

Cornell University Library
QL 47.T48 1916

Outlines of zoology,



3 1924 003 404 161

mann

CORNELL
UNIVERSITY
LIBRARY



BOUGHT WITH THE INCOME
OF THE SAGE ENDOWMENT
FUND GIVEN IN 1891 BY
HENRY WILLIAMS SAGE

RETURN TO

ALBERT R. MANN LIBRARY

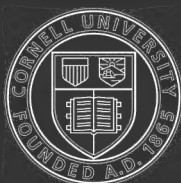

Cornell University
Library

The original of this book is in
the Cornell University Library.

There are no known copyright restrictions in
the United States on the use of the text.

<http://www.archive.org/details/cu31924003404161>

OUTLINES OF ZOOLOGY

OUTLINES OF ZOOLOGY

BY

^{John} ARTHUR THOMSON, M.A.

REGIUS PROFESSOR OF NATURAL HISTORY IN THE UNIVERSITY OF ABERDEEN;
JOINT-AUTHOR OF "THE EVOLUTION OF SEX";
AUTHOR OF "THE STUDY OF ANIMAL LIFE," "THE SCIENCE OF LIFE,"
"THE PROGRESS OF SCIENCE," "HEREDITY,"
"DARWINISM AND HUMAN LIFE," ETC.

FIFTH EDITION, REVISED, WITH 420 ILLUSTRATIONS



NEW YORK
D. APPLETON AND COMPANY

1916

MT

PREFACE TO THE SIXTH EDITION



THIS book is intended to serve as a Manual which students of Zoology may use in the lecture room, museum, and laboratory, and as an accompaniment to several well-known works, cited in the Appendix, most of which follow other modes of treatment.

To numerous authorities I acknowledge an obvious indebtedness, a detailed recognition of which would be out of place in a book of this kind. I must, however, acknowledge that in the preparation of a previous edition I had throughout the able assistance of Miss Marion Newbigin, D.Sc., and I have also been aided by suggestions from various kindly critics, especially Professor W. C. McIntosh, Professor P. J. White, the late Dr. Ramsay Traquair, Dr. John Beard, the late Mr. J. G. Goodchild, Dr. Arthur Masterman, Dr. John Rennie, Dr. W. D. Henderson, Mr. E. S. Russell, Mr. W. P. Pycraft, Mr. C. Tate Regan, and Professor H. J. Fleure. For most of the figures I am indebted to my artist friends, Mr. William Smith, Miss Florence Newbigin,

Miss E. M. Shinnie, and the late Mr. George Davidson. In almost every case the illustrations have been derived from original memoirs and works of reference, or drawn from specimens:

•

J. A. T.

THE UNIVERSITY,
ABERDEEN, *March* 1914.

CONTENTS.



GENERAL

CHAPTER I

	PAGE
GENERAL SURVEY OF THE ANIMAL KINGDOM	I

CHAPTER II

PHYSIOLOGY	20
----------------------	----

CHAPTER III

MORPHOLOGY	34
----------------------	----

CHAPTER IV

EMBRYOLOGY	52
----------------------	----

CHAPTER V

PALÆONTOLOGY	77
------------------------	----

CHAPTER VI

DOCTRINE OF DESCENT	84
-------------------------------	----

INVERTEBRATES

	PAGE
CHAPTER VII	
PROTOZOA	88
CHAPTER VIII	
SPONGES	124
CHAPTER IX	
CŒLENTERA	137
CHAPTER X	
UNSEGMENTED "WORMS"	179
CHAPTER XI	
ANNELIDS	209
CHAPTER XII	
ECHINODERMS	252
CHAPTER XIII	
ARTHROPODA	280
CHAPTER XIV	
ONYCHOPHORA OR PROTOTRACHEATA, MYRIOPODA, AND INSECTA	318
CHAPTER XV	
ARACHNOIDEA AND PALÆOSTRACA	363
CHAPTER XVI	
MOLLUSCS	380

VERTEBRATES

	PAGE
CHAPTER XVII	
HEMICHORDA	434
CHAPTER XVIII	
UROCHORDA	443
CHAPTER XIX	
CEPHALOCHORDA	459
CHAPTER XX	
STRUCTURE AND DEVELOPMENT OF VERTEBRATES	473
CHAPTER XXI	
CYCLOSTOMATA	516
CHAPTER XXII	
FISHES	529
CHAPTER XXIII	
AMPHIBIA	578
CHAPTER XXIV	
REPTILES	610
CHAPTER XXV	
BIRDS	647
CHAPTER XXVI	
MAMMALS	692

GENERAL

CHAPTER XXVII

	PAGE
DISTRIBUTION	795

CHAPTER XXVIII

THEORY OF EVOLUTION	807
APPENDIX ON BOOKS	815
INDEX	823

LIST OF ILLUSTRATIONS

FIG.	PAGE
1. Duckmole (<i>Ornithorhynchus</i>)	2
2. <i>Thenacodus</i> , a primitive extinct Mammal—after Cope	3
3. Extinct moa and modern kiwi—after Carus Sterne	3
4. Crocodiles	4
5. Salamander, an Amphibian	5
6. Queensland dipnoan (<i>Ceratodus</i>)	5
7. A lancelet, <i>Amphioxus</i> —after Haeckel	6
8. Ascidian or sea-squirt—after Haeckel	7
9. Cephalopod (paper nautilus, female)	9
10. Fresh-water crayfish (<i>Astacus</i>), a Crustacean—after Huxley	9
11. <i>a</i> , Caterpillar; <i>b</i> , pupa; <i>c</i> , butterfly	9
12. Spider	10
13. Crinoid or feather-star	10
14. Earthworm	11
15. Bladderworm stage of a Cestode—after Leuckart	11
16. Sea-anemones on back of hermit-crab—after Andres	12
17. Fossil Foraminifera (Nummulites) in limestone—after Zittel	13
18. Diagrammatic expression of classification in a genealogical tree. B indicates possible position of <i>Balanoglossus</i> , D of Dipnoi, S of Sphenodon or Hatteria	15
19. Diagram of Vertebrates	18
20. Diagram of Invertebrates	19
21. Diagram of cell structure—after Wilson	44
22. Structure of the cell—after Carnoy	46
23. Fertilised ovum of <i>Ascaris</i> —after Boveri	47
24. Diagram of cell division—after Boveri	47
25. Karyokinesis—after Flemming	49
26. Diagrammatic expression of alternation of generations	57
27. Diagram of ovum, showing diffuse yolk granules	58
28. Forms of spermatozoa (not drawn to scale)	60
29. Diagram of maturation and fertilisation. (From "Evolution of Sex")	61
30. Fertilisation in <i>Ascaris megalocephala</i> —after Boveri	64
31. Modes of Segmentation	66
32. Life history of a coral, <i>Monoxenia darwinii</i> —from Haeckel	68
33. Embryos—(1) of bird; (2) of man—after His. The latter about twenty-seven days old	70

FIG.	PAGE
34. Gradual transitions between <i>Paludina neumayri</i> (a), the oldest form, and <i>Paludina hærnesei</i> (j)—from Neumayr .	80
35. Life history of <i>Amoeba</i>	90
36. <i>Actinophrys sol</i> (Sun-animalcule)—after Grenacher	91
37. <i>Polystomella</i> , megalospheric form, with large central chamber (M) and one nucleus (N)—after Lister	93
38. <i>Polystomella</i> , microspheric form, with large central chamber (c.c.), numerous nuclei (N), bridges of protoplasm between chambers (B)—after Lister	93
39. <i>Paramæcium</i> —after Bütschli	94
40. Conjugation of <i>Paramæcium aurelia</i> —four stages—after Maupas	95
41. Diagrammatic expression of process of conjugation in <i>Paramæcium aurelia</i> —after Maupas	95
42. <i>Vorticella</i> —after Bütschli	97
43. <i>Volvox globator</i> —after Cohn	99
44. Life history of <i>Monocystis</i> —after Bütschli	101
45. Life history of <i>Gregarina</i> —after Bütschli	102
46. End-to-end union of Gregarines—after Frenzel	103
47. Life history of <i>Coccidium</i> —after Schaudinn.	104
48. Diagram of <i>Protomyxa aurantiaca</i> —after Haeckel	107
49. Formation of shell in a simple Foraminifer—after Dreyer	108
50. A Foraminifer (<i>Polystomella</i>) showing shell and pseudopodia—after Schultze	109
51. A pelagic Foraminifer— <i>Hastigerina</i> (<i>Globigerina</i>) <i>Murrayi</i> —after Brady	110
52. Optical section of a Radiolarian (<i>Actinomma</i>)—after Haeckel	111
53. <i>Glossina palpalis</i> , tse-tse fly	120
54. <i>Trypanosoma gambiense</i>	121
55. A colonial flagellate Infusorian— <i>Proterospongia hæckelii</i> —after Saville Kent	123
56. Simple sponge (<i>Ascetta primordialis</i>)—after Haeckel	125
57. A sponge colony	125
58. Sponge spicules	126
59. Section of a sponge—after F. E. Schulze	126
60. Diagram showing types of canal system—after Korschelt and Heider. The flagellate regions are dark throughout, the mesogloea is dotted, the arrows show the direction of the currents. All the figures represent cross-sections through the wall	127
61. Development of <i>Sycandra raphanus</i> —after F. E. Schulze	131
62. Diagrammatic representation of development of <i>Oscarella lobularis</i> —after Heider	132
63. A, Young <i>Dicyema</i> —after Whitman. B, Female Orthonectid (<i>Rhopalura giardii</i>)—after Julin	135
64. <i>Salinella</i> —after Frenzel	135
65. Diagram of Coelenterate structure, endoderm darker throughout	139
66. Colony of <i>Hydractinia</i> on back of a <i>Buccinum</i> shell tenanted by a hermit-crab	140

FIG.	PAGE
67. Diagram of a typical Hydrozoon polyp—after Allman	141
68. Hydra hanging from water-weed—after Greene	143
69. Minute structure of <i>Hydra</i> —after T. J. Parker and Jickeli	145
70. Development of <i>Hydra</i> —after Brauer	148
71. Bougainvillea—after Allman	150
72. Structure of a Medusoid—after Allman	151
73. Surface view of <i>Aurelia</i> —from Romanes	153
74. Vertical section of <i>Aurelia</i> —after Claus	155
75. Diagram of life history of <i>Aurelia</i> —after Haeckel	156
76. <i>Lucernaria</i> —after Korotneff	158
77. Diagram of <i>Lucernaria</i> —after Allman	158
78. External appearance of <i>Tealia crassicornis</i>	160
79. Vertical section of a sea-anemone—after Andres	161
80. Section through sea-anemone (across arrow in Figure 79)— after Andres	162
81. Z, Diagrammatic section of Zoantharian; A, of Alcyonarian —after Chun	163
82. The formation of a coral shell (<i>Astroides</i>)—after Pfuertscheller	165
83. Structure of Antipatharians	166
84. Diagrams of Types of Alcyonaria—after Hickson	167
85. <i>Corallium rubrum</i> , a corner of a colony—after Lacaze- Duthiers	168
86. Alcyonarian Spicules	169
87. Diagram of a gymnoblastic Hydroid—after Allman	170
88. Graptolites	171
89. Hydroids—after Hincks	172
90. Campanularian Hydroid—after Allman	173
91. Diagram of a Ctenophore—after Chun	174
92. <i>Hydroctena</i> . A medusoid with hints of Ctenophore structure	175
93. Commensalism of sea-anemones and hermit-crab	177
93A. Portions of excretory system of flat-worms	178
94. Diagram of Turbellarian—after Lang	181
95. Structure of liver fluke—after Sommer. From ventral surface. The branched gut (g.) and the lateral nerve (l.n.) are shown to the left, the branches of the excretory vessel (e.v.) to the right	184
96. Reproductive organs of liver fluke—after Sommer	185
97. Life history of liver fluke—after Thomas	187
98. Diagram of life cycle of liver fluke	189
99. Diagram of reproductive organs in Cestode joint—Constructed from Leuckart	192
100. Life history of <i>Tænia solium</i> —after Leuckart	193
101. Diagram of life history of <i>Tænia solium</i>	194
102. Diagrams of bladder-worms	196
103. Diagrammatic longitudinal section of a Nemertean (<i>Amphi- porus lactifloreus</i>), dorsal view—after McIntosh	197
104. Transverse section of the Nemertean <i>Drepanophorus latus</i> —after Bürger	198
105. Transverse section of a simple Nemertean (<i>Carinella</i>)—after Bürger	199

FIG.	PAGE
106. Cross section through <i>Ascaris</i>	203
107. Illustrating the structure of a Nematode	204
108. Trichinæ in muscle, about to be encapsuled—after Leuckart	207
109. Trichinæ in muscle, encapsuled. There may be 12,000 in a gramme of pig's muscle—after Leuckart	207
110. Earthworms	211
111. Anterior region of earthworm—after Hering	213
112. Transverse section of earthworm	216
113. Reproductive organs of earthworm—after Hering	218
114. Stages in the development of earthworm—after Wilson	220
115. <i>Arenicola marina</i>	223
116. Anterior part of nervous system in <i>Arenicola</i> —after Vogt and Yung	224
117. Dissection of lob-worm from dorsal surface	225
118. Cross-section of <i>Arenicola</i> —after Cosmovici	226
119. Development of <i>Polygordius</i> —after Fraipont	229
120. Parapodium of "Heteronereis" of <i>Nereis pelagica</i> —after Ehlers	231
121. Free-living Polychæte (<i>Nereis cultrifera</i>)	232
122. Transverse section of leech—after Bourne	238
123. Alimentary system of leech—after Moquin-Tandon	239
124. Dissection of leech—after Bourne	240
125. A nephridium of leech—after Bourne	241
126. Development of <i>Sagitta</i> —after O. Hertwig. Illustrating formation of a body cavity by pockets from the archenteron; also the early separation of reproductive cells	245
127. Actinotrocha or larva of <i>Phoronis</i> —after Masterman	248
128. <i>Phoronis</i>	249
129. Diagram of an Ectoproctous Polyzoon (<i>Plumatella</i>)	250
130. Interior of Brachiopod shell, showing calcareous support for the "arms"—after Davidson	251
131. Pluteus larva of Ophiuroid, with rudiment of adult—after Johannes Müller	253
132. Star-fish	256
133. Alimentary system of star-fish—after Müller and Troschel	257
134. Diagrammatic cross-section of star-fish arm—after Ludwig	259
135. Ventral surface of disc of an Ophiuroid (<i>Ophiothrix fragilis</i>)—after Gegenbaur	261
136. Apical disc of sea-urchin	263
137. Dissection of sea-urchin	265
138. Spicules of Holothurians—after Semon	268
139. Dissection of Holothurian (<i>Holothuria tubulosa</i>) from the ventral surface	271
140. Diagrammatic vertical section through disc and base of one of the arms of <i>Antedon rosacea</i> —after Milnes Marshall	273
141. Stages in development of Echinoderms—after Selenka	276
142. Appendages of Norway lobster	285
143. Section of compound eye of <i>Mysis vulgaris</i> —after Grenacher	287
144. Longitudinal section of lobster, showing some of the organs	289
145. Male reproductive organs of crayfish—after Huxley	292

LIST OF ILLUSTRATIONS.

xv

FIG.	PAGE
146. Female reproductive organs of crayfish—after Suckow	293
147. Section through the egg of <i>Astacus</i> after the completion of segmentation—after Reichenbach	294
148. Longitudinal section of later embryo of <i>Astacus</i> —after Reichenbach	295
149. Section through cephalothorax of a crab—after Pearson	296
150. Dorsal aspect of swimming crab (<i>Portunus</i>)	297
151. Dorsal aspect of shore crab (<i>Carcinus</i>)	297
152. Ventral aspect of female shore crab	298
153. Dorsal surface of <i>Apus cancriformis</i> —from Bronn's "Thierreich"	299
154. <i>Daphnia</i>	300
155. <i>Cypris</i>	301
156. <i>Cypris</i> , side view, after removal of one valve—after Zenker	302
157. <i>Cyclops</i> type	302
158. Acorn-shell (<i>Balanus tintinnabulum</i>)—after Darwin	304
159. Development of <i>Sacculina</i> —after Delage. (Not drawn to scale)	305
160. <i>Nebalia</i> —after Sars	307
161. <i>Anaspides</i> —after Calman	307
162. An Amphipod (<i>Caprella linearis</i>)	308
163. Hermit-crab withdrawn from its shell. The anterior appendages are broken off	309
164. <i>Mysis flexuosa</i> , from side	310
165. Nervous system of shore-crab (<i>Carcinus mænas</i>)—after Bethe	311
166. Zoæa of common shore-crab (<i>Carcinus mænas</i>)—after Faxon	314
167. External form of <i>Peripatus</i> —after Balfour	319
168. Dissection of <i>Peripatus</i> —after Balfour	321
169. Embryos of <i>Peripatus capensis</i> , showing closure of blastopore and curvature of embryo—after Korschelt and Heider	322
170. A millipede	324
171. A centipede	324
172. Female cockroach (<i>P. orientalis</i>)	326
173. Male cockroach (<i>P. orientalis</i>)	326
174. Ventral aspect of male cockroach with the wings extended. An imaginary median line has been inserted	328
175. Leg of cockroach	329
176. Mouth appendages of cockroach—after Dufour	329
177. Transverse section of insect—after Packard	330
178. Head and mouth parts of bee—after Cheshire	333
179. Nervous system of bee—after Cheshire	335
180. Food canal of bee—in part after Cheshire	336
181. Hive-bees and the cells in which they develop	337
182. Mouth-parts of mosquito—from Nuttall and Shipley	340
183. Young may-fly or ephemeropterid—after Eaton	342
184. Diagrams of insect embryo—after Korschelt and Heider	350
185. Life histories of insects	353
186. Life history of the silk-moth (<i>Bombyx mori</i>)	354
187. Development of blow-fly (<i>Calliphora erythrocephala</i>)—after Thomson Lowne	355

FIG.	PAGE
188. Mosquito—from Nuttall and Shipley	358
189. <i>Anurida maritima</i> (after Imms), one of the primitive wingless Collembola	359
190. <i>Acerentomon</i> , a very primitive insect	362
191. Scorpion	364
192. Garden spider	368
193. Dissection of <i>Mygale</i> from the ventral surface—after Cuvier	369
194. Section of lung-book—after Macleod	370
195. Follicle-mite (greatly enlarged)	373
196. Itch-mite (<i>Sarcoptes scabiei</i>) (greatly enlarged)	373
197. Tick (<i>Ixodes ricinus</i> , female), dorsal surface (after Wheler), showing the oval shield	374
198. Tick (<i>Ixodes ricinus</i> , female), ventral surface—after Wheler	374
199. <i>Limulus</i> or King-crab	376
200. Young <i>Limulus</i> —after Walcott	377
201. Trilobite (<i>Conocephalites</i>)—after Barrande	378
202. Vertical cross-section of a Trilobite (<i>Calymene</i>)—after Walcott	378
203. Sea-spider (<i>Pycnogonum littorale</i>), from the dorsal surface	379
204. Male of Nymphon—after Sars	379
205. Ideal mollusc—after Ray Lankester	381
206. Stages in molluscan development	381
207. Roman snail (<i>Helix pomatia</i>)	382
208. Vertical section of the shell of a species of <i>Helix</i>	383
209. Dissection of snail	389
210. Reproductive organs of <i>Helix pomatia</i> —after Meisenheimer	390
211. Snail (<i>Helix pomatia</i>), laying its eggs—after Meisenheimer	391
212. Diagram of larva of <i>Paludina</i> —after Erlanger	392
213. The fresh-water mussel (<i>Unio</i>)	394
214. Structure of <i>Anodonta</i> —after Rankin	397
215. Development of <i>Anodonta</i> —after Goette	401
216. Side view of <i>Sepia</i> —after Jatta	402
217. External appearance of a cuttlefish (<i>Loligo</i>)	404
218. Diagram of the structure of <i>Sepia</i> .—Mainly after Pelsener	407
219. Diagram of circulatory and excretory systems in a Decapod-like <i>Sepia</i> —after Pelsener	409
220. Male of <i>Argonaula</i> (after Jatta), showing "hectocotylus" arm; compare Fig. 9 of female	410
221. Bunch of <i>Sepia</i> eggs attached to plant—after Jatta	411
222. Common buckie (<i>Buccinum undatum</i>)	412
223. Bivalve (<i>Panopæa norvegica</i>), showing siphons	413
224. Nudibranch (<i>Dendronotus arborescens</i>), showing dorsal outgrowths forming adaptive gills	414
225. Ventral surface of <i>Patella vulgata</i> —after Forbes and Hanley	415
226. <i>Chiton</i> —after Prêtre	418
227. Dorsal view of nervous system of <i>Chiton</i> —after Pelsener	418
228. Anatomy of <i>Chiton</i>	419
229. A Pteropod (<i>Cymbulia peronii</i>), showing the wing-like expansions (pteropodial lobes) of the mid-foot	420

FIG.	PAGE
230. Stages in molluscan development	422
231. <i>Proneomenia</i> . Nervous system—from Hubrecht	424
232. Section of shell of <i>Nautilus</i> —after Lendenfeld	429
233. The Pearly <i>Nautilus</i> (<i>Nautilus pompilius</i>)—after Owen	430
234. Male of <i>Balanoglossus</i> (<i>Dolichoglossus</i>) <i>kowalevskii</i> —after Bateson	435
235. Transverse section through gill-slit region of <i>Ptychodera</i> <i>minuta</i> —after Spengel	437
236. Direct development of <i>Dolichoglossus</i> —after Bateson	438
237. Tornaria larva, from the side—after Spengel	439
238. Piece of a colony of <i>Cephalodiscus</i> , showing the tubes in- habited by the animals—after Ridewood	441
239. An individual <i>Cephalodiscus</i> —after Ridewood	441
240. Dissection of Ascidian—after Herdman	445
241. Diagram of Ascidian—after Herdman	448
242. Young embryo of Ascidian (<i>Clavelina</i>)—after Van Beneden and Julin	450
243. Embryo of <i>Clavelina</i> —modified after Seeliger	451
244. "Nurse" of <i>Doliolum mülleri</i> —after Uljanin	454
245. Sexual individual of <i>Doliolum mülleri</i> —after Uljanin	454
246. Diagram of <i>Salpa africana</i>	455
247. Anatomy of <i>Appendicularia</i> —after Herdman	456
248. Lateral view of <i>Amphioxus</i> —after Ray Lankester	460
249. Transverse section through pharyngeal region of <i>Amphioxus</i> —after Ray Lankester	461
250. Development of atrial chamber in <i>Amphioxus</i> —after Lankester and Willey	464
251 and 252. The nephridia of <i>Amphioxus</i> —after Boveri	466
253. Early stages in the development of <i>Amphioxus</i> —after Hatschek	469
254. Sections through embryos of <i>Amphioxus</i> , to illustrate de- velopment of body cavity	470
254A. Portions of excretory systems of <i>Phyllodoce</i> and <i>Amphi-</i> <i>oxus</i> —after Goodrich	472
255. Transverse section through an Elasmobranch embryo (diagrammatic)—after Ziegler	477
256 and 257. Ideal fore and hind limb—after Gegenbaur	483
258. Partial section of brain of young Vertebrate	484
259. Vertical section of the pineal eye in an embryo of <i>Spheno-</i> <i>don</i> —after Dendy	486
260. Diagram of parts of the brain in Vertebrates—after Gaskell	486
261. Diagrammatic section of spinal cord	491
262. Diagram of spinal cord of man, thoracic region—after John- ston	492
263. Diagram showing the ear and related parts in a young cat	494
264. Diagram of the eye	495
265. Development of the eye—after Balfour and Hertwig	496
266. Origin of lungs, liver, and pancreas in the chick—after Goette	500

FIG.	PAGE
267. Section through a young newt	501
268. Blood corpuscles of Vertebrates	504
269. Diagram of circulation—after Leunis	507
270. Development of excretory system of Vertebrate—in part after Boveri	510
271. Urogenital system	512
272. Mammalian ovum—after Hertwig	514
273. Median longitudinal section of anterior end of <i>Myxine</i> — after Retzius and Parker	518
274. Respiratory system of hag, from ventral surface	519
275. <i>Bdellostoma stouti</i> (Californian hag), enveloped in sheath of mucus—after Bashford Dean	521
276. The lamprey (<i>Petromyzon marinus</i>)	522
277. Longitudinal vertical section of anterior end of larval lamprey—after Balfour	523
278. Restored skeleton of <i>Palaeospondylus gunni</i> —after Traquair	527
279. <i>Pterichthys milleri</i> . Lateral view—restored by Traquair	528
280. Under surface of skull and arches of skate—after W. K. Parker	534
281. Side view of skate's skull—after W. K. Parker	535
282. Skeleton of skate—from a preparation	536
283. Dissection of nerves of skate	538
284. Side view of chief cranial nerves of Elasmobranchs—slightly modified from Cossar Ewart	542
285. Spiral valve of skate—after T. J. Parker	543
286. Upper part of the dorsal aorta in the skate—after Monro	544
287. Heart and adjacent vessels of skate—in part after Monro	545
288. Urogenital organs of male skate	546
289. Urogenital organs of female skate—in part after Monro	547
290. Elasmobranch development—after Balfour	548
291. Embryo dogfish in egg-case ("Mermaid's purse") which has been cut open to show contents	549
292. The haddock	551
293. External characters of a Teleostean—a carp (<i>Cyprinus carpio</i>)—after Leunis	551
294. Caudal vertebra of haddock	552
295. Disarticulated skull of cod—from Edinburgh Museum of Science and Art	553
296. Pectoral girdle and fin of cod—from Edinburgh Museum of Science and Art	554
297. Diagram of a Teleostean gill in section	556
298. Diagram of Teleostean circulation—after Nuhn	557
299. The early development of the salmon	559
300. Development of eel—after Smit	563
301. Young skate—from Beard	566
302. Lateral view of dogfish (<i>Scyllium catulus</i>)	567
303. Outline of <i>Acanthodes sulcatus</i> —after Traquair	569
306. Larva of <i>Polypterus</i> (after Budgett), $1\frac{1}{2}$ inch in length	570
305. Sturgeon (<i>Acipenser sturio</i>)	570
304. The goldfish (<i>Cyprinus auratus</i>)	572

FIG.	PAGE
307. <i>Lepidosiren</i> (after Graham Kerr), showing (<i>Pc.f.</i>) pectoral fin and the tufted pelvic fin (<i>Pv.f.</i>) of the mature male	574
308. Skeleton of <i>Ceratodus</i> fin—from Gegenbaur	575
309. Head region of <i>Protopterus</i> —from W. N. Parker	576
310. Larva of <i>Protopterus</i> —after Budgett	576
311. Larva of <i>Lepidosiren</i> —after Graham Kerr	577
312. The edible frog (<i>Rana esculenta</i>)	580
313. Vertebral column and pelvic girdle of bull-frog	582
314. Skull of frog—upper and lower surface—after W. K. Parker	583
315. Skeleton of frog. The half of the pectoral girdle, and fore- and hind-limb of the right side are not shown.	585
316. Pectoral girdle of <i>Rana esculenta</i> —after Ecker	586
317. Side view of frog's pelvis—after Ecker	586
318. Brain of frog—after Wiedersheim	587
319. Nervous system of frog—after Ecker	588
320. Arterial system of frog	592
321. Venous system of frog	593
322. Urogenital system of male edible frog—after Ecker	597
323. Urogenital system of female frog—after Ecker	597
324. Division of frog's ovum—after Ecker	599
325. Section of frog embryo—after Ziegler's model and Marshall	600
326. Dissection of tadpole—after Milnes Marshall and Bles	601
327. Life history of a frog—after Brehm	605
328. Cæcilian (<i>Ichthyophis</i>) with eggs—after Sarasin	607
329. External appearance of tortoise	613
330. Skull of turtle	613
331. Carapace of tortoise	614
332. Pectoral girdle of a Chelonian	615
333. Internal view of bones of the plastron of the Greek tortoise	616
334. Scales on ventral surface of plastron of Greek tortoise	617
335. Internal view of skeleton of tortoise	618
336. Dissection of chelonian heart—after Huxley	618
337. Heart and associated vessels of tortoise—after Nuhn	619
338. Hyoid apparatus of a chelonian	620
339. Lateral view of brain of <i>Hatteria punctata</i> —after Osawa	621
340. <i>Hatteria</i> or <i>Sphenodon</i> —after Hayek	621
341. Side view of skull of <i>Lacerta</i> —after W. K. Parker	624
342. Heart and associated vessels of a lizard—after Nuhn	626
343. Lung of <i>Chamaeleo vulgaris</i> , showing air-sacs—after Wiedersheim	627
344. Anterior view of python's vertebra	630
345. Posterior view of python's vertebra	630
346. Snake's head—after Nuhn	631
347. Skull of grass-snake—from W. K. Parker	633
348. Lower surface of skull of a young crocodile	635
349. Cervical vertebra of crocodile	636
350. Crocodile's skull from dorsal surface	637
351. Pectoral girdle of crocodile	638
352. Half of the pelvic girdle of a young crocodile	639
353. Origin of amnion and allantois—after Balfour	642

FIG.	PAGE
353A. Vertical section through backbone and ribs of a Chelonian and a Mammal—in part after Jaekel	646
354. Position of organs in a bird—after Selenka	649
355. Fore-limb and hind-limb compared	650
356. Diagrammatic section of young bird—after Gadow	651
357. A falcon	652
358. Young bearded griffin (<i>Gypæetus barbatus</i>)—after Nitzsch	653
359. Young feather and filoplume—after Nitzsch	654
360. Types of feathers	656
361. Parts of a feather—after Nitzsch	657
362. Entire skeleton of condor, showing the relative positions of the chief bones	658
363. Disarticulation of bird's skull—after Gadow. Membrane bones shaded	659
364. Under surface of gull's skull	661
365. Wing of dove	662
366. Side view of pelvis of cassowary	663
367. Bones of hind-limb of eagle	663
368. Brain of pigeon	664
369. Diagrammatic section of cloaca of male bird—after Gadow	667
370. Heart and arterial system of pigeon	668
371. Heart and venous system of pigeon	669
372. Female urogenital organs of pigeon	672
373. Male urogenital organs of pigeon	672
374. Pectoral girdle and sternum of swan	674
375. Position of wings in pigeon at maximum elevation—from Marey	675
376. Wings coming down—from Marey	676
377. Wings completely depressed—from Marey	676
378. Stages in development of chick—after Marshall	682
379. Diagrammatic section of egg—after Allen Thomson	683
380. Diagrammatic section of embryo—after Kennel	685
381. <i>Hesperornis</i> —after Marsh	688
381A. Fore and hind limbs of rabbit	691
382. Diagram of skull bones (partly after Flower and Weber), the membrane bones shaded	696
383. Side view of rabbit's skull	701
384. Dorsal view of rabbit's skull	702
385. Under surface of rabbit's skull	703
386. Skull of capybara	704
387. Dorsal view of rabbit's brain	708
388. Under surface of rabbit's brain—after Krause	708
389. Diagram of cæcum in rabbit	711
390. Duodenum of rabbit—from Krause, in part after Claude Bernard	712
391. Circulatory system of the rabbit	713
392. Vertical section through rabbit's head—from a section, with help from Parker's <i>Zootomy</i> and Krause	716
393. Urogenital organs of male rabbit	718
394. Urogenital organs of female rabbit	718

FIG.	PAGE
395. Segmentation of rabbit's ovum—after Van Beneden	725
396. Development of hedgehog. Three early stages—after Hubrecht	726
397. Embryo of <i>Perameles</i> with its foetal membranes—after Hill	727
398. Two stages in segmented ovum of hedgehog—after Hubrecht	728
399. Development of foetal membranes—after Hertwig	729
400. Diagram of foetal membranes—after Turner	730
401. View of embryo, with its foetal membranes—after Kennel	733
402. Pectoral girdle of <i>Echidna</i>	740
403. Pelvis of <i>Echidna</i>	742
404. Lower jaw of kangaroo	745
405. Foot of young kangaroo	748
406. Side view of sheep's skull, with roots of back teeth exposed	756
407. Stomach of sheep—from Leunis	757
408. Side view of lower part of pony's fore-leg	760
409. Side view of ankle and foot of horse	760
410. Side view of horse's skull, roots of teeth exposed	761
411. Feet of horse and its predecessors—from Neumayr	762
412. Left fore-limb of <i>Balenoptera</i>	767
413. Fore-limb of whale (<i>Megaptera longimana</i>)—after Struthers	767
414. Pelvis and hind-limb of Greenland whale (<i>Balæna</i>)—after Struthers	769
415. Vertebra, rib, and sternum of <i>Balenoptera</i> —from specimen in Anatomical Museum, Edinburgh	771
416. Skull of tiger, lateral view	773
417. Lower surface of dog's skull	774
418. Skull of Orang-Utan	789
419. Skull of gorilla	790
420. Skeleton of male gorilla	791

VERTEBRATES.	BIRDS. Flying Birds. Running Birds.		MAMMALS. Placentals. Marsupials. Monotremes.	METAZOA.	
	Snakes. Lizards. REPTILES. Crocodiles. Tortoises.				
	FISHES.	Dipnoi. Bony Fishes.	AMPHIBIANS. Newt. Frog.		
		"Ganoids." Elasmobranchs.	CYCLOSTOMES. Lamprey. Hag-fish.		
	LANCELETS.	TUNICATES.			
INVERTEBRATES.	CŒLOMATA.	BALANOGLOSSUS.		METAZOA.	
		Insects. Arachnids.	ANNELIDS.		Cuttle-fishes. Gasteropods.
		Myriopods. Peripatus.			MOLLUSCS. Bivalves.
		ARTHROPODS. Crustaceans.	"WORMS."		Feather-stars. Brittle-stars. Star-fish.
		UNSEGMENTED WORMS.	ECHINODERMS. Sea-urchins. Sea-cucumbers.		
Ctenophores. Jelly-fish. Sea-anemones. Corals.					
CŒLENTERA. Medusoids and Hydroids.					
		SPONGES.			
Infusorians. Rhizopods. Sporozoa. SIMPLEST ANIMALS.				PROTO- ZOA.	

OUTLINES OF ZOOLOGY

CHAPTER I

GENERAL SURVEY OF THE ANIMAL KINGDOM

IN beginning the study of Zoology, it is natural and useful to try to get a bird's-eye view of the "Animal Kingdom." Without this, one is apt to miss the plan in studying the details. But the survey can be of little service unless the student has the actual animals in his mind's eye.

VERTEBRATES, OR BACKBONED ANIMALS

Mammals.—We begin our survey with the animals which are anatomically most like man—the monkeys. But neither we nor the monkeys are separated by any structural gulf from the other four-limbed, hair-bearing animals, to which Lamarck gave the name of Mammals. For although there are many different types of Mammals—such as monkeys and men; horses, cattle, and other hooped quadrupeds; cats, dogs, and bears; rats, mice, and other rodents; hedgehogs, shrews, and moles, and so on—the common possession of certain characters unites them all in one class, readily distinguishable from Birds and Reptiles.

These distinctive characters include the milk-giving of the mother mammals, the growth of hair on the skin, the general presence of convolutions on the front part of the brain, the occurrence of a muscular partition or diaphragm between the chest and the abdomen, and so on, as we shall

afterwards notice in detail. Most mammals are suited for life on land, but diverse types, such as seals, whales, and sea-cows, have taken to the water. In another direction the bats are markedly adapted for aerial life.

Among the mammalian characteristics of great importance are those which relate to the bearing of young, and even a brief consideration of these shows that some mammals are distinguished from others by differences deeper than those which separate whales from carnivores, or rodents from bats. These deep differences may be stated briefly as follows:—(a) Before birth most young mammals are very closely united (by a complex structure

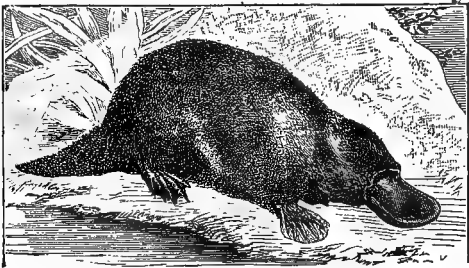

FIG. 1.—Duckmole (*Ornithorhynchus*).

called the placenta) to the mothers who bear them. (b) But this close connection between mother and unborn young is of rare occurrence, or only hinted at, in the pouched animals or Marsupials, which bring forth their young in a peculiarly helpless condition, as it were prematurely, and in most cases place them in an external pouch, within which they are sheltered and nourished. (c) In the Australian duckmole and its two relatives, the placental connection is quite absent, for these animals lay eggs as birds and most reptiles do. These differences and others relating to structure warrant the division of Mammals into three subclasses:—

- (a) Eutheria, Monodelphia, or Placentals—those in which there is a close (placental) union between the unborn embryo and its mother, *e.g.* Ungulates, Carnivores, Monkeys.

- (b) Metatheria, Didelphia, or Marsupials—the prematurely bearing, usually pouch-possessing kangaroos, opossums, etc.
- (c) Prototheria, Ornithodelphia, or Monotremes—the egg-laying duckmole (*Ornithorhynchus*), *Echidna*, and *Proechidna*.



FIG. 2.—Phenacodus, a primitive extinct Mammal.—After Cope.

Birds.—There can be no hesitation as to the class which ranks next to Mammals. For Birds are in most respects as highly developed as Mammals, though in a different direction. They are characterised by their feathers and wings, and many other adaptations for flight, by their high temperature, by the frequent sponginess and hollowness of their bones, by the tendency to fusion in many parts of the skeleton, by the absence of teeth in modern forms, by the fixedness of the lungs and their association with numerous air sacs, and so on.

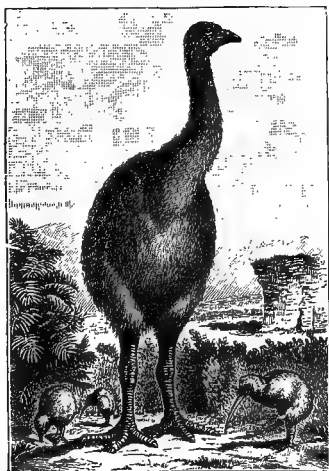

FIG. 3.—Extinct moa and modern kiwi.—After Carus Sterne.

But here again different grades must be distinguished—(1) There is the vast majority—the flying birds, with a breast-bone keel or carina, to

which the muscles used in flight are in part attached (*Carinatae*); (2) there is the small minority of running birds (ostriches, emu, cassowary, kiwi, and extinct moa), with wings incapable of flight, and with no keel (*Ratitae*); and (3) there is an extinct type, *Archaeopteryx*, with markedly reptilian affinities.

Reptiles.—There are no close relationships between Birds and Mammals, but the old-fashioned Monotremes have some markedly reptilian features, and so have some aberrant living birds, such as the Hoatzin and the Tinamou. Moreover, when we consider the extinct Mammals and Birds, we perceive other resemblances linking the two highest classes to the Reptiles.

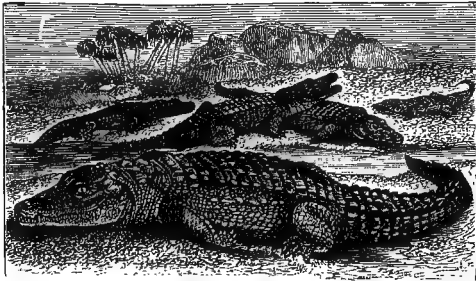

FIG. 4.—Crocodiles.

Reptiles do not form a compact class, but rather an assemblage of classes. In other words, the types of Reptile differ much more widely from one another than do the types of Bird or Mammal. Nowadays there are five distinct types:—the crocodylians, the unique New Zealand “lizard” (*Sphenodon*), the lizards proper, the snakes, and the tortoises. But the number of types is greatly increased when we take account of the entirely extinct saurians, who had their golden age in the inconceivably distant past.

The Reptiles which we know nowadays are scaly-skinned animals; they resemble Birds and Mammals in having during embryonic life two important “foetal membranes” (the amnion and the allantois), and in never having gills; they differ from them in being “cold-blooded,” and in many other ways.

Amphibians.—The Amphibians, such as frogs and newts, were once regarded—*e.g.* by Cuvier—as naked Reptiles, but a more accurate classification has linked them rather to the Fishes. Thus Huxley grouped Birds and Reptiles together as Sauropsida; Amphibians and Fishes together as Ichthyopsida—for reasons which will be afterwards stated. Amphibians mark the transition from aquatic life, habitual



FIG. 5.—Salamander, an Amphibian.

among Fishes, to terrestrial life, habitual among Reptiles; for while almost all Amphibians have gills—in their youth at least—all the adults have lungs, and some retain the gills as well. In having limbs which are fingered and toed, and thus very different from fins, they resemble Reptiles. But the two foetal membranes characteristic of the embryonic life of higher Vertebrates are not present in Amphibian embryos, and the general absence of an exoskeleton in modern forms is noteworthy.

Fishes.—The members of this class are as markedly adapted to life in the water as birds to life in the air. The very muscular posterior region of the body usually forms



FIG. 6.—Queensland dipnoan (*Ceratodus*).

the locomotor organ, and we say that a fish swims by bending and straightening its tail. The limbs have the form of paired fins—that is, they are limbs without digits. There are also unpaired median fins supported by fin rays. All have permanent gills borne by bony or gristly arches.

There is an exoskeleton of scales, and the skin also bears numerous glandular cells and sensory structures.

In many ways Fishes are allied to Amphibians, especially if we include among Fishes three peculiar forms, known as Dipnoi, which show the beginning of a three-chambered heart, and have a lung as well as gills. Ordinary Fishes have a two-chambered heart, containing only impure blood, which is driven to the gills, whence, purified, it passes directly to the body.

Apart from the divergent Dipnoi, there are two great orders of Fishes—the cartilaginous Elasmobranchs, such as shark and skate; and the Teleosteans or bony fishes, such as cod, herring, salmon, eel, and sole. There are several smaller orders of great importance, some of which, *e.g.* the sturgeons, are often called “Ganoids.”

Primitive Vertebrates.—Under this title we include—(1) the Roundmouths or Cyclostomata; (2) the lancelets or Cephalochorda; (3) the Tunicates, some of which are



FIG. 7.—A lancelet, *Amphioxus*.—After Haeckel.

called sea-squirts; and (4), with much hesitation, several strange forms, especially *Balanoglossus*, which exhibit structures suggestive of affinity with Vertebrates.

The Cyclostomata, represented by the lamprey (*Petromyzon*) and the hag (*Myxine*), and some other forms, probably including an interesting fossil known as *Palæospondylus*, are sometimes ranked with fishes under the title Marsipobranchii. But they have no definitely developed jaws, no paired fins, no scales, and are in other ways more primitive.

The lancelets or Cephalochorda are even simpler in their general structure (see Fig. 7). Thus there is an absence of limbs, skull, jaws, well-defined brain, heart, and some other structures. The vertebral column is represented by an unsegmented (or unvertebrated) rod, called the notochord, which in higher animals (except Cyclostomes and some fishes) is a transitory embryonic organ afterwards replaced by the backbone.

The Tunicata or Urochorda are remarkable forms, the majority of which degenerate after larval life (Fig. 8). In the larvæ of all, and in a few adults which are neither peculiarly specialised nor degenerate, we recognise some of the fundamental characters of Vertebrates. Thus there is a dorsal supporting axis (or notochord) in the tail region, a dorsal nervous system, gill-clefts opening from the pharynx to the exterior, a simple ventral heart, and so on.

Of *Balanoglossus* and its allies (Hemichorda or Enteropneusta) it is still difficult to speak with confidence. The possession of gill-clefts, the dorsal position of an important part of the nervous system, the occurrence of a short supporting structure on the anterior dorsal surface of the pharynx, and other features, have led many to place them at the base of the Vertebrate series.

Characteristics of Vertebrata.—At this stage, having reached the base of the Vertebrate series, we may seek to define a Vertebrate animal, and to contrast it with Invertebrate forms.

The distinction is a very old one, for even Aristotle distinguished mammals, birds, reptiles, amphibians, and fishes as "blood-holding," from cuttle-fish, shell-bearing animals, crustaceans, insects, etc., which he regarded as "bloodless." He was, indeed, mistaken about the bloodlessness, but the distinctiveness of the higher animals first mentioned has been recognised by all subsequent naturalists, though it was first precisely expressed in 1797 by Lamarck.

Yet it is no longer possible to draw a boundary line between Vertebrates and Invertebrates with that firmness of hand which characterised the early or, indeed, the pre-Darwinian classifications. We now know—(1) that Fishes and Cyclostomata do not form the base of the Vertebrate series, for the lancelets and the Tunicates must also be included in the Vertebrate alliance; (2) that *Balanoglossus*, *Cephalodiscus*, and some other forms, have several Vertebrate-like characteristics; (3) that some of the Invertebrates, especially the Chætopod worms, show some hints of affinities with Vertebrates. The limits of the Vertebrate alliance have been widened, and though the recognition of their characteristics has become more definite, not less so, the apartness of the sub-kingdom has disappeared.

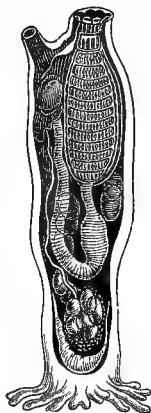

FIG. 8.—Ascidian or sea-squirt. — After Haeckel.

It does not matter much whether we retain the familiar title *Vertebrata*, or adopt that of *Chordata*, provided that we recognise—(1) that it is among Fishes first that separate vertebral bodies appear in the supporting dorsal axis of the body; (2) that, as a *characteristic*, the backbone is less important than the notochord, which precedes it in the history alike of the race and of the individual. Nor need we object to the popular title *backboned*, if we recognise that the adjective “bony” is first applicable among Fishes, and not to all of these.

The essential characters of Vertebrates may be summed up in the following table, where they are contrasted, somewhat negatively, with what is true of Invertebrates:—

“BACKBONELESS,” INVERTEBRATE OR NON-CHORDATE.	“BACKBONED,” VERTEBRATE OR CHORDATE.
<p>If there is a nerve-cord, it is <i>ventral</i>.</p> <p>No internal dorsal axis.</p> <p>No gill-slits.</p> <p>The eye is usually derived directly from the skin.</p> <p>The heart, if present, is dorsal.</p>	<p>The central nervous system—brain and spinal cord—is <i>dorsal</i> and <i>tubular</i>.</p> <p>There is a dorsal supporting axis or notochord, which is in most cases replaced by a backbone.</p> <p>Gill-slits or visceral clefts open from the sides of the pharynx to the exterior. In fishes, and at least young amphibians, they are associated with gills, and are useful in respiration; in higher forms they are transitory and functionless, except when modified into other structures.</p> <p>The essential parts of the eye are formed by an outgrowth from the brain.</p> <p>The heart is ventral.</p>

INVERTEBRATES, OR BACKBONELESS ANIMALS

Molluscs.—If we take the concentration of the nervous system as a useful criterion, the highest backboneless animals are the Molluscs. This series of forms includes Bivalves, such as cockle and mussel, oyster and clam; Gasteropods, such as snail and slug, periwinkle and whelk; Cephalopods, such as octopus and pearly nautilus.

Unlike Vertebrates, and such Invertebrates as Insects and Crustaceans, Molluscs are without segments and without appendages. A muscular protrusion of the ventral surface, known as the “foot,” serves in the majority as an organ of locomotion. In most cases a single or double fold of skin, called the “mantle,” makes a protective shell. The nervous system has three chief pairs of nerve centres or ganglia. In many cases there are very characteristic free-swimming larval stages.

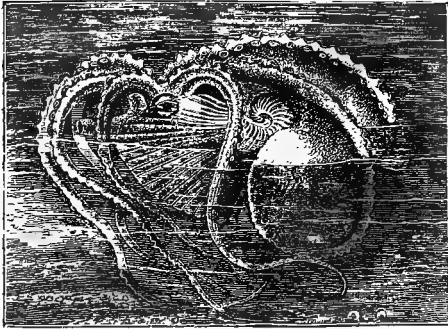

FIG. 9.—Cephalopod (paper nautilus, female).

Arthropods.—This large series includes Crustaceans, Myriopods, Insects, Spiders, and other forms, which have segmented bilaterally symmetrical bodies and jointed

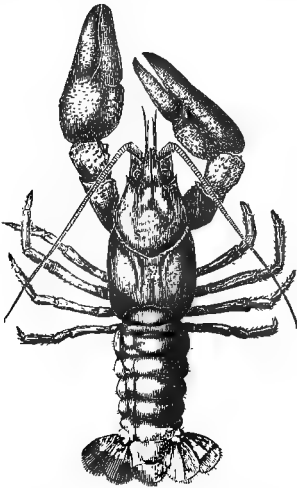

FIG. 10.—Fresh-water crayfish (*Astacus*), a Crustacean.—After Huxley.



FIG. 11.—*a*, Caterpillar ; *b*, pupa ; *c*, butterfly.

appendages. The skin produces an external, not-living cuticle, the organic part of which is a substance called chitin, associated in Crustaceans with carbonate of lime. The nervous system consists of a dorsal brain, connected, by a nerve-ring around the gullet, with a ventral chain of ganglia.



FIG. 12.—Spider.

Echinoderms.—This is a well-defined series, including star-fishes, brittle-stars, sea-urchins, sea-cucumbers, and feather-stars. The symmetry of the adult is usually radial, though that of the larva is bilateral. A peculiar system, known as the water-vascular system, is

characteristic, and is turned to various uses, as in locomotion and respiration. There is a marked tendency to deposition of lime in the tissues. The development is strangely circuitous or “indirect.”

Segmented “worms.”

—It is hopeless at present to arrange with any definiteness those heterogeneous forms to which the title “worm” is given. For this title is little more than a name for a *shape*, assumed by animals of varied nature who began to move head foremost and to acquire sides. There is no class of “worms,” but an assemblage—a mob—not yet reduced to order. It seems useful, however, to separate those which are ringed or segmented from those which are unsegmented. The former are often called Annelids, and include two chief classes :—

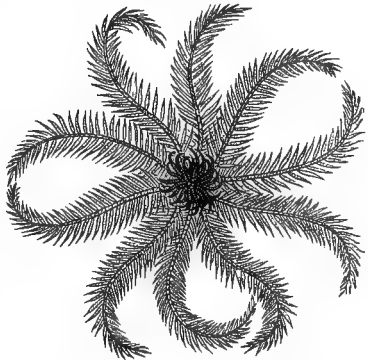

FIG. 13.—Crinoid or feather-star.

(1) Chætopoda or Bristle-footed worms, *e.g.* earthworm and lob-worm; and (2) Hirudinea or Leeches.

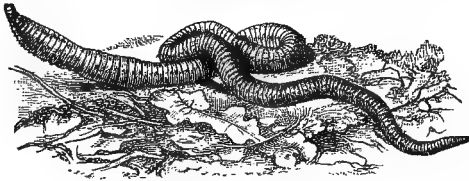

FIG. 14.—Earthworm.

Unsegmented "worms."—These differ from the higher "worms" in the absence of true segments and appendages, and resemble them in their bilateral symmetry. There is a motley lot:—the free-living Turbellarians or Planarians; the parasitic Trematodes or Flukes; the parasitic Cestodes or Tape-worms; the Nemer-teans or Ribbon-worms; the frequently parasitic Nematodes or Thread-worms; and several smaller classes.

As to some other groups, such as the sea-mats (Polyzoa or Bryozoa), the lamp-shells (Brachiopoda), the worm-like Sipunculids, and the wheel-animalcules or Rotifers, we must confess that they are still *incertæ sedis*.

But the general fact is not without interest, that in the midst of the well-defined classes of Invertebrates there lies, as it were, a pool from which many streams of life have flowed; for among the heterogeneous "worms" we may find in diverse types affinities with Arthropods, Molluscs, Echinoderms, and even Vertebrates.

Contrast of Coelomate and Coelenterate.—At this stage we may notice that in all the above forms the typical symmetry is bilateral (in Echinoderms, the superficial radial symmetry belongs only to the adults); that in most types a body cavity or coelom is developed; that the embryo consists of three germinal layers (external

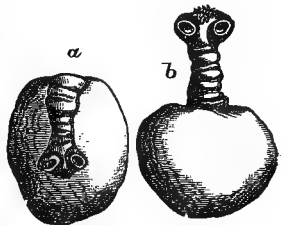

FIG. 15.—Bladderworm stage of a Cestode.—After Leuckart.

a, Early stage with head inverted.
b, Later stage with head everted.

ectoderm or epiblast, internal endoderm or hypoblast lining the gut, and a median mesoderm or mesoblast lining the body cavity). In the next two classes (Coelentera and Sponges) the conditions are different, as may be expressed in the following table:—

SPONGES AND CŒLENTERA.	HIGHER ANIMALS (CŒLOMATA).
<p>There is no body cavity. There is but one cavity, that of the food canal.</p> <p>Except in ctenophores, there is no definite middle layer of cells (mesoderm), but rather a middle jelly (mesogloea), and the embryo is diploblastic.</p> <p>The radial symmetry of the gastrula embryo is usually retained in the adult, and the longitudinal (oral-aboral) axis of the adult corresponds to the long axis of the gastrula.</p>	<p>There is a body cavity or cœlom between the food canal and the body-wall. But this is often incipient, or degenerate.</p> <p>There is a distinct middle layer of cells (mesoderm) between the external ectoderm and the internal endoderm. The embryo is triploblastic.</p> <p>The adults are usually bilateral, in some cases asymmetrical, in echinoderms superficially radial.</p>

Coelentera.—This series includes jelly-fishes, sea-anemones, corals, zoophytes, and the like, most of which are equipped

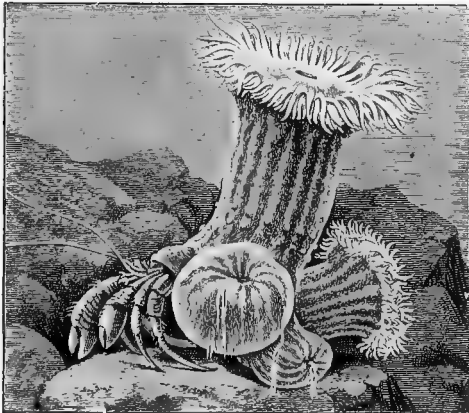

FIG. 16.—Sea-anemones on back of hermit-crab.
—After Andres.

with stinging cells, by means of which they paralyse their prey. All but a few are marine. The body may be a tubular polyp, or a more or less bell-like “medusoid,” and

in some cases the two forms are included in one life cycle. Budding is very common, and many of the sedentary forms—"corals"—have shells of lime.

Porifera.—Sponges, or Porifera, are the simplest many-celled animals. In the simplest forms, the body is a tubular, two-layered sac, with numerous inhalant pores by which water passes in, with a central cavity lined by cells bearing lashes or flagella, and with an exhalant aperture. But budding, folding, and other complications arise, and there is almost always a skeleton, calcareous, siliceous, or "horny." Apart from one family (Spongillidæ), all sponges are marine.

Contrast of Metazoa and Protozoa.—All the animals hitherto mentioned have *bodies* built up of many cells,¹ but there are other animals, each of which consists of a single cell. These simplest animals are called Protozoa.

Every animal hitherto mentioned, from mammal or bird to sponge, develops, when reproduction takes its usual course, from a fertilised egg-cell. This egg-cell or ovum divides and redivides, and the daughter cells cohere and are differentiated to form a "body." But the Protozoa form no "body"; they remain (with few exceptions) single cells, and when they divide, the daughter cells almost invariably go apart as independent organisms.

Here, then, is the greatest gulf which we have hitherto noticed—that between multicellular animals (Metazoa) and unicellular animals (Protozoa). But the gulf was bridged, and traces of the bridge remain. For—(a) there are a few Protozoa which form loose colonies of cells, and (b) there are a few multicellular animals of great simplicity.

Protozoa.—The Protozoa remain single cells, with few exceptions. Thus they form no "body"; and necessarily, therefore, they have no organs in the ordinary sense. They illustrate the *beginnings* of sexual reproduction, and they are not subject to *natural death* in the same degree as Metazoa are. The series includes—

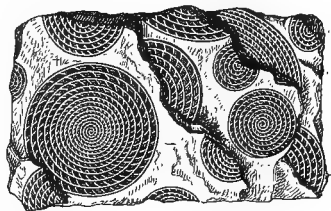

FIG. 17.—Fossil Foraminifera (Nummulites) in limestone.—
After Zittel.

¹ A cell may be defined as a unit corpuscle or unit area of living matter, typically controlled by a single nucleus.

(a) Rhizopods, with outflowing threads or processes of living matter, e.g. the chalk-forming Foraminifera (Fig. 17).

(b) Infusorians, with actively moving lashes of living matter.

(c) Sporozoa, parasitic forms, usually without either lashes or outflowing processes.

Note on Classification.

We always group together in our mind those impressions which are like one another. In this lies the beginning of all classification, whether that of the child, the savage, or the zoologist. For there are many possible classifications, varying according to their purpose, according to the points of similarity which have been selected as important. Thus we may classify animals according to their habitats or their diet, without taking any thought of their structure.

But a strictly zoological classification is one which seeks to show the blood-relationships of animals, to group together those whose affinities are shown by their being like one another in architecture or structure. It must, therefore, be based on the results of comparative anatomy—technically speaking, on “homologies,” *i.e.* resemblances in fundamental structure and in mode of development. Whales must not be ranked with fishes, nor bats with birds.

To a classification based on structural resemblances, two corroborations are of value, from embryology and from palæontology. On the one hand, the development of the forms in question must be studied: thus no one dreamed that a Tunicate was a Vertebrate until its life-history was worked out. On the other hand, the past history must be inquired into: thus the affinity between Birds and Reptiles is confirmed by a knowledge of the extinct forms.

In classification it is convenient to recognise certain grades or degrees of resemblance, which are spoken of as species, genera, families, orders, classes, and so on.

To give an illustration, all the tigers are said to form the species *Felis tigris*, of the genus *Felis*, in the family Felidæ, in the order Carnivora, within the class Mammalia. The resemblances of all tigers are exceedingly close; well marked, but not so close, are the resemblances between tigers, lions, jaguars, pumas, cats, etc., which form the genus *Felis*; broader still are the resemblances between all members of the cat family Felidæ; still wider those between cats, dogs, bears, and seals, which form the order Carnivora; and lastly, there are the general resemblances of structure which bind Mammals together in contrast to Birds or Reptiles, though all are included in the series or phylum Vertebrata.

It must be understood that the real things are the individual animals, and that a species includes all those individuals who resemble one another so closely that we feel we need a specific name applicable to them all. And as resemblances which seem important to one naturalist may seem trivial to others, there are often wide differences of opinion as to the number of species which a genus contains.

But while no rigid definition can be given of a species, certain common-sense considerations should be borne in mind:—

1. No naturalist now believes, as Linnæus did, in the fixity of species ; we believe, on the contrary, that one form has given rise to another. At the same time, the common characteristics on the strength of which we deem it warrantable to give a name to a group of individuals, must

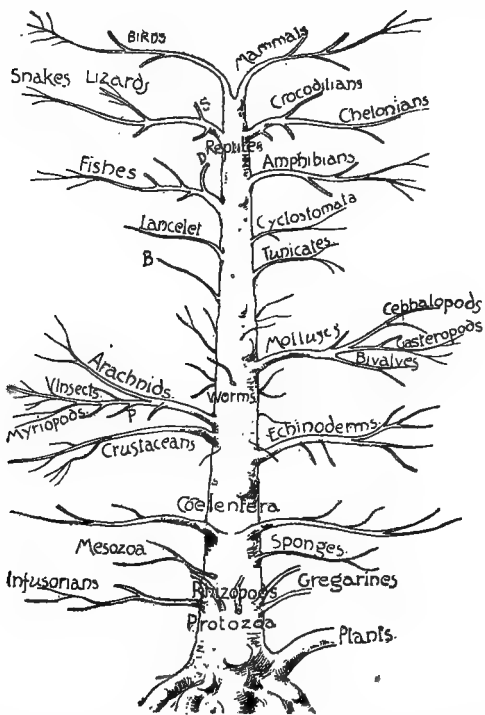

FIG. 18.—Diagrammatic expression of classification in a genealogical tree. B indicates possible position of Balanoglossus, D of Dipnoi, S of Sphenodon or Hatteria.

not be markedly fluctuating. The specific characters should exhibit *a certain degree of constancy from one generation to another.*

2. Sometimes a minute character, such as the shape of a tooth or the marking of a scale, is so constantly characteristic of a group of individuals that it may be safely used as the index of more important

characters. On the other hand, *the distinction between one species and another, should always be greater than any difference between the members of a family* (using the word family here to mean the progeny of a pair). For no one would divide mankind into species according to the colour of eyes or hair, as this might lead to the absurd conclusion that two brothers belonged to different species. Thus it is often doubly unsatisfactory when a species is established on the strength of a single specimen—(a) because the constancy of the specific character is undetermined; (b) because the variations within the limits of the family have not been observed. Indeed, it has happened that one species has been made out of a male, and another out of its mate.

3. Although cases are known where members of different species have paired and brought forth fertile hybrids, this is not usual. *The members of a species are fertile inter se, but not usually with members of other species.* In fact, the distinctness of species has largely depended on a restriction of the range of fertility.

TABULAR SURVEY.—(For Future Reference)

METAZOA CHORDATA

MAMMALIA.	{ Eutheria. Metatheria. Marsupials. Prototheria. Monotremes. Oviparous. }	Mam- malia.	} Gnathostomata (i.e. jawed).	} Craniota (with skulls).
AVES.	{ Carinatae. Keeled flying birds. Odontolcae. Extinct toothed birds. Ratitae. Keel-less running birds. Extinct reptile-like birds. }	Sauropsida.		
REPTILIA.	{ Crocodilia. Crocodiles and alligators. Ophidia. Snakes. Lacertilia. Lizards. Rhynchocephalia. <i>Sphenodon</i> . Chelonia. Tortoises and turtles. Extinct Classes. }			
AMPHIBIA.	{ Anura. Tail-less frogs and toads. Urodela. Tailed newts. Gymnophiona, e.g. <i>Cæcilia</i> . Labyrinthodonts and other extinct Amphibians. }	Ichthyopsida.		
PISCES.	{ Dipnoi. Mud-fishes. Teleostomi. Bony fishes, etc. Elasmobranchii. Cartilaginous fishes. }			
CYCLOSTOMATA.	{ Hag-fish (<i>Myxine</i>), and Lamprey (<i>Petromyzon</i>).		} Acrania (without skulls).	
CEPHALOCHORDA.	<i>Amphioxus</i> .			
UROCHORDA.	Tunicates.			
HEMICHORDA.	<i>Balanoglossus</i> , <i>Cephalodiscus</i>			

METAZOA NON-CHORDATA

MOLLUSCA.	{	Cephalopoda. Cuttle-fishes. Gasteropoda. Snails. Lamellibranchiata. Bivalves. Two smaller classes:—Scaphopoda and Solenogastres	
ARTHROPODA.	{	Arachnoidea. Spiders, scorpions, mites Insecta. Myriopoda. Centipedes and millipedes. Prototracheata. <i>Peripatus</i> . Crustacea. Palæostraca:—Trilobites, Eurypterids, and King-crabs. Some smaller classes.	
ECHINODERMA.	{	Crinoidea. Feather-stars. (Cystoids and Blastoids, extinct.) Ophiuroidea. Brittle-stars. Asteroidea. Star-fishes. Echinoidea. Sea-urchins. Holothuroidea. Sea-cucumbers.	
	{	Chætopoda. Bristle worms. Discophora. Leeches. Some smaller classes.	} Annelids or Annulata.
WORMS."	{	Brachiopoda. Lamp-shells. Polyzoa, <i>e.g.</i> Sea-mat (<i>Flustra</i>). Sipunculoidea, <i>e.g.</i> <i>Sipunculus</i> . Nematoda. Thread-worms. Acanthocephala. Nemertea. Ribbon-worms. Rotifera. Wheel-animalcules.	
	{	Cestoda. Tape-worms. Trematoda. Flukes. Turbellaria. Planarians.	} Platyhelminthes.
CŒLENTERA.	{	Ctenophora, <i>e.g.</i> <i>Beroë</i> . Actinozoa or Anthozoa. Sea-anemones. Alcyonarians and related corals. Scyphomedusæ or Acraspeda. Jelly-fishes. Hydrozoa. Zoophytes and medusoids.	
PORIFERA.		Sponges. Calcareous and non-calcareous.	

PROTOZOA

INFUSORIA. RHIZOPODA. SPOROZOA.

Simplest forms of animal life.

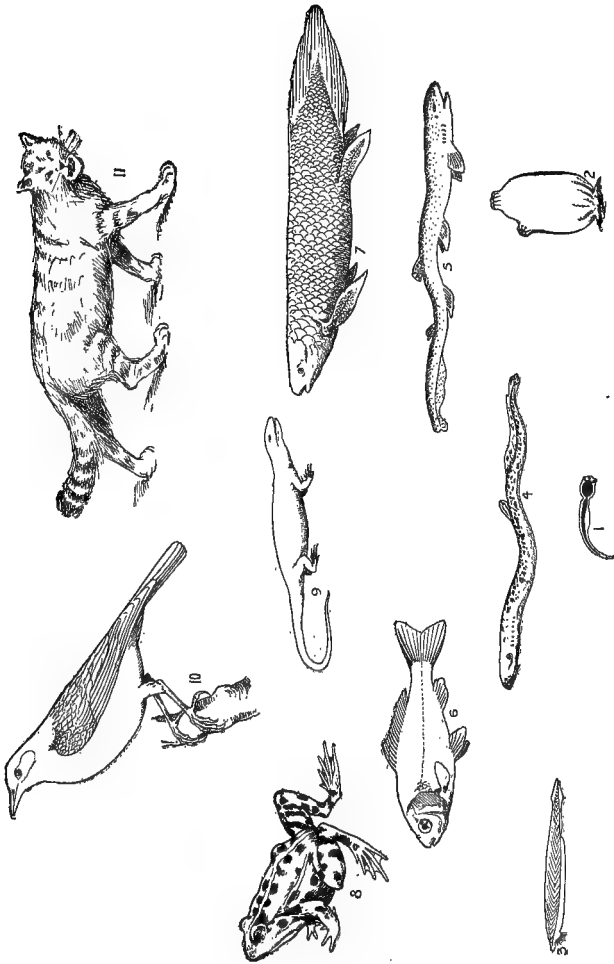

FIG. 19.—Diagram of Vertebrates.

1. Tadpole-Tunicate. 2. Ascidian. 3. Lancelet. 4. Lamprey (Cyclostome). 5. Dogfish (Elasmobranch). 6. Carp (Teleostome). 7. Mudfish (Double breather). 8. Frog (Amphibian). 9. Lizard (Reptile). 10. Starling (Keel flying bird). 11. Wild Cat (Carnivorous Mammal).

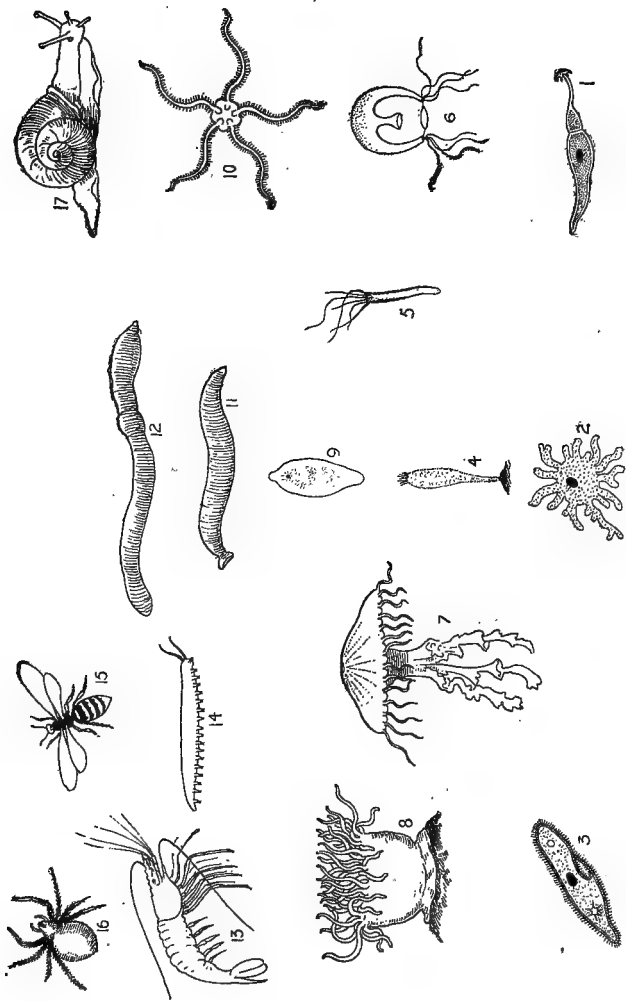

FIG. 20.—Diagram of Invertebrates.

1. Gregarine. 2. Amœba. 3. Paramoecium (Protozoa). 4. Simple Sponge. 5. Hydra. 6. Medusoid. 7. Medusa. 8. Sea-anemone (Coelenterate). 9. Liver fluke. 10. Brittle-star (Echinoderm). 11. Leech. 12. Earthworm (Annelid). 13. Prawn (Crustacean). 14. *Peripatus*. 15. Wasp. 16. Garden spider. 17. Snail (Gasteropod Mollusc).

CHAPTER II

THE FUNCTIONS OF ANIMALS

(PHYSIOLOGY)

Most animals live an active life, in great part ruled by the two motives of love and hunger in their widest sense; they are busy finding food, avoiding enemies, wooing mates, making homes, and tending the young. These and other forms of activity depend upon internal changes within the body. Thus the movements of all but the very simplest animals are due to the activity of contractile parts known as muscles, which are controlled by nervous centres and by impulse-conducting fibres, and the energy involved in these movements, and in most other vital activities, is supplied by the oxidation or combustion of the complex carbon-compounds which form a substantial part of the various organs.

The work done means expenditure of energy, and is followed by exhaustion (muscular, nervous, etc.), so that the necessity for fresh supplies of energy is obvious. This recuperation is obtained through food, but before this can restore the exhausted parts to their normal state, or keep them from becoming, in any marked degree, exhausted, it must be rendered soluble, diffused throughout the body, and so chemically altered that it is readily incorporated into the animal's substance. In other words, it has to be digested. A fresh supply of oxygen and a removal of waste are also obviously essential to continued activity.

We may say, then, that there are *two master activities* in the animal body, those of muscular and those of nervous parts. To these the other internal activities—digestion, respiration, excretion, and the like—are subsidiary.

Besides the more or less constantly recurrent activities or functions, there are the processes of growth and reproduction. When income exceeds expenditure in a young animal, growth goes on, and the inherited qualities of the organism are more and more perfectly developed. At the limit of growth, when the animal has reached "maturity," it normally reproduces—that is to say, liberates either parts of itself or special germ-cells which give rise to new individuals.

Living and not living.—Although no one is wise enough to tell completely what is meant by the simple word alive, it is safe to say that active life involves the following facts:—

(a) The living organism *grows* at the expense of material different from itself, while the crystal—one of the few not-living things which can be said to grow—increases only at the expense of material chemically the same as itself.

(b) The living organism is subject to ceaseless chemical change (metabolism), and yet it has the power of retaining its integrity, of remaining more or less the same for prolonged periods. The physical basis of life invariably includes complex compounds known as *proteids*, built up chiefly of Carbon, Hydrogen, Oxygen, and Nitrogen, and these are continually being broken down and made anew.

(c) The living organism resembles an engine, in being a material system adapted to transform matter and energy from one form to another; but it is a self-stoking, and, within limits, a self-repairing engine, and it is able to do what no engine can effect, namely, reproduce. From a physical standpoint it differs from an inanimate system in this, that the transfer of energy into it is attended with effects conducive to further transfer and retardative of dissipation, while the very opposite is true of an inanimate system.

(d) A living creature is a more or less perfect *integrate*, it has a *unified* behaviour, it gives *effective* response to external stimuli.

(e) A living organism exhibits five everyday activities—contractility (the power of movement), irritability (the power of feeling in the wide sense), nutrition or utilisation of food, respiration, and excretion, besides the periodic activities of growth and reproduction.

Division of labour.—All the ordinary functions of life are exhibited by the simple unicellular animals or Protozoa. Thus the *Amœba* moves by contracting its living substance, draws back sensitively from hurtful influences, engulfs and digests food, gets rid of waste, and absorbs oxygen.

But all these activities occur in the *Amœba* within the compass of a unit mass of living matter—a single cell, physiologically complete in itself.

In all other animals, from Sponges onwards, there is a “body” consisting of hundreds of unit areas or cells. A cell is a unified area of living matter almost always with a definite centre or nucleus. It is impossible for these cells to remain the same, for as they increase in number they become diversely related to the outer world, to food, to one another, and so on. Division of labour, consequent on diversity of conditions, is thus established in the organism. In some cells one kind of activity predominates, in others a second, in others a third. And this division of labour is associated with that complication of structure which we call differentiation.

Thus in the fresh-water *Hydra*, which is one of the simplest many-celled animals, the units are arranged in two layers, and form a tubular body. Those of the outer layer are protective, nervous, and muscular; those of the inner layer absorb and digest the food, and are also muscular.

In worms and higher organisms, there is a middle layer in addition to the other two, and this middle layer becomes, for instance, predominantly muscular. Moreover, the units or cells are not only arranged in strands or tissues, each with a predominant function, but become compacted into well-defined parts or organs. None the less should we remember that each cell remains a living unit, and that, in addition to its principal activity, it usually retains others of a subsidiary character.

Plants and animals.—Before we give a sketch of the chief functions in a higher animal, let us briefly consider the resemblances and differences between plants and animals.

(a) *Resemblance in function.*—The life of plants is essentially like that of animals, as has been recognised since Claude Bernard wrote his famous book, *Phénomènes de la vie communs aux animaux et aux végétaux*. The beech-tree feeds and grows, digests and breathes, as really as does

the squirrel on its branches. In regard to none of the main functions (except excretion) is there any essential difference. Many simple plants swim about actively; young shoots and roots also move; and there are many cases in which even the full-grown parts of plants exhibit *movement*. Moreover, the tendrils of climbers, the leaves of the sensitive plant, the tentacles of the sundew, the stamens of the rock-rose, the stigma of the musk, and many other plant structures exhibit marked *sensitiveness*.

(b) *Resemblance in structure*.—The simplest plants (Protophyta), like the simplest animals (Protozoa), are single cells; the higher plants (Metaphyta) and higher animals (Metazoa) are built up of cells and various modifications of cells. In short, all organisms have a cellular structure. This general conclusion is part of the Cell Theory or Cell Doctrine (1838).

(c) *Resemblance in development*.—When we trace the beech-tree back to the beginning of its life, we find that it arises from a unit element or egg-cell, which is fertilised by intimate union with a male element derived from the pollen-grain. When we trace the squirrel back to the beginning of its life, we find that it also arises from a unit element or egg-cell, which is fertilised by intimate union with a male cell or spermatozoon. Thus all the many-celled plants and animals begin as fertilised egg-cells, except in cases of virgin birth (parthenogenesis) or of asexual reproduction. From the egg-cell, which divides and redivides after fertilisation, the body of the plant or animal is built up by continued division, arrangement, and modification of cells.

Contrasts.—But while there is no absolute distinction between plants and animals, they represent divergent branches of a V-shaped tree of life. It is easy to distinguish extremes like bird and daisy, less easy to contrast sponge and mushroom, well-nigh impossible to decide whether some very simple forms, which Haeckel called "Protists," have a bias towards plants or towards animals. We cannot do more than state *average* distinctions. The food which most plants absorb is cruder or chemically simpler than that which animals are able to utilise. Thus most plants derive the carbon they require from the carbon dioxide of the air, while only a few (green) animals have this power; all the

others depend for their carbon supplies on the sugar, starch, and fat already made by other animals, or by plants. As regards nitrogen, most plants take this from nitrates and the like, absorbed along with water by the roots; whereas animals obtain their nitrogenous supplies from the complex proteids formed within other organisms. Most plants, therefore, feed at a lower chemical level than do animals, and it is characteristic of them that, in the reduction of carbon dioxide, and in the manufacture of starch and proteids, the kinetic energy of sunlight is transformed by the living matter into the potential chemical energy of complex foodstuffs. Animals, on the other hand, get their food ready made; they take the pounds which plants have, as it were, accumulated in pence, and they spend them. For it is characteristic of animals that they convert the potential chemical energy of foodstuffs into the kinetic energy of locomotion and other activities. In short, the great distinction—an average one at best—is that most animals are more active than most plants.

Chief functions of the animal body.—We have seen that there are two master activities in animals, those of muscular and of nervous structures, and that the other vital processes, always excepting growth and reproduction, are subservient to these. Let us now consider the various functions, as they occur in some higher organism, such as man.

Nervous activities.—Life has been described as consisting of action and reaction between the organism and its environment, and it is evident that an animal must in some way become aware of surrounding influences.

The unit in nervous reaction in any highly organised animal is the *reflex*. It requires three structures, a *receptor* (end-organ), a *conductor*, and an *effector* (muscle). The conductor consists of two or more nerve cells or neurones which span the distance between receptor and effector by means of their long processes. Stimulation of the receptor causes a nervous impulse to be transmitted along the conductor to set the effector in action. The whole nervous system is essentially a connected series of such reflex-arcs, all intricately joined up with one another.

There are two chief kinds of stimuli which are transmitted to the central nervous system—stimuli from without the

SOME EXCEPTIONS.	CHARACTERISTICS OF ANIMALS.	CHARACTERISTICS OF PLANTS.	SOME EXCEPTIONS.
<p>Some Protozoa and parasites simply absorb.</p> <p>Some green Protozoa (etc.?) seem to be able to utilise carbon dioxide as plants do (<i>helophytic</i>).</p> <p>Again, some Protozoa are probably able to feed like plants.</p> <p>A few, e.g. some Protozoa, the fresh-water sponge, <i>Hydra viridis</i>, have green pigment closely analogous or identical with chlorophyll.</p> <p>Cellulose seems to occur in some Infusorians, and forms most of the tunic or cuticle of the passive sea-squirts or ascidians.</p>	<p>They feed on more or less solid food.</p> <p>They obtain the requisite carbon from starch, sugar, fat, etc., made by plants or by other animals.</p> <p>They obtain the requisite nitrogen from nitrogenous compounds, not simpler than proteins, made by other organisms. Most of them are known to get rid of nitrogenous waste products.</p> <p>They have very rarely any chlorophyll.</p> <p>The component cells often have no very definite cell walls, rarely have them of material demonstrably different from the cell substance, and almost never show any trace of cellulose.</p> <p>Marked division of labour among the cells is characteristic.</p> <p>They utilise food material already worked up by plants or by other animals; they convert this potential energy into kinetic energy in locomotion and external work; they are characteristically oxidisers, are predominantly active, and show in the vital changes associated with their living matter or protoplasm, a <i>relative</i> preponderance of disruptive, down-breaking, or "katabolic" processes.</p>	<p>They absorb soluble food.</p> <p>They obtain the requisite carbon from carbon dioxide in the air or dissolved in water.</p> <p>They obtain the requisite nitrogen from simple nitrogenous compounds, especially the nitrates of the soil. They do not get rid of nitrogenous waste products.</p> <p>The majority possess chlorophyll, the green pigment by aid of which the living matter utilises the energy of sunlight, in reducing carbon dioxide (with liberation of oxygen), and in building up complex substances.</p> <p>The component cells are walked in by cellulose, a material chemically allied to starch.</p> <p>The cells exhibit, on an average, much less division of labour.</p> <p>They build up crude, chemically simple food material into living or complex substances; they convert the kinetic energy of sunlight into the potential chemical energy of these complex substances; they are characteristically reducers (of carbon dioxide), expend comparatively little energy in motion or external work, are predominantly passive, and show in the vital changes associated with their living matter or protoplasm, a <i>relative</i> preponderance of constructive, up-building, or "anabolic" processes.</p>	<p>Carnivorous plants, Fungi, and some parasites, find other sources of carbon-supply.</p> <p>Again, carnivorous plants, Fungi, and some parasites, are in part exceptional in their nutrition.</p> <p>Fungi and some parasites have no chlorophyll.</p> <p>Some simple plants have, for a time at least, naked cells.</p>

body, which make the organism aware of changes in its environment; and stimuli from within the body, which make it aware of the dispositions of its organs, *e.g.* the stimuli transmitted by the *afferent* nerves of the muscles, tendons, etc.

The chief functions of the nervous system are, then, to make the animal aware of its environment and to co-ordinate and integrate all its bodily functions and activities.

As we ascend in the scale, we find that in addition the brain possesses, to an increasing extent, the power of correlating present and past experiences, and of originating or inhibiting action in accordance with this correlation.

In whatever part there is activity, there is necessarily waste of complex substances and some degree of exhaustion; and it is interesting to notice, as a triumph of histological technique, that Hodge, Gustav Mann, and others have succeeded in demonstrating in nerve cells the structural results (cellular collapse, etc.) of fatigue, and that in such diverse types as bee, frog, bird, and dog.

Muscular activity.—The movements of a unicellular animal are due to the contractility of the living matter, or of special parts of the cell, such as lashes or cilia. In sponges specially contractile cells begin to appear; in most higher animals such cells are aggregated to form the muscles.

A piece of typical muscle consists of numerous fine transparent tubes or fibres, each invested by a sheath or sarcolemma, while the whole muscle is surrounded by connective tissue. It usually runs from one part of the skeleton to another, and is fastened to the skeleton by tendons or sinews. It is stimulated by motor nerves, and is richly supplied with blood.

When a muscle contracts, usually under a stimulus propagated along a motor nerve, there is of course a change of shape—it becomes shorter and broader. The source of the energy expended in work done is the “chemical explosion” which occurs in the fibres, for the oxygen stored up (intramolecularly) in the muscle enters into rapid union with carbon compounds. Heat, CO₂, and water are produced as the result of this combustion, and lactic acid is also formed as a by-product. Besides the chemical change and the change of shape, there are also

changes of "electric potential" associated with each contraction. Beside muscular movement we must rank ciliary, amœboid, and epithelial movement. Under the last heading are included active non-amœboid contractions and expansions of covering cells.

Digestion.—The energy expended in work or in growth is balanced by the energy of the food-stuffs:—proteids, carbohydrates, fats, water, and salts, in varying proportions.

In some of the lower animals, such as sponges, the food particles are engulfed by certain cells with which they come in contact, and digested within these cells (*intracellular digestion*). In most cases, however, the food is digested *within the food canal*, by ferments made by the secretory cells of the gut or of associated glands. The peculiarity of these ferments is that a small quantity can act upon a large mass of material without itself undergoing any apparent change. However digestion be effected, it means dissolving the food and making it diffusible. In a higher vertebrate there are many steps.

(a) The first ferment to affect the food, masticated by the teeth and moistened by the saliva, is the *ptyalin* of the salivary juice, which changes starch into sugar. The juice is formed or secreted by various salivary glands around the mouth.

(b) The food is swallowed, and passes down the gullet to the stomach, where it is mixed with the gastric juice secreted by glands situated in the walls. These walls are also muscular, and their contractions churn the food and mix it with the juice. In the juice there is some free hydrochloric acid and a ferment called pepsin: these act together in turning proteids into peptones. The juice has also a slight solvent effect on fat, and the acid on the carbohydrates.

(c) The semi-digested food, as it passes from the stomach into the small intestine, is called chyme, and on this other juices act. Of these the most important is the secretion of the pancreas, which contains various ferments, *e.g.* trypsin, and affects all the different kinds of organic food. It continues the work of the stomach, changing proteids into peptones and peptones into much simpler compounds such as amino-acids; it continues the work of the salivary juice, changing starch into sugar; it also emulsifies the fat, dividing the globules into extremely small drops, which it tends to saponify or split into fatty acids and glycerine.

(d) Into the beginning of the small intestine the bile from the liver also flows, but it is not of great digestive importance, being rather of the nature of a waste product. It seems to have a slight solvent, emulsifying, and saponifying action on the fats; in some animals it is

said to have slight power of converting starch into sugar; by its alkalinity it helps the action of the trypsin of the pancreas (which, unlike pepsin, acts in an alkaline fluid); it affects cell membranes, so that they allow the passage of small drops of fat and oil; and it is said to have various other qualities.

(e) In addition to the liver and the pancreas, there are on the walls of the small intestine a great number of small glands, which secrete a juice which seconds the pancreatic juice. The digested material is in part absorbed into the blood, and the mass of food, still being digested, is passed along the small intestine by means of the muscular contraction of the walls known as peristaltic action. It reaches the large intestine, and its reaction is now distinctly acid by reason of the acid fermentation of the contents. The walls of the large intestine contain glands similar to those of the small intestine, and the digestive processes are completed, while absorption of water also goes on; so that by the time the mass has reached the rectum, it is semi-solid, and is known as *fæces*. These contain the indigestible and undigested remnants of the food and the useless products of the chemical digestive processes.

Absorption.—But the food must not only be rendered soluble and diffusible, it must be carried to the different parts of the body, and there incorporated into the hungry cells. It is carried by the blood stream, and in part also by what are called lymph vessels, which contain a clear fluid resembling blood *minus* red blood corpuscles.

Absorption begins in the stomach by direct osmosis into the capillaries or fine branches of blood vessels in its walls, and a similar absorption, especially of water, takes place along the whole of the digestive tract. But lining the intestines there are delicate projections called villi; they contain capillaries belonging to the portal system (blood vessels going to the liver), and small vessels known as lacteals connected with lymph spaces in the wall of the intestine. The lacteals lead into a longitudinal lymph vessel or thoracic duct, which opens into the junction of the left jugular and left subclavian veins at the root of the neck. The contents of the duct in a fasting animal are clear; after a meal they become milky; the change is due to the matters discharged into it by the lacteals. It is probable that nearly all the fat of a meal is absorbed from the intestines by the lacteals, but it is not certain in what measure, if at all, this is true of the other dissolved foodstuffs; the greater part certainly passes into the capillaries of the portal system, which are contained in the villi. The digested proteid, chiefly in the form of amino-acids, passes into the blood of the portal vein, either directly or through the intermediary of leucocytes, which flock to the intestine when proteid food is being digested.

Function of the liver.—We now know the fate of the fats, and of the proteids of the food, and the manner in

which they pass into the blood; but we must follow the starchy material, or carbohydrates, a little further. The starch, we know, is converted into sugar, and this, with the sugar of the food, passes into the capillaries of the villi, and is carried to the liver. During digestion there is an increase of sugar in the blood vessel going to the liver from the intestine—that is, in the portal vein—but no increase in the hepatic veins, the vessels leaving the liver. The increase must therefore be retained in that organ, and we recognise as one of the functions of the liver the regulation of the amount of sugar in the blood. There is no special organ for the regulation of the amount of fat; the drops pass through the walls of the capillaries, and are stored in connective tissue cells.

All the products of digestion, except the fat, pass through the liver, which receives everything before it is allowed to pass into the general circulation. Thus many poisons, such as metals, are arrested by the liver, and various harmful substances which are formed in the course of digestion are changed by the liver into harmless compounds. The excess of sugar, we have already noted, is stored in the liver. It is synthesised there into a substance called glycogen, which can be readily retransformed into sugar according to the needs of the system. Glycogen is stored in the muscles also, and forms an important part of the fuel for the supply of muscular energy and of the warmth of the body. Thus, if an animal be subjected to a low temperature, the glycogen of the liver disappears just as it does during the performance of muscular work.

Another of the many functions of the liver is that in it nitrogenous waste products begin to be prepared for their final elimination by the kidneys.

Respiration.—There is another most important foodstuff to be noticed, namely, the oxygen which is absorbed from the air by the lungs. We may picture a lung as an elastic sponge-work of air chambers, with innumerable blood capillaries in the walls, enclosed in an air-tight box, the chest, the size of which constantly and rhythmically varies. When we take in a breath, the size of the chest is increased the air pressure within is lowered, and the air from without rushes down the windpipe until the pressure is equalised.

The oxygen of this air combines with a substance called hæmoglobin, contained in the red corpuscles of the blood, and is thus carried to all parts of the body. From the blood it passes to the tissues usually through the medium of the lymph. It is used in the tissues for oxidation. The carbon dioxide formed as a waste product is absorbed by the serum of the blood, or enters in part into loose chemical combination with its salts, and so in time reaches the lungs. But as the partial pressure of the carbonic acid in the air is lower than it is in the serum, the gas escapes from the latter into the air chambers of the lungs. When the size of the chest is decreased, the pressure is increased, and the gas escapes by the mouth or nose until the pressure is equalised.

Excretion.—We have seen that the blood carries the digested food to the various parts of the body, and that it is also the carrier of oxygen and of the waste carbon dioxide.

But there is much waste resulting from tissue changes, which is not gaseous. It is cast into the blood stream by the tissues, and has to be got rid of in some way. This is effected by the kidneys, which are really filters introduced into the blood stream. But they are the most marvellous filters imaginable, and give us a good example of the intricacy of life processes. For the kidneys not only take out of the blood all the waste products that result from the metabolism of proteids and contain nitrogen, they also maintain the composition of the blood at its normal, rejecting any stuffs that vary from that normal, either qualitatively or quantitatively, doing this work according to laws quite different from the simple ones of diffusion or solubility: thus sugar and urea are about equally soluble, and yet the sugar is kept in the body, while the urea is cast out. Even substances as insoluble as resins are removed from the blood by the living cells of the kidneys.

A considerable quantity of water, and traces of salts, fats, etc., leave the body by the skin, but its chief use is to protect, and to regulate the temperature by variations in the size of its blood vessels.

This completes our sketch—(a) of the process by which the food becomes available for the organism as fuel for the maintenance of its life energies, and (b) of the removal of

the waste products which are formed as the ashes of life.

There are indeed some organs which we have not mentioned, such as the spleen, which seems to be an area for the multiplication of red blood corpuscles (fishes, newts, embryo-mammals) or for the destruction of worn-out corpuscles (mammals), and the thyroid gland, which seems to have to do with keeping the blood at a certain standard of efficiency; but what we have said is perhaps enough to convey a general idea of the processes of life in a higher animal.

In conclusion, it is perhaps useful to remark that when in the course of further studies the student meets with organs which are called by the same name as those found in man or in Mammals, as, for example, the "liver" of the Molluscs, he must be careful not to suppose that the function of such a "liver" is the same as in Mammals, for comparatively little investigation into the physiology of the lower types of animal life has as yet been made. At the same time, he must clearly recognise that the great internal activities are in a general way the same in all animals; thus respiration, whether accomplished by skin, or gills, or air-tubes, or lungs, by help of the red pigment (hæmoglobin) of the blood, or of some pigment which is not red, or occurring without the presence of any blood at all, always means that oxygen is absorbed almost like a kind of food by the tissues, and that the carbon dioxide which results from the oxidation of part of the material of the tissues is removed.

MODERN CONCEPTION OF PROTOPLASM

The activities of animals are ultimately due to physical and chemical changes associated with the living matter or protoplasm. This is a mere truism. We do not know the nature of this living matter; perhaps our most certain knowledge of it is, that in our brains its activity is associated with consciousness.

When more is known in regard to the chemistry and physics of living matter, it may be possible to bring vital phenomena more into line with the changes which are observed in inorganic things. At present, however, it is idle to deny that vital phenomena are things apart. Not even the simplest of them can be explained in terms of chemistry and physics. Even the passage of digested food from the gut to the blood vessels is more than ordinary

physical osmosis ; it is modified by the fact that the cells are living.

But though we cannot analyse living matter, nor thoroughly explain the changes by which the material of the body breaks down or is built up, we can trace, by chemical analysis, how food passes through various transformations till it becomes a usable part of the living body, and we can also catch some of the waste products formed when muscles or other parts are active.

What is known in regard to the structure of protoplasm does not help the physiologist very much. The microscopists discover an intricate structure which pervades each unit of living matter, but no physiologist dreams of explaining the life of a cell in terms of its microscopically visible structure.

One general idea, however, the study of structure has suggested, which the conclusions of physiologists corroborate. This idea is—that a cell consists of a relatively stable living framework, and of a changeful content enclosed by it.

Now, many physiologists regard the framework as the genuine living protoplasm, and the content as the material upon which it acts. “The framework is the acting part, which lives, and is stable ; the content is the acted-on part, which has never lived, and is labile, that is,—in a state of metabolism or chemical transformation.” This view naturally leads those who adopt it to regard protoplasm as a sort of ferment acting on less complex material which is brought to it, which forms the really changeful part of each cell.

Somewhat different, however, is another idea,—that the protoplasm is itself the seat of constant change ; that it is constantly being unmade and remade. On the one hand, more or less crude food passes into life by an ascending series of assimilative or constructive chemical changes, with each of which the material becomes molecularly more complex and more unstable. On the other hand, the protoplasm, as it becomes active or a source of energy, breaks down in a descending series of disruptive or destructive chemical changes ending in waste products.

The former view, which considers protoplasm as a sort of ferment, restricts the metabolism to the material on which the protoplasm acts. The second view regards protoplasm as the climax or central term of the constructive and disruptive metabolism.

It is highly probable that there is no one substance which should be called protoplasm, but that vital phenomena depend upon the inter-actions of several complex substances. As Verworn says, “The life-process consists in the metabolism of proteids.”

Generalising from his studies on colour sensation, Professor Hering was led to regard all life as an alternation of two kinds of activity, both induced by stimulus, the one tending to storage, construction, assimilation of material, the other tending to explosion, disruption, disassimilation.

Generalising from his studies on nervous activities, Professor Gaskell was led to regard all life as an alternation of two processes, one of them a running down or disruption (katabolism), the other a winding up or construction (anabolism).

All physiologists are agreed that in life there is a twofold process of waste and repair, of discharge and restitution, of activity and recuperative rest. But there is no certainty as to the precise nature of this twofold process.

CHAPTER III

THE ELEMENTS OF STRUCTURE

(MORPHOLOGY)

ANIMALS may be studied alive or dead, in regard to their activities or in regard to their parts. We may ask how they live, or what they are made of; we may investigate their functions or their structure. The study of life, activity, function, is *physiology*; the study of parts, architecture, structure, is *morphology*.

The first task of the morphologist is to describe structure (descriptive anatomy); the second is to compare the parts of one animal with those of another (comparative anatomy); the third is to try to state the "principles of morphology," or the laws of vital architecture.

But just as the physiologist investigates life or activity at different levels, passing from his study of the animal as a unity with certain habits, to consider it as an engine of organs, a web of tissues, a city of cells, and a whirlpool of living matter; so the morphologist has to investigate the form of the whole animal, then in succession its organs, their component tissues, their component cells, and finally, the structure of protoplasm itself. The tasks of morphology and of physiology are parallel.

Morphology thus includes not only the description of external form, not only the anatomy of organs, but also that minute anatomy of tissues and cells and protoplasm which we call histology. Moreover, there is no real difference between studying fossil animals which died and were buried countless years ago, and dissecting a modern frog. The anatomical palæontologist is also a student of morphology.

Finally, as the greater part of embryology consists in studying the anatomy and histology of an organism at various stages of its development, the work of the embryologist is also in the main morphological, though he has also to inform us, if he can, about the physiology of development.

Morphology has been defined by Geddes as "the study of all the statical aspects of organisms," in contrast to physiology, which is concerned with their vital dynamics. In this chapter we shall follow the historical development of morphology, and work from the outside inwards.

I. Form and symmetry.—The form of an animal is due to the interaction of two variables—the protoplasmic material which composes the organism, and the environment which plays upon it. In fact, an animal takes definite form just as a mineral does: in both the shape is determined by the nature of the stuff and by the surrounding influences. Activity, or function, also affects form; but function is merely action and reaction between the animal and its surroundings.

As regards symmetry, animals may be distinguished as—(a) radially symmetrical; (b) bilaterally symmetrical; (c) asymmetrical.

In a radially symmetrical animal, such as a jelly-fish, the body can be halved by a number of vertical planes—it is symmetrical around a median vertical axis. That is, it is the same all round, and has no right or left side. In a bilaterally symmetrical body, such as a worm's, there is but one plane through which the body can be halved. In an asymmetrical animal, such as a snail, accurate halving is impossible.

Radial symmetry is illustrated by simple Sponges, most Coelentera, and by many *adult* Echinoderms. As it is the rule in the two lowest classes of Metazoa, and as it is characteristic of the very common embryonic stage known as the gastrula (an oval or thimble-shaped sac consisting of two layers of cells), it is probably more primitive than the bilateral symmetry characteristic of most animals above Coelentera. Radial symmetry seems best suited for sedentary life, or for aimless floating and drifting. Bilateral symmetry probably arose as it became advantageous for animals to move energetically and in definite directions, to pursue their prey, avoid their enemies, and seek their mates. The formation of a "brain" is correlated with the habit of moving head foremost. Among many-celled animals, some worm type probably deserves the credit of beginning the profitable habit of moving head foremost. Had some one not taken this step, we should never have known our right hand from our left.

II. Organs.—We give this name to any well-defined part of an animal, such as heart or brain. The word suggests a piece of mechanism; but the animal is more than a complex engine, and many organs have several different activities to which their visible structure gives little clue.

Differentiation and integration of organs.—When we review the animal series, or study the development of an individual, we see that organs appear gradually. The gastrula cavity—the future stomach—is the first acquisition, though some would make out that it was primitively a brood-chamber. To begin with, it is a simple sac, but it soon becomes complicated by digestive and other out-growths. The progress of the individual, and of the race, is from apparent simplicity to obvious complexity. We also notice that before definite nervous organs appear there is diffuse irritability, before definite muscular organs appear there is diffuse contractility, and so on. In other words, functions come before organs. The attainment of organs implies specialisation of parts, or concentration of functions in particular areas of the body.

If we contrast a frog with *Hydra*, one of the great facts in regard to the evolution of organs is illustrated. Among the living units which make up a frog, there is much more division of labour than there is among those of *Hydra*. An excised representative sample of *Hydra* will reproduce the whole animal, but this is not true of the frog. The structural result of this physiological division of labour is *differentiation*. The animal, or part of it, becomes more complex, more heterogeneous.

If we contrast a bird and a sponge, another great fact in regard to the evolution of organs is illustrated. The bird is more of a unity than a sponge; its parts are more closely knit together and more adequately subordinated to the life of the whole. This kind of progress is called *integration*. Differentiation involves the acquisition of new parts and powers, these are consolidated and harmonised as the animal becomes more integrated.

Correlation of organs.—It is of the very nature of an organism that its parts should be mutually dependent. The organs are all partners in the business of life, and if one member changes, others also are affected. This is especially

true of certain organs which have developed and evolved together, and are knit by close physiological bonds. Thus the circulatory and respiratory systems, the muscular and the skeletal systems, the brain and the sense organs, are very closely united, and they are said to be *correlated*. A variation, for better or worse, in one system often brings about a *correlated variation* in another, though we cannot always trace the physiological connection.

Homologous organs.—Organs which arise from the same primitive layer of the embryo (see Chapter IV.) have something in common. But when a number of organs arise in the same way, from the same embryonic material, and are at first fashioned on the same plan, they have still more in common. Nor will this fundamental sameness be affected though the final shape and use of the various organs be very different. We call organs which are thus structurally and developmentally similar, *homologous*. Thus the nineteen pairs of appendages on a crayfish are all homologous; the three pairs of "jaws" in an insect are homologous with the insect's legs; and it is also true that the fore-leg of a frog, the wing of a bird, the flipper of a whale, the arm of a man, are all homologous. The wing of a bird and the arm of man exhibit the same chief bones, blood vessels, muscles, and nerves, and they begin to develop in the same way; they are *homologous but not analogous*. The wing of a bird and the wing of an insect, which resemble one another in being organs of flight, are not the least alike in structure; they are *analogous but not homologous*. Yet two organs may be *both homologous and analogous*, e.g. the wing of a bird and the wing of a bat, for both are fore-limbs, and both are organs of flight. Sometimes two organs or two organisms—deeply different in structure—have a marked superficial resemblance, simply because both have arisen in relation to similar conditions of life. Thus a burrowing amphibian, a burrowing lizard, and a burrowing snake resemble one another in being limbless, but this "convergence," or "homoplasty," of form does not indicate any relationship between them.

Change of function.—Division of labour involves restriction of functions in the several parts of an animal, and no higher Metazoa could have arisen if all the cells had

remained with the many-sided qualities of Amœbæ. Yet we must avoid thinking about organs as if they were necessarily active in one way only. For many organs, e.g. the liver, have several very distinct functions. In addition to the main function of an organ, there are often secondary functions; thus the wings of an insect may be respiratory as well as locomotor, and part of the food canal of Tunicates and *Amphioxus* is almost wholly subservient to respiration. Moreover, in organs which are not very highly specialised, it seems as if the component elements retained a considerable degree of individuality, so that in course of time what was a secondary function may become the primary one. Thus Dohrn, who especially emphasised this idea of function change, says: "Every function is the resultant of several components, of which one is the chief or primary function, while the others are subsidiary or secondary. The diminution of the chief function and the accession of a secondary function changes the total function; the secondary function becomes gradually the chief one; the result is the modification of the organ." The contraction of a muscle is always accompanied by electric changes, and in the electric organs of fishes we see the electric changes in the modified muscular tissue composing the organs becoming more important than the contractility. The structure known as the allantois is an unimportant bladder in the frog, in Birds and Reptiles it forms a foetal membrane (chiefly respiratory) around the embryo, and in most Mammals it forms part of the placenta which effects vital connection between offspring and mother.

Substitution of organs.—The idea of several changes of function in the evolution of an organ, suggests another of not less importance which has been emphasised by Kleinenberg. An illustration will explain it. In the early stages of all vertebrate embryos, the supporting axial skeleton is the notochord,—a rod developed along the dorsal wall of the gut. From Fishes onwards, this embryonic axis is gradually replaced in development by the vertebral column or backbone; the notochord does not become the backbone, but is replaced by it. It is a temporary structure, around which the vertebral column is constructed, as a tall chimney may be built around an internal scaffolding of

wood. Yet it remains as the sole axial skeleton in *Amphioxus*, persists in great part in hag and lamprey, but becomes less and less persistent in Fishes and higher Vertebrates, as its substitute, the backbone, develops more perfectly. Now, what is the relation between the notochord and its substitute the backbone, seeing that the former does not become the latter? Kleinenberg's suggestion is that the notochord supplies the stimulus, the necessary condition, for the formation of the backbone. Of course we require to know more about the way in which an old-fashioned structure may stimulate the growth of its future substitute, but the general idea of one organ leading on to another is suggestive. It is consistent with our general conception of development—that each stage supplies the necessary stimulus for the next step; it also helps us to understand more clearly how new structures, too incipient to be of use, may persist, and why old structures should linger though they have only a transitory importance.

Rudimentary organs.—In many animals there are structures which attain no complete development, which are rudimentary in comparison with those of related forms, and seem retrogressive when compared with their promise in embryonic life. But it is necessary to distinguish various kinds of rudimentary structures. (a) As a pathological variation, probably due to some germinal defect, or to the insufficient nutrition of the embryo, the heart of a mammal is sometimes incompletely formed. Other organs may be similarly spoilt in the making. They illustrate *arrested development*. (b) Some animals lose, in the course of their life, many of the prominent characteristics of their larval life; thus parasitic crustaceans at first free-living, and sessile sea-squirts at first free-swimming, always undergo *degeneration*, which can be seen in each lifetime. (c) But the little kiwi of New Zealand, with mere apologies for wings, and many cave fishes and cave crustaceans with slight hints of eyes, illustrate degeneration, which has taken such a hold of the animals that the young stages also are degenerate. The retrogression cannot be seen in each lifetime, evident as it is when we compare these degenerate forms with probable ancestors. (d) But among "rudimentary organs" we also include structures somewhat different, e.g. the gill-

clefts which persist in embryonic reptiles, birds, and mammals, though most of them serve no obvious purpose, or the embryonic teeth of whalebone whales. These are "*vestigial structures*," traces of ancestral history, and intelligible on no other theory. The gill-clefts are used for respiration in all vertebrates below reptiles; the ancestors of whalebone whales doubtless had functional teeth.

Classification of organs.—We may arrange the various parts of the body physiologically, according to their share in the life. Thus some parts have most to do with the *external* relations of the animals; such as locomotor, prehensile, food-receiving, protective, aggressive, and copulatory organs. Of *internal* parts, the skeletal structures are passive; the nervous, muscular, and glandular parts are active. The reproductive organs are distinct from all the rest. They are conveniently called "gonads," which is a better term than reproductive glands. For by a gland we mean an organ which secretes, whose cells produce and liberate some definite chemical substance, such as a digestive ferment; whereas the gonads are organs where there is periodic multiplication of certain cells, kept apart from the specialisation characteristic of most of the "body cells" or "somatic" cells. It is true, however, that an accessory glandular function is often associated with the gonads.

Another classification of organs is embryological, *i.e.* according to the embryonic layer from which the various parts arise. Thus the outer layer of the embryo (the ectoderm or epiblast) forms in the adult—(1) the outer skin or epidermis; (2) the nervous system; (3) much at least of the sense organs: the inner layer of the embryo (the endoderm or hypoblast) forms at least an important part (the "mid-gut") of the food canal, and the basis of outgrowths (lungs, liver, pancreas, etc.) which may arise therefrom, and also the notochord of Vertebrates: the middle layer of the embryo (the mesoderm or mesoblast) forms skeleton, connective swathings, muscle, lining of body-cavity, etc.

III. Tissues.—Zoological anatomists, of whom Cuvier may be taken as a type, analyse animals into their component organs, and discover the homologies between one animal and another. But as early as 1801, Bichât had published his *Anatomie générale*, in which he carried the analysis further, showing that the organs were composed of *tissues*, contractile, nervous, glandular, etc. In 1838–39, Schwann and Schleiden formulated the "cell theory," in which was stated the result of yet deeper analysis—that all organisms have a *cellular* structure and origin. The simplest animals (Protozoa) are typically single cells or unit masses of living matter; as such all animals begin; but all,

except the simplest, consist of hundreds of these cells united into more or less homogeneous companies (tissues), which may be compacted, as we have seen, into organs. If we think of the organism as a great city of cells, the tissues represent streets (like some of those in Leipzig), in each of which some one kind of function or industry predominates.

The student should read the introductory chapters in one of the numerous works on histology, so as to gain a general idea of the characters of the different tissues.

There are four great kinds,—epithelial, connective, muscular, and nervous.

(a) *Epithelial tissue* is illustrated by the external layer of the skin (epidermis), the internal (endothelial) lining of the food canal and its outgrowths, the lining of the body cavity, etc.; by the early arrangements of cells in all embryos; and by the simplest Metazoa, such as *Hydra*, whose tubular body is formed by two layers of epithelium. Embryologically and historically, epithelium is the most primitive kind of tissue. It may be single layered or stratified; its cells may be columnar, scale-like, or otherwise. The cells may be close together, or separated by intercellular spaces, and they are often connected by bridges of living matter. Nor are the functions of epithelium less diverse than its forms, for it may be ciliated (effecting locomotion, food-wafting, etc.), or sensitive (and as such forming sense organs), or glandular (liberating certain products or even the whole contents of its cells), or pigmented (and thus associated with respiration, excretion, and protection), or covered externally with a sweated-off cuticle, susceptible of many modifications (especially of protective value).

(b) *Connective tissue*.—This term includes too many different kinds of things to mean much. It represents a sort of histological lumber-room.

The embryologists help us a little, for they have shown that almost all forms of connective tissue are derived from the mesoderm or middle layer of the embryo. As this mesoderm usually arises in the form of outgrowths from the gut, or from (“mesenchyme”) cells liberated at an early stage from either (?) of the two other layers of the embryo (ectoderm or endoderm), we may say that connective tissue is primarily derived from epithelium.

The general function of “connective tissue” is to enswathe, to bind, and to support, but the forms assumed are very various.

The cells may be without any intercellular “mortar” or matrix. They may be laden with fat or with pigment.

In other cases the cells of the connective tissue lie in a matrix, which they secrete, or into which they in part die away. Sometimes the matrix becomes secondarily invaded by cells. The connective cells are very often irregular in outline, and give off, in most cases, fine processes, which traverse the matrix as a network. They may secrete long fibres, as in the various kinds of fibrous tissue. The fibrous tissue

of tendons and the different kinds of gristle or cartilage illustrate connective tissue with much matrix. Cartilage is sometimes hardened by the deposition of lime salts in its substance, and then has a slight resemblance to another kind of "connective tissue"—bone. But bone, which is restricted to Vertebrate animals, is quite different from the cartilage which it often succeeds and replaces. It is made by strands or layers of special bone-forming cells (osteoblasts), which may rest on a cartilage foundation, or may be quite independent. These osteoblasts form the bone matrix, and some of them are involved in it, and become the permanent bone cells. These have numerous radiating branches, and are arranged in concentric layers, usually around a cavity or a blood vessel. (There are no blood vessels in cartilage.) The matrix becomes very rich in lime salts (especially phosphate); and the cartilage foundation, if there was one, is quite destroyed by the new formation. Here we may also note two important fluid tissues, the floating corpuscles or cells of the blood, and those of the body cavity or "perivisceral" fluid, which is often abundant and important in back-boneless animals.

(c) *Muscular tissue*.—The single-celled *Amœba* moves by flowing out on one side and drawing in its substance on another. It is diffusely contractile, and it has also sensitive, digestive, and other functions.

In *Hydra* and some other Cœlentera the bases of some of the epithelial cells which form the outer and inner layers are prolonged into contractile roots. Here, then, we have cells of which a special part discharges a contractile or muscular function, while the other parts retain other powers.

In other Cœlentera the muscular cells are still directly connected with the epithelium, but become more and more exclusively contractile. In all other animals the muscular tissue is derived from the mesoderm, which, as we have already mentioned, is not distinctly present in Cœlentera. In the majority, the muscle cells arise on the walls of the body cavity, and their origin may often at least be described as epithelial. But in other cases the muscles arise from those wandering "mesenchyme" cells to which we have already referred.

Smooth or unstriped muscle fibres are elongated contractile cells, externally homogeneous in appearance. They are especially abundant in sluggish animals, e.g. Molluscs, and occur in the walls of the gut, bladder, and blood vessels of Vertebrates. They are less perfectly differentiated than striped muscle fibres, and usually contract more slowly.

A striped muscle fibre is a cell the greater part of which is modified into a set of parallel longitudinal fibrils, with alternating "clear and dark" transverse stripes. A residue of unmodified cell substance, with a nucleus or with many, is often to be observed on the side of the fibre, and a slight sheath or sarcolemma forms the "cell wall." Many muscle fibres closely combined, and wrapped in a sheath of connective tissue, form a muscle, which, as every one knows, can contract with extreme rapidity when stimulated by a nervous impulse.

(d) *Nervous tissue*.—Beginning again with the *Amœba*, we recognise that it is diffusely sensitive, and that a stimulus can pass from one part of the cell to another.

In some Cœlentera a few of the external cells seem to combine contractile and nervous functions. Therefore they are sometimes called "neuro-muscular."

But in *Hydra* there are superficial sensory cells, whose basal prolongations are connected either directly with contractile cells, or with deeper ganglion-cells, some of which give off motor processes to the contractile cells.

In sea-anemones and some other Cœlentera there is a more sharply defined division of labour. Superficial sensory cells are connected with subjacent nerve- or ganglion-cells, from which fibres pass to the contractile elements.

In higher animals the sensory cells are mostly integrated into sense organs, the ganglionic cells into ganglia, while the delicate fibres which form the connections between sensory cells and ganglionic cells, and between the latter and muscles, are represented by well-developed nerves.

So far as we know, nervous tissue always arises from the outer or ectodermic layer of the embryo, as we would expect from the fact that this is the layer which, in the course of history, has been most directly subjected to external stimulus.

Let us consider first the ganglionic cells which receive stimuli and shunt them, which regulate the whole life of the organism, and are the physical conditions of "spontaneous" activity and intelligence. They are of very varied shape, but consist always of a cell-body which gives off one or more processes. One of these processes is long, branches very sparingly, and is known as the axis-cylinder. There are usually present other processes which ramify like the branches of a tree and are called dendrites. The cell-body contains a nucleus, distinct granules, and a network of fine fibrils. The nervous system is built up of such "neurons." In the ganglia they are supported and held apart by much-branched neuroglia cells.

In all but a few of the simplest Metazoa, the nerve fibres (axis-cylinders) are surrounded by a sheath called the neurilemma, said to be formed by adjacent connective tissue. Several nerve fibres may combine to form a nerve, but each still remains ensheathed in its neurilemma while fibrous sheaths bind the nerve fibres together. In Vertebrate animals each nerve fibre usually has in addition a medullary sheath. But even in the higher Vertebrates, "non-medullated" or simply contoured nerve fibres are found in the sympathetic and olfactory nerves, and this simpler type alone occurs in hag, lamprey, and lancelet, as well as in all the Invertebrates with distinct nerves.

A nerve fibre contains numerous fibrils like those seen within a ganglion cell. These are regarded by some as the essential elements in conducting stimuli, while others maintain that the essential part is the less compact, sometimes well-nigh fluid stuff between the fibrils, or that the fibrils are but the walls of tubes within which the essentially nervous stuff lies.

The nerve fibres arise as prolongations of the ganglion cells, which extend themselves in the embryo like Amœbæ sending out pseudopodia.

IV. Cells.—In discussing tissues, it was necessary to refer to the component cells. Let us now consider the chief characteristics of these elements.

A cell is a unit mass or area of living matter usually with a nucleus. Most of the simplest animals and plants (Protozoa and Protophyta) are single cells; eggs and male elements are single cells; in multicellular organisms the cells are combined into tissues and organs.

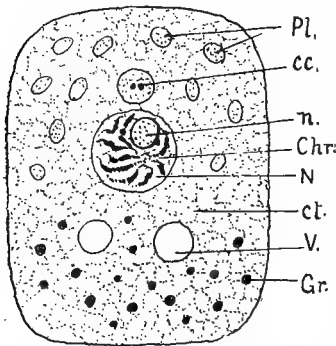

FIG. 21.—Diagram of cell structure.
—After Wilson.

- Pl. Plastids in cytoplasm.
- cc. Centrosome.
- n. Nucleolus.
- Chr. Chromosomes.
- N. Nucleus.
- ct. General cytoplasm.
- V. Vacuole.
- Gr. Granules.

Most cells are too small to be distinguished except through lenses; many Protozoa, *e.g.* large Amœbæ, are just visible to our unaided eyes; the chalk-forming Foraminifera are single cells, whose shells are often as large as pin-heads, and some of the extinct kinds were as big as half-crowns (see Fig. 17); the bast cells of plants may extend for several inches; the largest animal cells are eggs distended with yolk.

The typical and primitive form of cell is a sphere—a shape naturally assumed by a complex coherent substance situated in a medium different

from itself. Most egg-cells and many Protozoa retain this primitive form, but the internal and external conditions of life (such as nutrition and pressure) often evolve other shapes,—oval, rectangular, flattened, thread-like, stellate, and so on.

As to the structure of a cell, we may distinguish (see Fig. 21)—

(a) The general cell substance or cytoplasm, which consists partly of genuinely living stuff or protoplasm, and partly of complex materials not really living (metaplasm);

(b) A specialised nucleus, with a complex structure, and important functions ;

(c) One or more specialised bodies called central corpuscles or centrosomes, which seem to be centres of activity during cell division ;

(d) A cell wall, which occurs in very varied form, or may be entirely absent.

(a) *As to the cell substance*, it often appears at first sight almost homogeneous, but higher magnification shows considerable structural complexity. It is certainly not like white of egg, but shows a reticular, fibrillar, or vacuolar structure. It is usually slightly fluid, but it may be firm and compact in passive cells. It is usually translucent, but there are often obscuring granules of different kinds.

In thinking of the cell substance or cytoplasm, we distinguish the genuinely living protoplasm, which may be a mixture of proteids, from other materials of simpler chemical composition, such as carbohydrates, fats, pigments, etc. Some of these may be nutritive materials in process of elaboration into more complex substances ; others are disruptive products of the metabolism.

(b) *As to the nucleus*, one at least is present in almost every cell. It used to be said that some very simple animals, which Haeckel called Monera, had no nuclei, but in many cases the nuclei have now been demonstrated. In other cases, e.g. some Infusorians, the nuclear material seems to be diffused in the cell substance. The red blood cells of Mammals seem to be distinctly nucleated in their early stages, though there is no nucleus in those which are full grown.

The nucleus is a very important part of the cell, but it is not yet possible to define precisely what its importance is. In fertilisation an essential process is the union of the nucleus of the spermatozoon or male cell with the nucleus of the ovum or female cell (Fig. 23). In cell division the nucleus certainly plays an essential part. Cells bereft of their nuclei die, or live for a while a crippled life. According to some, the nucleus is important in connection with the nutrition of the cell ; according to others, it is of special importance in connection with the respiration of the cell. It is certain that there are complex actions and reactions

between the living matter of the nucleus and that of the cytoplasm. Cytoplasm and nucleoplasm form a "cell firm," potent in their co-operation. In many cells it has been shown that fragments or extensions of the nucleus pass into the cytoplasm, forming what is called a "chromidial apparatus," which seems to be of much functional importance.

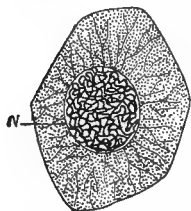

FIG. 22. — Structure of the cell.—After Carnoy.

N, Nucleus with chromatin coil; note protoplasmic reticulum.

The nucleus often lies within a little nest in the midst of the cell substance, but it may shift its position from one part of the cell to another. It has a definite margin, but this may be lost, *e.g.* before cell division begins. Internally, it is anything but homogeneous (see Fig. 22); at any rate, homogeneous nuclei are rare. Twisted strands or tubes of "linin" bear a more stainable material called "chromatin," and when the cell is preparing to divide the strands assume the form of a definite number of separable rods or loops or granules, the "chromosomes." Surrounding the linin and chromatin is the nuclear sap.

Sometimes a linin thread shows a row of minute chromatin bodies (microsomata), like jewel-stones embedded on a belt. Weismann maintains that the chromosomes or idants of the germ-cells are the vehicles of the heritable qualities. He has made a hypothetical scheme, according to which the chromosomes or *idants* are built up of *ids*, and the *ids* of *determinants*, and the determinants of *biophors*.

Many nuclei also contain little round bodies or nucleoli, or sometimes a single nucleolus. The term is applied somewhat vaguely to little aggregations of chromatin, and more properly to vacuole-like bodies, in which some believe that the waste products of the nucleus are collected.

(*c*) *As to the centrosomes*, it may be noted that when an animal cell divides, these bodies play an important part. The chromatin elements of the nucleus are divided, and separate to form the two daughter nuclei. In this separation extremely fine "archoplasmic" threads pass from the centrosomes to the chromosomes. The centrosomes are therefore regarded as "division organs," or as "dynamic centres." They also occur, in most cases singly, in resting

cells, and it seems likely that they are present in most animal cells, at least in those which retain the power of division.

(d) *As to the cell wall*, it seemed of much moment to the earlier histologists, who often spoke of cells as little bags or boxes. It is, however, the least important part of the cell. In plant cells there is usually a very distinct wall, consisting of cellulose. This is a product, not a part, of the protoplasm, though some protoplasm may be intimately associated with it as long as its growth continues. In animal cells there is rarely a very distinct

wall chemically distinguishable from the living matter itself. But the margin is often different from the interior, and a slight wall may be formed by a superficial compacting of the threads of the cell network, or by a physical alteration of the cell substance, comparable to the formation of a skin on cooling porridge. In other cases, especially in cells which are not very active, such as ova and encysted Protozoa, a more definite sheath is formed around the cell substance. Again, animal cells may secrete a superficial "cuticle," e.g. the chitin formed by the ectoderm cells in Insects, Crustaceans, and other Arthropods.

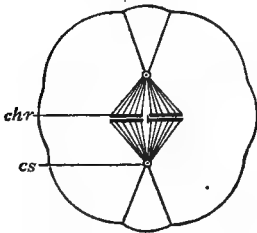

FIG. 24.—Diagram of cell division.—After Boveri.

chr., Chromosomes forming an equatorial plate; *cs.*, centrosome.

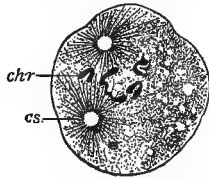

FIG. 23.—Fertilized ovum of *Ascaris*.—After Boveri.

chr., Chromatin elements, two from ovum nucleus and two from sperm nucleus; *cs.*, centrosome from which "archoplasmic" threads radiate, partly to the chromosomes.

In animals, as well as in plants, adjacent cells are often linked by intercellular bridges of living matter, which may be paths for the passage of materials or of disturbances from cell to cell. In many cases, e.g. of gelatinous tissue, a matrix arises outside of and between the cells, as an exoplasmic product.

In regard to cell division, the most important facts are the

following:—There is a striking similarity in most cases, and the nucleus plays an essential part in the process. The dividing nucleus usually passes through a series of complex changes known as karyokinesis or mitosis, and these are much the same everywhere, though different kinds of cells have their specific peculiarities. Occasionally, however, both in Protozoa and Metazoa, the nucleus divides by simple constriction (direct or amitotic division). This is a quicker process than the other, and occurs especially when there is rapid growth or frequent replacement of cells. Another departure from the ordinary scheme is seen when the nucleus shows a multiple division, while the cell remains undivided. This occurs normally in some marrow cells.

The eventful changes of karyokinesis are as follows:—

- (a) The *resting stage* of the nucleus shows a network or complete coil of filaments (chromatin elements) (Fig. 22).
- (b) *First stage*.—As division begins, the membrane separating the nucleus from the cell substance disappears, and the chromatin elements are seen as a tangled or broken coil (Fig. 25, 1).
- (c) *Astroid stage*.—The chromatin elements bend into looped pieces (or chromosomes), which are disposed in a star, lying flat at the equator of the cell, the free ends of the U-shaped loops being directed outwards. Meanwhile a centrosome has appeared and divided into two separating halves, between which a spindle of fine achromatin threads is formed. This seems to form (at least part of) what is called the nuclear spindle. The centrosomes separate until one lies at each pole of the cell, surrounded by radiating “archoplasmic” threads which become attached to the chromosomes (Fig. 25, 2).
- (d) *Division and separation of the loops*.—Each of the loops which make up the star divides *longitudinally* into two, and each half separates from its neighbour. They lie at first near the equator of the cell, but they are apparently drawn, or driven, to the opposite poles (Fig. 25, 2-4).
- (e) *Diastroid*.—The single star thus forms two daughter stars, which separate farther and farther from one another towards the opposite poles of the cell, remaining connected, however, by delicate threads (Fig. 25, 3-5).
- (f) Each daughter star is reconstituted into a coil or network for each daughter cell, for the cell substance has been constricted meanwhile at right angles to the transverse axis of the spindle. The halves separate in the case of Protozoa, but in most other cases, *e.g.* growing embryos, they remain adjacent, with a slight wall between them (Fig. 25, 6).

(g) Each daughter nucleus then passes into the normal resting phase. The spindle disappears, and the centrosomes may also vanish.

The essential fact is the exact partition of the nuclear material between the two daughter cells

Flemming gives the following summary of karyokinesis:—

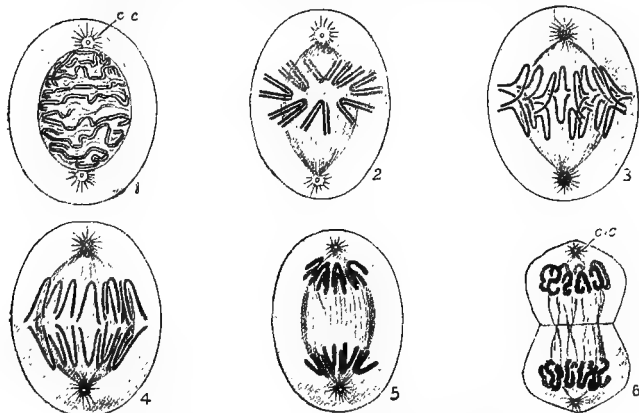
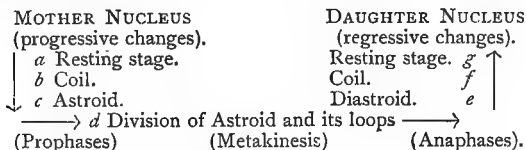

FIG. 25.—Karyokinesis.—After Flemming.

1. Coil stage of nucleus; *c.c.*, central corpuscle.
2. Division of chromatin elements into U-shaped loops, and longitudinal splitting of these (astroid stage).
3. 4. Recession of chromatin elements from the equator of the cell (diastroid).
5. Nuclear spindle, with chromatin elements at each pole, and achromatin threads between.
6. Division of the cell completed.

Besides the ordinary indirect division just described, the net result of which is that each of the two daughter cells gets an equal number of chromosomes, a precise half of each of the chromosomes in the original cell, there is another kind of cell division (meiotic or reducing division) which occurs only in the maturation of the ovum and

spermatozoon, and has for its net result the reduction of the number of chromosomes to a half of the normal number.

We are far from being able to give even an approximate account of the "mechanism" of cell division. The whole process is vital, and cannot, at present at least, be re-described in terms of matter and motion.

On the other hand, Leuckart, Spencer, and Alexander James have given a general rationale of cell division. Why do not cells grow much larger? why do they almost always divide at a definite limit of growth? The answer is as follows:—Suppose a young cell has doubled its original volume, that means that there is twice as much living matter to be kept alive. But the living matter is fed, aerated, purified through its surface, which, in growing spherical cells, for instance, only increases as the square of the radius, while the mass increases as the cube. The surface growth always lags behind the increase of mass. Therefore, when the cell has, let us say, quadrupled its original volume, but by no means quadrupled its surface, difficulties set in, waste begins to gain on repair, anabolism loses some of its ascendancy over katabolism. At the limit of growth the cell divides, halving its mass and gaining new surface. It is true that the surface may be increased by out-flowing processes, just as that of leaves by many lobes; and division may occur before the limit of growth is reached, but, as a general rationale, applicable to organs and bodies as well as to cells, the suggestion above outlined is very helpful. The ratio of the amount of nuclear material in the cell to the amount of cytoplasmic material seems also to have a determining influence upon cell division (R. Hertwig).

Protoplasm.—Morphological as well as physiological analysis passes from the organism as a whole to its organs, thence to the tissues, thence to the cells, and finally to the protoplasm itself. But although we may define protoplasm as genuinely living matter—as "the physical basis of life"—we cannot definitely say how much or what part of an Amœba, or an ovum, or any other cell, is really protoplasm. We are able to make negative statements, *e.g.* the yolk of an egg is not protoplasm, but we cannot make positive statements, or say, *This* is protoplasm, and nought else.

Thus what is spoken of as the structure of protoplasm is really the structure of the cytoplasm. It is often specifically different in different cases.

In regard to this structure, we know that it is very complex, but we are not sure of much more. For different experts see different appearances, even in the same cells.

Thus some, *e.g.* Frommann, describe a network or reticulum, with less stable material in the meshes; others, *e.g.* Flemming, describe a manifold coil of fibrils; and others, *e.g.* Bütschli, describe a foam-like or vacuolar structure. It seems likely that the structure is different at different times, or in different cells.

Professor Bütschli's belief that the cytoplasm has a vacuolar structure is corroborated by his interesting experiments on microscopic foams. Finely powdered potassium carbonate is mixed with olive oil which has been previously heated to a temperature of 50°–60° C., an acid from the oil splits up the potassium carbonate, liberates carbon dioxide, and forms an extremely fine emulsion. Drops of this show a structure not unlike that of cytoplasm, exhibit movements and streamings not unlike those of *Amœbæ*, and are, in short, mimic cells. Just as a working model may help us to understand the circulation, so these oil-emulsion drops may help us to understand the living cell, by bringing the strictly vital phenomena into greater prominence.

It cannot be said, however, that subsequent research has corroborated the conclusion that cytoplasm has, in general, a vacuolar structure. There is increasing evidence of specific architectural organisation in different kinds of cells, and of the significance of infinitely small bodies—the plastosomes—which are included in the general cytoplasmic matrix, and appear to be the vehicles of particular properties or formative potencies.

What is certain is that the cell-substance is not homogeneous like white-of-egg, but very heterogeneous and intricate.

CHAPTER IV

THE REPRODUCTION AND LIFE HISTORY OF ANIMALS

I. REPRODUCTION

IN the higher animals the beginnings of individual life are hidden, within the womb in Mammals, within the egg-shell in Birds. It is natural, therefore, that early preoccupation with those higher forms should have hindered the recognition of what seems to us so evident, that almost every animal arises from an egg-cell or ovum which has been fertilised by a male cell or spermatozoon. The exceptions to this fact are those organisms which multiply by buds or detached overgrowths, and those which arise from an egg-cell which requires no fertilisation. Thus *Hydra* may form a separable bud, much as a rose-bush sends out a sucker; thus drone-bees "have a mother, but no father," for they arise from parthenogenetic eggs which are not fertilised.

Sexual reproduction.—There is apt to be a lack of clearness in regard to sexual reproduction, because the process which we describe by that phrase is a complex result of evolution. It involves two distinct facts—(a) the liberation of special germ cells from which new individuals arise; (b) the union or amphimixis of two different kinds of germ cells, ova and spermatozoa, which come to nothing unless they unite. Furthermore, these dimorphic reproductive cells are produced by two different kinds of individuals (females and males), or from different organs of one individual, or at different times within the same organ (hermaphroditism).

It is conceivable that organisms might have gone on

multiplying asexually, by detaching overgrown portions of themselves which had sufficient vitality to develop into complete forms. But a more economical method is the liberation of special germ cells, in which the qualities of the organism are inherent. This is the primary characteristic of sexual, as opposed to asexual, multiplication.

It is also conceivable that organisms might have remained approximately like one another in constitution, and at all times very nearly the same, and that they might have liberated similar germ cells capable of immediate development. Such a race would have illustrated the one characteristic of sexual reproduction, the liberation of special germ cells; but it would have been without that other characteristic of sexual reproduction—the amphimixis or fertilisation of dimorphic germ cells, usually produced by different organs in one individual or by distinct male and female individuals.

Liberation of special germ cells.—One must think of this as an economical improvement on the method of starting a new life by asexual overgrowth or by the liberation of buds. Asexual reproduction, as Spencer and Haeckel point out, is a mode of growth in which the bud, or whatever it is, becomes distinct or discontinuous from the parent. The buds of a sponge, of a coral, of a sea-mat, or of many Tunicates, remain attached to the parent. If there be a keen struggle for subsistence, this may be disadvantageous; but in some cases, doubtless, the colonial life which results is a source of strength. In the case of *Hydra*, however, the buds are set adrift; the same is true of not a few worms. This liberation of buds takes us nearer the sexual process of liberating special germ cells. But unless the organism is in very favourable nutritive conditions, in which overgrowth is natural, the liberation of buds is an expensive way of continuing the life of a species. Not only so, but we can hardly think of budding even as a possibility in very complex organisms, like snails or birds, in which there is much division of labour. Moreover, the peculiarity of true germ cells is that they do not share in building up the “body,” and that they retain an organisation continuous in quality with the original germ cell from which the parent arose; they are thus not very liable to be tainted by the mishaps

which may befall the "body" which bears them. And, finally, in the mixture of two units of living matter which have had different histories, an opportunity for new permutations and combinations, in other words, for *variation*, is supplied. Thus it is not surprising to find that the asexual method of liberating buds has been replaced in most animals by the more economical and advantageous process of sexual reproduction.

SUMMARY OF MODES OF REPRODUCTION

A. *In Single-celled Animals* (Protozoa)

- (1) The almost mechanical rupture of an amœboid cell, which has become too large for physiological equilibrium.
- (2) The discharge of numerous superficial buds at once (*e.g. Arcella* and *Pelomyxa*).
- (3) The formation of one bud at a time (very common).
- (4) The ordinary division into two daughter cells at the limit of growth.
- (5) Repeated divisions within limited time and within limited space (a cyst). This results in what is called spore-formation (*e.g.* in Sporozoa).

B. *In Many-celled Animals* (Metazoa)

(Asexual)

- (a) The separation of a clump of body cells, *e.g.* from the surface of some Sponges. (A crude form of budding.)
- (b) The formation of definite buds which may or may not be set free.
- (c) Various forms of fission and fragmentation.

(Sexual)

The liberation of special reproductive or germ cells, which have not taken part in the formation of the body, and which retain the essential qualities of the original germ cell from which the parent arose. These special germ cells—the ova and spermatozoa—are normally united in fertilisation, but some animals have (parthenogenetic) ova which develop without being fertilised.

Evolution of sex.—A further problem is to account for the two facts—(a) that most animals are either males or females, the former liberating actively motile male elements or spermatozoa, the latter forming and usually liberating more passive egg cells or ova; and (b) that these two

different kinds of reproductive cells usually come to nothing unless they combine.

The problem is partly solved by a clear statement of the facts. Let us begin with those interesting organisms which are on the border line between Protozoa and Metazoa, the colonial Infusorians, of which *Volvox* is a type. The adults are balls of cells, and the component units are connected by protoplasmic bridges. From such a ball of cells reproductive units are sometimes set adrift, and these divide to form other individuals without more ado. In other conditions, however, when nutrition is checked, a less direct mode of reproduction occurs. Some of the cells become large, well-fed elements, or ova; others, less successful, divide into many minute units or spermatozoa. The large cells are fertilised by the small. Here we see the formation of dimorphic reproductive cells in different parts of the same organism. But we may also find *Volvox* balls in which only ova are being made, and others with only spermatozoa. The former seem to be more vegetative and nutritive than the latter; we call them female and male organisms respectively; we are at the foundation of the differences between the two sexes.

All through the animal series, from active Infusorians and passive Gregarines to feverish Birds and more sluggish Reptiles, we read antitheses between activity and passivity, between lavish expenditure of energy and a habit of storing. The ratio between disruptive (*katabolic*) processes and constructive (*anabolic*) processes in the protoplasmic metabolism varies from type to type. It may be that the contrast between the sexes is another expression of this fundamental alternative of variation.

Stages in the history of fertilisation.—While it is not difficult to see the advantage of fertilisation as a process which helps to sustain the standard or average of a species and as a source of new variations, we can at present do little more than indicate various forms in which the process occurs.

- (a) *Formation of Plasmodia*, the flowing together of numerous feeble cells, as seen in the life-history of those very simple Protozoa called Proteomyxa, e.g. *Protomyxa*, and Mycetozoa, e.g. flowers of tan (*Æthaliium septicum*).
- (b) *Multiple conjugation*, in which more than two cells unite and fuse together temporarily, as in some Sporozoa and in the sun-animalcule (*Actinosphaerium*).

- (c) *Ordinary conjugation*, in which two similar cells unite, with fusion of their nuclei, observed in Sporozoa, Heliozoa, Flagellates, and Rhizopods. In ciliated Infusorians, the conjugation may be merely a temporary union, during which nuclear elements are interchanged.
- (d) *Dimorphic conjugation*, in which two cells different from one another fuse into one, a process well illustrated in *Vorticella* and related Infusorians, where a small, active, free-swimming (we may say, male) cell unites with a fixed individual of normal size, which may fairly be called female (see Fig. 42 and Fig. 47).
- (e) *Fertilisation*, in which a spermatozoon liberated from a Metazoon unites intimately with an ovum, usually liberated from another individual of the same species.

Divergent modes of sexual reproduction.—(a) *Hermaphroditism* is the combination of male and female sexual functions in varying degrees within one organism. It may be demonstrable in early life only, and disappear as maleness or femaleness predominates in the adult. It may occur as a casualty or as a reversion; or it may be normal in the adult, e.g. in some Sponges and Cœlentera, in many "worms," such as earthworm and leech, in barnacles and acorn-shells, in one species of oyster, in the snail, and in many other Bivalves and Gastropods, in Tunicates and in the hag-fish. In most cases, though these animals are bisexual, they produce ova at one period and spermatozoa at another (dichogamy). It rarely occurs (e.g. in some parasitic worms) that the ova of a hermaphrodite are fertilised by the sperms of the same animal (*autogamy*). Certain facts, such as the occurrence of hermaphrodite organs as a transitory stage in the development of the embryos of many unisexual animals (e.g. frog and bird), suggest that hermaphroditism is a primitive condition, and that the unisexual condition of permanent maleness or femaleness is a secondary differentiation. Other facts, such as the hermaphroditism of many parasites, where cross-fertilisation would be difficult, suggest that the bisexual condition may have arisen as a secondary adaptation. It seems likely that there is both primitive and secondary hermaphroditism.

(b) *Parthenogenesis*, as we know it, is a degenerate form of sexual reproduction, in which ova produced by female organism develop without being fertilised by male elements. It is well illustrated by Rotifers, in which fertilisation is the

exception (in some genera males have never been found), by many small Crustaceans whose males are absent for a season; by Aphides, from among which males may be absent for the summer (or in artificial conditions for several years) without affecting the rapid succession of female generations; by the production of drones in the bee-hive from eggs which are never fertilised.

(c) *Alternation of generations.* A fixed asexual hydroid or zoophyte often buds off and liberates sexual medusoids or swimming-bells, whose fertilised ova develop into embryos which become fixed and grow into hydroids (Fig. 71, p. 150). This is the simplest illustration of alternation of generations, which may be defined as *the alternate occurrence in one life-cycle of two (or more) different forms differently produced* (Fig. 26).

The liver-fluke (*Distomum hepaticum*) of the sheep produces eggs which, when fertilised, grow into embryos. Within the latter, certain cells (which might be called spores) grow into numerous other larvæ of a different form. Within these the same process is repeated,

and finally the larvæ thus produced grow (in certain conditions) into sexual flukes (Fig. 98, p. 189). In this case, reproduction by special cells, like undifferentiated precocious ova, alternates with reproduction by ordinary fertilised egg-cells. So, too, the vegetative sexless "fern-plant" gives rise to special spore cells, which develop into an inconspicuous bisexual "prothallus," from the fertilised egg-cell of which a "fern-plant" springs.

Various kinds of alternation are seen in the life-cycle of the fresh-water sponge, in the stages of the jelly-fish *Aurelia*,

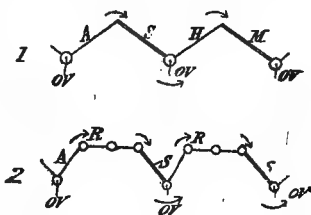

FIG. 26.—Diagrammatic expression of alternation of generations.

1. Hydromedusæ.

ov. Fertilised ovum gives rise to an asexual form *A*, which, by budding, produces sexual form or forms *S*; in the case of Hydromedusæ, *A* is represented by hydroid (*H*), and *S* by medusoid (*M*).

2. Liver Fluke.

ov. Fertilised ovum gives rise to asexual stages (*A*), which from special spore-like cells (*R*) produce eventually the sexual fluke (*S*).

in the history of some "worms" and Tunicates. They illustrate a rhythm between asexual and sexual multiplication, between parthenogenetic and normal sexual reproduction, between vegetative and animal life, between a relatively "anabolic" and a relatively "katabolic" preponderance.

II. EMBRYOLOGY

Egg cell or ovum.—Apart from cases of asexual reproduction and parthenogenesis, every multicellular animal begins life as an egg cell with which a male cell or spermatozoon has entered into intimate union.

The most important characteristic of the reproductive cells, whether male or female, is that they retain the essential qualities of the fertilised ovum from which the parent animal was developed.

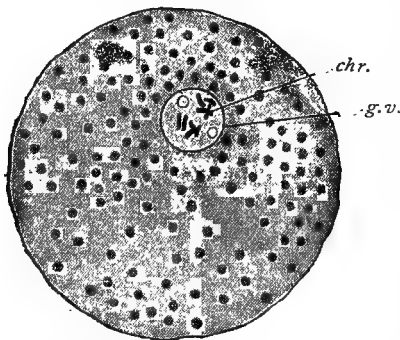

FIG. 27.—Diagram of ovum, showing diffuse yolk granules.

g.v., Germinal vesicle or nucleus; *chr.*, chromatin elements.

and a distinct sheath representing a cell wall (Fig. 27).

In Sponges the ova are well-nourished cells in the middle stratum of the body; in Coelentera they seem to arise in connection with either outer or inner layer (ectoderm or endoderm); in all other animals they arise in connection with the middle layer or mesoderm, usually on an area of the epithelium lining the body cavity. In lower animals they often arise somewhat diffusely; in higher animals their

formation is restricted to distinct regions, and usually to definite organs—the ovaries.

The young ovum is often amœboid, and that of *Hydra* retains this character for some time (Fig. 70, p. 148). The ovum grows at the expense of adjacent cells, or by absorbing material which is contributed by special yolk glands or supplied by the vascular fluid of the body.

The yolk or nutritive capital may be small in amount, and distributed uniformly in the cell, as in the ova of Mammals, earthworm, starfish, and sponge; or it may be more abundant, sinking towards one pole as in the egg of the frog, or accumulated in the centre as in the eggs of Insects and Crustaceans; or it may be very copious, dwarfing the formative protoplasm, as in the eggs of Birds, Reptiles, and most Fishes (Fig. 31).

Round the egg there are often sheaths or envelopes of various kinds—(a) made by the ovum itself, and then very delicate (*e.g.* the vitelline membrane); (b) formed by adjacent cells (*e.g.* the follicular envelope); or (c) formed by special glands or glandular cells in the walls of the oviducts (*e.g.* the “shells” of many eggs). The envelope is often firm, as in the chitinous coat around the eggs of many Insects, and in these cases we find a minute aperture (micropyle) or several of them through which the spermatozoon can enter. The hard calcareous shells round the eggs of Birds and Tortoises, or the mermaid’s purse enclosing the egg of a skate, are of course formed after fertilisation. Egg-shells must be distinguished from egg capsules or cocoons, *e.g.* of the earthworm, in which several eggs are wrapped up together.

Male cell or spermatozoon.—This is a much smaller and usually a much more active cell than the ovum. In its minute size, locomotor energy, and persistent vitality, it resembles a flagellate Monad, while the ovum is comparable to an Amœba or to one of the more encysted Protozoa.

A spermatozoon has usually three distinct parts: the essential “head,” consisting mainly of nucleus, and the mobile “tail,” which is often fibrillated, and a small middle portion between head and tail, which is said to be the bearer of the centrosome. The spermatozoa of Thread-

worms and most Crustaceans are sluggish, and inclined to be amœboid (Fig. 28 (6, 7)).

Both ova and spermatozoa are true cells, and they are complementary, but the spermatozoon has a longer history behind it (Fig. 29). The homologue of the ovum is the mother sperm cell or spermatogonium. This segments as the ovum does, but the cells into which it divides have little coherence. They go apart, and become spermatozoa. There is often a resemblance between the different ways in which a mother sperm cell divides and the various kinds of segmentation in a fertilised ovum. In most cases the

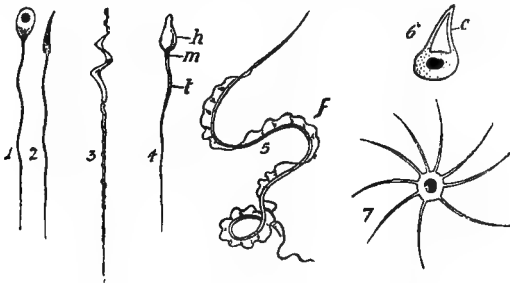

FIG. 28.—Forms of spermatozoa (not drawn to scale).

- 1 and 2. Immature and mature spermatozoa of snail; 3. of bird; 4. of man (*h.*, head; *m.*, middle portion; *t.*, tail); 5. of salamander, with vibratile fringe (*f.*); 6. of *Ascaris*, slightly amœboid with cap (*c.*); 7. of crayfish.

spermatogonium divides into spermatocytes, which usually divide again into spermatids or young spermatozoa.

Maturation of ovum.—When the egg-cell attains its definite size or limit of growth, it bursts from the ovary or from its place of formation, and in favourable conditions meets either within or outside the body with a spermatozoon from another animal. Before the union between ovum and spermatozoon is effected, generally indeed before it has begun, the nucleus or germinal vesicle of the ovum moves to the periphery and divides twice. This division results in the formation and extrusion of two minute cells or polar bodies, which come to nothing, though they may linger for

a time in the precincts of the ovum, and may even divide. The second division follows the first without the intervention of the "resting stage" which usually succeeds a nuclear division. In most cases the division which forms the first polar body is a reducing or *meiotic* division, the number of chromosomes being reduced to half the number characteristic of the cells of the body. The extrusion of polar globules and the associated reduction is almost universal in the history of ova, but in most parthenogenetic ova only one polar body is formed, and there is no reduction in the number of chromosomes. In some other cases

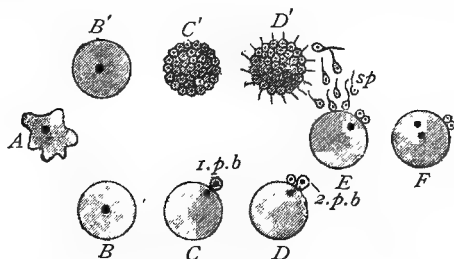

FIG. 29.—Diagram of maturation and fertilisation.
(From *Evolution of Sex.*)

- A. Primitive sex cell, supposed to be amoeboid.
 B. Ovum; C. formation of first polar body (1. p. b.); D. formation of second polar body (2. p. b.).
 B'. Mother sperm cell; C'. the same divided (sperm-morula).
 D'. Ball of immature spermatozoa: *sp.*, liberated spermatozoa.
 E. Process of fertilisation; F. approach of male and female nuclei within the ovum.

the parthenogenetic ovum passes through the meiotic phase and forms two polar bodies. The second of these, however, is not liberated, but remains within the ovum and re-uniting with the reduced nucleus restores the normal number of chromosomes.

Reducing or Meiotic Division.—In each kind of animal there is a definite number of chromosomes, say n , in each of the body-cells. In the ripe germ-cells, however, there is half the normal number, $\frac{n}{2}$, so that when spermatozoon and ovum unite in fertilisation the normal number is restored.

In the history of the germ-cells, therefore, in one way or another, at one stage or another, the number of chromo-

somes undergoes reduction to half the normal. In many cases this reduction comes about through a "heterotypic" or meiotic division. We give a condensed account of what happens in a large number of cases.

The germ-cells grow relatively large; the nuclear material takes the form of a definite number of chromatin loops; at a certain stage it is seen that the number is half what it was in more immature stages of the germ-cells, and half what it is in the somatic cells of the species under consideration. If the normal number be n , it is reduced to $\frac{n}{2}$. There has been *union* of chromosomes.

The chromatin-loops contract away from the nuclear membrane (synapsis); the chromatin granules divide so that each loop appears doubly-beaded; the ends of each loop are separated, and there are now n bodies with chromatin, each equivalent to a chromosome.

The ends of the loops move apart, and, with or without a second synapsis, they change in shape, unite end to end, and form $\frac{n}{2}$ twin-bodies or gemini, sometimes rod-like, sometimes like two brackets, sometimes like four dots.

The nuclear membrane disappears, the $\frac{n}{2}$ meiotic gemini are set free, they become arranged on the division-spindle at right angles to the equatorial plane (not flat as in ordinary karyokinesis), with their axes parallel to the axis of the spindle. They halve as if transversely, separating into two parts which go to the two poles of the spindle. Thus each daughter-cell has $\frac{n}{2}$ chromosomes.

In the case of the ovum the meiotic division usually occurs in the formation of the first polar body, so that it and the reduced nucleus of the ovum have each $\frac{n}{2}$ chromosomes. There is no further reduction in the formation of the second polar body, which involves an ordinary equational-division. The first polar body often divides into two. Thus the result is one viable cell (the mature ovum) and three non-viable cells (the polar bodies), each with $\frac{n}{2}$ chromosomes.

In the spermatogenesis or production of spermatozoa the meiotic division is usually the second-last. A "mother-sperm cell" or spermatogonium divides into spermatocytes with n chromosomes, each of these divides into 2 spermatocytes with $\frac{n}{2}$ chromosomes, and these again divide into spermatocytes which differentiate into spermatozoa. The result is that from each of the penultimate generation of spermatocytes there arise four spermatozoa, each with $\frac{n}{2}$ chromosomes. Thus there is a close parallelism in the maturation process in the two sexes. That the fertilisation of the ovum restores the number to the normal n is obvious.

Part of the significance of the long circuitous process of meiotic division is that it affords opportunity for fresh permutations and combinations of hereditary qualities, for it seems probable that the chromosomes are the bearers of these.

It is important to understand that in ordinary mitosis or cell-division, each daughter-cell gets an absolutely similar half of each chromosome of the mother-cell, whereas in meiotic division the daughter-cells get dissimilar halves.

A very important fact, discovered by Farmer, Moore, and Walker, is that the meiotic phase occurs among the cells of malignant growths (cancer). "Through the action of one or several different causes at present unknown, certain cells of the soma, passing out of co-ordination, go through the meiotic phase and produce a number of generations of cells that live upon the parent organism in a parasitic manner."

Fertilisation.—In the seventeenth and eighteenth centuries, some naturalists, nicknamed "ovists," believed that the ovum was all-important, only needing the sperm's awakening touch to begin unfolding the miniature model which it contained. Others, nicknamed "animalculists," were equally confident that the sperm was essential, though it required to be fed by the ovum. Even after it was recognised that both kinds of reproductive elements were essential, many thought that their actual contact was unnecessary, that fertilisation might be effected by an *aura seminalis*. Though spermatozoa were distinctly seen by Hamm and Leeuwenhoek in 1679, their actual union with ova was not observed till 1843, when Martin Barry detected it in the rabbit.

Of the many facts which we now know about fertilisation, the following are the most important:—

(1) Apart from the occurrence of parthenogenesis in a few of the lower animals, an ovum begins to divide only after a spermatozoon has united with it. After one spermatozoon has entered the ovum, the latter ceases to be receptive, and other spermatozoa are excluded. If, as rarely happens, several spermatozoa effect an entrance into the ovum, the result is usually some abnormality. It is said, however, that the entrance of numerous spermatozoa (polyspermy) is frequent in insects and Elasmobranch fishes.

(2) The union of spermatozoon and ovum is very intimate; the nucleus of the spermatozoon and the reduced nucleus of the ovum approach one another, combining to form a unified nucleus.

(3) The ovum centrosome disappears before fertilisation, and it is a centrosome introduced by the spermatozoon that

divides into the two which play an important rôle in the cleavage or segmentation of the fertilised ovum.

(4) When the combined or segmentation nucleus begins the process of development by dividing, each of the two daughter nuclei which result consists partly of material derived from the sperm nucleus, partly of material derived from the ovum nucleus. In other words, the union is

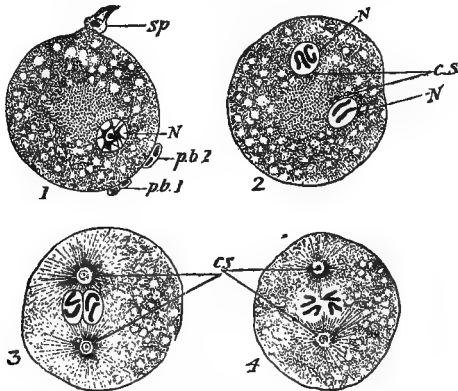

FIG. 30.—Fertilisation in *Ascaris megalcephala*.
—After Boveri.

1. Spermatozoon (*sp.*) entering ovum, which contains reduced nucleus (*N*), having given off two polar bodies (*pb. 1* and *2*).
2. Sperm nucleus (the upper), and ovum nucleus (*N*), each with two chromatin elements or idants, and with centrosomes (*c.s.*).
3. Centrosomes (*c.s.*) with "archoplasmic" threads radiating outwards in part to the chromosomes of the two approximated nuclei.
4. Segmentation spindle before first cleavage.

orderly as well as intimate, and the subsequent division is so exact, that the qualities marvellously inherent in the sperm nucleus (those of the male parent), and in the ovum nucleus (those of the mother animal), are diffused throughout the body of the offspring, and persist in its reproductive cells.

(5) Some eggs, *e.g.* of sea-urchins, can be artificially induced to develop without fertilisation (by being immersed for a couple of hours in a mixture of sea water and solution

of Magnesium chloride, and by other means). It seems, therefore, justifiable and useful to distinguish in ordinary fertilisation, (a) the mingling of the hereditary qualities of the two parents, and (b) an exciting or liberating stimulus which induces the ovum to divide. It should be noted that the chromosomes of the spermatozoon do not fuse with the chromosomes of the ovum when fertilisation occurs. There is some evidence for the view that they remain distinct from one another until maturation again takes place, and one theory of the reduction in the number of chromosomes which takes place at maturation, is that it involves the fusion in pairs of the paternal chromosomes with the maternal.

In some insects there is an accessory chromosome present in one half of the spermatozoa. It has been interpreted as an element whose presence or absence determines whether the offspring is to be male or female.

Segmentation.—The different modes of division exhibited by fertilised egg-cells depend in great measure on the quantity and disposition of the passive and nutritive yolk material, which is often called deutoplasm, in contrast to the active and formative protoplasm. The pole of the ovum at which the formative protoplasm lies, and at which the spermatozoon enters, is often called the animal pole; the other, towards which the heavier yolk tends to sink, is called the vegetative pole. In the floating ova of some fish, however, the yolk is uppermost, and the embryonic area lowest.

In contrasting the chief modes of segmentation, it should be recognised that they are all connected by gradations.

A. COMPLETE DIVISION—Holoblastic Segmentation

- (1) Eggs with little and diffuse yolk material divide completely into approximately equal cells,
 [01, Ova which are alecithal (*i.e.* without yolk) undergo approximately equal holoblastic segmentation].

This is illustrated in most Sponges, most Cœlentera (Figs. 31 (1) and 32), some "Worms," most Echinoderms, some Molluscs, all Tunicates, *Amphioxus*, and most Mammals.

- (2) Eggs with considerable yolk material accumulated towards one pole, divide completely, but into unequal cells,

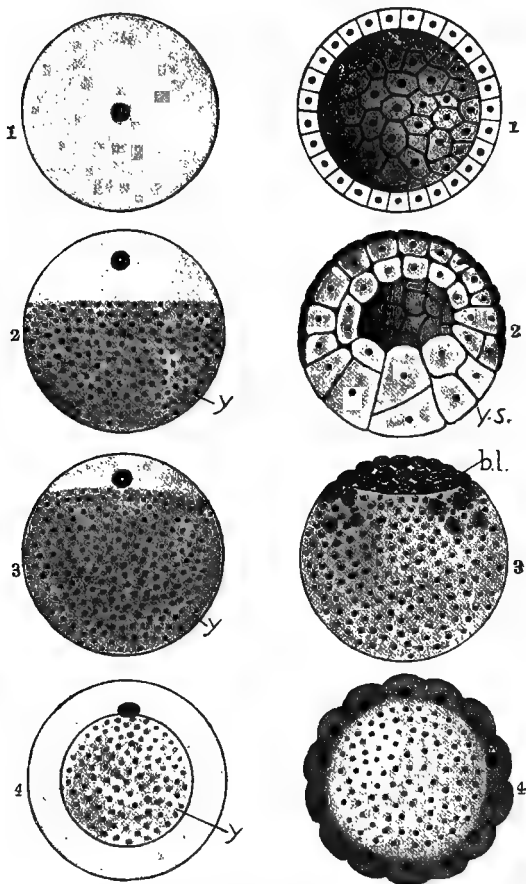

FIG. 31.—Modes of Segmentation.

1. Ovum, with little yolk, segments totally and equally into a blastosphere, *e.g.* *Hydra*, sponge, sea-urchin.
2. Ovum, with a considerable amount of yolk (*y.*) at lower pole, segments totally but unequally, *e.g.* frog; (*y.s.*) larger yolk-laden cells.
3. Ovum, with much yolk (*y.*) at lower pole, segments partially and discoidally, forming blastoderm (*bl.*), *e.g.* bird, most fishes.
4. Ovum, with central yolk, (*y.*) segments partially and peripherally, *e.g.* most Arthropods

[or, Ova with a considerable amount of deutoplasm lying towards one pole (telolecithal), undergo unequal holoblastic segmentation].

This is illustrated in some Sponges, some Coelentera (*e.g.* Ctenophora), some "Worms," many Molluscs, the lamprey, Ganoid Fishes, Dipnoi, Amphibians (Fig. 31 (2)).

B. PARTIAL DIVISION—Meroblastic Segmentation

- (3) Eggs with a large quantity of yolk on which the formative protoplasm lies as a small disc at one pole, divide partially, and in discoidal fashion,

[or, Ova which are telolecithal, and have a large quantity of deutoplasm, undergo meroblastic and discoidal segmentation].

This is illustrated in all Cuttle-fishes, all Elasmobranch and Teleostean Fishes, all Reptiles and Birds (Fig. 31 (3)), and also in the Monotremes or lowest Mammals.

- (4) Eggs with a considerable quantity of yolk accumulated in a central core and surrounded by the formative protoplasm, divide partially, and superficially or peripherally,

[or, Ova which are centrolecithal undergo meroblastic and superficial segmentation].

This is illustrated by most Arthropods (Fig. 31 (4)), and by them alone.

Blastosphere and morula.—The result of the division is usually a ball of cells. But when the yolk is very abundant (3), a disc of cells—a discoidal blastoderm—is formed at one pole of the mass of nutritive material, which it gradually surrounds.

As the cells divide and redivide, they often leave a large central cavity—the segmentation cavity—and a hollow ball of cells—a blastosphere or blastula—results.

But if the so-called "segmentation cavity" be very small or absent, a solid ball of cells or morula, like the fruit of bramble or mulberry, results.

Gastrula.—The next great step in development is the establishment of the two primary germinal layers, the outer ectoderm and the inner endoderm, or the epiblast and the hypoblast.

One hemisphere of the hollow ball of cells may be apparently dimpled into the other, as we might dimple an india-rubber ball which had a hole in it. Thus out of a hollow ball of cells, a two-layered sac is formed—a gastrula formed by invagination or *embolé* (Fig. 32). The mouth of the gastrula is called the blastopore, its cavity the archenteron.

But where the ball of cells is practically a solid morula, the apparent in-dimpling cannot occur in the fashion described above. Yet in these cases the two-layered gastrula

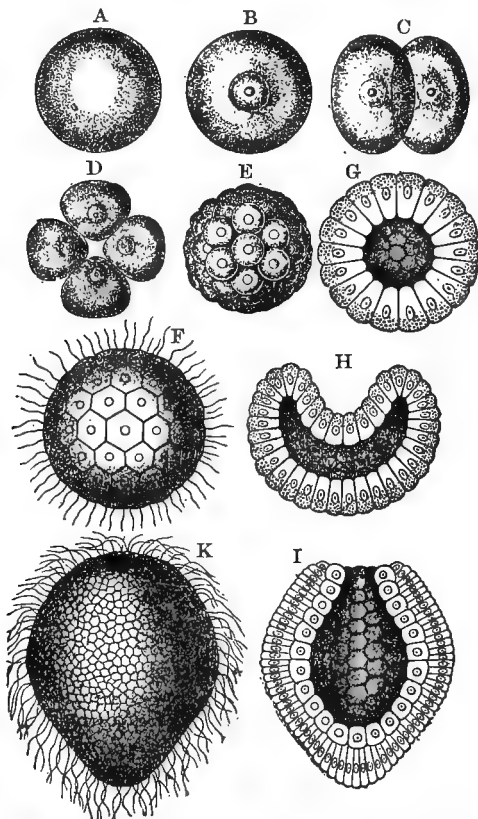

FIG. 32.—Life history of a coral, *Monoxenia darwini*,
—From Haeckel.

A, B, Ovum. C, Division into two. D, four-cell stage. E, Blastula. F, Free-swimming blastula with cilia. G, Section of blastula. H, Beginning of invagination. I, Section of completed gastrula, showing ectoderm, endoderm, and archenteron. K, Free-swimming ciliated gastrula.

is still formed. The smaller, less yolk-laden cells, towards the animal pole, gradually grow round the larger yolk-containing cells, and a gastrula is formed by overgrowth or *epibolè*.

In various ways the ectoderm and the endoderm are established, either by some form of gastrulation, or by some other process, such as that called *delamination* (see p. 163).

Mesoderm.—We are not yet able to make general statements of much value in regard to the origin of the middle germinal layer—the mesoderm or mesoblast. In Sponges and Cœlentera it is not a distinct layer except in Ctenophora, being usually represented by a gelatinous material (*mesoglaea*) which appears between ectoderm and endoderm, and into which cells wander from these two layers. In the other Metazoa, the middle layer may arise from a few *primary mesoblasts* or cells which appear at an early stage between the ectoderm and endoderm (*e.g.* in the earth-worm's development); or from numerous "*mesenchyme*" immigrant cells, which are separated from the walls of the blastula or gastrula (*e.g.* in the development of Echinoderms); or as *cœlom pouches*—outgrowths from the endodermic lining of the gastrula cavity (*e.g.* in *Sagitta*, *Balanoglossus*, *Amphioxus*); or by combinations of these and other modes of origin. The mesoderm lies or comes to lie between ectoderm and endoderm, and it lines the body cavity, one layer of mesoderm (parietal or somatic) clinging to the ectodermic external wall, the other (visceral or splanchnic) cleaving to the endodermic gut and its outgrowths.

Origin of organs.—From the outer ectoderm and inner endoderm, those organs arise which are consonant with the position of these two layers, thus nervous system from the ectoderm, digestive gut from the endoderm. The middle layer, which begins to be developed in "Worms," assumes some of the functions, *e.g.* contractility, which in Sponges and Cœlentera are possessed by ectoderm and endoderm, the only two layers distinctly represented in these classes.

In a backboned animal the embryological origin of the organs is as follows:—

- (a) *From the ectoderm or epiblast* arise the epidermis and epidermic outgrowths, the nervous system, the

most essential parts of the sense organs, infoldings at either end of the gut (fore-gut or stomodæum and hind-gut or proctodæum).

- (b) *From the endoderm or hypoblast* arise the mid-gut (mesenteron) and the foundations of its out-growths (e.g. the lungs, liver, allantois, etc., of higher Vertebrates), also the axial rod or notochord.
- (c) *From the mesoderm or mesoblast* arise all other structures, e.g. dermis, muscles, connective tissue, bony skeleton, the lining of the body cavity, and the vascular system. This layer aids in the formation of organs originated by the other two. With it the reproductive organs are associated. Connective tissues, vascular system, and unstriped muscles are formed by mesenchyme cells which are budded off from the true mesoderm.

Physiological embryology.—Of the physiological conditions of development we know relatively little. To investigate them is one of the tasks of the future. Why does the fertilised egg-cell divide, how does the yolk affect segmentation, what are the conditions of the infolding

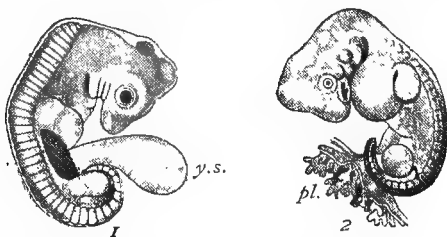

FIG. 33.—Embryos—(1) of bird ; (2) of man.—After His.
The latter about twenty-seven days old.

y.s., Yolk-sac ; *pl.*, placenta.

which forms the endoderm, and of the outfolding which makes the coelom pouches ; in short, what are the immediate conditions of each step in the familiar process by which, out of apparent simplicity, obvious complexity arises?

Generalisations.—(1) *The ovum theory or cell theory.*—All many-celled animals, produced by sexual reproduction,

begin at the beginning again. "The Metazoa begin where the Protozoa leave off"—as single cells. Fertilisation does not make the egg cell double; there is only a more complex and more vital nucleus than before. All development takes place by the division of this fertilised egg-cell and its descendant cells.

(2) *The gastræa theory.*—As a two-layered gastrula stage occurs, though sometimes disguised by the presence of much yolk, in the development of the majority of animals, Haeckel concluded that it represents the individual's recapitulation of an ancestral stage. He suggested that the simplest stable, many-celled animal was like a gastrula, and this hypothetical ancestor of all Metazoa he called a *gastræa*. The gastrula is, on this view, the individual animal's recapitulation of the ancestral gastræa. Rival suggestions have been made: perhaps the original Metazoa were balls of cells like *Volvox* (Fig. 43), with a central cavity in which reproductive cells lay; perhaps they were like the *planula* larvæ of some Coelentera—two-layered, externally ciliated, oval forms without a mouth.

(3) *The idea of recapitulation.*—It is a matter of experience that we recapitulate in some measure the history of our ancestors. Embryologists have made this fact most vivid, by showing that the individual animal develops along a path the stations of which correspond to some extent with the steps of ancestral history.

(1) The simplest animals are single cells (Protozoa).	(1) The first stage of development is a single cell (fertilised ovum).
(2) The next simplest are balls of cells (<i>e.g.</i> <i>Volvox</i>).	(2) The next is a ball of cells (blastula or morula).
(3) The next simplest are two-layered sacs of cells (<i>e.g.</i> <i>Hydra</i>).	(3) The next is a two-layered sac of cells (gastrula).

Von Baer, one of the pioneer embryologists, acknowledged that, with several very young embryos of higher Vertebrates before him, he could not tell one from the other. Progress in development, he said, was from a general to a special type. In its earliest stage every organism has a great number of characters in common with other organisms in their earliest stages; at each successive stage the series of embryos which it resembles

is narrowed. The rabbit begins like a Protozoon as a single cell; after a while it may be compared to the young stage of a very simple vertebrate; afterwards, to the young stage of a reptile; afterwards, to the young stage of almost any mammal; afterwards, to the young stage of almost any rodent; eventually it becomes unmistakably a young rabbit.

Herbert Spencer expressed the same idea, by saying that the progress of development is from homogeneous to heterogeneous, through steps in which the individual history is parallel to that of the race. But Haeckel has illustrated the idea more vividly, and summed it up more tersely, than any other naturalist. His "fundamental biogenetic law" reads: "Ontogeny, or the development of the individual, is a shortened recapitulation of phylogeny, or the evolution of the race."

It is hardly necessary to say that the young mammal is never like a worm, or a fish, or a reptile. It is at most like the *embryonic* stages of these, and it may also be noticed that, as our knowledge is becoming more intimate, the individual peculiarities of different embryos are becoming more evident. But this need not lead us to deny the *general* resemblance.

Moreover, the individual life history is much shortened compared with that of the race. Not merely does the one take place in days, while the other has progressed through ages, but stages are often skipped, and short cuts are discovered. And again, many young animals, especially those "larvæ" which are very unlike their parents, often exhibit characters which are secondary adaptations to modes of life of which their ancestors had probably no experience. In short, the individual's recapitulation of racial history is general, but not precise. It is seen rather in the stages in the development of organs (organogenesis) than in the development of the organism as a whole.

(4) *Organic continuity between generations.*—*Heredity.*—Everyone knows that like tends to beget like, that offspring resemble their parents and their ancestors. Not only are the general characteristics reproduced, but minute features, idiosyncrasies, and pathological conditions, inborn in the parents, may recur in the offspring.

At an early stage in the development of the embryo the future reproductive cells of the organism are often distinguishable from those which are forming the body. These, the somatic cells, develop in manifold variety, and, as division of labour is established, they lose their likeness to the fertilised ovum of which they are the descendants. The future reproductive cells, on the other hand, are not implicated in the formation of the "body," but, remaining virtually unchanged, continue the protoplasmic tradition unaltered, and are thus able to start an offspring which will resemble the parent, because it is made of the same protoplasmic material, and develops under similar conditions.

An *early* isolation of reproductive cells, directly continuous and therefore presumably identical with the original ovum, has been observed in the development of some "worm types"—(*Sagitta*, Thread-worms, Leeches, Polyzoa), and of some Arthropods (*e.g.* *Moina* among Crustaceans, *Chironomus* among Insects, Phalangidæ among Spiders), in *Micrometrus aggregatus* among Teleostean fishes, and with less distinctness in some other animals. A cell which will give rise to the germ-cells can be recognised in the gastrula stage of *Cyclops*, and in the very first segmentation stages of the thread-worm *Ascaris*.

In many cases, however, the reproductive cells are not recognisable until a relatively late stage in development, after differentiation has made considerable progress. Weismann gets over this difficulty by supposing that the continuity is sustained by a specific nuclear substance—the germ-plasm—which remains unaltered in spite of the differentiation in the body. It is perhaps enough to say that, as all the cells are descendants of the fertilised ovum, the reproductive cells are those which retain intact the qualities of that fertilised ovum, and that this is the reason why they are able to develop into offspring like the parent.

Finally, it may be noticed in connection with heredity, that there is great doubt to what extent the "body" can definitely influence its own reproductive cells. Animals acquire individual bodily peculiarities in the course of their life, as the result of what they do or refrain from

doing, or as dints from external forces. The "body" is thus changed, but there is much doubt whether the reproductive cells within the "body" are affected *specifically* by such changes. Weismann denies the transmissibility of any characters except those inherent in the fertilised egg-cell, and therefore denies that the influences of function and environment are, or have been, of direct importance in the evolution of many-celled animals. Such influences affect the *body*, and produce what are technically called "*modifications*," but these modifications do not affect the reproductive cells—at least not in a specific representative way. Therefore modifications are not likely to be transmitted, and there seems no good evidence to show that they are. Many of the most authoritative biologists are at present of this opinion. On the other hand, many still maintain that profound changes due to function or environment may saturate through the organism, and affect the reproductive cells in such a way that the changes or modifications in question are in some measure transmitted to the next generation. The question remains under discussion, but the probabilities are strongly against the transmissibility of acquired characters.

It is important to try to distinguish different modes of hereditary resemblance. The characters of the two parents may be *blended* in the offspring, or those of one parent may find predominant expression (*exclusive* inheritance), or the characters of one parent may be expressed in one part of the offspring and those of the other parent in another (*particulate* inheritance).

Another important inquiry is into the share that the various ancestors have *on an average* in forming any individual inheritance. The inheritance of an animal reproduced in the ordinary way is always *dual*, partly maternal and partly paternal, but *through* the parents there come contributions from grandparents, etc. Galton's *Law of Ancestral Inheritance* states that "The two parents contribute between them, on the average, one half of the total heritage; the four grandparents, one quarter; the eight great-grandparents, one eighth, and so on."

Another generalisation of great interest is Mendel's Law, which seems to apply to certain cases, *e.g.* peas, stocks,

mice, and rabbits. In its simplest expression the law may be stated as follows:—If *A* be a well-established, pure-bred variety with a certain character, e.g. of stature or colour, and *B* be another well-established variety in which the corresponding character is different, and if *A* and *B* are crossed, the hybrid offspring (*H*) will usually resemble one of the parents in the particular distinguishing character. The character which finds expression is called the *dominant*; the character which remains latent in the hybrids is called the *recessive*. Now, if the hybrids are bred together, their descendants will be of two kinds, some like the dominant grandparent, some like the recessive grandparent. When those like the recessive grandparent are in-bred, they yield only recessives. When those like the dominant grandparent are in-bred, some yield pure dominants only—that is, forms which if in-bred yield only dominants; but others yield *apparent* dominants like the original hybrid—that is, with the power of throwing off when in-bred more pure dominants, more pure recessives, and more apparent dominants like the original hybrid. The results tend to be always in the proportion 1 *A* + 2 *A* (*B*) + 1 *B*, as regards the two contrasted characters of *A* and *B*.

Two diagrams (after T. H. Morgan and R. C. Punnett) may make the matter clearer.

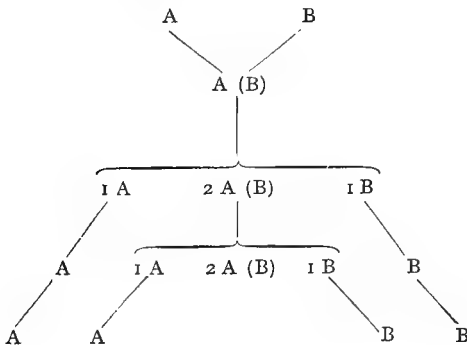

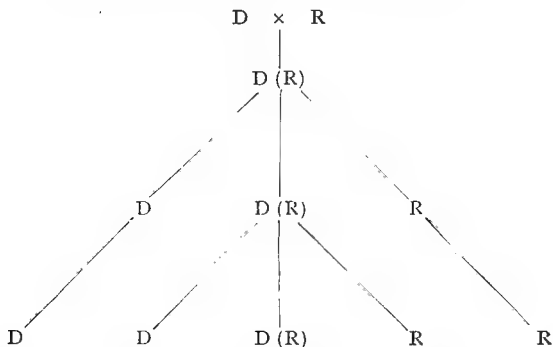

Heredity may be defined as the relation of genetic continuity between successive generations, and inheritance as all that the organism is or has to start with in virtue of this hereditary relation. Development is the expression or realisation of the heritable qualities which have their physical basis in the germ cells, and it presupposes an appropriate environment of nutrition and "liberating stimuli,"—"nurture" in the widest sense. What the organism becomes is the resultant of two components, inherited "nature" and external "nurture."

CHAPTER V

PAST HISTORY OF ANIMALS

(PALÆONTOLOGY)

IN the two preceding chapters we have noticed two of the great records of the history of animal life,—that preserved in observable structures, and the modified recapitulation discernible in individual development; in this we turn to the third—the geological record. In the early days of the Evolution theory the modern science of Embryology was still in its infancy, and could furnish few arguments, and it was the opponents of the new theory rather than its supporters who appealed to Palæontology. They asserted that the palæontological facts refused to lend the support which the theory demanded. To their attacks the evolutionists usually replied by pointing out that the geological record was very incomplete. The numerous investigations which have since been carried on on all sides now show conclusively that it was imperfection rather of knowledge than of the record which produced the negative results. We must, however, still acknowledge that, except in a few cases, there is but little certainty as to the precise pedigree of living animals, and seek for reasons to explain this.

“**Imperfection of the geological record.**”—If we remember the rule of modern Geology, that the past is to be interpreted by the aid of the present, there can be no difficulty in realising that the chances against the preservation of any given animal are very great. Many are destroyed by other living creatures, or obliterated by chemical agencies. Except in rare instances, only hard parts, such as bones,

teeth, and shells, are likely to be preserved, and this at once greatly limits the evidential value of fossils. The primitive forms of life would almost certainly be without hard parts, and have left no trace behind them. A number of extremely interesting forms, such as many worms and the Ascidians, are, for the same reason, almost unrepresented in the rocks. Finally, we cannot suppose that such an external structure as a shell can always be an exact index of the animal within.

After fossilisation has taken place, the rock with its contents may be entirely destroyed by subsequent denudation, or so altered by metamorphic changes that all trace of organic life disappears. Of those fossils which have been preserved only a small percentage are available, for vast areas of fossiliferous rocks are covered over by later deposits, or now lie below the sea or in areas which have not yet been explored.

With all these causes operating against the likelihood of preservation, and of finding those forms that may have been preserved, it is little wonder if the geological record is incomplete; but such as it is, it is in general agreement with what the other evidence, theoretical and actual, leads us to expect as to the relative age of the great types of animal life. Further, those specially favourable cases which have been completely worked out have yielded results which strongly support the general theory.

Probabilities of "fossils."—But it will be useful to note the probabilities of a good representation of extinct forms in the various classes of animals. Thus among the Protozoa the Infusoria have no very hard parts, and have therefore almost no chance of preservation, and the same may be said of forms like *Amœbæ*; while the Foraminifera and the Radiolaria, having hard structures of lime or silica, have been well preserved. The flinty Sponges are well represented by their spicules and skeletons. Of the Cœlentera, except an extinct order known as Graptolites, only the various forms of coral had any parts readily capable of preservation, and remains of these are very abundant in the rocks of many ancient seas. But, strange as it may seem, some beautiful vestiges of jelly-fish have been discovered.

Of the great series of "worms," only the tube-makers have left actual remains; the others are known only by their tracks, while of any that may have lived on the land there is no evidence.

The Echinoderms, because of their hard parts, are well represented in all their orders, except the Holothurians, where the calcareous structures characteristic of the class are at a minimum.

The Crustacea, being mostly aquatic, and in virtue of their hard shells, are fossilised in great numbers.

The Arachnida and the Insects, owing to their air-breathing habit, are chiefly represented by chance individuals that have been drowned; or enclosed within tree-stumps and amber.

The Molluscs and Brachiopods are perhaps better preserved than any other animals, since nearly all of them are possessed of a shell specially suitable for preservation.

Among the Vertebrates some of the lowest are without scales, teeth, or bony skeleton; such forms have therefore left almost no traces.

Fishes, which are usually furnished with a firm outer covering, or with a bony internal skeleton, or with both, are well represented.

The primitive Amphibians were furnished with an exoskeleton of bony plates, and are fairly numerous as fossils. The bones and teeth of the others have been fossilised, though more rarely. Of some the only record is their footprints.

The traces of Reptilia depend upon the habits of the various orders, those living in water being oftenest preserved, but the strange flying Reptiles have also left many skeletons behind them.

Of the Birds, the wingless ones are best represented, and then those that lived near seas, estuaries, or lakes.

The history of Mammals is very imperfect, for most of them were terrestrial. But the discoveries of Marsh, Cope, and others show how much may be found by careful search. The aquatic Mammals are fairly well preserved.

“Palæontological series.”—In spite of the imperfection of the “geological record,” in spite of the conditions unfavourable to the preservation of many kinds of animals, it is sometimes possible to trace a whole series of extinct forms through progressive changes. Thus a series of fossilised fresh-water snails (*Planorbis*) has been worked out; the extremes are very different, but the intermediate forms link them indissolubly by a marvellously gradual series of transitions. The same fact is well illustrated by another series of fresh-water snails (*Paludina*, Fig. 34), and not less strikingly among those extinct Cuttle-fishes which are known as Ammonites, and have perfectly preserved shells. Similarly, though less perfectly, the modern crocodiles are linked by many intermediate forms to their extinct ancestors, for it is impossible not to call them by that name. In short, as knowledge increases, the evidence from Palæontology becomes more and more complete.

In a general way it is true that the simpler animals precede the more complex in history as they do in structural rank, but the fact that all the great Invertebrate groups are

represented in the oldest distinctly stratified and fossiliferous rocks—the Cambrian system—shows that this correspondence is only roughly true. To account for this, we must remember that almost the whole mass of the oldest rocks, known as Archæan or Pre-Cambrian, has been so profoundly altered, that, as a rule, only masses of marble and carbonaceous material are left to indicate that forms of life existed when these rocks were laid down. Careful searching in Pre-Cambrian beds has revealed the presence of several Molluscs, a Eurypterid, and a fragment of Trilobite. There are also “annelid tracks” indicative of life.

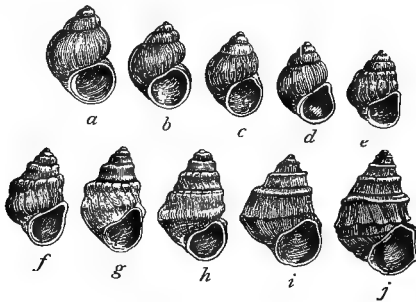

FIG. 34.—Gradual transitions between *Paludina neumayri* (a), the oldest form, and *Paludina hærnesi* (j).—From Neumayr.

Extinction of types.—Some animals, such as some of the lamp-shells or Brachiopods, have persisted from almost the oldest ages till now, and most fossilised animals have modern representatives which we believe to be their actual descendants. That a species should disappear need not surprise us, if we believe in the “transformation” of one species into another. The disappearance is more apparent than real: the species lives on in its modified descendants, “different species” though they be.

But, on the other hand, there are not a few fossil animals which have become wholly extinct, having apparently left no direct descendants. Such are the Graptolites, the ancient Trilobites, their allies the Eurypterids, two classes

of Echinoderms (Cystoids and Blastoids), many giant Reptiles, and some Mammals.

It is almost certain that there has been no sudden extinction of any animal type. There is no evidence of universal cataclysm, though local floods, earthquakes, and volcanic eruptions occurred in the past, as they do still, with disastrous results to fauna and flora. In many cases the waning away of an order, or even of a class of animals, may be associated with the appearance of some formidable new competitors; thus cuttle-fish would tend to exterminate Trilobites, just as man is rapidly and often inexcusably annihilating many kinds of beasts and birds. Apart from the struggle with competitors, it is conceivable that some stereotyped animals were unable to accommodate themselves to changes in their surroundings, and also that some fell victims to their own constitutions, becoming too large, too sluggish, too calcareous,—in short, too extreme.

Appearance of animals in time.—Such tables as those given here are apt to be misleading, in that they convey the impression that the great types of structure have appeared suddenly. It must be noted that any apparent abruptness is merely due to incompleteness of knowledge or inaccuracy of expression. The table is a mere list of a few important historical events, but one must fully realise that they are not isolated facts, that the present lay hidden in the past and has gradually grown out of it. Of the relative length of the periods represented here we know almost nothing, and we are also ignorant of the earliest ages in which life began. But the general result is clear. We find that in the Cambrian rocks, before Fishes appeared, the great Invertebrate classes were represented, though as yet but feebly. As we pass upwards they increase in number and in differentiation. Again, Fishes precede Amphibians, Amphibians are historically older than Reptiles, and many types of Reptiles are much older than Birds. In short, in the course of the ages life has been slowly creeping upwards.

Quaternary or Post-Tertiary.								
Tertiary or Cainozoic.	Pliocene.	Invertebrates.	Fishes.	Amphibians.	Reptiles.	Birds.	Mammals.	Man.
	Miocene.							(?)
	Eocene.							
Secondary or Mesozoic.	Cretaceous.		Teleosteans.	Modern Types.		Toothed and Primitive Forms.		
	Jurassic.					Archæopteryx.	Marsupials and Monotremes (?)	
	Triassic.						Few primitive types.	
	Permian.							
Primary or Palæozoic.	Carboniferous.			Labyrinthodonts.				
	Devonian or Old Red Sandstone.		Dipnoi.					
	Silurian.		Ganoids and Elasmobranchs.					
	Ordovician.							
	Cambrian.	Representatives of all the chief classes of Invertebrates.						
Pre-Cambrian or Archæan.								

CHAPTER VI

THE DOCTRINE OF DESCENT

WHEN we ask, as we are bound to ask, how the living plants and animals that we know have come to be what they are—very numerous, very diverse, very beautiful, marvellous in their adaptations, harmonious in their parts and qualities, and approximately stable from generation to generation—we may possibly receive three answers. According to one, the plants and animals that we know have always been as they are; but this is at once contradicted by the record in the rocks, which contain the remains of successive sets of plants and animals very different from those which now live upon the earth. According to another, each successive fauna and flora was destroyed by mundane cataclysms, to be replaced in due season by new creations, by new forms of life which arose after a fashion of which the human mind can form no conception. Of such cataclysms there is no evidence, and if it be enough to postulate one creation, we need not assume a dozen. The third answer is, that the present is the child of the past in all things: that the plants and animals now existing arose by a natural evolution from simpler pre-existing forms of life, these from still simpler, and so on back to a simplicity of life such as that now represented by the very lowest organisms.

This third theory is really an old one; it is merely man's application of his idea of human history to the world around him. It was maintained with much concreteness and power by Buffon (1749), by Erasmus Darwin (1794), and by Lamarck (1801). Yet in spite of the labours of these thoughtful naturalists and of many others, the general idea of the natural descent of organisms from simpler ancestors was not received with favour until Darwin, in his *Origin*

of *Species* (1859), made it current intellectual coin. By his work, and by that of Spencer, Wallace, Haeckel, Huxley, and many others, the doctrine of descent, the general fact of evolution, has been established, and is now all but universally recognised.

The chief arguments which Darwin and others have elaborated in support of the doctrine of descent, according to which organisms have been naturally evolved from simpler forms of life, may be ranked under three heads—(a) structural, (b) physiological, (c) historical.

Evidences of evolution.—(a) *Structural.*—Some say that there are over a million living animals of different species. In any case, there are many myriads. These species are linked together by varieties which make strict severance often impossible; they can be rationally arranged in general orders, families, and classes, between which there are not a few remarkable connecting links; there is a gradual increase of complexity from the Protozoa upwards along various lines of organisation; it is possible to rank them all on a hypothetical genealogical tree (Fig. 18). A little practical experience makes one feel that the facts of classification favour the idea of common descent.

Throughout vast series of animals we find in different guise essentially the same parts twisted into most diverse forms for different uses, but yet referable to the same fundamental type. It is difficult to understand this "adherence to type," this "homology" of organs, except on the theory of natural relationship.

There are many rudimentary organs in animals, especially in the higher animals, which remain very slightly developed, and which often disappear without having served any apparent purpose. Such are the "gill-slits" or "visceral-clefts" in Reptiles, Birds, and Mammals, the teeth of young whalebone whales, the pineal body (a rudimentary eye) in Vertebrates. Only on the theory that they are vestiges of structures which were of use in ancestors are these rudiments intelligible. They are relics of past history, comparable, as Darwin said, to the unpronounced letters in many words.

(b) *Physiological.*—Observation shows that animals are to some extent plastic. In natural conditions they usually exhibit some measure of changefulness from generation to

generation. This is especially the case if one section of a species be in any way isolated from the rest, or if the animals be subjected in the course of their wanderings to novel conditions of life.

The evidence from domesticated animals is very convincing. By careful interbreeding of varieties which pleased his fancy or suited his purpose, man has produced numerous breeds of horses, cattle, sheep, and dogs, which are often distinguished from one another by structural differences more profound than those which separate two natural species. In great measure, however, domestic breeds are fertile with one another, while different species rarely are. The numerous and very diverse breeds of domestic pigeons, which are all derived from the rock-dove (*Columba livia*), vividly illustrate the plasticity or variability of organisms.

It sometimes happens that the offspring of an animal resemble not so much the parent as some other form believed or known to be ancestral. Thus a blue pigeon like the ancestral *Columba livia* may be hatched in the dovecot. Such reversions are not readily intelligible except on the theory of descent.

(c) *Historical*.—Among the extinct animals disinterred from the rocks, many form series by which those now existing can be linked back to simpler ancestors. Thus the ancient history of horses, crocodiles, and cuttle-fish is known with a degree of completeness which makes it almost certain that the simpler extinct forms were in reality the ancestors of those which now live. Moreover, that many connecting links have been discovered in the rocks, and that the higher animals appear gradually in successive periods of the earth's history, are strong corroborations of the theory.

It is less easy to state in a few words how the facts of geographical distribution, or the history of the diffusion of animals from centres where the presumed ancestral forms are or were most at home, favour the doctrine of descent.

The individual life history of an animal—often strangely circuitous or indirect—is interpretable as a modified recapitulation of the probable history of the race.

Such, in merest outline, is the nature of the evidence which leads us to conclude that the various forms of life

have descended or have been evolved from simpler ancestors, and these from still simpler, and so on, back to the mist of life's beginnings. None of the evidence is logically demonstrative; we accept the evolution idea because it is a plausible interpretation which is applicable to many orders of facts, and is contradicted by none.

In accepting the evolutionist interpretation naturalists are unanimous; but in regard to the manner in which the modification of species or the general ascent of life has been brought about, there is much difference of opinion. The fact of evolution is admitted; debate goes on with regard to the factors (see Chapter XXVIII).

CHAPTER VII

PHYLUM PROTOZOA—THE SIMPLEST ANIMALS

CHIEF DIVISIONS

RHIZOPODS : *Classes*—LOBOSA, HELIOZOA, FORAMINIFERA, RADIO-LARIA, etc.

INFUSORIANS : *Classes* — FLAGELLATA, CILIATA, ACINETARIA, etc.

SPOROZOA : SEVERAL CLASSES.

THE Protozoa are the simplest animals, and they are of peculiar interest on this account. They throw light upon the beginnings of organic structure and vital activity, and they give us hints as to the nature of the first forms of life, of which we can know nothing directly. Almost all the Protozoa are single cells, unit masses of living matter; and in virtue of their simplicity, they are in some measure exempt from natural death, which is "the price paid for a body." In their variety they exhibit, as it were, a natural analysis of the higher animals, which are built up of many diverse cells.

GENERAL CHARACTERS

The Protozoa, the simplest and most primitive animals, are usually very small single cells. Most of them feed on small plants or on other Protozoa, or on débris, and not a few are parasitic. Most of them live in water, but many can endure dryness for some time. In one series (Rhizopods) the living matter is without any rind, and flows out in more or less changeful threads and lobes, by the movements of which the animals engulf their food and glide along. The others

have a definite rind, which in a large number (*Infusorians*) bears motile cilia or flagella, but in the others (*Sporozoa*) is usually without locomotor structures. But these three phases—amœboid, ciliate or flagellate, and encysted—may occur in the life history of one form; and the three main lines of evolution—*Rhizopods*, *Infusorians*, and *Sporozoa*—are marked by the predominant occurrence of the amœboid, ciliate or flagellate, and encysted phase of cell life. Many have a skeletal framework,—of lime, flint, or other material,—while within the cell there is a special kernel or nucleus, or there may be several. There are also other less constant structures. A Protozoon multiplies by dividing into two daughter units, or into a large number; and two individuals often unite, temporarily or permanently, in conjugation, which is analogous to the union of ovum and spermatozoon in higher animals. A few types, instead of remaining single cells, form by division or budding loose colonies, taking a step, as it were, towards the *Metazoa*, but never forming differentiated tissues.

First Type of Protozoa—AMŒBA

Amœba, a type of *Rhizopods*, especially of those in which the outflowing processes of living matter (*pseudopodia*) are blunt and finger-like (*Loboša*).

Description.—*Amœba proteus* and some other species are found in the mud of ponds; *A. terricola* occurs in damp earth. Some are just large enough to be seen with the unaided eye. The diameter is often about one-hundredth of an inch. Each is a unified corpuscle of living matter, and glides over the surface of stone and plant by protruding and retracting the pseudopodia. As they move the shape constantly changes, whence the old (1755) name of “*Proteus animalcule*.” Round the margin, which may show an apparent radial striation, the cell substance is firmer and clearer than it is in the interior, where it is more fluid, but contains very abundant granules, some of which are of a proteid, and others of a fatty nature. In the centre of the cell lies the usually single nucleus. The food consists of minute *Algæ*, such as diatoms, or of vegetable débris. There is reason also to suspect cannibalism. The food is surrounded by the finger-like processes, and engulfed

along with drops of water, which form food vacuoles in the cell substance. Into these vacuoles digestive ferments flow. After the digestible parts of the food have been absorbed, the undigested residue is got rid of at any point of the protoplasm. One or more contractile vacuoles are visible in the cell substance. They have an excretory function, and serve to get rid of the finer waste products.

Life history.—In favourable nutritive conditions the *Amœba* grows. At the limit of growth it reproduces by dividing into two. In disadvantageous conditions, such as drought, it may become globular, and, secreting a cell wall or cyst, lie dormant for a time. The cyst wall is said to be chitinoid. With the return of favourable conditions the

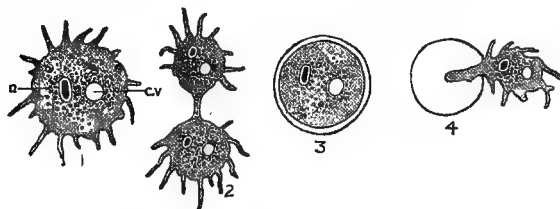

FIG. 35.—Life history of *Amœba*.

1. *Amœba* with pseudopodia; *n.*, nucleus; *cv.*, contractile vacuole. 2. Division in two. 3. Encystation. 4. Escape of *Amœba* from its cyst.

Amœba revives, and, bursting from the cyst with renewed energy, recommences the cell-cycle. The conjugation of two *Amœbæ* has been observed, and spore-formation occasionally occurs.

Second Type of Protozoa—ACTINOPHRYS

The Sun-animalcule, *Actinophrys sol*, is a type of the Heliozoa.

Description.—Like most other Heliozoa, *Actinophrys* lives in fresh water, floating about or rolling over the bottom. It is spherical and minute, measuring at most 0.05 mm. in diameter. Long stiff pseudopodia radiate out from the body. A clear axial filament runs up each pseudopodium, and the small organisms on which *Actino-*

phrys feeds are paralysed when they come in contact with the pseudopodia.

The body consists of ectoplasm and endoplasm. The ectoplasm is a thick external layer closely packed with large vacuoles, which are non-contractile and contain a clear fluid. But food vacuoles are formed as in other Protozoa, and there is also a single contractile vacuole. The endoplasm forms the central mass. It is not vacuolated, and contains the large, centrally placed nucleus.

Life history. —

An *Actinophrys* may withdraw its pseudopodia and divide into two, with or without the formation of a cyst. A number of individuals may unite for a time by the ectoplasm alone, and separate without any nuclear fusion having taken place (plastogamy). But Schaudinn has described a true sexual process which offers an interesting analogy to the processes of maturation and fertilisation in the higher animals.

A number of individuals become joined up in a common gelatinous cyst. Each loses its pseudopodia and forms a membranous cyst. These cysts become associated in pairs. The nucleus of each cyst divides mitotically, and a polar body is extruded from each, after which the nucleus returns to the resting condition. The cysts now fuse in pairs, with complete and intimate union of their nuclei and cell-bodies. The zygote so formed rests for a short period, then divides up into two daughter cysts from which emerge two new individuals of *Actinophrys*.

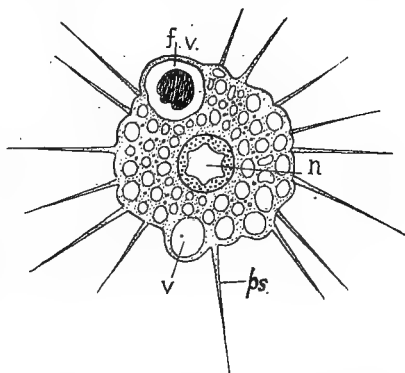

FIG. 36.—*Actinophrys sol* (Sun-animalcule).
—After Grenacher.

n., nucleus; *f.v.*, food vacuole; *v.*, contractile vacuole; *ps.*, pseudopodium.

In the allied genus *Actinosphaerium*, with very numerous nuclei, there is a strange and complicated formation and fusion of cysts within a single individual.

Third Type of Protozoa—POLYSTOMELLA

Polystomella (see Fig. 50) is a type of Foraminifera with a calcareous perforate shell or test.

Description.—*Polystomella crista* is common on the shore, especially among *Zostera*. It looks like a miniature of an Ammonite shell, and Foraminifera were indeed classified by the older naturalists with the Ammonites. The test forms a close spiral with beautifully chiselled surface; only the last whorl is visible from the outside. The test is made up of a series of chambers which communicate with one another and with the exterior by fine pores. Granular protoplasm fills up the chambers and forms also a thin layer on the outside. Long slender pseudopodia issue from the openings in the test and are given off also by the external protoplasmic layer. They frequently branch and anastomose with one another, and their granular protoplasm exhibits marked streaming movements. The pseudopodia serve to catch and entangle the diatoms and Infusoria on which the Foraminifer feeds.

Like many other Foraminifera, *Polystomella* shows a remarkable dimorphism. It occurs in two forms, outwardly indistinguishable, but differing in internal structure. In the *megalospheric* form the central chamber is large (a megalosphere), and there is a single large nucleus, placed about the middle of the series of chambers; in the *microspheric* form the central chamber is small (a microsphere), being about one-tenth of the diameter of the megalosphere, and there are numerous small nuclei. The megalospheric individuals are about thirty times as numerous as the microspheric individuals.

Life history.—The microspheric form has its nuclei replaced by chromidia (chromatin bodies detached from the nuclei into the protoplasm). These chromidia form the centres of amoeboid nucleated spores which leave the

shell or are liberated by the protoplasm creeping out and forming a halo of anastomosing threads round the deserted test. The spores secrete a shell and grow into the typical megalospheric forms.

When the megalospheric form is about to reproduce, its nucleus disintegrates and is replaced by numerous scattered nuclei formed around chromidia. The protoplasm segregates into little masses, each centred in a nucleus. Each of these nuclei divides by mitosis into two, then into four, and the division of the nucleus is followed by the division of the protoplasmic mass, so that hosts of tiny cells are

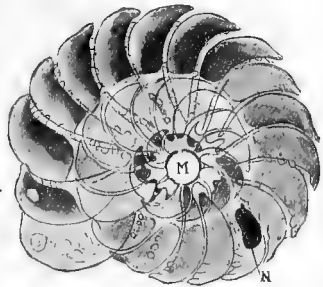

FIG. 37.—*Polystomella*, megalospheric form, with large central chamber (*M*) and one nucleus (*N*).—After Lister.

provided with flagella, swim out

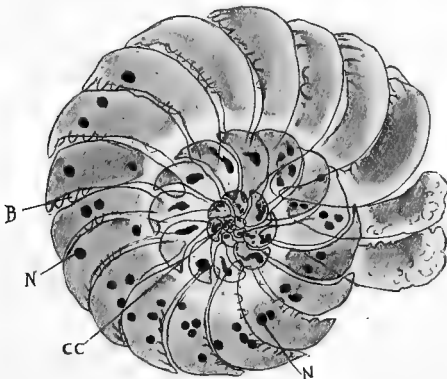

FIG. 38.—*Polystomella*, microspheric form, with small central chamber (*c.c.*), numerous nuclei (*N*), bridges of protoplasm between chambers (*B*).—After Lister.

into the water, leaving behind them the empty test, and there conjugate in pairs, not with one another but with similar "gametes" from another megalospheric individual. The "zygote" so formed becomes the initial chamber of a microspheric individual. In a more direct way—by fission—the megalospheric individual may give rise to another like itself. There is therefore in this complex life history of *Polystomella* an alternation between a sexual and an asexual generation.

Fourth Type of Protozoa—PARAMÆCIUM

Paramæcium, a type of ciliated Infusorians, especially of those which are uniformly covered with short cilia (Holotricha).

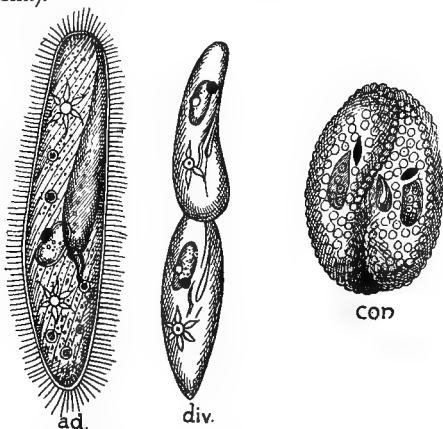

FIG. 39.—*Paramæcium*.—After Bütschli.

ad. Adult form, showing cilia, "mouth," contractile vacuoles, etc.
div. Transverse division.
con. Conjugation.

Description.—Specimens of *Paramæcium* may be readily and abundantly obtained by leaving fragments of hay to soak for some days in a glass of water. A few individuals have been lying dormant about the plant; they revive and multiply with extraordinary rapidity. They are also

abundant in most stagnant pools, and are just visible when a test-tube containing them is held between the eye and the light. Their food consists of small vegetable particles.

The form is a long oval, with the blunter end in front ;

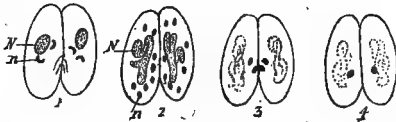

FIG. 40.—Conjugation of *Paramecium aurelia*—four stages.—After Maupas.

1. Shows macronucleus (*N*) and two micronuclei (*n*) in each of the two conjugates.
2. Shows breaking up of macronucleus, and multiplication of micronuclei to eight.
3. Shows the fertilisation in progress ; the macronucleus is vanishing.
4. Shows a single (fertilised) micronucleus in each conjugate.

the outer portion of the cell substance is differentiated into a dense rind or cortex, with a delicate external cuticle, perforated by cilia. There is a definite opening, the so-called mouth, which serves for the ingestion of food particles ; and there is also a particular anal spot posterior

FIG. 41.—Diagrammatic expression of process of conjugation in *Paramecium aurelia*.—After Maupas.

- A. The two micronuclei enlarge.
- B. Each divides into two.
- C. Eight micronuclei are formed.
- D. Seven disappear ; one (darkened) divides into two.
- E. An interchange and fusion occurs, and the conjugates separate.
- F. The fertilised micronucleus divides into two.
- G. Each conjugate begins to divide, the micronucleus of each half dividing into two, one of which becomes the macronucleus, while the others form the two normal micronuclei. The top line represents four individuals, each with a macronucleus and two micronuclei.

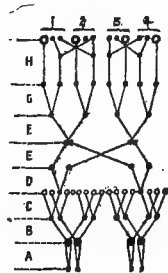

to the mouth, from which undigested residues are got rid of. The surface is covered with cilia, in regular longitudinal rows ; these serve both for locomotion and for driving food particles towards the mouth. Among the cilia there are small cavities in the cortex, in which lie fine protrusible

threads ("trichocysts"). These, though parts of a cell, suggest the thread cells of Cœlentera, and are probably of the nature of weapons. The cortical layer is contractile, and is distinctly fibrillated. In the substance of the cell lie two nuclei, the smaller "micronucleus" lying by the side of the larger "macronucleus." Food vacuoles occur as in the *Amœba*. There are two contractile vacuoles, from which fine canals radiate into the surrounding protoplasm; these discharge into the vacuole, which then bursts to the exterior.

Life history.—Growth is followed by obliquely transverse division into two (Fig. 39, *div.*). One half includes the "mouth," the other has to make one. As well as this simple fission, a process of transient conjugation also occurs. Two individuals approach one another closely, the two nuclei of each break up, an exchange of pieces of the micronucleus takes place; the two then separate, each to reconstruct its two nuclei (Fig. 40). This process is necessary for the continued health of the species.

The details of the conjugating process have been worked out with great care by Maupas and others. They differ slightly in different species; what occurs in *P. aurelia* is summarised diagrammatically in Fig. 41.

The micronuclear elements are represented by two minute bodies. As conjugation begins, these separate themselves from the macronucleus. The macronucleus degenerates, and each micronucleus increases in size (A). Each divides into two (B); another division raises their number to eight (C); seven of these seem to be absorbed and disappear, the remaining eighth divides again into what may be called the male and female elements (D); for mutual fertilisation now occurs (E). After this exchange has been accomplished, the Infusorians separate, and nuclear reconstruction begins. The fertilised micronucleus divides into two (F), and each half divides again (G), so that there are four in each cell. Two of these form the macronuclei of the two daughter-cells into which the Infusorian proceeds to divide (H); the other two form the micronuclei, but before another division occurs each has again divided. Thus each daughter-cell contains a macronucleus and two micronuclei.

Fifth Type of Protozoa—VORTICELLA

Vorticella, or the bell-animalcule, is a type of those ciliated Infusorians in which the cilia are restricted to a region round the mouth (Peritricha).

Description.—Groups of *Vorticella*, or of the compound form *Carchesium*, grow on the stems of fresh-water plants, and are sometimes readily visible to the unaided eye as white fringes. In *Vorticella* each individual suggests an inverted bell with a long flexible handle. The base of the stalk is moored to the water-weed, the bell swings in the

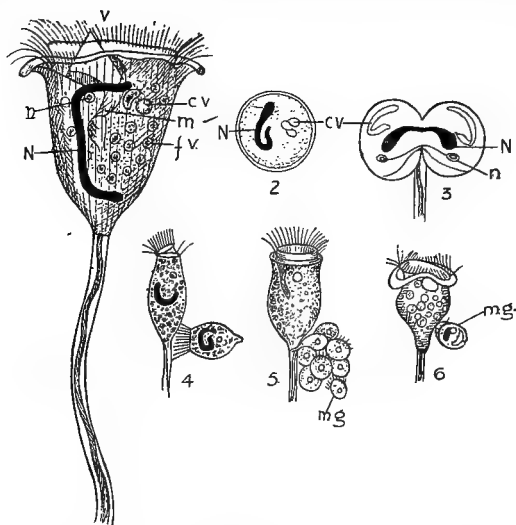

FIG. 42.—*Vorticella*.—After Bütschli.

1. Structure. *N.*, Macronucleus; *n.*, micronucleus; *c.v.*, contractile vacuole; *m.*, mouth; *f.v.*, food vacuole; *v.*, vestibule.
2. Encysted individual.
3. Division.
4. Separation of a free-swimming unit—the result of a division.
5. Formation of eight minute units (*mg.*).
6. Conjugation of microzooid (*mg.*) with one of normal size

water, now jerking out to the full length of its tether, and again covering down with the stalk contracted into a close and delicate spiral. In *Carchesium* the stalk is branched, and each branch terminates in a bell. Up the stalk there runs, in a slightly wavy curve, a contractile filament, which, in shortening, gives the non-contractile sheath a spiral form. This contractile filament, under a high power, may exhibit a fine striation. (A similar striated structure is seen in

some Amœbæ, Gregarines, spermatozoa, etc., and of a much coarser type in striped muscle fibres. It seems to be some structural adaptation to contractility.) The bell has a thickened margin, and within this lies a disc-like lid; in a depression on the left side, between the margin and the disc, there is an opening, the mouth, which leads by a distinct passage into the cell. On the side of this passage there is a weak spot, the potential anus, by which useless débris is passed out. The cilia are arranged so as to waft food particles into the mouth and down the passage. There is a large and horseshoe-shaped macronucleus, and a small micronucleus. Food vacuoles and contractile vacuoles are present as usual.

Sometimes a *Vorticella* bell jerks itself off its stalk and swims about; in other conditions it may form a temporary cyst; normally, the cilia are very active, and the movements of the stalk frequent and rapid. Multiplication may take place by longitudinal fission—a bell divides into similar halves; one of these acquires a basal cirlet of cilia and goes free, ultimately becoming fixed. Or the division may be unequal, and one, or as many as eight, microzooids may be set free. These swim away by means of the posterior girdle of cilia, and each may conjugate with an individual of normal size. In this case a small active cell (like a spermatozoon) fuses intimately with a larger passive cell, which may be compared to an ovum.

Sixth Type of Protozoa—VOLVOX

Volvox is a type of flagellate Infusorians, especially of those with flagella of equal size.

Volvox is found, not very commonly, in fresh-water pools, and is usually classed by botanists as a green Alga. It consists of numerous biflagellate individuals, connected by fine protoplasmic bridges, and embedded in a gelatinous matrix, from which their flagella project, the whole forming a hollow, spherical, actively motile colony. In *V. globator* the average number of individuals is about 10,000; in *V. aureus* or *minor*, 500–1000. The individual cells are stellate or amœboid in *V. globator*, more spherical in *V. aureus*; each contains a nucleus and a contractile vacuole.

At the anterior hyaline end, where the flagella are inserted, there is a pigment spot; the rest of the cell is green, owing to the presence of chlorophyll corpuscles. In consequence of the presence of these, *Volvox* is *holophytic*, *i.e.* it feeds as a plant does and builds up starch granules.

In its method of reproduction *Volvox* is of much biological interest and importance. As Klein, one of its best describers, says, it is an

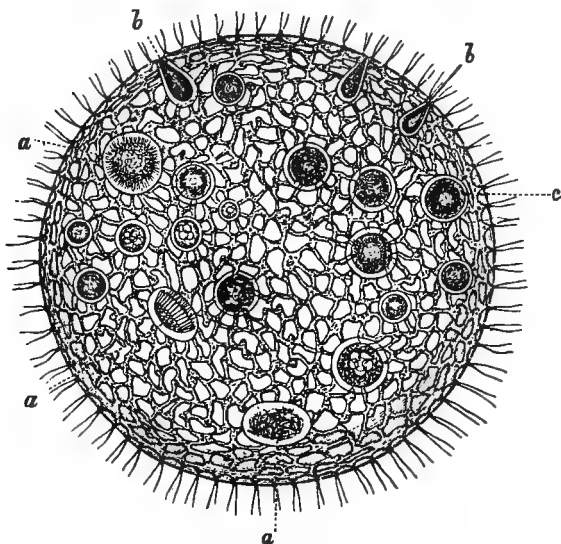

FIG. 43.—*Volvox globator*.—After Cohn.

a, Balls of sperms; *b*, immature ova; *c*, ripe ova.

epitome of the evolution of sex. Some of the colonies are asexual. In these a limited number of cells possess the power of dividing up to form little clusters of cells; these clusters escape from the envelope of the parent colony, and form new free-swimming colonies. In other colonies there are special reproductive cells, which may be called ova and spermatozoa.

In *V. globator* the two kinds of reproductive cells are usually formed in the same colony, the formation of spermatozoa generally preceding that of the ova. Technically the colony may then be described as a protandrous hermaphrodite.

In *V. aureus* the colony is oftenest unisexual or dioecious, *i.e.* either male or female. But it may be monoecious or hermaphrodite, and is then generally protogynous, *i.e.* producing eggs first.

Whether in a hermaphrodite or in a unisexual colony, the sex cells appear among the ordinary vegetative units; the ova are distinguishable by their larger size, the "sperm mother cells" divide rapidly and form numerous (32-100 or more) slender spermatozoa, each with two cilia. In *V. globator* their bundles may break up within the parent colony; or, as always occurs in *V. aureus*, they may escape intact, and swim about in the water. In any case, an ovum is fertilised by a spermatozoon, and, after a period of encystation and rest, segments to form a new colony. Occasionally, however, this organism, so remarkable a condensation of reproductive possibilities, may produce ova which develop parthenogenetically.

Here, then, we have an organism, on the border line between plant and animal life, just across the line which separates the unicellular from the multicellular, illustrating the beginning of that important distinction between *somatic* or body cells and *reproductive* cells, and occurring in asexual, hermaphrodite, and unisexual phases. Klein records no less than twenty-four different forms of *V. aureus* from the purely vegetative and asexual to the parthenogenetic, for there may be almost entirely male colonies, almost entirely female colonies, and other interesting transitional stages. Klein has also succeeded to some extent in showing that the occurrence of the various reproductive types depends on outside influences.

Seventh Type of Protozoa—MONOCYSTIS

Monocystis, a type of Sporozoa in which the cell is *not* divided into two parts by a partition.

Description.—Two species (*M. agilis* and *M. magna*) infest the male reproductive organs of the earthworm almost constantly. The full-grown adults are visible to the naked eye. They are usually flattened worm-like cells, but the shape alters considerably during the sluggish movements. There is a definite contractile rind, which is sometimes fibrillated, and a more fluid medullary substance, in which the large nucleus floats. In one species there is an anterior projection which resembles the cap of *Gregarina*, otherwise unrepresented in *Monocystis*. As in *Gregarina*, and many other parasitic forms, a contractile vacuole is absent.

Life history.—The young form of *M. agilis* is parasitic within one of the sperm mother cells of the earthworm. It grows, and becomes free from the cell as a trophozoite. In the free stage, two individuals may unite in the curious

end-to-end manner observed also in *Gregarina*. In reproduction two individuals (gametocytes) become associated inside a common cyst. The nucleus of each divides up repeatedly, and the daughter nuclei migrate to the surface of the cell, where each becomes surrounded by a little mass of protoplasm. Each of the gametocytes has thus given rise to a number of gametes, while there remains over a mass of residual protoplasm which has not been used up during this process. The wall between the two gametocytes now breaks down and the gametes conjugate in pairs, forming zygotes. It is probable that of each pair of conjugating gametes one is derived from each gametocyte. Each zygote

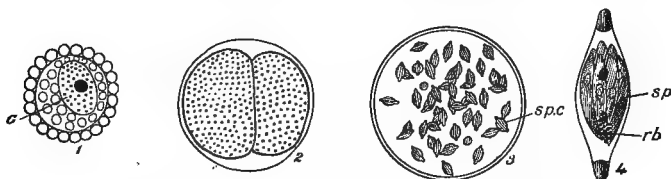

FIG. 44.—Life history of *Monocystis*.—After Bütschli.

1. Young Gregarine lying within a sperm mother cell of earthworm.
2. Association of two Gregarines within a cyst, ready to form gametes.
3. Numerous spore-cases (*sp.c.*, pseudonavicellæ) within a cyst.
4. A spore-case with eight spores (*sp.*) and a residual core (*rb.*).

secretes a membrane and becomes a spore-case. The nucleus divides up, and eight elongated spores are formed round a residual core. The spore-case now takes its typical shape and is known as a pseudonavicella. The spores are considerably larger than those of *Gregarina*. Eventually, in the alimentary canal of another earthworm the cyst bursts, the spore-cases are extruded, the spores emerge from their firm chitinous cases. The young spore (sporozoite) is like a bent spindle (falciform), and seems next door to being flagellate. It bores into a mother sperm cell, and from this it afterwards passes as an adult into the cavity of the seminal vesicles. Intracellular parasitism and copious food naturally act as checks to activity, and the adult is sluggish.

The allies of *Monocystis* occur chiefly in "Worms," Tunicates, and Arthropods; none are known in Vertebrates.

Eighth Type of Protozoa—GREGARINA

Gregarina, a type of Sporozoa in which the cell is divided into two regions by a partition.

Description.—Various species occur in the intestine of the lobster, cockroach, and other Arthropods. When young they are intracellular parasites, but later they become free in the gut. They feed by absorbing diffusible foodstuffs, such

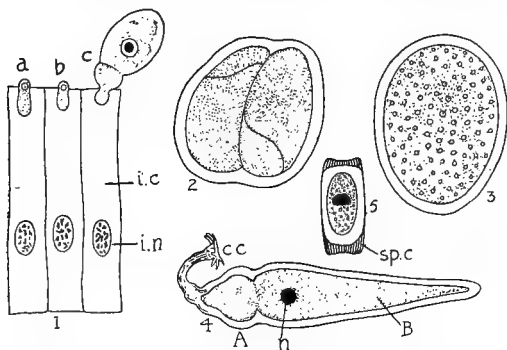

FIG. 45.—Life history of *Gregarina*.—After Bütschli.

1. Young forms (*a*, *b*, *c*) emerging from intestinal cells (*i.c.*); *i.n.*, nucleus of intestinal cell.
2. Two forms conjugating (*G. blattarum*).
3. Spore formation within a cyst.
4. Adult with deciduous head-cap (*c.c.*), and a cuticular partition dividing the cell into an anterior part (*A*) and a posterior part (*B*); *n.*, the nucleus.
5. A spore within its spore-case (*sp.c.*).

as peptones and carbohydrates, from their hosts, and store up glycogen within themselves. In many the size is about one-tenth of an inch. There is a firm cuticle of "proto-elastin," which grows inwards so as to divide the cell into a larger nucleated posterior region and a smaller anterior region, and also, in the young stage, forms a small anterior cap. The cell substance is divided into a firmer cortical layer and a more fluid central substance. The protoplasm often presents a delicate fibrillar appearance, suggesting that of striated muscle. The nucleus is very distinct, but there are no vacuoles. We may associate the absence of

locomotor processes, "mouth," and contractile vacuoles, as well as the thickness of the cuticle and the general passivity, with the parasitic habit of the Gregarines. It is not clearly understood how these and other intestinal parasites have become habituated to resist the action of digestive juices.

Life history.—The young Gregarine is parasitic in one of the lining cells of the gut; it grows, and, leaving the cell, remains for a time still attached to it by the cap (Fig. 45, *a, b, c*); later this is cast off, and the individual becomes free in the gut, while still increasing in size. Two or more individuals attach themselves together end to end, but the meaning of this is obscure. Encystation occurs, involving a single unit or two together. The details of spore-formation are similar to those in *Monocystis*. All the protoplasm is not always used up in forming the spores, but a residue may remain, which forms a network of threads supporting the spores. The cyst is sometimes (as in *G. blattarum*) complex, with "ducts" serving for the exit of the spores, each of which is surrounded by a firm case. Eventually the cyst bursts, the spore-cases are liberated, and from within each of these eight spores emerge to become cellular parasites. The adult of *G. (Porospora) gigantea* is sometimes three-quarters of an inch in length—enormous for a Protozoon.



FIG. 46.—End-to-end union of Gregarines. —After Frenzel.

Ninth Type of Protozoa—COCCIDIUM SCHUBERGI

Coccidia are intracellular parasitic Sporozoa, attacking mainly the epithelial cells of the gut or associated organs. They are found chiefly in insects, myriopods, molluscs, and vertebrates.

Coccidium schubergi infests the intestinal epithelium of the centipede *Lithobius forficatus*. The adult is a minute

oval or spherical cell with a nucleus. It lives a quiescent life within the host cell, growing and absorbing nourishment until the resources of the cell are exhausted.

Life history.—The coccidium enters the host cell as a minute sickle-shaped body, pointed at the anterior end, and

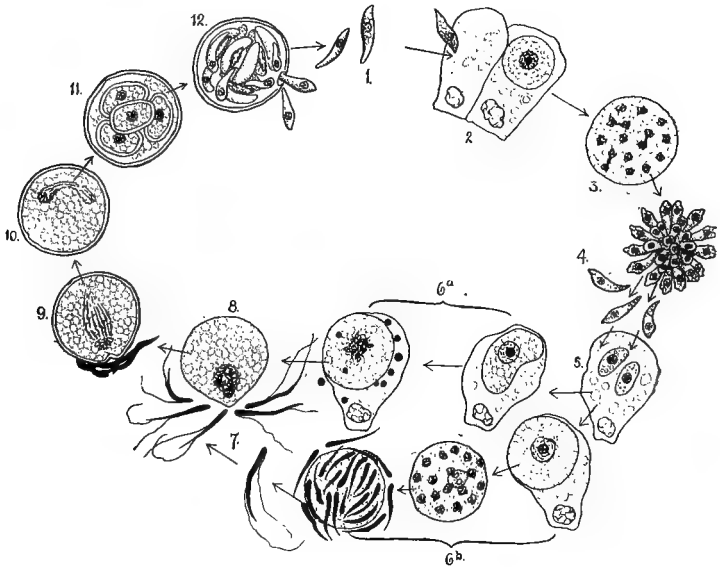

FIG. 47.—Life history of Coccidium.—After Schaudinn.

1. Sporozoite; 2. Sporozoite entering a cell and becoming a trophozoite; 3-4. Schizont, forming merozoites; 5. Merozoites entering another cell; 6^a. Merozoite forming macrogamete; 6^b. Merozoite forming microgametes; 7. Free microgamete; 8-9. Fertilisation of macrogamete by microgamete; 10. Zygote within oöcyst; 11. Formation of spores within oöcyst; 12. Spores forming sporozoites.

more blunt posteriorly. This is the *sporozoite* stage of the life history; it is liberated from a cyst (oöcyst) when the latter is swallowed by the centipede in its food. When freed in the gut the sporozoite progresses by forward gliding movements, alternating these by flexions, bending itself like

a bow and straightening out again. When about to enter an epithelial cell it presses the anterior end through the cell wall and wriggles its way in. Once within the cell in which development is to proceed, its movements gradually cease, but it may pass through several cells before coming to rest. Within the host cell the coccidium—now in the *trophozoite* stage—becomes oval in form, and in about twenty-four hours has reached full size and has exhausted the host cell contents. This is the completion of the trophozoite period, and the parasite now enters the *schizont* stage, where its nucleus divides into a number of daughter nuclei. These arrange themselves around the periphery of the cell, whilst the protoplasm breaks up to form along with them bodies of a shape similar to the sporozoites. There are important structural differences, however, apart from the difference in origin. The parasites, now known as *merozoites*, rupture the host cell, move in the gut cavity after the manner of the sporozoites, enter fresh epithelial cells, and repeat the foregoing cycle until ultimately the greater part of the gut epithelium is destroyed. In about five days, however, owing perhaps to the failing capacity of the host to nourish, the limit of asexual reproductivity is reached, and the parasite now enters upon a spore-forming stage. Certain merozoites grow more slowly than the others, and instead of becoming schizonts give rise to elements of two types, viz. microgametes, slender cells bearing a flagellum at each end, which are male, and macrogametes, larger bean-shaped cells, which are female. The latter after maturation free themselves from the host cell, and in the cavity of the gut are fertilised by a male element. After fertilisation, a transparent membrane forms around the zygote (fertilised cell). This membrane in the first instance serves to exclude all microgametes after the first, and later, becoming very tough and resistant, forms a protecting envelope or *oöcyst*. After the oöcyst is formed the parasite may pass from the host to the exterior or remain for some time longer within it. The nucleus of the zygote within the oöcyst now divides into four, around which the protoplasm aggregates itself to form the spores. There are thus four spores within a cyst. Each spore divides, forming two *sporozoites*, which on the arrival of the oöcyst in the gut of a fresh host are liberated,

and attacking the lining epithelium recommence the life history.

GENERAL CLASSIFICATION OF PROTOZOA

Since the Protozoa are unicellular organisms (except the few which form loose colonies), their classification should be harmonious with that of the cells in a higher animal. This is so. Thus (*a*) the Rhizopods, in which the living matter flows out in changeful threads or "pseudopodia," as

CLASSIFICATION OF PROTOZOA

(CORTICATA.) Predominantly ciliated and active. INFUSORIANS.	(GYMNOMYXA.) Predominantly amoeboid. RHIZOPODS.	(CORTICATA.) Predominantly encysted and passive. SPOROZOA.
ACINETARIA.	RADIOLARIA.	
CILIATA.	FORAMINIFERA.	SPOROZOA
RHYNCHOFLAGELLATA	LABYRINTHULIDEA.	OR
DINOFLAGELLATA.	HELIOZOA.	
FLAGELLATA.	LOBOSA.	GREGARINES.
PROTEOMYXA and MYCETOZOA. PRIMITIVE FORMS.		

in the common *Amœba*, are comparable with the white blood corpuscles or leucocytes, many young ova, and other "amoeboid" cells of higher animals; (*b*) the Infusorians, which have a definite rind and bear motile lashes (cilia or flagella), *e.g.* the common *Paramecium*, may be likened to the cells of ciliated epithelium, or to the active spermatozoa of higher animals; (*c*) the parasitic Sporozoa, which

have a rind and no motile processes or outflowings, may be compared to degenerate muscle cells, or to mature ova, or to "encysted" passive cells in higher animals.

This comparison has been worked out by Professor Geddes, who also points out that the classification represents the three physiological possibilities—(a) the amœboid units, neither very active nor very passive, form a median compromise; (b) the ciliated Infusorians, which are usually smaller, show the result of a relative predominance of expenditure; (c) the encysted Gregarines represent an extreme of sluggish passivity.

But, as Geddes and others have shown, the cells of a higher animal often pass from one phase to another,—the young amœboid ovum accumulating yolk becomes encysted, the ciliated cells of the windpipe may, to our discomfort, sink into amœboid forms. The same is true of the Protozoa; thus in various conditions the ciliated or flagellate unit may become encysted or amœboid, while in some of the simplest forms, such as *Protomyxa*, there is a "cell-cycle" in which all the phases occur in one life history.

SYSTEMATIC SURVEY

A. Primitive forms.—Under this heading may be included two classes: (1) the *Proteomyxa*, primitive, insufficiently known forms often without a nucleus, though nuclear material may be present in the form of scattered granules (chromidia), and (2) the Mycetozoa, organisms with somewhat complex fructifications, often classed as plants allied



FIG. 48.—Diagram of *Protomyxa aurantiaca*.—After Haeckel.

1. Encysted; 2. Dividing into spores; 3. Escape of spores, at first flagellate, then amœboid; 4. Plasmodium, formed from fusion of small amœbæ.

to Fungi. As examples of the *Proteomyxa*, we have the interesting *Protomyxa* in four phases: (a) encysted and breaking up into spores, which (b) are briefly flagellate, (c) sink into amœboid forms, and (d) flow together into a composite "plasmodium"; *Vampyrella*, parasitic on fresh-water Algæ; and many others.

The Mycetozoa are well illustrated by *Fuligo* or *Æthelium septicum*, "flowers of tan," found in summer as a large plasmodium on the bark of the tan-yard. The coated spores are formed in little capsules which rise from the surface of the plasmodium. The spores may be first flagellate, then amœboid, or amœboid from the first; the characteristic plasmodium is formed by the fusion of the amœbæ.

B. Predominantly amœboid Protozoa.—Rhizopoda.—The simplest Rhizopods generally resemble *Amœba*, and are ranked in the class (3) Lobosa. They may reproduce simply by division, as does *Amœba* itself, or may liberate several buds at once (*Arcella*), or form spores which conjugate (*Pelomyxa*). Various forms, such as *Arcella*, are furnished with a shell.

(4) The Labyrinthulidea are represented by forms like *Labyrinthula* on Algæ, and *Chlamydomyxa* on bog-moss, which consist of a mass of protoplasm spread out into a network, and of numerous spindle-shaped units, which travel continually up and down the threads of the living net.

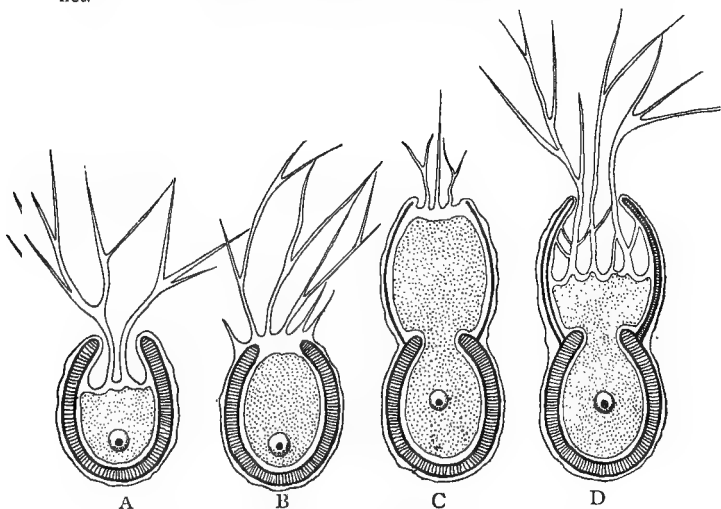

FIG. 49.—Formation of shell in a simple Foraminifer.
—After Dreyer.

In A the shell has one chamber; B, C, and D show the formation of a second. Note outflowing pseudopodia and the enclosure of the shell by a thin layer of protoplasm; note also the nucleus in the central protoplasm.

As (5) Heliozoa are classified the sun-animalcules (*Actinosphærium*, *Actinophrys sol*), and others, in which there are stiff processes radiating from a spherical body. Reproduction may be by division or by spore formation; skeletal structures may be represented by spicules.

The (6) Foraminifera or Reticularia include an interesting series of shelled forms in which the peripheral protoplasm forms branching interlacing threads. A few simple forms occur in fresh water; the great majority occur on the floor of the sea at varying depths; some

families are abundantly represented on the surface. The shell is usually calcareous, more rarely arenaceous or chitinous. There is sometimes dimorphism. Multiplication occurs by fission, or by the formation of swarm-spores (amoeboid or flagellate). Foraminifera are common as fossils from Silurian rocks onwards, and at the present day are very important in the formation of calcareous ooze; in this respect *Globigerina*, with a chambered shell, is especially important. Species of *Gromia* are found in both fresh and salt water; *Haliphysema*, a form utilising sponge-spicules to cover itself, was once mistaken for a minute sponge.

Most kinds of chalk consist mainly of the shells of Foraminifera

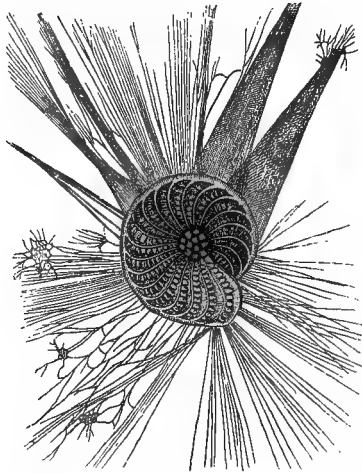

FIG. 50.—A Foraminifer (*Polystomella*) showing shell and pseudopodia.—After Schultze.

accumulated on the floor of ancient seas; *Nummulites* (Fig. 17) and related fossil forms were as large as shillings or half-crowns.

More complex are the (7) Radiolaria, which are divided by a chitinous membrane into an inner central capsule (with one or more nuclei), and an outer portion, gelatinous and vacuolated, giving off radiating thread-like pseudopodia, which very rarely interlace. There is usually a skeleton in the form of a siliceous lattice-work or regularly disposed spicules outside the central capsule, but in some cases the shell is formed of a horn-like substance called acanthin, which is probably a complex silicate. Radiolarians multiply by fission, which sometimes includes a halving of the skeleton, and by spores, which in some cases are dimorphic. Most Radiolarians include unicellular Algæ (yellow

cells), with which they live in intimate mutual partnership (symbiosis). Most Radiolarians float on the surface of the sea; others live below the surface at varying depths; and some are abyssal. They are abundant as fossils, and of much importance in the formation of the ooze of great depths.

Examples.—*Thalassicola*, *Eucyrtidium*, and the colonial *Collozoum* and *Sphærozoum*.

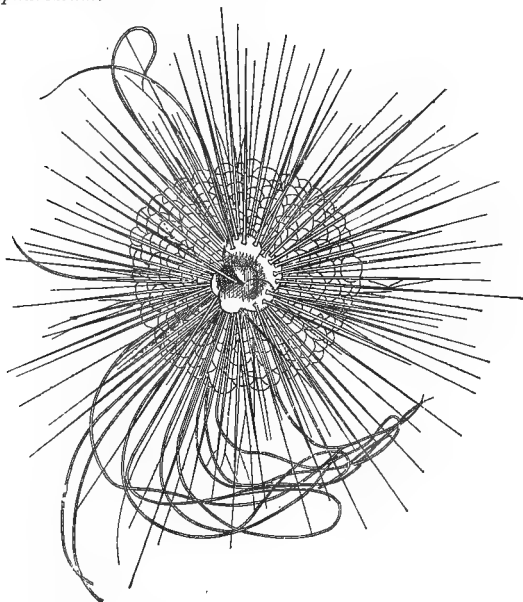

FIG. 51.—A pelagic Foraminifer—*Hastigerina* (*Globigerina*) *murrayi*.—After Brady.

Note central shell, projecting calcareous spines with a protoplasmic axis; also fine curved pseudopodia and vacuolated protoplasm.

C. Predominantly active forms (ciliate and flagellate), generally called Infusorians.—Protozoa, with a definite rind and with 1-3 undulating flagella, are included as (8) Flagellata, a very large group, among which are such familiar forms as the common *Euglena* of ponds; the Monads; *Volvox*, a colonial form; *Codosiga*, a colony in which the individual cells are furnished with a collar (Choanoflagellata). The Hæmoflagellata are important blood parasites, generally called Trypanosomes (see p. 121).

Modified flagellate forms are included in the groups Dinoflagellata and Cystoflagellata, in both of which there are two flagella, differently placed in the two cases. In the first are included *Peridinium* and *Ceratium*; in the latter, the large phosphorescent *Noctiluca*. They form an important part of the plankton of lakes and sea.

As (9) Ciliata are included a very large number of forms, more or less closely resembling *Paramecium* or *Vorticella*, and very abundant in infusions; some, such as *Opalina*, in the intestine of the frog, are parasitic.

As specially modified Ciliata are included (10) Acinetaria, highly specialised forms, ciliated when young, but usually furnished when adult

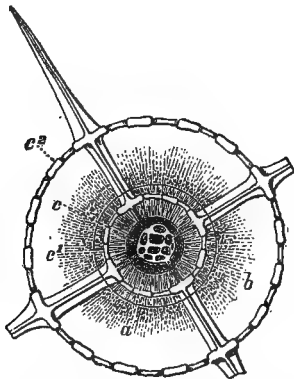

FIG. 52.—Optical section of a Radiolarian (*Actinomma*).
—After Haeckel.

a, Nucleus; *b*, wall of central capsule; *c*, siliceous shell within nucleus; *c*¹, middle shell within central capsule; *c*², outer shell in extra-capsular substance. Four radial spicules hold the three spherical shells together.

with suckorial tentacles. They are fixed in adult life, and feed on other Protozoa. As examples may be given *Acineta*; *Dendrosoma*, forming branched colonies; and *Ophryodendron*, without suckorial tentacles. Some, like *Sphaerophrya*, are minute and parasitic.

D. Predominantly encysted Protozoa.—Sporozoa.—Forms like *Gregarina* and *Monocystis* are included in a group of the (II) Sporozoa, the Gregarinida in the strict sense. They are parasites in the gut or body cavity of many Invertebrates, especially Arthropods. *Coccidium* is a type of the Coccidiidea, which are intracellular parasites occurring in Arthropods, Molluscs, and Vertebrates. A very important group, with a life cycle essentially similar to that of the Coccidiidea, are the Hæmosporidia, which are parasitic in the red blood corpuscles of Vertebrates. The malaria parasites belong to this

group. In many of the Hæmosporidia a part of the life cycle takes place in an intermediate host, usually a mosquito or a tick.

Other groups of the Sporozoa are the Myxosporidia, with peculiar nematocyst-like organs (Invertebrates and cold-blooded Vertebrates), and the Sarcosporidia, which are found inside the striped muscles of warm-blooded Vertebrates.

GENERAL NOTES ON THE FUNCTIONS OF PROTOZOA

Movement.—The simplest form of movement is that termed amœboid, as illustrated by an *Amœba*. In ordinary conditions it is continually changing its shape, putting forth blunt lobes and drawing others in. With this is usually associated a streaming movement of the granules. A more defined contraction, like that of a muscle cell, is illustrated in the contractile filament of the stalk of *Vorticella* and similar Infusorians; and not less definite are the movements of cilia and flagella, by means of which most Infusorians travel swiftly through the water. Cilia in movement are bent and straightened alternately; while flagella, which are usually single mobile threads, exhibit lashing movements to and fro, or, more often, are held stretched out in front, and by a curious rotatory movement draw the cell along. They are then more aptly termed *tractella*. It seems probable that cilia and flagella consist of an elastic core surrounded by a sheath, which may be uniformly contractile, or may have one contractile band, or two opposite contractile bands, and so on.

Considered generally, the movements are of two kinds: either (1) reflex, *i.e.* responses to external stimulus, as when the Protozoon moves towards a nutritive substance; or (2) automatic, *i.e.* such movements as appear to originate from within, without our being able to point to the immediate stimulus, *e.g.* the rhythmical pulsations of contractile vacuoles. Actively moving Protozoa usually show the following motor reaction to stimulus:—they move backward, turn over on one side structurally defined, and then move forward again.

Sensitiveness.—The Amœba is sensitive to external influences. It shrinks from strong light and obnoxious materials; it moves towards nutritive substances. This sensitiveness is, so far as we know, diffuse—a property of the whole of the cell substance; but the pigment spots of some forms are specialised regions.

Many Protozoa well illustrate a strange sensitiveness to the physical and chemical stimuli of objects or substances with which they are not in contact. Thus the simple amœboid *Vampyrella* will, from a considerable distance, creep directly towards the nutritive substance of an Alga, and the plasmodium of a Myxomycete will move towards a decoction of dead leaves, and away from a solution of salt. The same sensitiveness, technically termed *chemotaxis*, is seen when micro-organisms move towards nutritive media or away from others; when the spermatozoon (of plant or animal) seeks the ovum, or when the phagocytes (wandering amœboid cells) of a Metazoon crowd towards an intruding parasite or some irritant particle.

Nutrition.—The *Amœba* expends energy as it lives and moves; it regains energy by eating and digesting food particles. Most of the free Protozoa live in this manner upon solid food particles; a few, such as *Volvox*, in virtue of their chlorophyll, are holophytic, *i.e.* they feed like plants; the parasitic forms usually absorb soluble and diffusible substances from their hosts.

Respiration.—Oxygen is simply taken up by the general protoplasm from the surrounding medium, into which the waste carbonic acid is again passed. The bubbles which enter with the food particles assist in respiration. In parasitic forms the method of respiration must be the same as that of the tissue cells of the host.

Excretion.—Of the details of this process little is certainly known, but the contractile vacuoles are, without doubt, primitive excretory appliances. In the more specialised forms they appear to drain the cell substance by means of fine radiating canals, and then to burst to the exterior. Uric acid and urates are said to be demonstrable as waste products.

Colour.—Pigments are not infrequently present in the Protozoa. We have already noticed the presence of chlorophyll in some forms; with Radiolarians the so-called “yellow cells” are found almost constantly associated. Each of these cells consists of protoplasm, surrounded by a cell wall, and containing a nucleus. The protoplasm is impregnated with chlorophyll, the green colour of which is obscured by a yellow pigment. Starch is also present. The cells multiply by fission, and continue to live after isolation from the protoplasm of the Radiolarian. All these facts point to the conclusion that the cells are symbiotic Algæ, so-called *Zoochlorella*. According to some, the “chlorophyll corpuscles” seen in the primitive *Archerina*, in some flagellate forms, as *Euglena*, and in many Ciliata, as *Stentor*, *Stylonichia*, one species of *Paramacium*, *Volvox* and the allied forms, are

also symbiotic Algæ, which have lost the power of independent existence. The evidence for this is, however, insufficient, and this explanation will not apply in cases like that of *Vorticella viridis*, where the green colouring matter is uniformly distributed through the protoplasm. In many cases there is, besides the chlorophyll, a brown pigment, identical with the *diatomin* of Diatoms. In many of the Flagellata there are one or more bright pigment spots at the anterior end of the cell; these may be specially sensitive areas. In some of the simpler Gregarines the medullary protoplasm is coloured with pigment which is apparently a derivative of the hæmoglobin of the host.

Psychical life.—Protozoa often behave in a way which suggests control, but it should be noted that cut-off fragments sometimes behave just as effectively as the intact units. Verworn has decided, after much labour, that the Protozoa do not exhibit what even the most generous could call intelligence; but this is no reason why he or any other evolutionist should doubt that they have in them the indefinable rudiments of mind. Jennings has shown that the behaviour of some Infusorians corresponds to what may be called the method of trial and error; they “try” one kind of response after another until, in some cases, they give the effective answer.

GENERAL NOTES ON THE STRUCTURE OF PROTOZOA

The Protozoa are sometimes called “structureless,” but they are only so relatively. For though they have not stomachs, hearts, and kidneys, as Ehrenberg supposed, they are not like drops of white of egg.

The cell substance consists of a living network or foam, in the meshes or vacuoles of which there is looser material. Included with the latter are granules, some of which are food fragments in process of digestion, or waste products in process of excretion.

The cell substance includes one or more nuclei, specialised bodies which are essential to the life and multiplication of the unit. In the Protozoa there are several conditions under which the nucleus may exist:—

(1) In some adult forms, and in many spores or young forms, no definite nucleus has yet been discovered. It is, however, unnecessary to preserve the term “Monera” for such simple forms, as it is probable that nuclear material does exist in the form of granules.

(2) In the majority of cases, notably in the Sporozoa, the nucleus is single, often large, and placed centrally. From a consideration of the cells of Metazoa we may call this the typical case.

(3) In many of the Ciliata, *e.g.* *Paramecium*, there are two dimorphic nuclei. There is a large oblong nucleus, and beside it a smaller spherical one.

(4) In some Ciliata the macronucleus exists in the form of powder scattered through the protoplasm, *e.g.* in *Opalinopsis*. The granules may collect to form a compact nucleus when fission is about to take place.

(5) In *Opalina*, from the intestine of the frog, and a few other forms, there are very numerous nuclei, arranged in a symmetrical manner in the cell substance. In some cases these isolated nuclei have been observed to unite to form one large nucleus just before binary fission takes place. Of these various cases the diffuse condition is apparently very primitive.

The nucleus, when stained and examined under high powers, is observed to be complex in structure. It consists of a nuclear network, or a coil of chromatin threads. Karyokinesis has been observed in some cases.

While we cannot at present define the physiological import of the nucleus, we must recognise its importance. Thus Bruno Hofer has shown that when an *Amœba* is cut in two, the part with the nucleus lives and grows normally, while the part without any nucleus sooner or later dies; and Balbiani has observed that in the case of Infusorians cut into pieces, those parts which have nuclei survive, while if no nucleus is present in the fragment, the wound may remain unhealed, and death ensues.

The outer part of the cell substance ("ectoplasm") is often clearer and less granular than the inner part ("endoplasm"). In corticate Protozoa there is a more definite rind or thickened margin of cell substance. Outside this there may be a "cuticle" distinct from the living matter, sometimes consisting of chitin, or gelatin, or rarely of cellulose. The cuticle may form a cyst, which is either a protection during drought, or a sheath within which the unit proceeds to divide into numerous spores. Moreover, the cuticle may become the basis of a shell formed from foreign particles, or made by the animal itself of lime, flint, or organic material.

In the cell substance there may be bubbles of water taken in with food particles (food vacuoles), contractile vacuoles, fibres which seem to be specially contractile (in Gregarines), spicules of flint or threads of horn-like material, which may build up a connected framework, and the pigments already mentioned.

REPRODUCTION OF PROTOZOA

Growth and reproduction are on a different plane from the other functions. Growth occurs when income exceeds expenditure, and when constructive or anabolic processes are in the ascendant. Reproduction occurs at the limit of growth, or sometimes in disadvantageous conditions.

As it is by cell division that all embryos are formed from the egg, and all growth is effected, the beginnings of this process are of much interest. (a) Some very simple Protozoa seem to reproduce by what looks like the rupture of outlying parts of the cell substance. (b) The production of a small bud from a parent cell is not uncommon, and some Rhizopods (e.g. *Arcella*, *Pelomyxa*) give off many buds at once. (c) Commoner, however, is the definite and orderly process by which a unit divides into two—ordinary cell division. (d) Finally, if many divisions occur in rapid succession or contemporaneously, and usually within a cyst enclosing the parent cell, *i.e.* in narrowly limited time and space, the result is the formation of a considerable number of small units or spores. In the great majority of cases, each result of division is seen to include part of the parent nucleus.

A many-celled animal multiplies in most cases by liberating reproductive cells—ova and spermatozoa—different from the somatic cells which make up the “body.” A Protozoon multiplies by dividing wholly into daughter cells. This difference between Metazoa and Protozoa in their modes of multiplication is a consequence of the difference between multicellular and unicellular life. Each part of a divided Protozoon is able to live on, and will itself divide after a time, whereas the liberated spermatozoa and ova of a higher animal die unless they unite.

By sexual reproduction we mean—(a) the liberation of special reproductive cells from a “body,” and (b) the fertilisation of ova by spermatozoa. As Protozoa have no “body”—though the beginnings of one are seen in the colonial forms—they cannot be said to exhibit sexual reproduction in the first sense (a), yet many of them (especially the Sporozoa) give origin by division to special reproductive cells. And although many Protozoa can live on, dividing and multiplying, for prolonged periods without the occurrence of anything like fertilisation, processes corresponding to fertilisation are of general occurrence. For in many of the Protozoa there occurs at intervals a process of “conjugation” in which two individuals unite

either permanently or temporarily. This is an incipiently sexual process; it is the *analogue* of the fertilisation of an ovum by a spermatozoon. In many cases, moreover, there is a difference between the two conjugates, analogous to the difference between ovum and spermatozoon.

(1) It is one of the recurrent phases in the life history of some of the simplest Protozoa (*Proteomyxa* and *Mycetozoa*) (see p. 107), that a number of amoeboid units flow together into a composite mass, which has been called a "*plasmodium*."

(2) It is known that more than two individual Sporozoa and other forms occasionally unite. To this the term "multiple conjugation" has been applied.

(3) Commonest, however, is the union of two apparently similar individuals, either permanently, so that the two fuse into one, or temporarily, so that an exchange of material is effected. Permanent conjugation has been observed in several Rhizopods, Infusorians, and Sporozoa. Temporary conjugation is well known in not a few ciliated Infusorians, and it is possible that a curious end-to-end union of certain Sporozoa is of the same nature, or it may be of the nature of a "plasmodium" formation. The formation of small spores (gametes) which conjugate is not uncommon.

(4) There are some cases where one of the conjugating individuals is larger and less active than the other. Thus in *Vorticella*, a small free-swimming form unites and fuses completely with a stalked individual of normal size. This "dimorphic conjugation" is evidently analogous to the fertilisation of a passive ovum by an active spermatozoon. In *Volvox* this is even more obvious, for the small and active cells, both in shape and method of formation, recall the spermatozoa of higher forms.

Significance of Conjugation.—The precise interpretation of conjugation is uncertain. We may regard it as a mutual rejuvenescence, each unit supplying some substances or qualities which the other lacks; or we may regard it rather as a process by which the average character of the species is sustained, peculiarities or pathological variations of one individual being counteracted by other characters in the neighbour (apparently no near relation) with which it conjugates; or we may see in it a source of variation as the result of new combinations among the essential hereditary substances. The researches of M. Maupas have thrown much light on the facts, and some of his results deserve summary.

It has been often alleged that the subsequent dividing is accelerated by conjugation; but Maupas finds that this is by no means the case. The reverse in fact is true. While a pair of Infusorians (*Onychodromus grandis*) were engaged in conjugation, a single individual had, by ordinary asexual division, given rise to a family of from forty thousand to fifty thousand individuals. Moreover, the intense internal changes preparatory to conjugation, and the general inertia during subsequent reconstruction, not only involve loss of time, but expose the Infusorians to great risk. Conjugation seems to involve danger and death rather than to conduce to multiplication and birth.

The riddle was, in part at least, solved by a long series of careful observations. In November 1885, M. Maupas isolated an Infusorian (*Stylonichia pustulata*), and observed its generations till March 1886. By that time there had been two hundred and fifteen generations produced by ordinary division, and since these lowly organisms do not conjugate with near relatives, there had been no conjugation.

What was the result? At the date referred to, the family was observed to have exhausted itself. The members were being born old and debilitated. The asexual division came to a standstill, and the powers of nutrition were lost.

Meanwhile, before the generations had exhausted themselves, several of the individuals had been restored to their natural conditions, where they conjugated with unrelated forms of the same species. One of these was again isolated, and watched for five months. In this case, up till the one hundred and thirtieth generation, it was found that on removal to fresh conditions the organisms were capable of conjugating with unrelated forms. Later this power was lost, and at the one hundred and eightieth generation the individuals of the same family were observed making vain attempts to conjugate with each other.

We thus see that without normal conjugation the whole family becomes senile, degenerates both morphologically and physiologically. Morphologically, the individuals decrease in size, until they measure only a quarter of their original proportions, the micronucleus atrophies completely or partially, the chromatin of the macronucleus gradually disappears, other internal structures also degenerate. Physiologically, the powers of nutrition, division, and conjugation come to a standstill, and this senile decay of the isolated individuals or family inevitably ends in death.

The general conclusion is evident. Sexual union in those Infusorians, dangerous, perhaps, for the individual life, and a loss of time so far as immediate multiplication is concerned, is absolutely necessary for the species. The life runs in strictly limited cycles of asexual division. Conjugation with allied forms must occur, else the whole life ebbs. Without it, the Protozoa, which some have called "immortal," die a natural death. Conjugation is the necessary condition of their eternal youth.

It must be noted, however, that some subsequent investigators have watched over two hundred asexual generations of ciliated Infusorians without seeing the slightest trace of senile degeneration. Calkins has cultivated *Paramœcium* for over six hundred generations without conjugation by giving beef extract when degeneration threatened to set in. The same result was obtained by stimulating with alcohol, strychnine, etc.

Ecology.—Many Protozoa raise organic débris once more into the circle of life, and many form part of the food of higher animals. Thus those pelagic Foraminifera and Radiolarians, which sink dying to the great oceanic depths, form along with more substantial débris the fundamental

food supply in that plantless world. Fundamental, since it is plain that the deep-sea animals cannot all be living on one another.

Almost every kind of nutritive relation occurs among the Protozoa. Predatory life is well illustrated by most Infusorians, and thoroughgoing parasitism by the Sporozoa; *Opalina* in the rectum of the frog may serve as a type of those which feed on decaying débris, and *Volvox* of those which are holophytic. Radiolarians, with their partner Algæ, exhibit the mutual benefits of symbiosis, the plants utilising the carbon dioxide of their transparent bearers, the animals being aërated by the oxygen which the plants give off in sunlight, and probably nourished by the carbohydrates which they build up. Some of the parasitic forms, especially among the Sporozoa, are fatally injurious to higher animals.

Though Protozoa may be seriously infected by Bacteria, by *Acineta* parasites, by some fungi, like *Chytridium*, etc., fatal infection is rare, because of the power of intracellular digestion which most Protozoa possess. "The parasite," Metchnikoff says, "makes its onslaught by secreting toxic or solvent substances, and defends itself by paralysing the digestive and expulsive activity of its host; while the latter exercises a deleterious influence on the aggressor by digesting it and turning it out of the body, and defends itself by the secretions with which it surrounds itself." With this struggle should be compared that between phagocytes and Bacteria in most multicellular animals.

History.—Of animals so small and delicate as Protozoa, we do not expect to find distinct relics in the much-battered ancient rocks. But there are hints of Foraminifer shells even in the Cambrian; more than hints in the Silurian and Devonian; and an abundant representation in rocks of the Carboniferous and several subsequent epochs. The shells of calcareous Foraminifera form an important part of chalk deposits.

There seem at least to be sufficient relics to warrant Neumayr's generalisation in regard to Foraminifera, that the earliest had shells of irregularly agglutinated particles (*Astrorhizidæ*), that these were succeeded by forms with regularly agglutinated shells, exhibiting types of architecture which were subsequently expressed in lime.

Relics of siliceous Radiolarian shells are also known from Silurian strata onwards, with, perhaps, the exception of the Devonian. Best known are those which form the later Tertiary deposits of Barbados earth, from which Ehrenberg described no fewer than two hundred and seventy-eight species.

Protozoa and Disease.—The discoveries of recent years have shown that the study of Protozoa is an inquiry of great practical importance. Numerous Protozoa—representing the main divisions of the group—are known at some stage of their life history to be parasitic in the human body or in domestic animals. Some of them are associated with serious and fatal diseases. Thus, *Amœba* (*Entamœba*) *histolytica* causes an inflammation of the intestinal mucous membrane and liver abscesses. Several flagellates of the genus *Trypanosoma* are serious

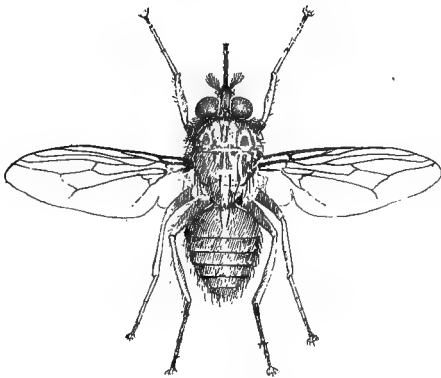

FIG. 53.—*Glossina palpalis*, tse-tse fly.

parasites of the blood affecting man, horses, cattle, camels, and other domestic animals in both the old and new worlds. *Trypanosoma gambiense* (Fig. 54) is the parasite causing the fatal “sleeping sickness,” a human disease disseminated by tse-tse fly, *Glossina palpalis*, in Africa (Fig. 53). In the fully formed Trypanosome, the flagellum is expanded into an undulating membrane which extends down the edge of the cell. In this membrane there are eight fine contractile threads or myonemes, which are connected at the lower end with a modified nucleus called the blepharoplast. The so-

called Leishman-Donovan body, the parasite of dum-dum fever or splenomegaly, a disease occurring in India and Africa, has recently been shown to be a stage in the life history of a flagellate protozoon. Of great importance, also, is the family of Spirochætes, one of which, *Treponema* (*Spirochæte*) *pallidum*, is the organism which causes syphilis. Another highly important genus is *Piroplasma* (*Babesia*), a sporozoon. These are blood parasites,

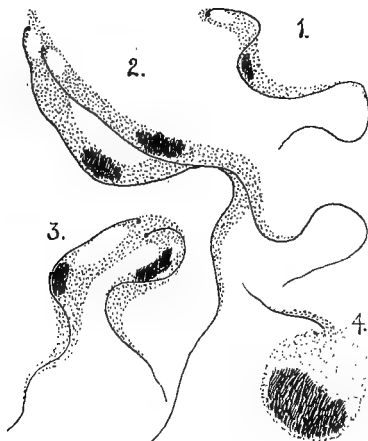

FIG. 54.

1. *Trypanosoma gambiense*, showing nucleus, blepharoplast, and flagellum.
- 2 and 3. Individuals undergoing longitudinal fission.
4. Leucocyte engulfing a trypanosome.

causing Texas fever in cattle and analogous diseases in horse, sheep, dog, and possibly man also. The parasite of Texas fever is transmitted through two generations of ticks. Lastly may be mentioned the parasites of malaria, *Laverania* and *Plasmodium*, whose complicated life histories in mosquito and man are now well known.

General zoological interest.—The Protozoa illustrate, in

free and single life, forms and functions like those of the cells which compose the many-celled animals. Typically, they show great structural or morphological simplicity, but great physiological complexity. Within its single cell the Protozoon discharges all the usual functions, while in a higher animal distinct sets of cells have been specialised for various activities, and each cell has usually one function dominant over the others. The Metazoan cells, in acquiring an increased power of doing one thing, have lost the Protozoan power of doing many things.

The Protozoa remain at the level represented by the reproductive cells of higher forms, and are comparable to reproductive cells which have not formed bodies. In the sexual colonies of *Volvox*, however, we see the beginning of that difference between reproductive cells and body cells which has become so characteristic of Metazoa. The Protozoa are self-recuperative, and in normal conditions they are not so liable to "natural death" as are many-celled animals. Weismann and others maintain that they are physically immortal.

They illustrate—(a) the beginnings of reproduction, from mere breakage to definite division, either into two, as in fission, or in limited time and space into many units, as in the formation of spores within a cyst; (b) the beginnings of fertilisation, from "the flowing together of exhausted cells" and multiple conjugation, to the specialised sexual union of some Infusorians, Heliozoa, Sporozoa, etc.,—where two individuals become closely united; along with this, the beginnings of maturation, as shown in the formation of polar nuclei in some Heliozoa, Sporozoa, Flagellata, and Lobosa; (c) the beginnings of sex, in the difference of size and of constitution sometimes observed between two conjugating units (e.g. in *Coccidium*); (d) the beginnings of many-celled animals, in the associated groups or colonies which occur in several of the Protozoan classes. These colonies show a gradation in complexity. *Raphidiophrys* and other Heliozoa form loose colonies, which arise by the want of separation of the products of fission. Among the Radiolarians there are several colonial forms; in these the individuals are united by their extra-capsular protoplasm, but are all equivalent. In *Proterospongia* the cells show

considerable morphological distinctiveness; some are flagellate, some amœboid, some encysted and spore-forming. Again, in *Volvox*, as we noticed above, the cells of the colonies show a distinction into nutritive and reproductive units.

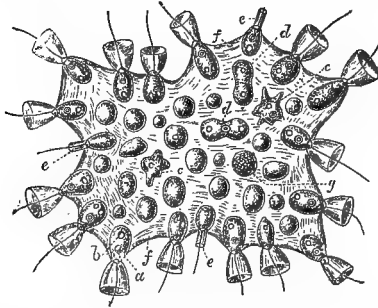

FIG. 55.—A colonial flagellate Infusorian—*Proterospongia haeckelii*.—After Saville Kent.

There are about 40 flagellate individuals. *a*, nucleus; *b*, contractile vacuole; *c*, amœboid unit in gelatinous matrix; *d*, division of an amœboid unit; *e*, flagellate units with collars contracted; *f*, hyaline outer membranes; *g*, unit forming spores.

Lastly, in their antithesis of passivity and activity, constructive and destructive preponderance, anabolism and katabolism, the Protozoa illustrate the phases of the cell-cycle, and so furnish a key to the variation of higher animals.

CHAPTER VIII

PHYLUM PORIFERA—SPONGES

Class I. CALCAREA.

Class II. HEXACTINELLIDA.

Class III. DEMOSPONGIÆ.

SPONGES seem to have been the first animals to attain marked success in the formation of a "body." For though their details are often complex, their essential structure is simpler than the average of any other class of Metazoa, and some of the simplest forms do not rise high above the level of the gastrula embryo. A "body" has been gained, but it shows relatively little division of labour or unified life; it is a community of cells imperfectly integrated. The cells of the body show an arrangement in two distinct layers, which is one of the most essential characters of the Metazoa. There are no definite organs, and the tissues are, as it were, in the making. Sponges are passive, vegetative animals, and do not seem to have led on to anything higher; but they are successful in the struggle for existence, and are strong in numbers alike of species and of individuals.

GENERAL CHARACTERS

Sponges are diploblastic (two-layered) Metazoa, the middle stratum of cells, the mesoglæa, not attaining to the definiteness of a proper mesoderm. There is no cœlom or body cavity. The longitudinal axis of the body corresponds to that of the embryo; in other words, the general symmetry of the gastrula is retained. In these three characters the Sponges

agree with the Cœlentera, and differ from higher (triploblastic and cœlomate) Metazoa.

The body varies greatly in shape, even within the same species. It is traversed by canals, through which currents of water bear food inwards and waste outwards. Numerous minute pores on the surface open into afferent canals, leading into a cavity or cavities lined by flagellate cells, many or all of which have a goblet shape with a delicate collar through which the flagellum rises ("choanocytes"). To the activity of the flagella the all-important water currents are due. The internal cavity may be a simple tube, or it may have radially outgrowing chambers, or it may be represented by branched spaces, from which afferent canals lead to the exterior. When there is a distinct central cavity there is usually but one large exhalant aperture (osculum), but in other cases there are many exhalant apertures.

A delicate outer layer covers the body, and is perhaps continued into the afferent canals. Beneath the covering layer there is in all but the simplest forms a mass of cells (the mesoglaea) which may be very varied in its composition. Thus there are scleroblasts making the skeleton of lime, flint, or spongin; amœboid cells or phagocytes, important in digestion and excretion, reproductive cells, and other elements.

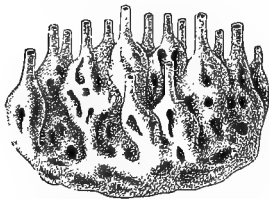

FIG. 57.—A sponge colony.

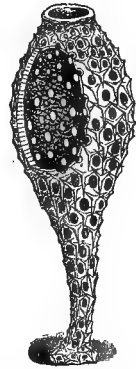

FIG. 56.—Simple sponge (*Ascetta primordialis*).—After Haeckel.

Note the vase-like form, the apical osculum, the inhalant pores in the walls.

This median mass of cells is traversed by the afferent canals and by the diverticula of the central cavity or the branches of the original central cavity, lined by flagellate cells. It is difficult to call this cavity or system of cavities the gut or enteron, or to call the layer which lines it the endoderm, or the outer covering layer the ectoderm. In

fact, the sponges are very different from other Metazoa, and represent a cul de sac in evolution.

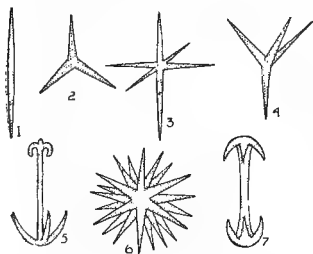

FIG. 58.—Sponge spicules.

- 1, Monaxon; 2, triod; 3, triaxon; 4, tetraxon; 5, anchor; 6, polyaxon; 7, a kind of amphidisc.

Budding is very common, and in a few cases buds are set adrift. Both hermaphrodite and unisexual forms occur. The sexually-produced embryo is almost always developed within the mesoglaea, and leaves the sponge as a ciliated larva. With the exception of one family, all are marine.

Description of a simple sponge.—A very simple sponge, such as *Ascetta*, is a hollow vase, moored at

one end to rock or seaweed, with a large exhalant aperture at the opposite pole, and with numerous minute inhalant pores penetrating the walls. In the calcareous sponges, the pores are minute perforations in single cells (porocytes).

The walls consist of—(1) a flat covering layer; (2) a mesoglaea containing triradial calcareous spicules, phagocytes, and reproductive elements; and (3) a layer lining the central cavity, and composed of collared flagellate cells, like some of the monad Infusorians (cf. Fig. 55).

More complicated forms.—But a description of a simple sponge like *Ascetta* conveys little idea of the structure of a complex form such as the bath-sponge (*Euspongia*). Let us consider the origin of complications.

(a) Sponges—long regarded as plants—are plant-like in being sedentary and passive. They seem also to feed

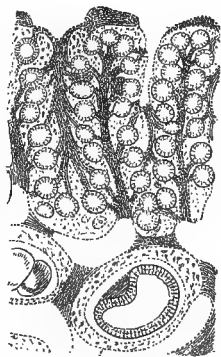

FIG. 59.—Section of a sponge.—After F. E. Schulze.

Showing inhalant canals, flagellate chambers, a gastrula forming in the mesoglaea, etc.

easily and well. Like plants, they form buds, the outcome of surplus nourishment. These buds, like the suckers of a rose-bush, often acquire some apparent independence, and the sponge looks like many vases, not like one. Moreover, as they grow these buds may fuse, like the branches of a tree tied closely together. Thus the structure becomes more intricate.

(b) In the simple sponge the cavity of the vase is completely lined by the collared flagellate cells (*Ascon* type). But the inner layer may grow out into radial chambers to which the choanocytes are restricted (*Sycon* type), and the walls of these may also be folded into side aisles (*Leucon* type). The outgrowing of the inner layer into the mesogloea may be continued even further, and the cells may become pavement-like except in the minute flagellate chambers, where alone the characteristic choanocytes are retained (see Fig. 60).

It may be that the characteristic folding or outgrowth of the inner layer is necessitated by the fact that the component cells are better

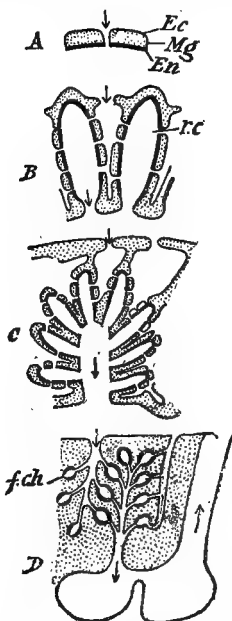

FIG. 60. — Diagram showing types of canal system. — After Korschelt and Heider. The flagellate regions are dark throughout, the mesogloea is dotted, the arrows show the direction of the currents. All the figures represent cross-sections through the wall.

- A. Simple *Ascon* type (*Ec.*, outer layer; *En.*, inner layer; *Mg.*, mesogloea).
- B. *Sycon* type, with flagellate radial chambers (*r.c.*).
- C. *Leucon* type, with flagellate side aisles on the main radial chambers.
- D. Still more complex type, with small flagellate chambers (*f.ch.*).

nourished and multiply more rapidly than those of the outer layer.

(c) By infoldings of the outer layer and a subjacent sheath of mesogloea—subdermal spaces may be formed; an outer cortex may be distinctly differentiated from the internal region in which the flagellate chambers occur; the pores may collect into sieve-like areas, which open into dome-like cavities; these and many other complications are common.

(d) The covering layer usually consists of flat epithelium, but flask-shaped cells have also been observed (Bidder). It may be folded inwards, as we have noticed, and, according to some, it also lines the inhalant or afferent canals in whole or in part. In a few cases, e.g. *Oscarella lobularis*, it is ciliated, and its cells may also exhibit contractility, as around the osculum of *Ascetta clathrus*, though the contractile elements usually belong to the mesogloea.

The inner layer consists typically of collared flagellate cells, but in the more complex sponges these are replaced, except in the flagellate chambers, by flat epithelial cells, with or without flagella.

The mesogloea contains very varied elements, and illustrates the beginnings of different kinds of tissue. Thus there are migrant amoeboid cells (phagocytes); irregular connective tissue cells; spindle-shaped connective tissue cells, united into fibrous strands; contractile cells, e.g. those forming a sphincter around the oscula of some forms, such as *Pachymatisma*; skeleton-making cells; pigment-containing cells; supposed nerve cells, projecting on the surface, and believed to be connected internally with multipolar (ganglion?) cells; and lastly, the reproductive cells.

(e) The skeleton consists of calcareous or siliceous spicules, or of spongin fibres, or of combinations of the two last. A calcareous spicule is formed of calcite, with a slight sheath and core of organic matter; a siliceous spicule is formed of colloid silica or opal; the spongin is chemically somewhat like silk. Uniradiate, biradiate, triradiate, quadri-radiate, sexradiate, and multiradiate spicules occur, and they are effective in keeping the meshes open and in giving the body architectural stability. In every pole scaffolding

we see, as it were, huge hexactinellid spicules, spliced together with rope. It is convenient to distinguish the large macroscleres from the small microscleres. Each spicule begins to be formed by one or more "scleroblasts," and may be speculatively regarded as an organised intracellular excretion. "During its growth," Professor Sollas says, "the spicule slowly passes from the interior to the exterior of the sponge, and is finally (in at least some sponges—*Geodia*, *Stelletta*) cast out as an effete product." The fibres of spongin are formed as the secretions of mesogloea cells, known as spongioblasts.

Ordinary functions.—Excepting the fresh-water Spongillidæ, all sponges are marine, occurring from between tide marks to great depths. After embryonic life is past, they live moored to rocks, shells, seaweeds, and the like. Their motor activity is almost completely restricted to the lashing movements of the flagella, the migrations of the phagocytes, and the contraction of muscular mesogloéal cells, especially around the exhalant apertures. In the closure of the inhalant pores, sponges show sensitiveness to injurious influences, but how far this is localised in specialised cells is uncertain.

The most important fact in the life of a sponge is that which Robert Grant first observed—that currents of water pass gently in by the inhalant pores, and more forcibly out by the exhalant aperture or apertures. This may be demonstrated by adding powdered carmine to the water. The instreaming currents of water bear dissolved air and supplies of food, such as Infusorians, Diatoms, and particles of organic débris. The outflowing current carries away waste. When a sponge is fed with readily recognisable substances, such as carmine or milk, and afterwards sectioned, the grains or globules may be found—(a) in the collared flagellate cells; (b) in the adjacent phagocytes of the mesogloea; (c) in the phagocytes surrounding the subdermal spaces, if these exist. It is uncertain whether the epithelium of the subdermal spaces or the flagellate lining of the deeper cavities is the more important area of absorption, but it is certain that the phagocytes play an important part in engulfing and transporting particles, in digesting those which are useful, and in getting rid of the useless.

In an extract of several sponges, Krukenberg found a (tryptic) digestive ferment, probably formed within the phagocytes, but digestion is wholly intracellular.

Many sponges contain much pigment; thus the lipochrome pigment zoonerythrin (familiar in lobsters) is common. Some pigments, such as floridine, may help in respiration. The green pigment of the fresh-water sponge is closely analogous, if not identical, with chlorophyll, and probably renders some measure of holophytic nutrition possible.

Reproduction.—If a sponge be cut into pieces, these may regenerate the whole—a fact which illustrates the relatively undifferentiated state of the sponge body. It is possible that fission may sometimes occur naturally.

The frequent budding is merely a kind of continuous growth, but when buds are set adrift, as sometimes happens, we have discontinuous growth or asexual reproduction.

In the fresh-water Spongillidæ there is a peculiar mode of reproduction by statoblasts or gemmules. A number of mesogloæal cells occur in a clump, some forming an internal mass, others a complex protective capsule, with capstan-like spicules, known as amphidiscs. According to W. Marshall, the life history is as follows: In autumn the sponge suffers from the cold and the scarcity of food, and dies away. But throughout the moribund parent gemmules are formed. These survive the winter, and in April or May they float away from the dead parent, and develop into new sponges. Some become short-lived males, others more stable females. The ova produced by the latter, and fertilised by spermatozoa from the former, develop into a summer generation of sponges, which, in turn, die away in autumn, and give rise to gemmules. The life history thus illustrates what is called alternation of generations. Interpreted from a utilitarian point of view, the formation of gemmules is a life-saving expedient. As Professor Sollas says, "the gemmules serve primarily a protective purpose, ensuring the persistence of the race, while as a secondary function they serve for dispersal."

All sponges produce sex cells, which seem to arise from amœboid mesogloæa cells retaining an embryonic character. In the case of the ovum, the amœboid cell increases in size, and passes into a resting stage; in the case of the male elements, the amœboid cell divides into a spherical cluster of numerous minute spermatozoa. The similar origin of the ova and spermatozoa is of interest. Most sponges are unisexual, but many are hermaphrodite. In

the latter case, however, either the production of ova or the production of spermatozoa usually preponderates, probably in dependence upon nutritive conditions.

Development.—It is not surprising to find that there is great variety of development in the lowest class of Metazoa; it seems almost as if numerous experiments had been made, none attended with progressive success.

The minute ovum, without any protective membrane, usually lies near one of the canals, and is fertilised by a spermatozoon borne to it by the water. It exhibits a certain power of migration, as in some Hydroids. Previous to fertilisation, the usual extrusion of polar bodies has been observed in a few cases, and is doubtless general. Segmentation is total and usually equal, and results in a spherical or oval embryo more or less flagellate. This leaves the parent sponge, swims about for a time, then settles down, and undergoes a larval metamorphosis often difficult to understand. It is peculiarly difficult to bring the history of the germinal layers in sponges into line with that in other Metazoa.

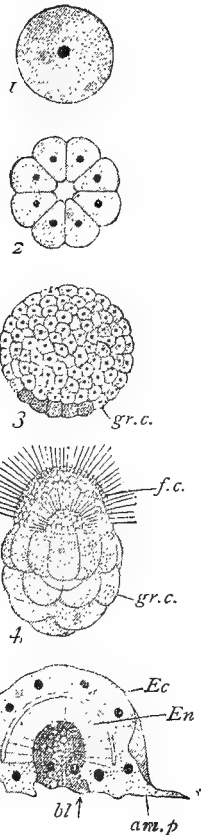

FIG. 61.—Development of *Sycandra raphanus*.—After F. E. Schulze.

1. Ovum.
2. Section of 16-cell stage.
3. Blastula with 8 granular cells (*gr.c.*) at lower pole.
4. Free-swimming amphiblastula, with upper hemisphere of flagellate cells (*f.c.*), and lower hemisphere of granular cells (*gr.c.*).
5. Gastrula stage settled down. *Ec.*, outer layer; *En.*, inner layer; *bl.*, closing blastopore; *am.p.*, mooring, amoeboid processes.

(a) In the small calcareous sponge *Sycandra raphanus* (Fig. 61), as described by F. E. Schulze, the segmentation results in a hollow ball of cells—the *blastula*. A few cells at the lower pole remain large, and are filled with nutritive granules; the other cells divide rapidly and become small, clear, columnar, and flagellate. The large granular cells become invaginated, forming what is called a “*pseudo-gastrula*.” This leaves the parent, and the cells forming the lower hemisphere

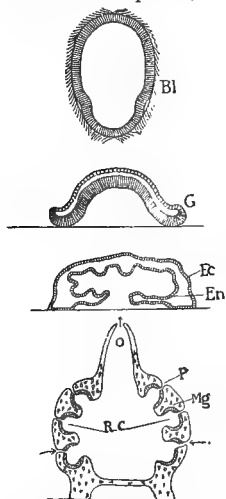

FIG. 62.—Diagrammatic representation of development of *Oscarella lobularis*.—After Heider.

Bl., Free-swimming blastula with flagella; G., gastrula settled down.

Next figure shows folding of inner layer (En.); Ec., outer layer. Lowest figure shows radial chambers (R.C.); Mesogloea (Mg.); inhalant pore (P.); exhalant osculum (O.).

hemispherical gastrula, which settles mouth downwards. Pores, an osculum, and the mesogloea are formed as before, and the inner layer becomes folded into flagellate chambers.

The main features of sponge embryology are thus summarised by Minchin:—

“I. The larva is composed of three classes of cell-elements: (1) Columnar flagellated cells, forming the outer covering or localised at

of the embryo become rounded and non-flagellate. The embryo swims for a time actively, but the flagellate cells of the upper hemisphere are invaginated into or overgrown by the large granular cells, and thus what is generally called the *gastrula* stage results. This soon settles down, on rock or seaweed, with the blastopore or gastrula mouth downwards, and is moored by amoeboid processes from the granular cells, which likewise obliterate the blastopore. The granular cells lose their granules, for the larva is not yet feeding; the now internal flagella disappear in the absence of the stimulating water; a mesogloea with spicules begins to be formed between the inner and outer layer, probably by migrants from the latter. But this disadvantageous state of affairs cannot last. Pores open through the walls, the entrance of water enables the inner cells to recover their flagella, and an exhalant aperture is ruptured at the upper pole. The young sponge is now in an *Ascon* stage, from which, by the outgrowth of the inner layer into radial chambers, it passes into the permanent *Sycon* form, grows into a cylinder, and becomes differentiated in detail (Fig. 61).

(b) In *Oscarella (Halisarca) lobularis* (Fig. 62), a sponge without any skeleton, the ovum segments equally into a blastula, which is flagellate all over. This free-swimming stage may be invaginated from either pole to form a

the anterior pole; (2) rounded, more or less amœboid elements, rarely flagellated, forming the inner mass or aggregated at the posterior pole; and (3) the archæocytes, usually scattered in the inner mass, and often represented by undifferentiated blastomeres. . . .

“II. The larva fixes and undergoes a metamorphosis whereby the flagellated cells become placed in the interior, while the cells of the inner mass come to surround them completely.

“III. (1) The flagellated cells of the larva become the choanocytes of the adult (gastral layer), acquiring a collar; . . . (2) the inner mass gives rise to the dermal layer in its entirety; . . . (3) the archæocytes become the wandering cells of the adult, from which the reproductive cells arise.”

It is interesting to note that the primitive germ-cells are early set apart.

Classification.—

Class I.—CALCAREA. With skeleton of calcareous spicules:—

Grade I.—Homocœla.—Continuous internal layer of collared flagellate cells, *e.g.* *Ascetta*, *Leucosolenia*.

Grade II.—Heterocœla.—Collared flagellate cells restricted to radial tubes or chambers, *e.g.* *Sycon* (*Grantia*).

Class II.—HEXACTINELLIDA, or Triaxonia, with sexradiate siliceous spicules (triaxons). The members live chiefly in deep water, *e.g.* Venus Flower-Basket (*Euplectella*) and the Glass-Rope Sponge (*Hyalonema*).

Class III.—Demospongiæ. Skeleton of siliceous spicules, but never triaxons, or of spongin fibres, or of spongin fibres and siliceous spicules, or absent.

Grade I.—Tetragonida, typically with tetraaxon spicules, *e.g.* *Pachymatisma*, *Tetilla*.

Grade II.—Monaxonida, with monaxon spicules, sometimes with spongin in addition, *e.g.* Mermaid's Gloves (*Chalina oculata*), Crumb-of-Bread Sponge (*Halichondria* or *Amorphina panicea*), Fresh-Water Sponge (*Spongilla*).

Grade III.—Ceratosa, “horny” sponges with or without spicules, *e.g.* the Bath-Sponge (*Euspongia*).

Grade IV.—Myxospongiida, without any skeleton, *e.g.* *Halisarca* and *Oscarella*.

A very remarkable form called *Merlia* seems to have both a siliceous and a calcareous skeleton.

History.—Sponges, as one would expect, date back almost to the beginning of the geological record. Thus the siliceous *Protospongia* occurs in Cambrian rocks, and in the next series—the Silurian—the main groups are already represented. From that time till now they have continued to abound and vary.

The division between calcareous and siliceous sponges goes deep down to the very roots of the phylum, and the siliceous branch must have divided very early into Triaxonia and Tetragonida.

Ecology.—Sponges are living thickets in which many small animals play hide-and-seek. Many of the associa-

tions are harmless, but some burrowing worms do the sponges much damage. The spicules and a frequently strong taste or odour doubtless save sponges from being more molested than they are; the numerous phagocytes wage successful war with intruding micro-organisms. Some sponges, such as *Cliona* on oyster-shells, are borers, and others smother forms of life as passive as themselves. Several crabs, such as *Dromia*, are masked by growths of sponge on their shells, and the free transport is doubtless advantageous to the sponge till the crab casts its shell. A compact orange-coloured sponge (*Suberites domuncula*) of peculiar odour often grows round a whelk-shell tenanted by a hermit-crab, and gradually dissolves the shell-substance. Within several sponges minute Algæ live, like the "yellow cells" of Radiolarians, in mutual partnership or symbiosis. One of the cuttlefishes, *Rossia glaucopsis*, puts its eggs carefully into pockets in the substance of a siliceous sponge. Finally, sponges deserve mention as factors in human civilisation.

General zoological position.—Sponges form the first successful class of Metazoa. They illustrate the beginnings of a "body," and the beginnings of tissues. Along with the Cœlentera, they differ markedly from the triploblastic, Cœlomate Metazoa, which do not retain the radial symmetry of the gastrula. In their germinal layers and in their internal cavity they differ so much from Cœlentera and all other Metazoa, that they must be regarded as on a by-road of evolution. This has been emphasised by Professor Ray Lankester in the term "Parazoa"; he speaks of them as a sterile stock.

Their origin is wrapped in obscurity; it may be that they are the non-progressive descendants of primitive gastrula-like ancestors with a sluggish constitution. The presence of choanocytes suggests a relationship with certain of the flagellate Protozoa (Choanoflagellata), and *Proterospongia* (Fig. 55) may possibly be regarded as a connecting link.

INCERTÆ SEDIS. MESOZOA

The title Mesozoa was applied by Van Beneden to some simple organisms which appear to occupy a very humble position in the

Metazoan series. He regarded them as intermediate between Protozoa and Metazoa; but others have remarked on their resemblance to Platyhelminthes, and especially to the sporocysts of certain Flukes. They may perhaps be regarded as precociously reproductive sporocysts. It will be enough here merely to notice four types:—

1. Dicyemidæ (type *Dicyema*) occur as parasites in Cephalopods;

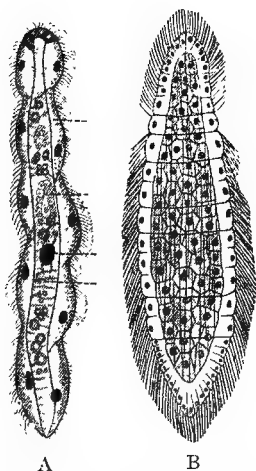

FIG. 63.—A. Young *Dicyema*.—After Whitman. B. Female Orthonectid (*Rhopalura giardii*).—After Julin.

e., Ectoderm; en., inner endoderm cell with nucleus (n.); and embryo (em.). Note the segmentation and the fibrillation supposed to be muscular.

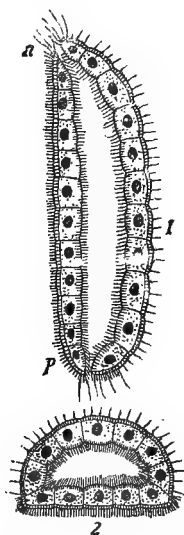

FIG. 64.—*Salinella*.—After Frenzel.

1. Longitudinal section—*a.*, anterior; *p.*, posterior.
2. Transverse section.

the body consists of a ciliated outer layer, enclosing a single multinucleate inner cell, within which egg-like germs develop, apparently without fertilisation, into dimorphic embryos (see Fig. 63, A).

2. Orthonectidæ (type *Rhopalura*) occur as parasites in Turbellarians, Brittle-stars, and Nemerteans; the body is slightly ringed, and consists of a ciliated outer layer, a subjacent sheath of contractile fibres, and an internal mass of cells, among which ova and spermatozoa appear. The sexes are separate and dimorphic (see Fig. 63, B).

3. Professor F. E. Schulze discovered a small marine organism—*Trichoplax adhærens*—in the form of a thin, *three-layered*, externally ciliated plate; and Monticelli records a similar form under the title *Treptoplax adhærens*. But *Trichoplax* is now said to be the planula of the Hydromedusan *Eleutheria*.

4. Professor J. Frenzel discovered in brine solutions a minute Turbellarian-like organism—*Salinella salve*—whose body consists of *one* layer of cells (Fig. 64). There is an anterior mouth, a ciliated food canal, and a posterior anus. The ventral surface is finely ciliated, the other cells bear short bristles. The animal reproduces by transverse fission, but conjugation and encystation also occur.

It must be confessed that some corroborative evidence in regard to this peculiarly simple animal is much to be desired.

CHAPTER IX

PHYLUM CŒLENTERA

Class 1. HYDROZOA.

Hydroids and
Medusoids.

Class 2. SCYPHOMEDUSÆ or
ACRASPEDA.

Jelly-fishes.

Class 3. ANTHOZOA or
ACTINOZOA.

Sea-anemones,
Madrepore-corals,
Alcyonarians, etc.

Class 4. CTENOPHORA.

THE Cœlentera—including zoophytes, swimming-bells, jelly-fish, sea-anemones, Alcyonarians, corals, and the like—form a very large series of Acelomate Metazoa, *i.e.* multicellular animals without a body cavity. Their simplest forms are not much above the level of the simplest sponges, but the series has been more progressive. Thus many illustrate the beginnings of definite organs. In their variety they seem almost to exhaust the possibilities of radial symmetry, and some types (*e.g.* Ctenophora) may be regarded as pioneers of the yet more progressive bilateral “worms.” Many are very vegetative, deserving the old name of zoophytes (which should rather be read backwards—Phytozoa), and in their budded colonies afford interesting illustrations of co-operation and division of labour. With the exception of three or four fresh-water forms like *Hydra*, all are marine.

GENERAL CHARACTERS

The Cœlentera are almost always radially symmetrical animals in which the primary long axis of the gastrula becomes the long axis of the adult. There is no body cavity, or cœlom, distinct from the digestive cavity (enteron) and its outgrowths. In the lower members of the phylum, the

primary opening of this cavity becomes the mouth of the adult, but in the more specialised types there is an (ectodermic) oral invagination, which forms a gullet-tube or stomodæum. Between the ectoderm and endoderm of the body wall there is a supporting layer, or mesoglæa, often of jelly-like consistency. In Ctenophora, however, a more definite mesoderm is established at an early stage in development. In the simplest cases the mesoglæa is a secretion quite devoid of cells, but secondary cells may migrate into it from the endoderm. Stinging cells of varying complexity are almost always present, but in most of the Ctenophora their place is taken by adhesive cells.

The Cœlentera exhibit two types of structure—polypoid and medusoid—which recur in modified forms throughout the group, and may be both present in the course of one life history, when they illustrate the phenomenon of alternation of generations, or metagenesis. The more primitive type is the sessile tubular polyp, which, at its simplest, may be compared to a gastrula fixed by one end, and furnished with a crown of tentacles round the central aperture of the other pole. The other derived form, which has become specialised in various directions, is the active medusoid or jelly-fish type. In several divisions the formation of a calcareous "skeleton" by the polypoid type results in the production of "corals." Multiplication by budding is common, and often results in the formation of colonies, some of which show considerable division of labour.

The preservation of the primary axis, the absence of true mesoderm and of a cœlom, are often said to distinguish Cœlentera and Sponges from the other Metazoa (Cœlomata), but the results of recent researches on the nature of the mesoderm seem to rob this distinction of part of its precision.

GENERAL SURVEY

The Cœlentera or "Stinging animals" include a large number of familiar and beautiful forms. The graceful zoophytes which fringe shells and stones, and the tiny transparent bells which float in the pools; the sea-anemones which cluster in the nooks of the rocks, and the active jelly-fish which swim on the waves, are but different expressions

of the antithesis between sedentary polypoid and active medusoid types which is characteristic of the phylum. The delicate iridescent globes, which represent the class Ctenophora, illustrate the climax of activity, and have no hint of a sedentary phase.

In our preliminary survey of the series, we may begin with the little fresh-water *Hydra* (Fig. 68), which is often

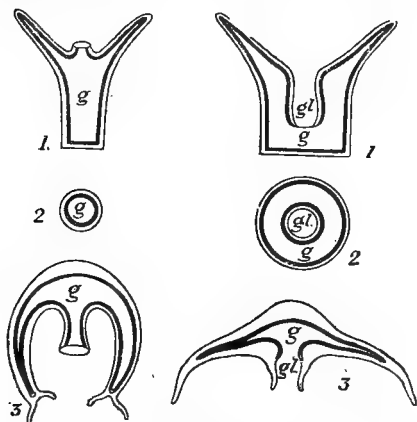

FIG. 65.—Diagram of Coelenterate structure, endoderm darker throughout.

1. To left, shows longitudinal section of *Hydra*; to right, of sea-anemone. *g.*, gut; *gl.*, incipient gullet.
2. To left, shows cross-section of *Hydra*; to right, of sea-anemone, in the region of the gullet.
3. To left, shows vertical section of Craspedote Medusoid (with velum); to right, of Acraspedote Medusa, without velum. *g.*, gut; *gl.*, gullet.

Note anatomical correspondence of the polypoid and medusoid forms.

to be found attached to the stems and leaves of water plants. The structure here is extremely simple, but the simplicity is probably due to degeneration. In favourable conditions the polyp may give off daughter buds, which remain for a time attached to the parent, and then separate as independent polyps. The bud itself, before leaving the parent, may also bud, so that three generations are present. If we picture this process of gemmation, but with

imperfect separation of the units, continued indefinitely, we can understand the formation of hydroid colonies, such as the zoophytes. In such cases the colony is usually supported by an organic sheath (*perisarc*) of varying complexity.

But the members of such a colony do not usually remain similar and equivalent. In *Hydractinia*, for example, which often grows on a Gastropod shell tenanted by a hermit-crab, the colony consists of polyps of varied structure and function. Some of the polyps are nutritive "persons," like *Hydra* in appearance; some are reproductive "persons," with rudimentary tentacles, with or without a mouth; others



FIG. 66.—Colony of *Hydractinia* on back of a *Buccinum* shell tenanted by a hermit-crab.

are long, slender, mobile, sensitive, often abundantly furnished with stinging cells; while the little protecting spines at the base of the colony may perhaps be abortive "persons." All these polyps are united by connecting canals at the base. Thus *Hydractinia* exhibits *polymorphism* among the members of the colony, and a tendency towards more or less division of labour is common in the Cœlentera.

In most hydroid colonies the division of labour only amounts to *dimorphism*; there are reproductive "persons," different from the ordinary polyps. These are in many cases sessile and mouthless, or they may after a time

become detached and float away as delicate, pulsating swimming-bells. These swimming-bells are male and female, they give rise to male and female elements, and so to embryos, which, after a time, settle down and form new zoophyte colonies. This is an instance of alternation of generations.

Again, just as the predominance of passivity is exhibited in *Hydractinia* and some zoophytes, where the active swimming-bell stage is left out of the life history, so the predominance of activity is exhibited in the permanent medusoids, e.g. *Geryonia*, where the sedentary hydroid stage is omitted, and the embryo becomes at once medusoid. Finally, the medusoids themselves may become colonial, and we have active floating colonies, like those of the Portuguese man-of-war, which show, on a different plane, as much polymorphism as *Hydractinia*.

The same general conclusions apply to the jelly-fish and sea-anemones. The jelly-fish present a strong resemblance to

the medusoids, but are distinguished from them by their usually greater size, as well as by greater complexity and several anatomical differences. It is in accordance with this increased complexity that the alternation of active and passive forms, though as real, is less obvious. But even here we find one type (*Pelagia*) always locomotor, another (*Aurelia*) whose early life is sedentary, and others (Lucernarians) which in their adult life are predominantly passive, and attach themselves by a stalk.

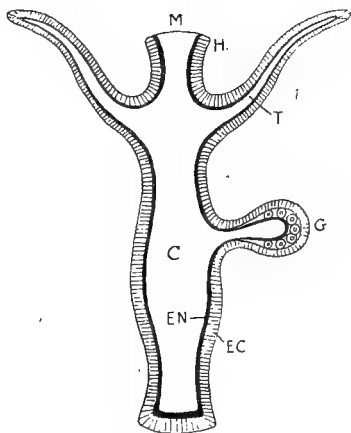

FIG. 67.—Diagram of a typical Hydrozoon polyp.—After Allman.

EC., Ectoderm; EN., endoderm; C., the cavity of the gut (coelenteron); G., a reproductive bud; T., a tentacle; H., hypostome or oral cone; M., mouth.

The sea-anemones and their numerous allies may be regarded as bearing a relation to the jelly-fish, somewhat similar to that which the hydroid polyps bear to the swimming-bells (Fig. 65). They are, however, much more complicated in structure than the hydroids. Solitary forms are much commoner than in the hydroids, but the colonial type is nevertheless very frequent. The colonies may be supported by an organic framework only, but very commonly there is a tendency to accumulate lime in the tissues, which results in the formation of "corals." It should be noted, however, that various quite distinct polypoid types may form "corals." Thus, while the most important reef-building corals are included in the Anthozoa, the Millepore-corals are hydroids.

Finally, as the corals are predominantly passive, so there is a climax of activity in the Ctenophores, which move by cilia united into combs, and often shine with that "phosphorescence" which is an expression of the intensity of life in many active animals.

As to diet, many of the larger forms, *e.g.* sea-anemones and jelly-fish, are able to engulf booty of considerable size; the active Ctenophores are carnivorous, attaching themselves by adhesive cells to one another, or to other small animals; but most Cœlentera feed on small organisms, in seizing and killing which the tentacles and stinging cells are actively used.

Stinging cells or cnidoblasts are so characteristic of Cœlentera that they deserve particular notice. They occur in all Cœlentera except the Ctenophores, and even there they have been detected in *Euchlora rubra*. They also occur in some Turbellarian worms, and in the papillæ of Æolid nudibranchs amongst molluscs; but it has been shown that these animals obtain their nematocysts from the Cœlentera on which they feed. Each cnidoblast contains a capsule or nematocyst, which encloses a coiled lasso lying in an irritant gelatinous substance. The nematocyst fills most of the cell, but there is a nucleus, etc., besides. At the distal end there may be a trigger-like cnidocil or a fringe of bristles, etc. At the proximal end there may be fixing processes. In some Anthozoa the coiled lasso is simply ruptured out, but in most cases it is evaginated. The basal part of the lasso is often stronger than the rest, and may bear stiletts; spirally arranged roughnesses and bristles are also frequent on the thread itself. The explosion of the cnidoblast is believed to be due to an entrance of water, which causes the gelatinous substance to swell up. According to others, the cnidoblast contracts as a whole. The action of the

threads is mechanical and chemical. They fix, *e.g.* by the stilets, into the victim, and the secretion poisons the wound, paralysing or killing small animals, and sometimes acting as a solvent. Many seem to be prehensile threads rather than weapons.

TYPES OF CŒLENTERA

First Type—HYDRA, a simple representative of the Class HYDROZOA

General life.—The genus *Hydra*—cosmopolitan, like many other small fresh-water animals—is represented by several species, *e.g.* the green *Hydra viridis*, the brownish *H. oligactis* or *fusca*, and the orange *H. vulgaris* or *grisea*, widely distributed in fresh water. They are among the simplest of Cœlentera, for the body is but a two-layered tube, with a crown of (6–10) hollow tentacles around the mouth, and with no organs except those concerned in reproduction. The body is usually fixed by its base to some aquatic plant, often to the lower surface of a duckweed. It may measure $\frac{1}{4}$ – $\frac{1}{2}$ inch in length, but it is as thin as a needle, and contracts into a minute knob.

The animal sways its body and tentacles in the water, and it can also loosen its base, lift itself up by its tentacles, stand on its head, or creep by looping movements. According to some observers, its movements are helped by fine pointed pseudopodia protruded from the ectoderm cells of the tentacles and base, and by threads ejected from large cylindrical stinging cells. Usually, however, the *Hydra* prefers a quiet life. It feeds on small animals, which are paralysed or killed by stinging cells on the tentacles, and are swept into the tubular cavity of the body by the action of flagella on the internal cells. Sometimes animals as large as water-fleas (*e.g.* *Daphnia*) are caught, and the *Hydra* may sometimes be seen struggling fiercely with a small Annelid worm (*Tubifex*). Infusorians (*Euplotes*,

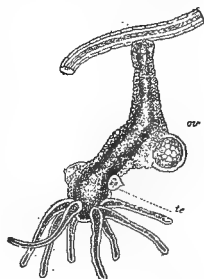

FIG. 68.—Hydra hanging from water-weed.
—After Greene.

ov., Ovary; t., testes.

etc.) are often seen wandering to and fro on the surface of the *Hydra*, but these wonted visitors do not provoke the stinging cells to action.

So simple is *Hydra*, that a cut-off fragment may grow into an entire animal. Thus the *Hydra* may be multiplied by being cut in pieces. The two conditions of a fragment regenerating a whole are—(1) that the fragment be not too small, and (2) that it be a fair sample of the various kinds of cells in the body. Thus neither a little corner off the base nor the tip of a tentacle will grow into a new *Hydra*. If the animal be turned inside out (a delicate operation), the *status quo* is soon restored. The Abbé Trembley, who first made this experiment, thought that the out-turned endoderm assumed the characters of the ectoderm, and that the inturned ectoderm assumed the characters of endoderm. But this is not the case. Either the animal rapidly rights itself by turning outside in, or, if this be prevented, the inturned ectoderm disappears internally, and by growing over the out-turned endoderm, from the lips downwards, restores the normal state.

In favourable nutritive conditions, the *Hydra* forms buds, and on these a second generation of buds may be developed. A check to nutrition or some other influence causes the buds to be set adrift. Sometimes a *Hydra* divides across the middle, and each half grows into a complete polyp in a few days. Besides these asexual modes of multiplication, the usual sexual reproduction occurs.

General structure.—The tubular body consists of two layers of cells, *i.e.* the animal is diploblastic. The cavity is the gut, and it is continued into the hollow tentacles. These, when fully extended, may be much longer than the body. The mouth is slightly raised on a disc or hypostome. Of the two layers of cells, the outer or ectoderm is transparent, the inner or endoderm usually contains abundant pigment. On the tentacles especially, even with low power, one can see numerous clumps of clear stinging cells. The male organs appear as ectodermic protuberances a short distance below the bases of the tentacles; the ovary, with a single ovum, is a larger bulging farther down. Both male and female organs may occur on the same animal, either at one time or at different times, but often they occur on

different individuals. Abundant food favours the development of female forms; when food is scarce males are more abundant. The buds have the same structure as the parent body; in origin they appear to be mainly due to multiplication of interstitial cells.

Minute structure.—The outer layer or ectoderm includes the following different kinds of cells:—

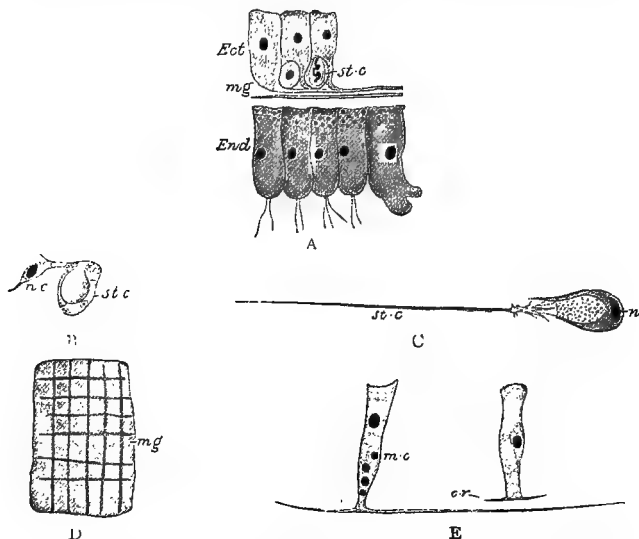

FIG. 69.—Minute structure of *Hydra*.—After T. J. Parker and Jickeli.

- A. *Ect.*, ectoderm; *mg.*, mesogloea; *st.c.* stinging cell; *End.*, endoderm with flagella and amoeboid processes.
- B. *n.c.*, nerve cell, and *st.c.*, stinging cell.
- C. Stinging cell with ejected thread; *n.*, nucleus.
- D. Mesogloea (*mg.*) with contractile roots resting on it.
- E. *m.c.*, muscular cell with contractile roots, *c.r.*

(1) Large covering or epithelial cells, within or between some of which lie the stinging cells. The epithelial cells are somewhat conical, broader externally than internally, and in the interspaces lie interstitial cells. By certain methods, a thin shred can be peeled off the external surface of the ectoderm cells. This is a *cuticle*, *i.e.* a pellicle no longer living, produced by the underlying cells.

(1a) Many of these large cells have contractile basal processes, or roots, running parallel to the long axis of the body, and lying on a

middle lamina which separates ectoderm from endoderm (Fig. 69, E). The cells themselves are contractile, but there is special contractility in the roots. Like the muscle cells of higher animals, they contract under certain stimuli, and are often called "neuro-muscular." But the presence of special nerve cells shows that even in *Hydra* there is a differentiation of the two functions of contractility and irritability.

(2) Stinging cells or cnidoblasts occur abundantly on the upper parts of the body, especially on the tentacles. Each contains a protrusible nematocyst. This consists of a sac, the neck of which is doubled in as a pouch, usually bearing internal barbs, and prolonged into a long, hollow, spirally coiled filament or lasso. This lasso is bathed in a fluid, presumably poisonous. On its free surface the stinging cell usually bears a delicate trigger hair or cnidocil. Under stimulus, whether directly from the outside or from a nerve cell, the cnidoblast explodes and the nematocyst is thrown out. With the help of the barbs they penetrate through even a chitinous membrane, and the secreted fluid has a solvent action. The victim is held fast and drawn closer. Besides the ordinary stinging cells, there are others of small size which coil into a spiral after explosion.

(3) There is to the inner aspect of the covering cells a network of ganglion cells and nerve processes. More superficially there are minute sensory cells, some of them connected by fine fibres with the ganglion cells.

(4) Small interstitial or indifferent units fill up chinks in the ectoderm, and seem to grow into reproductive, stinging, and other cells.

(5) Granular glandular cells on the basal disc or "foot" probably secrete a glutinous substance. They are also said to put out pseudopodia, and so move the animal slowly.

The endoderm is less varied. Its cells are pigmented, often vacuolated, and most of them are either flagellate or amoeboid. The pigment bodies in *H. viridis* are like the chlorophyll corpuscles of plants; it seems almost certain that they are unicellular Algæ. When a green *Hydra* liberates an egg while kept in the dark, that egg gives rise to a white *Hydra*, which is supposed to imply that the partner Algæ do not migrate into the egg when there is no light. In the other species of *Hydra*, the pigment is quite different from chlorophyll. The active lashing of the flagella causes currents which waft food in and waste out. If some small animal, stung by the tentacles, is thus wafted in, it may be directly engulfed by the amoeboid processes of some of the cells, and it has been noticed that the same cell may be at one time flagellate and at another time amoeboid (cf. the cell-cycle, p. 107). After this direct absorption the food is digested within the cells, and while some of the dark granules seen in those cells may be decomposed pigment bodies, others seem to be particles of indigestible débris. Thus *Hydra* illustrates what is called intracellular digestion, such as occurs in Sponges, some other Cœlentera, and some simple "worms." But experiments show that some of the food may be digested in the gut cavity, and subsequently absorbed. Thus it seems that both intracellular and extracellular digestion occur.

Some of the endoderm cells have muscular roots like those of the ectoderm. They lie on the inner side of the middle lamina, in a trans-

verse or circular direction. A few cells near the mouth and base are described as glandular, and the presence of a few stinging cells has been recorded, though some suggest that the last are discharged ectodermic nematocysts which have been swallowed.

The middle lamina, representing the mesogloea, is a thin homogeneous plate, bearing on its outer and inner surfaces the muscular roots of ectodermic and endodermic cells (Fig. 69, D).

It is historically interesting to notice the important step which was made when, in 1849, Huxley definitely compared the outer and inner layers of the Cœlentera with the epiblast and hypoblast which embryologists were beginning to demonstrate in the development of higher animals. Not long afterwards, Allman applied to the two layers of hydroids the terms ectoderm and endoderm.

The division of labour among the cells of *Hydra* is not very strict, but already the essential characteristics of ectoderm and endoderm are evident. We may summarise these as follows, comparing them with the characteristics of epiblast and hypoblast in higher animals :—

OUTER LAYER.	MIDDLE LAYER.	INNER LAYER.
In <i>Hydra</i> the ectoderm forms— Covering cells, stinging cells, nerve cells, muscle cells, etc.	None in <i>Hydra</i> , apart from the middle lamella.	In <i>Hydra</i> the endoderm forms— Digestive cells lining the food canal, and also muscle cells, etc.
The embryonic epiblast of higher animals grows into epidermis, nervous system, and essential parts of sense organs.	The mesoblast of higher animals becomes muscular, connective, and skeletal tissue.	The embryonic hypoblast of higher animals always lines the digestive part of the food canal.

The reproductive organs.—(a) From nests of repeatedly dividing interstitial cells, several (1–20) simple male organs or testes are formed. Each consists merely of a clump of male elements or spermatozoa, bounded by the distended ectoderm. Through this the spermatozoa are extruded at intervals, and one may fertilise the ovum of the *Hydra*. In other words, self-fertilisation, which is very rare among animals, may occur. The spermatozoon is a motile cell, with a minute cylindrical “head” consisting of nucleus, a more minute middle-piece, and a long thread-like vibratile tail (Fig. 70, 1).

(b) Usually there is but one female organ or ovary, but in *H. fusca* as many as eight have sometimes been observed. The ovary arises, like the testes, from a nest of interstitial cells, in the centre of which, distinct from the rest, the single ovum lies. In rare cases in *H. viridis*, *H. fusca*, and *H. grisea* there are two ova; in *H. divicia* there may be several.

Development.—The ovum of *Hydra* is the successful central cell in the ovary. It is at first amœboid, and becomes more and more rich at the expense of its neighbours. Their remains (perhaps nuclei)

accumulate within the ovum as "yolk spherules" or "pseudo-cells." Some yolk-granules, formed within the ovum, may coalesce in "pseudo-cells" of another type. With increase of size the ovum changes its form from amoeboid to cake-like, and from that to spherical. Around the spherical ovum a gelatinous sheath is formed. When the limit of growth is reached, the nucleus or germinal vesicle divides twice, and two polar bodies are extruded at the distal pole. There are twelve chromosomes to begin with, and by the reduction division in forming the first polar body, the number is reduced to six. Thereafter the ectoderm of the parent *Hydra* yields to the increasing strain put upon it, and

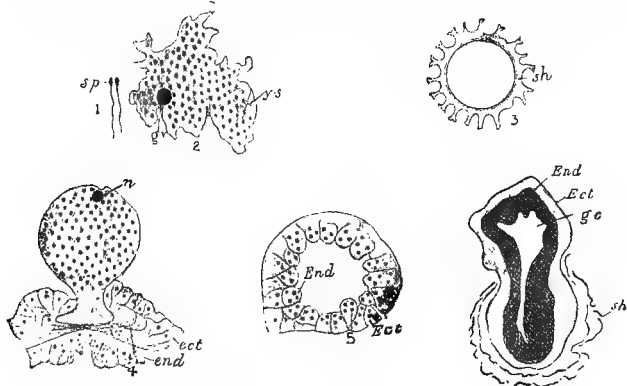

FIG. 70.—Development of *Hydra*.—After Brauer.

1. *sp.*, spermatozoa.
2. Amoeboid ovum; *g.v.*, germinal vesicle or nucleus; *y.s.*, yolk spherules.
3. Ovum with lobed envelope (*sh.*) around it.
4. Ovum protruding; *n.*, the nucleus; *ect.*, the ruptured ectoderm; *end.*, the endoderm.
5. Section of blastosphere—*Ect.*, ectoderm; *End.*, endoderm—being formed.
6. Section of larva. *Ect.*, ectoderm; *End.*, endoderm; *g.c.*, gut cavity; *sh.*, ruptured envelopes.

ruptures, allowing the ovum to protrude. By a broad base it still remains, however, attached to the parent, and in this state it is fertilised, the spermatozoon entering by the distal pole (Fig. 70, 4).

The segmentation which follows is total and equal, and results in the formation of a blastosphere (Fig. 70, 5). By inwandering, or by division of the cells of the blastosphere, an internal endoderm is formed, and this formation takes place on all sides. In a word, it is multipolar. The segmentation cavity of the blastosphere is thus filled up, and the two layers become differentiated from one another.

The outer or ectodermic layer forms—(a) an external "chitinoid" shell of several layers; (b) an internal membrane, homogeneous, thin,

and elastic; and (c) the future ectoderm of the adult. In *Hydra fusca* the egg is separated from the parent before the shell is formed, and is fastened by its gelatinous sheath to aquatic plants; in *H. viridis* and *H. grisea* the egg falls off after the outer shell has been formed. In all species the separation from the parent appears to be followed by a period of quiescence lasting from one to two months. It is probable that this resting-stage is carried by wind and birds from one water basin to another.

Within the shell differentiation at length recommences, but it proceeds slowly. Interstitial cells arise in the ectoderm; a middle lamella is formed; a gastric cavity begins to appear in the midst of the endoderm. Thereafter the shell bursts, and development proceeds more rapidly. The embryo elongates, acquires a mouth by rupture at the distal (sometimes called vegetative) pole. The inner sheath is also lost, and the young *Hydra* fixes itself and begins to live as its parent or parents did.

Forms like Hydra.—Even simpler than *Hydra* is *Protohydra*, without tentacles, occurring both in the sea and in fresh water. An American fresh-water form (*Microhydra ryderi*) is known to liberate free-swimming medusoids. A fresh-water Medusoid *Limnocodium* was found in the Victoria Regia tanks in the Botanic Gardens, Regent's Park, London. Its native habitat is unknown. Another species, *L. kawaii*, has been found in the Jantszekiang in China, 1000 miles from its mouth. A related form, *Limnocnida*, occurs in Lakes Tanganyika and Victoria Nyanza, and in the river Niger. A strange simple polype—*Polypodium*—has been found as a parasite on the eggs of sturgeons. Further details in regard to all these forms are much wanted.

Second Type of CŒLENTERA.—A Medusoid. Class HYDROZOA

Hydra is too simple to be thoroughly typical of the Hydrozoa. The class includes the hydroid colonies or zoophytes, which may be compared to *Hydræ* with many buds, and also free medusoid forms, which may be (a) liberated members of a hydroid colony, or (b) independent organisms. Besides these there are complex colonies of medusoid forms (Siphonophora).

The hydroid type, except in minor details, usually resembles *Hydra*. In some cases the tentacles are solid, instead of hollow as in *Hydra*, and they may be arranged in two circles,—an outer and an inner (e.g. *Tubularia*). In some of the hydroid colonies, notably the Millepores and *Hydractinia*, the polyps are very dissimilar to one another, and have become specialised for the performance of different functions.

The medusoid type is like an inflated hydroid adapted for swimming. It is bell-shaped, and down the middle of the bell hangs a prolongation—the manubrium—which terminates in the mouth. Around the margin of the bell there is a little shelf, the velum or craspedon, which projects inwards, and is furnished with muscle cells. The margin of

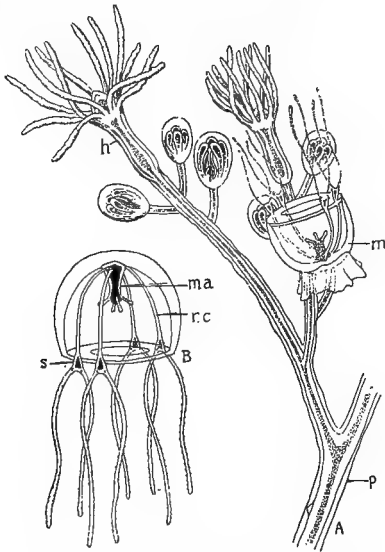

FIG. 71.—Bougainvillea.—After Allman.

A. A small piece of a hydroid colony.

h., Perisarc; *m.*, medusoid bud; *h.*, hydranth or polyp head.

B. A medusoid; *ma.*, manubrium; *r.c.*, radial canal; *s.*, sense organ.

the bell also bears tentacles, usually hollow, and abundantly furnished with stinging cells (Fig. 65, 3).

On the convex surface of the bell the ectoderm forms simply an epithelial layer; on the concave surface it is differentiated into muscle cells on the velum, the manubrium, and the tentacles, nerve cells at the base of the velum, and stinging cells on the tentacles. The endoderm is ciliated; it lines the food canal, and extends also into the

tentacles. The mesogloea forms a thickened jelly, present more especially on the convex (ex-umbrellar) surface.

The mouth opens into the canal of the manubrium, which leads to the central cavity of the dome. With this a varying number of unbranched radial canals communicate; these open into a marginal circular vessel, which communicates with the cavities of the tentacles. A plate of endoderm lies in the mesogloea between the radial canals. Digestion is intracellular, and probably goes on throughout the whole of this "gastro-vascular" system.

The movements of the bell are caused by the contractions of the ectodermic muscle cells.

The nervous system consists of a double ring of nerve fibres around the margin of the bell. With these are associated ganglionic cells, which apparently control the muscular contractions.

Sense organs may be present, in the form of "eyes," at the base of the tentacles (Ocellatæ), or in the form of "auditory" vesicles developed as pits in the velum (Vesiculatæ).

The reproductive organs develop either in the manubrium or on the radial canals. The products always (?) ripen in the ectoderm, and often seem to arise there; but Weismann and others have shown that the reproductive cells of a medusoid derived from a hydroid, or of the reduced and fixed reproductive persons of many hydroids, have considerable powers of migration, and may originate (sometimes in the endoderm) in the hydroid colony at some distance from the place where they are matured within the medusoid bud. The sexes are usually separate. The commonest kind of free-swimming larva is the planula, which is oval, ciliated, and diploblastic, devoid of an opening, and usually without a central cavity. In the case of those medusoids which arise as liberated sexual members of

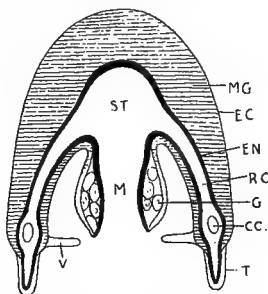

FIG. 72.—Structure of a Medusoid.—After Allman.

ST., Stomach; M., manubrium; V., velum; T., tentacle; C.C., circumference canal; G., gonad; R.C., radial canal; EN., endoderm; EC., ectoderm; MG, mesogloea.

a fixed asexual hydroid colony, the planula settles down, loses its cilia, buds out tentacles, and develops into a new hydroid.

In many hydroid colonies, as has been already noticed, the sexual members are not set free, but remain as buds attached to the parent. These fixed "gonophores" show many stages of degeneration; some, notably in the floating colonies of Siphonophora, differ little structurally from true medusoids, while others, as in *Hydractinia*, are simply small closed sacs enclosing the genital products (Fig. 87).

Third Type of CŒLENTERA.—The common Jelly-fish
—*Aurelia aurita*. Class SCYPHOMEDUSÆ

This Medusa is almost cosmopolitan, and in the summer months occurs abundantly around the British coasts. It swims by pulsating its disc, and also drifts along at rest without any pulsations. They often occur in great shoals, and hundreds may be seen stranded on a small area of flat sandy beach. The glassy disc usually measures about four inches in diameter, but may be twice as large. The jelly-fish feeds on small animals, such as copepod crustaceans, which are entangled and stung to death by the long lips.

External appearance.—The animal consists of a gelatinous disc, slightly convex on its upper (ex-umbrellar) surface, and bearing on the centre of the other (sub-umbrellar) surface a four-cornered mouth, with four long much-frilled lips. The circumference of the disc is fringed by numerous short hollow tentacles, by little lappets, and by a continuation of the sub-umbrella forming a delicate flap or *velarium*. Conspicuously bright are the four reproductive organs, which lie towards the under surface. Nor is it difficult to see the numerous canals which radiate from the central stomach across the disc, the eight marginal sense organs, and the muscle strands on the lower surface (Fig. 73).

The three layers.—The ectoderm which covers the external surface bears stinging cells, sensory and nerve cells, and muscle cells. The ectoderm seems also to be invaginated to form the gullet or stomodæum. The endoderm lines the digestive cavity, is continued out into its radiating

canals, and is ciliated throughout. The mesogloea is a gelatinous coagulation containing wandering amœboid cells from the endoderm. The whole animal is very watery; indeed, the solid parts amount to not more than 10 per cent. of the total weight. Yet some jelly-fish (species of *Rhopilema*) are used as food in Japan!

Nervous system.—The nervous system consists—(a) of a special area of nervous epithelium, associated with each of the eight sense organs, and (b) of numerous much-elongated bipolar ganglion cells lying beneath the epithelium on the under surface of the disc. This condition should be con-

trasted with the double nerve-ring in Craspedote medusoids, but too much must not be made of the contrast, for a nerve-ring is described in Cubomedusæ, one of the orders of Acraspedote jelly-fish. In *Aurelia* the sense organs are less differentiated than in many other jelly-fish. Each of the eight organs, protected in a marginal niche, consists of a pigmented spot, a club-shaped projection with numerous calcareous "otoliths" in its cells, and a couple of apparently sensitive pits or grooves. The sense organs arise as modifications of tentacles, and are often called "tentaculocysts" or "rhopalia." Their cavities are in free communication with branches of the radial canals.

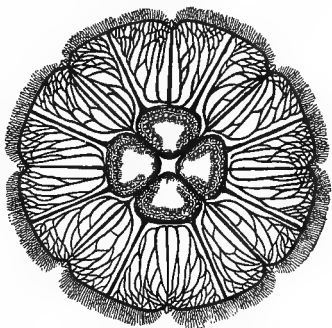

FIG. 73.—Surface view of *Aurelia*.—
From Romanes.

Showing four genital pockets in centre, much branched radial canals, eight peripheral niches for sense organs, and peripheral tentacles.

Muscular system.—Between the plexus of nerve cells and the sub-umbrellar mesogloea there are cross-striped muscle fibres, each of which has a large portion of non-contractile cell substance attached to it. They lie in ring-like bundles, and by their contractions the medusa moves. Unstriped muscle fibres are found about the tentacles and lips.

Alimentary system.—The four corners of the mouth are extended as four much-frilled lips, each with a ciliated groove and stinging cells, and with an axis of mesogloea. They exhibit considerable mobility. Their crumpled and mobile bases surround and almost conceal the mouth. A short gullet or “manubrium” connects the mouth with the digestive cavity in the centre of the disc. From this central chamber sixteen gastro-vascular canals of approximately equal calibre radiate to the circumference, where they open into a circular canal, with which the hollow tentacles are connected. Eight of the radial canals are straight, but the other eight are branched, and thus in an adult *Aurelia* the total number of canals is large. These canals are really due to a partial obliteration of the gastric cavity by a fusion of its ex-umbrellar and sub-umbrellar walls along definite lines. They are all lined by ciliated endoderm.

Where the gullet passes into the central digestive cavity, there are four strong pillars of thickened sub-umbrellar material. Beside these pillars, there are four patches where the sub-umbrellar surface remains thin. These are the gastro-genital membranes, lined internally by germinal epithelium (Fig. 74, *R.*).

To the inside of these genital organs, within the digestive cavity, are four groups of mobile gastric filaments (*g.f.*, Fig. 74), which are very characteristic of jelly-fish. In appearance these are very similar to the small tentacles of the margin, and, like them, are hollow. They are covered with endoderm—with ciliated, glandular, muscular, and stinging cells.

The body is mapped out into regions by the following convention: The first tentacles to appear in the larva are four in number, and correspond to the four angles of the mouth; the radii on which they appear are called “perradial,” marked by the four lips. Half-way between these, four “interradials” are then developed, marked by the gonads and gastric filaments. Then eight “adradials” may follow, between perradii and interradii, marked by the eight unbranched radial canals.

Reproductive system.—The sexes are separate. The reproductive organs—ovaries or testes—consist of plaited ridges of germinal epithelium, situated on the four patches already mentioned, within sacs which are derived from and

communicate with the floor of the gastric cavity. They are of a reddish violet colour, and at first of a horseshoe shape, with the closed part of the curve directed outwards. Afterwards the ridges become circular, and surround the walls of the sacs in which they lie. But the sub-umbrellar surface is modified beneath each genital sac in such a way that the sac comes to lie in a sub-genital cavity communicating with the exterior (*g.p.*, Fig. 74). The contractions of the umbrella produce a rhythmic movement of the water which enters the sub-genital cavities, and this constant renewal of the water suggests some respiratory significance for the sacs. The genital sacs containing the plaited ridges of germinal epithelium communicate with the gastric cavity only, while the sub-genital cavities containing water and enveloping the genital sacs communicate with the exterior only.

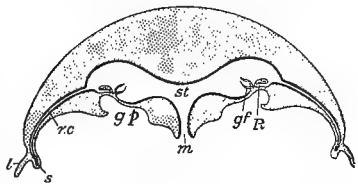

FIG. 74.—Vertical section of *Aurelia*.—After Claus.

The ova and spermatozoa pass from the frills of germinal epithelium into the sacs, and thence into the gastric cavity. They find exit by the mouth, but young embryos may be found swimming in the gastro-vascular canals, and also within the shelter of the long lips.

m., Mouth; *st.*, stomach; *r.c.*, radial canal; *R.*, reproductive organs; *g.f.*, gastric filaments; *g.p.*, sub-genital cavity; *L.*, marginal tentacle; *s.*, sense organ; the shaded part is mesogloea.

Variations.—The jelly-fish often exhibits *variations, i.e.* inborn changes of germinal origin which result in the organism being different from the norm or average of its species. It is normally tetrapartite, but sexpartite, pentapartite, and, more rarely, tripartite forms occur; and the detailed variations are manifold.

Life history of Aurelia.—The fertilised ovum divides completely, but not quite equally, to form a blastosphere, with a very narrow slit-like cavity. From the larger-celled hemisphere, single cells migrate into the cavity, and fill this up with a solid mass of endoderm. The archenteron arises as a central cleft in this cell mass, and opens to the exterior temporarily by the primitive mouth. During these

processes the embryo elongates, the outer cells become ciliated, and the mouth closes. Thus the embryo becomes a free-swimming oval *planula*.

After a short period of free life, this planula settles down on a stone or seaweed, attaching itself by the pole where the mouth formerly opened. At a very early stage the mesogloea appears between the two layers. At the free pole an ectodermic invagination next occurs, an opening breaks through at its lower end, and thus a gullet lined with ectoderm is formed, which hangs freely in the general cavity. During this process there are formed first two and then four diverticula of the

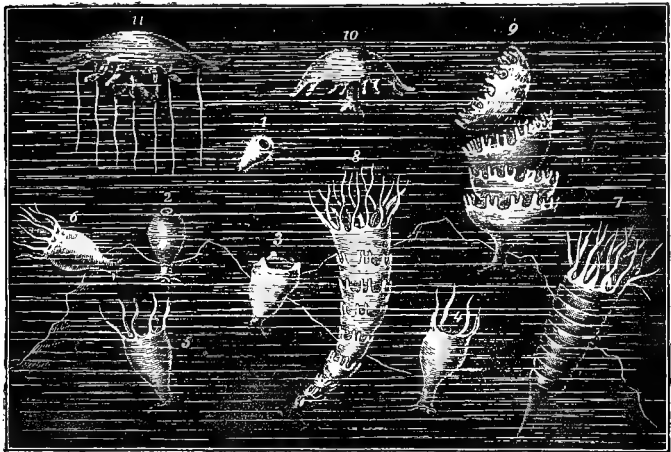

FIG. 75.—Diagram of life history of *Aurelia*.—After Haeckel.

1. Free-swimming embryo; 2-6, various stages of Hydra-tuba; 7, 8, Strobila stage; 9, liberation of Ephyrae; 10, 11, growth of Ephyrae into Medusæ.

general cavity, which are arranged round the gullet above, and open freely into the digestive cavity below. In the gullet region these are separated by broad septa, which are continued into the lower region of the body as four interradial ridges or tæniolæ. The tentacles bud out from the region of the mouth, the first four corresponding in position to the four pouches. Interradially above the four septa, four narrow funnel-shaped invaginations arise; these are produced by the ingrowth of ectoderm, which then forms the muscle fibres which run down the tæniolæ (contrast the *endodermic* muscles of Anthozoa). In contrasting this development with that of the hydroid polyp, Goette specially

emphasises the fact that the radial symmetry is first indicated by the gut pockets, and the tentacles are late in development. Goette describes a quite similar process of development in certain sea-anemones, and claims to have found there rudiments of septal pockets and ectodermal muscles, thus confirming his view of the intimate relation between the Anthozoa and Scyphomedusæ.

The larva now forms a "Hydra-tuba" or "Scyphistoma"; it is about an eighth of an inch in height. By lateral budding, or by the formation of creeping stolons, it may give rise to larvæ like itself. The gradual widening of the central cavity renders the gullet tube less obvious, and results in an increasing resemblance to the medusa type.

In late autumn, however, a more fundamental change occurs in the history of the Hydra-tuba. (a) Occasionally, as has been observed by Haeckel, the Scyphistoma becomes detached and converted into a free-swimming Ephyra, which in turn becomes a jelly-fish. (b) Sometimes, in unfavourable conditions, a furrow appears round the upper region of the Scyphistoma, the upper portion is converted into an Ephyra, and floats away, while the lower portion re-forms its oral region by regeneration, and produces another Ephyra. (c) In ordinary conditions the Scyphistoma elongates, and displays a succession of annular constrictions. This stage, often compared to a pile of discs or saucers, is called a Strobila. Each disc is separated off in its turn as a free-swimming Ephyra, which becomes a jelly-fish. The still undivided basal portion may rest for a time, and then undergo further constriction. This is probably an abbreviation of the primitive mode of development.

In the conversion of the Scyphistoma into the Ephyræ, the diverticula coalesce into a general cavity, the entrances to the septal invaginations probably persist as the sub-genital pits, the gastric filaments sprout out from the remains of the septa, and so mark the place where the ectodermal gullet passed into the endodermal cavity.

The first Ephyra differs from those which come after it in bearing the original tentacles of the Hydra-tuba. From its margin eight bifid lobes grow out, each embracing the base of a perradial or interradial tentacle. The bases of these eight tentacles become the sense organs or rhopalia. The other eight adradial tentacles atrophy. On the Ephyræ which follow there are at first no tentacles, only the eight bifid marginal lobes which bear the sense organs in their niches.

This development illustrates alternation of generations. From the fertilised ovum a fixed asexual Scyphistoma results. This grows into a Strobila, from which transverse buds or Ephyræ are liberated. Each of these grows into a sexual jelly-fish, producing ova or spermatozoa.

Relatives of Aurelia.—The Medusæ, or true jelly-fish, include forms which agree with the Anthozoa in relative complexity of structure as compared with Hydrozoa, and in the possession of an ectodermal gullet, but differ in possessing ectodermal septal muscles and in some histological features. If Goette's discovery of rudimentary ectodermal muscles in the larvæ of certain sea-anemones be confirmed, however, it would greatly increase the probability of a close relationship between the two sets. Among the Scyphomedusæ

closely allied to *Aurelia* some, e.g. *Pelagia*, have a direct development without the intervention of Scyphistoma or Strobila stages, but this may occur exceptionally in *Aurelia*. *Cyanea* is often very large,

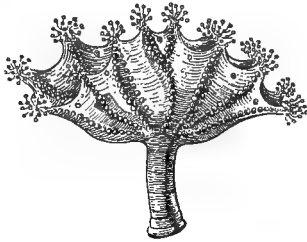

FIG. 76.—*Lucernaria*.—After Korotneff.

“it may measure $7\frac{1}{2}$ ft. across the bell, with tentacles 120 ft. long.” *Chrysaora* is hermaphrodite, and has diffuse sperm sacs even upon the arms. In the Rhizostomæ, e.g. *Cassiopeia* and *Pilema*, the

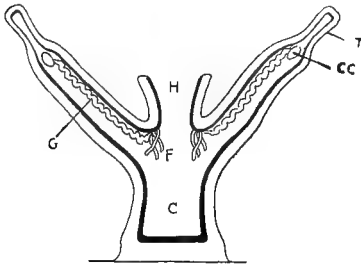

FIG. 77.—Diagram of *Lucernaria*.—
After Allman.

C., Cavity of gut (coelenteron); F., gastric filaments; H., hypostome; G., gonad; T., tentacle; c c., circumference canal.

mouth is obliterated, and replaced by numerous small pores on the four double arms. *Lucernaria* and its allies are interesting sessile forms which have been compared to sexual Scyphistomas, that is, are regarded as persistently larval forms.

Contrast between Medusoids (Hydromedusæ) and Medusæ (Scyphomedusæ)

MEDUSOIDS. (CRASPEDOTA.)	MEDUSÆ. (ACRASPEDA.)
The majority are small "swimming-bells."	Many are large "jelly-fish."
A flap or velum (craspedon) projects inwards from the margin of the bell.	No velum. (The velarium of Aurelia is a mere fringe, very inconspicuous in the adult, and not inturred.)
No tæniolæ, nor gastric filaments.	In the Scyphistoma there are four tæniolæ, from part of which the gastric filaments of the adult grow.
A double nerve-ring around the margin.	Eight separate nervous centres beside the sense organs, and a sub-umbrellar nervous plexus.
Naked sense organs either optic or auditory. They are usually derived from the skin, but the auditory sacs may be modified tentacles.	Sense organs are modified tentacles, and probably have almost always a triple function. They are usually protected by a hood.
Reproductive organs on the radial canals or by the side of the manubrium. The reproductive cells are usually derived from the ectoderm.	Reproductive organs in special pockets on the floor of the gastric cavity. The reproductive cells arise in the endoderm.
With the exception of the Trachymedusæ, all arise as the liberated reproductive persons of hydroid colonies.	Have no connection with hydroids, but may have a small sedentary polyp stage (or Scyphistoma) in the course of their life history. Probably more nearly related to Anthozoa than to Hydrozoa.

Fourth Type of CŒLENTERA.—A Sea-Anemone, such as *Tealia crassicornis*. Class ANTHOZOA

Most sea-anemones live fixed to the rocks about low-water mark. All these fixed forms have a distinct basal disc, and may, like *Tealia crassicornis*, be half buried in sand and gravel; others, without a basal disc, are loosely inserted in the sand, e.g. *Edwardsia* and *Cerianthus*. All are able to shift their positions by short stages. Some reef-anemones (*Cradactis*) can crawl about on their tentacles. They feed on small animals—molluscs, crustaceans, worms—which are caught and stung by the tentacles. Many depend on minute organisms; others may be seen trying to engulf molluscs decidedly too large for them. A few anemones, without pigment or with little, have symbiotic Algæ in their endoderm cells; the bright pigments of many others seem to help in respiration. Besides the sexual reproduction (in which the young are

sometimes developed within the parent), some sea-anemones also multiply asexually by detaching portions from near the base, and fission occurs in a few forms.

External appearance of a fixed Anemone. — The cylindrical body is fixed by a broad base; it bears whorls of hollow tentacles around the oral disc; the mouth is usually a longitudinal slit. The tentacles are contracted when the animal is irritated, and the whole body can be much reduced in size. Just below the margin of the oral disc there is a powerful sphincter muscle; this contracts,



FIG. 78.—External appearance of *Tealia crassicornis*.

and pulls together the body wall over the mouth and retracted tentacles. Water may pass out gently or otherwise by a pore at the tip of each tentacle, and long white threads, richly covered with stinging cells, can be ejected in many anemones through the walls of the body (Fig. 79).

General structure. — The Anthozoon polyp differs markedly from the Hydroid polyp—not only because an invagination from the oral disc inwards has formed a gullet tube, which hangs down into the general cavity, but also because a number of partitions or mesenteries extend from the body wall towards this gullet. Some of the partitions are “complete,” *i.e.* they reach the gullet; others are “in-

complete," *i.e.* do not extend so far inwards. The complete mesenteries are attached to the oral disc above, to the side of the gullet, and to the base, and all the mesenteries are ingrowths of the body wall. The cavity of the anemone is thus divided into a number (some multiple of six) of radial chambers. These are in communication at the base, so that food particles from the gullet may pass into any of the chambers between the partitions. Moreover, each partition is perforated, not far from the mouth, by a pore, besides which there is often another nearer the body wall. The tentacles are continuous with the cavities between the mesenteries, and thus all the parts of the body are in communication. The mouth is usually a longitudinal slit, and its two corners are often richly ciliated. The gullet is marked with longitudinal grooves, two of which, the "siphonoglyphes," correspond to the corners of the mouth, and are especially broad and deep. Along these two grooves, and by these two corners, food particles usually pass in; but in some, one side is an incurrent, the other an excurrent channel. Occasionally only one corner of the mouth and side of the gullet is thus modified. The gullet often extends far down into the cavity of the anemone. It admits of a certain amount of extrusion. The mesenteries bear—(a) mesenteric filaments; (b) retractor muscles; (c)

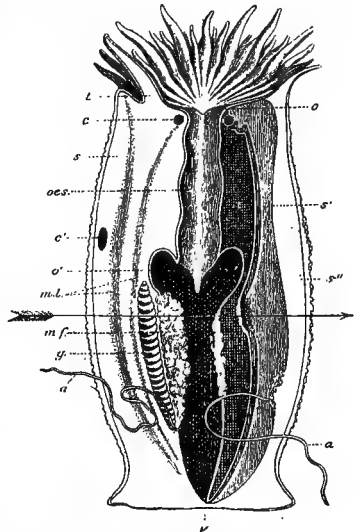

FIG. 79.—Vertical section of a sea-anemone.—After Andres.

t., Tentacles; *o.*, mouth; *oes.*, oesophagus; *c.*, *c'*., apertures through a mesentery; *a.*, *a'*., acoelia; *g.*, genital organs on mesentery; *m.f.*, mesenteric filaments; *m.l.*, longitudinal muscles; *s.*, primary septum or mesentery; *s'*., secondary septum; *s''.*, tertiary septum; *v.*, basal disc.

usually pass in; but in some, one side is an incurrent, the other an excurrent channel. Occasionally only one corner of the mouth and side of the gullet is thus modified. The gullet often extends far down into the cavity of the anemone. It admits of a certain amount of extrusion. The mesenteries bear—(a) mesenteric filaments; (b) retractor muscles; (c)

ridges of reproductive cells, almost always either ova or spermatozoa, rarely both; and (*d*) in some cases offensive threads or acontia. The mesenteric filaments seem to be closely applied to the food, and perhaps secrete digestive juice. Intracellular digestion also occurs. Sea-anemones have no sense organs; the sapphire beads, which are so well seen at the bases of the outermost tentacles of the common *Actinia mesembryanthemum*, are batteries of stinging cells. The nervous system is uncentralised, and

consists of superficial sensory cells connected with a plexus of sub-epithelial ganglion cells.

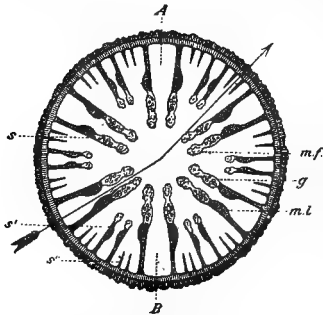

FIG. 80.—Section through sea-anemone (across arrow in Figure 79).—After Andres.

A, B, Directive septa; *m.f.*, mesenteric filaments; *g.*, genital organs; *m.l.*, longitudinal muscles; *s.*, primary septum; *s''*, secondary septum; *s'''*, tertiary septum. The arrow enters between two primary septa (an intra-septal cavity), and passes out between two tertiary septa.

The layers of the body.—

The ectoderm which clothes the exterior is continued down the inside of the gullet. The endoderm lines the whole of the internal cavity, including mesenteries and tentacles. The mesogloea is a supporting plate between these two layers, and forms a basis for their cells.

The ectoderm consists of ciliated, sensory, stinging, and glandular cells, and also of sub-epithelial muscle and ganglion cells based on the mesogloea, but mainly restricted to the circum-oral region.

The endoderm consists mainly of flagellate cells, with muscle fibres at their roots. These form the chief muscle bands of the

wall, the mesenteries, and the gullet. Nor are glandular and even sensory cells wanting in the endoderm.

The mesenteries.—In sea-anemones and nearly related Anthozoa, twelve primary mesenteries are first formed. These are grouped in pairs, and the cavity between the members of a pair is called intra-septal, in contrast to the inter-septal cavities between adjacent pairs. In these inter-septal chambers other mesenteries afterwards appear in pairs. Two pairs of mesenteries, however, differ from all the rest—those, namely, which are attached to the two corners of the mouth and to the corresponding grooves of the gullet. These two pairs of mesenteries are called “directive,” and they divide the animal into bilaterally symmetrical halves. Anatomically, a pair of directive mesenteries differs from the other paired mesenteries, because the retractor muscles, which

extend in a vertical ridge along them, are turned away from one another, and run on the inter-septal surfaces, whereas in the other mesenteries the retractor muscles run on the intra-septal surface—those of a pair facing one another. The arrangement of these muscles is of great importance in classifying Anthozoa. It is possible that the mesenteries are homologous with the tæniolæ of jelly-fish, and the mesenteric with the gastric filaments.

From the above description it will be noticed that the fundamental radial symmetry of the Cœlentera has here become profoundly modified.

Development.—Comparatively little is known in regard to the early stages of development in sea-anemones. From the fertilised ovum a blastosphere may result which by invagination becomes a gastrula. In

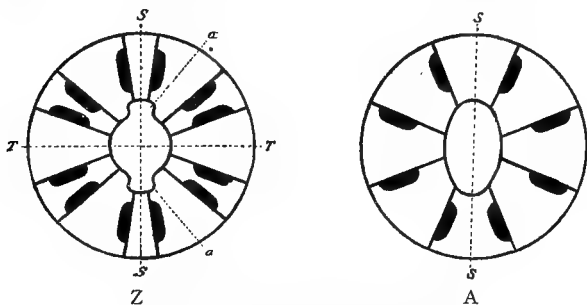

FIG. 81.—Z, Diagrammatic section of Zoantharian; A, of Alcyonarian.—After Chun.

The line S-S in Z is through the siphonoglyphes (a), the line T-T passes through two inter-septal spaces. The retractor muscles are represented by dark thickenings on the mesenteries—all on one (the ventral) side in the Alcyonarian. The line S-S in A represents the axis of symmetry.

some cases the ovum segments into a solid morula; this becomes a free planula, in which a cylindrical depression at one pole forms the mouth and gullet. Or the two layers may be established by a process known as delamination, in which a single layer of cells is divided into an inner endodermic and an outer ectodermic layer. According to Goette, the development is in essentials the same as that of the Hydra-tuba. The larva of Cerianthids is for a time pelagic, and used to be recognised as a distinct genus, *Arachnactis*.

Related forms.—The sea-anemones are classified in the sub-class Anthozoa or Actinozoa, and along with many corals are distinguished as Zoantharia or Hexacoralla from the Alcyonaria or Octocoralla, like *Alcyonium* and the related forms. This contrast is not very satisfactory, but it rests on such distinctions as the following:—

ANTHOZOA OR ACTINOZOA

ZOANTHARIA, HEXACORALLA, <i>e.g.</i> SEA-ANEMONE.	ALCYONARIA, OCTOCORALLA, <i>e.g.</i> DEAD-MEN'S-FINGERS.
<p>Many are simple, many colonial.</p> <p>The polyps of a colony may give rise to others directly by fission or budding.</p> <p>Tentacles usually simple, usually some multiple of six, often dissimilar.</p> <p>Mesenteries usually some multiple of six, complete and incomplete.</p> <p>Retractor muscles never as in Alcyonaria.</p> <p>Two gullet grooves or siphonoglyphes, or only one.</p> <p>No dimorphism.</p> <p>Calcareous skeleton, if present, is derived from the basal ectoderm.</p>	<p>All colonial, except a small family including <i>Monoxenia</i> and <i>Haima</i>.</p> <p>The polyps of a colony give rise to others not directly, but through stolons or solenia.</p> <p>Tentacles eight, feathered, uniform.</p> <p>Mesenteries eight, complete.</p> <p>Retractor muscles always on one (ventral) side of each mesentery (see Fig. 81).</p> <p>One (ventral) gullet groove (siphonoglyphe or sulcus), or none.</p> <p>Frequent dimorphism among members of a colony.</p> <p>There are usually calcareous spicules (of ectodermic origin) in the mesogloea.</p>
<p style="text-align: center;"><i>Examples.</i></p> <p>Sea-anemones—<i>e.g.</i> <i>Tealia</i> and <i>Actinia</i>.</p> <p>Madrepore corals, many of them reef-building.</p> <p>Antipatharians. An aberrant Antipatharian, <i>Dendrobrachia fallax</i>, has eight feathered tentacles.</p>	<p style="text-align: center;"><i>Examples.</i></p> <p><i>Alcyonium</i> (Dead-men's-fingers), with diffuse spicules of lime.</p> <p><i>Tubipora</i> (Organ-pipe coral), with spicules fused into tubes and transverse platforms.</p> <p><i>Corallium rubrum</i> (Red coral), with an axis of fused spicules.</p> <p><i>Pennatula</i> (Sea-pen), a free phosphorescent colony, with a "horny" axis, possibly endodermic.</p>

ZOANTHARIA

The Zoantharia include many orders, *e.g.* the primitive Cerianthidea (*Cerianthus*, etc.) and Edwardsiidea (*Edwardsia*), the Actiniidea (including the typical sea-anemones and the Madreporaria), and the divergent Antipathidea.

Making of a typical coral.—Although the term "coral" is applied to many different Cœlenterate types with substantial calcareous skeletons, *e.g.* to Millepores which are Hydrozoa, and to "blue corals" and "red corals" which are Alcyonarians, the corals *par excellence* are the Madreporarians. They form the coral rock and "coral islands" found in many parts of the globe, but rarely north or south of a belt extending 30° on each side of the equator, and rarely below the 40-fathom line.

In a general way a Madrepore polyp is like a sea-anemone in structure, and the "coral" it forms is its external shell rather than its skeleton. It is altogether a product of the ectoderm. From one polyp others usually arise by budding or by division, e.g. *Astræa* and *Madrepora* and *Lophohelia* (North Sea), but there are solitary forms such as *Fungia* and *Caryophyllia* (British).

The first part of the "shell" to be formed is the *basal plate* between the ectoderm of the base and the substratum.

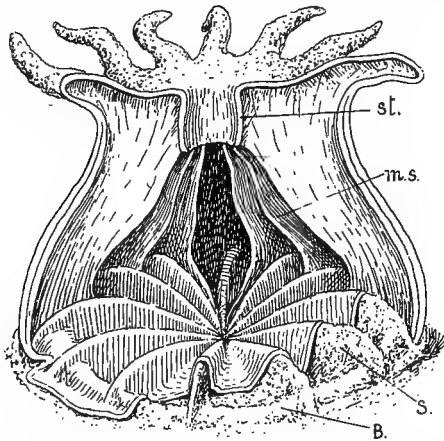

FIG. 82.—The formation of a coral shell (*Astroïdes*).—
After Pfuertscheller.

st., Stomodæum ; ms., mesentery ; s., calcareous septum ; B., basal plate.

On this plate a number of radially arranged vertical ridges (septa or cnemes) are then formed, and as they grow in height they push the ectoderm of the base up before them (see Fig. 82). An external wall or *theca* is then formed, partly by the fusion of the outer margins of the septa and partly by a circular upgrowth from the basal plate. This theca pushes the body wall before it, as the septa pushed the base. Sometimes a second external wall or *epitheca* is formed outside of and concentric with the theca. By the coalescence of septa in the central line a *columella* or median

pillar may be formed. The outer wall of the theca may bear vertical ridges or costæ, and these may be connected with neighbouring costæ of other polyps by horizontal shelves or dissepiments. Both septa and costæ correspond to intermesenteric spaces. (See Shipley's *Zoology of the Invertebrata*, pp. 68-71.)

ANTIPATHARIANS

Usually arborescent, sometimes whip-like colonies, of wide distribution in most seas, often called "black corals." A spinose hollow horny axis is covered with cœnenchyma and regularly arranged polyps,

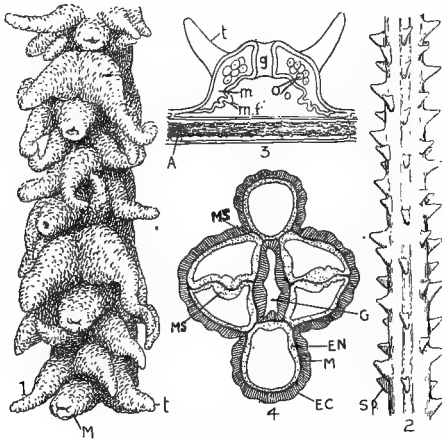

FIG. 83.—Structure of Antipatharians.

1. A group of polyps—*M.*, mouth; *t.*, tentacles.
2. Axis without polyps and cœnenchyma, covered with spines (*Sp.*).
3. Vertical section of a polyp—*A.*, axis; *t.*, tentacle; *g.*, gullet; *m.*, mesentery; *o.*, ovary; *m.f.*, mesenteric filaments.
4. Cross section of a polyp—*EC.*, ectoderm; *M.*, mesogloea; *EN.*, endoderm; *G.*, gullet; *MS.*, mesenteries.

without any trace of spicules. A polyp is usually oval in section, with its long diameter in the line of the axis, and its gullet elongated at right angles to this. There are usually six simple non-retractile tentacles, ten mesenteries, and two ill-defined siphonoglyphes. The mesenteries are without muscle-banners. The two longest, running at right angles to the elongated stomodæum, bear gonads. The development is unknown.

Examples:—

Antipathes (arborescent).

Cirripathes (whip-like).

Leiopathes (with twelve mesenteries).

Dendrobrachia (with eight pinnate retractile tentacles).

ALCYONARIA

In the Alcyonarian polyp there are always eight *pinnate* tentacles and eight mesenteries attached to the stomodæum or gullet. There is one longitudinal

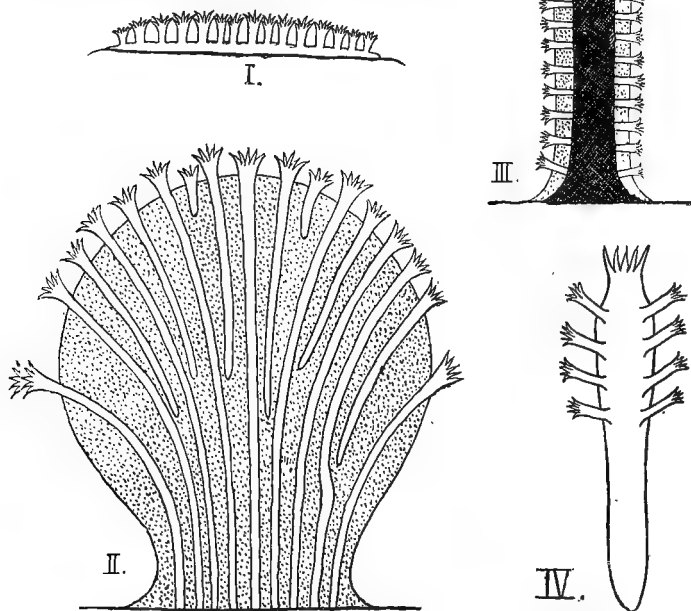

FIG. 84.—Diagrams of Types of Alcyonaria.—After Hickson.

Types of Alcyonaria:—I. Of Stolonifera; II. of Alcyonacea; III. of Axifera; IV. of Stelechotokea.

ciliated groove (siphonoglyphe or *sulcus*) in the stomodæum

(ventrally). The mesenteries bear retractor muscles, all situated on the sulcar aspect (see Fig. 81), and each mesentery bears a mesenterial filament. The two dorsal (asulcar) mesenteries are long, ciliated, and non-glandular; they are respiratory in function and cause an upward current, that in the sulcus being downward. Many Alcyonarians are dimorphic, having in addition to the typical polyps (*autozooids*) dwarf *siphonozooids*, with suppressed

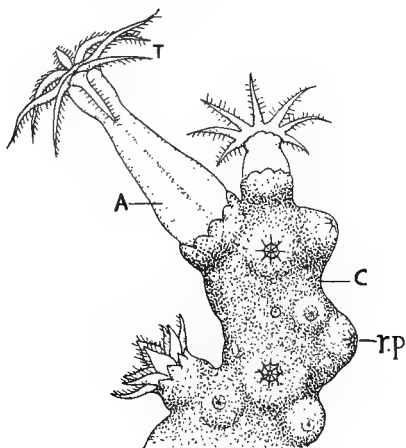

FIG. 85.—*Corallium rubrum*, a corner of a colony.—
After Lacaze-Duthiers.

A., Anthocodia or retractile portion of a polyp; *rp.*, completely retracted polyp, with the verruca or calyx portion left protruding; *C.*, cœnenchyma; *T.*, pinnate tentacles.

tentacles, strongly developed sulcus, no mesenteric filaments, and often ill-developed mesenteries. Their function is to drive currents of water through the canal systems of the colony, and they are sometimes reproductive as well. With the exception of one small family of solitary forms (*Haimeidæ*), the Alcyonarians form colonies which are in various ways supported by spicules, or by spicules and an axis. The spicules, which take the most diverse forms, seem to be begun at least by ectodermic cells (a pair to

each spicule), but they usually pass into the mesogloea. The nematocysts are usually small. A number of Alcyonarians are viviparous; the embryo is usually a planula.

Colonies are formed in different ways. (1) A parent polyp gives off hollow stolons or *solenia*, which bud off new polyps, and the whole forms a spreading network or flat plate, e.g. *Clavularia*, a type of *Stolonifera* (Fig. 84, I.).

(2) The polyps may be crowded together so as to form bundles raised on a stalk, or lobose fleshy growths with the polyps projecting on the surface of a dense mesogloecal mass honeycombed by *solenia*, e.g. *Xenia* and *Alcyonium*, types of *Alcyonacea* (Fig. 84, II.).

(3) Or the colony may raise itself in the water by forming a

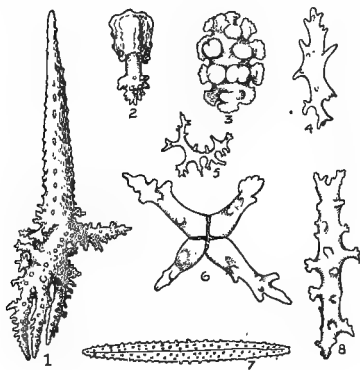

FIG. 86.—Alcyonarian spicules.

common upright coenenchyma, in which the polyps are embedded, and the medullary part of which may form a substantial axis of cemented spicules, e.g. *Corallium*, a type of *Pseudaxonia*.

(4) Or the vertical extension of the colony may be effected by a horny secretion from the polyps, which comes to form an axis, really outside of the polyps though encrusted by them. This axis may be purely horny or in part calcareous, e.g. *Gorgonia* and *Acanella*, types of *Axifera* (Fig. 84, III.).

(5) Fifthly, the vertical extension may be due to a great elongation of a single primary polyp which gives off *solenia* bearing numerous secondary polyps, e.g. *Pennatula*, a type of *Stelechotokea* (cf. Fig. 84, IV.).

An altogether aberrant type is represented by the blue coral (*Heliopora*) and its extinct relatives (*Heliolites*, etc.).

GENERAL SURVEY OF CŒLENTERA

Before we proceed to the systematic survey, we may contrast the essential structural features of the four classes of Cœlentera.

I. In the Hydrozoa or Hydromedusæ there is no inturned ectodermic gullet or stomodæum; there are no partitions or mesenteries; there are no special digestive organs; in the body wall the ectodermic muscles are mostly longitudinal and the endodermic muscles circular; the sex cells are usually produced in the ectoderm; there is very frequently a combination of polypoid and medusoid phases in the life history; the circumference of the medusoid bears a muscular velum of ectoderm and mesoglea; there is no calcareous secretion (except in Millepores).

II. In the Scyphomedusæ there is an inturned ectodermic gullet or stomodæum; there are hints of mesenteries; there are special digestive filaments; the sex cells are endodermic; there is no velum; there is often a non-sexual sedentary stage; there is no calcareous secretion.

III. In the Anthozoa there is an inturned ectodermic gullet or stomodæum; there are distinct mesenteries or partitions from body wall to gullet wall; there are often digestive filaments; in the body wall the ectodermic muscles are circular (except in *Cerianthus*), and the endodermic muscles longitudinal; the sex cells are endodermic; there is no medusoid phase.

IV. The Ctenophora are very divergent and apart from the other classes, e.g. in rarely having any stinging cells, and in having a well-defined mesoblast.

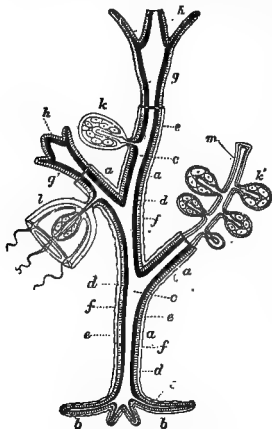

FIG. 87.—Diagram of a gymno-blastic Hydroid.—After Allman.

a., Stem; b., root; c., gut cavity; d., endoderm (dark); e., ectoderm; f., horny perisarc; g., hydra-like "person" (hydranth); g', the same, contracted; h., hypostome bearing mouth; k., sac-like reproductive bud (sporosac); m., a modified hydranth (blastostyle) bearing sporosacs; l., medusoid "person."

SYSTEMATIC SURVEY

Class I. HYDROZOA

Solitary polyps like *Hydra*, hydroid colonies or zoophytes with medusoid reproductive buds, medusoids without sedentary stages, colonies of modified medusoids.

I. Order Hydromedusæ.—Simple or colonial forms in which the sexually reproductive persons are either liberated as free-swimming medusoids or are sessile gonophores.

(a) Hydrophora.—Two types are included here. The first includes the Tubularians, *Hydractinia*, and other forms in which the polyps are not enclosed in the protective perisarc which often surrounds the colony (gymnoblasic), and in which the free medusoid forms, when present, have their genital organs placed in the wall of the manubrium (Anthomedusæ), and are furnished with ocelli placed at the base of the tentacles. *Hydra* and its allies may be included here.

An unattached marine hydroid—*Hypolytus peregrinus*—has been described, and as it bore gonophores it was obviously mature, which is doubtful as regards two other unattached forms, *Protohydra leuckartii* and *Halernita cumulans*, which may turn out to be larval. The hydroid stages of *Pelagohydra* and *Margelopsis* are free-swimming.

Examples:—

Syncoryne sarsii, the free medusoid of which is called *Sarsia tubulosa*.

Bougainvillea ramosa liberates the medusoid *Margelia ramosa*.

Cordylophora lacustris and *Tubularia larynx* have sessile gonophores or sporosacs.

The second type includes Campanularians and Sertularians along one line; Halecids and Plumularians along another line. The protective perisarc surrounding the colony is continued into little cups (hydrothecæ) enclosing the polyps (calyptoblastic). These hydrothecæ are stalked in Campanularians, sessile in Sertularians and Plumularians. The free medusoids have their gonads placed in the course of the radial canals (Leptomedusæ), and are either "ocellate" or "vesiculate."

Examples:—

Plumularia, with hydrothecæ on one side of the branches, and *Sertularia*, with hydrothecæ on both sides of the branches.

The Campanularian *Obelia geniculata* liberates the medusoid *Obelia geniculata*.

(b) Hydrocorallinæ.—Colonial forms which suggest the Hydractiniæ in their polymorphism and division of labour, but are distinguished by their power of taking up lime, and so forming "corals." The colonies are complex and divergent, the reproductive persons are either sessile gonophores or simple medusoids. *Millepora*, *Stylaster*.

(c) Trachymedusæ.—These exist as a rule only in the medusoid form,

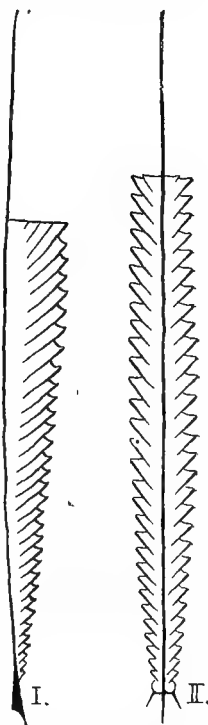

FIG. 88.—Graptolites.

I. Monograptus.
II. Diplograptus.

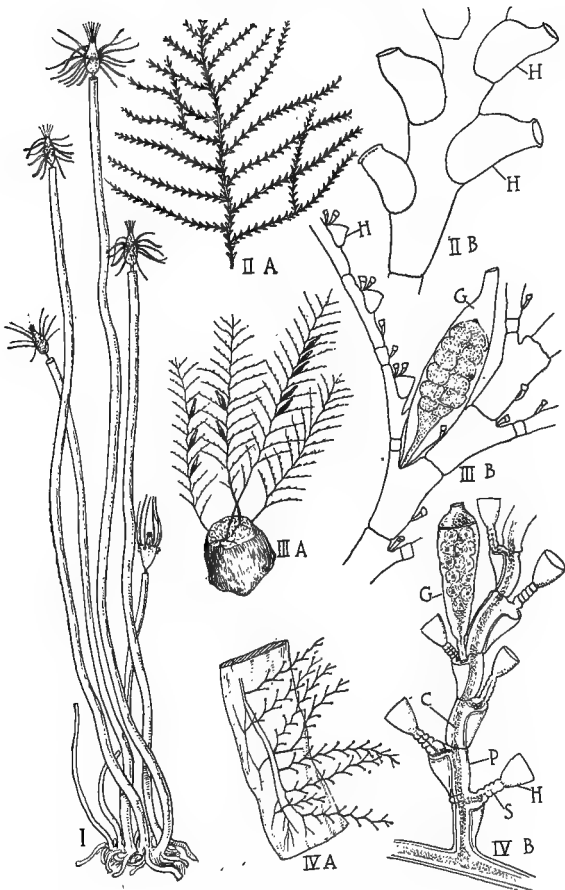

FIG. 89.—Hydroids.—After Hincks.

- I. Tubularia. II A. Piece of Sertularia. II B. A fragment enlarged, showing sessile hydrothecæ (*H.*) on both sides of the twigs. III A. Plumularia. III B. A fragment enlarged, showing hydrothecæ (*H.*) on one side of each twig, an axillary gonotheca (*G.*) and minute nematophores. IV A. Campanularian. IV B. A fragment enlarged, showing stalked hydrothecæ (*H.*), a gonotheca (*G.*); *C.*, the coenenchyma; *P.*, the perisarc; *S.*, a stalk.

and are divided into two groups, Trachomedusæ and Narcomedusæ, according to the position of the gonads. The fresh-water medusæ *Limnocodium* and *Limnocyclus* may possibly belong to this group.

Geryonia, *Carmarina*,
Cunina, *Aeginopsis*.

2. Order Siphonophora.
—Free-swimming colonies of modified medusoid persons (medusomes), with much division of labour.

Physalia (Portuguese man-of-war), *Diphyes*, *Velella*, *Porpita*.

Incertæ sedis. Graptolites.—Extinct unattached colonies with a rod-like axis found in Upper Cambrian, Ordovician, and Silurian systems. The colony is usually linear, and consists of cup-shaped hydrothecæ borne on one, two, or four sides of the solid axis (*virgula*). Each opens into a common median canal. At the proximal free end there is a minute triangular or dagger-shaped body—the *sicula*—which represents the embryonic skeleton. Some reproductive bodies or gonangia have been found. The animals were probably free-swimming in muddy seas, and of a Hydromedusan nature.

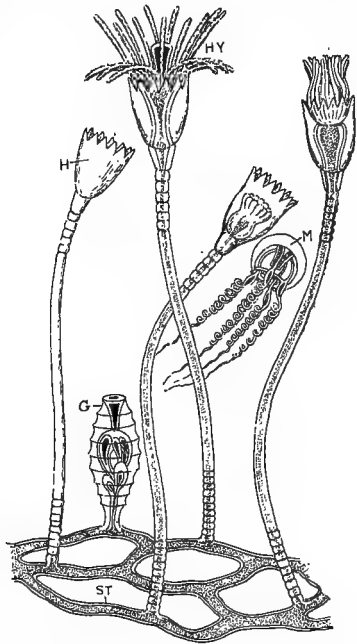

FIG. 90.—Campanularian Hydroid.—
After Allman.

H., Hydrotheca or polyp-cup; *HY.*, hydranth, or polyp-head; *G.*, gonotheca, enclosing a reproductive polyp producing medusoid buds; *M.*, a liberated medusoid; *ST.*, basal stolon.

Class II. SCYPHOMEDUSÆ (= Acraspeda)

Jelly-fish with gastric filaments, sub-genital pits, and no velum—

- (1) Lucernariæ.—Sedentary forms. *Lucernaria*, *Haliclystus*, and *Depastrum*.
- (2) Discomedusæ.—Active forms, often with complicated life history. *Aurelia*, *Pelagia*, *Cyanea*, *Rhizostoma*.

- (3) Cubomedusæ.—Forms with broad pseudo-velum, and other peculiar features. *Charybdea*.
- (4) Peromedusæ.—Forms with four inter-radial tentaculocysts only. *Pericolpa*.

Class III. ANTHOZOA (= Actinozoa)

Polypoid forms with well-developed gullet and septa, and circumoral tentacles.

- (1) Zoantharia or Hexacoralla.
- (a) Actiniaria. Sea-anemones. *Actinia*, *Anemonia*, *Tealia*, *Cerianthus*.
- (b) Madreporaria. Stone or reef corals. *Astræa*, *Madrepora*, *Fungia*, *Mæandrina*.
- (c) Antipatharia. "Horny" black corals. *Antipathes*.
- (2) Alcyonaria or Octocoralla.
- Alcyonium* (Dead-men's-fingers), *Tubipora* (Organ-pipe coral), *Corallium* (Red coral), *Gorgonia*, *Pennatula* (Sea-pen), *Monoxenia* (non-colonial).

Class IV. CTENOPHORA

Delicate free-swimming organisms, generally globular in form, moving by means of eight meridional rows of ciliated plates, or comb-

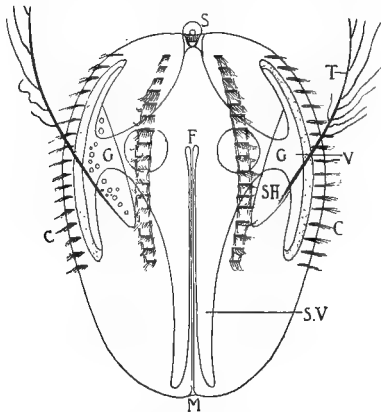

FIG. 91.—Diagram of a Ctenophore.—After Chun.

M., Mouth; *S.*, sensory organ; *T.*, tentacle cut short; *SH.*, pouch of tentacle; *C.*, ciliated combs; *F.*, funnel or central canal; *SV.*, paragastric canal running parallel with stomodæum; *G.*, other canals of the gut; *V.*, one of the meridional canals, bearing gonads, running under the bands of ciliated combs.

like combinations of cilia. The stinging cells are almost always replaced by "adhesive cells." The mouth is at one pole, and leads into an ectodermic gullet. The gastric cavity is usually much branched. The mesenchyme is very well developed, and includes muscular and connective cells. At the aboral pole there is a sensory organ, including an "otolith," which seems of use in steering. Here, also, there are two excretory apertures. Except in *Beroë* and its near relatives, there are two retractile tentacles. All are hermaphrodite. The development

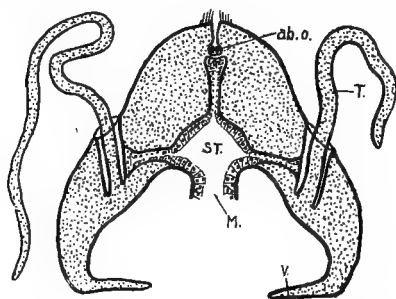

FIG. 92.—*Hydroctena*. A medusoid with suggestions of Ctenophore structure, but a true medusoid none the less.

ab.o., Aboral sensory organ; T., retractile tentacle;
v., velum; M., mouth; ST., stomach.

is direct. They are pelagic, very active in habit, carnivorous in diet, and often phosphorescent. According to some, they lead on to Polyclad worms, especially through *Ctenoplana* and *Cæloplana*, two curious flattened forms which crawl like Planarians. Mortensen's remarkable sessile *Tjalffella* corroborates this affinity.

Examples:—

- (a) With tentacles, *Cydidippe* and the ribbon-shaped Venus' Girdle (*Cestum veneris*). (b) Without tentacles, *Beroë*.

History of Coelentera.—Of corals, as we would expect, the rocks preserve a faithful record, and we know, for instance, that in the older (Palæozoic) strata they were represented by many types. We often talk of the imperfection of the geological record, and rightly, for much of the library has been burned, many of the volumes are torn, whole chapters are wanting, and many pages are blurred. But this imperfect record sometimes surprises us, as in the quite distinct remains of ancient jelly-fish, which animals, as we know them now, are apparently little more than animated sea-water. We should also grasp the conception, with which Lyell first impressed the world, of the uniformity of natural processes throughout the long history of the earth. Thus in connection with Coelentera we learn that there were great coral reefs in

the incalculably distant past, just as there are coral reefs still. So in the Cambrian rocks, which are next to the oldest, there are on sandy slabs markings exactly like those which are now left for a few hours when a large jelly-fish stranded on the flat beach slowly melts away. On the other hand, some forms of life which lived long ago seem to have been very different from any that now remain, as is well shown by the abundant Graptolite fossils, which, though probably Cœlentera, do not fit well into any of the modern classes.

As to the pedigree of the Cœlentera, the facts of individual life history, and the scientific imagination of naturalists, help us to construct a genealogical tree—a hypothetical statement of the case. Thus it seems very likely that the ancestral many-celled animals—ancestral to Sponges, Cœlentera, and all the rest—were small two-layered tubular or oval forms. The many-celled animals must have begun as clusters of cells; the question is, what sort of clusters—spheres of one layer of cells, or mouthless ovals, or little discs of cells, or two-layered thimble-like sacs? Possibly there were many forms, but Hæckel and other naturalists were led to fix their attention especially on the two-layered sac or *gastrula*, because this form keeps continually cropping up as an embryonic stage in the life history of animals, whether sponge or coral, earthworm or starfish, mollusc or even vertebrate, and also because this is virtually the form which is exhibited by the simplest sponges (Ascons), the simplest Cœlentera (*Hydra*), and even by the simplest “worms” (Turbellarians).

If we begin in our survey with such a gastrula-like ancestor, the probabilities are certainly in favour of the supposition that it was a free-swimming organism. A gradual perfecting of the locomotor characteristics might yield the two medusoid types of which we have already spoken. But we know that the common jelly-fish *Aurelia* has a prolonged larval stage which is sedentary, vegetative, and prone to bud. If we suppose with W. K. Brooks that many forms, less constitutionally active than others, relapsed into this sedentary state, with postponed sexuality, and with a preponderant tendency to bud, we can understand how polyps arose, and these of two types, one nearer the jelly-fish and Lucernarians and leading on to sea-anemones and corals, the other nearer the swimming-bell type and leading on to a terminus in *Hydra*. It is certainly suggestive that we have jelly-fish wholly free (*Pelagia*), jelly-fish with a sedentary larval life (*Aurelia*), jelly-fish predominantly passive (*Lucernaria*), and related polyps (Sea-anemones, etc.), which only occasionally rise into free activity; while in the other series we have medusoid types always free (Trachymedusæ), others which are liberated from (Campanularian and Tubularian) sedentary hydroids, other (Sertularian and Plumularian) zoophytes whose buds though often medusoid-like are not set free, and finally *Hydra*, which, though it may creep on its side, or walk on its head, is predominantly a sedentary animal, without any youthful free-swimming stage.

Ecology.—The Cœlentera are almost all marine. In fresh water we find the common *Hydra*, the minute *Microhydra* without tentacles, the strange *Polypodium*, which in

early life is parasitic on sturgeons' eggs, the compound *Cordylophora*, occurring in canals and in brackish water, and the fresh-water Medusoids (*Limnocodium* and *Limnocnida*). Most of the active swimmers are pelagic, but there are also a few active forms in deep water. Many polyps anchor upon the shells of other animals, which they sometimes mask, and there are most interesting constant

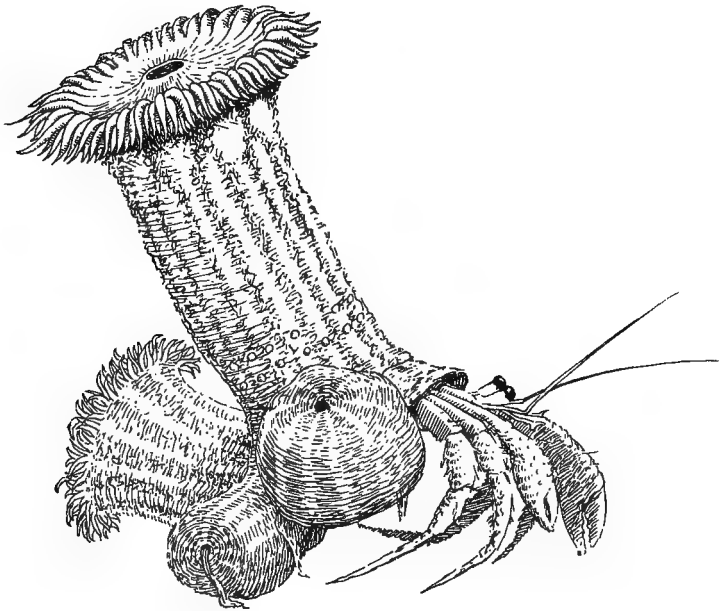

FIG. 93.—Commensalism of sea-anemones and hermit-crab.

partnerships between hermit-crabs and sea-anemones, e.g. between *Eupagurus prideauxii* and *Adamsia palliata*.

The hermit-crab is masked by the sea-anemone, and may be protected by its stinging powers; the sea-anemone is carried about by the hermit-crab, and may get crumbs from its abundantly supplied table. This illustrates a mutually

beneficial external partnership or *commensalism*. In some other animals it may degenerate into parasitism (see Fig. 93).

Another kind of partnership is illustrated by many sea-anemones and Alcyonarians. Minute unicellular Algæ (*Zoochlorellæ*) live within the cells of the animals in close physiological partnership with them (*symbiosis*).

A spatial partnership in which one animal finds habitual shelter within or near another is not infrequent; *e.g.* small horse-mackerels (*Carangidæ*) swimming in shelter of large jelly-fish; a small fish (*Amphiprion bicinctus*) inside a giant sea-anemone (*Crambactis arabica*) which has a diameter of a foot; another fish (*Fierasfer*) that goes in and out of the hind-gut of Holothurians; another that lives among the very long hair-like spines of the Red Sea rock-urchin (*Diadema saxatile*); and another (*Apogonichthys strombi*) that spends part of its time in the mantle cavity of the large sea-snail (*Strombus gigas*) of the Bahamas.

The quaint little hydroid *Lar sabellarum* lives at the mouth of the tubes of the worm *Sabella*; another hydroid (*Stylactis minor*) grows all over the skin of a rock-perch (*Minous*) from the Indian Ocean; *Stylactis vermicola* was found on the back of the worm *Aphrodite* at the great depth of 2900 fathoms.

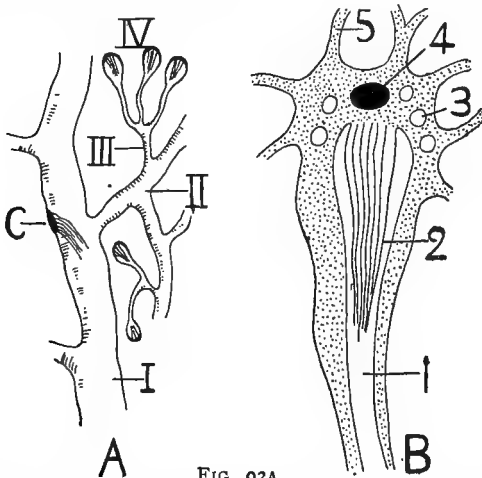

FIG. 93A.

A., a minute portion of the branched excretory system of a Plathelminth, showing longitudinal duct (I), with cilia (C.), its branches (II and III), and the terminal flame-cells (IV); B., one of the characteristic hollow flame-cells, leading into the excretory tubule (1), showing the long cilia (2), the excretory globules (3), the nucleus (4), and pseudopodia-like processes (5) passing among adjacent cells.

CHAPTER X

UNSEGMENTED "WORMS"

PHYLUM PLATYHELMINTHES :

Chief Classes—Turbellaria, Trematoda, Cestoda.

PHYLUM NEMERTEA.

PHYLUM NEMATHELMINTHES :

Chief Classes—Nematoda, Nematomorpha, Acanthocephala.

THE title "worms" is hardly justifiable except as a convenient name for a shape. The animals to which the name is applied form a heterogeneous mob, including about a dozen classes whose relationships are imperfectly known.

It is likely that certain "worms" were the first animals definitely to abandon the more primitive radial symmetry, to begin moving with one part of the body always in front, to acquire head and sides. And if one end of the body constantly experienced the first impressions of external objects, it seems plausible that sensitive and nervous cells would be most developed in that much-stimulated, over-educated head region. But a brain arises from the insinking of ectodermic cells, and its beginning in the cerebral ganglion of the simplest "worms" is thus in part explained.

Worm types begin the series of *triploblastic cœlomate* animals, *i.e.* of those which have a well-defined mesoderm, and a cœlom or body cavity lined with mesoderm and distinct from the gut. It must be noted, however, that the appearance of a well-developed cœlom and mesoderm is very gradual; thus there is practically no cœlom in the Platyhelminthes, and the mesoderm is sometimes not more definite than in Ctenophora.

PHYLUM PLATYHELMINTHES

The Platyhelminthes or flat-worms include three chief classes—Turbellarians, Trematodes, and Cestodes—which form a related series. The body is flattened from above downwards; the mesoderm forms a compact mass of cells or parenchyma without a definite cœlom; there is the beginning of a head-brain; the excretory system consists of a pair of lateral canals, giving off many branches, whose twigs end in peculiar "flame-cells"; almost all are hermaphrodite.

There is no doubt that the three classes, Turbellarians or Planarians, Trematodes or Flukes, and Cestodes or Tape-worms, are related to one another. A fourth class of Temnocephalids must also be admitted. It is interesting to notice that the Turbellarians and Temnocephalids are free-living, except in the case of a few marine Turbellarians which have taken to parasitism; that the Trematodes are all parasitic, either external hangers-on (ectoparasites) or internal boarders (endoparasites); and that the Cestodes are altogether endoparasitic. It is probable that the flukes and tape-worms arose from Turbellarian-like ancestors which adopted parasitic habits. Attention must be directed to the flame-cells which are characteristic of Platyhelminthes. Each terminal twig of a branch of an excretory canal leads into a large hollow cell, from the base of which a bunch of cilia—with rapid movements suggesting a flickering flame—projects into the cavity towards the lumen of the twig.

Class TURBELLARIA. Planarians, etc.

Turbellarians are unsegmented "worms," usually leaf-like, living in fresh, brackish, or salt water, or in moist earth. Almost all are carnivorous, a few are parasitic. They represent the beginning of definite bilateral symmetry.

The ectoderm is ciliated, often glandular, often with peculiar rod-like bodies (rhabdites) which may be discharged on irritation. A pair of ganglia in the anterior region give off lateral nerve-cords, and there are usually simple sense organs. The food canal has a protrusible muscular pharynx, is often branched, and is always blind. There are no special

respiratory or circulatory organs; the body cavity is not represented, unless it be by intercellular lacunæ in the parenchyma; the excretory system usually consists of two longitudinal canals, whose branches end internally in flame-cells. The Turbellarians are almost always hermaphrodite; and the reproductive organs usually show some division of

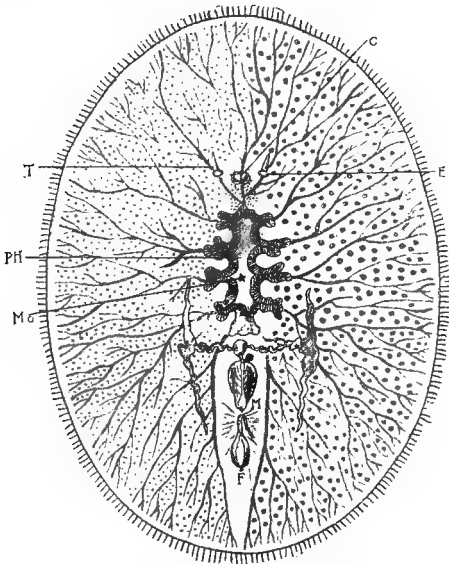

FIG. 94.—Diagram of Turbellarian.—After Lang.

C., Cerebral ganglia; E., eye; T., tentacle; PH., pharynx; Mo., mouth; M., male aperture; F., female aperture; the ovaries and testes are branched organs on both sides, represented by dots.

labour, e.g. in the development of a yolk gland, which may have arisen as an over-nourished (hypertrophied) part of the ovary. The eggs are usually enclosed in shells or cocoons, and the development may include a metamorphosis. Some forms multiply by fission. There seem to be affinities between Turbellaria and Cœlentera, especially the Ctenophora.

The Turbellarian worms form an exceedingly interesting group; they are often beautiful, and the ciliated ectoderm and well-developed muscles enable them to move with singular grace. Although the bilateral symmetry and the distinction of anterior and posterior ends is quite marked, the "mouth" or single opening of the food canal is often near the middle of the ventral surface. The anterior region is usually furnished with tactile processes. The shape of the body in the aquatic forms is flattened and leaf-like, as in the delicate *Leptoplana*, the "living film" found on the shore-rocks. Fresh-water forms are usually small and often minute, but those living in the sea may attain a length of six inches, though most are small. Land Planarians are elongated and more worm-like in shape; they may measure a foot or more in length, and are most abundant in tropical countries. Some, like *Planaria*, have so much regenerative capacity that half a dozen or more may be produced by cutting one into pieces.

Classification.—

Order 1. Rhabdoccelida—small fresh-water and marine forms.

The food canal is very slightly branched, or quite straight, or blocked.

Rhabdoccela. With straight intestine, *e.g.* *Microstoma*, a fresh-water genus. It is first male and then female (protandrous hermaphrodite); it forms temporarily united asexual chains, sometimes of sixteen individuals, suggesting the origin of a segmented type. *Graffilla* and *Anoplodium* are parasitic on Gastropods. Among the Vorticidæ allied to *Graffilla* we may notice *Provortex tellinæ* in *Tellina* and a related form in the cockle.

Alloiocoela. With irregular cæca on the gut, *e.g.* *Allostoma*. All marine except one from Swiss lakes (*Plagiostoma lemani*) and *Bothrioplana*.

Accela. Without intestine, *e.g.* *Convoluta*, which contains green cells, regarded by some as symbiotic Algæ. Marine.

Order 2. Tricladida. Elongated flat "Planarians" with three main branches from the gut, *e.g.* *Planaria* and *Dendrocoelum* (fresh-water), the former sometimes dividing transversely; *Polycelis nigra*, a common fresh-water form; *Gunda* (*Procerodes*) *segmentata* (marine), showing hints of internal segmentation; *Geodesmus* and *Bipalium* (in damp earth); *Bipalium kewense* is an import often found in Britain.

Order 3. Polycladida. Large leaf-like marine "Planarians," with numerous intestinal branches diverging from a central stomach, *e.g.* *Leptoplana* (not uncommon on the seashore), *Thysanozoon*.

Class TEMNOCEPHALOIDEA

The Temnocephalids are flattened forms, *e.g.* *Temnocephala*, found clinging to fresh-water animals, especially Crustaceans; there is a large ventral sucker; the epidermis is a nucleated

syncytium (*i.e.* without distinct demarcation into cells) which secretes a thick cuticle, contains rhabdites, and rarely bears cilia. The class seems to be intermediate between Rhabdocelid Turbellaria and Trematodes.

Class TREMATODA. Flukes, etc.

The Trematodes are leaf-like, or sometimes cylindrical external or internal parasites. With their parasitic life may be associated the absence of cilia on the surface of the adults, the thick "cuticle," the presence of attaching suckers (occasionally with hooks), and the rarity of sense organs. After embryonic life the ectoderm degenerates, ceases to be distinctly cellular, and sinks inwards. It is likely that they have arisen from free Turbellarian-like ancestors, and they resemble the Turbellarians in being unsegmented, in having anterior ganglia, from which nerves pass backward and forward, in the rudimentary nature of the body cavity, in the ramifying system of fine excretory canals, in the hermaphrodite and usually complex reproductive system. The excretory and nervous systems are, however, more complex than those of Turbellaria. The alimentary canal is usually forked, often much branched, and always ends blindly. In many cases the animals are self-impregnating, but cross-fertilisation also occurs. The development of the external parasites is usually direct, of the internal parasites usually indirect, involving alternation of generations. They occur on or in all sorts of Vertebrates, but those which have an indirect development, and require two hosts to complete their life-cycle, often pass part of their life in some Invertebrate.

Type, *The Liver Fluke (Distomum hepaticum)*

The adult fluke lives as a parasite in the liver and bile ducts of the sheep, causing "liver-rot." Unlike most flukes, it has many occasional hosts,—it sometimes occurs in cattle, horses, deer, camel, antelopes, goat, pig, beaver, squirrel, kangaroo, and rarely in man. The animal is flat, oval, and leaf-like, almost an inch in length by half an inch across the broadest part, reddish brown to greyish yellow in colour. As the word *Distomum* suggests, there

are two suckers—an anterior, perforated by the mouth; a second, imperforate, a little farther back on the mid-ventral line.

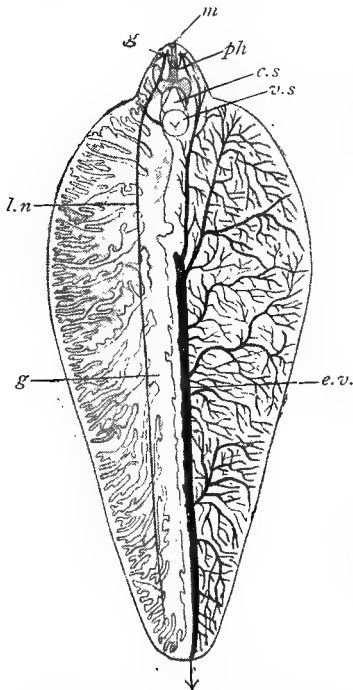

FIG. 95.—Structure of liver fluke.—After Sommer. From ventral surface. The branched gut (*g.*) and the lateral nerve (*l.n.*) are shown to the left, the branches of the excretory vessel (*e.v.*) to the right.

m., Mouth; *ph.*, pharynx; *g.*, lateral head ganglion; *v.s.*, ventral sucker; *c.s.*, position of cirrus sac. An arrow indicates the excretory aperture.

There is a muscular pharynx and a blind alimentary canal which sends branches throughout the body. The food is the *blood* sucked from the liver of the host. From a ganglionated collar round the pharynx, nerves go forward and backward; of those which run backward, the two lateral are most important. Although the larva has eye spots to start with, there are no sense organs in the adult. The body cavity is not represented unless it be by minute intercellular spaces in the body parenchyma. Into these there open the internal ciliated ends of much-branched excretory tubes, which unite posteriorly in a terminal vesicle opening to the exterior.

The reproductive system is hermaphrodite and complex. From much-branched testes, spermatozoa pass by a pair of ducts (*vasa deferentia*) into a seminal vesicle lying in front of the ventral sucker.

Thence they are expelled by an ejaculatory duct, which passes through a muscular protrusible penis. The retracted penis and the seminal

vesicle lie in a space or "cirrus sac" between the ventral sucker and the external male genital aperture. The ovary is also branched, but

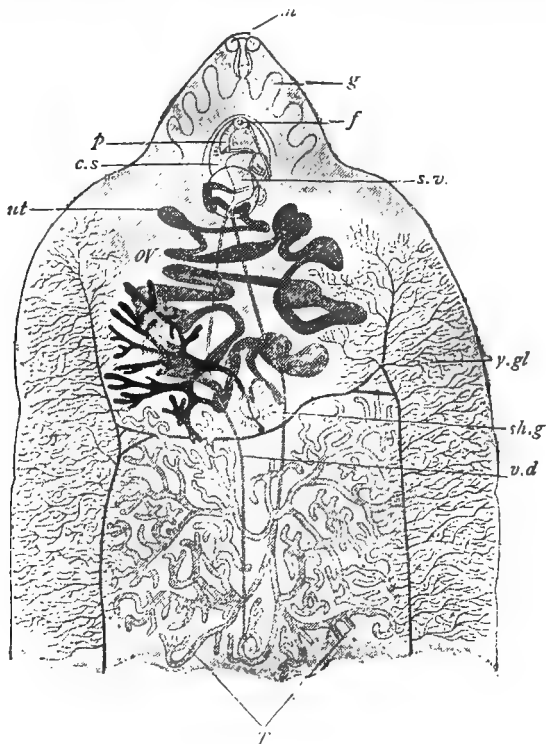

FIG. 96.—Reproductive organs of liver fluke.
—After Sommer.

f. Female aperture.
s.v. Seminal vesicle.
y.gl. Diffuse yolk glands.
sh.g. Shell gland.
v.d. Vas deferens.
T. Testes (anterior).

ov. Ovary (dark).
ut. Uterus.
c.s. Cirrus sac.
p. Penis.
m. Mouth.
g. Anterior lobes of gut.

less so than the testes. The ova pass from its tubes into an ovarian duct. Nutritive cells are gathered from very diffuse yolk glands, collected in a reservoir, and pass by a duct into the end of the afore-

said ovarian duct. At the junction of the yolk duct and the ovarian duct there is a shell gland, which secretes the "horny" shells of the eggs, and from near the junction a fine canal (the Laurer-Stieda canal) seems to pass direct to the exterior, opening on the dorsal surface. The meaning of this is still somewhat uncertain. In some flukes it is said to be a copulatory duct; in others it is regarded as a safety valve for overflowing products. From the junction of the ovarian duct and the duct from the yolk reservoir, the eggs (now furnished with yolk cells, accompanied by spermatozoa, and encased in shells) pass into a wide convoluted median tube, the oviduct or uterus, which opens to the exterior at the base of the penis. Self-fertilisation is probably normal, but in some related forms cross-fertilisation has been observed.

Life history.—The fertilised and segmented eggs pass in large numbers from the bile duct of the sheep to the intestine, and thence to the exterior. A single fluke may produce about 50,000 embryos, which illustrates the prolific reproduction often associated with the luxurious conditions of parasitism, and almost essential to the continuance of species whose life cycles are full of risks. Outside of the host, but still within the egg-case, the embryo develops for a few weeks, and eventually escapes at one end of the shell. Those which are not deposited in or beside pools of water soon die. The free embryo, known as a miracidium, is conical in form, covered with cilia, provided with two eye-spots, and actively locomotor. By means of its cilia it swims actively in the water for some hours, but its sole chance of life depends on its meeting a small amphibious water-snail (*Limnæus truncatulus* or *minutus*), into which it bores. In an epidemic among horses and cattle in the Hawaiian Islands, the host was *L. oahuensis*; in the Sandwich Islands the host is *L. peregra*, in Victoria *Bulimus tenuistriatus*. This diversity of host, also remarkable in the adult, is very unusual. Within the snail, e.g. in the pulmonary chamber, the embryo becomes passive, loses its cilia, increases in size, and becomes a *sporocyst*. The sporocyst is a hollow sac, with a slightly muscular wall and with the beginnings of an excretory system. Sometimes this sporocyst divides transversely (Fig. 97 (4)).

Within the sporocyst a few cells behave like parthenogenetic ova. Each segments into a ball of cells or morula, which is invaginated into a gastrula, and grows into another form of larva—the *redia*. These rediæ burst out of the

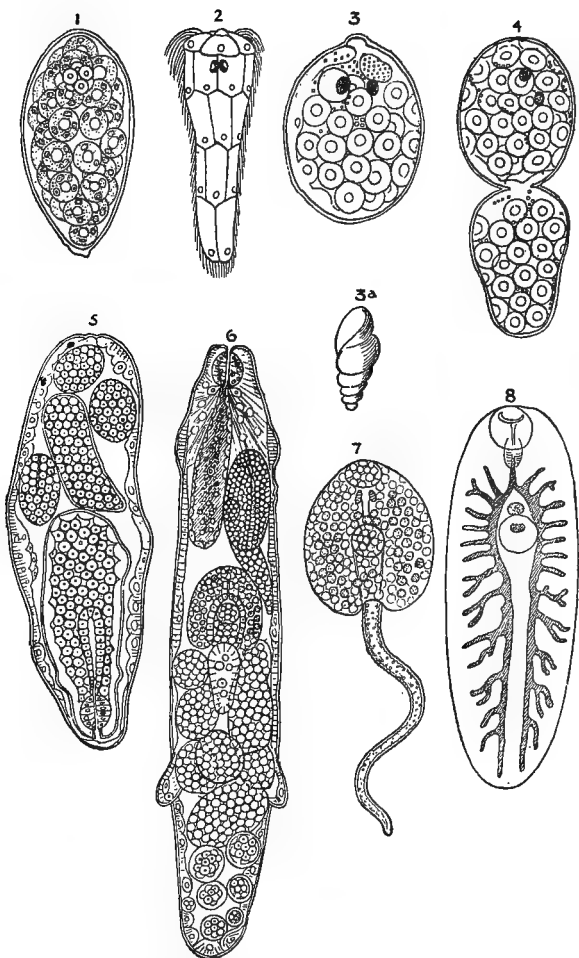

FIG. 97.—Life history of liver fluke.—After Thomas.

1. Developing embryo in egg-case; 2. free-swimming ciliated embryo; 3. sporocyst; 3a. shell of *Limnaeus truncatulus*; 4. division of sporocyst; 5. sporocyst with rediæ forming within it; 6. rediæ with more rediæ forming within it; 7. tailed cercaria; 8. young fluke.

sporocyst, and migrate into the liver or some other organ. Each sporocyst usually forms at a time 5-8 rediæ; each of these forms 8-12 more rediæ; and each of these forms 14-20 cercariæ. In the winter a sporocyst may give rise to cercariæ directly. A redia is a cylindrical organism with a short alimentary canal, excretory canals with "flame cells," and a pair of blunt locomotor processes posteriorly. A cercaria has a bifurcated gut, two suckers, a locomotor tail, and the beginnings of gonads (Fig. 97 (6)).

The cercariæ emerge from the rediæ, wriggle out of the snail, pass into the water, and after swimming for a short time, moor themselves to stems of damp grass. There they lose their tails and become encysted. If the encysted cercaria on the grass stem be eaten by a sheep, the cyst is dissolved in the stomach, and the young fluke makes its way up the bile duct and its tributaries. In about six weeks it grows into the adult sexual fluke.

It will be noted that the sporocyst is the modified embryo, but that it has the power of giving rise asexually to rediæ. These develop, however, from special cells of the sporocyst, which we may compare to spores or to precociously developed parthenogenetic ova. Though the reproduction is asexual, it is not comparable to budding or division. The same power is possessed by the rediæ, and there are thus several (at least two) asexual generations between the embryo and the adult.

The disease of liver-rot in sheep is common and disastrous. It has been known to destroy a million sheep in one year in Britain alone; and in the winter 1879-80 the mortality attributed to fluke disease was estimated at three millions. It is especially common after wet seasons, and in damp districts.

Classification.—Order 1. Heterocotylea, with a posterior adhesive organ, often with a pair of accessory suckers beside the mouth. Most are ectoparasitic. The development is direct and associated with one host (monogenetic).

e.g. Polystomum integerrimum. This form with many suckers is often found in the bladder of the frog. It attaches itself in its youth to the gills of tadpoles, passes thence through the food canal to the bladder, where it develops slowly for years.

Gyrodactylus, found on the gills and fins of fresh-water fishes. It is viviparous, but the embryo, before it is extruded, itself contains an embryo, and this in turn another, so that three generations of embryos are represented simultaneously.

Diplozoon paradoxum consists of two individuals united. The single embryo (*Diporpa*) is at first free-swimming,

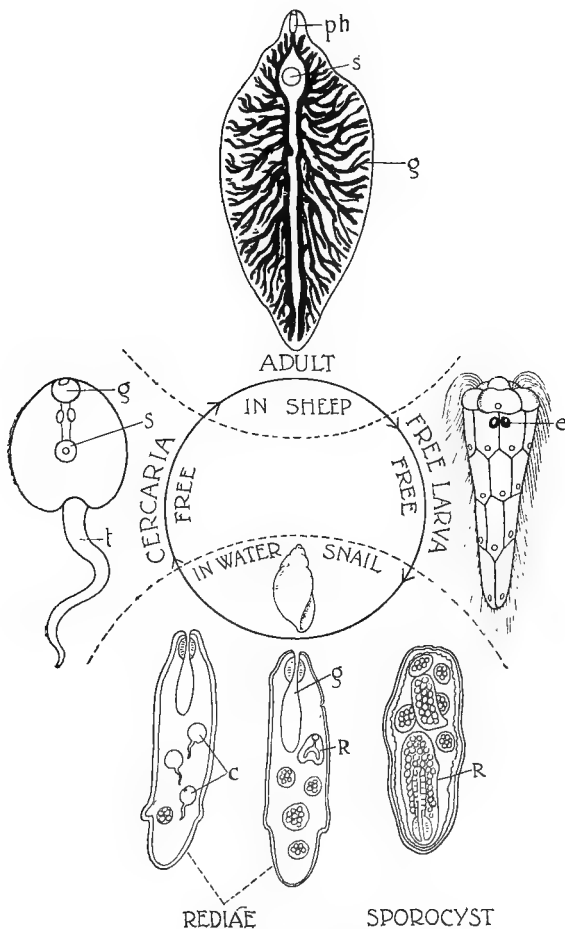

FIG. 98.—Diagram of life cycle of liver fluke.

Upper quadrant, adult in sheep; *ph.*, pharynx; *s.*, sucker; *g.*, gut. Right quadrant, free-swimming larva with eye-spots (*e*). Lower quadrant, sporocyst and redia in water-snail; *R*, redia within sporocyst or within redia; *g.*, gut in redia; *C.*, cercaria in redia. Left quadrant, free cercaria; *g.*, gut; *s.*, sucker; *t.*, tail.

but becomes a parasite on the gills of a minnow, and there two individuals unite very closely and permanently.

Tristomum, with three suckers, on some marine fishes.

Order 2. *Aspidocotylea*, with a large sucker occupying most of the ventral surface. Development is direct, and there is one host.

e.g. *Aspidogaster* in Molluscs.

Order 3. *Malacotylea*, with never more than two suckers. The development is indirect and requires two hosts, the adult usually frequenting the gut of a vertebrate.

e.g. *Distomum*, with numerous species. *Schistosomum* (*Bilharzia*) *hæmatobium*, a parasite of man, widely distributed in Africa, e.g. in Egypt. It occurs in the portal vein, the blood vessels of the bladder, large intestine, etc., causing inflammation, hæmaturia, stone, etc. The sexes are separate, and the male (about half an inch in length) carries the more thread-like female (about an inch in length) inserted in a groove or gynæcophoric canal. Man is probably infected through impure water, but the intermediate host is still unknown. The embryos are passed out in the urine.

Monostomum, with one sucker; adult in ducks, young in fresh-water snail, *Planorbis*.

The relationships of the Trematodes are on the one hand with the free-living Turbellarians, on the other hand with the parasitic Cestodes.

Class CESTODA. Tape-worms

The Cestodes are internal parasites, whose life history includes a bladder-worm (proscolex) and a tape-worm (strobila) stage, the former in a Vertebrate or Invertebrate host, the latter (with one exception) in a Vertebrate. In a few cases the body is unsegmented, e.g. Archigetes and Caryophyllæus, with one set of gonads; in a few others, e.g. Ligula, there is a serial repetition of gonads without distinct segmentation of the body; in most cases, e.g. Tænia and Bothriocephalus, the body of the tape-worm forms a chain of numerous joints or proglottides, each with a set of gonads. Thus the class includes transitions from unsegmented to segmented forms, but the latter are imperfectly integrated. The general form of the body is tape-like and bilaterally symmetrical, with anterior hooks, grooves, or suckers ensuring attachment to the gut of the host. The body wall consists of a cuticle and a well-innervated epidermis, within which there is parenchymatous connective tissue, often with cortical deposits of lime, and at least two sets (longitudinal and transverse) of unstriped muscles. The

nervous system consists of two or more longitudinal nerve-strands and anterior commissures; there are no special sense organs. There is no alimentary system; the parasite floating in the digested food of its host absorbs soluble material by its general surface. There is no vascular nor respiratory system, and a body cavity is represented merely by irregular spaces in the solid parenchymatous tissue. In some of these spaces there are "flame-cells," which lie at the ends of the fine branches of longitudinal excretory tubes, which are united in a ring in the head, are connected transversely at each joint, and open terminally by one or more pores. All tape-worms are hermaphrodite, and most, if not all, are probably self-fertilising. The male reproductive organs include diffuse testes, a vas deferens, and a protrusible terminal cirrus. The female organs include a pair of ovaries, yolk glands, a shell gland, a vagina by which spermatozoa enter, a receptacle for storing spermatozoa, and a uterus in which the ova develop. The embryo develops within another host into a proscölex or bladder-worm stage, which forms a "head" or scolex. When the host of the bladder-worm is eaten by the final host, the scolex develops into an adult sexual tape-worm. With the conditions of endoparasitic life may be associated the occurrence of fixing organs, the absence of sense organs, the low though somewhat complex character of the nervous system, the entire absence of a food canal, and the prolific reproduction.

Life history of *Tænia solium*.—This is one of the most frequent of the tape-worms infesting man. In its adult state it is often many feet in length, and is attached by its "head" to the wall of the intestine. The head bears four suckers and a crown of hooks, and buds off a long chain of joints, which develop complex reproductive organs as they get shunted farther and farther from the head. The last of the joints or *proglottides* is liberated (singly or along with others), and passes down the intestine of its host to the exterior. It has some power of muscular contraction and of movement, and it is distended with little embryos within firm egg-shells. When the proglottis ruptures, these are set free.

In certain circumstances, the embryos, within their firmly resistant egg-shells, may be swallowed by the omnivorous pig. Within its alimentary canal the egg-shells are dis-

solved, and embryos (hexacanth) bearing six anterior hooks are liberated. They bore their way from the intestine into the muscles or other structures, and there encyst. They lose their hooks, increase in size, and

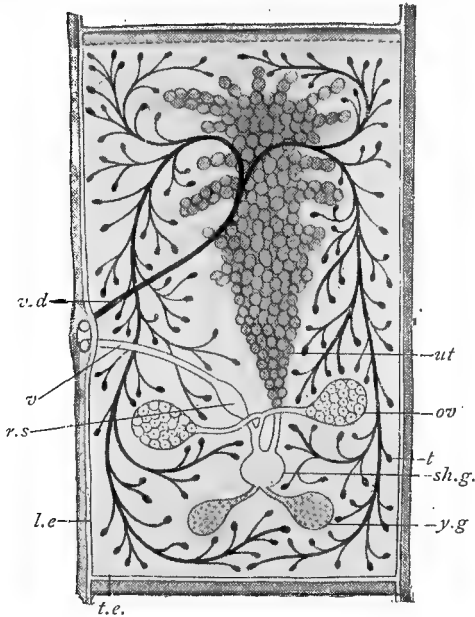

FIG. 99.—Diagram of reproductive organs in Cestode joint.
—Constructed from Leuckart.

., Ovary, with short oviduct; *ut*, "uterus"; *t*, diffuse testes; *sh.g.*, shell gland; *y.g.*, yolk gland; *v.d.*, vas deferens; *v.*, vagina; *r.s.*, receptaculum seminis; *l.e.*, longitudinal excretory ducts; *t.e.*, transverse bridges connecting these.

The dotted lines above and below represent the anterior and posterior borders of the proglottis. Note that the so-called uterus is blind; it opens to the exterior in a few tape-worms, and is perhaps the homologue of the Laurer-Stieda canal of Trematodes.

become passive, vegetative, asexual "bladder-worms." A bud from the wall of the bladder or *prosclex* grows into the cavity of the same, and forms the future "head" or *scolex*. This is afterwards everted, and then the bladder-

worm consists of a small head attached by a short neck to a relatively large bladder.

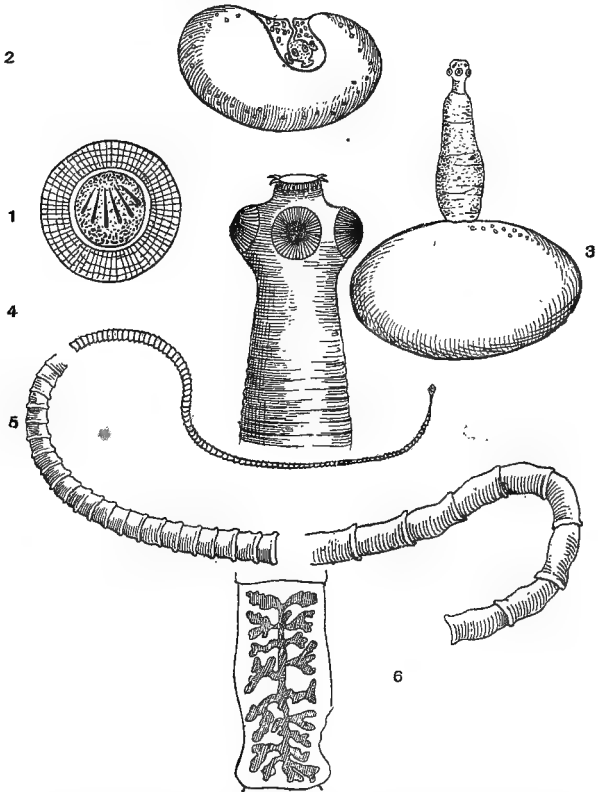

FIG. 100.—Life history of *Tænia solium*.—After Leuckart.

1. Six-hooked embryo in egg-case ; 2. prosclex or bladder-worm stage, with invaginated head ; 3. bladder-worm with evaginated head ; 4. enlarged head of adult, showing suckers and hooks ; 5. general view of the tape-worm, from small head and thin neck to the ripe joints ; 6. a ripe joint or proglottis with branched uterus (cf. Fig. 99) ; all other organs are now lost.

When man unwittingly eats “measly” pork—that is, pork infested with bladder-worms—an opportunity for further

development is afforded. The bladder is lost, and is of no importance, but the "head" or scolex fixes itself to the wall of the intestine. There it is copiously and richly nourished, and buds off asexually a chain of joints.

As these joints are pushed by younger interpolated buds farther and farther from the head, they become sexually

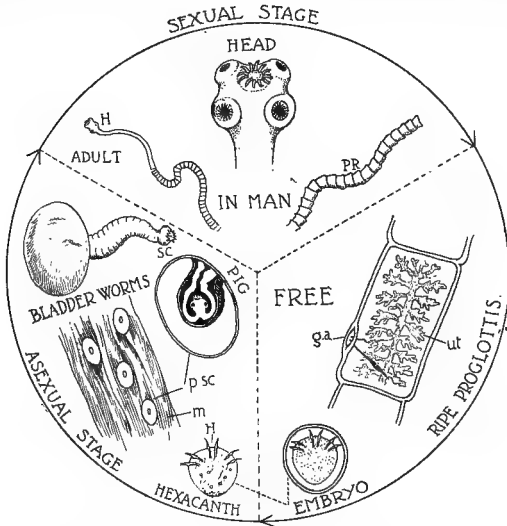

FIG. 101.—Diagram of life history of *Tania solium*.

First chapter: Tapeworm in man; *H.*, head; *PR.*, proglottides. Second chapter: Free proglottis and egg-cases; *ut.*, uterus; *g.a.*, genital aperture; embryo within the egg-case. Third chapter: Within the intermediate host, the pig; *H.*, hexacanth embryo; *p.sc.*, proscolix or bladder-worm; *m.*, muscle of pig; *sc.*, scolex or head.

mature. The ova are fertilised, apparently by spermatozoa from the same joint; the joint becomes distended with developing embryos. These ripe joints are liberated, the embryos are set free by rupture, and the vicious circle may recommence. Happily, however, the chances are many millions to one against the embryo becoming an adult.

The above history is true, *mutatis mutandis*, for many other tapeworms. The embryo grows into a *proscolix* or bladder, which buds off

a *scolex* or head, which, in another host, buds off the chain of *proglottides*. As it is virtually the same animal throughout, the life history does not include an "alternation of generations." It is doubtful, however, what term should be applied to those cases in which the bladder-worm (*Cœnurus* and *Echinococcus*) forms not one head only but many, each of which is capable of becoming an adult tape-worm. The only known exception to the fact that sexual tape-worms are parasites of Vertebrates is *Archigetes sieboldii*, a simple cestode which is sexual within the small fresh-water oligochæt *Tubifex rivulorum*.

Representative Life Histories.

ADULT, SEXUAL, OR TAPE-WORM STAGE.	NON-SEXUAL, PROSCOLEX, OR BLADDER-WORM STAGE.
<ol style="list-style-type: none"> 1. <i>Tænia solium</i>, in man, with four suckers and many hooks. 2. <i>Tænia saginata</i> or <i>mediocanellata</i>, in man, with four suckers, but no hooks. 3. <i>Bothriocephalus latus</i>, in man, with two lateral suckers, but no hooks, with less distinct separation of the proglottides than in <i>Tænia</i>. It may be 11 yards in length. 4. <i>Tænia</i> (<i>Echinococcifer</i>) <i>echinococcus</i>, in dog. Very small, with three joints. 5. <i>Tænia cœnurus</i>, in dog. 6. <i>Tænia serrata</i>, in dog. 7. <i>Tænia cucumerina</i>, in cat. 	<ol style="list-style-type: none"> 1. <i>Cysticercus cellulosa</i>, in muscles of the pig. 2. Bladder-worm in cattle. 3. The ciliated, free-swimming embryo becomes a parasite in the pike, trout, burbot, etc., but without a distinct bladder-like stage. 4. <i>Echinococcus veterinorum</i>, in sheep, cattle, pigs, etc., and sometimes in man, producing brood capsules, which give rise to many "heads." 5. <i>Cœnurus cerebrealis</i>, causing sturdie or staggers in sheep, with numerous "heads." Also in cattle, goat, horse, etc. 6. <i>Cysticercus pisiformis</i>, in rabbit. 7. <i>Cysticercus fasciolaris</i>, in mouse.

Zoologically the cestodes are interesting, on account of their life histories, the degeneration associated with their parasitism, the prevalence of self-impregnation, and the complexity of the reproductive organs. Practically they are of importance as parasites of man and domestic animals.

Classification.—The class Cestoda includes a number of families:—
Cestodariidæ. No joints, one set of gonads.

e.g. *Archigetes*, *Caryophyllæus*, *Amphilina*, *Gyrocotyle*.

Bothriocephalidæ. Two weak flat suckers; genital openings usually on the flat surfaces.

e.g. *Bothriocephalus*; *Ligula*, with no suckers or joints but with serial gonads.

Tettrarhynchidæ. With four protrusible proboscides armed with hooks, parasites of fishes. Found also in *Sepia*.

e.g. *Tettrarhynchus*. The finest pearls in the Ceylon pearl oyster are formed round a larval *Tettrarhynchus*.

Tetraphyllidæ. With four very mobile suckers.

e.g. Echinobothrium, Phyllobothrium.

Tæniidæ. With four suckers, often with apical hooks, with marginal genital apertures.

e.g. Taenia.

GENERAL NOTE ON PLATY- HELMINTHES

The four classes Turbellaria, Trematoda, Cestoda, and Temnocephaloidea, constitute the Platyhelminthes or Flat-worms — an interesting group, because its members illustrate so well the progressive degeneration associated with increasing parasitism, and also because of the relatively great simplicity. The four classes are nearly related, for forms like *Temnocephala* connect Turbellaria and Trematoda, and the "monozoic" Cestodes like *Archigetes*, *Amphilina*, *Caryophyllæus*, and *Gyrocotyle* connect Trematoda and Cestoda. It is probable that both Cestodes and Trematodes arose from a Turbellarian stock.

Among the most striking of the Platyhelminth characters are the nature of the excretory and reproductive organs and the condition of the mesoderm. The excretory system, with its longitudinal trunks, its ramifying canals, and "flame-cells," is characteristic. The reproductive organs are complex, show division of labour, and are furnished with ducts of their own, unconnected with the excretory system—a condition not common elsewhere. The presence of shells around the eggs is another point of interest. It becomes of great importance to the parasitic flukes and tape-worms, but occurs also in the free-living Turbellaria. The formation of yolk

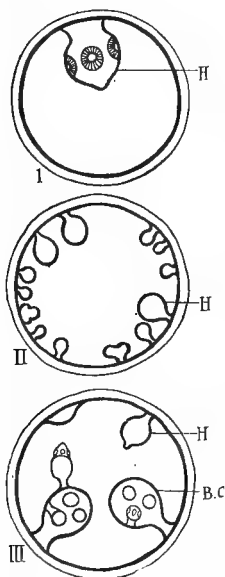

FIG. 102.—Diagrams of bladder-worms.

- I. The ordinary *Cysticercus* type with one head (H).
- II. The *Cœnurus* type, with many heads.
- III. The *Echinococcus* type, with many heads, and with brood capsules producing many heads.

cells from a specialised part of the ovary (yolk gland) is also noteworthy. There is no true body-cavity, the space between gut and body-wall being filled with a packing tissue; the absence of an anus is also important, the two characters taken together being held to indicate affinity with the Ctenophora.

Class NEMERTEA. Nemertines

The ribbon-worms or Nemertines are interesting in many ways, e.g. in being the simplest animals to have an open gut, a closed blood-system, and, occasionally, hæmoglobin; in having some very peculiar structures, notably a protrusible proboscis and ciliated head slits; in being in many cases extraordinarily extensile and liable to break into pieces.

The Nemertines are worm-like animals, unsegmented and generally elongate in form; they are almost all marine, and most, if not all, are carnivorous.

The ectoderm is ciliated. There is a remarkable retractile proboscis, unconnected with the alimentary canal, and forming a tactile organ or a weapon. The nervous system consists of a brain, a commissure round the proboscis, and two lateral nerve-cords; in connection with the brain there is a pair of ciliated pits. The gut terminates in a posterior anus, and is furnished with lateral pockets. There is no body cavity in the adult, but the closed vascular system is probably of cœlomic origin. The excretory system is apparently of the Platyhelminth type. The sexes are usually separate and the organs simple. The development is in some cases direct, while in others there is a peculiar pelagic larva.

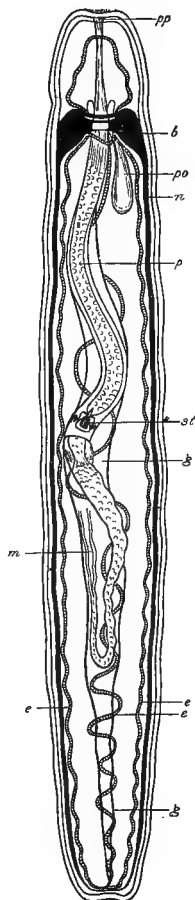

Fig. 103.—Diagrammatic longitudinal section of a Nemertean (*Amphiporus lactifloreus*), dorsal view.—After M^rIntosh.

pp., Proboscis pore; *b.*, brain giving off the lateral nerve-cords (*n.*); *po.*, oesophageal pocket; *p.*, proboscis lying within its sheath; *st.*, stilet of proboscis; *m.*, retractor muscles of proboscis; *g.*, gut shown in outline at the sides of the proboscis; *e.*, the three main longitudinal blood vessels, which unite both anteriorly and posteriorly.

GENERAL ACCOUNT OF NEMERTEA

In appearance most Nemertines are ribbon- or thread-like, and the cross-section is generally a flattened cylinder. They show a greater diversity of size than any other "worms,"—from a *Lineus*, 12 or more feet in length (25 metres has been recorded for an extended *Lineus longissimus*), to the pelagic *Pelagonemertes*, which is under an inch. The colours are often bright, and tend to resemble those of the surroundings. The ectoderm is covered with numerous short cilia, and

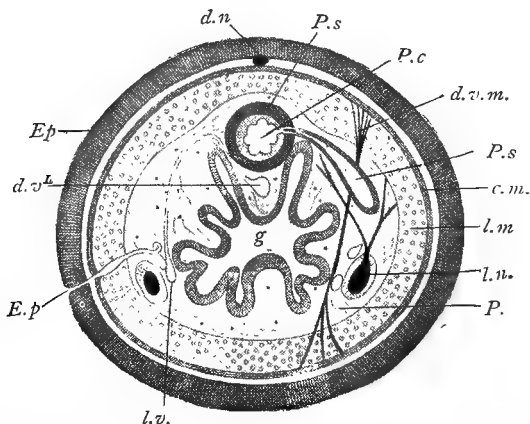

FIG. 104.—Transverse section of the Nemertean *Drepanophorus latus*.
—After Bürger.

d.n., Dorsal or proboscis nerve; *P.s.*, proboscis sheath; *P.c.*, proboscis cavity; *P.s.*, sac of proboscis cavity; *d.v.m.*, dorso-ventral muscles; *c.m.*, circular muscles; *l.m.*, longitudinal muscles; *l.n.*, lateral nerve with branches; *P.*, parenchyma; *g.*, gut; *l.v.*, lateral blood vessel, beside which lies an excretory vessel; *E.p.*, excretory pore; *d.v.*, dorsal blood vessel; *E.p.*, epidermis.

many of its cells are also glandular, secreting the mucus, which often forms a tube around the animal, or is exuded in movement. Beneath the epidermis there is a parenchyma, consisting in part of connective-tissue, and often in part gelatinous. The body is remarkably contractile, and in some cases the spasms result in breakage. The muscles are circular and longitudinal, and often also diagonal. The fibres are striped. In the adult there is no distinct cœlom, the space between the gut and the body wall being filled up with gelatinous connective tissue. In the larvæ, however, a body cavity may be seen, either as an archicœle, *i.e.* the persistent segmentation cavity (*Lineus obscurus*), or

as a schizocoel, *i.e.* a space formed by the cleavage of the mesoderm into two layers (*Pilidium*-larvæ). In the adult only the blood spaces and the cavity of the proboscis sheath are coelomic. The nervous system consists of a brain generally four-lobed,—the two lobes of each side being closely united and connected with those on the other side by a commissure above and by another below the proboscis cavity. From the lower lobes two longitudinal nerve-stems run along the sides, and are sometimes united posteriorly above the anus (Fig. 104, *l.n.*). In some forms there is in addition a dorso-median nerve, and sometimes a ventro-median nerve.

On each side of the head there is a ciliated pit communicating with the exterior through an open slit or groove, and communicating internally either with the brain itself or with adjacent nervous tissue. In those cases in which the development has been studied, these so-called lateral organs arise from epiblastic insinkings and cesophageal outgrowths. In the most primitive genus, *Carinella*, they are absent, except in one species. It has been suggested that they conduce to the respiration of the brain, which is rich in hæmoglobin, and they have even been compared with gill-slits. In some forms the groove through which they open to the exterior is rhythmically contractile. It has also been suggested that they are sensory. Apart from these organs, Nemertines are very sensitive, and in many this is associated with a superficial nerve plexus. Tactile

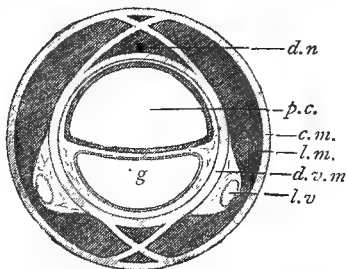

FIG. 105.—Transverse section of a simple Nemertean (*Carinella*).—After Bürger.

d.n., Dorsal nerve; *p.c.*, proboscis cavity; *g.*, gut; *c.m.*, circular muscles; *l.m.*, longitudinal muscles; *d.v.m.*, dorso-ventral or diagonal muscles; *l.v.*, lateral blood vessel.

papillæ and patches are often present; eyes and eye spots are general; and in some there are otocyst-sacs. Apart from the cephalic slits, the head also bears sensory pits and grooves and terminal sensory spots. In some there is a pair of lateral sense organs in the (anterior) nephridial region. The mouth is ventral, and leads into a plaited glandular fore-gut or cesophagus, which is followed by a straight, ciliated mid-gut (stomach and intestine), usually with regularly arranged lateral cæca. Between the cæca run transverse muscle partitions. The anus is in most cases terminal. In a cavity along the dorsal median line there lies the remarkable proboscis. It is protruded and retracted through an opening above, or, in a few cases, within the mouth. It arises as an invagination from in front, and is a muscular, very richly innervated tube lined with glandular epithelium, sometimes protruded with such force that it separates from the body, and then often retains its vitality for a long time, as if it were itself a worm. It has been compared in its retracted state to a glove-finger drawn in by

two threads attached to its tip, the threads being retractor muscles. But in front of the attachment of the retractor muscles there is a non-reversible glandular region which secretes an irritant fluid. In many cases there are stilets at the tip of the eversible portion, and if these be absent, there are stinging cells or adhesive papillæ. There is a hint of a similar structure in some Turbellarians, and the organ may be interpreted as one which was originally tactile, but which has become secondarily aggressive. It is protruded by the muscular contraction of the walls of the proboscis sheath, which forms a closed cavity surrounding the proboscis, and containing a fluid with corpuscles (Fig. 103).

In the majority there are three longitudinal blood vessels or spaces, a median and two laterals, which unite anteriorly and posteriorly, and also communicate by numerous transverse branches. The vessels or spaces are remnants of a cœlom. The blood is a colourless fluid, sometimes at least with nucleated elliptical corpuscles in which hæmoglobin may be present.

The excretory system usually consists of two coiled ciliated canals opening in the anterior region by a varying number of ducts. They are said to divide up internally into numerous fine branches ending in flame-cells, or in blind ampullæ embedded in the walls of the blood vessels.

The sexes are usually separate, and the reproductive organs are always simple. A few species (of *Geonemertes* and *Prosadenophorus*) are hermaphrodite, and some species of *Tetrastemma* are protandrous. The organs consist of simple sacs, arranged in a series on each side between the intestinal cæca, and communicating with the exterior by fine pores. The ova are often laid in gelatinous tubes, and are probably fertilised shortly before or at the time of expulsion. In three or four forms (*Prosorhochmus*, a fresh-water *Tetrastemma*, a species of *Lineus*) known to be viviparous, the fertilisation must, of course, be internal.

Segmentation is total and almost always equal; a complete or partial gastrula is formed, and development may be direct or indirect.

In *Cerebratulus*, etc., the larva is adapted for pelagic life, and is known as the Pilidium. "In external shape it resembles a helmet with spike and ear lobes, the spike being a strong and long flagellum or a tuft of long cilia, the ear lobes lateral ciliated appendages" (Hubrecht). Out of this, somewhat abruptly, the adult form arises.

Relationships.—The Nemertines are probably nearly related to Turbellaria, but show some very distinct marks of advance. Of these, the most noticeable are the presence of an anus, of a closed vascular system, of a cœlom at least in the larva. The presence of flame-cells in connection with the excretory system confirms the idea of Platyhelminth affinities; but it is to be noticed that the reproductive system is strikingly different. Professor Hubrecht has suggested that Nemertines exhibit affinities with Vertebrates, comparing proboscis sheath with notochord, and so forth.

Classification.

Order Protonemertini. Brain and lateral nerves outside the muscular layers; mouth behind brain; no stilets.

Carinella, Hubrechtia.

Order Mesonemertini. Lateral nerves in the muscular layer; mouth behind brain; no stilets.

Carinoma, Cephalothrix.

Order Metanemertini. Mouth in front of brain, usually opening along with proboscis; usually with stilets; lateral nerves internal to the muscular layers; usually with an intestinal cæcum.

e.g. Amphiporus, Drepanophorus, Tetrastemma.

An isolated form, *Malacobdella*, parasitic in bivalves, has a posterior sucker, a coiled intestine, and other peculiarities.

Order Heteronemertini. Mouth behind brain; no stilets; three layers of muscle, the outermost and innermost longitudinal; lateral nerves outside circular muscular layer.

e.g. Lineus, Cerebratulus.

Habits.—Most Nemertines are marine, creeping about in the mud, under stones, among seaweed, and the like; many, *e.g. Cerebratulus*, are able to swim; *Pelagonemertes* and *Planktonemertes* are leaf-like hyaline forms of pelagic habit; two or three species of *Prostoma* live in fresh water; seven species of *Geonemertes* are terrestrial; *Malacobdella* and a few others live in the mantle-cavity of marine bivalves, and some others are found as commensals in Ascidians; *Cephalothrix galatheæ* destroys the eggs of its host—the crustacean *Galathea*. Most seem to be carnivorous, eating annelids, molluscs, and even small crustaceans. Many break readily into pieces when irritated, and some are able to regenerate what they lose in this way. The fresh-water *Prostoma lumbricoides* forms a protective cyst of mucous threads in unfavourable conditions, and *Tetrastemma dorsale* often does the same along stems of the hydroid Tubularia.

PHYLUM NEMATHELMINTHES

Class Nematoda, *e.g. Ascaridæ.*

Class Nematomorpha, Gordiidæ.

Class Acanthocephala, *e.g. Echinorhynchus.*

Class NEMATODA. Thread-worms, Hair-worms, etc.

The Nematodes are unsegmented, more or less thread-like "worms," some of which are free-living and others parasitic. The body is covered by a cuticle, often thick, often subject to moulting; the muscular system consists of elongated muscle-cells arranged longitudinally, and usually leaving two free "lateral lines." From a nerve-ring around the gullet, six nerves go forwards and six backwards. The alimentary canal is usually well developed, has mouth and anus, and is divided into three regions. Vascular and respiratory systems are unrepresented; the cavity of the body is not cœlomic; the remarkable excretory system consists of two lateral canals opening anteriorly by a single pore. The sexes are usually separate and the reproductive organs simple; there is distinct sexual dimorphism. The life history is often intricate. There are many remarkable features such as the sluggish amœboid spermatozoa, the absence of cilia, and the absence of migratory phagocytes.

Type, *Ascaris megalocephala*, the Round-worm
of the horse

This round-worm occurs in the small intestine of the horse, while other species similarly infest man, ox, pig, etc. The body is cylindrical in cross-section and tapering at each end. The colour is dead-white, the absence of pigment being very characteristic of Nematodes. Some of the small thread-worms, e.g. *Trichostrongylus pergracilis* in the cæca of the grouse, are quite transparent and almost invisible when alive. At the anterior end is the mouth, furnished with three lips bearing sense papillæ; the anus is posterior and ventral. The male is smaller than the female, and has a recurved tail furnished with two horny spines and numerous sense papillæ. It is usually about seven inches long, while the female may be as much as seventeen.

(a) Most externally there is a thick chitinoid cuticle, perhaps of protective value. With its presence may be associated the scarcity of cutaneous glands, and the absence of cilia. (b) Beneath this is the sub-cuticula or epidermis, thickened along four longitudinal lines—median dorsal,

ventral, and lateral—and consisting of a protoplasmic matrix without distinct cell-limits. Except at the tail-end the nuclei are confined to the longitudinal lines, and are most numerous laterally. The epidermis makes and remakes the cuticle, which is periodically moulted. (c) Beneath the epidermis is a layer of remarkable muscle cells, lying in groups defined by the lines mentioned above. Many of the Nematodes are very agile.

Around the pharynx there is a nerve-ring from which six nerves run forwards and six backwards. One runs along the median dorsal line—a unique position in an Invertebrate. Here and there on the ring and on the nerves there are ganglionic cells, but there is but little aggregation of these into ganglia. Sense organs are represented by the papillæ already mentioned.

As the food consists of juices from a living host, it is not surprising to find that the alimentary canal has but a narrow cavity. It consists of three parts—a fore-gut or œsophagus, lined by the inturned cuticle, a mid-gut or mesenteron of endodermic origin, and a usually short hind-gut or rectum lined by the cuticle. When the external cuticle is shed, so is that of the fore-gut and hind-gut (cf. Crayfish).

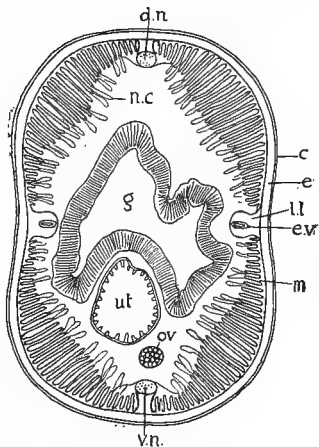

FIG. 106.—Cross-section through *Ascaris*.

d.n., Dorsal nerve; *n.c.*, non-contractile portion of muscle cells; *c.*, cuticle; *e.*, epidermis; *l.l.*, lateral line; *e.v.*, excretory vessel; *m.*, contractile portion of muscle cells; *v.n.*, ventral nerve; *ov.*, ovary; *ut.*, uterus; *g.*, gut.

There is a distinct space between gut and body wall, but it is lined externally by the muscle cells, internally by the endoderm of the gut, which has no mesoblastic coat; the space is therefore not strictly coelomic. It contains a clear fluid, which probably discharges some of the functions of blood. There are *no free amœboid phagocytes*.

Embedded in each lateral line there is a longitudinal canal. These

unite anteriorly, and open in a ventral excretory pore near the head. They seem to be associated internally with fixed phagocytic cells. In the species discussed there are four giant branched cells situated

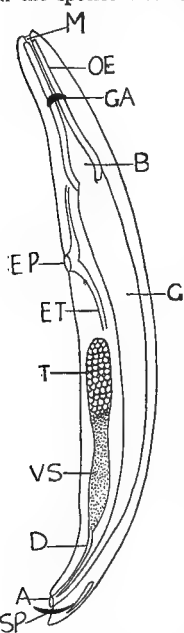

FIG. 107.—Diagram of the structure of a male Nematode.

M., mouth; *OE.*, oesophagus; *GA.*, nerve ring; *B.*, bulb at lower end of fore-gut; *G.*, mesenteron; *SP.*, spine with sheath; *A.*, anus; *D.*, ejaculatory duct; *VS.*, seminal vesicle; *T.*, testis; *ET.*, longitudinal excretory tube, cut short; *EP.*, excretory pore.

anteriorly, which are especially connected with taking up waste particles. The relation of this excretory system to that of other Invertebrates is unknown.

The sexes are separate. In the male the testis is unpaired—a coiled tube gradually differentiating into vas deferens, seminal vesicle, and ejaculatory duct. The genital aperture is close to the anus. The spermatozoa have not the typical form, and are sluggish. In the female the ovary is a paired tube, which passes gradually into an oviduct and a uterus at each side, and a short unpaired vagina. The genital aperture is ventral and anterior.

The ova meet the spermatozoa at the junction of uterus and oviduct. Segmentation is total, and results in the formation first of a blastula and then of a gastrula. The germ-cells are distinguishable very early from the body-cells. Blastopore and archenteron are obliterated, the mid-gut arising as a secondary splitting between two rows of endoderm cells. The eggs pass out of the gut of the host and probably hatch in water, and are thus re-introduced. No intermediate host has yet been found.

The Nematoda form an important group, interesting both on account of their parasitism and on account of their peculiarly isolated zoological position. Though parasitism is exceedingly common, many are free-living

for at least a part of the life cycle, and feed on putrefying organic matter. Again, although the number of individuals which may infest one host shows how successful the parasitism is, yet Nematodes exhibit few of the ordinary adaptations to a parasitic life, and there is no sharp structural line of demarcation between free and parasitic forms. Among

histological peculiarities, the absence of cilia—paralleled elsewhere only among the Arthropods—the nature of the muscle cells, the condition of the sub-cuticular layer, are to be noticed. Among the grosser structural peculiarities, the nature of the excretory system, of the body cavity, and of the nervous system, are worthy of special note. Sense-organs are never well developed, but in the free-living forms simple eyes may occur. The alimentary canal is usually completely developed, but may, as in *Sphærulearia*, be degenerate. Of the relationships nothing is known.

LIFE HISTORIES

1. The embryo grows directly into the adult, and both live in fresh or salt water, damp earth, and rotting plants—*Enoplidæ*, e.g. *Enoplus*.
2. The larvæ are free in the earth, the sexual adults are parasitic in plants, or in Vertebrate animals, e.g. *Tylenchus scandens*, a common parasite on cereals; *Strongylus* and *Dochmius* in man.
3. The sexual adults are free, the larvæ are parasitic in insects, e.g. *Mermis*. The fertilised females of *Sphærulearia bombi* pass from the earth into the body-cavity of humble-bee and wasp, whence their larvæ bore into the intestine and eventually emerge.
4. The larvæ are parasitic in one animal, the sexual adults in another which feeds on the first. Thus *Ollulanus* passes from mouse to cat, *Cucullanus* from *Cyclops* to perch.

There are other life histories, and many degrees of parasitism. The most remarkable form is *Angiostomum* (or *Ascaris* or *Leptodera nigrovenosum*). In damp earth males and females occur, the progeny of which pass into the lungs of frogs and toads. There they mature into hermaphrodite animals (the only example among Nematodes), which produce first spermatozoa and then ova. They are self-impregnating, and the young pass out into the earth as males or females. Here there is alternation of generations: and a somewhat similar story might be told of *Rhabdonema strongyloides* from the intestine of man, and *Leptodera appendiculata* from the snail.

There are several quaint reproductive abnormalities, thus—the female *Sphærulearia bombi*, which gets into the body cavity of the humble-bee, has a prolapsed uterus, larger than itself; the male of *Trichodes crassicauda* passes into the uterus of the female.

Some of the most Important Forms Parasitic in Man.

NAME.	POSITION.	HISTORY.	RESULT ON HOST.
<i>Ascaris lumbricoides</i> , maw-worm (common). [<i>A. mystax</i> , common in dogs and cats, has also been found in man.]	Usually in small intestine.	Repeated experiment has shown that infection results if the eggs (with their outer envelope entire) are swallowed along with vegetable food or otherwise.	Commonest in children; rarely dangerous, unless very numerous, or wandering into other parts of the body, e.g. respiratory tract, bile duct, vermiform appendix. Like others, it may puncture the wall of the gut and liberate pathogenic bacteria.
<i>Oxyuris vermicularis</i> (common).	From stomach to rectum, mostly in colon.	From food or water.	Rarely more than discomfort.
<i>Trichocephalus dispar</i> or <i>trichinurus</i> , the whip-worm (common).	Colon; more rarely appendix and small intestine.
<i>Ancylostomum duodenale</i> (widely distributed). <i>Rhabdonema strongyloides</i> .	Small intestine. Associated with <i>Ancylostomum</i> .	The larvæ seem to live freely in the earth. Infection by ingestion or cutaneously.	Ulceration, hæmorrhage, and dangerous anæmia. It was common in the workers at the Mont Cenis Tunnel, and has occurred in Cornish mines.
<i>Filaria bancrofti</i> (Australia, China, India, Egypt, and Brazil).	Mature female (80-100 mm.) in lymphatic glands, embryos in blood. Males rare (30-45 mm.).	Larvæ in a mosquito.	Elephantiasis and hæmaturia.
<i>Dracunculus (Filaria) medinensis</i> (Guinea-worm), in Arabia, Egypt, Abyssinia, etc.	The female is 1-6 ft. long, encysts beneath skin, especially of back or legs. Male rarely seen.	Larvæ in a <i>Cyclops</i> .	Subcutaneous abscesses.
<i>Trichina (Trichinella) spiralis</i> .	Becomes sexually mature in the intestine; embryos, produced rapidly and viviparously, find their way to muscles, and become encysted.	From "trichinosed" pig's muscle to man.	Inflammatory processes, often fatal, are brought about by the migration of the young worms from intestine to muscles.

Trichina.—The formidable *Trichina* deserves fuller notice. It is best known as a parasite in man, pig, and rat, but occurs also in hedgehog, fox, marten, dog, cat, rabbit, ox, and horse. The sexual forms live in the intestine, the female about 3 mm. in length, the male less than half as long. After impregnation the female brings forth numerous embryos viviparously, sixty to eighty at a time, and altogether about 1500. These are produced in the wall of the intestine, or in the adjacent lymphatic spaces. Most of them find their way into lymph and blood vessels, and are swept by the blood stream to the muscles; occasionally some seem to migrate actively, boring their way especially through connective tissue. The migration causes inflammation and fever. In or between the muscle fibres they grow, coil themselves



FIG. 108.—Trichinæ in muscle, about to be encapsuled.—After Leuckart.

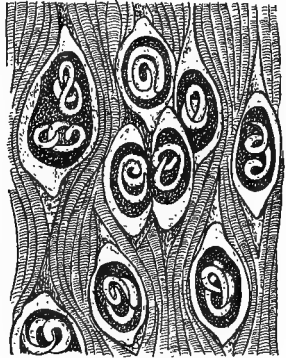

FIG. 109.—Trichinæ in muscle, encapsuled. There may be 12,000 in a gramme of pig's muscle.—After Leuckart.

spirally, and become encysted within a sheath, at first membranous and afterwards calcareous (Figs. 108 and 109). The cyst is partly due to the muscle, and partly to the parasite. The infected muscle fibre degenerates. In these cysts, which may be sometimes counted in millions, the young *Trichinæ* remain passive, unless the flesh of their host be eaten by another,—pig eating rat, man eating pig. In the alimentary canal of the new host the capsule is dissolved, the embryos are set free, and become in two or three days reproductive. The male seems to die after copulation.

Among the numerous other parasitic Nematodes the following may be noted :—The giant palisade worm (*Eustrongylus gigas*) occurs in the renal region of domestic animals, etc. ; the female may be 3 ft. long. The armed palisade worm (*Strongylus armatus*) occurs in the intestine

and intestinal arteries of horse, causing aneurisms, colic, etc. The young forms are swallowed from stagnant water, bore from gut into arteries, become adult, return to gut, copulate and multiply. Various other species of *Strongylus* occur in sheep, cattle, etc. Of the genus *Ascaris* alone, over 200 species have been found in all types of Vertebrates;—*A. megalcephala* in horses, *A. lumbricoides* in man, *A. mystax* in cats and dogs. *Syngamus trachealis* occurs in the trachea of birds, causing "gapes," e.g. in poultry and pheasants. It pierces the wall of the trachea, and "actually clenches the teeth with which its mouth is provided in the tracheal rings." A remarkable large form, *Ichthyonema grayi*, is found inside sea-urchins. Various species of *Tylenchus*, especially *T. devastatrix* and *T. scandens* (or *T. tritici*), destroy cereal and other crops. Various species of *Heterodera* (especially *H. schachtii* and *H. radicumicola*) infest the roots of many cultivated plants, e.g. turnip, radish, cabbage.

Class NEMATOMORPHA

The Gordiidæ (e.g. *Gordius aquaticus*—the horse-hair worm) are so different from true Nematodes that they must be ranked in a separate class. There are no lateral lines. Three nerve-strands lie close together in the mid-ventral line. In the adult *Gordius* the mouth is shut and the food canal is partly degenerate. The adult Gordiidæ usually live freely in fresh water; larval forms occur in aquatic molluscs, young insects, etc.; later stages usually occur in carnivorous insects, whence they emerge to become adult in the water. One form, *Nectonema agile*, is marine.

Class ACANTHOCEPHALA

For a few genera, of which the best known is *Echinorhynchus*, whose larvæ live in Arthropods, and the adults in Vertebrates, a special class, ACANTHOCEPHALA, has been established. They may be placed beside Nematodes, but the relationship does not seem to be very close. Mouth and gut are absent. The anterior end bears a protrusible hooked proboscis used in boring in the intestinal wall of the host. In the minute swellings at the ends of the two much-branched excretory organs of *E. gigas*, there are ciliated cells,—the only case known among Nematohelminthes.

Echinorhynchus proteus of pike, minnow, trout, etc., larva in the Amphipod *Gammarus pulex*.

„ *angustatus* of perch, larva in the Isopod *Asellus aquaticus*.

„ *moniliformis* of rat, etc., larva in larval beetles (*Blaps*).

„ *gigas* of pig, larva in grubs of cockchafer, etc.

CHAPTER XI

PHYLUM ANNELIDA

Chief Classes—CHÆTOPODA, DISCOPHORA

THE Annelids or Annulata are segmented "worms," in most of which the segmentation of the body is visible externally. The head usually consists of a pre-oral "prostomium" and a post-oral peristomium. The body wall has several layers of muscles, and many, e.g. Chætopods, have setæ embedded in the skin. In most, there is a well-developed cœlom, communicating with the exterior by paired nephridia. The nervous system consists typically of two dorsal cerebral ganglia, a commissural ring round the gullet, and a ventral ganglionated chain. The gonads arise on the cœlomic epithelium. Not infrequently the nephridia function also as genital ducts. The development may be direct or indirect, and if indirect it usually includes a larval Trochosphere stage.

In habit, form, and structure the Annelids exhibit much diversity. The Chætopods, represented on the one hand by the familiar earthworm, and on the other by the marine worms, best illustrate the typical Annelid structure. With these, however, may be included the aberrant Echiuridæ, e.g. *Echiurus* and *Bonellia*. A few primitive forms (Archi-Annelida), and the Myzostomata (parasitic on Crinoids), may also be appended to the Chætopod class. The leeches (Discophora) are probably Annelids which have diverged in consequence of a peculiar half-parasitic habit. Finally, some zoologists include *Sagitta* (Chætognatha) in this series as an Annelid with three segments, and also the Rotifers (Rotatoria), whose adult form somewhat resembles the Trochosphere larvæ of many Annelids.

Class CHÆTOPODA. Annelids with Bristles

Segmented animals with setæ developed in little skin-sacs, either on a uniform body wall or on special locomotor protrusions known as parapodia. The segments, indicated externally by rings, are often marked internally by partitions running across the body cavity, which is usually well developed. The nervous system generally consists of a double ventral chain of ganglia, connected with a pair of dorsal cerebral ganglia by a ring round the beginning of the gut. Two excretory tubes or nephridia are typically present in each segment, and they or their modifications may also function as reproductive ducts. The reproductive elements are formed on the lining membrane of the body cavity. The development is either direct or with a metamorphosis.

The two chief orders of this class may be contrasted :—

OLIGOCHÆTA, e.g. Earthworm.	POLYCHÆTA, e.g. <i>Nereis</i> .
With no parapodia, and with relatively few setæ. Without any "jaw" apparatus in the pharynx. Head not highly developed. No tentacles or cirri. Gills in a few forms. With complex hermaphrodite reproductive organs, limited in number and definitely localised. Development direct. Living in fresh water or in the soil.	With parapodia and with very numerous setæ. The pharynx is often armed with "jaws." The head is much more developed, and bears tentacles and cirri. Gills are often present. Sexes usually separate, and reproductive organs simple. A metamorphosis in development. Marine, with two or three exceptions.

Type of OLIGOCHÆTA. The Earthworm (*Lumbricus*)

Habits.—Earthworms eat their way through the ground, and form definite burrows, which they often make more comfortable by a lining of leaves. The earth swallowed by the burrowers is reduced to powder in the gut, and, robbed of some of its decaying vegetable matter, is discharged on the surface as the familiar "worm-castings." By the burrowing the earth is loosened, and ways are opened for plant-roots and rain-drops; the internal bruising reduces mineral matter to more useful form; while, in covering the surface with earth brought up from beneath, the earth-

worms have been ploughers before the plough. Darwin calculated that there were on an average over 53,000 earthworms in an acre of garden ground, that 10 tons of



FIG. 110.—Earthworms.

soil per acre pass annually through their bodies, and that they cover the surface with earth at the rate of 3 in. in fifteen years. He was therefore led to the conclusion that earthworms have been the great soil-makers, or, more

precisely, that the formation of vegetable mould was mainly to be placed to their credit.

Though without eyes, earthworms are sensitive to light and persistently avoid it, remaining underground during the day, unless rain floods their burrows, and reserving their active life for the night. Then, prompted by "love" and hunger, they roam about on the surface, leaving on the moist roadway the trails which we see in the morning. More cautiously, however, they often remain with their tails fixed in their holes, while with the rest of their body they move slowly round and round. The nocturnal peregrinations, the labour of eating and burrowing, the transport of leaves to their holes, the collection of little stones to protect the entrance to the burrows, include most of the activities of earthworms, except as regards pairing and egg-laying, of which something will afterwards be said. When an earthworm is halved with the spade, it does not necessarily die, for the head portion may grow a new tail, while a decapitated worm may even grow a new head and brain. Phagocytes help as usual in the regeneration. The earthworm is much persecuted by numerous enemies, *e.g.* centipedes, moles, and birds. The male reproductive organs are always infested by unicellular parasites—Gregarines of the genus *Monocystis*; and minute thread-worms (*Pelodera pello*) usually occur in the nephridia and body cavity, and often in the ventral blood vessels.

Form and external characters.—The earthworm is often about 6 in. long, with a pointed head end, and a cylindrical body rather flattened posteriorly. The successive rings seen on the surface mark true segments. The mouth is overarched by a small lobe called the prostomium, and the food canal terminates at the blunt posterior end. The skin is covered by a thin transparent cuticle, traversed by two sets of fine lines, which break up the light and produce a slight iridescence. On a region extending from the 31st to the 38th ring, the skin of mature worms is swollen and glandular, forming the clitellum or saddle, which helps the worms as they unite in pairs, and also forms the slimy stuff which hardens into cocoons. The middle line of the back is marked by a special redness of the skin. On the sides and ventral surface we feel and see four rows of tiny bristles or setæ, which project from little sacs, are worked by muscles, and assist in locomotion. These bristles are fixed like pins into the ground, at times so firmly that even a bird finds it difficult to pull the worm from its hole. As each of the four longitudinal rows is double, there are obviously eight bristles to each ring. On the skin of the ventral

surface there are not a few special apertures, which should be looked for on a full-grown worm; but careful examination of several specimens is usually necessary. Almost always plain on the 15th ring are the two swollen lips of the male ducts, less distinct on the 14th are the apertures of the oviducts through which the eggs pass, while on each side, between segments 9 and 10, 10 and 11, 11 and 12, 12 and 13, 13 and 14, are the openings of two receptacula seminis or spermathecae into which male elements from another earthworm pass, and from which they again pass out to fertilise the eggs of the earthworm when these are laid. Each segment contains a pair of excretory tubes, which have minute ventral-lateral apertures, while on the middle line of the back, between the rings, there are minute pores, through which fluid from the body cavity may exude on to the skin.

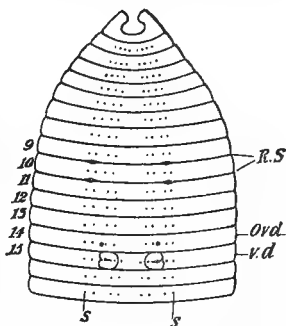

FIG. III.—Anterior region of earthworm.—After Hering.

Skin and bristles.—The thin cuticle is produced by the cells which lie beneath, and is perforated by the apertures previously mentioned.

The epidermis clothing the worm is a single layer of cells, of which most are simply supporting or covering elements, while many are slightly modified, as glandular or mucous cells, and as nervous cells. As the latter are connected with afferent fibres which enter the nerve-cord, the skin is diffusely sensitive. In a few species the skin is slightly phosphorescent. The chitinous bristles, which are longest on the genital segments, are much curved, and lie in small sacs of the skin, in which they can be replaced after breakage.

Muscular system and body cavity.—The earthworm moves by the contraction of muscle cells, which are arranged in circular hoops and longitudinal bands underneath the skin. The special muscles above the mouth and pharynx have considerable powers of grasping, while less obvious muscular elements occur in the wall of the gut, in the partitions which run internally between the

Note the eight setæ (*s.*) on each segment. *R.S.*, Spots between 9-10, 10-11, indicate openings of receptacula seminis; *Ovd.*, openings of oviducts on segment 14; *v.d.*, openings of vasa deferentia on segment 15.

segments, and on the outermost portions of the excretory tubes.

Unlike the leech, the earthworm has a very distinct body cavity, through the middle of which the gut extends, and across which run the partitions or septa incompletely separating successive segments. In this cavity there is some fluid with cellular elements, of which the most numerous are yellow cells detached from the walls of the gut. Possible communications with the exterior are by the dorsal pores, and also by the excretory tubes, which open internally into the cavities of the segments.

Nervous system.—Along the middle ventral line lies a chain of nerve-centres or ganglia, really double from first to last, but compactly united into what to unaided eyes seems a single cord. As the segments are very short, the limits of the successive pairs of ganglia are not very evident, especially in the anterior region, but they are plain enough on a small portion of the cord examined with the microscope, when it may also be seen that each of the pairs of ganglia gives off nerves to the walls of the body. Anteriorly, just behind the mouth, the halves of the cord diverge and ascend, forming a ring round the pharynx. They unite above in two dorsal or cerebral ganglia, which are situated in the peristomium or first ring, and not, as in *Polychætes*, in the prostomium. These form the earthworm's "brain," and give off nerves to the adjacent pre-oral lobe or prostomium, on which are numerous sensitive cells. These, coming in contact with many things, doubtless receive impressions, which are transmitted by the associated nerves to the "brain." As Mr. Darwin observed that earthworms seized hold of leaves in the most expeditious fashion, taking the sharp twin leaves of the Scotch fir by their united base, we may credit the earthworms with some power of profiting by experience; moreover, as they deal deftly with leaves of which they have no previous experience, we may even grant them a modicum of intelligence. From the nerve-collar uniting the dorsal ganglia with the first pair on the ventral cord, nerves are given off to the pharynx and gut, forming what is called a "visceral system." The earthworm has no special sense organs, but there are abundant sensitive cells, especially on the head end. By them the

animal is made aware of the differences between light and darkness, and of the approaching tread of human feet, not to speak of the hostile advances of a hungry blackbird. The sense of smell is also developed. The afferent or sensory nerve fibres from the nervous cells of the skin enter the nerve-cord and bifurcate into longitudinal branches, which end freely in the nearest ganglia. In this the earthworm's nervous system suggests that of Vertebrates.

The nerve cells, instead of being confined to special centres or ganglia, as they are in Arthropods, also occur diffusely along with the nerve fibres throughout the course of the cord. Along the dorsal surface of the nerve-cord there run three peculiar tubular "giant fibres," with firm walls and clear contents. They are probably comparable to the medullated nerve fibres of Vertebrates.

Alimentary system.—Earthworms eat the soil for the sake of the plant débris which it may contain, and also because one of the modes of burrowing involves swallowing the earth. In eating they are greatly helped by the muscular nature of the pharynx; from it the soil passes down the gullet or œsophagus, first into a swollen crop, then into a strong-walled grinding gizzard, and finally through a long digestive and absorptive stomach-intestine. There are three pairs of œsophageal glands. Canals from the posterior two pairs open into the anterior pair, and thus into the gullet. Their contents are limy, and perhaps counteract the acidity of the decaying vegetable matter. It may be that they are in part excretory; or it may be that they serve to fix some of the carbon dioxide formed by the animal. The long intestine has its internal surface increased by a dorsal fold, which projects inwards along the whole length. In this "typhlosole," and over the outer surface of the gut, there are crowded yellow cells.

There is no warrant for calling the yellow cells hepatic or digestive. Structurally they are pigmented cells of the peritoneal epithelium, which here, as in most other animals, lines the body cavity and covers the gut. As to their function, they absorb particles from the intestine, and go free into the body cavity, whence, as they break up, their débris may pass out by the excretory tubes. When a worm has been made to eat powdered carmine, the passage of these useless particles from gut to yellow cells, from yellow cells to body cavity, and thence out by the excretory tubes, can be traced. The amœboid cells of the body cavity fluid act as phagocytes. Various ferments have been

detected in the gut, a diastatic ferment turning the starchy food into sugars, and others—peptic and tryptic—not less important. The wall of the stomach-intestine from without inwards, as may be traced in sections, is made up of pigmented peritoneum, muscles, capillaries, and an internal ciliated epithelium. In the other parts of the gut the innermost lining is not ciliated, but covered with a cuticle.

Vascular system.—The fluid of the blood is coloured red with hæmoglobin, and contains small corpuscles. Along

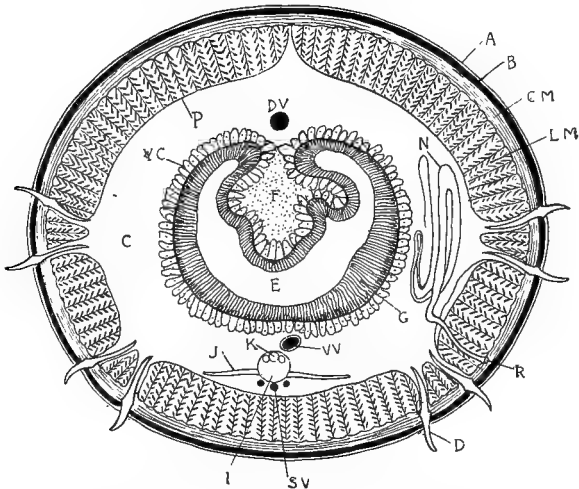

FIG. 112.—Transverse section of earthworm.

A., Cuticle; *B.*, epidermis; *C.M.*, circular muscles; *L.M.*, longitudinal muscles; *D.*, a seta; *C.*, coelom; *Y.C.*, yellow cells; *F.*, typhlosole; *V.V.*, supra-neural blood vessel; *S.V.*, sub-neural vessel; *D.V.*, dorsal vessel; *P.*, peritoneum; *E.*, cavity of gut; *G.*, endodermic lining of gut; *N.*, part of a nephridium; *R.*, opening of a nephridium; *I.*, the nerve-cord; *J.*, a nerve given off; *K.*, giant fibres in the nerve-cord.

the median dorsal line of the gut a prominent blood vessel extends, another (supra-neural) runs along the upper surface of the nerve-cord, another (infra-neural) along the under surface, while two small latero-neurals pass along each side of this same cord. All these longitudinal vessels, of which the first three are most important, are parallel with one another; the first three meet in an anterior network on the

pharynx; the dorsal and the supra-neural are linked together in the region of the gullet by five or six pairs of contractile vessels or "hearts."

Respiration is effected by the distribution of blood on the general surface of the skin.

Excretory system.—There is a pair of nephridia in each segment except the first four. Each opens internally into the segment in front of that on which its other end opens to the exterior. They remove little particles from the body cavity, and get finer waste products from the associated blood vessels. Nephridia occur in many animals, in most young Vertebrates as well as among Invertebrates, but they are never seen more clearly than in the earthworm. When a nephridium is carefully removed, along with a part of the septum through which it passes, and examined under the microscope, the following three parts are seen:—
(a) An internal ciliated funnel; (b) a trebly coiled ciliated tube, at first transparent, then glandular and granular; and (c) a muscular duct opening to the exterior. Minute particles swept into the ciliated funnel pass down the ciliated coils of the tube, and out by the muscular part which opens just outside of the ventral bristles. The coiled tube consists in part at least of a series of intracellular cavities, that is to say, it runs through the middle of the cells which compose it; the external muscular portion arises from an invagination of skin.

Reproductive system.—Like all Oligochætes, the earthworm is hermaphrodite and the organs complex. The complexity is produced by the specialisation of certain of the nephridia to form genital ducts and accessory organs and by the presence of chambers (seminal vesicles) connected with the testes, formed by the shutting off of portions of the body cavity.

The organs in the earthworm are difficult to dissect, and differ considerably in old and young specimens.

(a) The *Male Organs* consist of two pairs of testes, three pairs of seminal vesicles, and paired vasa deferentia.

(1) The testes, flattened lobed bodies, about $\frac{1}{10}$ in. in size, arise from proliferations of the peritoneal lining of the body cavity, and are invested by a delicate membrane derived therefrom; they lie near the nerve-cord, attached to the

posterior surfaces of the septa between segments 9-10 and 10-11. They are minute, translucent, and difficult to see. In immature worms they lie exposed in the body cavity; in mature worms they are concealed by the great development of the seminal vesicles.

(2) The seminal vesicles are much-lobed structures, exceedingly prominent in dissection. Small and laterally placed in young worms, in the adult the anterior two

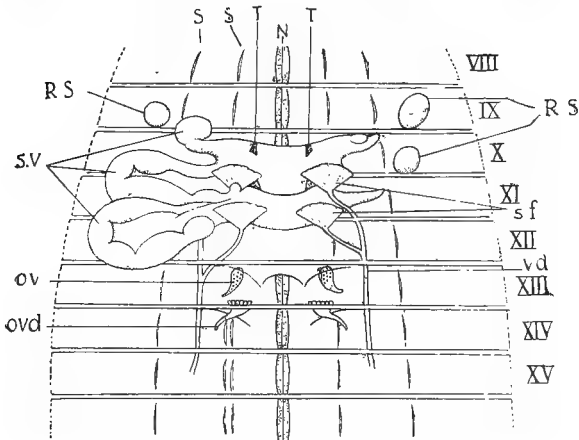

FIG. 113.—Reproductive organs of earthworm.—
After Hering.

N., Nerve cord; *T.*, anterior testes; *S.*, sacs of setæ; *R.S.*, receptacula seminis; *s.f.*, seminal funnels; *v.d.*, vas deferens; *ovd.*, oviduct; *ov.*, ovary; *sv.*, seminal vesicles cut open; *VIII.-XV.*, segments.

pairs fuse in the middle line and cover the anterior pair of testes and its ducts, while the posterior pair similarly conceals the second pair of testes with its ducts. Into the seminal vesicles mother sperm cells from the testes pass, and there divide up to form spermatozoa.

Development shows that the seminal vesicles arise as outgrowths of the septa of segments 9-12, and that their lumen is a portion of the body cavity. This is of importance,

for in Polychætes the genital products mature in the general body cavity, just as the spermatozoa in the earthworm mature in the seminal vesicles.

(3) From the seminal vesicles the spermatozoa are carried to the exterior by means of the vasa deferentia. The internal openings of these are large and funnel-shaped, and are concealed by the seminal vesicles. Each of the four funnels opens into a duct, and the two ducts unite at each side to form the two elongated vasa deferentia, which pass backwards to open externally on the 15th segment.

(b) The *Female Organs* consist of two ovaries and two oviducts, each of which has a side receptacle for the eggs.

(1) The two ovaries are small bodies situated near the nerve-cord on the septum between segments 12-13. Each is pear-shaped, the stalk of the pear being a string of ripe ova. They are more readily seen than the testes.

(2) The two oviducts open internally on the anterior face of the septum between 13-14, and externally on the ventral surface of segment 14. Into the wide ciliated internal mouths, which lie opposite the ovaries, the ripe eggs pass.

(3) The egg-sac or receptaculum ovarum, near the internal mouth of each oviduct, is a posterior diverticulum of the septum between segments 13-14. Within it a few mature ova are stored.

(c) Two pairs of receptacula seminis or spermathecæ receive spermatozoa from *another* earthworm, and liberate them to fertilise the eggs of this one. They are white globular sacs, opening in the grooves between segments 9-10 and 10-11, and probably, like the genital ducts, arise from modified nephridia. According to some, these spermathecæ not only receive and store spermatozoa, but make them into packets or spermatophores. Others say that the glands of the clitellum make these packets. At any rate, minute thread-like packets of spermatozoa are formed, and a pair of them may often be seen adhering to the skin of the earthworm about the saddle region.

When two worms unite sexually, they lie apposed in opposite directions, the head of the one towards the tail of the other. What happens is that the spermatozoa of the one pass into the receptacula of the other.

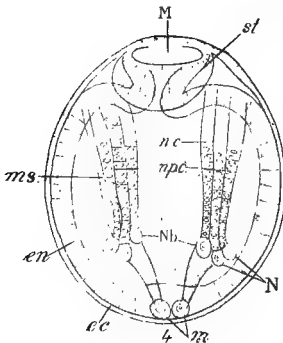
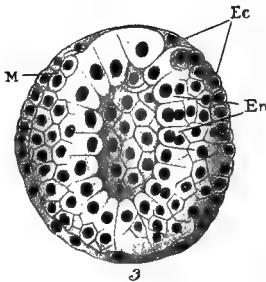
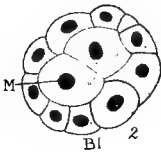
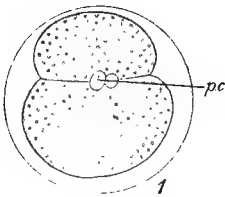

When the eggs of an earthworm are liberated, they are surrounded by a sheath of gelatinous stuff, believed to be secreted by the saddle. As this is peeled off towards the head, spermatophores are also enclosed.

Development. — Many cocoons are made about the same time, and each contains numerous ova, and also packets of sperms, so that fertilisation takes place outside the body. These cocoons are buried in the earth a few inches below the surface. They measure about a quarter of an inch in length.

The favourite time for egg-laying is during the spring and summer, though it may be continued throughout the whole year. The earthworm of the dungheap (*L. fetidus*) makes this a habit, induced probably by the warmth of its environment.

Of the many ova in the cocoon of *L. terrestris*, only one comes to maturity, while in *L. fetidus* a few, and in *L. communis* two may do so. But in the last species

FIG. 114.—Stages in the development of earthworm. — After Wilson.

1. Two-celled stage; *pc.*, polar bodies.
2. Blastula; *M.*, a primary mesoblast.
3. Gastrula stage; *Ec.*, ectoderm or epiblast; *En.*, endoderm or hypoblast, in process of being covered by the small ectoderm cells. Note the widely open blastopore; *M.*, mesoblast cells.
4. Longitudinal section in late gastrula stage, showing germ-bands; *ec.*, ectoderm; *en.*, endoderm; *M.*, mouth; *st.*, stomodæum; *ms.*, primary mesoblasts; *Nb.*, neuroblasts; *nc.*, nerve-cord; *N.*, nephridioblasts; *ms.*, mesoderm bands; *npc.*, incipient nephridia.

the two embryos are often twins formed from one ovum, separation taking place at the gastrula stage.

The whole process of growth, until leaving the egg, lasts from two to three weeks, the time varying, however, with the temperature.

The ovum is surrounded by a vitelline membrane, and is laden with yolk granules. Segmentation is slightly unequal (Fig. 114 (1)), and exhibits considerable variation even within the limits of a species.

In about twenty-four hours a nearly spherical, one-layered blastosphere or blastula is formed. It consists of only about thirteen cells. During the next twenty-four hours the cells increase in number rapidly, but the blastula remains one-layered. Two cells lying together do not take part in this division; they are rather larger than the rest, and their inner ends project into the cavity, and are soon cut off as daughter-cells. Gradually the large cells still undergoing division begin to sink in, and at last are quite included in the cavity (Fig. 114 (2)). Thus there arise two parallel rows of cells within the blastula, and these define the longitudinal axis of the embryo. This is the beginning of the mesoblast which forms all the muscles of the trunk, and which thus takes origin from two primary mesoblasts.

After five to six pairs of secondary mesoblasts have been formed, the blastula begins to flatten, and to elongate, becoming an oval disc. The cells of the lower surface become clearer, and the hypoblast is thus defined. The cells of the upper surface are smaller, and become very much flattened; they compose the epiblast. The mesoblasts lie side by side near one end, forming two rows extending forwards and downwards, but divergent, because of the flattening of the blastula. The hypoblast now becomes concave, and thus the blastopore arises, occupying the whole of the lower surface (Fig. 114 (3)). The sides close in and the blastopore becomes a slit, which further closes from behind forwards, leaving only a small opening—the future mouth. During these processes the cells at the anterior tip of the blastopore, which will give rise to the pre-oral lobe, undergo no change, but the mesoblast has been active.

As gastrulation proceeds, the mesoblast rows grow forwards and upwards, until they come near each other above the anterior tip of the blastopore, while their middle portions are carried downwards until they lie on the ventral surface. Over them the epiblast is thickened in two bands. Two longitudinal rows of epiblast cells near the anterior end, and ending behind in large cells, sink in just as the primary mesoblasts did. The thickening now extends ventrally until the two bands meet and, passing into the blastopore, form the stomodæum. Even before this the embryo has begun to swallow the albumen in which it floats.

There are now two lateral bands of cells called the germ bands, composed of three layers (Fig. 114 (4)); outside is the thickened epiblast, next the rows of cells which sank in, and innermost the mesoblast rows. The mesoblast rows have met in the middle line by dividing and widening out into a pair of flattened plates, but they still end behind in the two primary mesoblasts. Cœlomic cavities develop in the plates, and the anterior ends meet above the mouth. The epiblastic rows which sank in (there were eight of them, four on each side of the median line, and each ending in a large mother-cell) go on

growing. The mother-cells are apparently carried backwards as the embryo lengthens, leaving a trail of daughter-cells behind them. The cells so formed also divide, the embryo rapidly lengthening and finally becoming vermiform. Of the eight rows the innermost on each side (neuroblasts) give rise to the nervous system, the next two rows on either side (nephridioblasts) form parts of the nephridia (Fig. 114 (4)), while of the fourth row nothing definite is known. Each row, ending behind in a single cell, widens out and deepens as it is traced forwards. The neural and mesoblastic rows can be traced round the mouth, and help to form the prostomium; the others fade away at the sides of the stomodæum.

Let us sum up this complex history:—

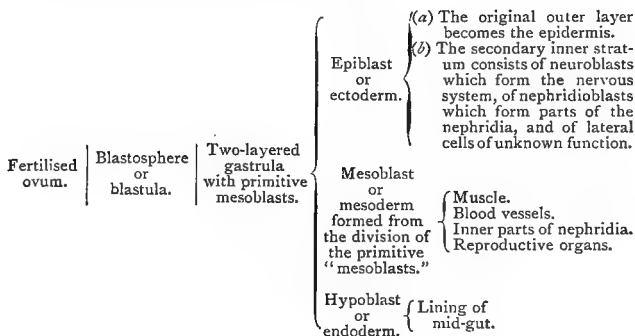

Type of POLYCHÆTA. The Lob-worm (*Arenicola marina*)

Habits.—On the flat sandy beach uncovered at low tide, the "castings" of the lob-worm or lug-worm are very numerous. There the fishermen seek the worms for bait, and have to dig quickly, for the burrowers retreat one to two feet into the sand. The burrows are curved tubes, lined by a yellowish green secretion from the animal's epidermis, and the surrounding sand is often discoloured by some change which the secretion effects on the iron oxides and other constituents. The tubes are at first vertical, afterwards oblique or horizontal, and then turn vertically upwards again.

The lob-worm burrows like the earthworm, not only forcing the anterior part of its body onwards, but eating the

sand for the sake of the organic particles and small organisms which it contains. The sandy castings, which pass from the end of the food canal, and are got rid of at the mouth of the tube, fall into spiral coils. It has been calculated that in a year the average volume of sand per acre thus brought up in castings is about 1900 tons, representing a layer of 13 in. spread out over the surface. This work, comparable to that of earthworms, tends to cleanse the sand and to reduce it to a finer powder. When getting rid of the casting, the worm lies with its tail upwards and its head downwards, or with its body bent like a bow; when the tide comes in, the mouth may protrude at the other end of the U-shaped tube. The worms that live between tide-marks seem to differ in many respects (as to colour, gills,

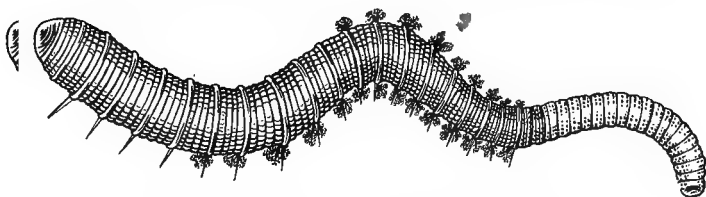

FIG. 115.—*Arenicola marina*.

Entire animal viewed slightly from left side. Note anterior mouth; setæ on anterior region; setæ and gills on median region; thinner tail region often longer than shown.

habits, and sexual maturity) from those which occur in the Laminarian zone, which is only uncovered at low spring-tides.

External appearance.—The lob-worm varies in length from 8 to 16 inches, and at its thickest part is about half an inch in diameter. There are three regions in the body: (*a*) The anterior seven segments, of which all but the first have bristles; (*b*) the middle region of thirteen segments, with both gills and bristles; (*c*) the thinner posterior part of variable length, without either gills or bristles, and with an inconstant number of segments (up to about thirty). In the very front there is a head-lobe or prostomium, but there are no tentacles or eyes. Anteriorly a soft proboscis is often protruded from the gut. The anus is terminal.

Skin, muscles, and appendages.—Each segment is marked by about four superficial rings. The epidermis is pigmented and secretes mucus, and is divided into numerous polygonal areas, separated by shallow grooves. Beneath the epidermis is a sheath of circular muscles, and then a layer of longitudinal muscles. Besides these there are (from the middle of the gullet to the beginning of the tail) thin oblique muscles arising from the sides of the nerve-cord, and dividing the body cavity longitudinally into a central and two lateral compartments. Other muscles control the prostomium, the proboscis, and the bristles. Unlike many of the marine Annelids, *Arenicola* has very rudimentary appendages. This reduction of appendages must be associated with the animal's mode of life; it occurs also in many tube-inhabiting worms. Neither the prostomium nor the first segment show any trace of appendages, but the next nineteen have rudiments. The dorsal part (notopodial) consists of a tuft of bristles, whose bases are enclosed in a sac;—the ventral part (neuropodial), separated by a short interval, bears several hooks.

Nervous system.—This is in its general features like that of the earthworm, but ganglia are not developed. In the ventral nerve-cord, the ring round the gullet, and the slight cerebral enlargement which represents a brain, nerve cells occur diffusely scattered among the nerve fibres. Along the dorsal surface of the nerve-cord, in the branchial region, there are two "giant fibres" like those in the earthworm; anteriorly and posteriorly there is only one.

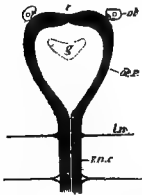

FIG. 116. — Anterior part of nervous system in *Arenicola*.— After Vogt and Yung.

c., Cerebral part on dorsal surface; a.r., oesophageal ring; g., gullet; v.n.c., ventral nerve-cord; l.n., lateral nerves; ot., otocyst.

The prostomial lobes are diffusely sensory, and bear also two ciliated, probably olfactory, pits—the "nuchal organs." Otherwise sense organs are represented only by a pair of otocyst sacs (Fig. 116), one on each side of the oesophageal nerve-ring. These sacs, like those

which occur in many other Invertebrates, seem to have to do rather with the direction of the animal's movements than with hearing. Professor Ehlers notes an interesting series: In *A. claparedii* there are simply two open grooves; in *A. marina* the sacs have open necks, and contain

foreign particles; in *A. grubii* and *A. antillensis* the sacs are closed, and contain intrinsic otoliths of lime.

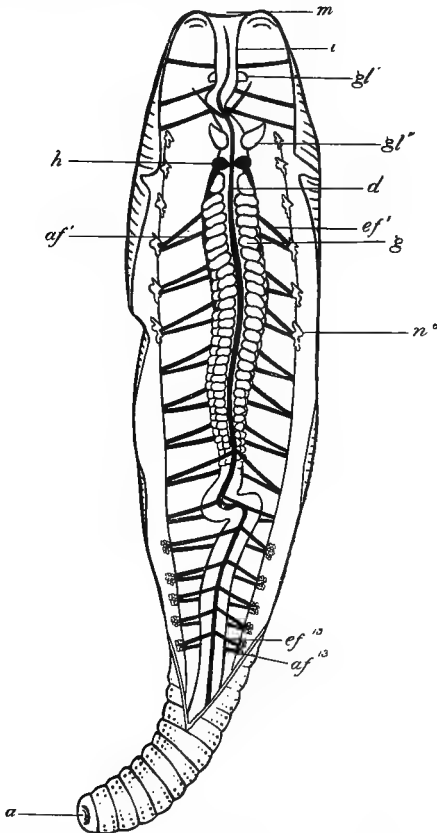

FIG. 117.—Dissection of lob-worm from dorsal surface.

m., Opening of retracted buccal cavity; *i.*, gullet; *gl'*, diverticula on first diaphragm; *gl''*, oesophageal glands; *d.*, dorsal blood vessels; *ef*¹, first efferent branchial; *g.*, stomach intestine; *n*⁶, sixth nephridium; *ef*¹³, thirteenth efferent branchial; *af*¹³, thirteenth afferent branchial; *a.*, anus; *af*¹, first afferent branchial; *h.*, heart of left side.

Food canal.—(1) The buccal cavity is protrusible as a “proboscis” or introvert, which grips the sand, and bears internal papillæ with chitinous tips. The protrusion is due to the pressure of the cœlomic fluid, while special muscles bring about retraction. (2) The gullet has smooth walls, and bears a posterior pair of glands, which secrete a yellowish fluid, probably digestive. (3) The gastric region, from the heart to the twelfth or thirteenth notopodium, is covered with yellow cells and many blood vessels, and has a

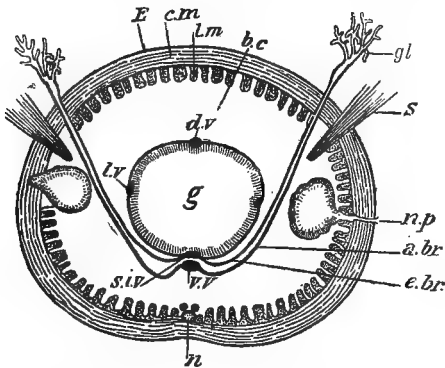

FIG. 118.—Cross-section of *Arenicola*.—After Cosmovici.

E., Epidermis; *c.m.*, circular muscles; *l.m.*, longitudinal muscles; *b.c.*, body cavity; *gl.*, gill; *s.*, setæ; *n.p.*, nephridial pore; *a.br.*, afferent branchial; *e.br.*, efferent branchial; *n.*, ventral nerve-cord, with blood vessels above; *d.v.*, dorsal vessel; *l.v.*, lateral vessel; *s.i.v.*, sub-intestinal vessels; *v.v.*, ventral vessel; *g.*, gut.

median-ventral ciliated groove. (4) The intestinal region is much folded, “in a concertina-like manner,” by the caudal septa, and is full of sand, from which the nutritive matter has been absorbed. The anus is at the very end.

Body cavity.—This is spacious, except in the tail region, and contains a viscous cœlomic fluid. Anteriorly there are three transverse, partly muscular, septa or diaphragms which moor the gullet. The first of these diaphragms bears a pair of small pouches. Behind the

third diaphragm the gut swings freely until the beginning of the tail region, in which there are many septa.

Vascular system.—The blood has a bright red colour, and is rich in hæmoglobin. It flows in a very elaborate system of blood vessels, in regard to the details of which there is still some uncertainty. There is along the whole mid-dorsal line of the gut a contractile dorsal vessel, which carries blood *forwards* from the seven posterior gills, etc. Connected with this by capillaries, there is below the gut an equally long, feebly contractile ventral vessel, which carries blood backwards to gills, nephridia, etc. Around the gastric region of the gut there is an elaborate plexus of blood vessels, which communicate by two lateral vessels with the paired heart. There are also two sub-intestinal vessels between the ventral vessel and the gut; these lead through the plexus into the lateral gastric vessels, and thus into the hearts. These organs lie just behind the œsophageal glands, and consist on each side—(a) of a thin-walled auricle, an expansion of the lateral gastric vessel; and (b) of a muscular ventricle, which drives the blood into the ventral vessel. Like the sub-intestinals, the dorsal vessel communicates with the heart only indirectly through the gastric plexus. The ventricle contains a spongy “cardiac body,” which probably prevents regurgitation from the ventral vessel.

From the ventral vessel arise afferent branchial vessels to gills, nephridia, etc. From the seven posterior gills efferent branches enter the dorsal vessel; while those from the six anterior gills join the sub-intestinals. Each efferent vessel gives off a branch to the skin, while the dorsal and sub-intestinal vessels give off numerous branches to the gastric plexus on the gut.

Respiratory system.—There are thirteen pairs of gills, on the seventh to the nineteenth bristle-bearing segments. Each is a tuft of hollow thread-like branches, through the thin walls of which the red blood shines. The afferent branches to the gills all come from the ventral vessel; the first six efferent vessels from the gills open into the sub-intestinals; the posterior seven open into the dorsal vessel. As the papillæ on the proboscis are hollow and contain vessels, they are doubtless of respiratory significance. Indeed, the gills may be regarded as exaggerated papillæ.

Excretory and reproductive systems.—In the anterior region, in segments 4–9, there are six pairs of nephridia, of which the foremost seems in process of degeneration. Each consists of three parts—a funnel opening into the body cavity, a glandular portion, and a bladder communicating with the exterior.

The sexes are separate and similar. The reproductive organs are very simple, and arise by proliferation of the

peritoneal membrane beside the blood vessels supplying the funnels of the nephridia. The reproductive cells are liberated into the body cavity, and there matured. They pass out by the nephridia, and may be temporarily stored in the bladder portions of all but the first. Little is known in regard to the development, beyond the fact that the young are for a time free-swimming pelagic forms.

Development of Polychæta.—As an example of the development of the marine Chætopods, we may take *Eupomatus*, which has been investigated by Hatschek. Here segmentation is complete, but somewhat unequal, and results in the formation of a blastula, with its upper hemisphere composed of small (ectodermic) cells, and the lower of large (endodermic) cells. Among these latter are two spherical cells—the primitive mesoblasts. Invagination takes place in the usual way to form a gastrula; the primitive mesoblasts divide and form mesoblastic bands. During these processes the external form has altered considerably. The apical (aboral) region of the gastrula becomes tilted forward, an ectodermic invagination arises posteriorly, and, uniting with the archenteron, produces hind-gut and anus, while a similar insinking anteriorly, in the region of the blastopore, forms fore-gut and mouth. The larval gut so formed has a distinct ventral curve. Cilia appear on the surface at an early stage, and now form a distinct pre-oral ring, and also a less constant post-oral ring. At the apex of the pre-oral region an ectodermic thickening takes place; this gives rise to an apical ganglion, with which sensory structures are often associated. The mesodermic bands give rise to muscle cells, used in swimming, and also to the “head kidneys”—a pair of larval excretory tubes. The larva so formed is a typical Trochosphere, such as occurs in the great majority of Polychæta, in a more or less modified guise in many other worm-types, and also in Molluscs. Its chief characters are the following:—

(1) There is a prominent pre-oral region, with an apical ganglion and a ring of cilia.

(2) The gut has a distinct ventral curve, and a threefold origin.

(3) The larval body cavity is simply the persistent segmentation cavity, and in it posteriorly lie the primitive mesoblasts.

The Trochosphere is a free-swimming pelagic larva, which, among worms, corresponds largely to the future head region of the adult. Its metamorphosis into the adult probably takes place in the most primitive fashion in the little worm *Polygordius*. We shall therefore follow it there (Fig. 119).

In the larva, which is a typical Trochosphere, the first sign of segmentation appears in the bands of mesoblast. These become divided into successive segments, while at the same time the posterior region of the larva elongates greatly, carrying the larval gut backwards with it. Meanwhile a cavity appears in each of the mesoblastic segments. These cavities, taken together, form the adult body cavity; the outer and inner walls form the somatic and splanchnic layers; the posterior and anterior walls of adjacent segments fuse to form the septa of the adult worm; the inner (splanchnic) walls of the primitive segments on

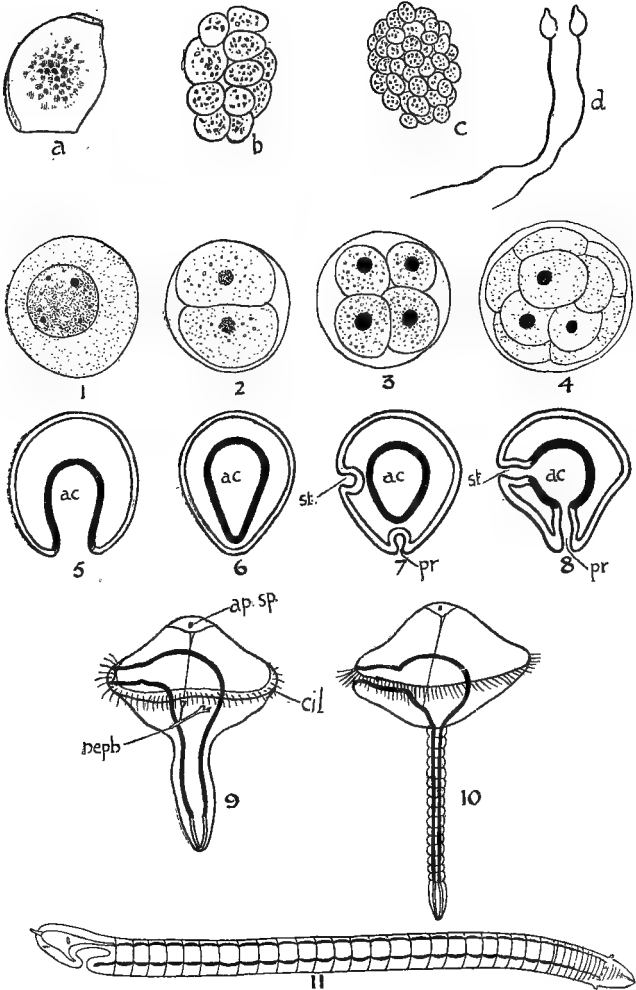

FIG. 119.—Development of *Polygordius*.—After Fraipont.

- a.*, Mother sperm cell; *b.*, *c.*, sperm morulae; *d.*, spermatozoa.
 1. Ovum with large nucleus; 2. two-cell stage; 3. four-cell stage; 4. blastosphere; 5. gastrula; *ac.*, archenteron; 6. closure of gastrula mouth or blastopore; 7. formation of stomodæum (*st.*), and proctodæum (*pr.*), which invaginate to meet archenteron (*ac.*); 8. complete gut formed; 9. elongation of larva; *ap. sp.*, apical spot; *cil.*, ciliated ring; *neph.*, primitive nephridia; 10. formation of posterior segments; 11. form of adult *Polygordius*.

each side fuse above and below the gut to form the dorsal and ventral supporting mesenteries of the gut. The head region is at first disproportionately large, but later, by an independent process of growth, becomes reduced. The larva abandons its pelagic life, and becomes adult.

Comparing the development of Polychæta with this, we find that the Trochosphere is often modified, and that segmentation tends constantly to appear at an earlier stage. As a further step in the same direction, we may note that in some Polychæta the Trochosphere stage is no longer recognisable as such.

GENERAL SURVEY OF THE CLASS CHÆTOPODA

I. Oligochæta.—The general characters may be gathered from the description of the earthworm, but it is to be noticed that the earthworms are specialised forms, and that the fresh-water Oligochætes are of much simpler structure. The most essential distinction from the Polychæta is to be found in the complex reproductive organs. The absence of gills, though general, is not universal, for a few fresh-water forms, such as *Dero* and *Branchiura*, possess gills of simple structure, while the West African *Alma nilotica* has more complex branched retractile gills. Among other characters may be noticed the tendency to variation in the structure of the excretory system. In all, with the exception of *Eolosoma*, certain of the nephridia are modified to serve as genital ducts, while in the Megascolicidæ the nephridia tend to be reduced to a mass of minute tubules ramifying over the inner surface of the body wall. In general the Oligochætes, however, show more uniformity of structure than their marine allies.

They may be divided into two main groups—(1) the Microdrili, and (2) the Megadrili. The first group includes the small aquatic forms; of these most familiar are *Tubifex rivulorum*, often found in the mud of brooks, and the species of *Nais*, remarkable for their power of asexual budding. Some Microdrili live between tide-marks. The leech-like *Branchiobdella*, which is parasitic on the gills of the fresh-water crayfish, is a somewhat aberrant member of the group. The Megadrili include the larger Oligochætes, mostly living in earth, and commonly designated as "earthworms." The largest form is a Tasmanian species (*Megascolides gippslandicus*), measuring about 6 ft. in length.

II. Polychæta.—As contrasted with the more or less subterranean earth- and mud-worms, the marine Polychæta have a richer development of external structures and a more complex life history. The external appearance is greatly modified by the relative degree of development of the parapodia, which are lateral outgrowths typically functioning as walking "legs," or as swimming organs. A parapodium, when fully developed, is divisible into a ventral neuropodium and a dorsal notopodium. Each of these is bilobed, bears a tactile process or cirrus, and is fringed with firm bristles or setæ. Within the substance of each lobe is embedded a stout needle-shaped "aciculum,"

which functions as an internal skeleton, both by giving support and by serving as an attachment for muscles. With the notopodium, further, true gills containing prolongations of the body cavity are often associated. Such typical parapodia occur especially in the active free-living forms like *Nereis* and its allies, but in the order in general the parapodia show much variation, and may be almost suppressed, as in *Arenicola*. Parapodia are absent from the "prostomium," and are rarely fully developed on the first true segment or peristomium. In both cases, however, tactile cirri and tentacles are often present. The prostomium varies greatly in development and structure, and is of great systematic importance; it is frequently furnished with eyes and other sense organs,

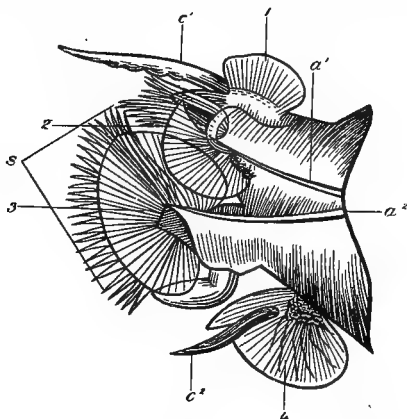

FIG. 120.—Parapodium of "Heteronereis" of *Nereis pelagica*.—After Ehlers.

1, 2, 3, 4, the leaf-like outgrowths; c^1 , notopodial cirrus; c^2 , neuropodial cirrus; a^1 , a^2 , acicula or supporting bristles of notopodium and neuropodium; s , setæ.

but these may also occur in other regions of the body. Apart from the parapodia, the shape and appearance of the body are most affected by the condition of the septa. In the active free-living forms (Errantia) these are usually present throughout the body, and gave a characteristic worm-like appearance. In burrowing and tubicolous forms (Sedentaria) the septa tend to be suppressed. Their absence facilitates burrowing, by permitting free movement of the coelomic fluid, and is often associated with a division of the body into regions, and a loss of the typical uniform shape (cf. *Arenicola*).

With regard to internal organs, the gut is frequently branched and of large calibre. In some cases (Capitellidæ) it possesses an accessory

communicating tube (Nebendarm), which is of interest, because it has been compared to the notochord of Vertebrates. There is typically a pair of nephridia in each segment, but they are often reduced in number. They may open into the coelome by a ciliated funnel or nephrostome, or end in a group of solenocytes, which are comparable to the flame-cells of Flatworms (see Fig. 254A). With the nephridia there are often associated ciliated "coelomoducts," which typically open to the exterior and into the coelome: They often combine with the nephridia. Though the sexes are usually separate, there are a few hermaphrodite forms. There is a metamorphosis in development,

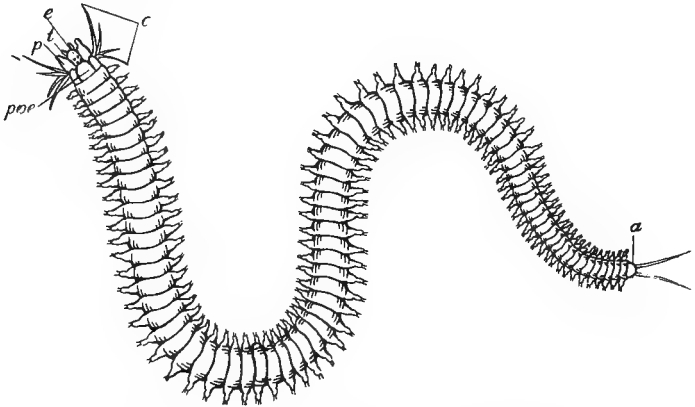

FIG. 121.—Free-living Polychaete (*Nereis cultrifera*).

Note, as compared with *Arenicola*, the absence of gills, and the well-developed parapodia, which are absent from the peristomium (*pe.*), or first true segment. The prostomium bears eyes (*e.*), the small tentacles (*t.*), and the large palps (*p.*); *c.*, the four paired cirri, borne by the peristomium; *a.*, the anus, with two long cirri.

and some interesting peculiarities occur in regard to reproduction. Thus several species of the common genus *Nereis*, when sexually mature, have the body divided into two regions—a posterior region containing the ova or sperms, and an anterior unmodified asexual region. The posterior region is distinguished by the structure of its parapodia, which become converted into broad, flattened swimming organs, and there is sexual dimorphism. Worms of this peculiar type were long described as a distinct genus under the name of "Heteronereis," and even yet the subject is imperfectly understood, for there is from unknown causes much variation as regards the extent of the modification. A complete change of habit at the spawn-

ing season is probably common here as elsewhere in marine Invertebrates. In the Syllidæ a phenomenon occurs similar to the formation of a "Heteronereis," but a process of fission may result in the division of the modified form into an anterior asexual zooid and a posterior sexual one. In *Myrianida* a long chain of sexual zooids is formed. In this way a regular alternation of sexual and asexual generations may arise.

Some Polychæta dwell habitually within tubes, others are at least at times active and free-living. The latter have usually well-developed parapodia and sense organs, the anterior part of the gut may be furnished with strong jaws, the body is more or less uniform, and the worms are carnivorous. These forms are all included in the sub-order Nereidiformia, which embraces such familiar animals as the common sea-mouse (*Aphrodite*), with its mass of iridescent bristles covering the sides of the body, the species of *Nereis* and *Nephtys*, so common under stones on the shore, and others equally remarkable for beauty of colour. The bright colours may be due to the iridescent cuticle or to pigments. There are a few transparent pelagic forms, e.g. *Tomopteris*.

The sedentary forms lead a sluggish life within various kinds of tubes—limy, sandy, papery, or gelatinous. They are not nearly related, but possess in common certain adaptive characters, such as the aggregation of gills, cirri, tentacles, and sense organs to the anterior exposed part of the body; the reduction of the parapodia, often used solely for clambering in the tube; the absence of "jaws," and the habit of feeding on minute Algæ or other substances suspended in water. Among these are included *Serpula*, which forms twisted limy tubes outside shells and other marine objects; the aberrant *Sabellaria*, which often builds reefs of porous rock formed of the aggregated sandy tubes; the common *Terebella* or *Lanice conchilega*, with its tubes of glued sand particles; and the strange phosphorescent *Chatopterus*, found in deep water, within its yellow parchment-like tube.

III. Echiuridæ.—In holes in the rocks on the warmer coasts of Europe there lives a curious "worm"—*Bonellia viridis*, of a beautiful green colour, with a globular body, and a long, grooved, anteriorly forked, pre-oral protrusion. Such, at least, is the female; but the male is microscopic in size, lives in or on his mate, and is exceedingly degenerate. His gut is without mouth and anus, the surface is covered with cilia, and the body cavity almost obliterated. Related to *Bonellia*, but of less anomalous shape, are a few other forms, like *Thalassema* and *Echiurus*.

In all, the body in the adult shows mere traces of segmentation; parapodia, cirri, and gills are absent, but, except in the degenerate males, a few setæ are always present. The most characteristic structure is the elongated solid proboscis, which has the mouth at its base. The nervous system consists of a gullet-ring and a ventral cord, but the latter is unsegmented, and there is no brain. The gut is coiled, and bears a curious adjacent tube known as the "collateral intestine," and a pair of excretory "anal vesicles," opening from gut to body cavity, and formed in development from nephridia. The anus is terminal, there is a closed vascular system, and one to four pairs of nephridia. The sexes are separate, the reproductive elements are formed on the walls of the body cavity, and are shed into it.

There is a metamorphosis in development, but the nature of the larva differs markedly in the different genera. In *Echiturus* and *Thalassema* it bears a striking resemblance to a Trochosphere. Thus there is a well-developed pre-oral lobe with an apical sense organ, and pre-oral and post-oral bands of cilia. "Head kidneys" or provisional nephridia occur, and the post-oral region shows distinct segmentation, the segments being marked externally by rings of cilia. As development proceeds, all trace of segmentation is lost. In *Bonellia* the larva shows no trace of segmentation, and is Turbellarian-like; owing to a premature arrest of development, the male remains at this level throughout life.

Appendix (1) to Chætopoda

Primitive Forms. ARCHI-CHÆTOPODA OR
ARCHI-ANNELIDA

There are a few, small, simple, marine worms, with some Annelid or Chætopod characters, which are sometimes supposed to be ancestral forms. Thus *Dinophilus* is a minute Planarian-like animal found among Algæ. In the young at least the body is distinctly segmented, but there are no bristles, gills, or tentacles. There are circling bands of cilia. The nervous system consists of a brain and two widely separated ventral ganglionated cords, but it remains in contact with the epidermis.

More distinctly Annelid are the marine worms *Polygordius*, *Protodrilus*, *Saccocirrus*, and *Histriodrilus*.

The small body is segmented and uniform; there are no setæ, parapodia, cirri, or gills, but the head bears a few tentacles; the pre-oral region is small, and the segment around the mouth is large; the very simple nervous system is retained in the epidermis.

Polygordius (Fig. 119 (11)) is a thin worm, an inch or more in length, living at slight depths in sand or fine gravel, often along with the lancelet. It has two tentacles, a few external cilia about the mouth in a pair of head-pits, and sometimes on the body; it moves like a worm, but has no bristles. It feeds like an earthworm, or sometimes more discriminatingly on unicellular organisms. The females are usually larger than the males, and in some species break up at sexual maturity. The development includes a metamorphosis, and the larvæ are ciliated, free-swimming, light-loving, surface animals, feeding on minute pelagic organisms, seeking the depths as age advances. According to some, the larva represents a primitive unsegmented ancestral Annelid, with medusoid affinities; according to others, the larval characteristics are adaptive to the mode of life, and without historic importance.

Protodrilus is even smaller than *Polygordius*, with more cilia, mobile tentacles, and two fixing lobes on the posterior extremity; the movements are Turbellarian-like, the reproductive organs hermaphrodite, the development direct. *Histriodrilus* is parasitic on the eggs of the lobster, and its affinities are doubtful.

Appendix (2) to Chætopoda

Parasitic and Degenerate Chætopods. MYZOSTOMATA

The remarkable forms (*Myzostoma*) included in this small class, live parasitically on feather-stars, on which they form galls. They are regarded as divergent offshoots from primitive Annelids, the larval form showing some distinctly Chætopod characters. The minute disc-like body is unsegmented, and bears five pairs of parapodia, each with a grappling hook, with which four pairs of suckers usually alternate. There are also abundant cirri. The skin is thick, the body muscular, the nervous system is concentrated in a ganglionic mass, which encircles the gullet, and gives off abundant branches. There is a protrusible proboscis and a branched gut; the mouth and anus are ventral. The ova arise in the reduced body cavity, and pass by three meandering oviducts to the anal aperture. The testes are paired, branched, and ventral, with associated ducts, which open anteriorly on the side of the body.

The series are united, but there is marked protandry. The very young forms, originally described as "dwarf males," contain spermatozoa, and are often carried on the back of the mother; as they grow older they become hermaphrodite, and later the power of forming spermatozoa is lost and the animals become female.

It must be allowed, however, that all would not agree with the above summary. Thus Beard says: "The various kinds of parasitism presented by the numerous species of *Myzostoma*, have led in some cases to the preservation of the males, in others to their extinction, in yet others to their conversion into hermaphrodites." He distinguishes—

1. Purely dicecious forms with small males, e.g. *M. pulvinar*.
2. Hermaphrodite forms and true males, which remain males, e.g. *M. glabrum*.
3. Hermaphrodite forms and males, which, retaining their positions on the hermaphrodites, afterwards become female, e.g. *M. alatum*.
4. Hermaphrodite forms, in which the males have lost their dorsal position, and have either become extinct or converted into protandric hermaphrodites, e.g. *M. cirriiferum*.

Class HIRUDINEA OR DISCOPHORA. Leeches

This class includes forms in which the body is oval and flattened, usually devoid of setæ or gills, and marked externally by rings which are much more numerous than the true segments. The body cavity is much reduced and broken up (except in Acanthobdella), and may communicate indirectly with the well-developed vascular system. The nephridia are numerous and segmentally arranged. There are usually two suckers, one at each end of the body, the anterior being formed

by the mouth. Almost all are hermaphrodite,—the male organs are numerous and segmentally arranged, and special genital ducts are present. The genital openings are median. The development is direct. Most live in fresh water or on land, but a few are marine.

Type, the Medicinal Leech (*Hirudo medicinalis*)

Habits.—This is the commonest and most familiar of leeches, once so constantly used in the practice of medicine that leech became synonymous with physician. It lives in ponds and sluggish streams, and though not common in Britain, is abundant on the Continent, where leech farms, formerly of importance, are still to be seen. Leeches feed on the blood of fishes, frogs, and the like, and are still caught in the old fashion on the bare legs of the callous collector. As animals are naturally averse to blood-letting and hard to catch, leeches make the most of their opportunities. They gorge themselves with blood, and digest it slowly for many months, it may be, indeed, for a year. Watched in a glass jar, the leech is seen to move by alternately fixing and loosening its oral and posterior suckers, and, on some slight provocation, it will swim about actively and gracefully. At times it casts off from its skin thin transparent shreds of cuticle,—a process which, in natural conditions, usually occurs after a heavy meal, when the animal, as if in indigestion, spasmodically contracts its body, or rubs itself on the stems of water-plants. Numerous eggs are laid together in cocoons in the damp earth near the edge of the pool. Thence, after a direct development, the young leeches emerge and make for the water.

External features.—The leech is usually from 2 to 6 inches in length, and appears cylindrical or strap-like, according to its state of contraction. The slimy body shows over one hundred skin-rings; its dorsal surface is beautifully marked with longitudinal pigmented bands, while the ventral surface is mottled irregularly; the suckorial mouth is readily distinguished from the unperforated hind sucker, above which, on the dorsal surface, the alimentary canal may be seen to end.

According to Whitman's precise investigations, there are 102 skin-rings and 26 somites or true segments. The hind sucker is supposed to consist of 7 fused segments, making the total number 33.

These segments may be recognised externally by conspicuous pigment spots ("segmental papillæ"), which in the middle region of the body occur on every fifth ring. In type, therefore, five rings correspond to a segment, but at either end of the body the number of rings is abbreviated. In the head region there is a pair of "eyes" on the 1st, 2nd, 3rd, 5th, and 8th rings; these are homologous with "segmental papillæ," and therefore in this region eight rings correspond to five segments.

The penis is protruded on the middle ventral line between rings 30 and 31; the aperture of the female duct lies five rings farther back. Also on the ventral surface there are seventeen pairs of small lateral apertures, through which a whitish fluid may be squeezed—the openings of the excretory organs. The skin of segments 9–11 is especially glandular, and forms the so-called clitellum or saddle, the secretion of which forms the cocoon for the eggs.

Skin.—Most externally lies the cuticle—a product of the epidermis—periodically shed, as we have already noticed. In this shedding some of the genuine epidermis cells are also thrown off. These are somewhat hammer-like units, with the heads turned outwards, while the spaces between the thick handles contain pigment and the fine branches of blood vessels. As the latter come very near the surface, a respiratory absorption of oxygen and outward passage of carbon dioxide is readily effected. Opening between the epidermal elements, but really situated much deeper, are numerous long-necked, flask-shaped glandular cells, secreting the mucus so abundant on the skin. Underneath the epidermis there is much connective tissue, besides yellow and green, brown and black pigment.

Muscular system and body cavity.—The muscular system consists of spindle-shaped cells arranged externally in circular bands like the hoops of a barrel, internally in longitudinal strands like staves. Besides these there are numerous muscle bundles running diagonally through the body, or from dorsal to ventral surface, and there are other muscles associated with the lips, jaws, and pharynx. The body cavity, though distinct in the embryo, is almost obliterated in the adult leech, where the predominant connective tissue has filled up nearly every chink.

Nervous system and sense organs.—The nervous system mainly consists of a pair of dorsal ganglia lying above the pharynx, and of a double nerve-cord, with twenty-three ganglia, lying along the middle ventral line. The dorsal (or

supra-oesophageal) ganglia are connected with the most anterior (or sub-oesophageal) pair on the ventral chain, by a narrow nerve-ring surrounding the beginning of the gut. The sub-oesophageal ganglia represent about five pairs of ganglia fused together. From the dorsal ganglia nerves proceed to the "eyes" and anterior sense spots; from the ventral centres the general body is innervated. Special

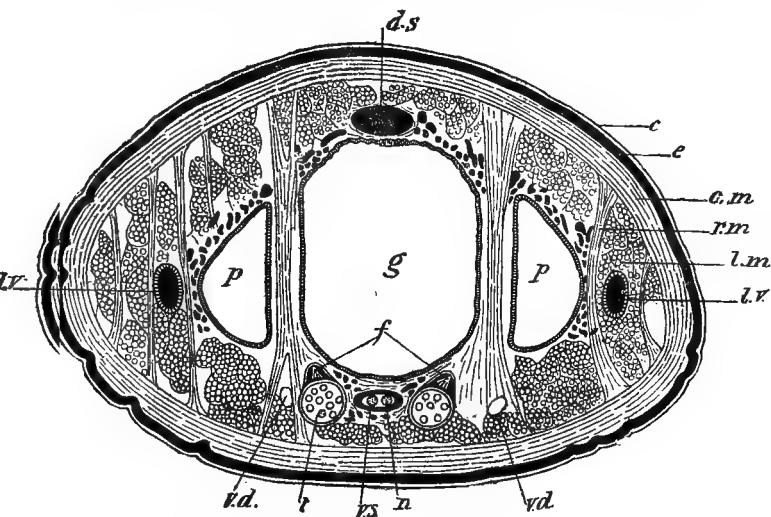

FIG. 122.—Transverse section of leech.—After Bourne.

c., Cuticle; *e.*, epidermis; *c.m.*, dermis and outer muscles (circular and oblique); *l.m.*, longitudinal muscles (the peculiar connective tissue is hardly indicated); *r.m.*, radial muscles; *l.v.*, lateral blood vessel; *d.s.*, dorsal sinus; *v.s.*, ventral sinus enclosing nerve-cord (*n.*); *g.*, median part of crop, with lateral pockets (*p.*); *t.*, testis; *f.*, nephridial funnels; *v.d.*, vas deferens.

nerves from the dorsal ganglia supply the alimentary canal, forming what is called a visceral system.

The sense organs of the leech are ten so-called "eyes," besides numerous sense spots usually occurring on every fifth skin-ring. The eyes are arranged round the edge of the mouth, and look like little black spots. Microscopic examination shows them to be definite cups, surrounded by

connective tissue with black pigment, and containing clear, strongly refracting cells, each in connection with a fibre of the optic nerve.

It has been shown (Whitman) that the eyes of leeches are serially homologous with the segmental sense organs. At the one extreme there are purely tactile organs, at the other extreme there are purely visual organs, and between these there are compound sense organs, in part tactile and in part visual—a series which is full of suggestiveness in regard to the evolution of sense organs (cf. the series of sensitive setæ in the crayfish). The visual organs of the leech are not able to form images of external objects, but the animals are exquisitely sensitive to alterations of light.

Alimentary system.—When the leech has firmly fastened itself to its prey by the hind sucker, it brings its muscular mouth into action, pressing the lips tightly on the skin, and protruding three chitinous tooth-plates which lie within. Each of these tooth-plates is worked by muscles, and is like a semicircular saw, for the edge bears from 60 to 100 small teeth. Rapidly these saws cut a triangular wound, whence the flowing blood is sucked into the muscular pharynx. The process may be observed and felt by allowing a hungry leech to fasten on the arm. As the blood passes down the pharynx, it is influenced by the secretion of glandular cells which lie among the muscles of the seventh, eighth, and ninth segments, and exude a ferment which prevents the usual clotting. The blood greedily sucked in gradually fills the next region of the gut—the crop—which bears on each side eleven storing pockets. These become wider and more capacious towards the hind end, the largest terminal pair forming two great sacs on each side of the comparatively narrow posterior part of the gut. As all the

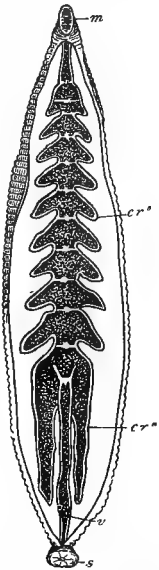

FIG. 123. — Alimentary system of leech.—After Moquin-Tandon.

m., Mouth; *cr*⁶, sixth crop-pocket; *cr*¹¹, last crop-pocket; *v.*, rectum; *s.*, posterior sucker.

pockets point more or less backwards, it is evident that a leech to be emptied of the blood which it has sucked must be pressed from behind forwards. The pockets filled, the

leech drops off its victim, seeks to retire into more private life, and digests at leisure. The digestion does not take place in the pockets, but in a small area just above the beginning of the terminal part or rectum. This rectum, running between the two last pockets, is separable from the true stomach just mentioned by a closing or sphincter muscle. It ends in a dorsal anus above the hind sucker.

Vascular system.—Two main lateral vessels run longitudinally, one on each side of the body. They are connected with one another by looping vessels, give off numerous branches which riddle the spongy body, and have a definite muscular coat. On the dorsal surface and ventrally around the nerve-cord are two lacunar spaces, which are really portions

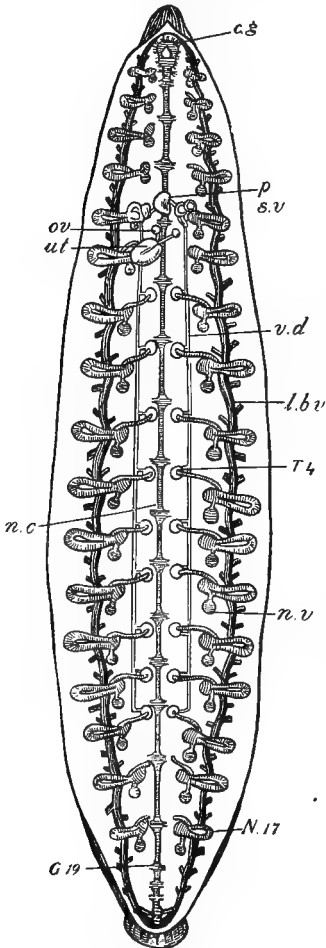

FIG. 124. —Dissection of leech.
—After Bourne.

c.g., Cerebral ganglia; *p.*, penis; *s.v.* is opposite the seminal vesicle; *ov.*, ovary; *ut.*, uterus; *v.d.*, vas deferens; *l.b.v.*, lateral blood vessel; *T.4*, fourth testis; *n.v.*, nephridial vesicle; *N.17*, last nephridium; *G.19*, nineteenth pair of ganglia; *n.c.*, nerve-cord.

of the true body cavity, and not parts of the vascular system. With those and similar spaces, however, the blood vessels are connected by means of a secondarily developed series of canals, roughly corresponding to the lymphatic vessels of Vertebrates. The blood is red, and contains colourless floating cells of diverse form.

Excretory system.—There are seventeen pairs of excretory tubules or nephridia, from the second to the eighteenth segment inclusive. These open laterally on the

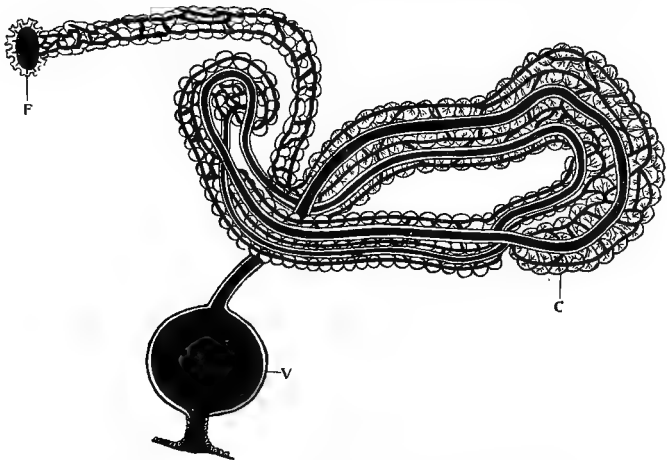

FIG. 125.—A nephridium of leech.—After Bourne.

F., Internal terminal funnel; *C.*, glandular coil covered with blood vessels; *V.*, external terminal vesicle.

ventral surface, voiding the waste products extracted from the blood vessels which cover their walls. From the seventh to the seventeenth, each nephridium ends internally in a ciliated “cauliflower lobe,” corresponding to the funnel of *Oligochæta*, and enclosed in a blood space, apparently part of the reduced coelom. In the first nine of these funnel-bearing nephridia the terminal lobe lies close upon and dorsal to a testis, but there is no morphological meaning in this approximation. Each consists of two

parts, a twisted horseshoe-shaped glandular region, where the actual excretory function is discharged, and a spherical, internally ciliated bladder opening to the exterior. Within the latter there is a whitish fluid with waste crystals.

Reproductive system.—The leech, like many other Invertebrates, is hermaphrodite, containing both male and female reproductive organs. The essential male organs or testes are diffuse, being represented by nine pairs, lying on each side of the nerve-cord in the middle region of the body. Each is a firm globular body, within which mother sperm cells divide into balls of sperms. The spermatozoa pass from each testis by a short canal leading into a wavy longitudinal vas deferens. This duct, followed towards the head, forms a coil (so-called seminal vesicle) as it approaches the ejaculatory organ or penis. From the coil on each side the sperms pass into a swollen sac at the base of the penis, where, by the viscid secretion of special ("prostate") glands, they are glued together into packets or spermatophores. These pass up the narrow canal of the muscular penis, and leave the body on the middle ventral line between rings 30 and 31, when they are transferred in copulation to the female duct of another leech.

The female organs are more compact. The two small tubular and coiled ovaries are enclosed in spherical vesicles, the walls of which are continued as two oviducts, which unite together in a convoluted common duct. This is surrounded by a mass of glandular cells, which exude a glairy fluid into the duct. Finally, the duct leads into a relatively large muscular sac—the "uterus"—which opens through a sphincter muscle on the middle ventral line between rings 35 and 36.

The favourite breeding-time is in spring. Two leeches inseminate one another, uniting in reverse positions, so that the penis of each enters the uterus of the other. Spermatophores are passed from one to the other, and the contained sperms may remain for a long time within the uterus, or, liberated from their packets, may work their way up the female duct, meeting the eggs at some point, or reaching them even in the ovaries. The development is direct.

GENERAL NOTES ON LEECHES

The leeches constitute a relatively small class, whose structure has been insufficiently worked out. The presence of suckers, the parasitic habit, the reduction of the body cavity, have led many naturalists to associate them with Flat-worms, but all recent work goes to emphasise their affinity with Annelids, especially Oligochætes. In leeches setæ are absent, except in *Acanthobdella*, which has paired segmentally arranged bristles in the anterior region; but it is to be noted that they are absent in some Oligochætes. As in Oligochætes, gills are usually absent, but occur in *Branchellion*. The condition of the body cavity affords one of the most striking contrasts to Oligochætes; but in *Acanthobdella* the adult has a typical Annelid coelom divided into regions by septa. In others, in spite of the large amount of connective tissue in the adult, there are distinct traces of segmental septa. In *Hirudo* the reduction is carried so far that the coelom is represented merely by canals without trace of septa. In all cases, however, development shows that the reduction is secondary, and that in the embryo there is a true Annelid body cavity unconnected with the vascular system. The condition of the alimentary canal affords a basis for classification, for in one set the anterior region is protrusible, and in the other it is not, but is furnished with jaws or tooth-plates. The jaws are interesting, because they are absent from Oligochætes, except in a few forms, like *Branchiobdella*; the jawed leeches are more specialised than those without these structures.

With regard to the nephridia, in *Clepsine*, which has a fairly well-developed body cavity, there is a direct communication between coelom and nephridia by means of a ciliated funnel of typical Annelid form. Where the coelom is much reduced, as in *Hirudo*, the funnel is represented by the blind ciliated "cauliflower lobe." In the reproductive system, apart from the numerous male organs, the leeches differ from the Oligochætes in the apparent continuity of the organs and ducts; but in the case of the ovaries, at least, the connection is secondary. In the processes of fertilisation and egg-laying, in the formation of a cocoon, and in the development, the two groups show marked resemblance.

Most leeches are worm-like aquatic animals, with blood-sucking propensities; but some live in moist soil, and others keep to the open surface, while the parasitic "vampire" habit, familiarly illustrated by the apothecary's ancient panacea, is in many cases replaced by carnivorous habits and predatory life. The medicinal leech (*Hirudo*) is typical of the majority, for it lives in ponds and marshes, and sucks the blood of snails, fishes, frogs, or of larger available victims. The giant leech (*Macrobdella valdiviana*), said to measure $2\frac{1}{2}$ ft. in length, though this is very doubtful, is subterranean and carnivorous; while the wily land-leeches (*Hæmadipsa*, etc.), of Ceylon and other parts of the

East, move very rapidly along the ground, fasten on to the legs of man or beast, and gorge themselves with blood. The hungry horse-leeches are species of *Hæmopsis*, greedily suctorial, though the teeth, which occur in two rows, are too small and irregular to be useful in medicinal blood-letting; but the name is also applied to species of the common genus *Aulostoma*, which are carnivorous in habit. Other common leeches are species of *Nephelis*, predaceous forms with indiscriminating appetites, and the little *Clepsine*, also common in our ponds, notable for carrying its young about on its ventral surface. Several marine forms prey upon fishes and other animals, e.g. the "skate-sucker" (*Pontobdella muricata*), with a leathery skin rough with knobs. This form lays velvety eggs in empty mollusc shells, and mounts guard over them for more than a hundred days. The remarkable *Branchellion* on the Torpedo has eleven pairs of leaf-like respiratory plates on the sides of its body, and so has the related *Ozobranchus jantseanus*, a parasite of a river turtle in the Jantsekiang. One of the strangest habitat is that of *Lophobdella*, on the lips and jaws of the crocodile.

Classification.—

Family 1. Rhynchobdellidæ, in which the fore part of the pharynx can be protruded as a proboscis. There is an anterior as well as a posterior sucker. The blood plasma is colourless. The ova are large and rich in yolk; the embryos are hatched at an advanced stage, and soon leave the cocoon, which contains no albuminous fluid.

e.g. *Clepsine*, *Pontobdella*, *Branchellion*.

Family 2. Gnathobdellidæ, in which there is no proboscis, but the pharynx usually bears three tooth-plates. The mouth is suctorial. The blood plasma is red. The ova are small and without much yolk; the embryos are hatched at an early stage, and swim about in the nutritive albuminous fluid of the cocoon.

e.g. *Hirudo*, *Hæmopsis*, *Hæmadipsa*, *Aulostoma*, *Nephelis*.

Family 3. Acanthobdellidæ. By itself is the Siberian fish parasite *Acanthobdella*, which has rows of setæ on the first five segments, a spacious cœlom, and other peculiarities.

Appendix (1) to Annelid Series

CLASS CHÆTOGNATHA. ARROW-WORMS

There are two little pelagic "worms," *Sagitta* and *Spadella*, which are so different from all others, that they have been placed in a class by themselves. It is possible to regard them as Annelids with three segments.

The translucent body, which may be nearly 3 in. long, but is usually much less, has three distinct regions,—a head bearing a ventral mouth with spines and bristles (whence the name Chætognatha), a median region with lateral fins, and a trowel-like tail. The nervous system consists of a supra-œsophageal ganglion in the head, a sub-

oesophageal about the middle of the body, long commissures between them, and numerous nerves from both; it retains its primitive connection with the epidermis. There are two eyes and various patches of sensitive cells. The food canal is complete and simple, and lies in a spacious ciliated body cavity. Corresponding to the external divisions, the cavities of the head, body, and tail are distinct, being separated from one another by septa; a longitudinal mesentery supports the gut and divides the cavities into lateral halves.

There is no vascular system, nor are there any certain nephridia. It is possible that the latter may be represented by the genital ducts.

The animals are hermaphrodite, and the simple reproductive organs lie near one another posteriorly. The two ovaries project into the body cavity, and their ducts open laterally where body and tail meet. The two testes project into the cavity of the tail; and their ducts have

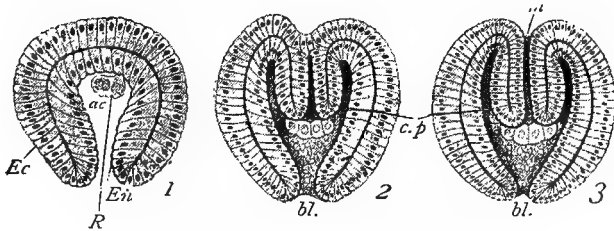

FIG. 126.—Development of *Sagitta*.—After O. Hertwig. Illustrating formation of a body cavity by pockets from the archenteron; also the early separation of reproductive cells.

Ec., Ectoderm; *En.*, endoderm; *ac.*, archenteron; *R.*, reproductive cells; *bl.*, blastopore; *c.p.*, coelom pouches; *m.*, mouth; 1. section of gastrula; 2 and 3. origin of coelom pouches.

internal ciliated funnels, and open on the tail. Two reproductive cells are set apart at a very early stage, and each divides into the rudiment of an ovary and of a testis. The eggs undergo complete segmentation; a gastrula is formed by the invagination of the blastula; the body cavity arises, in enterocœlic fashion, as two pockets from the archenteron. The young forms are like the adults.

Appendix (2) to Annelid Series

Class ROTATORIA. Rotifers

Rotifers are beautiful minute animals, abundant in fresh water, also found in damp moss, and in the sea. They owe their name and the old-fashioned title of wheel-animalcules to the fact that the rapid move-

ments of cilia on their anterior end produce the appearance of a rotating wheel. The food seems to consist of small organisms and particles caught in the whirlpool made by the lashing cilia. The little animals are tenacious of life, and can survive prolonged drought. If they are left dry for long, however, they die, though the ova may survive and subsequently develop.

The body is usually microscopic, and is sometimes (*e.g.* in *Melicerta* and *Floscularia*) sheltered within an external tube. There is no internal segmentation, but there are sometimes external rings, and the attaching outgrowth or "foot" is sometimes segmented. The anterior end bears, on a retractile ridge, the ciliated ring or "trochal apparatus."

The nervous system is a single dorsal ganglion with a few nerves. An unpaired eye and some tufts of sensory hairs are usually present.

The food canal extends along the body in a well-developed "cœlom," and the fore-gut contains a mill, in which two complex hammers beat upon an anvil. The canal ends posteriorly on the dorsal surface between the body and the foot, and, as the terminal portion also receives the excretory canals and the oviduct, it is called a cloaca.

There is no vascular system, but a nephridial tube of a primitive type lies on each side of the body, and opens posteriorly into the cloaca.

The sexes are separate; the reproductive organs are simple. Except in the marine parasite *Seison*, in *Rhinops vitrea*, and two or three other forms, the males are dwarfed and degenerate, destitute even of a true food canal, and often "little more than perambulating bags of spermatozoa." In many cases the sexual union (effected by a penis) seems to be ineffective, and there is no doubt that many, if not most, Rotifers are parthenogenetic. No males have as yet been found in *Philodina*, *Rotifer*, *Callidina*, or *Adineta*. The females lay three different kinds of eggs, according to their conditions and constitution—either small ova, which become males, or thin-shelled "summer ova," or thick-shelled "resting or winter ova," the two last developing into females. The so-called winter eggs may occur at any season, and seem usually to have been fertilised. Many species, however, are viviparous. We include the Rotifers beside the Annelids proper, because it seems possible to regard them as derived from ancestors somewhat like Annelid larvæ.

Rotifers living in fixed tubes or envelopes,—*Melicerta*, *Floscularia*, *Stephanoceros*.

Free Rotifers,—*Notommata*, *Hydatina*, *Brachionus*.

Parasitic on the marine crustacean *Nebalia*,—*Seison*.

Pedalion occupies a unique position; it has hints of appendages and a peculiar jumping motion.

At this stage it may be mentioned that there are several sets of small worm-like animals of which we know very little. It is quite possible that some of them, may become of great interest to the systematic zoologist, but we do not yet understand what places in the system they should occupy. Moreover, as they are small, unfamiliar, and unknown to myself, I shall simply refer to more complete works for an account of the Gasterotricha, Echinoderidæ, Demoscolicidæ, and Chætosomidæ.

*Appendix (3) to Annelid Series*A. Class SIPUNCULIDÆ, e.g. *Sipunculus*, andB. Class PRIAPULIDÆ, e.g. *Priapulus*

These two classes were formerly united with the Echiuridæ as Gephyrea, but it is improbable that the three are nearly related. The Echiuridæ are apparently modified Chætopods, while the position of the Sipunculidæ and Priapulidæ is quite uncertain.

Both include marine worms, living in the sand or mud upon which they feed, having unsegmented bodies with a capacious body cavity, and an anterior protrusible proboscis or introvert, which is moved by special retractor muscles, and bears the mouth at its tip. In most other respects the two classes differ markedly from one another.

In the Sipunculids, the large introvert terminates in a hollow tentacular fringe, within the cavity of which closed blood vessels run. The gut is much coiled, and the anus is dorsal and anterior. A nervous system with a distinct brain, a gullet-ring, and a ventral cord is present, but the ventral cord is unsegmented. Peculiar ciliated vesicles or "urns" arise in some Sipunculids as buds from the blood vessels, and many swim freely in the body cavity. By collecting and agglutinating particles they help to purify the cœlomic fluid. Large nephridia or brown tubes, usually two in number, occur in the anterior region, and function also as genital ducts. The sexes are separate except in *Phascolosoma minutum*, and the reproductive cells develop on the lining of the body cavity. In the development, which includes a metamorphosis, several peculiarities are observable, tending to show that the animals are not primitive. The larva of *Sipunculus* is sometimes compared to a trochosphere, but differs from a typical trochosphere, notably in the total absence of segmentation, of "head kidneys," of a pre-oral band of cilia, as well as in the position of mouth and anus, and the slight development of the pre-oral lobe.

The class includes eleven genera, which are widely distributed; many of the species are large and conspicuous. It should be noticed that while Sipunculids are typically without trace of setæ, some genera, e.g. *Phascolosoma*, have distinct hooks on the introvert.

The Priapulidæ include two genera—*Priapulus* and *Halicryptus*, both almost entirely confined to the northern hemisphere. They have no tentacles, no vascular system, no brown tubes, and no brain. The gut is straight, or has a single loop; the anus is posterior. A gullet-ring and ventral nerve-cord are present as in *Sipunculus*, but retain their primitive connection with the epidermis. There are complex genital ducts opening by a pore on each side of the anus, which in the young are connected with an excretory system of the Platyhelminth type, while in the adult they are overgrown and concealed by the reproductive cells. The development is unknown. In *Priapulus* there is a peculiar respiratory (?) appendage at the posterior end of the body.

Appendix (4) to Annelid Series

Under the old term Molluscoidea are sometimes included the three classes—Phoronoidea, Polyzoa or Bryozoa, and Brachiopoda.

The Molluscoidea are characterised by the presence of a true coelom, formed in development by the folding off of pouches from the archenteron, and by the shortening of the dorsal region of the body, which results in the close approximation of mouth and anus. The mouth is typically furnished with ciliated tentacles, and is often overhung by an epistome; both tentacles and epistome, when present, contain spaces which are part of the body cavity. Except in the Ectoprocta among Polyzoa, two or four nephridia are present, and serve also as genital ducts. There is always a metamorphosis in development, and the larvæ are peculiar.

The development is in most cases insufficiently known, and it is probable that further knowledge of it will remove these sets of animals from their apparently anomalous position.

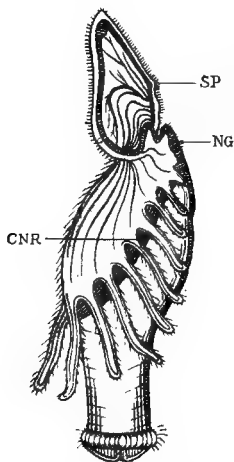

FIG. 127.—Actinotrocha or larva of *Phoronis*.—After Masterman.

The mouth is overhung by the prominent pre-oral hood; the anus is at the other end of the body. Behind the mouth is a ring of ciliated tentacles.

SP., the nerve ganglion in the hood; *N.G.*, the nerve ganglion of the region called collar region by Masterman; *CNR.*, nerve-ring at base of tentacles.

Class PHORONOIDEA.

This class was erected for the genus *Phoronis*, which has been associated both with the Gephyrea and with Polyzoa. Another genus, *Phoronopsis*, from the Cape, has been recently established. It has been proposed to associate these two genera, along with *Cephalodiscus* and *Rhabdopleura*, with the Hemichorda, on account of certain Chordate affinities, said to be exhibited by the larva.

The genus *Phoronis* includes a few species of small marine "worms," social in habit, and found enclosed in fixed leathery tubes often encrusted with foreign particles. Each individual is furnished with a horseshoe-shaped crown of tentacles, which are hollow and supported by an internal skeleton. The nervous system lies in the ectoderm—a very primitive character, and consists of a ring round the mouth, and of a cord down the left side of the body. An interesting point is the presence of a closed vascular system with nucleated

red cells. The body cavity is well developed, and is divided into chambers. The sexes are united; and the larva, known as *Actino*

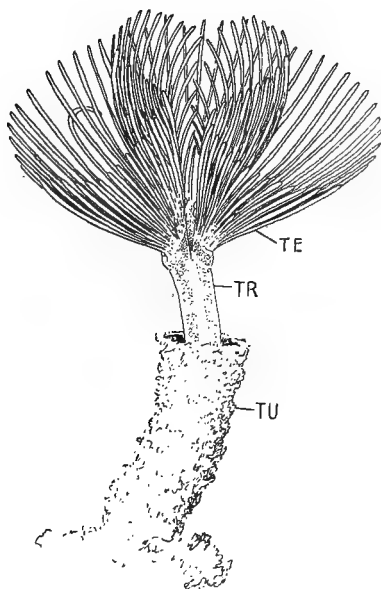

FIG. 128.—Phoronis, much enlarged.

TR., Trunk; *TE.*, tentacles; *TU.*, tube.

trocha, undergoes a remarkable metamorphosis in the course of its conversion into the adult.

Class POLYZOA or BRYOZOA

As usually defined, the class includes two sub-classes, the Ectoprocta and the Entoprocta, but it seems almost certain that these are distinct classes.

The Ectoprocta include fresh-water and marine forms, in which the anus is outside the basis of the tentacles. The nervous system is represented by a ganglion placed between the mouth and anus. There is a body cavity. There is no vascular system. Nephridia are absent. All are colonial and bud very freely; the marine forms show considerable division of labour among the members of the colony.

(a) Tentacles in a crescent—Fresh water, *Cristatella*, *Lophopus*, etc.
 (b) Tentacles in a circle—Marine, except *Paludicella*; *Flustra*, the common sea-mat; *Membranipora*, encrusting seaweed, etc.; *Cellepora*, very calcareous; *Alcyonidium*, gelatinous.

The Entoprocta include the colonial *Pedicellina*, with a few allied genera, also the non-colonial *Loxosoma*, in which the buds separate as soon as they are formed. All the forms are stalked and minute. The anus is included within the tentacular circle. In the meta-

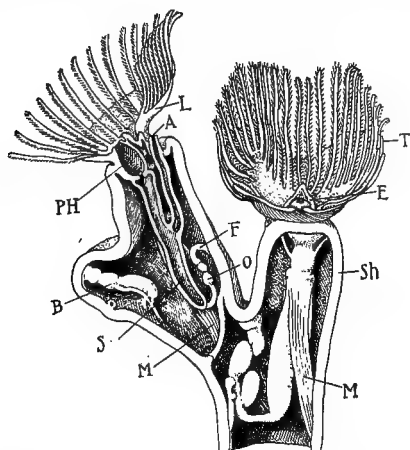

FIG. 129.—Diagram of an Ectoproctous Polyzoon (*Plumatella*).

L., Lophophore; PH., pharynx; A., anus; S., stomach; M., retractor muscle; F., funiculus, a cord of mesodermic tissue; O., cells that form "statoblast" buds; B., an ordinary bud; E., epistome over the mouth; T., tentacles; Sh., outer wall of zoecium.

morphosis of *Pedicellina* there is an elongation of the dorsal region of the body, and a consequent approximation of the mouth and anus on the shortened ventral surface. There is no apparent body cavity in the adult, and the mesoderm arises from two primitive mesoblasts. The nephridia are anterior, minute, and do not serve as genital ducts, but resemble the "head kidneys" of Annelid trochospheres. They are said to terminate in flame-cells like those of Platyhelminths. In all these three respects the Entoprocta differ from the Ectoprocta, and from the Molluscoidea generally.

Class BRACHIOPODA

The Brachiopods or Lamp-shells are quaint marine animals, once very numerous, but now decadent. The body is enveloped *dorsally* and *ventrally* by two folds of skin or mantle; these secrete a shell, usually of lime, but sometimes organic. The development of this shell has apparently modified both the position and the relations of the organs. There is no real resemblance between a Brachiopod shell and that of a bivalve Mollusc, except that both consist of two valves. In Brachiopods these lie dorsally and ventrally; in Lamellibranchs they are lateral; moreover, in Brachiopods the ventral valve is usually the larger. It is hardly necessary to say that the Brachiopod organism is not the least like a Mollusc.

A considerable part of the space between the valves of the shell is filled up by two long "arms," which are coiled in a spiral, and often supported by a calcareous skeleton. These arise in development from the specialisation of a horseshoe-shaped "lophophore," such as is characteristic of the Polyzoa. The mouth is placed between the arms, and opens into the ciliated food canal. This may end blindly, or may be furnished with an anus placed near the mouth; in *Crania* the anus is dorsal and posterior. The muscular system is well developed, the shell being both opened and closed by means of muscles.

There is a nerve-ring round the gullet, with a slight brain and an inferior ganglion. Sensory structures in many cases perforate the valves. Above the gut lies the heart, which is connected with blood vessels. Two (or more rarely four) nephridia open near the mouth, and serve also as genital ducts. The posterior region of the body often forms a stalk by which the shell is moored, but in many this stalk is absent, and the animal is directly attached to the substratum. The sexes are sometimes separate, but perhaps some are hermaphrodite. There is a metamorphosis in the development, and the larvæ resemble, in some respects, those of Polyzoa.

The Brachiopods date from the earliest known fossiliferous rocks, and had their maximum representation in the Ordovician and Silurian.



FIG. 130.—Interior of Brachiopod shell, showing calcareous support for the "arms."—After Davidson.

CHAPTER XII

PHYLUM ECHINODERMA

Class 1. HOLOTHUROIDEA. Sea-cucumbers.	}	SUB-PHYLUM ELEUTHEROZOA.
„ 2. ECHINOIDEA. Sea-urchins.		
„ 3. ASTEROIDEA. Starfishes.		
„ 4. OPHIUROIDEA. Brittle-stars.		
„ 5. CRINOIDEA. Feather-stars.	}	SUB-PHYLUM PELMATOZOA.
„ 6. EDRIOASTEROIDEA. Extinct.		
„ 7. BLASTOIDEA. Extinct.		
„ 8. CYSTIDEA. Extinct.		

IN contrast to the “worms,” the Echinoderms form a well-defined series. They may be described as sluggish marine animals, generally with superficially radial symmetry, with a tendency to form limy skeletons. The radial symmetry led the older zoologists to place the Echinoderma near Cœlentera, but there seems to be no real affinity. Moreover, the larval Echinoderm is bilateral in its symmetry. It seems likely that the Echinoderms represent an offshoot of some “worm” stock. As in Cœlentera, the nervous system shows a marked absence of centralisation, which may be connected with the absence of a definite head region, and this again with the sedentary or sluggish habit.

GENERAL CHARACTERS

The Echinoderms are cœlomate marine animals in which the bilateral symmetry of the larva is replaced in the adult by more or less marked radial symmetry. In addition to the dominant radial symmetry, the adults show to a varying extent a tendency towards the bilateral type, but this is never the same as that of the larva, nor is it equivalent in the different forms. Lime is always deposited in the mesodermic

tissues (mesenchyme), and in consequence there is frequently a very complete skeleton. From the primitive gut of the larva, pouches grow out to form the usually spacious cœlom and the characteristic water vascular system (hydrocœl), which may have locomotor or respiratory functions or both. The branches of this system, together with the nerves, exhibit in most cases a typical five-rayed arrangement. In addition to the water vascular system, there is an ill-defined lacunar system of blood vessels. In the hæmal vessels, water vessels, and cœlom, there are abundant migratory amœbocytes. Well-defined excretory organs are absent. Gonads arise on the lining of the body cavity, and are radially disposed except in *Holothurians*. The sexes are almost always separate. There is usually a striking circuitousness or indirectness in development. The larvæ are almost always free-swimming, and exhibit a metamorphosis. The diet is vegetarian (most sea-urchins), or carnivorous (starfishes), or consists of the organic particles found in sand and mud, the *Holothurians* in particular practising this worm-like mode of nutrition.

Most *Echinoderms* have to a remarkable extent the power of casting off and regenerating portions of their body. This power is probably one of their means of defence, but they often mutilate themselves as a consequence of unfavourable conditions of life. This self-mutilation, or autotomy, seems to be reflex, and not voluntary.

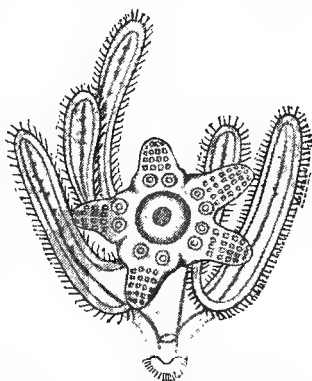

FIG. 131.—Pluteus larva of Ophiuroid, with rudiment of adult.—After Johannes Müller.

GENERAL NOTES ON STRUCTURE

The *Echinoderma*, in spite of the numerous fossil representatives, form an exceedingly well-defined group, showing no close relation to any other, and exhibiting certain striking peculiarities. The skeleton is generally well developed; in *Holothurians* it consists of isolated spicules, but elsewhere of a series of plates which may be firmly united

together, as in most sea-urchins, or may be capable of movement upon one another. Apart from the skeleton proper, lime may appear in almost any of the organs of the body. With this deep-seated tendency to form skeletal substance may perhaps be associated the sluggish habit of the majority, and the absence of definite excretory organs. Except in Holothurians, where the calcareous plates are diffusely scattered, the parts of the skeleton show much regularity of arrangement. The primitive skeleton is believed to have consisted of two series of plates, constituting respectively the oral and apical systems. These, especially the latter, were of much importance in the formation of the skeleton of the extinct Blastoids and Cystoids, but in modern Echinoderms they are absent or unimportant, and are functionally replaced by accessory plates, such as those which form the "test" of sea-urchins. The oral system consists of five plates surrounding the mouth, and in living forms it is fully developed only among Crinoids. The apical system in the Pelmatozoa typically forms a cup or calyx enclosing the viscera, and consists of a central plate to which a stalk may be attached, and three sets of plates arranged around this, five infra-basals, five basals, and five radials. In the larva of *Antedon* this apical system is fully represented, except that the infra-basals are reduced to three, but in other Crinoids and in the adult *Antedon* there tends to be reduction. Among other Echinoderms the apical system is best represented among sea-urchins, where there are often five basals (the genitals) around the anus. The "oculars" seem to correspond to the "terminals" at the tips of starfish arms. In Ophiuroids the apical system is sometimes represented both by basal and radial plates, but often only by radials; in starfishes it is typically absent in the adult, though more or less clearly shown in the larva.

The other most striking characteristic of Echinoderms is the peculiar water vascular system. This arises in development from the cœlom, and consists typically of the following parts:—An external opening or madreporite opens into a canal with calcified walls, called the stone canal; this opens into a ring canal around the mouth, which has often connected with it little vesicles and glandular bodies; the ring canal opens into five radial canals which run in the radii of the body, and give off branches to the protrusible tube-feet which project on the surface of the body, and may be furnished with suckers; the radial canals are also often connected with internal reservoirs or ampullæ. The tube-feet are very characteristic, and have different functions in the different classes. In Asteroids, in most Holothurians, and in part in Echinoids, they are primarily locomotor; in Ophiuroids, in Crinoids, and in part in Echinoids, they are respiratory, tactile, or used for food-catching. But there is great variety of structure and functions; thus in many Holothurians the tube-feet are represented only by a ring of tentacles around the mouth.

Class ASTEROIDEA. Starfishes

Star-like or pentagonal Echinoderms more or less flattened at right angles to the main axis of the body; usually with

well-defined simple arms containing the gonads and prolongations of the gut, and with a ventral ambulacral groove supported by paired ossicles and bearing the tube-feet; with regularly disposed calcareous, often spinous, plates on the skin; with an external madreporite (occasionally multiple), always on the upper surface of the disc in living forms; with a mouth at the centre of the lower surface, and usually with an anus at the opposite pole.

Description of a Starfish.

The description applies especially to the common five-rayed starfish (*Asterias* or *Asteracanthion rubens*). It is often seen in shore pools exposed at low water, but its haunts are on the floor of the sea at greater depths. There it moves about sluggishly by means of its tube-feet.

Each of the five arms bears a deep ventral groove in which the tube-feet are lodged. The mouth is in the middle of the ventral surface, the food canal ends about the centre of the dorsal disc. With this flat, five-rayed form, the 11-13 rayed sun-star (*Solaster*), the pincushion-like *Porania*, and the flat pentagonal *Palmipes*, should be contrasted. Between two of the arms lies the perforated madreporic plate, thus defining the *bivium*, while the three other arms constitute the *trivium*.

The body is covered by a ciliated ectoderm, beneath which lies a mesodermic layer. In association with the latter there is developed on the ventral surface of each arm a double series of sloping plates. These meet dorsally, like rafters, in the middle line of the arm, forming an elongated shed. The rafter-like plates are called *ambulacral ossicles*; the groove which they bound lodges the nerve-cord, the water vessel, and the tube-feet of each arm.

In association with the outer mesodermic layer of the integument, numerous smaller plates are developed, e.g. the *adambulacrals*, which articulate with the outer lower ends of ambulacrals. The dorsal surface bears a network of little ossicles, and many of these bear spines. Peculiarly modified spines, known as *pedicellariæ*, look like snapping scissor-blades mounted on a single soft handle. They

have been seen gripping Algæ and the like, and probably keep the surface of the star-fish clean.

A starfish is not very muscular, but it often bends its arms upwards by means of a muscular layer in the body wall. Other muscles affect the size of the ventral grooves, and muscular elements also occur on the protrusible part of the stomach, and in connection with the water vascular system.

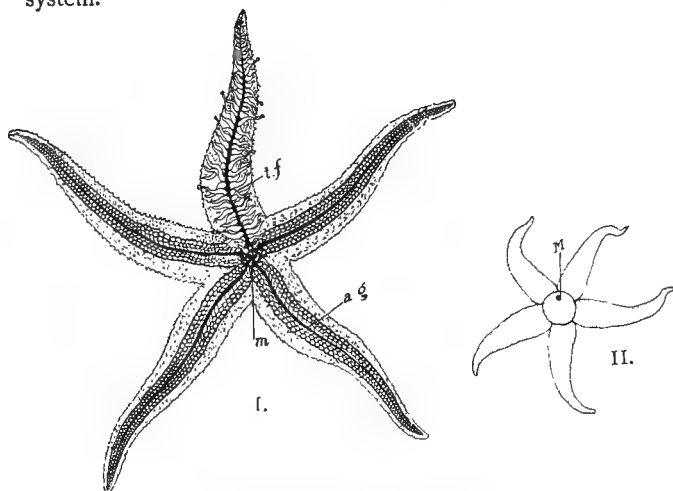

FIG. 132.—Starfish.

- I. Ventral surface; *t.f.*, tube-feet extended; *a.g.*, the ambulacral groove with the tube-feet retracted; *m.*, the mouth. II. Dorsal surface, showing the position of the madreporite (*M.*); the two adjacent arms form the bivium.

Underneath the ciliated ectoderm lies a network of nerve fibrils, with some ganglion cells. But besides these diffuse elements there is a pentagon around the mouth, and a nerve along each arm. The system is not separable from the skin. Ganglion cells are developed also on certain parts of the wall of the cœlom.

A red eye spot, sensitive to light, lies on the terminal ossicle at the tip of each arm, and is usually upturned. It is a modified tentacle, bearing numerous little cups, lined

by sensitive and pigmented cells, containing clear fluid, and covered by cuticle. The skin is diffusely sensitive. The terminal tube-foot of each ray seems to be olfactory.

The starfish may be found with part of its stomach extruded over young oysters and other bivalves. This protrusible portion of the stomach is glandular and saccu-

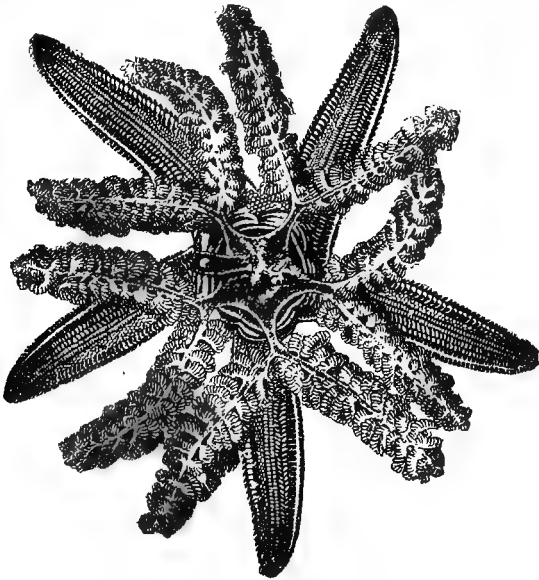

FIG. 133.—Alimentary system of starfish.—After Müller and Troschel.

The dorsal surface has been removed; the digestive caeca and the stomach are shown.

lated, and bulges slightly towards the arms; it is followed by an upper portion, giving off five branches, each of which divides into two large digestive caeca,—a pair in each arm (Fig. 133). These glands are comparable to a pancreas; their secretion contains three ferments, which convert proteids into peptones, starch into sugar, and break up fats into fatty acids and glycerine. From the short tubular

intestine between the stomach and the almost central dorsal anus two little outgrowths are given off, perhaps homologous with the "respiratory trees" of Holothurians (Fig. 139, *r.t.*). Some parts of the food canal are ciliated.

The cœlom is distinct, though not much of it is left unoccupied either in the disc or in the arms. It is lined by ciliated epithelium, and contains a fluid with amœboid cells. A few of these have a pigment which probably aids in respiration; others are phagocytes, which get rid of injurious particles through the "skin-gills"; others continue the work of digestion.

When a starfish is crawling up the side of a rock, scores of tube-feet are protruded from the ventral groove of each arm; these become long and tense, and their sucker-like terminal discs are pressed against the hard surface. There they are fixed, and towards them the starfish is gently lifted. The protrusion is effected by the internal injection of fluid into the tube-feet; the fixing is due to the production of a vacuum between the ends of the tube-feet and the rock.

As to the course of the fluid, it is convenient to begin with the madreporic plate, which lies between the bases of two of the arms (the *bivium*). This plate is a complex calcareous sieve, with numerous perforating canals and external pores. It may be compared to the rose of a watering-can, but the holes are much more numerous, and lead into small canals, which converge into a main ciliated canal, the stone canal. This, as usual, opens into a ring canal around the mouth. The ring canal gives off nine glandular bodies (Tiedemann's bodies), and five radial tubes, one for each of the arms. Considerations of symmetry suggest that there should be ten glandular bodies, but in the inter-radius containing the stone canal there is only one. In many starfishes there are five or ten little reservoirs (Polian vesicles) opening into the circumoral ring, but in *Asterias rubens* these are hardly distinguishable from the first ampullæ of the radial vessels. These run along the arms, and lie in the ambulacral groove beneath the shelter of the rafter-like ossicles. From them branches are given off to the bases of the tube-feet, but from each of these bases a canal ascends between each pair of ambulacral ossicles, and expands into an ampulla or reservoir on the dorsal or more internal side (see Fig. 134). The fluid in the system may pass from the radial vessels into the tube-feet, and from the tube-feet it can flow back, not into the radial vessel, but into the ampullæ. There are muscles on the walls of the tube-feet, ampullæ, and vessels. At the end of each arm there is a long unpaired tube-foot, which seems to act as a tactile tentacle, and has also olfactory significance.

With regard to the vascular system there is considerable uncertainty. There is probably no definite vascular system at all. The organ described as a heart is really the "genital stolon." There is a "pseud-hæmal sinus" surrounding the stone canal, leading into a circum-oesophageal ring, which gives off a vessel along each ray.

From the dorsal surface and sides of a starfish in a pool, numerous transparent processes may be seen hanging out into the water. They are the simplest possible respiratory structures, contractile outgrowths of the skin with cavities

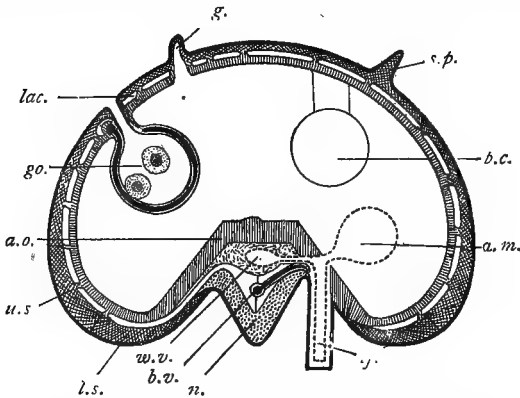

FIG. 134.—Diagrammatic cross-section of starfish arm.—
After Ludwig.

n., Radial nerve; *b.v.*, radial blood vessel according to Ludwig, septum in pseud-hæmal vessel according to others; *w.v.*, radial water vessel; *am.*, ampulla; *l.f.*, tube-foot; *p.c.*, a pyloric cæcum cut across; *s.p.*, a calcareous spine; *g.*, a skin-gill; *lac.*, spaces in the wall; *go.*, ova in ovary; *a.o.*, ambulacral ossicle.

continuous with the cœlom, and are called "skin-gills." It is likely that pigmented cells of the body cavity fluid act like rudimentary red blood corpuscles; the water vascular system may help in aeration; and the whole body is, of course, continually washed with water.

The "skin-gills" are said to have an excretory function; for phagocytes, bearing waste, seem to traverse their walls. It may also be that excretion is somehow concerned in

forming the carbonate of lime skeleton, but facts are wanting.

The sexes are separate, and they are like one another, both externally and internally. The gonads develop periodically, and lie in pairs in each arm. Each is branched like an elongated bunch of grapes, and is surrounded by a "blood sinus." Each has a separate duct, which opens on a porous plate, between the bases of the arms on the dorsal surface. In *Asterina gibbosa*, however, the eggs are extruded ventrally. In the same species there is an interesting sexual variability: many are first males and then females (protandric), others are simply hermaphrodites, others seem exclusively of one sex. The eggs of starfishes are fertilised in the water, and the free-swimming larva is known as a *Bipinnaria* or as a *Brachiolaria*.

Other Starfishes

Parental care is incipient among Asteroids. A species of *Asterias* has been seen sheltering its young within its arms: there is a definite brood-pouch in the form of a sort of tent on the dorsal surface of *Pteraster*.

Many Asteroids break very readily, or throw off their arms when these are seized. The lost parts are slowly regenerated, and strange forms are often found in process of regrowth. Thus the "comet form" of starfish occurs when a separated arm proceeds to grow the other four.

There are many deep-sea forms, such as the ophiuroid-like *Brisinga*, the widely-distributed *Hymenaster*, and the blue *Porcellanaster cœruleus*; but the majority occur in water of no great depth.

Asteroidea first occur in Silurian strata.

Classification.—

Order I. Phanerozonia. With strongly developed marginal plates, the upper and lower marginals in contact; with skin-gills restricted to the dorsal (abactinal) surface; with broad ambulacral plates; with prominent adambulacrals in the peristome, with pedicellariæ sessile (if present), with two rows of tube-feet.

e.g. *Astropecten*, *Luidia*, *Porania*, *Asterina*, *Palmipes*.

Order II. Cryptozonia. With indistinct or rudimentary marginal plates in the adults, often with intermediate plates between the

upper and lower marginals, with skin-gills not restricted to the dorsal (abactinal) surface, with narrow ambulacral plates, with ambulacrals or adambulacrals prominent in the peristome, with pedicellariæ sessile or stalked (if present), often with apparently four rows of tube-feet.

e.g. Asterias, Solaster, Henricia, Brisinga.

Class OPHIUROIDEA. Brittle-stars, *e.g. Ophiopholis aculeata*

Echinoderms with a stellate flattened body, nearly related to starfishes, but usually differing from them in having the arms (sometimes branched) sharply marked off from the

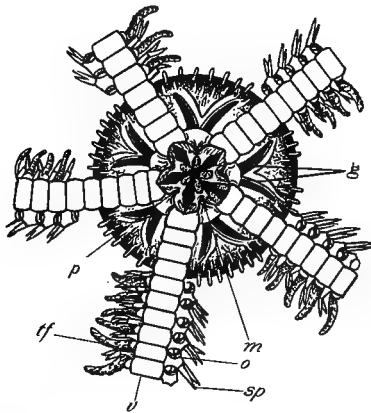

FIG. 135.—Ventral surface of disc of an Ophiuroid (*Ophiothrix fragilis*).—After Gegenbaur.

- g.*, Openings of genital pockets or bursæ; *m.*, mouth; *v.*, ventral plates of arms; *sp.*, spines of arms; *tf.*, tube-feet—at the right side these are represented as retracted; *o.*, the openings through which they are protruded; *p.*, plates around mouth bearing the so-called teeth; one of these plates is perforated, and functions as the madreporite.

central disc, no ambulacral groove on the ventral surface of the arms, the digestive organs and gonads restricted to the disc, and the madreporite ventral. There is no anus. There are deep respiratory clefts on the disc at the insertion of the

arms. They agree with starfishes in being free, in having radially disposed gonads, in having the tube-feet restricted to the under surface, and in other features.

The body of a brittle-star differs from that of a starfish in the abruptness with which the arms spring from the central disc (cf. *Brisinga*). These arms are muscular, and useful in wriggling and clambering; they do not contain outgrowths of the gut, nor reproductive organs. Moreover, there is no ambulacral groove, and the tube-feet which project on the sides are usually very small. They are often of locomotor service, adhering even to vertical surfaces, but in many cases they seem to be only sensory. Each segment of the arm includes a central "vertebral ossicle," with four plates forming a tube round about it. There is a complete oral skeleton. The madreporic plate is situated on the ventral surface, usually on one of the plates around the mouth. The food canal ends blindly.

Some brittle-stars have small luminescent glands, e.g. *Amphiura squamata*. The reproductive organs lie in pairs between the arms, and open into pockets or bursæ formed from inturnings of the skin, which communicate with the exterior by slits opening at the bases of the arms. Water currents pass in and out of these pockets, which probably have both respiratory and excretory functions.

The free-swimming larva is a *Pluteus*, very like that of Echinoids (see Fig. 131).

Ophiuroids are first found in Silurian strata.

The Ophiuroids are usually classified according to the characters of their ossicles and covering plates. Some common genera are *Ophiothrix*, *Ophiocoma*, *Ophiopholis*, *Ophiura*. In the deep-water *Astrophyton* and *Gorgonocephalus* the arms are repeatedly branched. In *Astronyx loveni*, often caught in the trawl off the north coast of Britain, the disc is relatively large and soft and the arms very long. In the extinct *Lysophiuræ* there is an ambulacral groove.

Class ECHINOIDEA. Sea-Urchins, e.g. the common
Echinus esculentus

Echinoderms with the body covered by rows of plates, usually in vertical series and forming an inflexible test; the shape of the majority approaches a sphere, but some are pin-

cushion-like, flat, or obviously bilateral; the test is covered with spines which vary greatly in length and thickness in the different types; the locomotor and respiratory tube-feet usually extend from the peristome to near the aboral pole; there is often a well-developed system of apical plates; the mouth is at the lower pole, the anus either at the aboral pole or in the posterior inter-radius; the gonads are unpaired, five in number, and inter-radial.

Description of the Common Sea-Urchin.

Most sea-urchins live off rocky coasts, and not a few shelter themselves sluggishly in holes. They move by

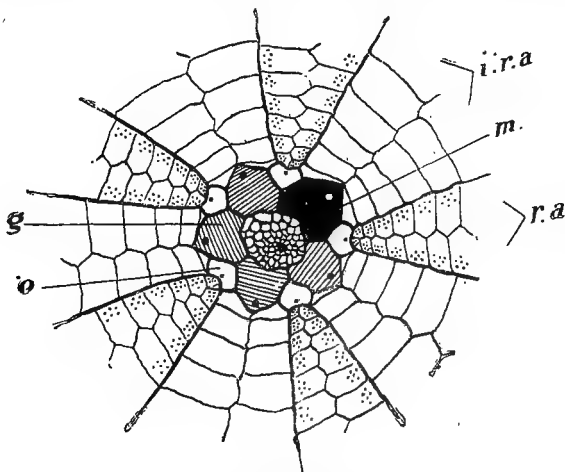

FIG. 136.—Apical disc of sea-urchin

- In the centre is the periproct bearing the anus; around it are five genital or inter-radial plates (*g.*), one of which is modified as the madreporite (*m.*); beyond these five ocular or radial plates (*o.*); *i.r.a.*, an inter-radial or inter-ambulacral area, with spines only; *r.a.*, a radial or ambulacral area, with spines and openings for tube-feet.

means of their tube-feet and spines, and seem to feed on "acorn-shells" and other small sedentary animals, some seaweeds, and the organic matter found in mud and other

deposits. After the perils of youth are past, the larger forms have few formidable enemies.

The hard and prickly body is more or less spherical. The food canal begins in the middle of the lower surface; it ends at the opposite pole in the middle of an apical disc, formed in the young animal of a central plate surrounded by five "ocular" and five "genital" plates. In the adult the central plate is no longer distinct. Each has a hole for the protrusion of a sensitive tube-foot; the genitals bear the apertures of the genital ducts, and one also bears the perforated madreporic plate. From pole to pole run ten meridians of calcareous plates, which fit one another firmly; five of these (in a line with the ocular plates) are known as ambulacral areas, for through their plates the locomotor tube-feet are extruded; the five others (in a line with the genital plates) are called inter-ambulacral areas, and bear spines, not tube-feet. Altogether, therefore, there are ten meridians, and each meridian area has a double row of plates. On the dry shell from which the spines have been scraped, the ambulacral plates are seen to be perforated by small pores, three pairs or so to each plate. Through each pair of pores a tube-foot is connected with an internal ampulla. In the starfish the ambulacral areas are wholly ventral, and the apical area seen on the dorsal surface of the young forms is not demonstrable in the adult.

On the shell there are obviously many spines, most abundant on the inter-ambulacral areas. Their bases fit over ball-like knobs, and are moved upon these by muscles. But besides these, there are modified spines—(a) several kinds of pedicellariæ, with three snapping blades on a soft stalk, and sometimes with apical glands; and (b) small globular spheridia, which show some structural resemblances to otocysts. It is said that, like true otocysts, they are concerned with the perception of direction of motion. New spines and pedicellariæ can be grown to replace those that are shed in unwholesome conditions or rubbed off by accident. This is the only marked regeneration in sea-urchins.

In front of the mouth project the tips of five teeth, which move against one another, grasping and grinding small particles. They are fixed in five large sockets or pyramids,

and along with five stout "braces" (*rotulæ*) and five curved "compasses" (*radii*) form "Aristotle's lantern," a complex masticating apparatus, of whose history we know little. It surrounds the pharynx, and is swayed about and otherwise moved by muscles, many of which are attached to five beams which project inward from the margin of the shell and form a "girdle" round about the mouth.

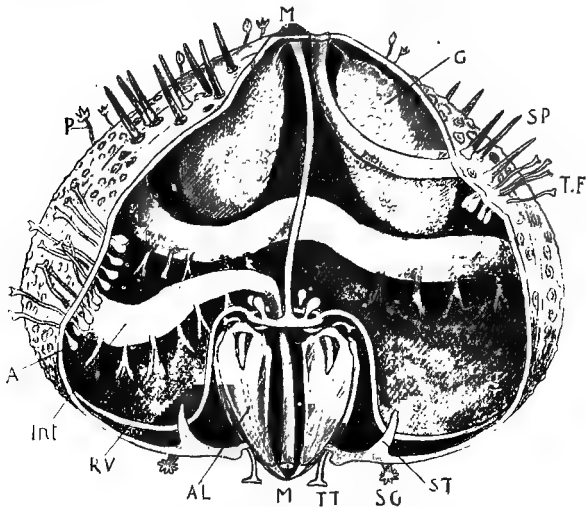

FIG. 137.—Dissection of sea-urchin.

M. at the lower pole is the mouth; *M.* at the upper pole is the madreporic plate; *T.T.*, one of the large tentacular tube-feet around the mouth; *S.G.*, a skin-gill; *S.T.*, a standard or perignath; *A.L.*, an alveolus; *R.V.*, a radial vessel, with ampullæ (*A.*); intestine (*Int.*) fixed by mesenteries; *P.*, a pedicellaria; *G.*, a gonad; *S.P.*, spines; *T.F.*, tube-feet.

As in other Echinoderms, the skeleton of lime is mesodermic. The shell is covered externally by a delicate ciliated ectoderm, beneath which, in a thin layer of connective tissue, there is a network of nerve fibres, and some ganglion cells. Internally, there is another thin layer of connective tissue, and a ciliated epithelium lining the body cavity. The skeleton grows by the formation of

new plates around the apical disc, and also by the individual increase of each. In a few forms the shell retains some plasticity.

The nervous system consists of a ring around the mouth, of radial branches running up each ambulacral area, and of the superficial network. Tube-feet, sphæridia, pedicellariæ, and spines are all under nervous control, and each radial nerve ends in the "eye specks" of the apical "ocular plates." It is probable that all the tube-feet are sensory, and this is certainly the main function of ten which lie near the mouth.

The alimentary canal passes through Aristotle's lantern, and the intestinal portion lies in two and a half coils around the inside of the shell, to which it is moored by mesenteries. It contains fine gravel, sand, and some organic débris. It ends near the centre of the apical disc, whence the pedicellariæ have been seen removing the fæces.

The spacious body cavity is lined by ciliated epithelium, and contains a "perivisceral" fluid, whose corpuscles have a respiratory pigment (echinochrome). When the fluid of a perfectly fresh sea-urchin is emptied out, the contained corpuscles unite in plasmodia, forming composite amœboid clots (cf. *Protomyxa*, etc.).

The madreporic plate communicates with a membranous stone canal (calcareous in *Cidaris*) which runs downwards into a circular vessel near the upper end of the lantern. This gives off five inter-radial transparent "Polian" vesicles and five radial vessels, which run down the sides of the lantern and up each ambulacral area. Each radial vessel gives off numerous lateral branches, which communicate with the internal ampullæ and thence with the external tube-feet. When the tube-feet are made tense with fluid, they extend far beyond the limit of the spines, and are attached to the surface of the rock over which the sea-urchin slowly drags itself. The sucker at the tip of each tube-foot bears a rosette of small calcareous plates; indeed, there is hardly any part of an Echinoderm in which lime may not be deposited. Before bending upwards from the base of the lantern, each radial vessel gives off a branch to two large tentacle-like tube-feet without attaching discs. The five pairs lie near the mouth, and are sensitive.

The blood vascular system is not readily traced, and there is uncertainty as to many points. A "dorsal or axial organ" lies beside the stone canal, and seems to be connected with a "genital ring" and with a circular vessel around the gullet. There is also a "pseud-hæmal" system consisting of a circum-oesophageal sinus with radial branches. The fluid cannot be distinguished from that of the body cavity; it contains corpuscles, some of which are pigmented.

On the area round about the mouth there are ten hollow outgrowths, which resemble the skin-gills of starfishes. There are also five large vesicles at the top of the lantern ("Stewart's organs") which may function as internal gills. As already mentioned, the pigmented cells of the body cavity fluid seem able to absorb oxygen. There is no doubt that the water vascular system plays a very important part in respiration. It probably also aids in excretion.

The sexes are separate, and indistinguishable externally. Five large branched yellow-brown ovaries or rose-white testes lie inter-radially under the apex of the shell, and open by separate ducts on the five genital plates. In spring the apical disc may be seen covered with orange ova or milky-white spermatozoa.

The eggs are fertilised externally by sperms wafted from adjacent sea-urchins, and the free-swimming larva is called a Pluteus.

Classification.—

The class may be divided into three sub-classes or groups of orders.

Sub-Class I. Regularia Endobranchiata. Mouth and anus at opposite poles; the anus surrounded by the apical system of plates if these are developed; no external gills.

e.g. the somewhat primitive *Cidaris*.

Sub-Class II. Regularia Ectobranchiata. Mouth and anus at opposite poles; a double circle of apical plates surrounds the anus; there are external gills.

e.g. the common genera *Echinus*, *Strongylocentrotus*, *Arbacia*.

The Echinothurinæ have flexible tests and powerful muscles.

e.g. *Asthenosoma* and *Phormosoma*.

Sub-Class III. Irregularia. The anus lies outside the apical system of plates in the posterior inter-radius.

e.g. the heart-urchins, *Spatangus* and *Echinocardium*, without lanterns. In the related *Echinoneus* there is a lantern in the young forms. It is interesting to contrast the large massive *Clypeaster* with the minute *Echinocyamus pusillus*, common in the stomach of cod-fishes.

Class HOLOTHUROIDEA. Sea-Cucumbers

Cylindrical or worm-like Echinoderms, elongated in the direction of the main axis, with more or less tendency to bilateral symmetry, with a usually soft or leathery skin, with irregularly scattered microscopic calcareous bodies, with a terminal mouth surrounded by tentacles, with a posterior anus, with or without tube-feet, with no external madreporite, with a muscular body wall.

The Holothurians do not at first sight suggest the other Echinoderms, for they are like plump worms, and the

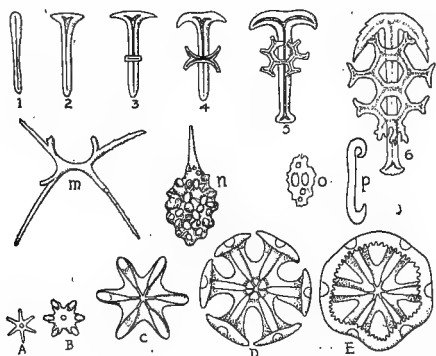

FIG. 138.—Spicules of Holothurians.—After Semon.

The series 1-6 shows stages in the development of an anchor and a plate in a *Synapta*. The series A-E shows stages in the development of a wheel in *Chiridota*, a Synaptid.

calcareous skeleton is not prominent. But closer examination shows the characteristic pentamerous symmetry, and the occurrence of calcareous plates in the skin. These seem to be absent in the unique pelagic *Pelagothuria*.

Holothurians occur in most seas, from slight to very great depths. Their food consists of small animals, and of organic particles from the sand. Some of them catch these in their waving tentacles, which are then plunged into the pharynx. The muscles of a captured Holothurian often over-contract and eject the viscera at the ends or through

a side rupture; in this way the animal may sometimes escape, and the viscera can be regrown.

In *Synapta* the rupture of the body takes place very rapidly, and is probably defensive, the anterior portion re-forming a complete individual. In some forms of *Cucumaria planci* the body divides by stricture, torsion, or stretching into two or three equivalent parts, each of which may regenerate the whole. In this case the autotomy seems to be reproductive.

The worm-like body is often regular in form, with five equidistant longitudinal bands, along which tube-feet emerge. But three of these "ambulacral areas" may be approximated on a flattened ventral sole, leaving two on the convex dorsal surface, and there are other modifications of form. In many cases the tube-feet are modified into pointed papillæ.

The body wall is tough and muscular, consisting of epidermis, dermis, and circular muscles, and there are paired longitudinal muscles along each radius. A skeleton is represented by scales, plates, wheels, and anchors of lime scattered in the skin, and by plates around the gullet and on a few other regions.

The nervous system consists of a circumoral ring in which the five radial nerves running in the ambulacral areas unite, and from which nerves to the tentacles arise. The ring and the radial nerves are sunk below the skin. Cœlomic nervous tissue is developed on the perihæmal canals. Sense organs are represented by the tentacles, which sometimes have "ear-sacs" at their bases, and by tactile processes on the dorsal surface of some of the creeping forms.

From the terminal or ventral mouth, surrounded by five, ten, or more tentacles, the food canal coils to the opposite pole. There it expands in a cloacal chamber sometimes contractile, and from this are given off in many forms a pair of much-branched "respiratory trees," which extend forward in the body cavity. These "trees" are supplied with water by means of the rhythmic contractions of the cloaca. They are respiratory, hydrostatic, and excretory. The body fluid sometimes contains a red pigment like hæmoglobin. Arising from the base of the respiratory trees in some Holothurians there are the remarkable "Cuvierian

organs," which emit white conical bodies from the cloaca when the animal is irritated. The bodies remain adherent by their bases, are greatly elongated by internal fluid pressure into sticky tubes which break off. They will adhere to almost everything but the Holothurian itself. Those Holothurians, e.g. *Holothuria nigra*, in which the organs are well developed are often called "cotton-spinners," on account of the dense mass of viscid substance which they eject. A little fish, *Fierasfer*, introduces itself—tail first—into the cloaca of several Holothurians, and lives there as an innocent commensal.

The water-vascular system shows many peculiarities. In what, by analogy with the other classes, may be described as the primitive condition, there is a ring canal round the mouth communicating with the exterior by a stone canal, with one or more Polian vesicles hanging in the body cavity, and with five radial canals. The radial canals, as in starfishes and sea-urchins, are connected with internal ampullæ and external tube-feet. The anterior tube-feet are greatly enlarged and modified to form the tentacles which encircle the mouth. It is, however, only rarely that the water-vascular system exhibits this primitive condition. In most cases the stone canal loses its original connection with the exterior and opens merely into the body cavity; often it is represented by numerous small canals, hanging freely in the body cavity (Fig. 139, *st.*). Certain of the tube-feet are always modified to form tentacles, and these may, as in *Synapta*, be the only representatives of the tube-feet. In regard to the function and degree of development of these, there is indeed much variation.

The blood-vascular system consists of a circum-oesophageal ring and vessels to the alimentary canal and the gonads. The system is in great part lacunar. There is also a pseud-hæmal system.

The sexes are usually separate. The reproductive organs do not exhibit radial symmetry, and are branched tubes which open within or just outside the circle of tentacles. Like other internal organs of Holothurians, they are often very brightly coloured. The larva is, in most cases, what is known as an *Auricularia*. Sometimes, however, the larval stage is skipped, as in *Cucumaria crocea* and *Psolus ephippifer*, where the eggs and young are attached to the back of the mother. In *C. curata* the eggs and young are sheltered on the ventral surface; in *C. parva* in a shallow ventral insinking; in *C. lævigata* there is an invaginated ventral brood-pouch; in *Chiridota contorta* the young are sheltered in the genital tubules; in *Synapta vivipara* and

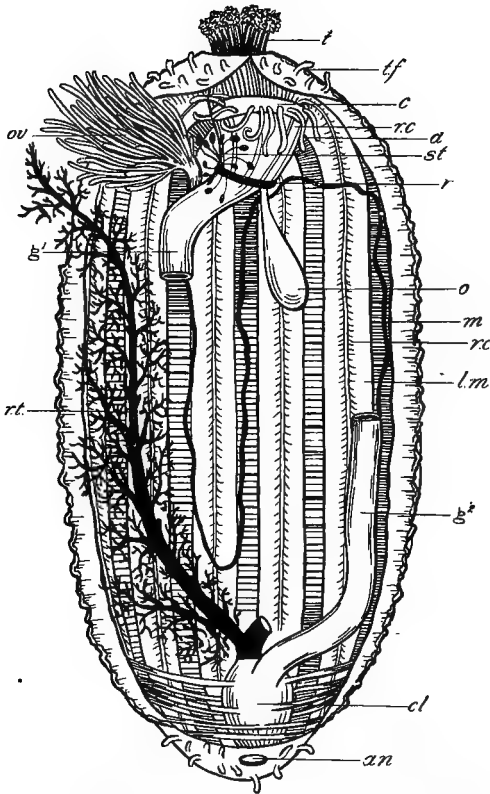

FIG. 139.—Dissection of Holothurian (*Holothuria tubulosa*) from the ventral surface.

t., Tentacles surrounding the mouth; *t.f.*, scattered tube-feet of ventral surface; *c.*, calcareous ring surrounding the food canal; *a.*, ampullæ of tentacles (modified tube-feet); *r.*, circular vessel surrounding the gullet, giving off the branched stone canal (*st.*), the single Polian vesicle (*o.*), and the five radial canals (*r.c.*), which run forwards, pass through the calcareous ring, and then curve outwards to run on the surface of the longitudinal muscles (*l.m.*) along the radial areas. Of the five longitudinal muscles, one only is marked. *g*¹, The gut cut through at the beginning of the first loop; *m.*, the mesentery which attaches the gut to the body wall, showing the course of the gut; *g*², the other end of the gut; *cl.*, the cloaca bound down by muscles; *an.*, the anus; *r.t.*, the right respiratory tree—the left is cut short close to its origin; *ov.*, the ovary. The blood vessels are not shown.

some others the body cavity serves as a brood-pouch. This illustrates how the same result may be reached in a great variety of ways.

The calcareous plates of Holothurians are found as far back as Carboniferous strata.

As "trepang" or "bêche-de-mer," the Holothurians of the Pacific form an important article of commerce, being regarded as a delicacy by the Chinese.

Classification.—

Order 1. Actinopoda. The radial water vessels are associated with external tentacles, tube-feet, and ambulacral papillæ, but the tube-feet and papillæ may be absent. There are several families, e.g. the deep-sea *Elasipoda*, markedly bilateral, almost always flattened ventrally, often with an external pore for the stone canal, e.g. *Elpidia* and *Kolga*; the *Aspidochirota*, e.g. *Holothuria* and *Stichopus*, and *Dendrochirota*, e.g. *Cucumaria*, *Thyone*, *Psolus*, with tube-feet as well as tentacles; the *Molpadiidæ* with tentacles only, e.g. *Molpadia*; the *Pelagothuriidæ* containing the free-swimming *Pelagothuria*.

Order 2. Paractinopoda or Apoda. The only external outgrowths of the water-vascular system are the pinnate tentacles around the mouth. One family, *Synaptidæ*, e.g. *Synapta* and *Chiridota*. There are no tube-feet or respiratory trees or Cuvierian organs. The calcareous bodies are usually beautiful anchors and plates. Many are hermaphrodite.

Class CRINOIDEA. Feather-stars

Usually stalked forms, with five jointed, often branched arms ("brachia"), growing out from a central cup or "theca," and bearing pinnules; the arms arise from a corresponding number of thecal plates or "radials," below which there is a circlet of alternating "basals," often with "infra-basals" alternating again with them; below the "basals" or "infra-basals" there is usually a jointed stem anchored to the substratum by "cirri."

The feather-stars or sea-lilies differ from other Echinoderms in being fixed permanently or temporarily by a jointed stalk. The modern Comatulids, e.g. the rosy feather-star (*Comatula* or *Antedon rosacea*) leave their stalk at a certain stage in life; but the other Crinoids, e.g. *Pentacrinus*, are permanently stalked, like almost all the extinct stone-lilies or encrinites, once so abundant. Most of them live in deep

water, and many in the great abysses. An anchorage is found on rocks and stones, or in the soft mud, and great numbers grow together—a bed of sea-lilies. The free Comatulids swim gracefully by bending and straightening their arms, and they have grappling “cirri” on the aboral side, where the relinquished stalk was attached. By these cirri they moor themselves temporarily. Small organisms—Diatoms, Protozoa, minute Crustaceans—are wafted down ciliated grooves on the arms to the central mouth, which is of course on the upturned surface. Some members of

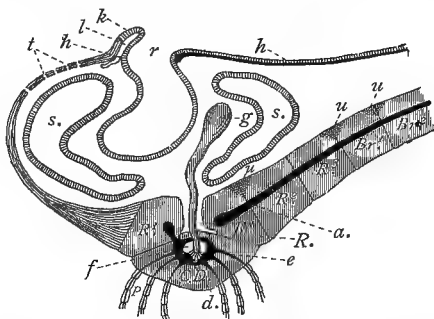

FIG. 140.—Diagrammatic vertical section through disc and base of one of the arms of *Antedon rosacea*.—After Milnes Marshall.

The section is inter-radial on the left, radial on the right. *z*, Ciliated openings in body wall; *h*, sub-epithelial ambulacral nerve; *l*, water-vascular canal; *k*, tentac'le; *r*, mouth; *s*, intestine; *g*, central plexus, with “chambered organ” at its base; *f*, coelom; *R*¹-*R*³, radial plates; *Br.*, brachial plates; *u*, muscle; *a*, axial nerve-cord; *d*, central capsule; *C.D.*, centro-dorsal plate; *p*, cirri; *e*, nerve branches from central capsule to cirri.

the class, e.g. *Comatula*, are infested by minute parasitic “worms” (Myzostomata) allied to Chætopods, which form galls on the arms. A lost arm can be replaced, and even the visceral mass may be regenerated completely within a few weeks after it has been lost. It has been suggested that the occasional expulsion of the visceral sac frees the Crinoid from parasites (Dendy).

The animal consists of (1) a cup or calyx, (2) an oral disc forming the lid of this cup, (3) the radiating “arms,” and (4) the stalk supporting the whole. The lowest part of the cup is supported by a pentagonal

“centro-dorsal” ossicle, bearing the cirri; this conceals the coalesced “basals” of the larva; above this are three tiers of “radials,” whence spring the “brachials” of the arms.

The oral disc, turned upwards, is supported by plates. Here the anus also is situated. The arms usually branch in dichotomous fashion, and thus ten, twenty, or more may arise from the original five. But the growing point continues to fork dichotomously, like the leaf of many ferns, and as each alternate fork remains short, a double series of lateral “pinnules” results. The arms are supported by calcareous plates. The stalk usually consists of numerous joints, especially in extinct forms, in some of which it measured over fifty feet in length. Except in *Holopus*, *Hyocrinus*, and in the stalked stage of *Antedon*, the stalk bears lateral cirri.

The nervous system consists (*a*) of a circumoral ring with ambulacral nerves, and (*b*) of axial coelomic nerves up the ossicles on the opposite side of each arm and connected with a peculiar “chambered organ” in the interior of the centro-dorsal plate.

Apart from the superficial epithelium, there are no sensory structures. The ciliated food canal descends from the mouth into the cup, and curves up again to the anus, which is on a papilla. The last part of the gut is expanded to form an anal tube, which during life is in constant movement, and has apparently a respiratory function. From the cup, where the body cavity is in great part filled with connective tissue and organs, four coelomic canals extend into each of the arms. They communicate at the apices of the arms and pinnules, and currents pass up one and down the other.

The blood-vascular system consists of a circumoral ring, which is connected with a radial vessel under each ambulacral nerve, and with a circum-oesophageal plexus.

The water-vascular system consists as usual of a circumoral ring and radial vessels, but in several respects it shows remarkable modification. The madreporite of other forms is represented by fine pores which open from the surface of the calyx directly into the body cavity, and which may be very numerous; there are said to be 1500 in *Antedon rosacea*. By these pores water enters the body cavity, and from it enters the numerous stone canals which hang from the ring freely in the body cavity, and open into it near the pore canals. There are no Polian vesicles or ampullæ, the tube-feet are small, are arranged in groups of three, and are connected by delicate canals with the radial vessels. Certain of them form tentacles around the mouth, and these are supplied by canals coming off directly from the ring canal.

The sexes are separate. The reproductive organs extend as tubular strands from the disc along the arms, but are rarely functional except in the *pinnules*, from each of which the elements burst out by one duct in females, by one or two fine canals in males.

The oval ciliated larva of *Antedon*, the only one known, is less peculiar than that of other Echinoderms.

There are about 400 living species in twelve genera, but about 1500 species in 200 genera are known from the rocks. The class is obviously decadent. It is represented in the Cambrian, and attained its maximum development in Silurian, Devonian, and Carboniferous times.

The recent forms include the stalked *Pentacrinus*, *Rhizocrinus*, etc., and the free Comatulids, which pass through a stalked *Pentacrinus* stage, e.g. *Antedon*.

Class EDRIOASTEROIDEA. Wholly extinct

These extinct Pelmatozoa had a sac-like theca of an indefinite number of irregular plates, with a mouth in the centre of the upper surface, with at most a short stalk. Ordovician, Silurian, and Devonian. "They are alone among Pelmatozoa in presenting a type of ambulacrum from which the holothurian, stellerid, and echinoid types may readily be derived" (F. A. Bather).

Class BLASTOIDEA. Wholly extinct

The Blastoids are first found in the upper Silurian, later than Cystoids and Crinoids; they had their golden age in the Carboniferous and Devonian times, but then disappeared. Their body was ovate, with five ambulacral areas, with each groove of which jointed pinnules were associated.

Class CYSTIDEA. Wholly extinct

The Cystidea are first found in the Lower Silurian rocks, had their golden age in Upper Silurian times, and died out in the Carboniferous period. Their body was ovate or globular, sessile or shortly stalked, covered with polygonal plates often irregularly arranged.

DEVELOPMENT OF ECHINODERMS

The ovum undergoes total segmentation, and a hollow ball of cells or blastosphere results. A typical gastrula is formed by invagination.

The mesoblast has a twofold origin: (*a*) from "mesenchyme" cells, which immigrate from the invaginated endoderm into the segmentation cavity; (*b*) from the outgrowing of one or more coelom pouches (vaso-peritoneal vesicles) from the gastrula cavity or archenteron. From these vesicles the body cavity and the rudiments of the water-vascular system arise.

The larva is, first of all, a slightly modified, diffusely ciliated gastrula. In Holothuroids, Echinoids, Asteroids, and Ophiuroids, it becomes quaintly modified by the outgrowth of external processes, and the formation of

special ciliated bands. These are at first simply pre-oral and pre-anal rings, but they become drawn out along variously disposed and shaped processes. The larva of Crinoids (of *Antedon*) is not so divergent. In all cases the bilateral symmetry is preserved.

The larva does not grow directly into the adult. On the contrary, the adult arises, for the most part, from new growth within the larva on one side. The arms or processes peculiar to the larva are absorbed or in part thrown off. Only in a few forms which have brood-chambers or

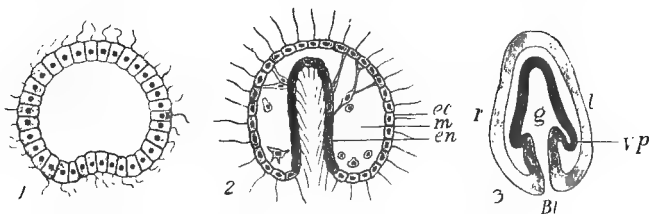

FIG. 141.—Stages in development of Echinoderms.—After Selenka.

1. Section of blastula of *Synapta digitata* (Holothuroid), with a hint of gastrulation. 2. Section of gastrula of *Toxopneustes brevispinosus* (sea-urchin); *ec.*, ectoderm; *en.*, endoderm; *m.*, segmentation cavity with mesenchyme cells in it. 3. Section of larva of *Asterina gibbosa* (starfish); *Bl.*, blastopore; *g.*, archenteron; *v.p.*, vaso-peritoneal vesicle; *r.* and *l.*, right and left sides.

are viviparous is the development direct, and without free-swimming larvæ.

The celebrated comparative anatomist and physiologist, Johannes Müller, was the first to show that the various types of Echinoderm larvæ might be derived from one fundamental form.

“This fundamental type is an elongated, oval, or pear-shaped larva, which is somewhat flattened on its ventral side. It has arisen from a gastrula whose blastopore has become the anus, while the archenteron is bent towards the ventral surface, where it communicates by the larval mouth with the exterior. Besides these two apertures, the larva has a third, namely, the dorsal pore of the water-vascular system. The cilia, with which the larva was at first uniformly covered, partly disappear, and persist only in restricted regions or ciliated bands” (Korschelt and Heider).

Crinoids.—The simplest Echinoderm larva is that of *Antedon*, a somewhat modified oval, with five transverse rings of cilia (the most

SOME CONTRASTS BETWEEN THE FIVE EXTANT CLASSES OF ECHINODERMS

HOLOTHUROIDEA.	ECHINOIDEA.	ASTEROIDEA.	OPHIUROIDEA.	CRINOIDEA.
The body is elongated and worm-like, with a rough muscular skin, in which limy plates are imbedded.	The body is globular, heart-shaped, or flattened. Limy plates form a usually rigid shell, and bear movable spines. Pedicellariæ are present.	The body is flattened, pentagonal, or stellate. The arms have a deep ventral ambulacral groove. The skin bears many limy plates, tubercles, etc., and pedicellariæ are present.	The body is a flat pentagonal disc, from which five plated arms; without any ambulacral groove, radiate abruptly.	A permanent or temporary jointed stalk bears a complex cup, from which branched arms with lateral pinnules spread outwards.
They move partly by muscular writhings, partly by means of the tube-feet.	They move by means of the tube-feet, aided a little by the spines.	They move by means of the tube-feet.	They move by wringing the muscular arms.	<i>Antedon</i> and other free comatulids swim gently, the others sway their arms on the top of stalks.
There is a circumoral nerve-ring with radial branches. Sometimes there are "ear-sacs."	There is a circumoral nerve-ring, with radial branches. There are "eyes."	There is the usual ambulacral nervous system, and there are eyes at the tip of the arms.	There is the usual ambulacral nervous system; there are no special sense organs.	There is a motor and sensory ambulacral nervous system, and the usual ambulacral system, which is mainly sensory. No special sense organs.
The mouth, surrounded by tentacles, is at or near, one pole; the anus at or near the other.	The mouth is in the middle of the ventral surface; the anus is usually at or near the opposite pole.	The mouth is ventral and central; the anus, when present, dorsal. Extensions of the digestive tract lie in the arms.	The mouth is ventral and central; there is no anus.	Mouth and anus are near one another on the upturned surface.
The madreporic plate may open into the body cavity, but is usually suppressed; the tube-feet are often restricted, and often mere papillæ without terminal discs. Some are always modified to form the circle of tentacles which surround the mouth.	The madreporic opening is on one of the five genital plates in the apical disc. The tube-feet end in discs.	The madreporic plate is dorsal and interradial. The tube-feet end in discs.	The madreporic plate is ventral, usually on one of the oral plates. The tube-feet are pointed, lateral, and small.	The water-vascular system communicates by several canals with the body cavity, into which water enters by numerous pores. The tube-feet are respiratory tentacles, and assist in food-catching.
The reproductive organs are branched tubes in the body cavity; they open near the base of the wreath of tentacles, and do not exhibit a five-rayed arrangement.	The reproductive organs lie under the apical region, and open interradially on apical plates.	The reproductive organs lie in the arms, and open interradially.	The reproductive organs lie in the body, and open interradially at the bases of the arms.	The functional parts of the reproductive organs are restricted to the pinnules, and open there.
Larva—an <i>Auricularia</i> .	Larva—a <i>Pintus</i> .	Larva—a <i>Bipinnaria</i> or a <i>Brachiolaria</i> .	Larva—a <i>Pluteus</i> .	The Larva of <i>Antedon</i> is barrel-shaped, with five transverse ciliated rings and a posterior tuft.

anterior is less distinct), and a posterior terminal tuft. Eventually the posterior end is elongated to form, in the pentacrinoïd stage, an attaching stalk, which is afterwards absorbed. As all the extinct Crinoids are permanently stalked, there is here an instance of Recapitulation.

Holothuroids.—The larva of Holothuroids (an *Auricularia*) is much quaint. Its diffuse cilia are succeeded by a wavy longitudinal band, which in the *pupa* stage breaks into transverse rings, usually five in number. The pre-oral region becomes large.

Asteroids.—Nearest the *Auricularia* is the larva of starfishes, which has the same enlarged pre-oral region. There are *two* ciliated bands, of which the ad-oral is smaller, the ad-anal much larger. They are extended peripherally by the development of soft bilateral arms, and such a larva is known as a *Bipinnaria*. But another larval form in Asteroids is the *Brachiolaria* stage, in which three warty arms are formed at the anterior dorsal end, independently of the ciliated bands.

Ophiuroids and *Echinoids.*—In the *Pluteus* larvæ (Fig. 131) characteristic of these classes the pre-oral region remains small, while the post-anal region becomes large. There is one undulating ciliated band, the course of which is much modified by the growth of six long arms, with temporary calcareous supports. This quaint form is often compared to a six-legged easel.

The development of these larval forms into the adult is very intricate. The adult is a new formation within the larva, retaining the water-vascular system and mid-gut, but absorbing or rejecting the provisional larval structures. As certain parts are broken down, others are built up, chiefly through the agency of the wandering amoeboid cells of the mesenchyme. The first steps in the upbuilding of the adult, and especially of its skeleton, are to some extent parallel in the five classes.

One of the most important changes is that from bilateral to radial symmetry. In connection with this, it has been conjectured that the primitive ancestor was bilaterally symmetrical, and that the radiate symmetry was acquired by early sessile or sedentary Echinoderms, such as the Cystoids. As we have already seen, the adults in the different classes tend to acquire an independent and secondary bilateral symmetry.

It is very difficult to compare the Echinoderm larvæ, even in their simplest form, with those of other animals. The nearest type is perhaps the Tornaria of *Balanoglossus*, but it again is very unique. One naturally tries to compare the Echinoderm larva with the Trochosphere of Annelids, but the differences are very marked. One of the most marked of these is the absence of the apical sense organ, so characteristic of the Trochosphere. The fact that this is represented in the larva of *Antedon* is regarded by many naturalists as a point of much importance.

RELATIONSHIPS OF ECHINODERMA

The Echinoderms form an exceedingly well-defined phylum, but the Holothurians especially show how many of the significant characters may be lost. In that class we see how the power of forming a calcareous skeleton, the characteristic tube-feet, and the greater part of

the peculiar water-vascular system, may all disappear ; it is conceivable that further modification of the same kind might eliminate all the distinctively Echinoderm characters, and produce an organism whose systematic position would be very difficult to determine. This is important, because, as we have already seen, there are many "worm-like" types of whose affinities we know nothing. That some of these are related to Echinoderms has been often suggested.

It is conceivable that Holothurians of the worm-like *Synapta* type are nearest the primitive stock of Echinoderma. But there are strong arguments in favour of the view that the free forms, the Eleutherozoa, have been derived from attached Pelmatozoic ancestors. The extinct Edrioasteroidea are in some ways intermediate between the Cystidea and the Eleutherozoa.

CHAPTER XIII

PHYLUM ARTHROPODA

Chief Classes—CRUSTACEA, PROTOTRACHEATA, MYRIOPODA,
INSECTA, ARACHNOIDEA, PALÆOSTRACA

MORE than half the known species of animals are included in the Arthropod phylum, for of insects alone there are said to be more species than of all other animals taken together.

The Arthropods are in some ways like Annelids—in the bilateral symmetry; in the division of the body into successive segments, some or all of which bear appendages; in the plan of the nervous system; and so on. Furthermore, *Peripatus*, which has air-tubes or tracheæ somewhat similar to those of Myriopods and Insects, has nephridia like those of some Annelids; and the biramosse appendages of a simple Crustacean like *Apus* may be compared with the parapodia of an Annelid.

It is difficult to discern the relationships of the various classes included in the Arthropod phylum. Crustaceans, most of which are aquatic and breathe by gills, are often opposed to the Prototracheata, Myriopods, Insects, and Arachnoids, most of which are terrestrial or aerial, and breathe by tracheæ, or possible modifications of these. Three divergent groups—the King-crabs (*Limulus*), and the extinct Eurypterids and Trilobites—may be conveniently referred to a separate class—Palæostraca.

General Characteristics of Arthropods (to which primitive, parasitic, and degenerate forms present exceptions)

The body is bilaterally symmetrical, and consists of numerous segments variously grouped. Several or all of the segments

bear paired jointed appendages variously modified. The cuticle is chitinous. Ciliated epithelium is almost always absent. The dorsal brain is connected by a ring round the gullet with a double chain of ventral ganglia. Above the food canal lies the heart. The true or primitive cœlom is always small in the adult; the apparent body cavity is of secondary origin, and has in a great part a blood-carrying or vascular function. The sexes are almost always separate, the reproductive organs and ducts are usually paired. There is often some metamorphosis in the course of development. In habit the Arthropods are predominantly active.

Class CRUSTACEA

General Characteristics of Crustaceans (to which primitive, parasitic, and degenerate forms offer exceptions)

With few exceptions, e.g. land-crabs, wood-lice, and sand-hoppers, Crustaceans live in water. They breathe by gills or cutaneously. The head carries two pairs of antennæ in addition to other appendages, e.g. at least three pairs of jaws; the thorax, sometimes distinct from, and sometimes fused to the head, bears various kinds of limbs; the abdomen is usually segmented, and often has appendages. The typical appendage consists of two branches and a basal portion, to which gills may be attached. To the chitin of the cuticle, carbonate of lime is added.

A Type of CRUSTACEA. The fresh-water Crayfish (*Astacus fluviatilis*)

(Most of the following description will apply also to the Lobster (*Homarus*), to the Rock Lobster (*Palimurus*), and to the Norway Lobster (*Nephrops norvegicus*), often called a crayfish.)

Mode of life.—The fresh-water crayfish lives in streams, and burrows in the banks. It is not found in Scotland, but occurs here and there in England and Ireland, and is common on the Continent. It is not found in districts where the water contains little lime. The food is very varied—from roots to water-rats; cannibalism also occurs. The animals swim backwards by powerful tail strokes, or

creep forwards on their "walking legs." Their life is tolerably secure, but the frequent moultings during adolescence are expensive and hazardous. When hatched the young are like miniature adults; for a time they cling beneath the tail of the mother.

External appearance.—The head and thorax are covered by a continuous (cephalothoracic) shield; the abdomen shows obviously distinct segments movable upon one another. As indicated by the appendages, there are three groups of segments or metameres—five in the head, eight in the thorax, six in the abdomen, as well as an unpaired piece or telson on which the food canal ends. Each of the nineteen segments bears a pair of appendages. Among other external characters may be noticed the stalked movable eyes, the two pairs of feelers, the mouth with six pairs of appendages crowded round it, and the gills under the side flaps of the thorax.

- | | | |
|-------------------------------|---|--|
| The BODY WALL
consists of— | { | <p>(1) The external shell or cuticle, composed of various strata of chitin, coloured with pigments, hardened with lime salts;</p> <p>(2) The ectoderm, epidermis, or hypodermis, which makes and remakes the cuticle;</p> <p>(3) An internal connective tissue layer or dermis, with pigment, blood vessels, and nerves. Internal to this lie the muscles.</p> |
|-------------------------------|---|--|

Between the rings and at the joints the cuticle contains no lime, and is therefore pliable. It is a layer not in itself living or cellular, made by the underlying living skin. As it cannot expand, it has to be moulted periodically as long as the animal continues to grow. The old husk becomes thinner, a new one is formed beneath it, a split occurs across the back just behind the shield, the animal withdraws its cephalothorax and then its abdomen, and an empty but complete shell is left behind. The moulting is preceded by an accumulation of glycogen in the tissues, and this is probably utilised in the rapid growth which intervenes between the casting of the old and the hardening of the new shell.

How thorough the ecdysis or cuticle-casting is, may be appreciated from the fact that the covering of the eyes, the hairs of the ears, the lining of the fore-gut and hind-gut, the gastric mill, and the tendinous

inward prolongations of the cuticle to which some of the muscles are attached, are all got rid of and renewed. The moults occur in the warm months, eight times in the first year, five times in the second, thrice in the third, after which the male moults twice, the female once a year, till the uncertain limit of growth is reached. It is not clearly known in what form the animals procure the carbonate of lime which is deposited in the chitinous cuticle, but Irvine's experiments have shown that a carbonate of lime shell could be formed by crabs even when the slight quantity of carbonate of lime in sea-water was replaced by the chloride. Moulting is an expensive and exhausting process, and great mortality is associated with the process itself or with the defenceless state which follows. It is the necessary tax attendant on the advantage of armature. Inequalities in the legs are usually due to losses sustained in combat, but these are gradually repaired by new growth.

The surface of the body bears setæ or bristles of various kinds. These have their roots in the epidermis, and are made anew at each moult. There are simple glands beneath the gill-flaps, and on the abdomen of the female there are cement glands, the viscid secretion of which serves to attach the eggs.

Appendages.—The limbs of a Crustacean usually exhibit considerable diversity; in different regions of the body they are adapted for different work; yet all have the same typical structure, and begin to develop in the same way. In other words, they are serially *homologous organs*, illustrating division of labour. Typically each consists of a basal piece or *protopodite*, and two jointed branches rising from this—an internal *endopodite* and an external *exopodite*; but in many the outer branch disappears.

The protopodite has usually two joints—a basal or proximal coxopodite, and a distal basipodite; the five joints which the endopodite frequently exhibits are named from below upwards—ischio-, mero-, carpo-, pro-, dactylo-podites—details of some use in the comparison and identification of species.

The stalked eyes are not included in the above list, since their development is not like that of the other appendages; but cases where an excised eye has been replaced by an antenniform structure suggest that the eye-stalk may be of the nature of an appendage.

With many of the thoracic appendages, gills, plate-like epipodites, and setæ are associated.

It is interesting to connect the structure of the appendages with their functions. Thus it may be seen that the great paddles are fully spread when the crayfish drives itself backwards with a stroke of its tail, while in straightening again the paddles are drawn inwards, and the outer joint of the exopodite bends in such a way that the friction is reduced.

THE APPENDAGES OF THE CRAYFISH

	No.	NAME.	FUNCTION.	STRUCTURE.
Head (5).	1	Antennules (pre-oral?).	Tactile, olfactory, with ear-sac at base.	Two branches, but probably not homologous with endopodite and exopodite.
	2	Antennæ (pre-oral?).	Tactile, opening of kidney at base.	Small exopodite.
	3	Mandibles.	Masticatory.	Four joints, of which three form the palp (endopodite and upper joint of protopodite).
	4	1st Maxillæ.	?	Thin single-jointed protopodite, small endopodite, no exopodite.
	5	2nd Maxillæ.	Produces respiratory current.	Thin protopodite, filamentous endopodite; the "baler" is formed from the epipodite, probably along with the exopodite.
Thorax (8).	6	1st Maxillipedes (foot-jaws).	?	Thin protopodite, small endopodite, large exopodite.
	7	2nd Maxillipedes.	?	Two-jointed protopodite, five-jointed endopodite, long exopodite.
	8	3rd Maxillipedes.	Masticatory.	Two-jointed protopodite, large five-jointed endopodite with strong teeth on its ischiopodite, slender exopodite.
	9	Forceps (chelate).	Fighting, seizing.	No exopodite. In the claw the last joint bites against a prolongation of the second last.
	10	Walking Legs (chelate).	Walking.	..
	11	" "	Genital opening in female.	Without chelæ.
	12	" "	..	"
	13	" "	Genital opening in male.	"
	Abdomen (6).	14	Modified swimmerets in male; in female, rudimentary.	{ Serve in the male as canals for the seminal fluid.
15		Modified swimmerets in male, normal in female.	..	All the three parts.
16		Swimmerets.	{ Move slightly like oars, and carry the eggs in the female.	"
17		" "	..	"
18		" "	..	"
19		Great paddles.	Important in swimming.	"

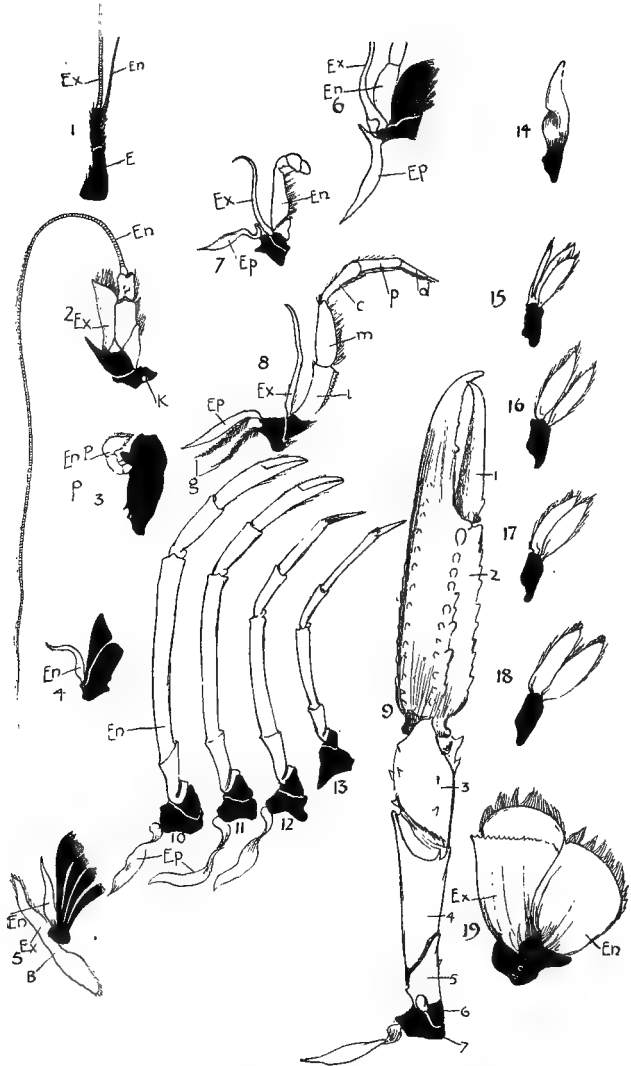

FIG. 142.—Appendages of Norway lobster.

Ex., Exopodite; *En.*, endopodite; protopodite dark throughout; *Ep.*, epipodite. 1. Antennule—*E.*, position of ear; 2. antenna—*K.*, opening of kidney; 3. mandible—*P.*, palp; 4. first maxilla; 5. second maxilla—*B.*, baler; 6. first maxillipede; 7. second maxillipede; 8. third maxillipede—the basal joint of the protopodite is called coxopodite, the next basipodite; the five joints of the endopodite are called—ischiopodite (*i.*); meropodite (*m.*); carpopodite (*c.*); propodite (*p.*); dactylopodite (*d.*); 9. forceps—(7) coxopodite; (6) basipodite, the joints of the endopodite are numbered; 10–13. walking legs; 14. modified male appendage; 15–18. small swimmerets; 19. large paddles.

It is likely that some of the crowded mouth-parts, *e.g.* the first maxillæ, are almost functionless. The hard toothed knob which forms the greater part of the mandible is obviously well adapted to its crushing work.

In connection with the skeleton, the student should also notice the beak (*rostrum*) projecting between the eyes; the triangular area (*epistoma*) in front of the mouth, and the slight upper and lower lips; and the lateral flaps of the body wall which project the gills. Each posterior segment consists of a dorsal arch (*tergum*), side flaps (*pleura*), a ventral bar (*sternum*), while the little piece between the *pleuron* and the socket of the limb is dignified by the name of *epimeron*. The hindmost piece (*telson*), on which the food canal ends ventrally, is regarded by some as a distinct segment. The most difficult fact to understand clearly, is that the cuticle of certain appendages (*e.g.* the mandibles), and of the ventral region of the thorax, is folded inwards, forming chitinous "tendons" or insertions for muscles, and, above all, constituting the complex, apparently, but not really, internal, "endophragmal" skeleton of the thorax, protecting the ventral nerve-cord and venous blood sinus.

Muscular system.—The muscles are white bundles of fibres, which on minute examination show clearly that transverse striping which is always well marked in rapidly contracting elements. The muscles are inserted on the inner surface of the cuticle, or on its internal foldings (*apodemata*). The most important sets are—(1) the dorsal extensors or straighteners of the tail; (2) the twisted ventral muscles, most of which are flexors or benders of the tail, which have harder work, and are much larger than their opponents; (3) those moving the appendages; (4) the bands which work the gastric mill.

Nervous system.—The supra-oesophageal nerve-centres or ganglia, forming the brain, have been shunted far forward by the growth of the pre-oral region. We thus understand how the nerve-ring round the gullet, connecting the brain with the ventral chain of twelve paired ganglia, is so wide.

The dorsal or supra-oesophageal ganglia are three-lobed, and give off nerves to eyes, antennules, antennæ, and food canal, besides the commissures to the sub-oesophageal centres. They act as a true brain.

The sub-oesophageal ganglia, the first and largest of the ventral dozen, innervate the six pairs of appendages about the mouth. There are other five ganglia in the thorax, and six more in the abdomen.

Though the ganglia of each pair are in contact, the

ventral chain is double, and at one place, between the fourth and fifth ganglia, an artery (sternal) passes between the two halves of the cord. From each pair of ganglia nerves are given off to appendages and muscles, and apart from the brain these minor centres are able to control the individual movements of the limbs. In the thoracic region the cord is well protected by the cuticular archway already referred to.

From the brain, and from the commissure between it and the sub-oesophageal ganglia, nerves are given off to the food canal, forming a complex visceral or stomato-gastric system. Similarly, from the last ganglia of the ventral chain, nerves go to the hind-gut. If the brain be regarded as the fusion of two pairs of ganglia, as the development suggests, and the sub-oesophageal as composed of six fused pairs, then these, along with the eleven other pairs of the ventral chain, give a total of nineteen nerve-centres, — a pair for each pair of appendages.

Sensory system.—A skin clothed with chitin is not likely to be in itself very sensitive, but some of the setæ are, and some observers describe a peripheral plexus of nerve-cells beneath the epidermis. The setæ are not mere outgrowths of the cuticle, but are continuous with the living epidermis beneath; and though some are only fringes, both experiment and histological examination show that others are *tactile*.

On the under surface of the outer fork of the antennules there are special innervated setæ, which have a *smelling* function.

Other specialised setæ have sunk into a sac at the base of the antennules, and are spoken of as *auditory*. The sac

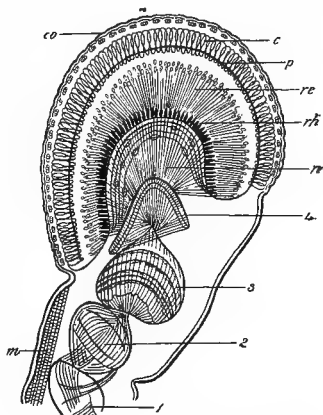

FIG. 143.—Section of compound eye of *Mysis vulgaris*.—After Grenacher.

m., Muscle of eye-stalk; 1-4 ganglionic swellings in the course of the optic nerve; *n.*, the nerve fibrils passing up to the retinulæ; *rh.*, the rhabdoms; *re.*, elements of retinulæ; *p.*, band of pigment; *c.*, crystalline cones; *co.*, the corneal facets with the subjacent nuclei.

opens by a bristle-guarded slit on the inner upper corner of the expanded basal joint, and contains a gelatinous fluid and small "otoliths," which appear to be foreign particles. This "ear" seems to be an equilibrating organ, connected with directing the animal's movements. In some other Crustaceans the auditory hairs are lodged in an open depression; this has become an open sac in the crayfish, a closed bag in the crab. Small setæ on the upper lip of the mouth have been said to have a tasting function.

The stalked eyes, which used to be regarded as appendages, arise in development from what are called "procephalic lobes" on the head. They are compound eyes—that is, they consist of a multitude of elements, each of which is structurally complete in itself. On the outside there is a cuticular cornea, divided into square facets, one for each of the optic elements; beneath this lie, as in other parts of the body, the nucleated epidermal cells. Then follows a focussing layer, consisting of many crystalline cones. Each crystalline cone is composed of four crystalline cells, which taper internally, and externally secrete a firm crystalline body. The bases of the crystalline cones are surrounded by the retinula cells. Each retinula consists of five elongated cells arranged about a central axis. Distally, this axis is formed by the crystalline cone, proximally by a little rod or rhabdom. The rhabdom consists of four little red rods closely apposed together, and connected by a nerve-fibre with the optic ganglion, which lies at the end of the optic nerve. The proximal ends of the retinal cells are deeply pigmented. Thus each element consists of corneal facet, crystalline cone, and retinula, and the retinula consists of internal rhabdom and external retinula cells. Between the individual optic elements lie some pigment cells. The retinule image is erect, not inverted as in the eyes of Vertebrates.

Alimentary system.—The food canal consists of three distinct parts—a fore-gut or stomodæum developed by an intucking from the anterior end of the embryo, a hind-gut or proctodæum similarly invaginated from the posterior end, and a mid-gut or mesenteron, which represents the original cavity of the gastrula.

The mouth has been shunted backwards from the anterior

end of the body, so that the antennules and antennæ lie far in front of it. The fore-gut, which is lined by a chitinous cuticle, includes a short "gullet," on the walls of which there are small glands, hypothetically called "salivary," and a capacious gizzard, which is distinctly divided into two regions.

In the anterior (cardiac) region there is a complex mill; in the posterior (pyloric) region there is a sieve of numerous hairs. The mill

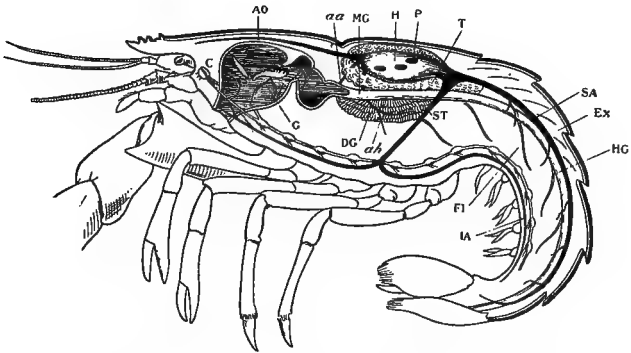

FIG. 144.—Longitudinal section of lobster, showing some of the organs.

H., Heart; *AO.*, ophthalmic artery; *aa.*, antennary artery; *ah.*, hepatic artery; *ST.*, sternal artery; *SA.*, superior abdominal artery; *MG.*, mid-gut; *DG.*, digestive gland; *HG.*, hind-gut; *Ex.*, extensor muscles of the tail; *Fl.*, flexor muscles of the tail; *IA.*, inferior abdominal artery; *G.*, gizzard; *C.*, cerebral ganglia; *P.*, pericardium; *T.*, testes.

is very complex; there are supporting "ossicles" on the walls with external muscles attached to them, and internally projecting teeth which clash together and grind the food. Three of the teeth are conspicuous; a median dorsal tooth is brought into contact with two large laterals. On each side of the anterior part of the gizzard there are two limy discs or gastroliths, which are broken up before moulting, and though quite inadequate to supply sufficient carbonate of lime for the new skeleton, seem to have some relation to this process. The occurrence of chitinous cuticle, setæ, teeth, and gastroliths in the gizzard, is intelligible when the origin of the fore-gut is remembered, and so is the dismantled state of this region when moulting occurs.

The mid-gut is very short, but outgrowths from it form

the large and complex digestive gland. The mid-gut, here as always, is the digestive and absorptive region, but both processes are carried on to a large extent in the digestive gland, which communicates with the mid-gut by two wide ducts. It is roughly three-lobed at both sides, and consists of an aggregated mass of cæca, closely compacted together. The gland is more than a "liver," more even than a "hepatopancreas." It absorbs peptones and sugar; like the Vertebrate liver, it makes glycogen; its digestive juices are comparable to those of the pancreas and the stomach of higher animals. The hind-gut is long and straight. It is lined by a chitinous cuticle, as its origin suggests. There are a few minute glands on its walls.

Body cavity.—The space between the gut and the body wall is for the most part filled up by the muscles and the organs, but there are interspaces left which contain a fluid with amœboid cells. These interspaces seem to represent enlarged blood sinuses (a hæmocœle), rather than a true body cavity or cœlom. One of the spaces forms the blood-containing pericardium, or chamber in which the heart lies.

Vascular system.—Within this non-muscular pericardium, and moored to it by thin muscular strands, lies the six-sided heart, which receives pure blood from the gills (*via* the pericardium) and drives it to the body.

The arterial system is well developed. Anteriorly, the heart gives off a median (ophthalmic) artery to the eyes and antennules, a pair of (antennary) arteries to the antennæ, and a pair to the digestive gland (hepatic). Posteriorly there issues a single vessel, which at once divides into a superior abdominal, running along the dorsal surface, and a sternal, which goes vertically through the body. This sternal passes between the connectives joining the fourth and fifth ventral ganglia, and then divides into an anterior and posterior abdominal branch. All these arteries are continued into capillaries.

From the tissues the venous blood is gathered up in channels, which are not sufficiently defined to be called veins. It is collected in a ventral venous sinus, and passes into the gills. Thence, purified by exposure on the water-washed surfaces, it returns by six vessels on each side to the pericardium. From this it enters the heart by six large and

several smaller apertures, which admit of entrance but not of exit.

The blood contains amœboid cells, and the fluid or plasma includes a respiratory pigment, hæmocyacin (bluish when oxidised, colourless when deoxidised), and a lipochrome pigment, called zoonerythrin. Both of these are common in other Crustaceans.

Respiratory system.—Twenty gills—vascular outgrowths of the body wall—lie on each side of the thorax, sheltered by the flaps of the shield. A current of water from behind forwards is kept up by the activity of the baling portion, or scaphognathite, of the second maxilla. Venous blood enters the gills from the ventral sinus, and purified blood leaves them by the six channels leading to the pericardium.

Observed superficially, the gills look somewhat like feathers with plump barbs, but their structure is much more complex. The most important fact is that they present a large surface to the purifying water, while both the stem and the filaments which spring from it contain an outer canal continuous with the venous sinus, and an inner canal communicating with the channels which lead back to the pericardium and heart.

Three sets of gills are distinguishable. To the basal joints of the six appendages, from the second maxillipede to the fourth large limb inclusive, the *podobranchs* are attached. They come off with the appendages when these are pulled carefully away, and each of them bears, in addition to the feathery portion, a simple lamina or *epipodite*. The membranes between the basal joints of the appendages and the body, from the second maxillipede to the fourth large limb inclusive, bear a second set, the *arthrobranchs*, which have no epipodites. In connection with the second maxillipede there is a single arthrobranch; in connection with each of the five following appendages there are two; so that there are eleven arthrobranchs altogether. There remain three *pleurobranchs*, one on the epimeron of the fifth large limb, and two others quite rudimentary on the two preceding segments. The bases of the *podobranchs* bear long setæ.

In *Nephrops*, the *podobranchs* are represented by a small rudiment on the second maxillipede, and by five well-developed gills on the next five appendages; there are eleven arthrobranchs, the most anterior being small; and there are four large *pleurobranchs*.

Excretory system.—A kidney or “green gland” lies behind the base of each antenna, and its opening is marked by a conspicuous knob on the basal joint of that appendage.

Each kidney consists of a dorsal sac communicating with the exterior, and of a ventral coiled tube which forms the proper renal organ. The latter is supplied with blood from the antennary and abdominal arteries, and forms as waste products uric acid and greenish guanin. Each kidney may be regarded as homologous with a nephridium.



FIG. 145.—Male reproductive organs of crayfish.—After Huxley.

t., Testes; *vd.*, vas deferens; *vd.*, opening of vas deferens on last walking leg.

The crayfish has also, near the gills, small branchial glands which excrete carcinuric acid from the blood, and also help in phagocytosis, that important process in which wandering amoeboid cells resist infection and help to repair injuries (cf. possible function of thymus in Fishes). In not a few invertebrates there are scattered groups of excretory cells or nephrocytes, and it seems that the endothelial cells of the lymphatic vessels and renal capillaries in tadpoles have a similar function.

Reproductive organs.—

The male crayfish is distinguished from the female by his slightly slimmer build, and by the peculiar modification of the first two pairs of abdominal appendages.

In both sexes the gonads

are three-lobed, and communicate with the exterior by paired ducts.

The testes consist of two anterior lobes lying beneath and in front of the heart, and of a median lobe extending backwards. Each lobe consists of many tubules, within which the spermatozoa develop. From the junction of each of the anterior lobes with the median lobe, a genital duct or vas deferens is given off. This has a long coiled course, is in part glandular, and ends in a short muscular portion opening on the last thoracic limb. The spermatozoa are at first disc-like cells; they give off on all sides long pointed processes like those of a Heliozoon, and remain very sluggish. The seminal fluid is milky in appearance,

and becomes thicker in its passage through the genital ducts. It is possible that the genital ducts represent modified nephridia, and that the cavities of the gonads are coelomic.

The ovaries are like the testes, but more compact. The eggs are liberated into the cavity of the organ, and pass out by short thick oviducts opening on the second pair of walking legs. As they are laid they seem to be coated with the secretion of the cement glands of the abdomen, and the mother keeps her tail bent till the eggs are glued to the small swimmerets.

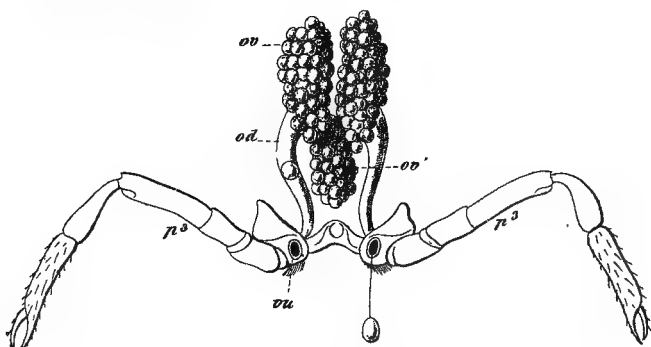

FIG. 146.—Female reproductive organs of crayfish.—
After Suckow.

ov., Ovaries; ov', fused posterior part; od., oviduct; vu., female aperture on the second walking leg.

Before this, however, sexual union has occurred. The male seizes the female with his great claws, throws her on her back, and deposits the seminal fluid on the ventral surface of the abdomen. The fluid flows down the canal formed by his first abdominal appendages, and these seem to be kept clear by the movements of the next pair, which are also modified. On the abdomen of the female the agglutinated spermatozoa doubtless remain until the eggs are laid, when fertilisation in the strict sense is achieved.

The *Development* has been very fully worked out, and is of interest in being direct, without the metamorphosis so common among the

Arthropoda. The spherical ovum is surrounded by a cuticular vitelline membrane, and contains a considerable quantity of yolk. After fertilisation the segmentation nucleus divides in the usual way into two, four, eight, and so on, but this nuclear division is not followed by division of the plasma. Eventually the nuclei, each surrounded by a small amount of protoplasm, approach the surface of the egg and arrange themselves regularly round it. The peripheral protoplasm then segments round these nuclei, and thus we have a central core of unsegmented yolk enveloped by a peripheral sphere of rapidly dividing

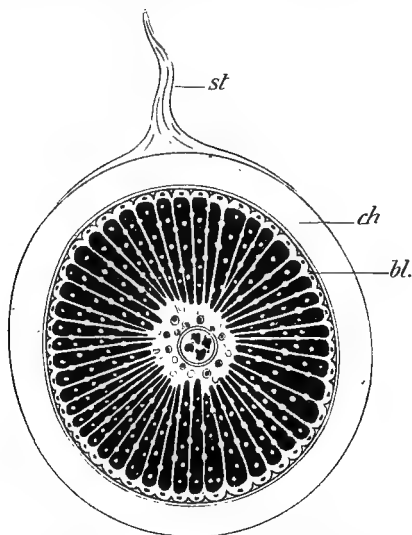

FIG. 147.—Section through the egg of *Astacus* after the completion of segmentation.—After Reichenbach.

st., Stalk of the egg; *ch.*, chorion envelope; *bl.*, peripheral blastoderm within which are the yolk pyramids (dark).

cells. In the central yolk, free nuclei are frequently found; these are the so-called yolk nuclei. Such a type of segmentation is called peripheral or centrolecithal, and is very characteristic of Arthropod eggs.

Over a particular region of the segmented egg, known as the "ventral plate," the cells begin to thicken; at this region an invagination occurs, which represents the gastrula. At the anterior lip of the blastopore the mesoderm appears, being many-celled from the first. Soon the blastopore closes; the cavity of the gastrula thus becomes a closed sac—the future mid-gut. The cells of this archenteron take up the core of yolk

into themselves in a way which early suggests their future digestive function. On the surface of the egg there have already appeared ectodermic thickenings,—the so-called eye-folds,—rudiments of the appendages, and of the thoracic and abdominal regions.

In the later stages invaginations of the ectoderm form the fore- and hind-gut, which grow inward from opposite ends to meet the endodermic mid-gut. The ear-sac and the greater part of the gills have also an ectodermic origin. From the mid-gut the digestive gland is budded out. The heart, the blood vessels, blood, and muscles are due to the mesoderm.

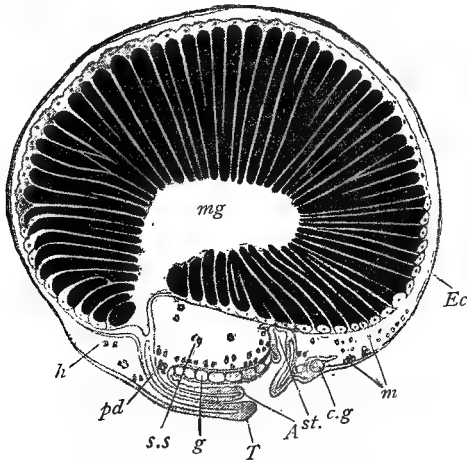

FIG. 148.—Longitudinal section of later embryo of *Astacus*.—After Reichenbach.

Ec., Ectoderm; *m.*, mesoderm cells; *c.g.*, cerebral ganglia; *st.*, stomodæum; *A.*, anus; *T.*, telson; *g.*, ventral ganglia; *s.s.*, sternal sinus; *pd.*, proctodæum; *h.*, heart; *mg.*, mid-gut; yolk pyramids dark.

As usual, the nervous system arises from an ectodermic thickening. The eye arises partly from the optic ganglia of the "brain," partly from the "eye-folds," and partly from the epidermis.

When the young crayfishes are hatched from the egg-shells, they still cling to these, and thereby to the swimmerets of the mother. In most respects they are like the adults, but the cephalothorax is convex and relatively large, the rostrum is bent down between the eyes, the tips of the claws are incurved and serve for firm attachment, and there are other slight differences. The noteworthy fact is that the development is completed within the egg-case, and that it is continuous without metamorphosis. The shortened life history of the crayfish is interesting

in relation to its fresh-water habitat, where the risks of being swept away by currents are obviously great; but it must also be remembered that the tendency to abbreviate development is a general one. There is some maternal care in the crayfish, for the young are said sometimes to return to the mother after a short exploration on their own account.

THE CRAB

It is instructive to contrast the crab-type with that of the crayfish or lobster. The cephalothorax is broadened by a hollow extension of the gill-covering (branchiostegite) region. The abdomen is greatly reduced, with a soft sternal region, and is bent permanently upwards and forwards in a groove in the thoracic sternum. In the male there are only two pairs of abdominal limbs, which have a reproductive function; in the female there are four pairs, which carry the eggs.

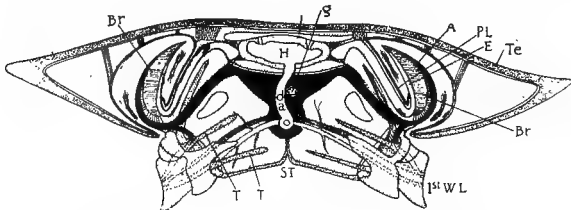

FIG. 149.—Section through cephalothorax of a crab.—
After Pearson.

H., Heart; *Te.*, extension of the tergum; *ST.*, sternum; *PL.*, pleuron; *T.*, tendons; *1st W.L.*, insertion of first walking leg; *Br.*, gill in gill-chamber; *g.*, gut; *d.a.*, descending artery; *A.*, afferent branchial; *E.*, efferent branchial.

The eye-stalks lie in sockets of the carapace; the bases of the reflexed antennules are also in sockets; the antennæ are short and straight.

The third maxillipedes are broad and flat and form a kind of operculum over the five preceding pairs of appendages. The great claws are relatively very large, the other thoracic legs are non-chelate, and in the swimming crabs, *e.g.* *Portunus* (see Fig. 150), the fifth pair of thoracic legs have their last joint adapted as a paddle.

As to the soft parts, there is a noteworthy change in the nervous system. From the cerebral ganglia a pair of œsophageal commissures extend to a large ganglionated mass sheltered by the endosternal skeleton. It is composed of numerous pairs of ganglia fused together, and gives off nerves to maxillæ, maxillipedes, and thoracic limbs. It is perforated by the sternal artery. The œsophageal commissures are united by a transverse commissure just behind the gullet, and in front of this cross junction there are two small ganglia giving off nerves to the mandibles. On the lower surface of the anterior part of the gizzard there are two small gastric ganglia innervated from the cerebrals.

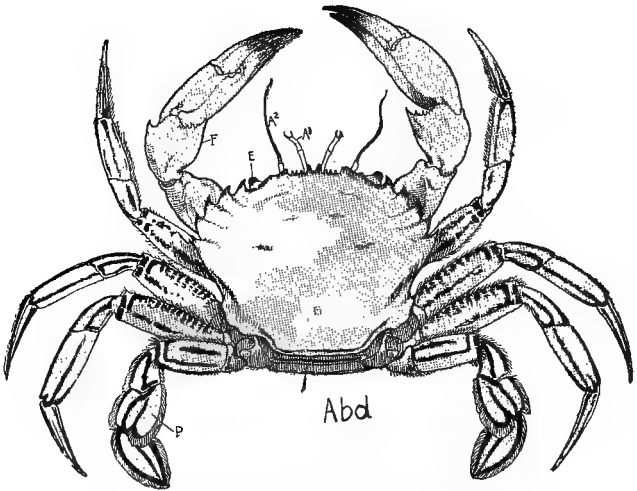

FIG. 150.—Dorsal aspect of swimming crab (*Portunus*).
P., Paddle; *Abd.*, abdomen; *A*¹, antennules; *A*², antennæ; *E.*, eyes; *F.*, forceps

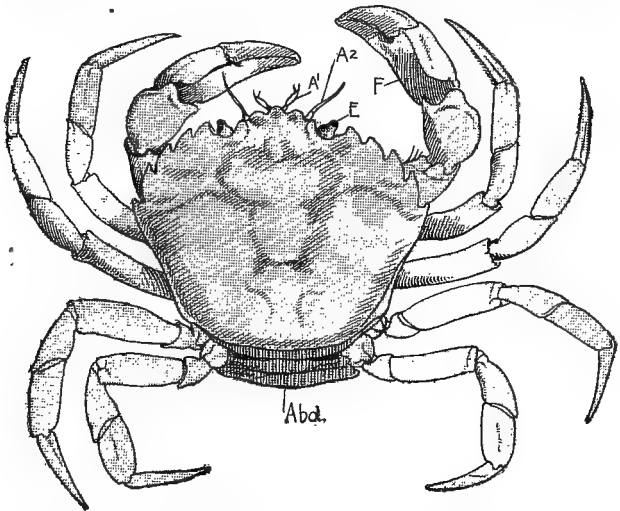

FIG. 151.—Dorsal aspect of shore crab (*Carcinus*).
Abd., Abdomen; *A*¹, antennules; *A*², antennæ; *E.*, eyes; *F.*, forceps.

When the branchial chamber is opened the large pyramidal gills are seen, also the long sword-shaped epipodite (flabellum) of the first maxillipede which seems to help the "baler," the smaller and mobile epipodites borne by the second and third maxillipedes, and the broad

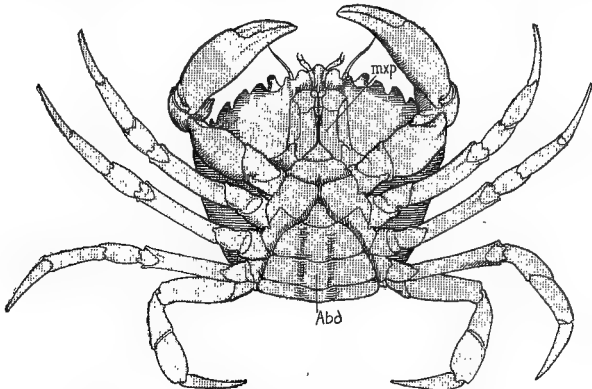

FIG. 152.—Ventral aspect of female shore crab.

Abd., Abdomen; *mxp.*, third maxillipede.

scaphognathite of the second maxilla which bales the water forwards and outwards.

It must be clearly understood that the branchial chamber is entirely outside of the body, being formed by the lateral extension of a hollow reduplication from the tergal region.

The large gizzard, the enormous greyish-yellow hepatopancreas, the transparent pericardium, and other organs are readily seen.

SYSTEMATIC SURVEY OF THE CLASS CRUSTACEA .

(1) Entomostraca, lower forms. They are usually small and simple.

The number of segments and appendages is very diverse.

The larva is generally hatched as a simple unsegmented *Nauplius*.

There is no gastric mill.

The excretory organ is associated with the second maxillæ.

(2) Malacostraca, higher forms.

They are usually larger and more complex.

The head consists of 5, the thorax of 8, the abdomen of 6 (7 in Leptostraca) segments.

The larva is usually higher than a *Nauplius*.

There is often a gastric mill.

The excretory organ is usually associated with the antennæ, but maxillary glands may be present in the larvæ, and may even persist in adults.

First Sub-Class. ENTOMOSTRACA

Order 1. Phyllopora. — In these at least four pairs of leaf-like swimming feet bear respiratory plates. The body is generally well segmented, and is protected by a shield-like or bivalve shell. The mandibles are without palps, and the maxillæ are rudimentary.

(a) Branchiopoda. The body has numerous segments and (10-20 or more) foliaceous appendages with respiratory plates. The shell is rarely absent, usually shield-like or bivalved. The heart is a long dorsal vessel with numerous openings. The eggs are able to survive prolonged desiccation in the mud.

Branchipus, a beautifully coloured fresh-water form, with hardly any shell.

Artemia. Brine-shrimps. Periodically parthenogenetic. By gradually changing the salinity of the water, Schmanke-witsch was able, in the course of several generations, to modify *A. salina* into *A. milhausenii*, and *vice versa*. *Artemia fertilis* is one of the four animals known to occur in the dense waters of Salt Lake.

Apus, an archaic fresh-water form with a large dorsal shield.

Apus is over an inch in length, a giant among Entomostraca. It has an almost world-wide distribution. The appendages are very numerous and mostly leaf-like. They may be regarded as representing a primitive type of Crustacean limb. Professor Ray Lankester enumerates them as follows:—

- | | |
|-----------|---|
| Pre-oral. | { 1. Antenna.
2. Second antenna. (This is sometimes absent, and apparently always in certain species.) |
| Oral. | |

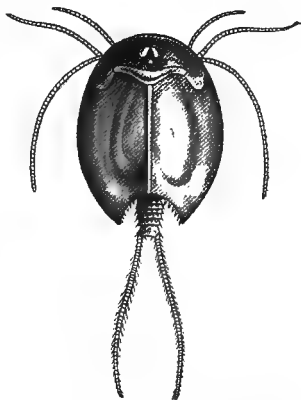

FIG. 153.—Dorsal surface of *Apus cancriformis*. — From Bronn's *Thierreich*.

In the anterior region are the two compound eyes, and behind them the simple unpaired eye. The whip-like outgrowths of the first thoracic appendage project laterally.

- Thoracic (Pregenital). { 6. First thoracic foot (leg-like).
7-16. Other ten thoracic feet (swimmers).
The 16th in the female carries an egg-sac or brood-chamber. There are eleven thoracic rings on the body.
- Abdominal (Post-genital). { 17-68. Fifty-two abdominal feet, to which there correspond only seventeen rings on the body.

The large dorsal shield is not attached to the segments behind the one bearing the maxillipedes. Many of the thin limbs doubtless function as gills. The genital apertures are on the sixteenth appendages. The anus is on the last segment of the body.

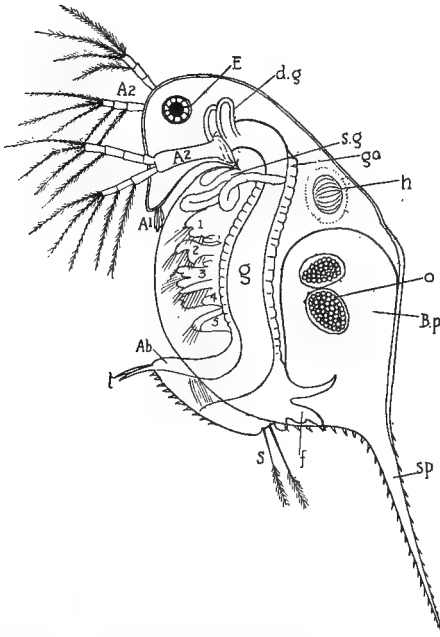

FIG. 154.—*Daphnia*.

E., Eye; *A.²*, second antenna; *A.¹*, first antenna; *dg.*, digestive caeca; *s.g.*, shell gland; *go.*, gonad; *h.*, heart in pericardium; *o.*, ovum; *B.p.*, brood-pouch; *sp.*, spine; *f.*, furca; *s.*, setae; *Ab.*, rudimentary abdomen; *t.*, caudal fork; *g.*, gut; *1-5*, thoracic limbs.

There is a pair of ventral ganglia to each pair of limbs; the ventral nerve-cords are widely apart; and the cephalic ganglion is remarkably isolated. There is periodic parthenogenesis.

- (b) Cladocera. Small laterally compressed "water-fleas," with few and somewhat indistinct segments. The shell is usually bivalved, and the head often projects freely from it. The second antennæ are large, two-branched, swimming appendages, and there are 4-6 pairs of other swimming organs. The heart is a little sac with one pair of openings. An excretory organ (the shell or maxillary gland) opens in the region of the second maxillæ. It is the Entomostrocan equivalent of the antennary green gland of Malacostraca. The males are usually smaller and much rarer than the females. The latter have a brood-chamber between the shell and the back. Within this many broods are hatched throughout the summer. Periodic parthenogenesis (of the "summer ova") is very common. "Winter eggs," which require fertilisation, are set adrift in a part of the shell modified to form a protective cradle or ephippium.

Daphnia, *Moina*, *Sida*, *Polyphemus*, *Leptodora*, and many other "water-fleas," are extraordinarily abundant in fresh water, and form part of the food of many fishes. A few occur in brackish and salt water.

In *Daphnia* the appendages are:—antennules, antennæ, mandibles, first maxillæ, second maxillæ (disappearing in the larva), and five thoracic limbs. The abdomen is turned downwards and forwards, and shows three segments and a telson.

Order 2. Ostracoda.—Small Crustaceans, usually laterally compressed, with an indistinctly segmented or unsegmented body, rudimentary abdomen, and bivalve shell. There are only seven pairs of antennules, antennæ, mandibles, first maxillæ, second maxillæ, and two pairs of thoracic limbs. Parthenogenesis is often prolonged.

Examples.—*Cypris* (fresh water), *Cypridina* (marine).

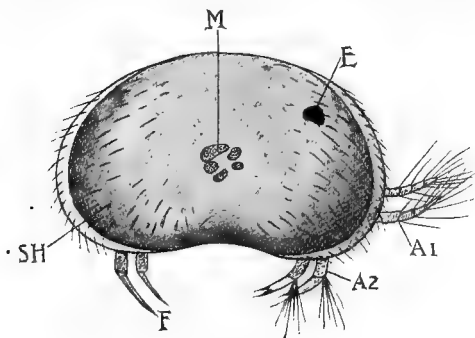

FIG. 155.—*Cypris*.

M., Marks of adductor muscle; *E.*, eye seen through the shell (*SH.*); *A.1.*, first antennæ; *A.2.*, second antennæ; *F.*, thoracic legs.

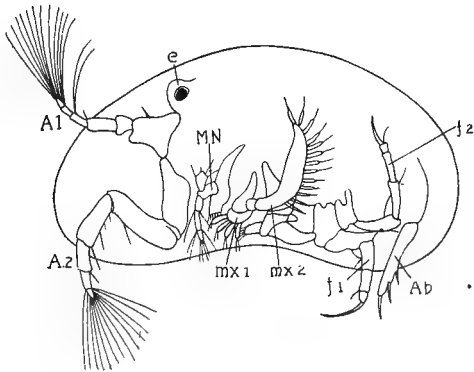

FIG. 156.—*Cypris*, side view, after removal of one valve.—
After Zenker.

e., Eye; *A.1*, first antennæ; *A.2*, second antennæ; *MN*, mandibles; *mx.1*, first maxilla; *mx.2*, second maxilla; *f.1*, *f.2*, thoracic legs; *Ab.*, rudimentary abdomen.

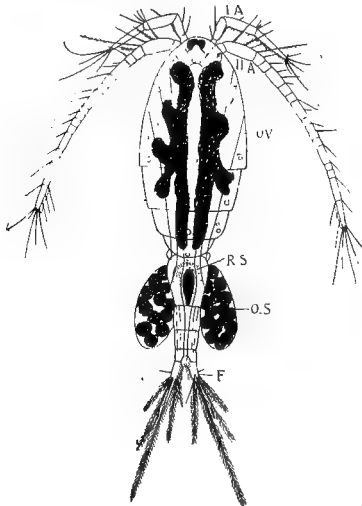

FIG. 157.—*Cyclops* type.

IA., first antenna; *IIA.*, second antenna; *OV.*, ovary; *RS.*, receptaculum seminis; *OS.*, ovisac; *F.*, caudal fork.

Order 3. Copepoda.—Elongated Crustaceans, usually with distinct segments. There is no dorsal shell. There are five pairs of biramous thoracic appendages, but the last may be rudimentary or absent. The abdomen is without limbs, and of its five segments the first two are sometimes united. The females carry the eggs in external ovisacs. Most Copepods move very actively in the water, jerking themselves rapidly by means of their thoracic legs, or swim more gently by means of their second antennæ. Many are ecto-parasitic, especially on fishes ("fish-lice"), and are often very degenerate. The free-living Copepods form an important part of the food-supply of fishes.

Cyclops, free and exceedingly prolific in fresh water. Its appendages are:—antennules, antennæ, mandibles, first maxillæ, second maxillæ, four pairs of flattened biramous thoracic legs united across the middle with those of the opposite side, another rudimentary pair, and probably the genital valve. *Cetochilus*, *Calanus*, free and abundant in the sea. In *Chondracanthus*, as in many other cases, the parasitic females carry the pigmy males attached to their body. *Caligus*, a very common genus of "fish-lice." In the carp-lice (*Argulus*) the mouth is a sucker with sharp stilets and the second maxillæ form adhesive discs.

Lernæa, *Penella*, etc. The adult females are parasitic, and almost worm-like. The males and the young are free.

Order 4. Cirripedia.—Barnacles and acorn-shells, and some allied degenerate parasites.

Marine Crustaceans, which in adult life are fixed head downwards. The body is indistinctly segmented, and is enveloped in a fold of skin, usually with calcareous plates. The anterior antennæ are involved in the attachment; the posterior pair are rudimentary. The oral appendages are small, and in part atrophied. In most there are six (or less frequently four) pairs of two-branched thoracic feet, which sweep food particles into the depressed mouth. The abdomen is rudimentary. There is no heart. The sexes are usually combined, but dimorphic unisexual forms also occur. The hermaphrodite individuals occasionally carry pigmy or "complemental" males. The spermatozoa are mobile, which is unusual among Crustacea.

Lepas, the ship-barnacle, is as an adult attached to floating logs and ship-bottoms. The anterior end by which the animal fixes itself is drawn out into a long flexible stalk, containing a cement gland, the ovaries, etc., and involving in its formation the first pair of antennæ and the front lobe of the head. The second antennæ are lost in larval life. The mouth region bears a pair of small mandibles and two pairs of small maxillæ,—the last pair united into a lower lip. The thorax has six pairs of two-branched appendages, and from the end of the rudimentary abdomen a long penis projects. At the base of this lies the anus. Around the body there is a fold of skin, and from this arise five calcareous plates, an unpaired dorsal *carina*, two *scuta* right and left

anteriorly, two *terga* at the free posterior end. The nervous system consists of a brain, an œsophageal ring, and a ventral chain of five or more ganglia. There is a fused pair of rudimentary eyes. No special circulatory or respiratory organs are known. Two excretory (?) tubes lead from (cœlomic) cavities to the base of the second maxillæ, and are probably comparable with shell glands and with nephridia. There is a complete food canal and a large digestive gland. Beside the latter lie the branched testes, whose vasa deferentia unite in an ejaculatory duct in the penis. From the much-branched ovaries in the stalk, the oviducts pass to the first thoracic legs, where they open into a cement-making sac, opening to the exterior. The eggs are found in flat cakes between the external fold of skin and the body.

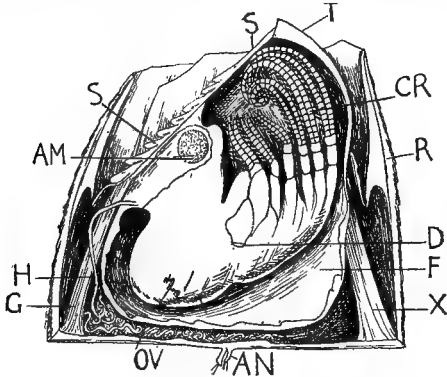

FIG. 158.—Acorn-shell (*Balanus tintinnabulum*).
—After Darwin.

T., tergum; *CR.*, thoracic legs; *R.*, outer shell in section; *D.*, aperture of oviduct; *F.*, mantle cavity; *X.*, depressor muscle of tergum; *AN.*, antennæ; *OV.*, ovary; *G.*, depressor of scutum; *H.*, oviduct; *AM.*, adductor muscle of scuta; *S.*, scutum.

The life history. Nauplius larvæ escape from the egg-cases, and, after moulting several times, become like little Cyprids. The first pair of appendages become sucktorial, and, after a period of free-swimming, the young barnacle settles down on some floating object, mooring itself by means of the antennary suckers, and becoming firmly glued by the secretion of the cement glands. During the settling and the associated metamorphosis, the young barnacle fasts, living on a store of fat previously accumulated. Many important changes occur, the valved shell is developed, and the adult form is gradually assumed.

The food consists of small animals, which are swept to the mouth by the waving of the curled legs. Growth is somewhat rapid, but the usual ecdysis is much restricted, except in one genus. Neither the valves, nor the uniting membranes, nor the envelope of the stalk, are

moulted, though disintegrated portions may be removed in flakes and renewed by fresh formations. In the allied genus *Scalpellum*, some are like *Lepas*, hermaphrodites, without complementary males (*Sc. balanoides*); others are hermaphrodite, with complementary males (*Sc. villosum*); and others are unisexual, but the males are minute and parasitic (*Sc. regium*).

Balanus, the acorn-shell, encrusts the rocks in great numbers between high and low water marks. It may be described, in Huxley's graphic words, as a crustacean fixed by its head, and kicking the food into its mouth with its legs. The body is surrounded, as in *Lepas*, by a fold of skin, which forms a rampart of six or more calcareous plates, and a fourfold lid, consisting of two *scuta* and two *terga*. When covered by the tide, the animal protrudes and retracts between the valves of the shell six pairs of curl-like thoracic legs. The structure of the acorn-shell is in the main like that of the barnacle, but there is no stalk.

The life history also is similar. A Nauplius is hatched. It has the usual three pairs of legs, an unpaired eye, and a delicate dorsal shield. It moults several times, grows larger, and acquires a firmer shield, a longer spined tail, and stronger legs. Then it passes into a *Cypris* stage, with two side eyes, six pairs of swimming legs, a bivalve shell, and other organs. As it exerts itself much but does not feed, it is not unnatural that it should sink down as if in fatigue. It fixes itself by its head and antennæ, and is glued by the secretion of the cement gland. Some of the structures, e.g. the bivalve-shell, are lost; new

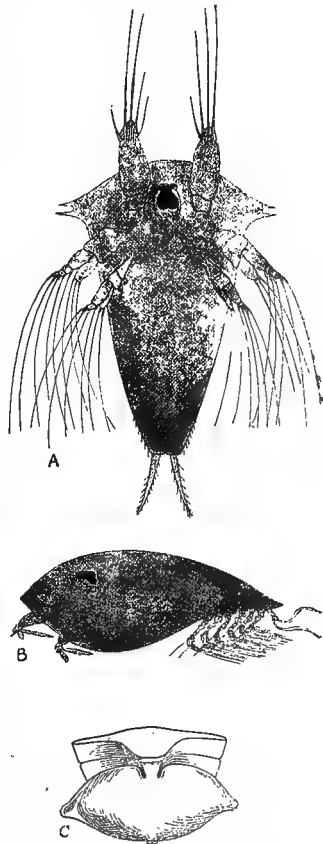

FIG. 159.—Development of *Sacculina*. —After Delage. (Not drawn to scale.)

A., Free-swimming Nauplius, with three pairs of appendages; B., pupa stage; C., adult protruding from the abdomen of a crab.

structures appear, *e.g.* the characteristic Cirriped legs and the shell. Throughout this period, which Darwin called the "pupa stage," there is external quiescence, and the young creature continues to fast. The skin of the pupa moults off; the adult structures and habits are gradually assumed. At frequent periods of continued growth the lining of the shell and the cuticle of the legs are shed. In spring these glassy cast coats are exceedingly common in the sea. Acorn-shells feed on small marine animals. They fix themselves not to rocks only, but also to shells, floating objects, and even to whales and other animals.

On the ventral surface of the abdomen of crabs, *Sacculina*, one of the most degenerate of all parasites, is often found. Its history has been beautifully worked out by Professor Delage. It is in shape an ovoid sac, and is attached about the middle of a segment. On the lower surface of the sac there is a cloacal aperture, opening into a large brood-chamber, usually distended with eggs contained in chitinous tubes. The brood-chamber surrounds the central "visceral mass," consisting of a nerve ganglion, a cement gland which secretes the egg-cases, and the hermaphrodite reproductive organs; of digestive or vascular systems there is no trace. The parasite is attached by a peduncle, dividing up into numerous "roots," which ramify within the body of the crab, and by them the *Sacculina* obtains nutrition and gets rid of its waste products; it is practically an *endoparasite*. The larvæ leave the brood-chamber as Nauplii; they moult rapidly and become Cyprid larvæ. These fix themselves by their antennæ to young crabs, at the uncalcified membrane round the base of large bristles. The thorax and abdomen are cast off; the structures within the head region contract; eyes, tendons, pigment, the remaining yolk and the carapace, are lost; a little sac remains, which passes into the interior of the crab. It reaches the abdomen, and, as it approaches maturity, the integuments of the crab are dissolved beneath it, and the sac-like body protrudes. It appears to live for three years, during which time the growth of its host is arrested, and no moult occurs. Forms allied to *Sacculina* are grouped together as Rhizocephala. One of them—*Sesarma xenos*—occurs on a fresh-water crab, *Sesarma*, in the Andamans; all the rest are marine.

Second Sub-Class. MALACOSTRACA

Series I. Leptostraca. Division Phyllocarida.

Marine Crustaceans of great systematic interest, retaining in many ways the simplicity of ancestral forms, and linking Malacostraca and Entomostraca. The most important genus is *Nebalia*.

A bivalve shell covers the whole of the lank body, except the last four abdominal segments; the head is free from the thorax; the eight segments of the thorax are free from one another, and the plate-like appendages resemble those of Phyllopods; the abdomen has seven segments and a telson with two forks; the elongated heart extends into the abdomen, and has seven pairs of lateral apertures or ostia. There are both antennary and maxillary excretory organs. *Nebalia* and its

congeners are probably related to certain ancient fossil forms from Palæozoic strata, e.g. *Hymenocaris* from the Cambrian.

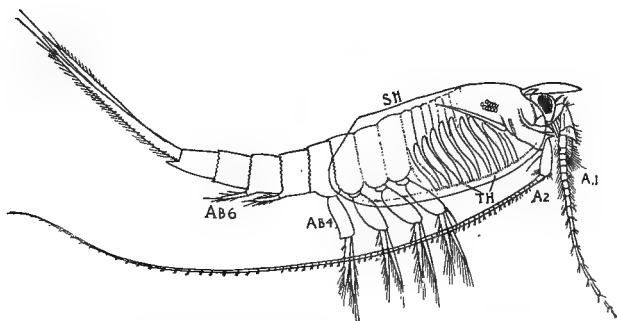

FIG. 160.—*Nebalia*.—After Sars.

SH., Shell; *A.1.*, first antennæ; *A.2.*, second antennæ; *TH.*, 8 thoracic limbs; *Ab.4.*, *Ab.6.*, fourth and sixth abdominal limbs.

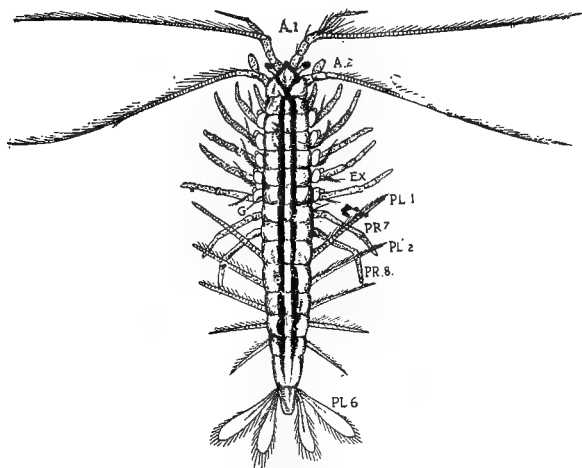

FIG. 161.—*Anaspides*.—After Calman.

A.1., *A.2.*, antennæ; *EX.*, rudimentary exopodite; *G.*, respiratory lamina *PR.7.*, *PR.8.*, seventh and eighth thoracic limbs or pereiopods; *PL.1.*, *2.*, *6.*, first, second, and sixth abdominal limbs or pleopods.

Series II. Eumalacostraca.

Division 1. Syncarida, the order Anaspidacea, primitive fresh-water forms, without a carapace; with the eight thoracic segments all distinct (*Anaspides*), or with the first one fixed to the head (*Koonunga*); with stalked eyes in *Anaspides*, sessile eyes in *Koonunga*; with lamellar branchiæ on the thoracic legs, whose slender exopodites are also respiratory.

Division 2. Peracarida, with a carapace that leaves at least four of the thoracic segments free, with the first thoracic segment always fused to the head, with usually sessile eyes, with a brood-pouch on the thoracic appendages of the female, with an elongated heart, with direct development. Numerous orders including:—the pelagic Mysidacea (formerly united with Euphausiacea

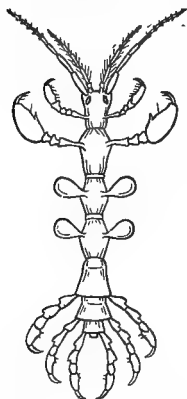

FIG. 162.—An Amphipod (*Caprella linearis*).

The two anterior thoracic segments are fused to the head; the abdomen is greatly reduced and without appendages; the fourth and fifth thoracic segments bear only respiratory plates.

Division 4. Eucarida, with a cephalo-thoracic shield uniting the head and thorax segments; with stalked eyes; with a saccular heart; with eggs attached to the abdominal endopodites; with spherical spermatozoa showing peculiar radiating pseudopodia; usually with a complex metamorphosis.

Order 1. Euphausiacea:—shrimp-like surface and deep-water forms, with biramous thoracic limbs as in Mysids, e.g. *Euphausia*.

Order 2. Decapoda:—with the three anterior thoracic limbs turned forward as maxillipedes, with the other thoracic limbs almost always uniramous.

as Schizopods), e.g. *Mysis*; the pelagic and deep-water Cumacea, e.g. *Cuma* and *Diastylis*; the Isopods, with dorso-ventral flattening of the body, a posterior heart, and respiratory organs on the abdominal limbs, e.g. the terrestrial wood-lice (*Porcellio*, *Oniscus*, etc.), which show minute trachea-like respiratory tubes in the abdominal limbs, and corresponding forms on the shore (e.g. *Ligia*, *Idotea*); the Amphipods, with lateral flattening of the body, an anterior heart, and respiratory organs usually on the thoracic limbs, e.g. *Gammarus locusta* in the shore pools, *G. pulex* in fresh water, and sandhoppers like *Talitrus* and *Orchestia*; the "no body" crabs, *Caprella*; *Phronima*, living inside the glassy case of the free-swimming Tunicate *Pyrosoma*.

Division 3. Hoplocarida, with a carapace that leaves at least four of the thoracic segments free, with stalked eyes, with the eggs carried in a chamber formed by the maxillipedes, with an elongated heart, and with a complicated metamorphosis. Order:—Stomatopods, e.g. *Squilla*, with the second maxillipedes forming very large raptorial organs.

Sub-order Macrura.—Abdomen long. *Homarus* (lobster); *Nephrops* (Norway lobster, sea crayfish); *Astacus* (fresh-water crayfish); *Palinurus* (rock lobster), whose larva was long known as the glass-crab (*Phyllosoma*); *Penæus*, a shrimp which passes through Nauplius, Zoæa, and Mysis stages; *Lucifer* and *Sergestes* are also hatched at a stage antecedent to the Zoæa; *Crangon vulgaris* (the British shrimp); *Palæmon*, *Pandalus*, *Hippolyte* (prawns); *Galathea* (with the abdomen

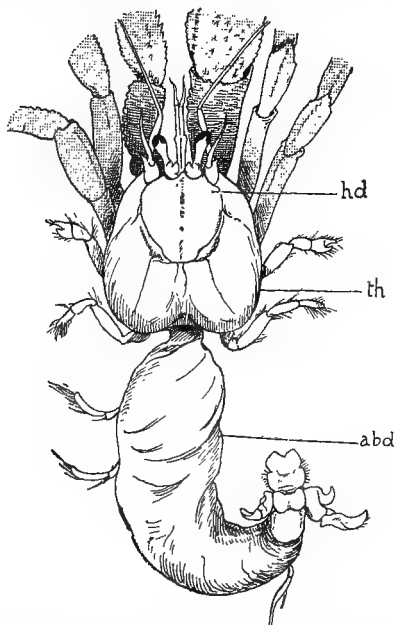

FIG. 163.—Hermit-crab withdrawn from its shell.
The anterior appendages are broken off.

hd., Head; *th.*, thorax; *abd.*, abdomen.

bent forwards); *Pagurus*, *Eupagurus* (hermit-crabs); *Birgus latro* (the terrestrial robber or palm-crab), in which the upper part of the gill-cavity is shut off to form a "lung," the walls having numerous vascular plaits.

Sub-order Brachyura. — Abdomen short, and bent under the thorax. It is narrow in the male, and does not usually bear more than two pairs of appendages; it is broader in the female, and bears four paired appendages. The ventral ganglia have fused

into an oval mass. *Cancer* (edible crab); *Carcinus maenas* (shore-crab); *Portunus* (swimming-crab); *Dromia* (often covered by a sponge); *Pinnotheres* (living inside bivalves); *Telphusa* (a fresh-water crab); *Gecarcinus* (land-crabs, only visiting the sea at the breeding season).

History.—Fossil Crustaceans are found in Cambrian strata, but the highest forms (Decapoda) were not firmly established till the Tertiary period. Some of the genera, e.g. the Branchiopod *Estheria*, living from Devonian ages till now, are remarkably persistent and successful. How the class arose we do not know; it is probable that types like *Anaspides* and *Nebalia* give us trustworthy hints as to the ancestors of the higher Crustaceans; it is likely that the Phyllopods, e.g. *Apus*, bear a similar relation to the whole series; the Copepods also retain some primitive

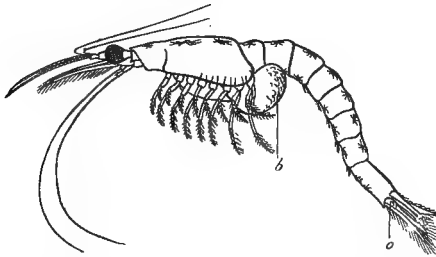

FIG. 164.—*Mysis flexuosa*, from side.

b., Brood-pouch borne on posterior thoracic limbs; *o.*, otocyst in tail. Note eight pairs of similar biramous thoracic feet. The last two thoracic segments are not covered by the shield.

characteristics; but it is difficult to say anything definite as to the more remote ancestry.

We naturally think of a segmented worm-type as a plausible starting-point for Crustaceans, and it is not difficult to imagine how a development of cuticular chitin would tend to produce a flexibly jointed limb out of an unjointed parapodium; how the mouth might be shunted a little backwards, and two appendages and ganglia a little forwards; and how division of labour would result in the differentiation of distinct regions.

GENERAL NOTES ON CRUSTACEANS

Of a class that includes animals so diverse as crabs, lobsters, shrimps, "beach-fleas," "wood-lice," barnacles, acorn-shells, and "water-fleas," it is difficult to state general

characteristics, other than those facts of structure which we have already summarised.

Admitting the parasitism of many Crustaceans, and the sedentary life of barnacles and acorn-shells, we must still allow that great activity characterises the class. With this may be connected the brilliant colouring, the power of colour change, and the phosphorescence of many forms.

Except in the case of a few primitive and degenerate forms, the Crustacea are all segmented. In this, in the presence of hollow jointed appendages, in the reduction of the cœlom, and in their firm chitinous cuticle, the Crustacea resemble other Arthropods; as special characteristics we notice the two pairs of antennæ; the presence of carbonate of lime in the cuticle, and the nature of the respiratory organs—these, with few exceptions, being adapted for breathing in water.

While these characters remain constant throughout the group, there is an almost infinite variety in detail. In regard to the segmentation of

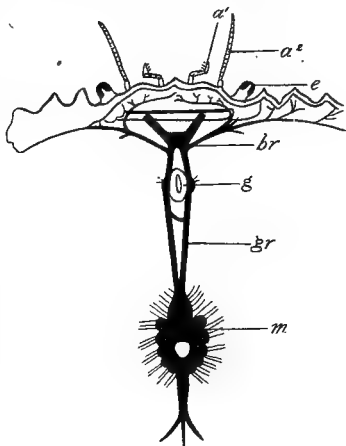

FIG. 165.—Nervous system of shore-crab (*Carcinus maenas*).—After Bethe.

br., The supra-oesophageal mass; *g.*, gullet surrounded by *gr.*, the gullet ring; *m.*, the sub-oesophageal mass representing a fusion of the thoracic ganglia of the crayfish, and giving off nerves to the limbs; behind it is a short strand representing the abdominal ganglia of the crayfish. *a*¹, antennules; *a*², antennæ; *e.*, eye.

the body, we notice that, apart from the general tendency to reduction which is so marked in many parasitic forms, the higher forms as compared with the lower show marked specialisation. In the primitive Phyllopods the body consists of a large but varying number of segments, remarkably uniform in structure. The higher Crustacea, on the other hand, are characterised by their relatively few but constant

segments, which exhibit marked division of labour; a comparison of *Nebalia*, *Mysis*, *Euphausia*, *Penæus*, *Nephrops*, will make this plain. The same gradual process of specialisation is observable in the appendages. Typically consisting of a basal piece and two branches, the appendages, like the parapodia of Annelids, are primitively organs of locomotion, usually adapted as swimming organs. In Phyllopods the great majority of the appendages remain permanently at this level. It is worth notice that in the Nauplius and in Ostracods and in free-swimming Copepods, the antennæ themselves are swimming organs. Just as, however, in the Annelid head the locomotor function of the parapodia becomes subordinated to the sensory one, so also in Crustacea the anterior appendages of the head become specialised as sense organs. Again, the appendages in connection with the mouth become modified in connection with alimentation, and the further processes of specialisation which differentiate the regions of the body are reflected in the appendages of these regions. It is this specialisation of certain appendages to function as masticatory organs which especially characterises Arthropods as compared with Annelids.

In the nervous system there is always a certain amount of fusion of ganglia—these never being so numerous as the segments—but the fusion is more marked in the more specialised forms. In the Crabs the ventral chain is represented by a lobed ganglionic mass in the thorax, connected with a mere rudiment, which corresponds to the abdominal portion of the cord in the crayfish (Fig. 165). Sense organs are usually well developed, and are not confined to the head region; thus many Mysids have “auditory” organs in the tail (Fig. 164). The alimentary canal runs straight throughout the body; it consists of fore-gut, mid-gut, and hind-gut. The fore-gut and hind-gut are anterior and posterior invaginations of ectoderm, and are always large, especially in Malacostraca. In the higher Malacostraca the fore-gut is furnished with a gastric mill. The mid-gut or archenteron is always short, but has connected with it diverticula which form the so-called hepatopancreas. In the Entomostraca there is usually only a single pair of outgrowths; in Mysids, Cumacea, and larval

Decapods there are three pairs; a process of rapid growth and branching converts these into the compact digestive gland of the adult Decapods. In connection with the posterior end of the mid-gut in Amphipods and some others, there is a pair of blind tubes functioning as excretory organs, and presenting an interesting similarity to the Malpighian tubes of insects, which, however, are in connection with the hind-gut. The body cavity is never large, being mainly filled up with muscles and organs, and, as in Arthropods in general, the true coelom is virtually absent. In the blood, hæmocyanin is the commonest pigment, but is not universal. Respiration is carried on in many different ways. In the simple forms it may be merely by the general surface, but in the majority of cases, certain portions of the limbs, or outgrowths of the limbs, constitute definite respiratory organs, often specialised to form gills. In the excretory system the numerous nephridia of Annelids are absent. The typical excretory organs of the Entomostraca are the "shell glands"—paired coiled tubes opening on the second maxilla; of the Malacostraca, the antennary glands exemplified by the green glands of the crayfish. The genital ducts are possibly modified nephridia.

There are many peculiarities connected with reproduction—thus parthenogenesis for prolonged periods is common among "water-fleas"; hermaphroditism is frequent, occurring, for example, in barnacles, acorn-shells, etc., and it is often complicated by the simultaneous existence of "pigmy" complemental males. When separate, the two sexes are often very diverse. The spermatozoa are often exceptional in being very slightly motile. Some appendages are often modified for copulation or for carrying the eggs.

Development.—The ova of most Crustacea show considerable similarity to those of *Astacus*, and the segmentation is typically of the kind already described. But while this is the most typical case for Crustacean, and, indeed, for Arthropod development, it is possible, within the limits of the class Crustacea, to trace out a complete series, in which the first term is a segmentation of the complete and equal type, like that of a worm, and the last the purely peripheral. In the same way, though gastrulation is usually much disguised, there are many modes, from

an invagination of the simplest embolic type (*Lucifer*), and through the condition described for *Astacus*, to the formation of endoderm by the ingrowth of a solid plug of cells.

Compared with *Astacus*, however, the most important point we have to notice is the frequent occurrence of a very striking metamorphosis in the life history. In other words, the larva hatched from the egg is rarely like the parent, and

only acquires the adult characters after a series of profound changes. In some cases (*Nebalia*, *Mysis*) a metamorphosis takes place within the egg-cases, and in the few forms in which development seems to be direct, slight traces of metamorphosis are found.

Almost all the lower Crustaceans and some higher forms, e.g. *Euphausia* and *Penæus*, are hatched in a Nauplius stage. In the remaining cases the Nauplius stage is indicated within the egg by the moulting of a larval cuticle (as in *Astacus*). The Nauplius is characterised by a typically rounded body, and by the presence of three pairs of appendages, which are the only

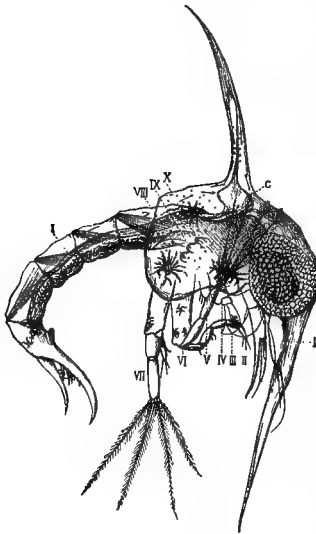

FIG. 166.—Zoea of common shore-crab (*Carcinus maenas*).—After Faxon.

The appendages are numbered; c., gills; z., alimentary canal.

obvious indications of segmentation. The first pair of appendages are unbranched, and bear larval sense organs, the next two are biramous swimming organs. There is an unpaired median eye, but no heart, and frequently no hind-gut. The three pairs of appendages become the first and second pairs of antennæ and the mandibles of the adult. The head region of the

Nauplius becomes the head region of the adult; the posterior region also persists; the new growth of segments and appendages takes place (with numerous moultings) in the region between these.

The second important form of larva is the Zoæa, which has all the appendages on to the last maxillipedes inclusive, a segmented abdomen, and two lateral compound eyes, in addition to the unpaired one of the Nauplius stage. Most Decapoda are hatched in the Zoæa stage.

- (a) The crayfish (*Astacus*) is hatched almost as a miniature adult. The development is therefore very direct in this case.
- (b) The lobster (*Homarus*) is hatched in a *Mysis* stage, in which the thoracic limbs are two-branched and used for swimming. After some moults it acquires adult characters.
- (c) Crabs are hatched in the Zoæa form, and pass with moults through a *Megalopa* stage, with the abdomen in a line with the cephalothorax. The abdomen is subsequently tucked in under the thorax.
- (d) *Penæus* (a kind of shrimp) is hatched as a *Nauplius*, becomes a Zoæa, then a *Mysis*, then an adult. Its relative *Lucifer* starts as a *Meta-Nauplius* with rudiments of three more appendages than the Nauplius. Another related form, *Sergestes*, is hatched as a *Protozoæa*, with a cephalothoracic shield and an unsegmented abdomen. Thus there are two grades between Nauplius and Zoæa.

Three facts must be borne in mind in thinking over the life histories of crayfish, lobster, crab, and *Penæus*: (1) There is a general tendency to abbreviate development, and this is of more importance when metamorphosis is expensive and full of risks; (2) there is no doubt that larvae exhibit characters which are related to their own life rather than to that of the adult; (3) it is a *general* truth, that in its individual development the organism recapitulates to some extent the evolution of the race, that ontogeny tends to recapitulate phylogeny. But while there can be no doubt that the metamorphosis of these Crustaceans is to some extent interpretable as a recapitulation of the racial history,—for there were unsegmented animals before segmented forms arose, and the Zoæa stage is antecedent to the *Mysis*, etc.,—yet it does not follow that ancestral Crustaceans were like Nauplii. On the contrary, the *Nauplius* must be regarded as a larval reversion to a type much simpler than the ancestral Crustacean.

Ecology.—Most Crustaceans are carnivorous and predatory; others feed on dead creatures and organic débris in the water; a minority depend upon plants. Many of the smaller forms play a very important part in the economy of nature—in the circulation of matter—for while they feed on

animalcules and débris, they are themselves the food of larger animals such as fishes.

Parasitism occurs in over 700 species, in various degrees, and, of course, with varied results. Most of the parasites keep to the outside of the host (*e.g.* fish-lice), and suck nourishment by their mouths; the Rhizocephala (*e.g.* *Sacculina*) send ramifying absorptive roots through the body of the host. Sometimes the parasitism is temporary (*Argulus*); sometimes only the females are parasitic (*e.g.* in *Lernæa*). The parasites tend to lose appendages, segmentation, sense organs, etc., but the reproductive organs become more fertile. The hosts, *e.g.* crabs, infested by Rhizocephala, are sometimes materially affected, and even rendered incapable of reproducing.

Some Crustaceans live not as parasites, but as commensals with other animals, doing them no harm, though sharing their food. Thus there is a constant partnership between some hermit-crabs and sea-anemones (Fig. 16). The hermit-crab is concealed and protected by the sea-anemone; the latter is carried about by the Crustacean, and gets fragments of food.

Masking is also common, especially among crabs. Some will cut the tunic off a sea-squirt and throw it over their own shoulders. Many attain a mask more passively, for they are covered with hydroids and sponges, which settle on the shell. There is no doubt, however, that some actively mask themselves, for besides those known to use the Tunicate cloak, others have been seen planting seaweeds on their backs. The protective advantage of masking both in offence and defence is very obvious.

The intelligence of crabs and some of the higher Crustaceans is well developed. Maternal care is frequent. Fighting is very common. Many will "voluntarily" part with a leg to save themselves from their enemies. The loss of limbs is readily repaired.

Deep-sea Crustaceans are very abundant, and often remarkable "for their colossal size, their bizarre forms, and brilliant red colouring"; in many cases, they are brilliantly phosphorescent. Yet more abundant are the pelagic Crustaceans (especially Entomostraca and Mysids); they are often transparent except the eyes, often

brightly coloured or phosphorescent. Many Crustaceans live on the shore, and play a notable part in the struggle for existence which is so keen in that densely crowded region. The lower Crustaceans are abundantly represented in fresh water, in pools, streams, and lakes. A few Crustaceans, such as wood-lice and land-crabs, are terrestrial, and some blind forms occur in caves.

CHAPTER XIV

PHYLUM ARTHROPODA—(continued)

Classes (continued)—ONYCHOPHORA or PROTOTRACHEATA ;
MYRIOPODA ; and INSECTA

THESE three classes form a series of which winged insects are the climax. The type *Peripatus* is archaic, and links the series to the Annelids: the Myriopods lead on to the primitive wingless insects. All breathe by tracheæ—tubes which carry air to the organs of the body—and all have antennæ; hence they are often united under the title Tracheata Antennata.

First Class of Tracheata Antennata.—ONYCHOPHORA or PROTOTRACHEATA

GENERAL CHARACTERS

The body is worm-like in form, soft-skinned, and without external segmentation.

The appendages are—a pair of prominent pre-oral antennæ, a pair of jaws in the mouth, a pair of slime-secreting oral papillæ, which development shows to be true appendages, numerous pairs of short, imperfectly jointed legs, each with two claws, and a pair of anal papillæ, which are rudimentary appendages. The legs contain peculiar (crural) glands.

Respiration is effected by numerous unbranched tracheæ with openings irregularly scattered. The heart is an elongated dorsal vessel with valvular ostia. There is a series of nephridia in the legs. The halves of the ventral nerve-cord are widely separate. All are viviparous.

In its possession of tracheæ and nephridia this type is an interesting connecting link; in many ways it seems to be an old-fashioned survivor of an archaic stock. There are about half a dozen genera very widely distributed.

The Onychophora are very beautiful animals. Prof. Sedgwick says: "The exquisite sensitiveness and continually changing form of the antennæ, the well-rounded plump body, the eyes set like small diamonds on the side of the head, the delicate feet, and, above all, the rich colouring and velvety texture of the skin, all combine to give these animals an aspect of quite exceptional beauty." They are shy and nocturnal, with a great dislike to light. They seek out damp places under leaves and among rotting wood. They feed on insects, which they catch by the ejection of slime from the oral papillæ. The slime is also squirted out when they are irritated. To their shy habits their persistence is possibly in part due. They are able to move quickly, somewhat after the fashion of millipedes, especially like *Scolopendrella*. They have been seen to climb up vertical glass plates. When at rest or irritated they coil up in a circle.

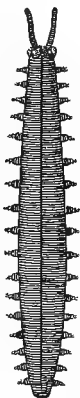

FIG. 167.—External form of *Peripatus*.—After Balfour.

Note antennæ and simple legs.

Like some other archaic types, *e.g.* Dipnoi, the Onychophora have a very wide range of distribution, which may be briefly indicated:—*Peripatus* (tropical America and tropical Africa); *Eoperipatus* (Indo-Malay); *Peripatoides* and *Ooperipatus* (Australasia); *Opisthopatus* (Chili and South Africa); *Paraperipatus* (New Britain); *Peripatopsis* (Central Africa).

A more Detailed Account of Peripatus

Form.—The body suggests an Annelid or a caterpillar, but, apart from the appendages, there is no external segmentation. There is a clear dorso-median line. Over the soft skin are numerous minute warts with small bristles. The mouth is ventral and anterior; the anus terminal and posterior.

Appendages.—The first are the large, ringed antennæ; then follow the sickle-like jaws in the mouth cavity; a little farther back are two oral papillæ from which slime is exuded. Then there are the 14-42 stump-like legs, each with two terminal chitinous claws.

Skin.—The chitinous cuticle, ordinarily thick in Arthropods, is delicate. It is subject to moulting. The epidermis is a single layer of cells. Beneath it there is a dermis.

Muscular system.—Externally there is a layer of circular muscles; within this lies a double layer of diagonal fibres; internally there are strong longitudinal bundles. Finally, in connection with this internal layer, there are fibres which divide the apparent body cavity into a median and two lateral compartments. The median includes heart, gut, slime glands, reproductive organs; the laterals include the nerve-cords and salivary glands; the legs contain nephridia and coxal or crural vesicles. Striped, rapidly contracting muscles are characteristic of Arthropods, but in *Peripatus* the muscles are unstriped, excepting those which work the jaws and are perhaps the most active. The true coelom is represented in the embryo by the cavities of the mesoderm segments, which give origin to the muscular system.

Nervous system.—The dorsal brain is connected by an oesophageal ring with the two widely separate latero-ventral nerve-cords. These are connected transversely by numerous commissures, are slightly swollen opposite each pair of legs, to which they give off nerves, and are united posteriorly over the anus. There are only hints of ganglia, but there is a continuous layer of ganglionic cells. The brain is very homogeneous, simpler than that of most Insects. Sense organs are represented by two simple eyes on the top of the head. These are most like the eyes of some marine Annelids.

Alimentary canal.—Round about the mouth papillæ seem to have fused to form a "mouth cavity," which includes the mandibles, a median pad or tongue, and the opening of the mouth proper. The mouth leads into a muscular pharynx, into which opens the common duct of two large salivary glands, which extend far back along the body. Mouth, pharynx, and short oesophagus are lined by a chitinous cuticle, like that of the exterior. The long endodermic digestive region or mid-gut extends from the second leg nearly to the end of the body. Its walls are plaited. Finally, there is a short rectum or proctodæum, lined by a chitinous cuticle.

Circulatory system.—The dorsal blood vessel forms a long contractile heart. It lies within a pericardial space, and receives blood by segmentally arranged apertures with valves. The circulation is mostly in ill-defined spaces in the apparent body cavity or "hæmo-coele."

Respiratory system.—Very long and fine unbranched tracheæ are widely distributed in the body; a number open together to the exterior in flask-like depressions. These openings or stigmata are irregularly distributed.

Excretory system.—A pair of nephridia lie in each segment. Each consists of an internal mesodermic terminal funnel, a looped canal, and a wide vesicle which opens near the base of each leg, the two last parts being invaginations of the ectoderm. Nephridia are not known in any other Tracheate. The salivary glands and the genital ducts seem to be modified nephridia. It may be noted, too, that the same is perhaps true of the "coxal glands" of *Limulus* and of the antennary glands of Crustaceans.

Coxal or crural glands lie in the legs and open to the exterior. They can be in part evaginated, and they probably help in respiration. In the male of *P. capensis* the last pair are very long (Fig. 168, *a.g.*). The large mucous glands, which pour forth slime from the oral papillæ, are regarded as modified crural glands.

Reproductive system.—(*a*) Female (of *P. edwardsii*).—From the two ovaries, which are surrounded by one connective tissue sheath, and arise, as usual, from the cœlomic epithelium, the ova pass by two long ducts leading to a common terminal vagina opening between the second last legs. These ducts are for the most part uteri, but on what may be called the oviduct portions adjoining the ovaries, there are two pairs of pouches—a pair of receptacula seminis (for storing the spermatozoa

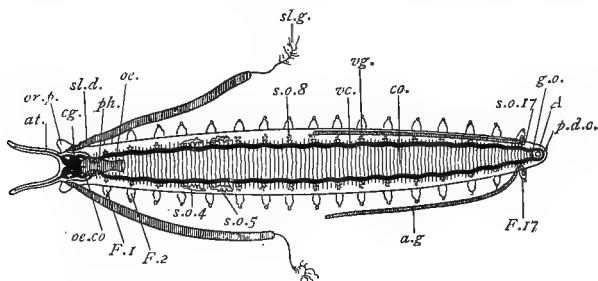

FIG. 168.—Dissection of *Peripatus*.—After Balfour.

at., Antennæ; *or.p.*, oral papillæ; *c.g.*, cerebral ganglia; *sl.d.*, duct of slime gland (*sl.g.*); *s.o.8*, eighth segmental organ or nephridium; *v.c.*, ventral nerve connected by transverse commissures (*co.*) with its fellow; *s.o.17*, seventeenth nephridium; *g.o.*, genital aperture; *A.*, anus; *p.d.c.*, posterior commissure; *F.17*, seventeenth appendage; *a.g.*, last crural gland—that of the opposite side is marked *v.g.*; *F.1*, *F.2*, first and second legs; *oe.co.*, oesophageal nerve commissure; *oe.*, oesophagus; *ph.*, pharynx—the remainder of the gut is removed.

received during copulation), and a pair of receptacula ovarum for storing fertilised eggs.

The eggs are hatched in the uteri, and all stages are there to be found in regular order. The young embryos seem to be connected to the wall of the uterus by what has been called a "placenta," so suggestive is it of mammalian gestation. The older embryos lose this "placenta," but each lies constricted off from its neighbours. When born the young resemble the parents except in size and colour. In *P. capensis* the period of gestation is thirteen months.

(*b*) Male (of *P. edwardsii*).—The male elements are produced in small testes, pass thence into two seminal vesicles, and onwards by two vasa deferentia into a long single ejaculatory duct, which opens in front

of the anus. In the ejaculatory duct the spermatozoa, which are thread-like, are made into spermatophores which are attached to the female. It is uncertain how the spermatozoa get into the female. Fertilisation is ovarian.

While it is characteristic of Arthropods, in which chitin is so predominant, that ciliated epithelium is absent, it seems that in *Peripatus*, which is much less chitinous than the others, ciliated cells occur in some parts of the reproductive ducts.

Development.—There is some variety of development in different species. Thus there is much yolk in the ovum of *P. novæ zealandiæ*, extremely little in that of *P. capensis*.

In *P. capensis* the "segmentation" is remarkable, for true cleavage of cells does not occur. The fully "segmented" ovum does not exhibit the usual cell limits. It is a protoplasmic mass—or syncytium—with many nuclei. Even when the body is formed, the continuity of cells persists, nor does the adult lack traces of it. To Prof. Sedgwick this singular fact suggested the theory that the Metazoa may have begun as multinucleate Infusorian-like animals.

The gut appears from a fusion of vacuoles within the multinucleated mass, and a gastrula stage is thus established. A very interesting feature is that the blastopore or mouth of the gastrula is first elongated, then dumb-bell shaped, then closed except at the two ends which form the mouth and the anus.

In the ova of *P. novæ zealandiæ*, which have much yolk, a superficial multiplication of nuclei forms a sort of blastoderm, which spreads over almost the entire ovum. The segmentation in this case has been called centrolecithal (the type characteristic of Arthropods), but it is again true that for a long time the cells do not exist as well-defined units. It

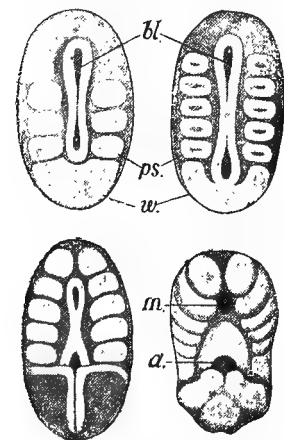

FIG. 169.—Embryos of *Peripatus capensis*, showing closure of blastopore and curvature of embryo.—After Korschelt and Heider.

a., Anus; bl., blastopore; m., mouth; p.s., primitive segments; w., zone of proliferation.

has been said, indeed, that "the embryo is formed by a process of crystallising out *in situ* from a mass of yolk, among which is a protoplasmic reticulum containing nuclei."

Zoological position.—The synthetic characters of *Peripatus* and its allies may be thus summarised:—

ANNELID CHARACTERISTICS.

Segmentally arranged nephridia as in Chætopods.
 The muscular ensheathing of the body.
 The cilia in the genital ducts.
 Less important are the stump-like hollow legs and the simple eyes.

ARTHROPOD AND TRACHEATE CHARACTERISTICS.

The presence of tracheæ.
 The nature of the heart (a tube with paired ostia communicating with a pericardium) and the lacunar circulation.
 The modification of appendages as mouth organs.
 The form of the salivary glands.
 The smallness of the genuine coelom; the cavity of the body is hæmocœlic.

The Onychophora differ from other Tracheata Antennata in the simplicity and diffuseness of the tracheæ, in having only one pair of jaws, in the absence of external segmentation, in the nature of the body wall, and so forth.

The ladder-like character of the ventral nervous system (cf. primitive Molluscs, Phyllopod Crustaceans, and Nemerteans) is probably primitive. That salivary glands and genital ducts are homologous with nephridia is a fact of much morphological interest. It is possible that the slime glands are modifications of crural glands, and that the latter are homologous with the parapodial glands of some Annelids. It is not certain that the antennæ, jaws, and oral papillæ of *Peripatus* precisely correspond to the antennæ, mandibles, and first maxillæ of Insects.

Our general conclusion is that *Peripatus* is an archaic type, a survivor of forms which were ancestral to Tracheata and closely related to Annelids.

Second Class of Tracheata Antennata.—MYRIOPODA.

Centipedes and Millipedes

The centipedes and millipedes, which are grouped together in the class Myriopoda, are usually elongated, somewhat vermiform animals, with a distinct head and a very uniform segmented trunk. The head bears eyes (groups of eye-spots, not compound eyes like those of insects, except in *Scutigera*), jointed antennæ, and two or three pairs of jaws. The segments of the trunk bear six- or seven-jointed legs with terminal claws, very similar throughout. The nervous system, the tracheæ, the heart, the excretory tubules, etc., are like those of Insects. It cannot

be said that the centipedes (*Chilopoda*) and the millipedes (*Diplopoda*) are very closely related to one another, and ~~there are two other distinct orders, Symphyla and Pauropoda.~~ The resemblances are in part resemblances of *convergence*, not of genuine affinity. Simple wingless insects, known as Collembola and Thysanura, are closely approached by such

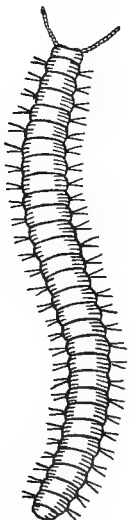

FIG. 170.—A millipede.

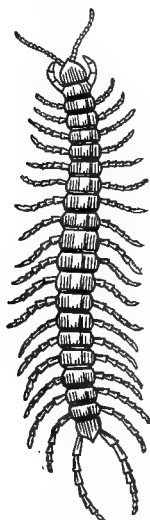

FIG. 171.—A centipede

Myriopods as *Scolopendrella*; and it is likely that Myriopods and Insects are divergent branches from a common stock.

Centipedes and millipedes are characteristically ~~terrestrial~~. Most are very shy animals, lurking in dark places and avoiding the light, but it is interesting to note that at least two Myriopods—*Geophilus submarinus* and *Linotænia maritima*—occur on British coasts.

MYRIOPODA

CENTIPEDES. CHILOPODA,	MILLIPEDES. DIPLOPODA (or CHILOGNATHA).
<p><u>Carnivorous.</u> <u>Poisonous.</u> Body usually flat.</p> <p>One pair of appendages to each segment. The stigmata do not correspond in number to the segments; they often occur on alternate segments.</p> <p>Many-jointed antennæ. Toothed cutting mandibles. Two pairs of maxillæ, usually with palps.</p> <p><u>The first pair of legs modified as poison claws.</u></p> <p>A single genital aperture on the second last segment.</p> <p>Examples.—<i>Scolopendra.</i> <i>Lithobius.</i> <i>Geophilus.</i></p>	<p>Vegetarian. Harmless. Body cylindrical.</p> <p>By the imperfect separation of the segments, all but the first three behind the head seem to have two pairs of appendages each, and also two paired ganglia, and two pairs of stigmata (tracheal openings).</p> <p>Seven-jointed antennæ. Broad masticating mandibles. A pair of maxillæ fused in a broad plate, usually four-lobed.</p> <p><u>No poison claws.</u></p> <p><u>Genital apertures open anteriorly.</u></p> <p>Examples.—<i>Julus.</i> <i>Polyxenus.</i> <i>Glomeris.</i></p>

In the order Symphyla (*Scolopendrella*) there are not more than twelve segments, and there is only one pair of tracheæ, which open on the head. *Scolopendrella* is in several ways like the primitive insects known as Thysanura. In the order Pauropoda (*Pauropus*), there are ten segments, and the antennæ are branched.

Third Class of Tracheata Antennata.—INSECTA

Insects occupy a position among the backboneless animals like that of birds among the Vertebrates. The typical members of both classes have wings and the power of true flight, richly aerated bodies, and highly developed respiratory, nervous, and sensory organs. Both are very active and brightly coloured. They show parallel differences between the sexes, and great wealth of species within a narrow range.

GENERAL CHARACTERS

Like other Arthropods, Insects have segmented bodies, jointed legs, chitinous armature, and a ventral chain of ganglia linked to a dorsal brain. Compared with Peripatus and Myriopods, adult insects show concentration of the body segments, decrease in the number and increase in the quality of the appendages, and wings in the great majority.

Insects are terrestrial and aerial, and rarely aquatic animals; usually winged as adults, breathing by means of

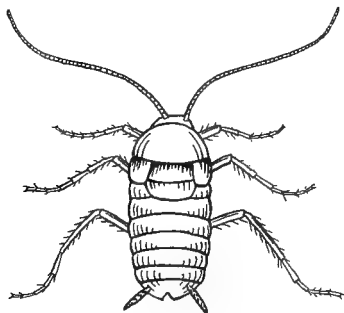

FIG. 172.—Female cockroach
(*P. orientalis*).

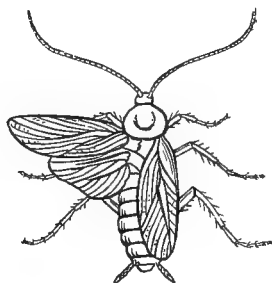

FIG. 173.—Male cockroach
(*P. orientalis*).

tracheæ, and often with a metamorphosis in the course of their life history.

~~The body is divided into three distinct regions.—head, thorax, and abdomen.~~ ^{→ as opposed to Periplaneta} The head bears a pair of pre-oral antennæ, and three pairs of mouth appendages; the thorax bears a pair of legs on each of its three segments, and, typically, a pair of wings on each of the posterior two; the abdomen has no appendages, unless rudimentary modifications of these be represented by stings, ovipositors, etc.

First Type of Insects, *Periplaneta* (or *Blatta*).—
The COCKROACH

Habits.—The cockroaches in Britain are immigrants from the East (*P. orientalis*), or from America (*P. americana*).

EXTERNAL CHARACTERS

REGION.	APPENDAGES.	OTHER STRUCTURES.
<p>The head is vertically elongated and separated from the thorax by a neck.</p> <p>The insect's head seems to consist of seven fused segments—ocular, antennary, intercalary, mandibular, maxillary, and labial.</p> <p>The thorax consists of three segments—</p> <p>(a) prothorax, (b) mesothorax, (c) metathorax. (Each segment is bounded by a dorsal tergum and ventral sternum.)</p> <p>The abdomen consists of 10 (or 11) distinct segments, with terga and sterna as in the thorax. The first sternum is rudimentary in both sexes, and in the female the eighth and ninth segments are concealed by the large seventh.</p>	<p>1. The antennæ (probably homologous with appendages), long, slender, many-jointed, tactile.</p> <p>2. A pair of stout toothed mandibles working sideways.</p> <p>3. The first maxillæ, each consisting—</p> <p>(a) of a basal piece or protopodite with two joints: a basal cardo, a distal stipes; (b) of a double endopodite borne by the basal piece, and consisting of an inner lacinia and a softer outer galea; (c) of an exopodite or maxillary palp also borne by the basal piece, and consisting of five joints.</p> <p>4. The second pair of maxillæ, fused together as the "labium," consisting—</p> <p>(a) of a fused basal piece or protopodite with two joints: a basal sub-mentum, a smaller distal mentum; on each side this protopodite bears— (b) a double endopodite (ligula) consisting of an inner lacinia and an outer paraglossa; (c) an exopodite or labial palp, consisting of three joints.</p> <p>(a) First pair of legs. (b) Second pair of legs. (c) Third pair of legs. Each leg consists of many joints—a basal expanded "coxa" with a small "trochanter" at its distal end, a "femur," a "tibia," a six-jointed tarsus or foot ending in a pair of claws (Fig. 175).</p> <p>Two cigar-shaped tactile anal cerci, attached under the edges of the last tergum, are possibly relics of the last abdominal appendages.</p> <p>The ninth sternum of the male bears a pair of styles, possibly relics of appendages.</p> <p>Both sexes have complex hard structures (gonapophyses) beside the genital apertures. They are possibly relics of appendages.</p>	<p>The large black compound eyes.</p> <p>The "upper lip" or labrum, in front of the mouth.</p> <p>The white oval patches near the bases of the antennæ, possibly sensory.</p> <p>In some primitive insects a minute pair of appendages, known as maxillulæ, occurs between the mandibles and the first maxillæ.</p> <p>(b) A pair of wing-covers (modified wings), rudimentary in female of <i>P. orientalis</i>.</p> <p>(c) A pair of membranous wings, sometimes used in flight, folded when not in use, absent in female of <i>P. orientalis</i>.</p> <p>Between the segments of the thorax are two pairs of respiratory apertures or stigmata.</p> <p>A pair of stigmata occur between the edges of the terga and sterna in the first eight abdominal segments.</p> <p>The anus is terminal, beneath the tenth tergum of the abdomen; a pair of "podical plates" lie beside it.</p> <p>The genital aperture is on the eighth segment in the female, behind the ninth sternum in the male.</p> <p>The opening of the spermatheca—the female's receptacle for spermatozoa—lies on the ninth sternum of the abdomen.</p>

They are omnivorous in their diet, active in their habits, hiding during the day and feeding at night. They are ancient insects, for related forms occurred in Silurian ages; they are average types, neither very simple nor very highly specialised. Their position is among the Orthoptera, in the same order as locusts and grasshoppers. The hatched young are like miniatures of the adults, except that wings are absent. If there are wings, they appear at the last moult, when the cockroach becomes sexually mature.

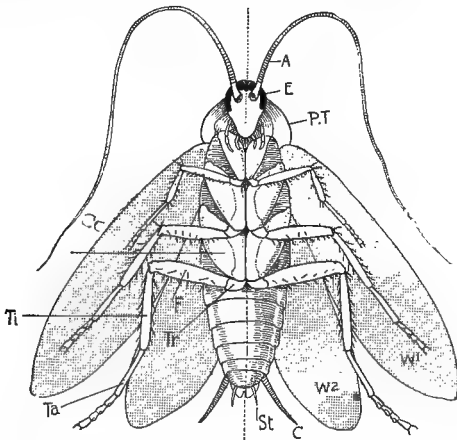

FIG. 174.—Ventral aspect of male cockroach with the wings extended. An imaginary median line has been inserted.

A., antennæ; *E.*, eye; *P.T.*, prothorax; *W¹*, first pair of wings; *W²*, second pair of wings; *C.*, cercus; *St.*, style; *Co.*, coxa; *Tr.*, trochanter; *F.*, femur; *Ti.*, tibia; *Ta.*, tarsus.

Skin.—There is an external chitinous cuticle and a subjacent cellular layer—the epidermis or hypodermis—from which the cuticle is formed. The newly hatched cockroaches are white, the adults are dark brown.

Moulting, which involves a casting of the cuticle, of the internal lining of the tracheæ, etc., occurs some seven times before the cockroach attains in its fifth year to maturity.

The *muscles* which move the appendages, and produce

the abdominal movements essential to respiration, are markedly cross striped. They are in many cases attached to special tendons, which arise as cuticular invaginations, and are lost and replaced at each moult.

Nervous system.—A pair of supra-oesophageal or cerebral ganglia lie united in the head. As a brain they receive impressions by antennary and optic nerves. By means of a paired commissure surrounding the gullet, they are connected with a double ventral chain of ten ganglia. Of these, the first or sub-oesophageal pair are large, and give off nerves to the mouth-parts, etc. ; from each of the ganglia of the thorax and the abdomen nerves are given off to adjacent parts. There are three pairs of ganglia in the thorax, and six in the abdomen, of which the last is the largest. From the oesophageal commissures visceral nerves are given off to the gullet, crop, and gizzard. Besides the large compound eyes, there are other sensory structures — some of the setæ on the skin, the maxillæ (to some extent organs of taste), the antennæ (tactile and olfactory), the anal cerci (tactile), and possibly the oval white patches on the head.

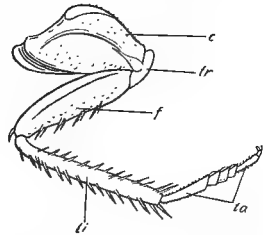

FIG. 175.—Leg of cockroach.
c., Broad expanded coxa; *tr.*, trochanter; *f.*, femur; *ti.*, tibia; *ta.*, six-jointed tarsus with terminal claws and adhesive cushions.

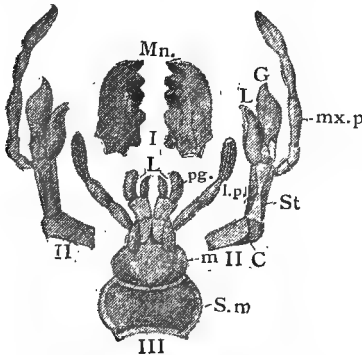

FIG. 176.—Mouth appendages of cockroach.—After Dufour.

I. *Mn.*, mandibles; II. first maxillæ; *C.*, cardo; *St.*, stipes; *L.*, lacinia; *G.*, galea; *mx.p.*, maxillary palp; III. second maxillæ or labium; *S.m.*, submentum; *m.*, mentum; *L.*, lacinia; *pg.*, paraglossa; *l.p.*, labial palp.

etc. ; from each of the ganglia of the thorax and the abdomen nerves are given off to adjacent parts. There are three pairs of ganglia in the thorax, and six in the abdomen, of which the last is the largest. From the oesophageal commissures visceral nerves are given off to the gullet, crop, and gizzard. Besides the large compound eyes, there are other sensory structures — some of the setæ on the skin, the maxillæ (to some extent organs of taste), the antennæ (tactile and olfactory), the anal cerci (tactile), and possibly the oval white patches on the head.

Alimentary system.—(1) The fore-gut (stomodæum) is lined by a chitinous cuticle continuous with that of the outer surface of the body. It includes—(a) the buccal or mouth cavity, in which there is a tongue-like ridge, and into which there opens the duct of the salivary glands; (b) the narrow gullet or œsophagus; (c) the swollen crop; (d) the gizzard, with muscular walls, six hard cuticular teeth, and some bristly pads.

There is a pair of diffuse salivary glands on each side of the crop, and between each pair of glands a salivary receptacle. The ducts of the two salivary glands on each side unite; the two ducts thus formed combine in a median duct, and this unites with another median duct formed from the union of the ducts of the receptacles. The common duct opens into the mouth.

(2) The mid-gut (mesenteron) is lined by endoderm. It

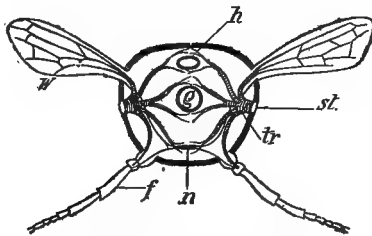

FIG. 177.—Transverse section of insect.—After Packard.

h., Heart; *g.*, gut; *n.*, nerve-cord; *st.*, stigma; *tr.*, trachea; *w.*, wing; *f.*, femur of leg.

is short and narrow, and with its anterior end seven or eight club-shaped digestive (pancreatic) outgrowths are connected.

(3) The hind-gut (proctodæum) is lined by a chitinous cuticle. It is convoluted and divided into narrow ileum, wider colon, and dilated rectum with six internal ridges.

Respiratory system.—The tracheal tubes, which have ten pairs of lateral apertures or stigmata, ramify throughout the body, and have a spirally thickened chitinous lining.

Circulatory system.—The chambered heart lies along the mid-dorsal line of abdomen and thorax. It receives blood by lateral valvular apertures from the surrounding

pericardial space, and drives it forwards by a slender aorta. The blood circulates, however, within ill-defined spaces in the body.

Excretory system.—There are sixty or so fine (Malpighian) tubules, which rise in six bundles from the beginning of the ileum, and twine through the “fatty body” and in the abdominal cavity. The absence of nephridia in insects has been already mentioned.

REPRODUCTIVE SYSTEM

OF THE MALE.	OF THE FEMALE.
<p>The testes are paired organs, surrounded by the fatty body below the 5th and 6th abdominal terga. They atrophy in the adult.</p> <p>From the testes, two narrow ducts or vasa deferentia lead to two seminal vesicles.</p> <p>These seminal vesicles (the “mushroom-shaped gland”) open into the top of the ejaculatory duct.</p> <p>This duct opens between the 9th and 10th sterna. Beside the aperture, there are copulatory structures (gonapophyses). With the ejaculatory duct a gland is associated.</p> <p>Large branched tubular glands secrete a volatile alkaline substance, with a strong mousy odour, probably offensive to enemies.</p>	<p>The ovaries are paired organs, in the posterior abdominal region, each consisting of eight ovarian tubes. These are bead-like strings of ova at various stages of ripeness.</p> <p>From the ovarian tubes of each side eight eggs pass at a time into a short wide oviduct.</p> <p>The two oviducts unite and open in a median aperture on the 8th abdominal sternum. Beside the aperture are hard structures (gonapophyses) which help in the egg-laying.</p> <p>On the 9th abdominal sternite a pair of arborescent glands pour out their cementing secretion by two apertures. The spermatheca is a paired sac opening between the 8th and the 9th abdominal sternum.</p>

Sixteen ova, one from each ovarian tube, are usually enclosed within each egg-capsule. The latter is formed from the partly calcareous secretion of the arborescent

glands. Each egg is enclosed in an oval shell, in which there are several little holes (micropyles), through one of which a spermatozoon enters. Spermatozoa, from the store within the spermatheca, are included in the egg-capsule.

At an early stage in development some cells associated with the mesoderm are set apart as reproductive cells, and originally these have a segmental arrangement as in Annelids; at a later stage other mesoderm cells join these, some forming ova, others epithelial cells around the latter. The distinction between truly reproductive cells and associated epithelial cells, which is said to be late of appearing in some of the higher insects, is established at a very early stage in the cockroach.

Second Type of Insects.—The BRITISH HIVE-BEE (*Apis mellifica*)

This is a much more highly specialised type than the cockroach. It belongs to the order Hymenoptera.

Habits.—The Hive-Bee (*Apis mellifica*) is a native of this country, and is the species most commonly found domesticated. It is the only British representative of the genus *Apis*, and exhibits, in its most fully developed form, the social life which is foreshadowed among the Humble-Bees. As a consequence of this social life, there is much division of labour, which expresses itself alike in habit and in structure. The males (drones) take no part in the work of the colony, and are wholly reproductive; the females include the queen-bees and the workers. In the workers, which perform all the work of the hive, the reproductive organs are normally abortive and functionless. In the queens, of which there is but one adult to each hive, the enormous development of the reproductive organs seems to act as a check upon the brain and other organs, which are less developed than in the workers. The workers are further divisible into nurses, which are young and do not leave the hive, being occupied with the care of the larvæ, and the older foraging bees, which gather food for the whole colony.

In considering the relation between the life of the Hive-Bee and that of many allied forms (*Bombus*, etc.), it is important to notice that the habit of laying up stores of food material for the winter enables the colony, and not

merely an individual, to survive, and must thus have greatly assisted in the evolution of sociality.

External features.—The body shows the usual division into head, thorax, and abdomen, and varies considerably in the three different types, being smallest in the workers. It is entirely covered with hairs, some of which are sensitive, while others are used in pollen-gathering, etc.

The head bears antennæ, which are composed of a long basal and numerous smaller joints. They are marvellously sensitive, serving to communicate impressions, and also containing organs of special sense. A pair of compound eyes, largest in the drones, and three median ocelli, are also present in the head region. Of the other appendages of the head, the mandibles are in the workers very powerful, and used for many purposes connected with comb-building. In the first maxillæ the maxillary palps are aborted, and the appendage consists of an undivided lamina at each side, borne on a basal piece consisting as usual of stipes and cardo. The second pair of maxillæ form as usual the labium or so-called lower lip, and are much modified. The united basal joints form the mentum and sub-mentum. From the mentum at either side springs the long labial palp, which represents the outer fork of the typical appendage. The endopodite at each side is divided into two parts, but the inner two (lacinix) are united, much elongated, and form the tongue or ligula of the bee. The outer halves form the paraglossæ, which are closely apposed to the base of the ligula. It is the great elongation of the ligula and labial palps which especially fits the bee for nectar-gathering. The three structures can be closely apposed to one another, and then form an air-tight tube, up which, by the action of the stomach, nectar is sucked. In many of our British bees the ligula is much shorter, and more or less trowel-like in shape, and is then used largely, as in wasps, in the operation of plastering the nest. In such cases the bee can only suck those flowers

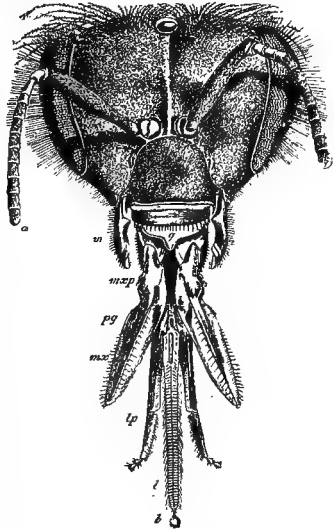

FIG. 178.—Head and mouth parts of bee.—After Cheshire.

a., Antenna; *m.*, mandible; *g.*, labrum or epipharynx; *mx.p.*, rudiment of maxillary palp; *mx.*, lamina of maxilla; *lp.*, labial palp; *l.*, ligula; *b.*, bouton at end. The paraglossæ lie concealed between the basal portions of the labial palps and the ligula.

The three structures can be closely apposed to one another, and then form an air-tight tube, up which, by the action of the stomach, nectar is sucked. In many of our British bees the ligula is much shorter, and more or less trowel-like in shape, and is then used largely, as in wasps, in the operation of plastering the nest. In such cases the bee can only suck those flowers

in which the nectar is superficial. The hive-bees and humble-bees, on the other hand, are specially modified to enable them to extract nectar from tubular flowers. When not in use, the elongated mouth-parts are folded back upon themselves, not coiled as in butterflies and moths, where there is even greater elongation.

In the queen and in the drone the mouth-parts are shorter, and are not used in honey-gathering.

The thoracic appendages consist as usual of three pairs of legs, which have the usual parts. On the first leg, at the junction of the tibia and the first tarsal joint, there is a complicated mechanism which is employed in cleaning the antennæ; this is present in all three forms, and varies with the size of the antennæ. In the workers the third leg is remarkably modified for pollen-gathering purposes. The first tarsal joint bears regular rows of stiff straight hairs on which the pollen grains are collected; they are borne to the hive in the pollen basket, placed at the back of the tibia, and furnished with numerous hairs. In queen and drone these special arrangements of hairs are absent.

The second and third thoracic segments bear each a pair of wings. These are largest in the drones and relatively smallest in the queen, who flies but seldom. At the base of each wing there is a respiratory spiracle.

In the adult queen and worker, the abdomen is divided into six segments; in the drone, into seven. There are no abdominal appendages. On the ventral surface in the worker, but not in the queen or drone, there are four pairs of wax pockets or glands, which secrete the wax, which, after mastication with saliva, is employed in building the combs. The abdomen also bears in queen and worker five pairs of spiracles, but in the drone, on account of the additional segment, there are six pairs. The total number of spiracles is thus fourteen for queen and worker, and sixteen for the drone. The posterior region of the abdomen bears the complicated sting. In the worker this consists of a hard incomplete sheath, which envelops two barbed darts. The poison flows down a channel lying between the darts and the sheath. Ramifying through the abdomen are found the two slender coiled tubes which constitute the poison gland. At the posterior end of the body these unite and open into a large poison sac. When a bee uses its sting, the chitinous sheath first pierces the skin, and then the wound is deepened by the barbed and pointed darts, while at the same time poison is steadily pumped down the channel mentioned above, and pours out by minute openings at the bases of the darts. The poison contains formic acid, and is fatal to the bee if directly introduced into its blood. Associated with the sting there are a pair of delicate tactile palps. In the queen the sting is curved and more powerful, but it is apparently only used in combat with a rival. In the worker, the sting, and with it a portion of the gut, is usually lost after use, and, in consequence, death ensues; the queen, on the other hand, can withdraw her sting from the wound with considerable ease. The sting is really an ovipositor adapted to a new function. Naturally, therefore, there is no trace of it in the drones.

Nervous system.—In the adult this exhibits considerable

fusion of parts. The supra-oesophageal ganglia are very large, and send large lateral extensions to the compound eyes. This "brain" is best developed in the active workers. The sub-oesophageal mass is formed by the fusion of three pairs of ganglia. In the thorax there are two pairs of ganglia, of which the second supplies the wings and the two last pairs of legs. In the worker there are five

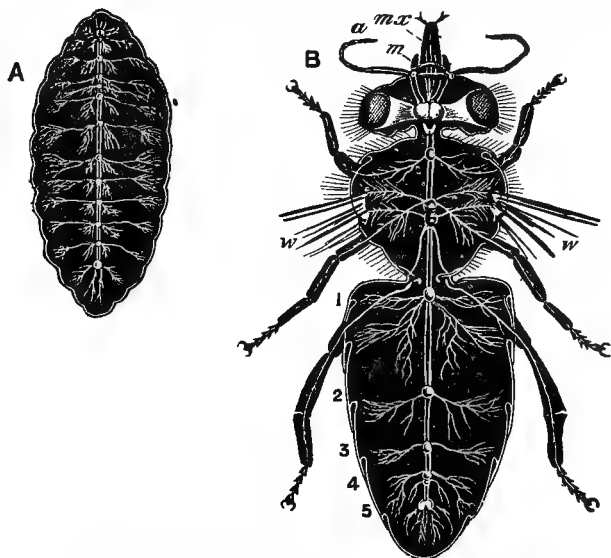

FIG. 179.—Nervous system of bee.—After Cheshire.

A, of larva. B, of adult. *a*., Antenna; *mx*., maxilla; *m*., mandible; *w*., origin of wing; 1-5, abdominal ganglia.

pairs of abdominal ganglia, but in the queen and drone only four. The sense organs are the simple and compound eyes, and the antennæ, which are furnished with numerous sensitive structures.

Alimentary system.—The œsophagus is a narrow tube which runs down the thoracic region. In the abdominal region it expands into the crop or honey-sac. The crop opens by a complicated orifice, with a remarkable stopper

arrangement, into the digestive region or chyle stomach, which is separated by a pylorus from the coiled small intestine. The inner wall of the small intestine bears numerous rows of chitinous teeth set in longitudinal ridges, and is perforated by the apertures of the excretory tubules. At the junction of the small with the large intestine there are six brownish plates, perhaps functioning as valves.

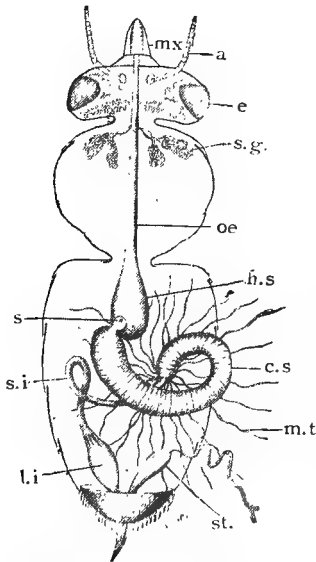

FIG. 180.—Food canal of bee.—In part after Cheshire.

mx., Maxilla; *a.*, antenna; *e.*, eye; *s.g.*, salivary glands; *oe.*, oesophagus; *h.s.*, honey-sac; *s.*, stopper; *c.s.*, chylific stomach; *m.t.*, Malpighian tubules; *s.i.*, small intestine; *l.i.*, large intestine; *st.*, sting.

In connection with the anterior region of the gut there is a very complicated series of glands. First we have, in the workers only, on either side of the head, a long coiled gland which is intracellular in type. It is largest in the so-called "nurses" which feed the young, and diminishes in size later. According to Mr. Cheshire, this gland secretes a nitrogenous fluid which is furnished to all the larvæ in their early stages, but is supplied to the future queen during the whole of the feeding period, and also during the period of egg-laying; this secretion was formerly termed "royal jelly." In addition to this pair of glands, there are in the worker three other gland systems. Of these, the second and third pairs have a common central outlet on the mentum, and secrete the saliva, which is plentifully mixed with the nectar during suction. The fourth pair is small, and the ducts open just within the mandible. The last three pairs of glands are found also in drone and queen.

The method of feeding in the bee differs considerably in the three types. In the worker, the honey sucked up from flowers is mixed with saliva, passes down the gullet into the crop, thence by the opening of the "stomach

mouth" it may reach the true stomach and so be digested, or may be carried in the crop to the hive, and there emptied into the cells by regurgitation. The pollen, which is frequently mixed with the honey, is separated from the latter by means of the stomach mouth, and is digested. Before impregnation, the queen, like the worker, feeds on pollen and honey; after it, she is always fed by the

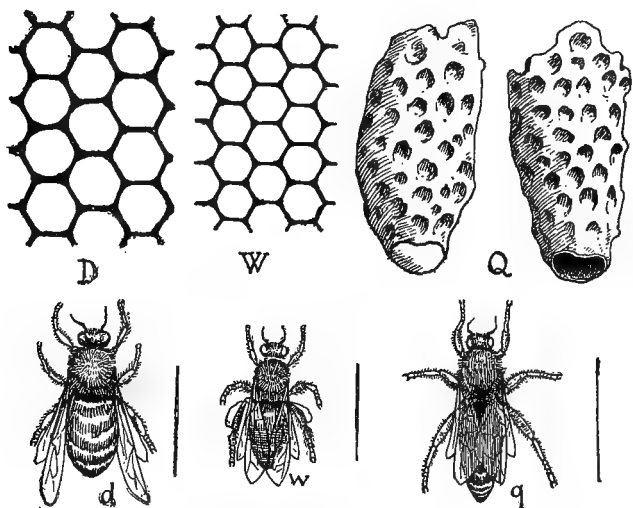

FIG. 181.—Hive-bees and the cells in which they develop.

D., Drone cells; *W.*, worker cells; *Q.*, queen cell, open and closed;
d., drone; *w.*, worker; *q.*, queen.

attendant workers. The drones, like the young workers, avail themselves of the general food-supply of the colony, and do not themselves collect honey.

Other systems.—The respiratory system is represented by the ramifying tracheal tubes. They open to the exterior by the lateral spiracles, which can be completely closed. In connection with the tracheæ there are large air-sacs.

The circulatory system is in essentials the same as that

of the cockroach. The blood contains a few nucleated amœboid corpuscles.

The excretory system consists of numerous fine Malpighian tubules which open into the small intestine.

Reproductive system.—In the drone the reproductive organs consist of a pair of testes, each furnished with a narrow vas deferens, expanding at its distal end into a seminal vesicle. The seminal vesicles open into the ejaculatory duct, and at their junction a large paired mucus gland opens. When maturity is reached, the testes diminish in size, while the spermatozoa accumulate in the terminal expanded part of the ejaculatory duct, and there become aggregated into a compact spermatophore. With the terminal portion of the male duct copulatory organs are associated.

Mating takes place only once in the life of the queen, and is followed by the death of the drone.

In the queen the large ovaries occupy considerable space in the abdominal region. As usual, each consists of numerous (100–150) ovarian tubes, containing ova in various stages of maturity. The ovarian tubes open into the right and left oviducts, which again unite to form the common oviduct. With the anterior portion of the common duct the globular spermatheca is associated. In connection with it there is a gland corresponding to the mucus gland of the male. The oviduct terminates in a copulatory pouch.

Previous to laying, the eggs are fertilised by sperms set free from the spermatheca. In the case of drone eggs, this liberation of spermatozoa does not take place, and the eggs in consequence are parthenogenetic. Queens which have never mated, or which have exhausted their stock of male elements, habitually lay drone eggs, but those which are laying abundant fertilised eggs at times also lay unfertilised eggs. This withholding of spermatozoa is said to be “voluntary,” and related to the needs of the colony, but the physiological reason is unknown.

The workers possess female organs similar in type to those of the queen, but of an extremely rudimentary nature.

The eggs are laid singly in the cells of the comb, at the rate of about two per minute, for weeks together. They are of the usual insect type. According to the size of the cell in which it is deposited, and the food with which it is furnished, the fertilised ovum develops into a worker or into a queen. The development takes place within the cell, and includes a complete metamorphosis.

CLASSIFICATION OF INSECTS

- I. Primitive wingless insects, Apterygota or Aptera, including Thysanura, *e.g.* *Machilis*, *Camptodea*, *Lepisma*; Collembola, Springtails, *e.g.* *Podura*, *Smynthurus*.
- II. Winged insects, Pterygota (in some degenerate forms the wings have been lost).
- A. With mouth-parts usually adapted throughout life for biting (Menognathous), with no metamorphosis (Ametabolic) or with incomplete metamorphosis (Henimetabolic).
e.g. Orthoptera (cockroach, locust, cricket, etc.); Corrodentia (Termites, bird-lice); Odonata (Dragon-flies); Ephemera (May-flies); and Dermaptera (Earwigs).
- B. With mouth-parts adapted in the main as suctorial organs (Menorhynchous), usually with no metamorphosis (Ametabolic).
e.g. Rhynchota or Hemiptera, *e.g.* Phylloxera, aphides, coccus insects; Cicadas; bugs; water-scorpions, lice.
- C. With complete metamorphosis (Holometabolic), with mouth-parts always adapted for biting (Menognathous), or adapted at first for biting and afterwards for sucking (Metagnathous).
e.g. Coleoptera (beetles); Diptera (two-winged flies); Lepidoptera (butterflies and moths); Hymenoptera (ants, bees, and wasps).

GENERAL NOTES ON INSECTS

The main characteristics of insects have already been described in the two types chosen, but we here revise them in general terms.

Form.—The body of an adult insect may be divided into three distinct regions:—

1. The head, probably consisting of seven fused segments.
2. The median thorax, divided into pro-, meso-, and meta-thoracic segments, each with a pair of legs, the last two often with wings.
3. The abdomen, usually with ten to eleven segments, with never more than transformed traces of appendages.

Within these limits there is great variety of form, *e.g.* the long dragon-fly with its large outspread wings, the compact cockchafer, the thin-waisted wasps and long-bodied butterflies, the house-fly and cricket, the large moths and beetles, and the almost invisible insect parasites.

Appendages.—Insects feel their way, test food, and apparently communicate impressions to one another, by means of the antennæ. Then follow the mandibles, first

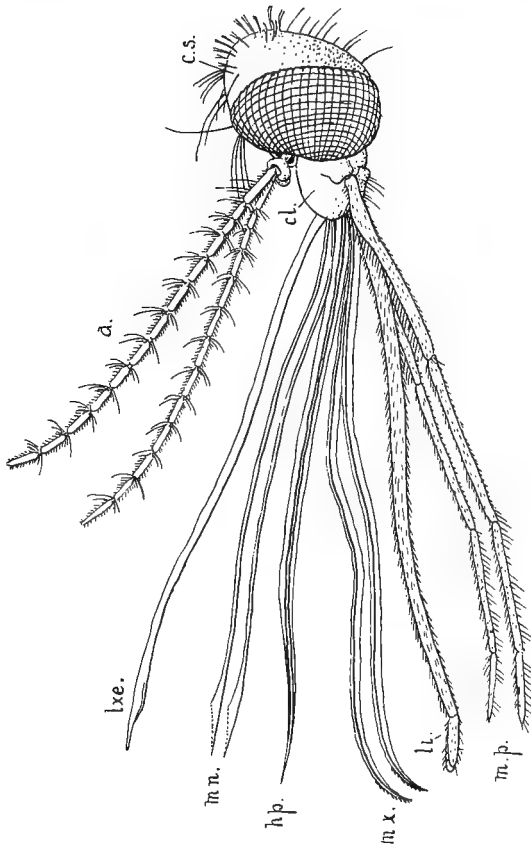

FIG. 182.—Mouth-parts of mosquito.—After Nuttall and Shipley.

a., Antennæ; *lxe.*, labrum and epipharynx; *m.n.*, mandibles; *h.p.*, hypopharynx; *m.x.*, first maxillæ; *li.*, labium; *m.p.*, maxillary palps; *cl.*, clypeus; *cs.*, head scales.

maxillæ, and second maxillæ, on the head; the three pairs of legs on the thorax; and sometimes vestiges of legs on the abdomen.

It was a step of some importance in morphology when Savigny showed that the three pairs of appendages about the mouth are homologous with the other appendages, *i.e.* are masticatory legs.

(1) Farthest forward lie two *mandibles*, the biting and cutting jaws. These are single-jointed, and thus differ from the organs of the same name in the crayfish, which bear a three-jointed palp in addition to the hard basal part. In those insects which suck and do not bite, *e.g.* adult butterflies, the mandibles are reduced.

(2) Next in order is the *first pair of maxillæ*. Each maxilla consists of a basal piece (protopodite), an inner fork (endopodite), and an outer fork (exopodite). The entomologists divide the protopodite into a lower joint, the *cardo*, and an upper, the *stipes*; the endopodite into an internal *lacinia* and an external *galea*; while the exopodite is called the *maxillary palp*.

(3) The last pair of oral appendages or *second maxillæ* are partially fused, and form what is called the *labium*. The lower and upper joints of their fused protopodites are called *submentum* and *mentum*; the endopodites on each side are double, as in the first maxillæ, and consist of internal *lacinia* and external *paraglossa*; the exopodites are called the *labial palps*.

The three pairs of thoracic legs consist of many joints, are usually clawed and hairy at their tips, and differ greatly according to their uses, as may be seen by comparing, for instance, the hairy feet by aid of which the fly runs up the smooth window-pane, the muscular limbs of grasshoppers, the lank length of those which characterise "daddy-long-legs," the bees' legs with their pollen baskets, the oars of water-beetles.

Wings.—These arise as flattened hollow sacs, which grow out from the two posterior segments of the thorax. They are moved by muscles, and traversed by "veins" or "nervures," which include air-tubes, nerves, and vessel-like continuations of the body cavity. Most insects have two pairs, but many sluggish females and parasites, like lice and fleas, have lost them. On the other hand, there is no reason to believe that the very simplest wingless insects, known as Collembola and Thysanura, ever had wings.

There are many interesting differences in regard to wings in the various orders of Insects. Thus in beetles the front pair form wing-covers or elytra; in the little bee parasites—Strepsiptera—they are twisted rudiments; in flies the posterior pair are small knobbed stalks (halteres or balancers); in bees the wings on each side are hooked together. When the insect is at rest, the wings are usually folded neatly on the back; but dragon-flies and others keep them expanded; butterflies raise them like a single sail on the back; moths keep them flat. Many wings bear small scales or hairs, and are often brightly coloured. It is well known that the colours also vary with sex, climate, and surroundings. Most interesting are those cases in which the colours of an insect harmonise exactly with those of its habitat, or make it a mimetic copy of some more successfully protected neighbour.

As to the origin of wings, it may be mentioned that in many cases they are of some use in respiration as well as in locomotion, and the theory seems plausible that wings were originally respiratory outgrowths, which by and by became useful for aerial locomotion. New organs seem often to have arisen by the predominance of some new function in organs which had some prior significance. Moreover, we can fancy that an increase in respiratory efficiency brought about by the outgrowths in question would quicken the whole life, and would tend to raise insects into the air, just as terrestrial insects can be made to frisk and jump when placed in a vessel with relatively more oxygen than there is in the atmosphere. Finally, we must note that the aquatic larvæ of some insects, *e.g.* may-flies, have a series of respiratory outgrowths from the sides of the abdomen, the so-called "tracheal gills," which in origin and appearance are like young wings (Fig. 183).

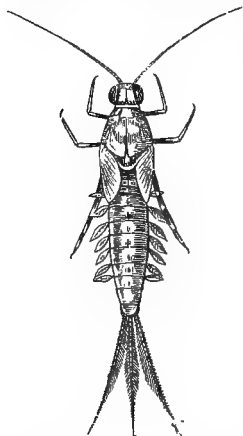

FIG. 183.—Young may-fly or ephemeropterid.—After Eaton. Showing tracheal gills, and wings appearing in front of them.

Insects excel in locomotion. "They walk, run, and jump with the quadrupeds; they fly with the birds; they glide with the serpents, and they swim with the fish." They beat the elastic air with their wings, and though there cannot be so much complexity of movement as in birds where the individual feathers move, the insect wing is no rigid plate, and its up-and-down motions are complex. They can soar rapidly, but their lightness often makes horizontal steering difficult. The wind often helps as well as hinders them; thus

the insects which fly in and out of the windows of express trains are probably in part sucked along. Marey calculates the approximate number of wing strokes per second at 330 for the fly, 240 for the humble-bee, 190 for the hive-bee, 110 for the wasp, 28 for the dragon-fly, 9 for a butterfly. For short distances a bee can outfly a pigeon.

Skin.—As in other Arthropods, the epidermis (or hypodermis) of Insects forms a firm cuticle of chitin, which in the exigencies of growth has sometimes to be moulted. This cuticle is often finely marked, so that the animal seems iridescent; and there are many different kinds of scales,

hairs, and spines. Chitin is not favourable to the development of skin glands. Most insects have "salivary glands" opening in or near the mouth. Bees have wax-making glands opening on the abdomen; aphides have glandular tubes; not a few have poison bags; and many larvæ besides silkworms have organs from which are exuded the threads of which a cocoon is made.

Muscular system.—In very active animals like Insects, we of course find a highly developed set of rapidly contracting striped muscles. These work the wings, the legs, and the jaws. The resulting movements have this further significance, that they help in the respiratory interchange of gases, and in the circulation of the blood.

Nervous system.—As in other Arthropods, the nervous system consists—(a) of a dorsal brain or supra-oesophageal ganglionic mass, and (b) of a double ventral nerve-cord with a number of paired ganglia, of which the most anterior (the sub-oesophageal) are linked to the brain by a ring commissure around the gullet; and (c) of nerves given off from the various ganglia to the sense organs, the alimentary canal, and the other organs. In many of the higher insects the ganglia of the ventral nerve-cord are in some degree concentrated, and in the adults are usually more centralised than in the larvæ.

Sensory structures.—Animals so much alive as Insects, and in surroundings so stimulating as many of them enjoy, have naturally highly-developed sense organs.

Two compound eyes are present on the head of all adults except the primitive Collembola, the degenerate lice, the likewise parasitic fleas, and blind insects which live in caves or other dark places. Each eye contains a large number of similar elements, in each of which we can distinguish—(1) a cuticular or corneal facet; (2) a glassy lens-like portion; (3) a retinal portion in association with which are fibres from the optic nerve; and there are also pigmented cells between the elements.

In addition to the compound eyes, simple eyes or ocelli are present in the adults of many insects, *e.g.* ants, bees, and wasps; they occur without the accompaniment of compound eyes in Collembola, lice, and fleas, and they are usually the only eyes possessed by larvæ. They have only

one lens (monomeniscous), whereas the compound forms have many lenses (polymeniscous). In the simple eye each retinal unit is a single cell, of which the distal part is unpigmented. In the compound eye the retinal unit consists of six cells around an axis. The structure of ocelli varies greatly, and their use is very uncertain.

Auditory (or chordotonal) organs have been found in all orders of Insects (except as yet the Thysanoptera), and occur both in the larvæ and in the adults. Their essential structure is as follows:—A nerve ends in a centre or ganglion near the skin; some of the cells of this ganglion grow out into long sensitive rods enclosed in a tiny sheath; the rods are directly or indirectly connected with the epidermis above them. "They are found in groups of 2-200 in various parts of the body, antennæ, palps, legs, wings, in the halteres of Diptera, and upon the dorsal aspect of the abdomen." Quite different from these, and occurring in flies alone, on the hind end of the larva, or at the base of the adult's feelers, are little bags with fluid in which clear globules float.

In addition to the "eyes" and "ears," there are innervated hairs (tactile, tasting, olfactory) on the antennæ and mouth-parts of many insects. Not a few insects seem to possess a diffuse or dermatoptic sense, by which, for instance, they can, when blinded, find their way out of a dark box.

Many Insects produce sounds. We hear the whirr of rapidly moving wings in flies; the buzz of leaf-like structures near the openings of the air-tubes in many Hymenoptera; the scraping of legs against wing ribs in grasshoppers; the chirping of male crickets, which rub one wing against its neighbour; the piping of male Cicadas, which have a complex musical instrument; the voice of the death's-head moth, which expels air forcibly from its mouth. The death-watch taps with its head on wooden objects, as if knocking at the door behind which his mate may be hidden. In some cases the sounds are simply automatic reflexes of activity; in many cases they serve as alluring love calls; and they may also serve as expressions of fear and anger, or as warning alarms.

In the case of hive-bees there is definite evidence of a sense of direction. They return straight to the hive from a distance of over a mile, even when they have been blinded and robbed of antennæ, even when they have been carried afield in a box.

Alimentary system.—The diet of Insects is very varied. Some, such as locusts, are vegetarian, and destroy our crops; others are carnivorous (we need not specify the homœopathist's leech), and suck the blood of living victims, or devour the dead; the bees flit in search of nectar from flower to flower, while the ant-lion lurks in his pit of sand for any unwary stumbler; the termites gnaw decaying wood; some ants keep aphides as cows ("vaccæ formicarum," Linnæus called them), whose sweet juices they

lick ; and a great number of larvæ devour the flesh and vegetables in which they are hatched.

Many modifications of mouth organs, and of the alimentary canal, are associated with the way in which the insect feeds.

The alimentary canal consists of fore-gut, mid-gut, and hind-gut, but in many cases it seems very doubtful if the mid-gut has its typically endodermic character.

The fore-gut conducts food, and includes mouth cavity, pharynx, and œsophagus, the latter being often swollen into a storing crop, or continued into a muscular gizzard with grinding plates of chitin.

The mid-gut is digestive and absorptive, often bearing a number of glandular outgrowths or cæca, and varies in length (in beetles at least) in inverse proportion to the nutritive and digestible quality of the food.

The hind-gut is said to be partly absorptive, but is chiefly a conducting intestine, often coiled and terminally expanded into a rectum with which glands are frequently associated.

In association with the alimentary canal are various glands :—

(a) The salivary glands, which open in or near the mouth. They are usually paired on each side, and provided with a reservoir. They arise as invaginations of the ectoderm near the mouth. Their secretion is mainly diastatic in function, *i.e.* it changes starchy material into sugar by means of a ferment. Along with these may be ranked the “spinning glands” of caterpillars, etc., which also open at the mouth. They secrete material which hardens into the threads used for the cocoon.

(b) From the beginning of the mid-gut blind outgrowths sometimes arise (in some Orthoptera, etc.), which are apparently digestive. They are sometimes called pyloric cæca. In other cases (some beetles) there may be more numerous and smaller glandular outgrowths resembling villi in appearance.

Respiratory system.—The body of an insect is traversed by a system of air-tubes (tracheæ), which open laterally by special apertures (stigmata), and by means of numerous branches conduct the air to all the recesses of the tissues. In animals which breathe by gills or lungs the blood is carried to the air ; in insects the air permeates the whole body. But how does the air pass in and out ? In part, no doubt, there is a slow diffusion ; in part the movements of the wings and legs will help ; but there are also special

expiratory muscles. We see their action when we watch a drone-fly panting on a flower. Inspiration is passive, as in birds, and depends on the elasticity of the skin and of the tracheal walls; expiration is active, and depends upon these muscles. They are chiefly situated in the abdomen, but in some beetles (at least) they are also present in the metathorax.

The tracheæ seem to arise as tubular ingrowths of skin, and, primitively, each segment probably contained a distinct pair; but their number has been reduced, and they are often in part connected into a system. With the doubtful exception of one of the primitive Collembola, and the certain exception of caterpillars, no insects have any tracheal openings in the head region. There are rarely more than two pairs in the thorax; there are often six to eight pairs in the abdomen; the maximum total is ten pairs. Each trachea is kept tense throughout the greater part of its course by internal chitinous thickenings, which apparently have a spiral course. The branches of the tracheæ penetrate into all the organs of the body, carrying oxygen to every part. The very efficient respiration of insects must be kept in mind in an appreciation of the general activity of their life.

As the conditions of larval life are often different from those of the adult insects, the mode of respiration may also differ in details.

In insects without marked metamorphosis, and even in some beetles in which the metamorphosis is complete, the young insect and the adult both breathe by tracheæ with open stigmata. Both are said to be "holopneustic."

When the larvæ live in water, the tracheal system is closed, otherwise the creatures would drown. This closed condition is termed "apneustic." These larvæ (of dragon-flies, may-flies, and some others) breathe by "tracheal gills" (see Fig. 183)—little wing-like outgrowths from the sides of the abdomen, rich in tracheæ—or by tracheal folds within the rectum, in and out of which water flows. In either case, an interchange of gases between the tracheæ and the water takes place. In adult aerial life the tracheæ of the body acquire stigmata, and the insect becomes "holopneustic."

In most insects with complete metamorphosis, the larva (*e.g.* caterpillar or grub) has closed stigmata on the last two segments of the thorax (those which will bear wings), but there is a pair of open stigmata on the prothorax. In the adult the reverse is the case.

There are some other modifications—for instance, what obtains in the parasitic larvæ of some flies, *e.g.* gadflies. In these the stigmata are open only at the end of the body. In all cases, however, the stigmata of the adult are already present as rudiments in the larva, though they may not open till adolescence is over.

Circulatory system.—As the respiratory system is very efficient, air passing into the inmost recesses of the body, it is natural that the blood-vascular system should not be highly developed. Within a dorsal part of the body cavity, known as the pericardium, the heart lies, swayed by special muscles. It is a long tube, usually confined to the abdomen, and with eight chambers, with paired valvular openings on its sides, through which blood enters from the pericardium. The blood is driven forwards, the posterior end of the heart being closed, and there is usually an anterior aorta or main blood vessel. But, for the most part, the blood circulates in spaces within what is commonly called the body cavity. Such a circulation is often described as lacunar. The blood may be colourless, yellow, red, or even greenish, and, in some cases, hæmoglobin, the characteristic blood pigment of Vertebrates, has been detected. The cells of the blood are amœboid.

Body cavity.—It is necessary to distinguish the primitive cœlom from the apparent body cavity of the adult. In discussing the development of *Peripatus*, Sedgwick notes the following characteristics of a true cœlom :—It is a cavity which—(1) does not communicate with the vascular system ; (2) does communicate by nephridial pores with the exterior ; (3) has the reproductive elements developed on its lining ; (4) develops either as one or more diverticula from the primitive enteron (or gut), or as a space or spaces in the unsegmented or segmented mesoderm. Now, in Arthropods the apparent body cavity of the adult is not a true cœlom : it consists of a set of secondarily derived vascular spaces ; it has been called a pseudocœl or a hæmocœl. The true cœlom of Arthropods is very much restricted in the adult.

The apparent body cavity in which the organs lie, and in which the blood circulates, is well developed in Insects. It includes, *inter alia*, a peculiar fatty tissue, which seems to be a store of reserve material, which is especially large in young insects before metamorphosis, and is also interesting as one of the seats of “ phosphorescence.”

Excretory system.—Although no structures certainly homologous with nephridia have yet been demonstrated in Insects, the excretory system is well developed. From the hind-gut (proctodæum), and therefore of ectodermic origin, arise fine tubes, or in some cases solid threads, which extend into the apparent body cavity. Their number varies from two (in some Lepidoptera, for instance) to one hundred and fifty (in the bee). They twine about the organs in the abdominal cavity, and their excretory significance is inferred from the fact that they contain uric acid.

Reproductive system.—Among Insects the sexes are always separate and often different in appearance. The males are more active, smaller, and more brightly coloured than the females. Darwin referred the greater decorative-ness of the males to the sexual selection exercised by the females. The handsomer variations succeeded in courtship better than their rivals. Wallace referred the greater plain-ness of females to the elimination of the disadvantageously conspicuous in the course of natural selection. There may be truth in both views, but both require to be supplemented by the consideration, in part accepted by Wallace, that the “secondary sexual characters” of both sexes are the natural and necessary expressions of their respectively dominant constitutions.

The organs consist of:—

MALE.	FEMALE.
The paired testes, usually formed of many small tubes.	The paired ovaries, usually formed of many small tubes (ovarioles).
Two ducts (<i>vasa deferentia</i>) conducting spermatozoa (perhaps in part comparable to nephridia).	Two ducts (oviducts) conducting the ova (perhaps in part comparable to nephridia).
An unpaired terminal and ejaculatory duct, paired and with two apertures in Ephemeroidea only; sometimes formed by a union of the <i>vasa deferentia</i> , sometimes by an external invagination meeting the <i>vasa deferentia</i> .	An unpaired terminal region or vagina, paired and with two apertures in Ephemeroidea; usually formed from an external invagination meeting the united ends of the oviducts.
From the <i>vasa deferentia</i> or from the ejaculatory duct, opens a paired or unpaired seminal vesicle for spermatozoa.	Near or from the vagina, opens a receptaculum seminis for storing spermatozoa received from a male during copulation.
Various accessory glands, whose secretion sometimes unites the spermatozoa into packets or spermatophores.	Various accessory glands, <i>e.g.</i> those which secrete the material surrounding the eggs.
Sometimes a copulatory penis.	Sometimes a special bursa copulatrix in the vagina.
Often external hard pieces.	Often external hard pieces, <i>e.g.</i> , ovipositor.

Some peculiarities in reproduction.—Many Insects, such as aphides, silk-moth, and queen-bee, are exceedingly prolific. The queen termite lays thousands of eggs, “at the rate of about sixty per minute”!

The store of spermatozoa received by the female, and kept within the receptaculum seminis, often lasts for a long time,—for two or three years in some queen-bees.

Parthenogenesis, or the development of ova which are unfertilised, occurs normally, for a variable number of generations, in two Lepidoptera and one beetle, in some coccus insects and aphides, and in certain saw-flies and gall-wasps. It occurs casually in the silk-moth and several other Lepidoptera, seasonally in aphides, in larval life in some flies (*Miastor*, *Chironomus*), and partially or “voluntarily” when the queen-bee lays eggs which become drones.

A few insects hatch their young within the body, or are “viviparous.” This is the case with parthenogenetic summer aphides, a few flies, the little bee parasites Strepsiptera, a few beetles and cockroaches.

Development of the ovum.—The tubes which compose the ovaries and lead into the oviducts begin as thin filaments, the ends of which are usually connected on each side. These thin filaments consist of indifferent germinal cells, all of them potential ova, and of mesodermic epithelial cells, which form the ovarian tubes, etc., and are connected anteriorly to the pericardial wall.

But in most cases only a minority of these cells become ova, the others become nutritive cells which are absorbed by the ova, and follicle cells which line the walls of the ovarian tubes and help to furnish the egg-shells.

There may be, indeed, ovarian tubes without nutritive cells (*e.g.* in Orthoptera), and then each tube is simply a bead-like row of ova, which become larger and larger as they recede from the thin terminal filaments and approach the oviducts. In other cases the bead-like row consists of ova alternating with clumps of nutritive cells (*e.g.* in Hymenoptera and Lepidoptera). In other cases the nutritive cells mostly remain in the terminal region, but their products pass down to the receding ova.

As there are numerous ovarian tubes in each ovary, and as the same process of oogenesis is going on in each, numerous eggs are ready for liberation at the same time, and are simultaneously discharged into the oviduct of each side.

The eggs are large and contain much yolk. In relatively

few cases yolk is almost absent, as, for example, in the summer eggs of the Aphides, which are hatched within the body, and in some forms where the young are endoparasitic. The ovum is surrounded by a vitelline membrane, and also by a firm chitinous shell, secreted by the follicular cells, which is often sculptured in a characteristic manner. This shell is pierced by one or more minute holes (micropyles). Through a micropyle the spermatozoon finds entrance,

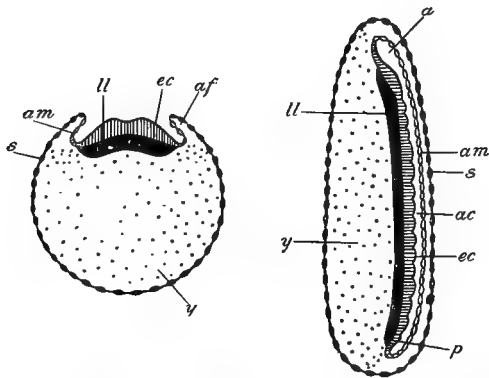

FIG. 184.—Diagrams of Insect embryo.—After Korschelt and Heider.

A transverse section before the union of the amnion folds, and a longitudinal median section after the union of the folds. *a.*, Anterior end of blastoderm; *p.*, posterior end of blastoderm; *af.*, in the left-hand figure, the beginning of the amnion fold; *am.*, amnion; *a.c.*, amniotic cavity; *s.*, serosa; *ec.*, ectoderm; *ll.*, lower germinal layer; *y.*, yolk. The amniotic cavity marks the future ventral region of the embryo, so that the yolk mass dorsal.

sometimes (as in the cockroach) after moving round and round the shell in varying orbits.

The ripe egg usually consists of a central yolk-containing mass, surrounded by a thin sheath of protoplasm. As is usual in Arthropods, the segmentation is peripheral or centrolecithal. The central nucleus divides up into several nuclei, which, being united by protoplasmic cords, form for a time a central syncytium. Later, these nuclei emigrate into the peripheral protoplasm, which segments around them; thus a peripheral layer of similar epithelial cells is formed. Some of the nuclei

may be left behind in the central yolk to form the yolk nuclei, or, what is probably the more primitive condition, these are formed by subsequent immigration from the blastoderm.

The next process is the appearance of differentiation among the similar cells of the blastoderm. Over a special area—the ventral plate—(cf. *Astacus*) the cells increase in number and become cylindrical in shape; over the rest of the egg the cells flatten out and become much thinner. In the middle of the ventral plate a slight groove is formed by rapid multiplication of the cylindrical cells. This represents the disguised gastrulation, the open roof of the groove being the much-elongated blastopore. The surrounding cylindrical cells unite over this open roof, the groove usually flattens out, and thus we have formed a two-layered germinal streak which spreads forwards and backwards over the egg, and early exhibits externally transverse division into segments. The upper layer is the ectoderm; the lower includes the rudiments of both mesoderm and endoderm.

Meanwhile another very important event has taken place. We saw that while the cells of the ventral plate increased in depth, the remaining cells flattened out laterally; at the point where the two kinds of cells unite, on either side of the ventral plate, a double fold arises. The two folds unite over the surface of the ventral plate, forming a membranous arch over it. The internal fold is called “amniotic,” the outer “serous,” from their resemblance to the similar envelopes in the embryos of higher vertebrates. The folds take no direct part in the development of the embryo.

We must now return to the germinal streak. The gastrula groove may persist as a tube after closure of the blastopore, but it is usually compressed by the ectoderm, or never exists as a distinct cavity. The greater part of the lower stratum of the germinal streak consists of mesoderm. This becomes divided into successive segments at each side, each containing a primitive coelomic cavity, perhaps continuous with the gastrula cavity. The endoderm arises as paired clusters of cells, found only at the anterior and posterior ends of the primitive streak. These clusters increase rapidly and form long endodermal streaks, which curve downwards so as to enclose the yolk. The streaks meet and fuse, first ventrally and later dorsally, thus constituting the mid-gut. The yolk nuclei previously mentioned have meanwhile increased rapidly, forming yolk cells which absorb the yolk. These cells are included in the endodermic mid-gut, and there break up. As the endoderm grows round the yolk, it is accompanied by a layer (splanchnic) of the mesoblast. Fore- and hind-gut are formed by invaginations which fuse with the mid-gut.

In the later stages of development the primitive coelomic pouches lose their cross partitions, become filled with mesenchyme cells, and practically obliterated. The body cavity of the adult is formed by the appearance of lacunæ amid the cells of the mesenchyme.

The tracheæ arise as segmentally repeated invaginations of the ectoderm. The openings of the invaginations form the stigmata. From the hind-gut arise the Malpighian tubules, which are therefore ectodermic. The development of the other organs is similar to that of the Crustacea.

In summarising the development of Insecta, one must specially note the peripheral segmentation, the formation of the two-layered germinal streak, the presence of an over-arching blastodermic fold, the segmentation of the mesoderm, and the formation of the mid-gut by the union of endodermic bands.

Metamorphosis of Insects.—(1) In the lowest Insects, namely, in the old-fashioned wingless Thysanura and Collembola, the hatched young are miniatures of the adults. By gradual growth, and after several moultings, they attain adult size.

Similarly, the newly hatched earwigs, young of cockroaches and locusts, of lice, aphides, termites, and bugs, are very like the parents, except that they are sexually immature, and that there are no wings, which indeed are absent from some of the adults.

These insects are called *ametabolic*, *i.e.* they have no marked change or metamorphosis.

(2) In cicadas there are slight but most instructive differences between larvæ and adults. The adults live among herbage, the young on the ground, and the diversity of habit has associated differences of structure, as in the burrowing fore-legs of the larva. Moreover, the larva acquires the characters of an adult after a quiescent period of pupation.

The differences between larva and adult are more striking in may-flies, dragon-flies, and the related Plecoptera (*e.g.* *Perla*), for in these the larvæ are aquatic, with closed respiratory apertures, and with tracheal gills or folds, while the adults are winged and aerial, and breathe by open tracheæ.

These insects are called *hemimetabolic*, *i.e.* they have a partial or incomplete metamorphosis.

(3) Very different is the life history of all other sets of Insects—ant-lions, caddis-flies, flies, fleas, butterflies and moths, beetles, ants, and bees. From the egg there is hatched a larva (maggot, grub, or caterpillar), which lives a life very different from the adult, and is altogether unlike it in form. The larva feeds voraciously, grows, rests, and moults. Having accumulated a rich store of reserve material in its "fatty body," it finally becomes for some

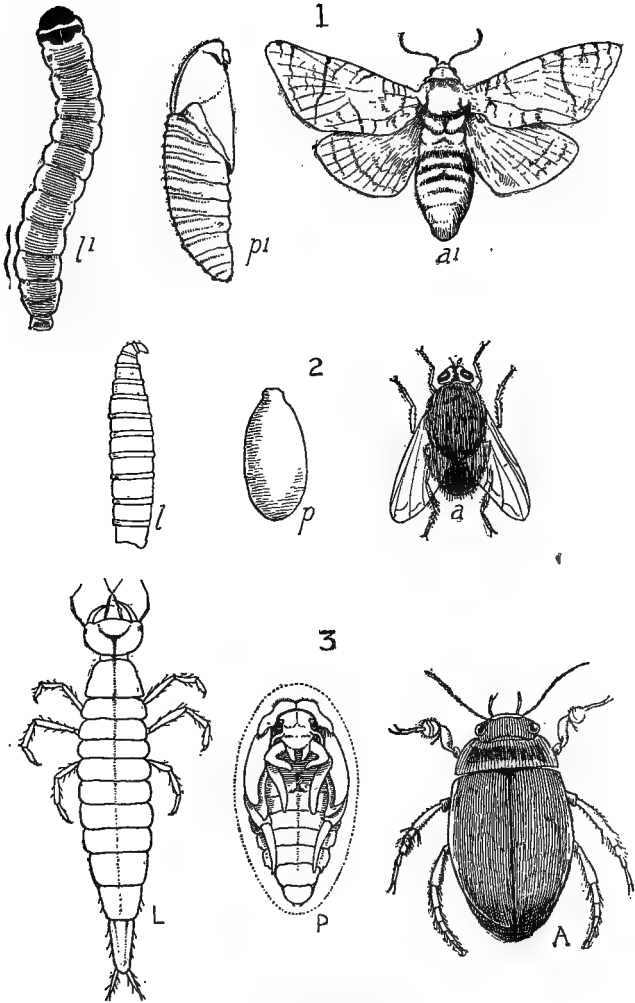

FIG. 185.—Life histories of Insects.

L., *P.*, and *A.*, larva, pupa, and adult respectively of water-beetle (*Dytiscus marginalis*); *L.*, *p.*, *a.*, larva, pupa, and adult of blue-bottle fly (*Musca vomitoria*); *l.*, *p.*, *a.*, larva, pupa, and adult of *Cossus ligniperda*.

time quiescent, as a pupa, nymph, or chrysalis, often within the shelter of a cocoon. During this period there are great transformations; wings bud out, appendages of the adult pattern are formed, reconstruction of other organs is effected. Finally, out of the pupal husk emerges a miniature winged insect of the adult or imago type.

These insects are called *holometabolic*, *i.e.* they exhibit a complete metamorphosis.

Two kinds of larvæ occur among insects. (*a*) In many ametabolic and hemimetabolic forms the larva is somewhat like one of the lowly Thysanuran insects (*Campodea*), and is

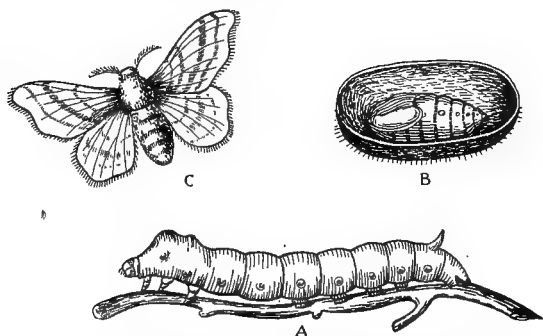

FIG. 186.—Life history of the silk-moth (*Bombyx mori*).

A, caterpillar; B, pupa; C, imago; the cocoon is cut open to show the pupa lying within. In the caterpillar note the three pairs of true legs in the anterior region, and the four pairs of pro-legs in the posterior region.

therefore called campodeiform. It has the regions of the body well defined, three pairs of locomotor thoracic limbs, and mouth-parts adapted for suction. (*b*) The other type is worm-like or eruciform, *e.g.* the caterpillars of Lepidoptera (Fig. 186, A), with distinct head and limbs; the more modified grubs of bees, etc., with distinct head, but without limbs; and the degenerate maggots of flies (Fig. 187, A), etc., not only limbless, but with an ill-defined head. A typical caterpillar has a cylindrical body often "hairy," a distinct hard head, simple eyes, small antennæ, mouth-parts suited for biting, three pairs of jointed clawed thoracic limbs (corre-

sponding to those of the butterfly), and four or five pairs of unjointed clasping abdominal "pro-legs." Other abdominal appendages are known on the larvæ of other insects, and even in the embryos of some whose larvæ are campodeiform. These facts make it likely that the primitive form had many legs.

The larvæ of Insects vary enormously in habit and in structure, and exhibit numerous adaptations to conditions of life very different from those of the parent. Thus caterpillars, which are usually plump and

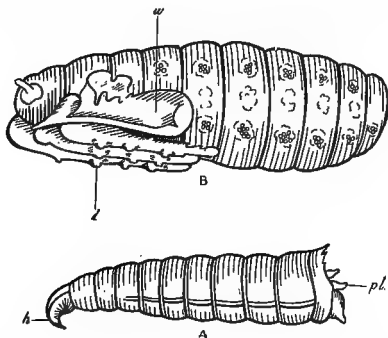

FIG. 187.—Development of blow-fly (*Calliphora erythrocephala*).
—After Thompson Lowne.

The lower figure (A) shows the adult larva (maggot). Note, as compared with the caterpillar, the absence of appendages, except those about the mouth; *h.*, the large hooks connected with the maxillæ; *pl.*, pro-legs.

The upper figure (B) shows the pronymph removed from the pupa-case. In the abdominal region the imaginal discs are shown; *l.*, rudiments of legs; *w.*, of wings.

tense, so that a peck from a bird's bill may cause them to bleed to death, even if no immediate destruction befall them, are protectively adapted in many different ways. Their colours are often changed in harmony with those of their surroundings; some palatable forms are saved by their superficial resemblance to those which are nauseous; a few strike "terrifying attitudes"; while others are like pieces of plants.

Internal metamorphosis.—In Insects with no marked metamorphosis, or with merely an incomplete one, the organs of the larvæ develop gradually into those of the adult. But in Insects with complete metamorphosis there

is a marvellous internal reconstruction during the later larval, and especially during the quiescent pupal stage. The more specialised larval organs are disrupted, their débris being used in building new structures. In some cases, such as flies, phagocytes play a very important part in this metamorphosis; in other cases there is no true phagocytosis. Parts of larval organs which have not been highly specialised form the foundations of new adult structures. Of special importance are certain ingrowths of the larval skin (the epi- or hypo-dermis) which form what are called "imaginal discs," *i.e.* embryonic or germinal areas, from which arise the wings, legs, etc., of the adult insect. The reconstruction is very thorough; most of the musculature, much of the tracheal system, part of the mid-gut, etc., are gradually replaced by the corresponding organs of the adult. There is first a disruptive process of histolysis, and then a reconstructive process of histogenesis. Yet in most cases the disruption and replacement of organs is very gradual.

Ecology.—The average insect is active, but between orders (*e.g.* ants, bees, and wasps *versus* aphides, coccus insects, and bugs), between nearly related families, between the sexes (*e.g.* male and female cochineal insect), between caterpillar and pupa, we read the constantly recurrent antithesis between activity and passivity.

The average length of life is short. Queen-bees of five years, queen-ants aged thirteen, are rare exceptions. In many cases death follows as the rapid nemesis of reproduction. But though the adult life is often very short, the total life may be of considerable length, as in some Ephemeroidea, which in their adult life of winged love-making may be literally the flies of a day, while their aquatic larval stages may have lived for two years or more.

The relation between the annual appearance of certain insects and that of the plants which they visit, the habits of hibernation in the adult or larval state, the occasional "dimorphism" between winter and summer broods of butterflies, should be noticed.

The prolific multiplication of many insects may lead to local and periodic increase in their numbers, but great increase is limited by the food-supply and the weather, by

the warfare between insects of different kinds, by the numerous insects parasitic on others, by the appetite of higher animals,—fishes, frogs, ant-eaters, insectivores, and, above all, birds.

There is a great variety of protective adaptation. The young of caddis-flies are partially masked by their external cases of pebbles and fragments of stem; many caterpillars and adult insects harmonise with the colour of their environment; leaf-insects, “walking sticks,” moss-insects, scale-insects, have a precise resemblance to external objects which must often save them; a humming-bird moth may resemble a humming-bird; many palatable insects and larvæ have a mimetic resemblance to others which are nauseous or otherwise little likely to be meddled with. Many insects may be saved by their hard chitinous armour, by their disgusting odour or taste, by their deterrent discharges of repulsive formic acid, etc., by simulation of death, by active resistance with effective weapons.

Many flowers depend for cross-fertilisation upon insects, which carry the pollen from one to another. Many insects depend for food on the nectar and pollen of flowers. Thus many flowers and insects are mutually dependent. But many insects injure plants, and many plants exhibit structures which tend to save them from attack. On the other hand, there may be “partnerships” between insects and plants—as in the “myrmecophilous” (ant-loving) plants, which shelter a bodyguard of ants, by whom they are saved from unwelcome visitors. And again, the formation of galls by some insects which lay their eggs in plants, and the insect-catching proclivities of some carnivorous plants, should be remembered.

Most insects are terrestrial and aerial; the majority live in warm and temperate countries, but they are represented almost everywhere, even above the snow-line, in arctic regions, in caves. Even on the sea the *Challenger* explorers found the pelagic *Halobates*, a genus of bugs. The distribution of insects is mainly limited by food-supplies and climate, for their powers of flight are often great, and their opportunities of passive dispersal by the wind, floating logs, etc., are by no means slight.

Many insects are more or less parasitic, either externally

as adults, *e.g.* fleas, lice, bird-lice, plant-lice, etc., or internally as larvæ, *e.g.* the maggots of bot-flies in sheep, and a great number of borers within plants.

We need only mention Hessian-fly, phylloxera, Colorado beetle, weevils, locusts, to suggest many more which are of much economic importance as injurious insects. On the other hand, our indebtedness to hive-bee and silk-moth, to cochineal and lac insects, to those which destroy injurious insects, and to those which carry pollen from flower to flower, is obvious.

Finally, we must at least mention that in ants, bees,

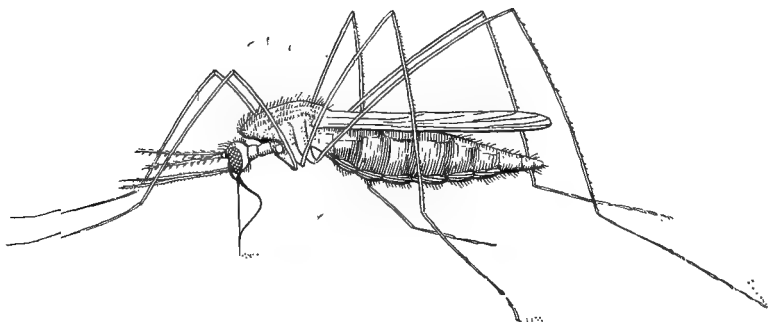

FIG. 188.—Mosquito.—After Nuttall and Shipley.

wasps, and termites we find illustration of various grades of social life, and marvellous exhibitions of instinctive skill as well as some intelligence.

INSECTS AND DISEASE

As carriers of disease-germs insects play a very important part. The rôle of flies as mechanical distributors of anthrax, plague, and other bacterial diseases has been clearly proved. Besides carrying bacilli upon their bodies and leaving them on wounds or food, they also swallow germs, and subsequently deposit them in their excreta in similar situations. Undoubtedly, however, the most serious cases are those of the blood-sucking Diptera which act as

hosts as well as carriers of disease-producing parasites. The gnats or mosquitoes (Culicidæ) are perhaps the most important in this respect. Human malaria is conveyed by at least twelve different species of mosquito, of which those belonging to the genus *Anopheles* have the widest distribution. *Anopheles maculipennis* occurs all over Europe, in many parts of Africa, North America, and India, and in all these countries it carries malaria (see Fig. 182). Proteosoma, the malaria parasite of birds, is carried by a *Culex*, a related genus. The unknown parasite of yellow fever is transmitted by the bite of another mosquito, *Stegomyia fasciata*. It occurs in all parts of the world between the parallels 40° N. and S. "It is a most vicious biter both by day and night, and breeds in small artificial collections of water, such as barrels, puddles, cisterns, and even in such small receptacles as sardine tins" (Theobald). *Culex fatigans* and *C. pipiens* act as carriers of *Filaria bancrofti* or *F. sanguinis hominis nocturna*, the parasite of the human disease filariasis. The African Tsetse flies, *Glossina palpalis* (Fig. 53) and *G. morsitans*, convey the parasites (Trypanosomes) of sleeping sickness and Nagana respectively. The latter disease, which is communicable to horses, cattle, goats, sheep, and other domesticated animals, is probably also conveyed by other species of Tsetse flies. In general, one may say that wild animals, which appear to be unaffected by the parasites which they contain, are the source of the fatal infection of new-comers.

PEDIGREE

Insects must have appeared relatively early, for remains of a cockroach-like form have been found even in Silurian strata. The higher forms with complete metamorphosis appear much later (e.g. beetles in the Carboniferous ages); but it seems that the Palæozoic insects were

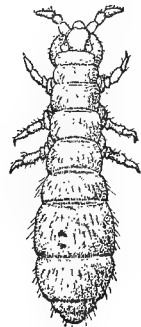

FIG. 189.—*Anurida maritima* (after Imms), one of the primitive wingless Collembola.

ORDERS OF INSECTS (after Brauer and Lang).

PTERYGOTA, Winged Insects (excepting some degenerate forms).	Order 16. <i>Hymenoptera</i> . Ants, bees, wasps, gall-flies, saw-flies, etc. Menogn. or Metagn., or a sort of compromise between these states. Usually with four transparent wings. Larvæ are footless grubs, except in some wasps.
C. METABOLA (i.e. with complete metamorphosis),	Order 15. <i>Lepidoptera</i> . Butterflies and moths.
either MENOGNATHA (i.e. always with biting jaws)	Metagn. Two pairs of uniform, scaly wings. Larva—a caterpillar.
or METAGNATHA (i.e. biting jaws replaced by sucking apparatus).	Order 14. <i>Diptera</i> . Two-winged flies. House-fly, gad-fly, midge, gnat. Metagn., but sometimes with power of biting. Two anterior transparent unfolded wings, and posterior "balancers" or "halteres."
	Larva—usually a footless maggot, without a distinct head.
	Order 13. <i>Siphonaptera</i> or <i>Aphaniptera</i> . Fleas. Metagn., but also with power of piercing. No wings. No compound eyes. Ectoparasitic. Larva—footless maggot.
	Order 12. <i>Coleoptera</i> . Beetles. Menogn., rarely Metagn. Fore wings modified into wing-covers, hind wings folded when not in use. Larvæ very diverse, generally with feet. The little bee parasites Strepsiptera are probably allied.
	Order 11. <i>Trichoptera</i> . Caddis-flies. Menogn. Hind wings usually larger than the fore wings; both folded like fans. The body is hairy, rarely scaly. The larvæ are somewhat caterpillar-like, usually live in water within special cases, and are apneustic.
	Order 10. <i>Panorpata</i> . Scorpion-flies. Menogn. Two pairs of narrow membranous wings, or sometimes none. Larva—like a caterpillar.
	Order 9. <i>Neuroptera</i> . Ant-lions and lace-winged flies. Menogn. Two pairs of glassy wings with many nervures. The larvæ sometimes live in water, and have tracheal gills.
B. AMETABOLA (i.e. no metamorphosis).	Order 8. <i>Rhynchota</i> or <i>Hemiptera</i> , e.g. <i>Phylloxera</i> , aphides, coccus insects; cicadas; bugs, water-scorpions, lice. (The male coccus insects have a complete metamorphosis.)

MENORHYNCHA
(i.e. with persistent suctorial organs).

A. AMETABOLA
(i.e. with no metamorphosis),

and HEMIMETABOLA
(i.e. with incomplete metamorphosis).

MENOGNATHA
(i.e. with persistent biting jaws).

AFTERYGOTA.
Primitive Wingless Insects.

The mouth-parts are adapted for sucking and for slight piercing. Two pairs of wings or none. The parasitic forms have no compound eyes, and are in several respects degenerate.

Order 7.

Thysanoptera, e.g. *Thrips*.

Ametab. Suctorial mouth organs. Wings very narrow, often rudimentary or absent. Only three or four pairs of stigmata. Concentrated nervous system.

Order 6.

Corrodentia, e.g. Bird-lice, termites.

Ametab. Mouth-parts adapted for biting. Wings often wanting. The bird-lice have no compound eyes.

Order 5.

Orthoptera, e.g. Cockroach, locust, cricket, mole-cricket, "walking stick," "walking leaf."

Ametab. Mouth-parts adapted for biting. Anterior wings usually shorter and firmer than those behind, or modified into wing-covers. Prothorax strongly developed and distinct from the rest of the thorax. Both pairs are sometimes absent.

Order 4.

Plecoptera, e.g. *Perlæ*.

Hemimetab. Mouth-parts adapted for biting. Two pairs of large wings or none. The larvæ live in water, and breathe by tracheal gills, which often persist in the adult.

Order 3.

Odonata, Dragon-flies.

Hemimetab. Mouth-parts adapted for biting. Two pairs of large unfolded wings. The larvæ live in water, and breathe by tracheal gills or folds.

Order 2.

Ephemera, May-flies.

Hemimetab. Mouth-parts of adult somewhat degenerate, and rarely used. Fore wings large, hind wings small or absent. Larvæ live in water, breathe by tracheal gills, and have biting mouth organs.

Order 1.

Dermoptera, Earwigs.

Ametab. Mouth-parts adapted for biting. Anterior wings small, hind wings large, but folded both longitudinally and crosswise. Posterior forceps.

Order 2. *Collembola*, Springtails, e.g. *Podura*, *Smynthorus*.

Order 1. *Thysanura*, e.g. *Campodea*, *Lepisma*, *Maculis*, *Japyx*.

mostly generalised types, prophetic of rather than referable to the modern orders.

As to the pedigree of insects, the wingless Collembola and Thysanura are doubtless primitive. In *Protopteron*, for instance, there are appendages on the first four segments of the abdomen, and the genital apertures are paired. Similarly, *Acerentomon* is a little blind creature, without antennæ, without cerci, without stigmata, with suctorial mouth-parts, with eleven abdominal segments, with a peculiar anal segment, with an unpaired genital aperture

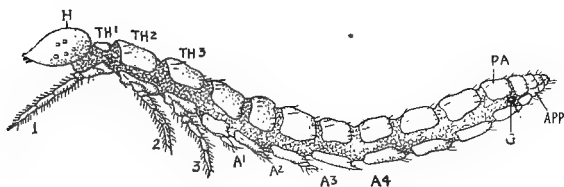

FIG. 190.—*Acerentomon*, a very primitive insect.

H, Head; TH¹, TH², TH³, terga of thoracic segments; 1, 2, 3, the thoracic legs; A¹, A², A³, A⁴, abdominal appendages; P.A., eighth abdominal tergum; G., genital aperture; A.P.P., post-anal appendix.

on the eleventh urosternite. For *Acerentomon*, *Acerentulus*, and *Eosentomon* (with stigmata) the special order Protura has been proposed. These and similar primitive forms lead us back to some of the less specialised Myriopods (e.g. *Scolopendrella*), back further to the level represented by *Peripatus*, which helps to link the Tracheate to the Annelid series.

But though the primitive wingless insects, the simple types of Myriopods, and *Peripatus*, represent ascending steps in evolution, what the actual path has been we do not know.

CHAPTER XV

PHYLUM ARTHROPODA—(continued)

Classes ARACHNOIDEA (Spiders, Scorpions, Mites, etc.)
and PALÆOSTRACA (King-crabs, Eurypterids, Trilobites)

THE class Arachnoidea is far from being a coherent unity. Its subdivisions are numerous and diverse, and a statement of general characters is consequently difficult.

The anterior segments, about seven in number, are usually fused into a cephalothorax, with six pairs of appendages. The most anterior of these appendages may be turned in front of the mouth, but there are no pre-oral antennæ as in Insects. The first two pairs of appendages (chelicerae and pedipalps) generally have to do with seizing and holding the food; the others are walking legs. But although six pairs occur in most, there may be more or less. The abdomen is generally, but not always, without appendages; it may be segmented or unsegmented; it is generally distinct from, but may be fused to the cephalothorax. A plate-like internal skeleton, called the endosternite, is often present. The elaborate compound eyes of Insects are not represented, the eyes being almost always simple. Respiration may be by tubular tracheæ, or by lung-books (chambered tracheæ?), or by both, or cutaneous, and many would include the branchiate Palæostraca along with Arachnoidea. In the tracheate forms there are never more than four pairs of stigmata. Within all or some of the legs lie coxal glands, perhaps comparable to nephridia. An elongated dorsal heart usually lies in the abdomen. The position of the genital aperture or apertures is usually on one of the anterior abdominal segments. All have separate sexes. In most cases the newly hatched young are essentially like the adults—that is to say, there is no metamorphosis.

Order I. SCORPIONIDÆ

Scorpions are elongated Arachnoids, restricted to warm countries, lurking under stones or in holes during the day, but active at night. The *Scorpio afer* of the East Indies attains a length of 6 inches, but most are much smaller. They feed on insects, spiders, and other small animals. The "tail," with the venomous sting at its tip, is usually

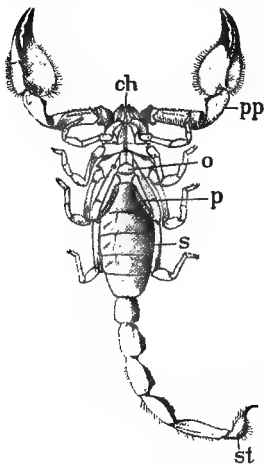

FIG. 191.—Scorpion.

ch., Chelicerae; *pp.*, pedipalps; *o.*, genital operculum; *p.*, pectines; *s.*, stigma of a lung-book on the abdomen; *st.*, sting or post-anal piece.

curved over the anterior part of the body, and can reach forward to kill the prey caught by the anterior appendages, or can be suddenly straightened to strike backwards. When man is stung, the poison seems to act chiefly on the red blood corpuscles, and, though never or very rarely fatal, may cause much pain. It has been said that scorpions commit suicide when surrounded by fire or otherwise fatally threatened, but it has been answered that they do not sting themselves, that they could not if they would, and that, even if they could, the poison would have no effect!

The body is divided into—
(1) a cephalothorax or "prosoma" of six segments, whose terga fuse into a carapace, and (2) an abdomen, which includes a broad seven-segmented "mesosoma," and a narrow five-segmented "metasoma." At the end of the latter there is a post-anal curved spine or "telson," containing a paired, compressible poison gland opening at the sharp tip. There is a strong cuticle of chitin, and also an interesting internal piece of skeleton (the endosternite), partly chitinous, but also

resembling fibro-cartilage, which lies in the cephalothorax above the nerve-cord, and serves for the insertion of muscles.

The appendages are—

1. Small, three-jointed, chelate chelicerae or falces just above the mouth, used in holding prey.

2. Large, six-jointed, chelate pedipalps. These seize the prey; their basal joints help in mastication, and in some cases they produce rasping sounds.

3-6. Four pairs of seven-jointed, non-chelate walking legs. The basal joints of the first two pairs help in connection with the mouth.

Apparently equivalent to a first pair of abdominal appendages is a small notched plate or operculum which covers or bears the genital aperture or apertures.

Apparently of the nature of appendages are the comb-like, probably tactile, pectines on the second abdominal segment.

Six other pairs of abdominal appendages are present in the embryo, but they abort.

The nervous system consists of a dorsal brain, a ring round the gullet, and a ventral nerve-cord. The eyes are innervated from the brain, the first six appendages from the collar and the sub-oesophageal ganglion. Behind the latter there are seven ventral ganglia in the eleventh to seventeenth segments inclusive. There are in scorpions two to six pairs of eyes placed on the carapace. The lateral eyes are simpler than the median pair, and the type is in some ways intermediate between the simple eye and the compound eye. There is, as in ocelli, a single crystalline-lens-like portion, below which there are a few groups of retinal cells. Each group has five cells, and the outer part of each cell is pigmented. There is no crystalline cone.

Scorpions seize small animals with their pedipalps, hold them close to the small mouth by their chelicerae, sting them if need be, and suck their blood and juices. The pharynx serves as a suction pump; a narrow gullet leads to a slight enlargement, into which a pair of salivary glands open; from the narrow mid-gut several large digestive outgrowths arise; the hind-gut ends in a ventral anus beneath the base of the sting. The narrowness of the gut may be associated with the fluid nature of the food. The so-called Malpighian tubes of *Buthus europæus* are really the ducts of the liver.

The cavity of the body is for the most part filled up with organs, muscles, and connective tissue. A pair of coxal glands, perhaps excretory and nephridial, but apparently closed in the adult, lie near the base of the third pair of walking legs. It is stated that in the embryo they open into the body cavity by internal funnels.

The blood contains amoeboid corpuscles and the respiratory pigment hæmocyanin. An eight-chambered heart, within a pericardium, lies along the back of the mesosoma. It gives off lateral arteries from the posterior end of each of its chambers, is continued backwards in a posterior aorta, and forwards in an anterior aorta. The latter supplies the head and divides into two branches, encircling the gullet and

reuniting in a ventral artery above the nerve-cord. From capillaries the blood is gathered into a ventral venous sinus, is purified in the lung-books, and thence returns by veins to the pericardium, finding its way by valved lateral openings (ostia) into the anterior end of each heart-chamber.

On the ninth to twelfth segments lie slit-like stigmata, the openings of four pairs of lung-books. Each lung-book is like a little purse with numerous (over a hundred) compartments. Air fills the much-divided cavity, and blood circulates in the lamellæ or partitions.

The testes consist of two pairs of longitudinal tubes, united by cross bridges; the vas deferens, with a terminal copulatory modification, opens under the operculum on the first abdominal segment. The ovary consists of three longitudinal tubes, united by cross ducts, and two oviducts open on the under surface of the operculum.

Fertilisation is internal; the ova begin their development in the ovary, and complete it in the oviduct. The segmentation is discoidal, the ova are hatched within the mother. The young, thus born "viviparously," are like miniatures of the adults, and adhere for some time after birth to the body of the mother.

In *Euscorpio italicus* there is abundant yolk in the ovum; in *Scorpio* there is little; but the embryo of the latter seems to eat the terminal part of the ovarian tube in which it develops. In the embryo of *Opisthophthalmus* there are peculiar horn-like outgrowths, possibly absorptive in function.

The race of scorpions is of very ancient origin, for one has been found in Silurian strata, and others nearly resembling those now alive are found in the Carboniferous.

In many ways, e.g. in their appendages, endosternite, and coxal glands, the scorpions link the Arachnoids to the King-crabs, and thus to the Trilobites.

Order 2. PSEUDOSCORPIONIDÆ. "Book-Scorpions," e.g.
Chelifer, *Chernes*

Minute animals, most abundant in warm climates, under bark, in books, under the wing-covers of insects, etc. They are like miniature scorpions, but without the long tail and sting. Their food probably consists of the juices of insects. There is a cephalothorax with six pairs of appendages; the chelicerae are minute and chelate, with openings of spinning glands, the pedipalps like those of scorpions. The abdomen is broad, with ten to eleven segments. They breathe by tubular tracheæ.

Order 3. PEDIPALPI. "Whip-Scorpions," e.g. *Thelyphonus*, *Phrynus*

Small animals, found in warm countries. There is a cephalothorax with six pairs of appendages; the abdomen is depressed, well-defined

from the thorax, and has eleven to twelve segments. The chelicerae are simply clawed, but are poisonous; the pedipalps are simply clawed or else truly chelate. The first pair of limbs are like antennae. Respiration is by two pairs of abdominal lung-sacs. In *Thelyphonus* there is a long terminal whip.

Order 4. PHALANGIDÆ (or OPILIONINA). "Harvest-men," e.g.
Phalangium

The small, spider-like "harvest-men" are noted for their extremely long legs, by which they stalk slowly along, avoiding the glare of day. The broad six-segmented abdomen is not constricted off from the unsegmented cephalothorax; the chelicerae are chelate; the pedipalps are like legs. Respiration is by tubular tracheae. The harvest-men do not trouble us, but feed on small insects.

Order 5. SOLPUGIDÆ or SOLIFUGÆ, e.g. *Galeodes* or *Solpuga*

Active, pugnacious, venomous, nocturnal animals, found in the warmer parts of the earth. The head and abdomen are distinct from the thorax. The thorax has three segments, the abdomen nine or ten. The chelicerae are large and chelate, the pedipalps like long legs. The respiration is by means of tubular tracheae. The presence of distinct segments on the thorax is remarkable.

Several other small orders of Arachnids must be recognised, e.g. Palpigradi for a very interesting minute form, *Kænenia*, with the last two joints of the cephalothorax free, and with an abdomen of eleven segments ending in a long-jointed whip.

Order 6. ARANEIDÆ. Spiders

Spiders are found almost everywhere upon the earth, and a few are at home in fresh water, e.g. *Argyroneta*, and on the seashore, e.g. *Desis*, *Desidiopsis*. Most of them live on the juices of insects, and many form webs in which their victims are snared. They may be divided, according to habit, into the wanderers who spin little, and the sedentary forms who spin much.

The body of a spider is very distinctly divided into two parts: the cephalothorax and the abdomen, connected by a narrow waist. The chitinous cuticle varies in hardness, hairiness, and colouring; it has, as usual, to be moulted as the spider grows. Thus the young garden spider moults eight times in its first year.

There are six pairs of appendages—

1. The two-jointed chelicerae or falcæ, whose terminal joint or fang

bends down on the basal joint in "sub-chelate" fashion, and is perforated by the duct of a poison gland.

2. The leg-like, usually six-jointed, non-chelate pedipalps, whose basal joint helps in mastication, while the terminal joint in the male expands as a reservoir for the spermatozoa and serves as a copulatory organ.

3-6. Four pairs of terminally clawed 7-jointed walking legs. The most anterior pair are much used as feelers. The spinnerets at the end of the abdomen are modified abdominal legs. Besides these the embryo has four pairs of abdominal appendages which abort.

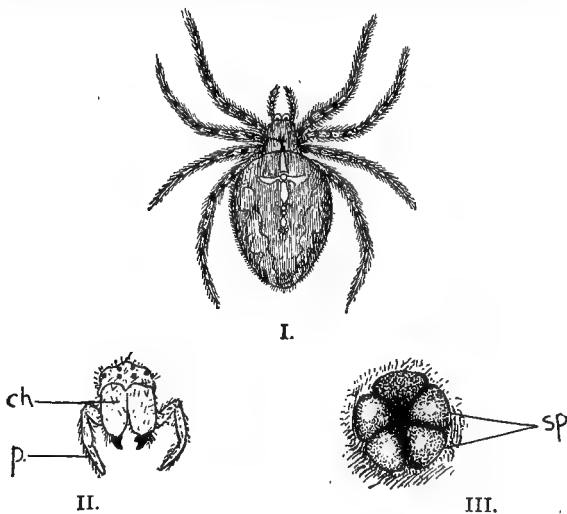

FIG. 192.—Garden spider.

I., Female garden spider; II., end view of head of the same showing the simple eyes, the poison fangs (*ch.*), and the pedipalps (*p.*); III., posterior end of body showing two pairs of spinnerets (*sp.*), with anus above.

The nervous system is of the usual Arthropod type, but shows much centralisation. Thus the ventral ganglia are fused into one large centre in the cephalothorax (see Fig. 193), a condition comparable to that in crabs. There are two or three rows of simple eyes on the cephalothorax, whose focal distance is very short, spiders trusting most to their exquisite sense of touch, by which they discriminate

the various vibrations on a web line. The senses of smell, hearing, and taste are also present, but little is known in regard to the organs.

Body cavity, endosternite, and coxal glands generally resemble those of scorpions.

The spider usually sucks the blood and juices of its prey, and behind the gullet lies a powerfully suctorial region, strengthened by chitinous plates, and worked by muscles. From the small mid-gut arise five pairs of long cæca, a pair running forwards and a pair passing into the bases of each pair of legs, and then back again. These cæca sometimes anastomose. Farther back the mid-gut gives off numerous digestive outgrowths, which fill a large part of the abdomen. Their secretion digests pro-teids. Terminally there is a large cloaca, and where the intestine joins this, four much-branched excretory Malpighian tubes are given off, which are said to be endodermal in origin.

A three-chambered heart, containing colourless blood, lies within a pericardium near the dorsal surface of the abdomen. It gives off an anterior and a posterior aorta and lateral vessels; and the circulation corresponds in general to that of the scorpion.

In a few forms (Tetrapneumones) respiration is effected by four "lung-books," e.g. in the large bird-catching *Mygale* (Fig. 193). In the vast majority (Dipneumones) there are two lung-books, and tubular tracheæ in addition. The

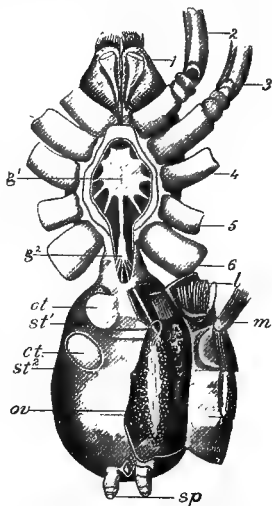

FIG. 193.—Dissection of *Mygale* from the ventral surface.—After Cuvier.

1, Chelicerae; 2, pedipalps cut short; 3-6, walking legs; *g.*¹, large thoracic ganglion; *g.*², ganglion at base of abdomen; *ct.*, chambered tracheæ or lung-books—at the left side the anterior is cut open to show the lamellæ (*l.*); *m.*, muscle of abdomen; *st.*¹ and *st.*², stigmata of lung-books; *ov.*, ovary; *sp.*, spinnerets.

stigmata of the lung-books lie on the anterior ventral surface of the abdomen; the tracheæ open posteriorly near the spinnerets, or just behind the opening of the lung-books, or at both places.

The spinnerets (4-6) lie just in front of the anus. They are movable and perforated by numerous (often many hundred) tubes or "spinning spools," each of which is connected with a compressible gland secreting silk. There are various kinds of glands; both the amount and the nature of the secretion are under control. The spinnerets are transformed abdominal appendages (a new organ from an old—as is so often the case); and the glands are ectodermic invaginations.

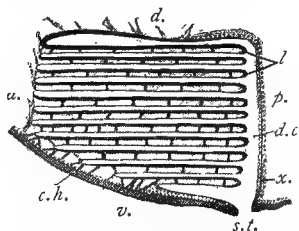

FIG. 194 —Section of lung-book.
—After Macleod.

d., Dorsal; *v.*, ventral; *l.*, lamellæ; *p.*, posterior; *a.*, anterior; *d.c.*, dorsal chamber; *x.*, posterior wall; *s.t.*, stigma; *ch.*, one of the interlamellar chambers.

Many spiders have at the base of their spinnerets a transverse surface or cribellum perforated by spinning tubes, and from this they comb out a peculiar curled silk with the help of a row of stiff bristles or calamistrum on each posterior leg.

The males are usually smaller and often more brightly coloured than their mates. From the paired testes, in the anterior part of the abdomen, two vasa deferentia pass to a common aperture beside the openings of the lung-books. From the paired ovary two oviducts likewise arise and open into a uterus, whose external aperture is surrounded in the mature female by a complex genital armature or epigynium. Here also in most females are the openings of two receptacula seminis, in which the sperms received from a male are stored, and from which they pass by a pair of internal ducts to the oviducts, there to fertilise the ova. The sperms of the male, after emission, may be stored up in the last joint of the palps. The ova are usually surrounded by silken cocoons, which are carried about by the mother or carefully hidden in nooks or nests. There is no metamorphosis 'but

spiders at birth are often very different in details from their later stages.

Spinning.—Muscular compression of the glands causes a flow of liquid silk through the fine spools of the spinnerets. The extremely thin filaments from each spinneret unite into a thread, and the thread of one spinneret is often combined with that from the others. In this way a compound thread of exquisite fineness, though rivalled by a quartz-fibre, is produced; but two or four separate threads are often exuded at the same time. Before beginning to “spin,” the spider often presses the spinnerets against the surface to which the thread is to adhere, and draws the filaments out by slowly moving away. Often, however, the filaments ooze out quite apart from any attachment. The legs are also much used in extending and guiding the thread, and some spiders have, as has been mentioned, a special comb (calamistrum).

One of the most important ways in which the secreted threads are used is in forming a web. The common garden spider (*Epeira*) makes a web which is a beautiful work of unconscious art, and very effective as a snare for insects. The spider first forms “foundation lines” around the selected area; it then swings across the area with the first “ray,” which it fixes firmly; another and another is formed, all intersecting in one centre. Thirdly, it starts from the centre, and moves from ray to ray in a long wide spiral gradually outwards, leaving a strong spiral thread as it goes. Fourthly, the spider moves in a closer spiral from the circumference inwards, biting away the former spiral, replacing it by another, which is viscid and adhesive. It is to this that the web chiefly owes its power of catching insects which light there. There is usually a special thread running to the adjacent hole or nest, and the spider feels rather than sees when a victim is caught.

The spun threads are used in many other ways. They line the nest, and form cocoons for the eggs. They often trail behind the spiders as they creep; they greatly assist locomotion, and are used in marvellous feats of climbing. Small and young spiders often stand on tiptoe on the top of a fence, secrete a parachute of threads, and allow themselves to be borne by the wind. The fallen threads are known as gossamer.

The distribution of spiders, *e.g.* on islands, does not appear to be much affected by the absence of wings. Many young forms are aeronauts, and many are carried about by the wind apart from ballooning.

Courtship.—The males are often much smaller than the females. The disproportion is sometimes such as would be observed if a man 6 ft. high and 150 lb. in weight were to marry a giantess 76–90 ft. high, 200,000 lb. in weight. The smallness of the males may be due to the fact that they are males; others say that the smaller the males are, the less likely they are to be caught by their frequently ferocious mates.

The males are often more brilliantly coloured than the females. Wallace spoke of the brilliancy of males as due to their greater vitality, and referred the relative plainness of the females to their greater need for protection. Darwin referred the greater decorativeness of males to the fact that those which varied in this direction found

favour in the eyes of their mates, were consequently more successful in reproduction, and thus tended to entail brilliancy on their male successors. The careful researches of Prof. and Mrs. Peckham greatly strengthen the position of those who believe in the efficacy of sexual selection. In the *Evolution of Sex* it has been suggested that sexual selection may help to establish the brilliancy of males, and that natural selection may help to keep the females plain, but that the decorative and other differences between the sexes are primarily associated with the more fundamental qualities of maleness and femaleness.

Classification of Spiders

- 1 Tetrapneumones or Mygalomorpha, with four lung-books and no tracheæ; the fangs of the chelicerae move vertically, parallel to each other, *e.g.*—
Mygale, a large lurking spider which has been known to kill small birds, but usually eats insects; *Atypus*, *Cteniza*, and others make neat trap-door nests.
2. Dipneumones or Arachnomorpha, with two lung-books and tracheæ as well; the fangs of the chelicerae move somewhat horizontally toward each other.

The web-spinners, *e.g.* *Epeira*; wolf-spiders, *e.g.* *Lycosa*, *Tarantula*, the latter with poisonous qualities which have been much exaggerated; jumping spiders or Attidæ, *e.g.* *Attus salticus*. The common house spider is *Tegenaria domestica*; the commonest garden spider is *Epeira diademata*. *Agyroneta aquatica* fills an aquatic silken nest with bubbles of air caught at the surface.

Order 7. ACARINA. Mites and Ticks

Mites are minute Arachnoids inclined to parasitism. They occur in the earth, or in water, salt and fresh, or on animals and plants. They feed on the organisms they infest or upon organic débris.

The abdomen is fused with the cephalothorax, but there is sometimes a clear boundary line; both are unsegmented except in *Opilioacarus*, which has a segmented abdomen. According to the mode of life, the mouth-parts are adapted for biting or for piercing and sucking. Respiration may be simply through the skin; in the majority there are tracheæ with two stigmata. A heart seems usually absent, but it is present in *Gamasus*. Many of the young have only three pairs of legs when hatched, but soon gain another pair. When some mites are starved or desiccated, and to some extent die, certain cells in the body unite within a cyst, and are able in favourable conditions to regrow the animal.

Examples—

- (a) Without tracheæ. Cheese-mite (*Tyroglyphus*). Itch-mite (Fig. 196) (*Sarcoptes scabiei*), causing "itch" in man; *S.*

canis, causing "mange" in dogs. Follicle-mite (*Demodex folliculorum*), common in the hair follicles of man and domestic animals (Fig. 195). Gall-mites (Phytoptids), forming dimples and pouches on plants.

(g) With tracheæ. Harvest-mites (*Trombidium*), whose minute hexapod larvæ are troublesome parasites in summer on



FIG. 195.—Follicle-mite (greatly enlarged).

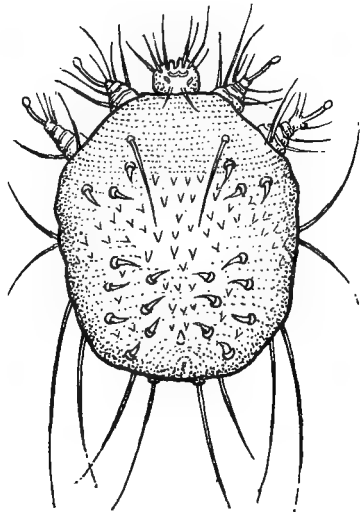

FIG. 196.—Itch-mite (*Sarcoptes scabiei*) (greatly enlarged).

insects, many mammals, and man. The so-called "red spider" (*Tetranychus telarius*) spins webs, and lives socially under leaves. Water-mites, e.g. *Hydrachna* on water-beetles, and *Atax* on gills of fresh-water mussels. Beetle-mites (*Gamasus*), often found on carrion beetles. There is a common red mite on the shore-rocks, known as *Molgus* (*Bdella littoralis*).

Ticks (Ixodidæ, etc.) are the largest Acarina. They show a movable "capitulum" bearing serrated cutting chelicerae and strong four-jointed pedipalps. They are responsible for spreading the germs of some diseases affecting man and beast, e.g. human "tick-fever" on the

Congo, spread by *Ornithodoros moubata*; a spirochæt disease in the West Indies, borne by *Argas reflexus* and *A. persicus*; Texas fever or "red water" in cattle, carried by *Boophilus annulatus*. The common sheep tick is in

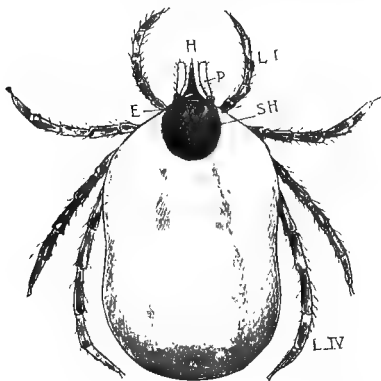

FIG. 197.—Tick (*Ixodes ricinus*, female), dorsal surface, showing the oval shield (SH).—After Wheler.

H., Hypopharynx; P., palp; L.I., L.IV., first and fourth leg.

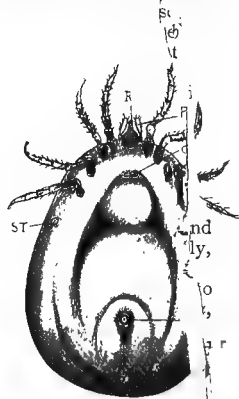

FIG. 198.—Tick (*Ixodes ricinus*, female), ventral surface.—After Wheler.

R., Rostrum; P., palp; G., genital aperture; ST., stigma; A., anus.

Britain is *Ixodes ricinus*. It may be noted that mites have been found inside human tumours, and there are many facts suggesting that some of the small Acarines may share in spreading disease germs. Even *Demodex* may play its part.

Aberrant Orders or Classes

Order LINGUATULIDA or PENTASTOMIDA, e.g. *Pentastomum tænioides*

This strange animal is parasitic in the nasal and frontal cavities, etc., of the dog and wolf. It is worm-like in form, externally ringed, without any oral appendages, but with two pairs of movable hooks near the mouth. The muscles are striated. The alimentary canal is very simple, without Malpighian tubes. A narrow circumoesophageal nerve-ring, without a brain, is connected with a single ventral ganglion. There are no sense organs nor tracheæ, nor is there any heart. The sexes are separate; the males smaller than the female.

Embryos within egg-cases pass from the nostrils of the dog. If they happen to be swallowed by a rabbit or a hare, or it may be some other mammal, the embryos hatch in the gut and penetrate to liver or

lung. There they encyst, moult, and undergo metamorphosis. The final larval form has two pairs of short legs, and has been compared to a larval mite. Liberated from its encystment, it moves about within its host, but will not become adult or sexual unless its host be eaten by dog or wolf. There are a few other species occurring in Reptiles, Apes, and even man, but their history is not adequately known, and the systematic position is very uncertain. There is very little reason for ranking them along with Arachnoids.

Order TARDIGRADA. Water-bears or Sloth-animalcules,
e.g. Macrobiotus

Microscopic animals, sometimes found about the damp moss of swamps or even in the roof-gutters of houses. Some occur in fresh water, others in the sea. The unsegmented body is somewhat worm-like, with four pairs of unjointed clawed limbs like little stumps, with mouth-parts resembling those of some mites, and adapted for piercing and sucking. The muscles are unstriped. There is no abdomen. There is a food canal, a brain, and a ventral chain of four ganglia, sometimes even a pair of simple eyes, but no respiratory or vascular organs. The sexes are separate; the males rarer and smaller.

The terrestrial Tardigrada, even as adults, have great powers of successfully resisting desiccation, but sometimes only the eggs do so, developing rapidly when favourable conditions return. There is very little reason for ranking them along with Arachnoids. Perhaps, as the seta-like "claws" and the cirri of some types suggest, they are nearer to Annelids.

Class PALÆOSTRACA

The three following orders, Xiphosura, Eurypterina, and Trilobita, may be united under this title. They live or lived in water, and have or had gills in association with the limbs. The recently discovered antennæ of Trilobites, together with the markedly biramose character of some of their limbs, suggest an affinity with Crustacea, but, on the other hand, the affinities of the Xiphosura seem to be distinctly Arachnoid.

Order I. XIPHOSURA

There is one living genus, the King-crab or Horseshoe-crab (*Limulus*).

The King-crab lives at slight depths off the muddy or sandy shores of the sheltered bays and estuaries of North America, from Maine to Florida, in the West Indies, and also on the Molucca Islands, etc., in the far East. The

body consists of a vaulted cephalothorax shaped like a horseshoe, and an almost hexagonal abdomen ending in a long spine. Burrowing in the sand, *Limulus* arches its body at the joint between cephalothorax and abdomen, and pushes forward with legs and spine. It may also walk about under water, and even rise a little from the bottom.

It is a hardy animal, able to survive exposure on the shore, or even some freshening of the water. Its food consists chiefly of worms.

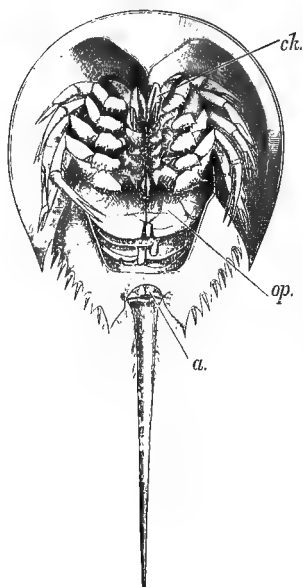

FIG. 199.—*Limulus* or King-crab.

ch., Chelicerae; *op.*, operculum;
a., anus.

hind these, still on the cephalothorax, there is a pair of small appendages called chilaria.

Then follows on the abdomen a double "operculum" with the genital apertures on its posterior surface.

Under the operculum lie five pairs of flat plates bearing remarkable respiratory organs ("gill-books"). These appendages show hints of the exopodite and endopodite structure characteristic of Crustaceans.

Each "gill-book" looks like a much-plaited gill, or like a book with

The King-crab is interesting in its structure and habits and also because it is the only living representative of an old race.

The hard, horseshoe-shaped, chitinous cephalothoracic shield is vaulted, but the internal cavity is much smaller than one would at first sight suppose; the well-defined abdomen shows some hint of being divisible into meso- and meta-soma; the long sharp spine is (like the scorpion's sting) a post-anal telson.

On the concave under-surface of the cephalothorax there are six (or seven) pairs of limbs, as in spiders and scorpions—

- (1) A little pair of three-jointed chelicerae in front of and bent towards the mouth.
- (2) A pair of pedipalps lateral to the mouth.
- (3-6) Four pairs of walking legs, the bases of which surround the mouth, and help in mastication. Be-

over a hundred hollow leaves. The leaf-like folds are externally washed by the water, and within them the blood flows. The leaves of the gill-books are often compared to the leaves of the insunk lung-books of scorpions.

Spawning occurs in the spring and summer months. The ova and spermatozoa are deposited in hollows near high-water mark. Some of the early stages of development present considerable resemblance to corresponding stages in the scorpion. In the larvæ, both cephalothorax and abdomen show signs of segmentation, but this disappears. The spine is represented only by a very short plate, and the larva presents a striking superficial resemblance to a Trilobite.

It seems likely that *Limulus* is linked to the extinct Eurypterids by some fossil forms known as Hemiaspidæ, e.g. *Hemiaspis*, *Bélinurus*.

Order 2. EURYPTERINA (= Merostomata or Gigantostroma), e.g. *Eurypterus*

Large extinct forms found from Cambrian to Carboniferous strata. The body is divided into head, thorax, and abdomen. The head is small and unsegmented. The thorax is composed of six distinct segments, the abdomen of six with a terminal telson. On the head are borne six pairs of appendages of varying shape, two lateral compound eyes, and two median ocelli. On the ventral surface of the thorax there are five pairs of gills covered by flat plates, of which the most anterior pair are very large, and form the so-called operculum (cf. *Limulus*). The surface of the body was covered with scales. Some of the Eurypterids reached a length of 6 ft. The oldest Merostomes are referred by Walcott to a sub-order *Limulava* somewhat divergent from other Eurypterids.

This order is sometimes placed near the Crustacea, but the general opinion is that they are linked through *Limulus* to Arachnoids.

Order 3. TRILOBITA. Trilobites, e.g. *Calymene*, *Phacops*, *Asaphus*

Extinct forms chiefly found in Cambrian and Ordovician strata, but extending up to the Carboniferous. The body as found is divisible into three parts—the unsegmented head shield, often prolonged backwards at the angles; the flexible thorax of a varying number of segments; the unsegmented abdomen or pygidium. A median longitudinal ridge, or rachis, divides the body into three longitudinal portions.

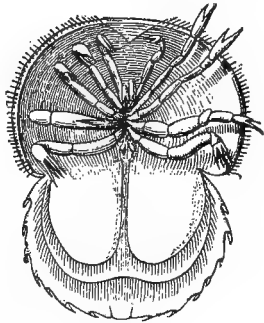

FIG. 200.—Young *Limulus*.—
After Walcott.

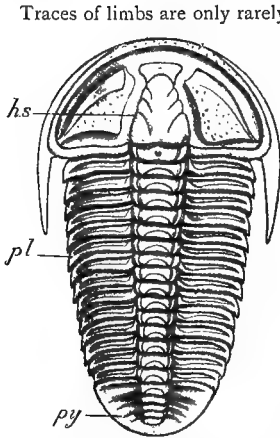

FIG. 201.—Trilobite (*Conocephalites*).—After Barrande.

h.s., Head shield; *pl.*, pleura of thoracic region; *py.*, pygidium.

ing the Trilobites as an offshoot from a stock ancestral to both Arachnoids and Crustaceans.

Traces of limbs are only rarely preserved. In the head region there are four pairs, apparently simple. Antennæ have been recently found in this region. The thorax and abdomen are furnished with biramous appendages, with long-jointed endopodite, short exopodite, and a gill (or epipodite?) of varying shape. In the abdominal region the gills were perhaps rudimentary.

Trilobites are often found rolled up in a way that reminds one of some wood-lice. So abundant are they in some rocks that even their development has been studied with some success.

The limbs seem to be more like those of Crustaceans than those of Arachnoids, and the occurrence of antennæ, observed by Linnæus (1759), and recently corroborated, accentuates the resemblance. The affinities with *Limulus*, according to the views of other authorities, justify the association of Trilobites and Arachnoids. A compromise may be perhaps effected by regard-

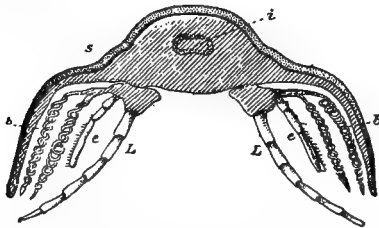

FIG. 202.—Vertical cross-section of a Trilobite (*Calymene*).—After Walcott.

i., Intestine; *s.*, shield; *L.*, endopodite; *e.*, exopodite; *b.*, epipodial parts.

Incertæ Sedis

Class PYCNOGONIDA, PANTOPODA, or Podosomata

Marine Arthropods, sometimes called sea-spiders. They may be ranked between Crustaceans and Arachnoids. Many climb about

seaweeds and hydroids near the shore, but some live at great depths. The body consists of an anterior proboscis, cephalothoracic region with three fused and three free segments, and an unsegmented rudimentary abdomen. Four somewhat primitive eyes on an anterior hillock, are nearer to the eyes of Arachnoids than to those of any other class. There are typically seven pairs of appendages. The first are short and chelate, but may be absent in the adult. The next two are small and slender, and are often absent in the adult female; the second pair may also be absent in the male, but the third in the males of all genera carries the eggs. The last four pairs of appendages are always present, and form the walking legs. Into them, and into the chelicerae when these are present, out-growths of the mid-gut extend. The sexes are separate. The larvæ are at first unsegmented, with three pairs of appendages.

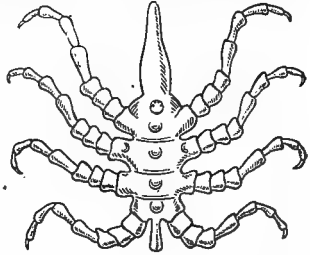

FIG. 203.—Sea-spider (*Pycnogonum littorale*), from the dorsal surface.

present, out-growths of the mid-gut

The larvæ are at first unsegmented,

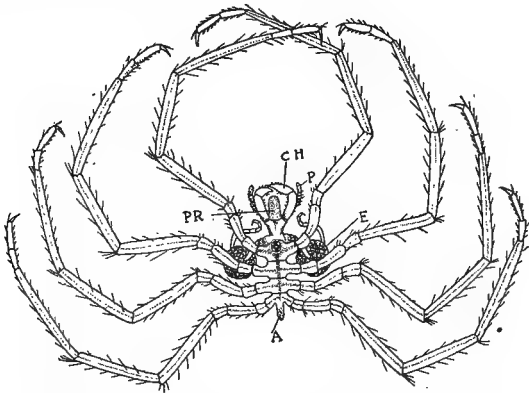

FIG. 204.—Male of *Nymphon*.—After Sars.

PR., Proboscis; CH., chelophores; P., pedipalps; E., eggs carried on ovigerous legs; A., rudimentary abdomen.

Examples.—*Pycnogonum*, *Nymphon*, *Ammonothea*. In *Pentanymphton* and *Decolopoda* there is an extra pair of long walking legs.

CHAPTER XVI

PHYLUM MOLLUSCA

Classes:—1. GASTEROPODA, *e.g.* Snails. 2. SOLENOGASTRES—A small class of doubtful worm-like forms, *e.g.* *Neomcna*. 3. SCAPHOPODA—A small class, *e.g.* *Dentalium*. 4. LAMELLIBRANCHIATA—Bivalves. 5. CEPHALOPODA—Cuttle-fishes.

THE series of Molluscs is in many ways contrasted with that of Arthropods; thus the body of the Mollusc is unsegmented, and there are no appendages. The general habit of life is also very different, for, although there are active Molluscs and sluggish Arthropods, it is true as an average statement that Molluscs are sluggish and Arthropods are active. In the frequent presence of a trochosphere larva, in the nerve-ring around the gullet, and in some other features, Molluscs resemble Annelids, but it is probable that they took their origin from a still lower level.

GENERAL CHARACTERS

Molluscs are unsegmented and without appendages. The symmetry is fundamentally bilateral, but this is lost in most Gasteropods. The "foot"—a muscular protrusion of the ventral surface—is very characteristic; it usually serves for locomotion, but is much modified according to habit. Typically, a projecting dorsal fold of the body-wall forms a mantle, or pallium (Fig. 205, c.), which often secretes a single or bilobed shell covering the viscera, and roofs in a space—the mantle cavity—within which lie the gills. But both mantle and shell may be absent. There are three chief pairs of ganglia—cerebrals, pedals, and pleurals—with connecting circum-oesophageal commissures, and there is also a visceral nervous system con-

sisting typically of (a) a loop connecting the two pleurals and provided with two visceral ganglia, and (b) a stomato-gastric

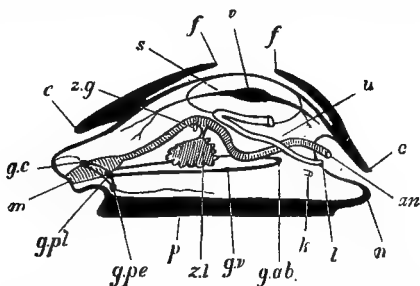

FIG. 205.—Ideal mollusc.—After Ray Lankester.

m., Mouth; *g.c.*, cerebral ganglia; *c.*, edges of mantle skirt; *z.g.*, duct of right lobe of digestive gland; *s.*, pericardial cavity; *f.*, edges of shell-sac; *v.*, ventricle of heart; *u.*, nephridium; *an.*, anus; *n.*, posterior part of the foot; *l.*, opening of nephridium; *h.*, genital aperture; *g.ab.*, abdominal ganglion on visceral loop; *g.v.*, visceral ganglion; *z.l.*, left lobe of digestive gland; *p.*, foot; *g.pe.*, pedal ganglion; *g.pl.* pleural ganglion.

loop connecting the cerebrals below the gullet and provided with two buccal ganglia (Fig. 205). Except in Lamelli-branchs, in which the head region is degenerate, there is in the

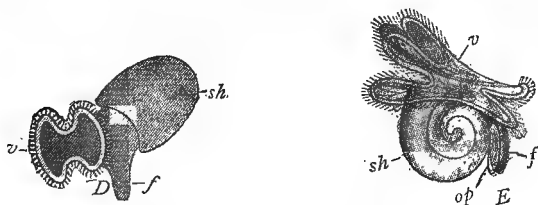

FIG. 206.—Stages in molluscan development.

D. Larva of Heteropod (after Gegenbaur); *sh.*, shell covering visceral hump; *v.*, velum; *f.*, foot.

E. Larva of *Atlantia* (after Gegenbaur); *v.*, velum; *sh.*, shell; *f.*, foot; *op.*, operculum.

mouth a chitinous ribbon or radula, usually bearing numerous small teeth, and moved by special muscles, the whole structure being known as the odontophore. There is much unstriped muscle, but the more rapidly contracting muscles have cross-

striped fibres, or fibres with unstriped fibrils twisted in a spiral. A portion of the true body cavity or cœlom usually persists as the pericardium at least (Fig. 205, s.), and communicates with the exterior through the nephridium or nephridia. The rest of the cavity of the body is hæmocœlic. The vascular system is almost always well developed, but part of the circulation is in most cases lacunar; the heart typically consists of a ventricle and two auricles. Respiratory organs are most typically represented by gills or ctenidia, consisting of an axis attached to the body and bearing lamellæ, but the gills may have simpler forms, or may be absent, and in the terrestrial snails the mantle cavity is adapted for aerial respiration. At the base of the gills there is generally an olfactory organ or osphradium. The sexes are separate or united. There are two common larval stages, — the Trochosphere, which resembles the same stage in some Annelids, and the more characteristic Veliger (Fig. 206); but the development is often direct.

First Type of MOLLUSCA. The Snail (*Helix*), one of the terrestrial (pulmonate) Gasteropods

Habits.—The common garden snail (*H. aspersa*), or the larger edible snail (*H. pomatia*), which is rare in England

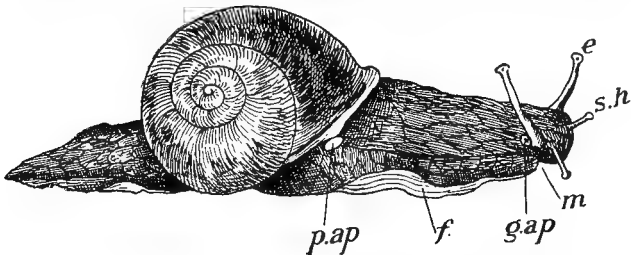

FIG. 207.—Roman snail (*Helix pomatia*).

Note shell covering visceral hump; *p.ap.*, pulmonary aperture (including anus and opening of ureter); *f.*, the foot; *g.ap.*, genital aperture; *m.*, mouth; *e.*, eye on long horn; *s.h.*, one of short horns.

but abundant on the Continent, serves as a convenient type of this large genus of land-snails. They are thoroughly

terrestrial animals, breathing air directly through a pulmonary chamber, and drowning (slowly) when immersed in water. Their food consists of leaves and other parts of plants, but they sometimes indulge in strange vagaries of appetite. They are hermaphrodite, but there is always cross-fertilisation. The breeding time is spring, and the eggs are laid in the ground. In winter snails bury themselves, usually in companies, cement the mouths of their shells with hardened mucus and a little lime, and fall into a state of "latent life," in which the heart beats feebly. They have been known to remain dormant for years.

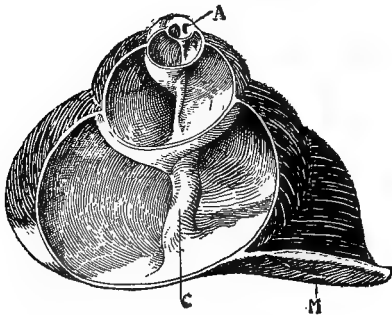

FIG. 208.—Vertical section of the shell of a species of *Helix*.

M., Mouth of shell; *A.*, apex; *C.*, columella.

General appearance.—A snail actively creeping shows a well-developed head, with two pairs of retractile horns or tentacles, of which the longer and posterior bear eyes. The foot, by the muscular contraction of which the animal creeps, is very large; it leaves behind it a trail of mucus. The viscera protrude, as if ruptured, in a dorsal hump, which is spirally coiled and protected by the spiral shell. On slight provocation the animal retracts itself within its shell, a process which drives air from the mantle cavity, and thus helps indirectly in respiration. Around the mouth of the shell is a very thick mantle margin or collar, by which the continued growth of the shell is secured. On the right

side of the expanded animal, close to the anterior edge of the shell, there is a large aperture through which air passes into and out of the mantle cavity. Within the same aperture is the terminal opening of the ureter. The food canal ends slightly below and to the right of the pulmonary aperture. All the three openings are close together. The *anterior* termination of ureter and food canal is one of the results of the twisting of the visceral mass *forwards to the right*. But still farther forward, at the end of a slight groove which runs along the right side of the neck, indeed quite close to the mouth, is the genital aperture. Lastly, an opening just beneath the mouth leads into the large mucus gland of the foot.

Shell.—The right-handed spiral shell is a cuticular product made and periodically enlarged by the collar. Chemically it consists of carbonate of lime and an organic basis (conchin). The outermost layer is coloured, without lime, and easily rubbed off; the median layer is thickest, and looks like porcelain; the innermost layer is pearly. The twisted cavity of the shell is continuous, and the viscera extend to the uppermost and oldest part.

As the shell is made, the inner walls of the coils form a central pillar (columella), as on a staircase, to which the animal is bound by a strong (columellar) muscle. Many Gasteropods bear on the foot a lid or operculum, of conchin or of lime, which closes the mouth of the shell. In *Helix* there is none; the "epiphragm" with which the shell is sealed in winter consists of hardened mucus, plus phosphate and a smaller quantity of carbonate of lime. It is formed very quickly from the collar region when cold weather sets in, has no organic connection with the animal, such as binds the operculum to the foot of the whelk, and is loosened off in the mildness of spring.

Sinistral shells, with left-handed spiral, occasionally occur as variations. The shell, held with its summit towards the observer, has its aperture to the left. The internal organs are inverted, and at the start there is a reversal of the cleavage planes of the egg.

Appearance after the shell is removed.—If the shell is removed carefully, so that nothing is broken except the columellar muscle, many structures can be seen without any dissection. The skin of the head and foot should be contrasted—(a) with the thick collar of the mantle; (b) with the mantle itself, which forms the loose roof of the pulmonary chamber; (c) with the exceedingly delicate, much-stretched, and always protected skin of the visceral hump. The mantle is a downgrowth of the skin of this dorsal region. It is peculiar in the snail, in that its margin

(the collar) is fused to the body-wall. The result is to form a respiratory cavity, which is as much outside the body as is the gill-chamber of the crayfish. It is important to realise that the great rupture-like hump of viscera on the dorsal surface has been coiled spirally, and that there is the yet deeper torsion forward to the right.

A great part of the hump consists of the greenish brown digestive gland, in which the bluish intestine coils; behind the mantle chamber, on the right, lies the triangular and greyish kidney; the whitish reproductive organ lies in the second last and third last coil of the spiral.

Skin.—This varies greatly in thickness. It consists of a single-layered epidermis and a more complex dermis, including connective tissue and muscle fibres. There are numerous cells from which mucus, pigment, and lime are secreted; those forming pigment and lime are especially abundant on the collar, where they contribute to the growth of the shell.

Muscular system.—Among the important muscles are—(a) those of the foot; (b) those which retract the animal into its shell, and are in part attached to the columella; (c) those which work the radula in the mouth; (d) the retractors of the horns; and (e) the retractor of the penis. The muscle fibres usually appear unstriated. There is much connective tissue, some of the cells of which contain glycogen, pigment, and lime.

Nervous system.—This is concentrated in a ring around the gullet. Careful examination shows that this ring consists dorsally of a pair of cerebral ganglia, connected ventrally with a pair of pedals and a pair of pleuro-viscerals, which, according to some authorities, have a median abdominal ganglion lying between them.

The cerebrals give off nerves to the head, *e.g.* to the mouth, tentacles, and otocysts, and also two nerves which run to small buccal ganglia, lying beneath the junction of gullet and buccal mass. The pedals give off nerves to the foot; the pleuro-viscerals to the mantle and posterior organs.

Sense organs.—An eye, innervated from the brain, is situated on one side of the tip of each of the two long horns. It is a cup invaginated from the epidermis, lined posteriorly by a single layer of pigmented and

non-pigmented retinal cells, filled with a clear vitreous body perhaps equivalent to a lens, closed in front by a transparent "cornea," and strengthened all round by a firm "sclerotic." How much a snail sees we do not know, but it detects quick movements. Though the eye is by no means very simple, the snail soon makes another if the original be lost, and this process of regeneration has been known to occur twenty times in succession.

The otocysts appear as two small white spots on the pedal ganglia. Each is a sac of connective tissue, lined by epithelium which is said to be ciliated in one region, containing a fluid and a variable number of oval otoliths of lime, and innervated by a delicate nerve from the cerebral ganglia.

Though no osphradium or smelling-patch, comparable to that which occurs at the base of the gills in most Molluscs, has been discovered in *Helix*, the snail is repelled or attracted by odours; it shrinks from turpentine, it smells strawberries from afar. This sense of smell seems to be located in the horns, for a dishorned snail has none. The tips of both pairs of horns bear sensory cells connected with ganglionic tissue and nerve-fibres within.

Other sensory cells, probably of use in tasting, lie on the lips; and there are many others, which may be called tactile, on the sides of the foot, and on various parts of the body. In short, the snail is diffusely sensitive.

Alimentary system.—In cutting a piece of leaf, the snail uses two instruments—the crescentic jaw-plate on the roof of the mouth, and the toothed ribbon or radula on the floor. This radula is like a flexible file,—a short and broad strip of membrane, bearing several longitudinal rows of minute chitinous teeth. It rests on a cartilaginous pad on the floor of the mouth cavity, and is moved (backwards and forwards, and up and down) in a curve by protractor and retractor muscles. The whole apparatus, including teeth, membrane, and pad, is called the odontophore. The radula wears away anteriorly, but is added to posteriorly within a radula sac which projects from the floor of the buccal cavity. Its action on leaves may be compared very roughly to that of a file, but its movements within the mouth also produce a kind of suction which draws food particles inwards. In this suction the muscular lips and the cilia in the mouth cavity assist.

The ducts of two large salivary glands open on the dorsal surface of the buccal cavity, and there are numerous distinct glandular cells close to the entrance of the two ducts. The salivary glands are large lobed structures, and extend far backward on the crop. They consist of hundreds

of glandular cells or unicellular glands, which secrete a clear fluid. This travels up the ducts, and is forced, in part at least, by muscular compression, into the buccal cavity. While some say that this fluid converts starch into sugar (after the usual fashion of saliva), other authorities deny that it has any effect upon the food. Similar glands are found in all Gasteropods, while they are entirely absent in Lamellibranchs. In some boring Gasteropods the secretion contains 2-4 per cent. of free sulphuric acid.

The gullet extends backward from the buccal cavity, and expands into a storing-crop; this is followed by a small stomach surrounded by the digestive gland; thence the intestine extends, and, after coiling in the visceral hump, passes forward to end on the right side anteriorly beside the respiratory aperture. The digestive tract is muscular, and in part ciliated internally.

A large part of the visceral spiral is occupied by the so-called "liver." This gland has two lobes, each of which opens by a duct into the stomach. The left lobe is again imperfectly divided into three. Besides producing juices which digest all kinds of food, the gland makes glycogen, stores phosphate of lime, and contains a greenish pigment. It is thus more than a "liver," more even than a "hepatopancreas," it is a complex digestive gland, producing several digestive ferments. The phosphate of lime may possibly be used to form the autumnal epiphragm.

Vascular system.—The blood contains some colourless amœboid cells, and a respiratory pigment called hæmocyanin, which gives the oxidised blood a blue tint, and is very common among Molluscs.

The heart, with a ventricle and a single auricle, lies in a pericardial chamber on the dorsal surface, to the left side, behind the mantle cavity. The average number of pulsations in Gasteropods is about one hundred per minute, but in the hibernating snail the beating is scarcely perceptible.

From the ventricle pure blood flows by cephalic and visceral arteries to the head, foot, and body, passes into fine ramifications of these arteries, and thence into spaces among the tissues. From these the blood is collected in larger venous spaces, and eventually in a pulmonary sinus around the mantle cavity, on the roof of which there is a

network of vessels. There the blood is purified. Most of it returns directly to the auricle by a large pulmonary vein, but some passes first through the kidney.

Respiratory system.—Most Gasteropods, *e.g.* the dogwhelk (*Purpura*), the buckie (*Buccinum*), the periwinkle (*Littorina*), breathe by gills covered by the mantle. The snail being entirely terrestrial, has a pulmonary or lung cavity, formed by the mantle fold. On the roof of this cavity the blood vessels are spread out. Air passes into and out of the pulmonary chamber by the respiratory aperture. When the animal is retracted within its shell, the freshening of the air in the pulmonary chamber takes place by slow diffusion, but when the snail extends itself at full length, the chamber is rapidly filled with air, and it is even more rapidly emptied when the body is withdrawn into the shell.

Excretory system.—There is a single triangular greyish kidney behind the pulmonary chamber, between the heart and the rectum. It is a sac with plaited walls, and excretes nitrogenous waste products, which pass out by a long ureter running along the right side of the pulmonary chamber, and opening close beside the anus. There are two sources of blood supply to the kidney—(*a*) from the pulmonary chamber, and (*b*) from the heart by a renal artery. As in most other Molluscs, the kidney communicates by a small aperture with that part of the cœlom which forms the pericardial sac. Thus, as in earthworm, lobworm, etc., the cœlom has a nephridial connection with the exterior.

Reproductive system.—The snail is hermaphrodite, and its reproductive organs exhibit much division of labour.

(*a*) The essential reproductive organ (the *ovotestis*) is a whitish body near the apex of the visceral spire. It consists of numerous cylindrical follicles, in each of which both ova and spermatozoa are formed, but not at the same time.

(*b*) A much-convoluted *hermaphrodite duct* of a white colour conducts the sex cells from the ovotestis, and leads to the base of a large yellowish albumen gland.

(*c*) This tongue-shaped *albumen gland* varies in size with the age and sexual state of the snail. It forms gelatinous proteid material, which envelops and probably nourishes the ova.

(*d*) The ova and spermatozoa pass from the hermaphrodite

duct towards the head along a *common duct*, but not at the same time. Moreover, their paths are different, for the portion of the duct down which the ova travel is much plaited, while the path which the spermatozoa follow is a

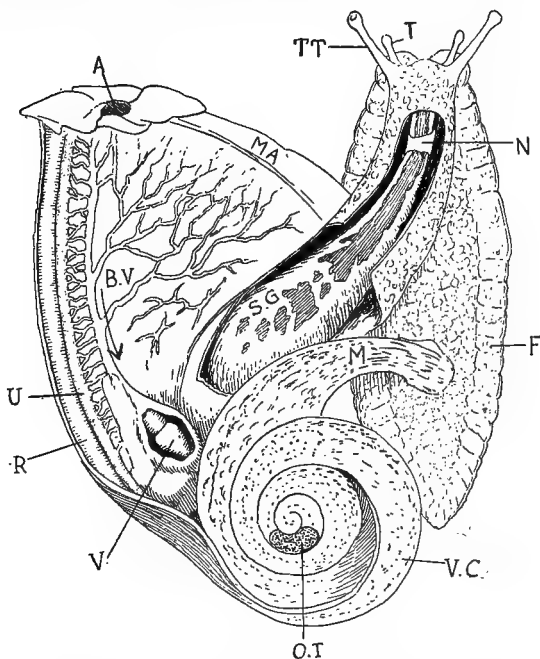

FIG. 209.—Dissection of snail.

T., Short horn; TT., long horn with eye; N., cerebral ganglia; S.G., salivary glands on the crop; F., foot; M., columellar muscle; V.C., visceral coil; O.T., ovotestis; V., ventricle of heart; R, rectum; U, ureter; B.V., blood vessels returning to the auricle from the mantle; A., pulmonary aperture; MA., edge of the mantle.

less prominent groove, incompletely separated from the other. Both paths are glandular, and the glands on the male side are often called prostatic.

(e) At the base of this common duct, a distinct *vas deferens* diverges to the left and leads into a muscular *penis*,

which can be protruded at the single genital aperture and retracted by a special muscle. Before the vas deferens enters the penis, a long process or *flagellum* is given off. It is like the lash of a whip, and is as long as the common duct. Its secretion is used in forming a sperm-packet or spermatophore of a large number of spermatozoa, which are

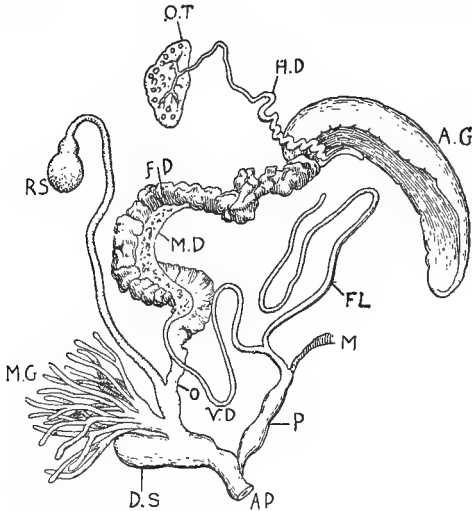

FIG. 210.—Reproductive organs of *Helix pomatia*.—
After Meisenheimer.

O.T., Ovotestis; H.D., hermaphrodite duct; A.G., albumen gland; F.D., female side of common duct; M.D., male side of common duct; O., oviduct; R.S., receptaculum seminis; M.G., mucus glands; D.S., dart-sac; V.D., vas deferens; FL., flagellum; P., penis; M., retractor muscle of penis; AP., genital aperture.

compacted together at the time of sexual union partly in the flagellum, partly in the penis. The spermatophore is transferred by the penis into the genital aperture of another snail.

(f) Continued from the oviducal side of the common duct, there is a separate ciliated *oviduct*. This has a short course, and ends in the common genital aperture. Before

it reaches this, however, the oviduct is associated with two structures. The first of these is a long process, as long as the common duct beside which it runs, in appearance suggesting the flagellum, but expanding at its free end into a globular sac—the *receptaculum seminis* or *spermatheca*. In *Helix aspersa* a long slender diverticulum is given off from the duct of the receptaculum. This is also occasionally seen in *Helix pomatia*. A spermatophore from another

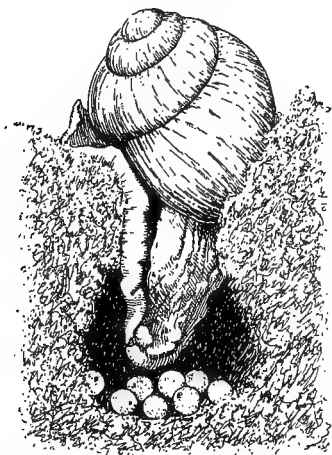

FIG. 211.—Snail (*Helix pomatia*) laying its eggs.—
After Meisenheimer.

snail passes into the receptaculum, and is there dissolved after some days, liberating hundreds of spermatozoa. By these spermatozoa the ova of the snail are fertilised. It seems likely that the place of fertilisation is in a small diverticulum at the upper end of the oviducal side of the common duct, whither the spermatozoa are said to find their way. The second structure associated with the female duct is a conspicuous *mucus gland*, formed of two sets of finger-like processes. The secretion is very abundant during copulation, and as it contains not a little lime, it is possible that it may form the calcareous shells of the eggs.

It seems to serve as a lubricant which facilitates the expulsion of a calcareous dart and the copulation.

(g) Finally, between the entrance of oviduct and penis into the terminal aperture there lies a firm cylindrical structure, larger than the penis and with muscular walls. It is the *Cupid's Dart Sac*, and contains a pointed calcareous arrow (*spiculum amoris*), which is jerked out previous to copulation. The dart is sometimes found adhering to the foot of a snail, and after copulation the sack is empty, soon, however, to be refilled.

When two snails pair, the genital apertures are dilated, the

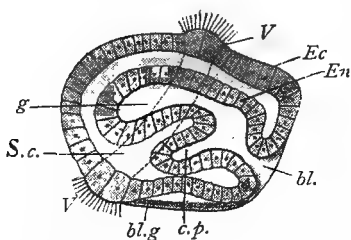

FIG. 212.—Diagram of larva of *Paludina*.—After Erlanger.

Ec., Ectoderm; *En.*, endoderm; *v.*, velum, with cilia; *g.*, gut-cavity; *S.c.*, segmentation cavity; *c.p.*, coelom pocket from gut; *bl.g.*, blastopore groove closed, except at *bl.*, which becomes the anus. The origin of the mesoderm from a gut-pocket has as yet only been described in *Paludina* among Mollusca.

protruded penis of one is inserted into the aperture of the other, and the spermatophore of each snail is transferred to the receptaculum of the other.

The large eggs are laid in the earth in June and July. Each is surrounded by gelatinous material acquired in the oviduct and by an elastic but calcareous shell.

Segmentation is total but slightly unequal. As the snail is a terrestrial Gasteropod, there is no

trochosphere larva, nor more than a slight hint of the characteristic Molluscan velum. A miniature adult is hatched in about three weeks. The study of development may be more profitably followed in the pond-snail *Limnaeus*, where gastrula, trochosphere, and veliger can be readily seen.

Second Type of MOLLUSCA. The Fresh-water Mussel (*Anodonta cygnea*), one of the Lamellibranchiata

Habit.—The fresh-water mussel lives in rivers and ponds. It lies with its head end buried in the mud, or moves slowly along by means of its ploughshare-like foot. Its food

consists of minute plants and animals, which are wafted in at the posterior end by the currents produced by the ciliated gills. What is noted here in regard to *Anodonta* will also apply, for the most part, to *Unio* and other fresh-water mussels.

External appearance.—The bivalve is 4 to 6 in. long; its valves are equal and united in a dorsal hinge by an elastic ligament, an uncalcified part of the shell; on the ventral surface when the valves gape the foot protrudes; the anterior end is rounded, the posterior end is more pointed, and it is there that the water currents flow in (ventrally) and out (dorsally). In bivalves the ligament is generally posterior to the dorsal knob or *umbo*—the oldest part of the shell—and the umbo generally points towards the anterior end. The greenish brown soft (“horny”) layer of the shell is often worn away near the umbo on each side, and then displays the median layer of lime. This is called prismatic, since the lime salts are deposited in prisms, transversely varicose or striated, like those which form the enamel of our teeth. Internally there is a pearly layer. Lines of growth on the shell mark the position of the margin in former years, the newest part being obviously at the edge.

The shell is a cuticular structure, *i.e.* it is made by the epidermis of the mantle. It consists, as in the snail, of calcium carbonate plus conchiolin or conchin. Thus the composition of a *Pinna* shell is:—Lime salts, 89·2; organic matrix, 1·3; water, 9·5.

Internal appearance.—When the right half of the shell is folded back, the anterior and posterior closing muscles having been carefully cut close to the gently raised valve, the mantle folds are seen lining the shell, and forming posteriorly the ventral inhalant and dorsal exhalant lips. The ventral lips have papillary processes. Internal to the mantle there are two gill-plates on each side; projecting from between these is the foot, muscular ventrally, softer dorsally; the median dorsal pericardium is just beneath the ligament; the ventricle shines through its walls, and the dark-coloured kidneys are seen through its floor. Below the anterior adductor muscle is the large mouth, bordered beneath by two lip processes (labial palps) on each side.

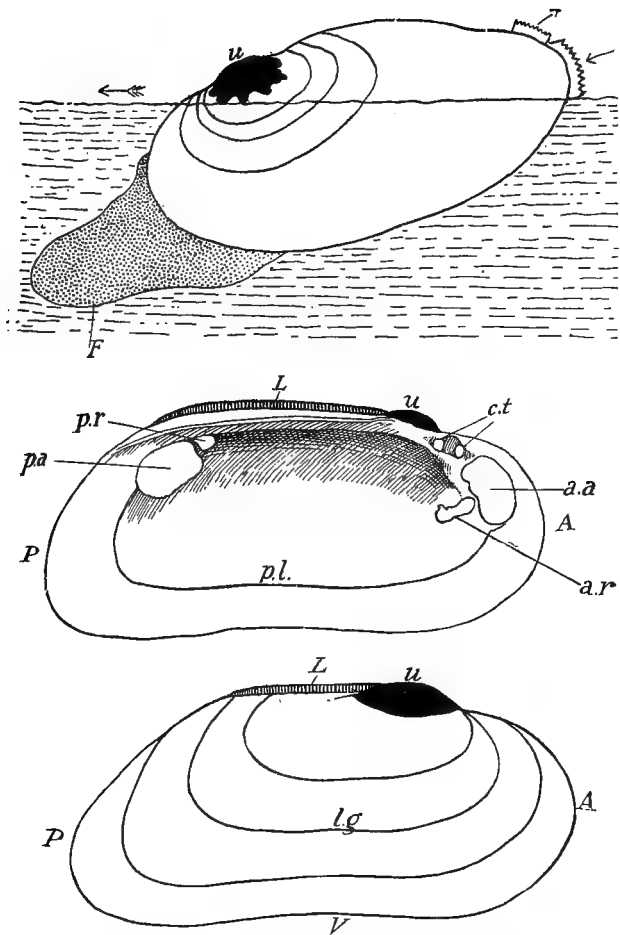

FIG. 213.—The fresh-water mussel (*Unio*).

The uppermost figure represents the bivalve in motion in the mud with protruded foot (*F.*); note inhalant and exhalant apertures. The middle figure shows the inside of the shell (left valve). The lower figure shows the outside (right valve). *u.*, The umbo; *L.*, the ligament; *c.t.*, lateral teeth; *a.a.*, anterior adductor mark; *a.r.*, mark of protractor of the foot; *pl.*, pallial line; *p.a.*, posterior adductor mark; *p.r.*, mark of posterior retractor of the foot; *lg.*, a line of growth; *A.*, anterior (the blunter end); *P.*, posterior; *V.*, ventral.

These resemble the gills in appearance, and are probably modified portions of the gills. The anus is above the posterior closing muscle. The whole space between the two mantle flaps is called the mantle cavity, and it is divided by a slight partition at the bases of the gills into a large ventral infra-branchial chamber and a small dorsal supra-branchial chamber which ends at the exhalant orifice.

On the surface of the valves of the shell a few small pearls may be seen; they are formed by the enclosure of some minute grains of sand in the prismatic layer. There are two teeth in front of the umbo in *Unio*, but not in *Anodonta*. The following muscles are inserted on the shell, and leave impressions:—

- (a) The anterior adductor.
- (b) The posterior adductor.
- (c) The anterior retractor of the foot continues with (a).
- (d) The protractor of the foot a little below (a).
- (e) The posterior retractor of the foot continues with (b).

As the shell grows, the insertion of the muscles and the attachment of the mantle change, and the traces of this shifting are visible.

Skin.—There is much ciliated epithelium about *Anodonta*, especially on the internal surface of the mantle, on the gills, and on the labial palps; and little pieces cut from an animal incompletely dead (*e.g.* from the oyster swallowed half-alive) have by means of their cilia a slight power of motion. The skin of the foot is not ciliated but glandular; on the mantle edge sensitive and glandular cells are abundant, but usually in inverse ratio to one another.

Muscular system.—The shell is closed and kept closed by the action of the two adductor muscles. When these are relaxed under nervous control, the elasticity of the hinge ligament opens the valves. The foot is a muscular protrusion of the ventral surface, under the control of three muscles—a retractor and a protractor anteriorly, and a posterior retractor. Its upper portion contains some coils of gut and the reproductive organs; its lower region is very muscular. The protrusion or extension of this locomotor organ is mainly due to an inflow of blood, which is prevented from returning by the contraction of a sphincter muscle round the veins. In moving, the animal literally ploughs its way along the bottom of the pond or river pool,

and leaves a furrow in its track. The muscle fibres, as in the snail, are mainly of the slowly contracting non-striped sort, but those of the adductor and of the heart show oblique cross-stripping. In that part of the adductor muscle of *Pecten* (and some other bivalves) that effects the rapid closing of the valves, and hence the swimming, the muscle-fibres are transversely cross-striped, and the same is true of those found in the margin of the mobile mantle. There is here therefore a good instance of the connection between striation and rapidity of contraction and relaxation.

Nervous system.—There are three pairs of nerve-centres:—

- (a) *Cerebro-pleural ganglia*, lying above the mouth on each side on the tendon of the anterior retractor of the foot, connected to one another by a commissure, connected to the two other pairs of ganglia (b) and (c), by long paired connectives, and giving off some nerves to mantle, palps, etc.
- (b) *Pedal ganglia*, lying close together about the middle of the foot, united by connectives to (a), giving off nerves to the foot, and having beside them two small ear-sacs, each with a calcareous otolith, and with a nerve said to be derived from the cerebral ganglion.
- (c) *Visceral ganglia* (also called parieto-splanchnic or osphradial), lying below the posterior adductor, connected to (a) by two long connectives, and giving off nerves to mantle, muscles, etc., and to a patch of "smelling cells" (*osphradium*) at the bases of the gills.

Sense organs.—Unlike not a few bivalves, which have hundreds of "eyes" on the mantle margin, *Anodonta* has no trace of any. The ear-sac, originally derived from a skin-pit, is sunk deeply within the foot, and is of doubtful use. The "smelling patch" or "*osphradium*" at the base of the gills has perhaps water-testing qualities. There are also "tactile" cells about the mantle, labial palps, etc.

Alimentary system.—The mouth lies between the anterior adductor and the foot, and beside it lie the ciliated, vascular, and sensitive labial palps, two on each side, which

waft food into the mouth. It opens immediately into the gullet, for the pharynx of other Molluscs, with all its associated structures, is absent in Lamellibranchs. The short wide gullet leads into a large stomach surrounded by a paired digestive gland. Part of the food digested by

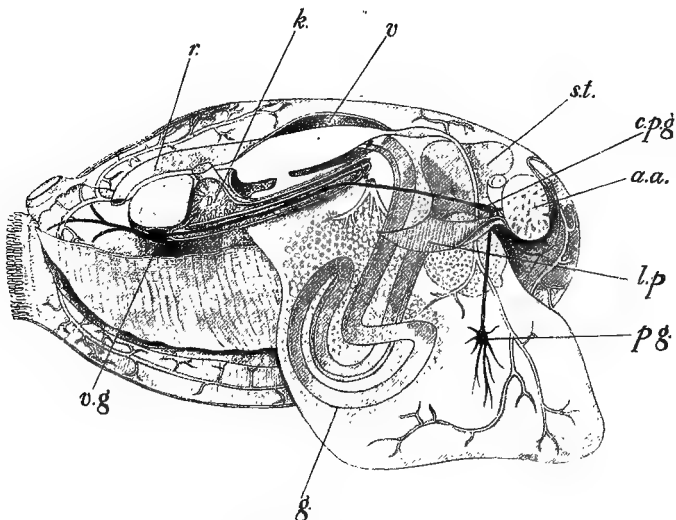

FIG. 214.—Structure of *Anodonta*.—After Rankin.

a.a., Anterior adductor; *c.p.g.*, cerebro-pleural ganglia; *st.*, stomach; *v.*, ventricle, with an auricle opening into it; *k.*, kidney, above which is the posterior retractor of the foot; *r.*, rectum ending above posterior adductor; *v.g.*, visceral ganglia with connectives (in black) from cerebro-pleurals; *g.*, gut coiling in foot; *p.g.*, pedal ganglia in foot, where also are seen branches of the anterior aorta and the reproductive organs; *l.p.*, labial palps behind mouth. At the posterior end the exhalant (upper) and inhalant (lower) apertures are seen.

these juices in the stomach is compacted in autumn into a "crystalline style"—a mass of reserve foodstuffs, and similar but less solid material is found in the intestine. On this supply the mussel tides over the winter. The intestine, which has in part a folded wall like that of the earthworm, coils about in the foot, ascends to the pericardium, passes

through the ventricle of the heart, and ends above the posterior adductor at the exhalant orifice.

Vascular system.—The heart lies in the middle line on the dorsal surface, within a portion of the body cavity called the pericardium, and consists of a muscular ventricle which has grown round the gut and drives blood to the body, and of two transparent auricles—one on each side of the ventricle—which receive blood returning from the gills and mantle. In bivalves the heart-beats average about twenty per minute, much less than in Gasteropods. The colourless blood passes from the ventricle by an anterior and a posterior artery; flows into ill-defined channels; is collected in a “vena cava” beneath the floor of the pericardium; passes thence through the kidneys, where it loses nitrogenous waste, to the gills, where it loses carbonic acid and gains oxygen; and returns finally by the auricles to the ventricle. The blood from the mantle, however, returns directly to the auricles without passing through kidneys or gills, but probably freed from its waste none the less. The so-called “organ of Keber” consists of “pericardial glands” on the epithelium of the pericardial cavity. They seem to be connected with excretion. Many of the cells lining the blood channels secrete glycogen, the principal product of the Vertebrate liver.

Respiratory system.—Lying between the mantle flaps and the foot there are on each side two large gill-plates, whence the title Lamellibranch. They are richly ciliated; their internal structure is like complex trellis-work; their cavities communicate with the supra-branchial chamber. As in many other Molluscs, the gills or ctenidia are not merely surfaces on which blood is purified by the washing water-currents (a respiratory function), but some of their many cilia waft food-particles to the mouth (a nutritive function), and in the females the outer gill-plate shelters and nourishes the young larvæ (a reproductive function). The water may pass *through* the gills to the supra-branchial chamber and thence out again, or *over* the gills to the mouth, and thence into the supra-branchial chamber. It is likely that the mantle has no small share in the respiration. In many cases, e.g. *Lutraria elliptica*, the posterior end of the mantle gives origin to a contractile respiratory siphon, a

double tube, the upper half of which is expiratory and the lower half inspiratory. A cross-section shows a cuticular investment of conchin, a layer of epidermis, a narrow zone of circular muscle-fibres, a thick zone of longitudinal muscle-fibres, a narrow zone of circular muscle-fibres, an internal epithelium, and the two canals. The white circular muscle-fibres are unstriped; the longitudinal muscle-fibres, which are greyish yellow, show a lozenge-shaped marking as in the more opaque fibres of the adductor muscles.

The precise structure and attachment of the gill-plates is complex, but it is important to understand the following facts:—(a) A cross section of the two gill-plates on one side has the form of a W, one half of which is the outer, the other the inner gill-plate; (b) each of these gill-plates consists of a united series of gill filaments, which descend from the centre of the W and then bend up again; (c) adjacent filaments are bound together by fusions and bridges both horizontal and vertical, so that each gill-plate becomes like a complex piece of basket work; (d) both gill-plates begin by the downward growth of filaments from a longitudinal "ctenidial axis," the position of which on cross-section is at the median apex of the W; (e) this mode of origin, and the much less complex gills of other bivalves, lead one to believe that there is on each side one gill consisting of two gill-plates formed from a series of united and reflected gill filaments. On the gills there are often parasitic mites (*Unionicola* or *Atax ypsilophorus*).

Excretory system.—The paired kidney, which used to be called the "organ of Bojanus," lies beneath the floor of the pericardium. Each half is a nephridium bent upon itself, with the loop posterior, the two ends anterior. The lower part of this bent tube is the true kidney; it is dark in colour, spongy in texture, and excretes guanin and other nitrogenous waste from the blood which passes through it. It has an internal opening into the pericardium, which thus communicates indirectly with the exterior. The upper part of the bent tube, lying next the floor of the pericardium, is merely a ureter. It conveys waste products from the glandular part to the exterior, and opens anteriorly just under the place where the inner gill-plate is attached to the visceral mass. As already mentioned, the "pericardial glands" probably aid in excretion, and possibly the same may be said of the mantle.

The reproductive organs.—These lie in the upper part of the foot, adjacent to the digestive gland. Ovaries and

testes occur in different animals, and the two sexes are distinguishable, though not very distinctly, by the greater whiteness of the testes and by slight differences in the shells. The females are easily known when the larvæ begin to accumulate in crowds in the outer gill-plates. The reproductive organs are branched and large; there are no accessory structures; the genital aperture lies on each side under that of the ureter.

The ova pass from the ovaries in the foot, and appear to be moved to the exhalant region, whence, however, they do not escape, but are crowded backward till they pass into the cavity of the outer gill-plate. At some stage they are fertilised by spermatozoa drawn in by the water currents, though it is difficult to believe that this is entirely a matter of chance. Development takes place within the external gill-plate, and the larvæ feed for some time on mucus secreted by the gill.

Development and life history.—The development of *Anodonta* differs in certain details from that of most bivalves, perhaps in adaptation to fresh-water conditions. Moreover, a temporary parasitism of the larva has complicated the later stages.

The egg-cell is surrounded by a vitelline membrane, and attached to the wall of the ovary by a minute stalk, the insertion of which is marked on the liberated ovum by an aperture or micropyle, through which the spermatozoon enters.

Segmentation is total but unequal. A number of small clear yolkless cells are rapidly divided off from a large yolk-containing portion, which is slower in dividing. Eventually a hollow ball of cells or blastosphere results (Fig. 215).

On the posterior dorsal region a number of large opaque cells form an internally convex plate,—the beginning of the future shell-sac. A pair of large cells are intruded into the central cavity, and begin the mesoderm.

On the under surface posteriorly there is a slight protrusion of ciliated cells forming a ciliated disc. In front of this, at an unusually late stage, an invagination establishes the archenteron, and the embryo becomes a gastrula (see Fig. 215).

The shell-sac forms an embryonic shell, and many of the mesoderm cells combine in an adductor muscle. The mouth of the gastrula closes, and a definite mouth is subsequently formed by an ectodermic invagination. Gradually a larva peculiar to fresh-water mussels, and known as a Glochidium, is built up.

The Glochidium has two triangular, delicate, and porous shell valves, each with a spiny incurved tooth on its free edge. The valves clap together by the action of the adductor muscle. The mantle lobes are very small, and their margins bear on each side three or four patches of

sensory cells. The foot is not yet developed, but from the position which it will afterwards occupy there hang long attaching threads of "byssus," which moor the larva. If it manage to anchor itself on the tail, fins, or gills of a fish, the Glochidium shuts its valves and fixes itself more securely, and is soon surrounded by a pathological growth of its host's skin.

In this parasitic stage a remarkable metamorphosis occurs. The sensory or tactile patches not unnaturally disappear; the "byssus"

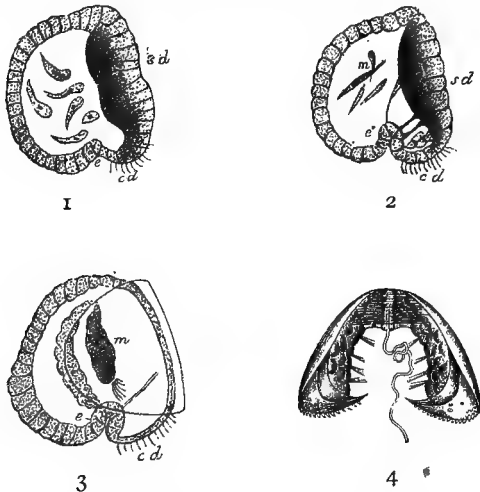

FIG. 215.—Development of *Anodonta*.—After Goette.

1. Section of blastosphere. *s.d.*, Shell gland; *c.d.*, ciliated disc; *e.*, beginning of ectodermic invagination. Note mesoderm cells in the cavity.
2. Later stage. *m.*, Mesoderm.
3. Embryonic shell has appeared.
4. Glochidium larva; note byssus threads, and teeth on shell valves.

and the embryonic "byssus glands" vanish, but a true byssus gland (which remains quite rudimentary in *Anodonta*) appears; the single adductor atrophies, and is replaced by two; the foot and the gills make their appearance; the embryonic mantle lobes increase greatly, or are replaced by fresh growths; and the permanent shell begins to be made.

After this metamorphosis, when the larva has virtually become a miniature adult, no longer so liable to be swept away, it drops from its temporary host to the bottom of the pond or river pool.

Third Type of MOLLUSCA. The Common Cuttlefish (*Sepia officinalis*), one of the Dibranchiate Cephalopods

Habits.—This common cuttlefish is widely distributed, especially in warmer seas like the Mediterranean. Unlike *Octopus*, which usually lurks passively, *Sepia* is an active swimmer; it moves head foremost by working the fins which fringe the body, or it jerks itself energetically backwards by the outgush of water through the funnel. It likes the light, and is sometimes attracted by lanterns. The beautiful colours change according to external conditions and internal emotions; and a plentiful discharge of ink

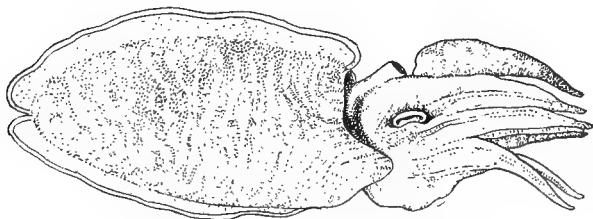

FIG. 216.—Side view of *Sepia*.—After Jatta.

often covers its retreat from an enemy. Its food includes fish, other molluscs, and crabs. In spring the female attaches her encapsuled eggs to seaweeds and other objects, and often comes fatally near the shore in so doing. The cuttles are caught for food and bait. The “cuttle bone” and the pigment of the ink-bag are sometimes utilised by man.

External appearance.—A large *Sepia* measures about 10 in. in length and 4 to 5 in breadth; the body, fringed by a fin, is shaped like a shield, the broad end of which bears a narrowed head, with eight short and two long sucker-bearing arms. Besides the diffuse pigment cells, there are bands across the “back.” The large eyes, the parrot-beak-like jaws protruding from the mouth, the spout-like funnel on the neck, and the mantle cavity, are conspicuous. Beside the eyes are the small olfactory pits;

within the mantle cavity lie the anus and the openings of the nephridia and genital duct.

The true orientation of the different regions in *Sepia* is not obvious. If the "arms" surrounding the mouth be divided portions of the anterior part of the "foot," the *ventral* surface is that on which the animal rests when we make it stand on its head. We can fancy how the "foot" of a snail might grow forward and surround the mouth, so as to bring that into the middle of the sole. Then the visceral mass has been elongated in an oblique dorso-posterior direction, so that the tip of the shield, directed forward when the cuttle jerks itself away from us, represents in anatomical strictness the *dorsal* surface tilted backwards. (As above noticed, the animal may also swim with foot and mouth in front.) The side of lighter colour, marked by the mantle cavity and the siphon or funnel, is *posterior* and slightly *ventral*; the banded and more convex side, on which the cerebral ganglia lie in the head region, and on which the shell lies concealed in the visceral region, is *anterior* and slightly *dorsal*.

Skin.—There are numerous actively changeful pigment cells or chromatophores lying in the connective tissue beneath the epidermis. Each cell is expanded by the contraction of muscular cells which radiate from it, and contracts when these relax. It is probable that these chromatophore cells have some protoplasmic spontaneity of their own, but the controlling muscular elements are also affected by nervous impulses from the central ganglia. As the cells dilate or contract, the pigment is diffused or concentrated, and the colours change. The animal's beauty is further enhanced by numerous "iridocysts" or modified connective tissue cells, with fine markings which cause iridescence.

Muscular system.—The cuttlefish is very muscular, notably about the arms, the mantle flap, and the jaws. Many of the muscles show double oblique striping. The animal seizes its prey by throwing out its two long arms, which are often entirely retracted within pouches. With great force it jerks itself backwards by contracting the mantle cavity, and making the water gush out through the pedal funnel. This mode of locomotion is very quaint.

At one time the mantle cavity is wide, and you can thrust your fingers into its gape; when about to contract, this gape is closed by a strange double hook-and-eye arrangement; contraction occurs, and the water, no longer free to leave as it entered, gushes out by the funnel, the base of which is within the mantle cavity. The suckers on the arms are muscular cups, borne on little stalks (unstaked in *Octopus*, etc.), well innervated, and able to grip

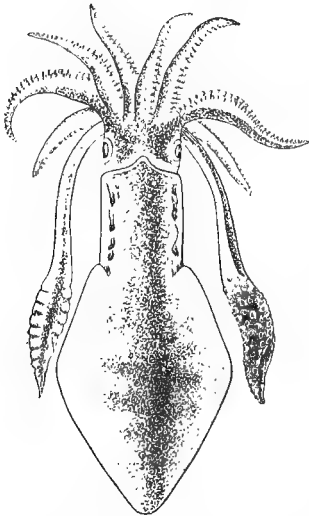

FIG. 217.—External appearance of a cuttlefish (*Loligo*).

with a tenacity which in giant cuttlefish is dangerous even to men. The inner edge of the cup margin is supported by a chitinoid ring bearing small teeth. Each cup acts as a sucker, in a fashion which has many analogues, for a retractor muscle increases the size of the cavity after the margin has been applied to some object. The external pressure is then greater than that within the cup, and the little teeth keep the attachment from slipping.

It seems likely that the arms represent a propodium, and the siphon a mesopodium, and a valve within the siphon has been compared to a metapodium.

Skeletal system.—An internal skeleton is represented by supporting cartilaginous plates in various parts of the body, especially—(a) in the head, round about the brain, arching over the eyes, enclosing the “ears”; (b) at the bases of the arms; (c) as a crescent on the neck; (d) at the hook-and-eye arrangement of the mantle flap; (e) along the fringing fins. Ramified “stellate” cells lie in the structureless transparent matrix of the cartilage.

On the shore one often finds the "cuttle bone" or sepio-staire, which is sometimes given to cage birds to peck at for lime, or used for polishing and other purposes. It lies on the dorsal side of the animal, covered over by the mantle sac. In outline it is somewhat ellipsoidal, thinned at the edges like a flint axe-head, and with curved markings which indicate lines of growth. In the very young *Sepia* it consists wholly of the organic basis conchiolin, but to this lime is added from the walls of the sac. Between the plates of lime there is gas, and though the structure may give the cuttle some stability, it is probably of more use as a float.

Internal appearance.—When the mantle flap is cut open and reflected, the two plume-like gills are seen, and the lower end of the siphon. The dark outline of the ink-bag, followed along towards the head, leads our eyes to the end of the food canal. Near this are the external apertures of the two kidneys and of the genital duct. On each side of the base of the funnel lies a very large and unmistakable "stellate" ganglion. Removing the skin as carefully as possible over the whole visceral region between the gills, and taking precautions not to burst the ink-sac, we see the median heart, the saccular kidneys, contractile structures or branchial hearts at the base of each gill, and the essential reproductive organs near the apex of the visceral mass. Disturbing the arrangement of these organs, we can follow the food canal, with its stomach, digestive gland, etc.

Nervous system.—Three pairs of ganglia surround the gullet,—cerebral on the dorsal and anterior side, pedal and pleuro-visceral on the ventral and posterior side (Fig. 218), but lying so close together that their boundaries are defined with difficulty. All are well protected by the investing cartilages.

The cerebral ganglia are three-lobed, and are connected anteriorly by two commissures with a "supra-pharyngeal" ganglion, which gives off nerves to the mouth and lips, and is connected also with an "infra-pharyngeal" ganglion. The cerebral ganglia are also connected by short double commissures with the pedals and pleuro-viscerals on the ventral side of the gullet. The pedal ganglia at each side are in part divided into two,—one half forming the brachial ganglion which sends nerves to the arms, the other the infundibular which supplies the funnel.

The following chief nerves arise from the central system :—

- (1) The very thick optic nerves are given off from the commissures between cerebrals and pleuro-viscerals, and lead to a large optic ganglion at the base of each eye.
- (2) Ten nerves to the "arms" are given off by the pedal ganglion, and this is one of the reasons which have led most morphologists to regard these arms as portions of the "foot."
- (3) Two large nerves from the more ventral portion of the pleuro-visceral ganglia form a visceral loop, and give off many branches to the gills and other organs. From the pleural portion arise two mantle nerves, each of which ends in a large stellate ganglion.

Sense organs.—The eyes are large and efficient. They present a striking resemblance to those of Vertebrates, and, as they are not "brain eyes," they illustrate how superficially similar structures may be developed in different ways and in divergent groups. In cuttlefishes the eyes lie on the sides of the head, protected in part by the cartilage surrounding the brain, and in part by cartilages on their own walls.

The eye is a sensitive cup arising in great part from the skin. Its internal lining is a complex retina, on the *posterior* surface of which the nerves from the optic ganglion are distributed. It seems likely that the Cephalopod retina corresponds only to the rods and cones (the sensory part) of the Vertebrate retina. In the cavity of the cup there is a clear vitreous humour.

The mouth of the cup is closed by a lens, supported by a "ciliary body." The lens seems to be formed in two parts—an outer and an inner plano-convex lens. The pupil in front of it is fringed by a contractile iris.

The outer wall of the optic cup is ensheathed by a strong supporting layer—the sclerotic, which is in part strengthened by cartilage, covered by a silvery membrane, and continued into the iris.

In front of the eye there is a transparent cornea, and the skin also forms protecting lids.

Round about the optic ganglion there is a strange "white body," which seems to be a fatty cushion on which the eye rests.

The two ear-sacs, containing a spherical otolith and a fluid, sometimes with calcareous particles, are enclosed in part of the head cartilage, close to the pedal ganglia. The nerves seem to come from the pedals, but it is said that their fibres can be traced up to the cerebrals.

A ciliated "olfactory sac" lies behind each eye, and is innervated from a special ganglion near the optic. There are no osphradia of the usual type.

Finally, there are tactile or otherwise sensitive cells on various parts of the body, especially about the arms.

Apart from sight altogether, an octopus can find a dead fish at a distance of over a yard in a few minutes, and even slight movements in the water are detected.

In many Decapods there are luminous organs, usually on the ventral surface in diverse positions, and often buried. They may serve as recognition-marks or as search-lights. They may be glandular or

non-glandular, and those of the second type are often somewhat eye-like, with pigment layer, reflector, lens, and diaphragm, or with some of these structures.

Alimentary system.—The cuttlefish eats food which requires tearing and chewing, and this is effected by the chitinous jaws worked by strong muscles, and by the toothed radula moving on a muscular cushion. The mouth lies in the midst of the arms, bordered by a circular lip, and opens into a large pharynx or buccal cavity (cf. the snail). The narrow gullet passes through the ganglionic mass, and leads into the globular stomach, lying near the dorsal end of the body. The stomach is followed by a cæcum or pyloric sac, and the intestine curves headwards again, to end far forward in the mantle cavity. There do not seem to be any glands on the walls of the food canal; the stomach has a hard cuticle; the digestion which takes place there must therefore be due to the digestive juices of the glandular annexes. Of these the most important is usually called the liver; it is bilobed, and lies in front of the stomach, attached to the œsophagus. Its two ducts conduct the digestive juice to the region where the stomach, "pyloric sac," and intestine meet; and these ducts are fringed by numerous vascular and glandular appendages, which are called "pancreatic," and arise from the wall of the unpaired portion of the nephridia. Far forward, in front of the large digestive gland, lie two small white glands on each side of the gullet, with ducts which open into the mouth (cf. the "salivary glands" of the snail). A diastatic ferment has been proved in the salivary secretion of

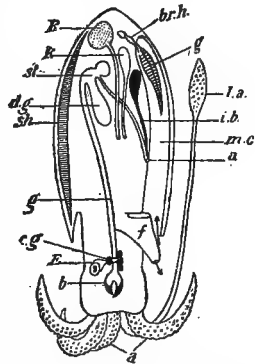

FIG. 218.—Diagram of the structure of *Sepia*.—Mainly after Pelseneer.

a., Eight short arms around mouth; *i.a.*, one of the two long arms; *b.*, beak of the mouth; *c.g.*, cerebral ganglia, with commissures to the others; *E.*, eye; *g.*, gullet; *d.g.*, digestive gland (the "salivary glands" are not represented); *st.*, stomach; *a.*, anus; *sh.*, shell-sac with septostaire; *k.*, kidney; *R.*, reproductive organ; *br.h.*, branchial heart; *g.*, a gill; *i.b.*, ink-bag; *m.c.*, mantle cavity; *f.*, funnel.

Cephalopods, but that of *Octopus* has a poisonous, paralysing effect on the crabs, etc., which are bitten, and also a peptonising action. At the other end of the food canal, the ink-sac, full of black pigment, probably of the nature of waste products, opens into the rectum close to the anus. This ink-sac is a much enlarged anal gland; for, while most of the bag is made of connective tissue and some muscle fibres, a distinct gland is constricted off at the closed end, and the neck is also glandular. Beside the anus are two pointed papillæ.

Vascular system.—The blood of *Sepia* is bluish, owing to the presence of hæmocyanin in the serum; the blood cells are colourless and amœboid. The median but somewhat oblique ventricle of the heart drives the blood forward and backward to all parts of the body. It reaches the tissues by capillaries, and apparently also by lacunar spaces. The venous blood of the head region is collected in an annular sinus round the basis of the arms, and passes towards the heart by a large vena cava, which divides into two branchial veins, covered by spongy outgrowths of the nephridia. Joined by other vessels from the apical region of the viscera, each branchial vein enters a “branchial heart” at the base of each gill. The branchial heart is contractile, and drives the venous blood through the gills, whence, purified, it returns by two contractile auricles into the ventricle. There are valves preventing back-flow from the ventricle to the auricles, or from the arteries to the ventricle. Beside each branchial heart lies an enigmatical glandular structure known as a “pericardial gland,” possibly an excretory or incipiently excretory organ. The course of the blood differs from that in the mussel and snail in this, that none returns to the heart except from the respiratory organs. In the nephridial outgrowths around the branchial veins the interesting parasite *Dicyema* is found.

Respiratory system.—The blood is purified by being exposed on the two feather-like gills which are attached within the water-washed mantle cavity. The water penetrates them very thoroughly; the course of the blood is intricate. At the base of the gills there is some glandular tissue, which those impatient with enigmas have credited with blood-making powers.

Excretory system.—The excretory system is difficult to dissect and to explain. On each side of the anus there is a little papilla, through which uric acid and other waste products ooze out into the mantle cavity, and so into the water. A bristle inserted into either of these two papillæ leads into a large sac—the nephridial sac. But the two sacs are united by two bridges, and they give off an unpaired dorsal elongation, which extends as far back as the reproductive organs.

The dorsal wall of each nephridial sac becomes intimately associated with the branchial veins, and follows their outlines faithfully. It is likely that waste material passes from the blood through the spongy appendices into the nephridial sacs.

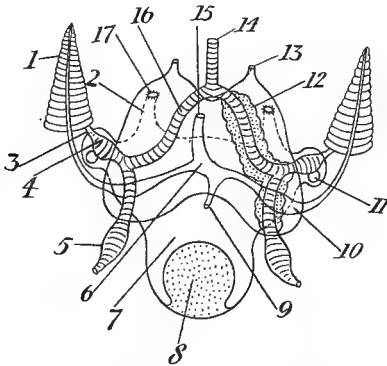

FIG. 219.—Diagram of circulatory and excretory systems in a Decapod-like *Sepia*.—After Pelseener.

- 1, Gill; 2, renal sac; 3, afferent branchial vessel; 4, branchial heart; 5, abdominal vein; 6, heart; 7, visero-pericardial sac (body cavity); 8, genital organ; 9, posterior aorta; 10, "auricle"; 11, glandular appendix of branchial heart; 12, renal appendices of branchial vein; 13, external aperture of kidney; 14, vena cava; 15, anterior aorta; 16, bifurcation of vena cava; 17, reno-pericardial aperture.

Into the terminal portion of each nephridial sac, a little below its aperture at the urinary papilla, there opens by a ciliated funnel another sac, which is virtually the body cavity. It surrounds the heart and other organs, and is often called the visero-pericardial cavity. Through the kidneys or nephridial sacs it is in communication with the exterior. Associated with the branchial hearts there are numerous diminutive cells which contain ammoniacal salts, phosphates, pigment, etc.; these waste products are probably passed into the blood and got rid off by the kidneys, just as, in a Vertebrate, the urea formed in the liver passes by the blood to the kidneys. In Invertebrates there is often this co-operation between "closed kidneys" and "open kidneys."

Reproductive system.—The sexes are separate, but there is not much external difference between them, though the males are usually smaller, less rounded dorsally, and have slightly longer arms. When mature, the male is easily known by a strange modification on his fifth left arm. The essential reproductive organs are unpaired, and lie in the body cavity towards the apex of the visceral mass.

The testis—an oval yellowish organ—lies freely in a peritoneal sac, near the apex of the visceral mass. From this sac the spermatozoa pass along a closely twisted duct—the vas deferens. This expands into a twofold “seminal vesicle,” and gives off two blind outgrowths, of which one is called the “prostate.” The physiological interest of these parts is that within them the spermatozoa begin to be arranged in packets. In this form they are found within the next region, the spermatophore sac, which opens to the exterior to the left of the anus. Each spermatophore is like an automatically explosive



FIG. 220. — Male of *Argonauta* (after Jatta), showing “hectocotylus” arm; compare Fig. 9 of female.

bomb; within the transparent shell there lies a bag of spermatozoa, and a complex spring-like arrangement. Even on the scalpel or slide these strange but efficient bombs will explode. The liberated spermatozoa are of the usual type.

The ovary—a large, rounded white organ—lies freely in a peritoneal sac near the apex of the visceral mass. From this sac the eggs pass along a short direct oviduct, which opens into the mantle cavity to the left of the anus. Associated with the oviduct, and pouring viscid secretion into it, are two large “nidamental glands,” of foliated structure. Close beside these are accessory glands, of a reddish or yellowish colour, with a median and two lateral lobes; while at the very end of the oviduct are two more glands. All seem to contribute to the external equipment of the egg.

The spermatophores pass from the genital duct of the male to the fifth left arm, which becomes covered with them and quaintly modified. This modification of one of the arms is usual among cuttlefish; indeed, in some, e.g. *Argonauta* and *Tremoctopus*, the modified arm, with its load of spermatozoa, is discharged bodily into the mantle cavity of the

female. There its discoverers described it as a parasitic worm, "*Hectocotylus*." The lost arm is afterwards regenerated. In *Sepia*, however, the modified arm is not discharged, but is simply thrust into the mantle cavity of the female. The spermatophores probably enter the oviduct, and burst there.



FIG. 221.—Bunch of *Sepia* eggs attached to plant.—After Jatta.

The eggs, when laid, are enclosed within separate black capsules containing gelatinous stuff, but the stalks of the capsules are united, so that a bunch of "sea-grapes" results.

GENERAL NOTES ON MOLLUSCS

From the description of these three types a general idea of the structure of Mollusca may be obtained, but it should be noted—(1) that all the three types are specialised; (2) that two small classes, the Solenogastres and the Scaphopoda, are unrepresented in the descriptions; (3) that in the three classes to which the types belong there is much diversity of structure, this being especially true of the large and heterogeneous class of Gasteropods.

In surveying the structure of the whole group, it is convenient to begin with the most striking of the external characters—the absence or presence of a well-developed head region.

In the Lamellibranchs or Pelecypoda the head is absent, and along with it the tentacles, the radula, and the

pharynx with all its associated structures. Elsewhere a head region, usually furnished with tentacles and eyes, and containing within it a pharynx and radula, is always present. Best developed in Gasteropods and Cephalopods, the head region may elsewhere be represented, as in *Dentalium*, merely by a buccal tube fringed with tentacles. Apart from Lamellibranchs, the radula is characteristic and, with few exceptions, universal.

Almost as important is the condition of the characteristic Molluscan foot. Primitively this had the form of a ventral creeping sole, as shown, for example, in its simplest

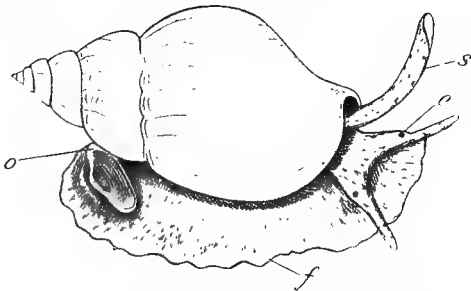

FIG. 222.—Common buckie (*Buccinum undatum*).
e., Eye; s., respiratory siphon; o., operculum; f., foot.

condition, in *Chiton* (Fig. 228). This condition is retained in many Gasteropods, and in the simplest Lamellibranchs, like *Solenomya*. In most Lamellibranchs, however, in adaptation to a more or less passive life in the sand, the foot became wedge-shaped, and the characteristic byssus gland, which secretes attaching threads, is developed. In the Cephalopods the foot became greatly modified, and in those related to *Sepia* a portion of it is specialised as the funnel—the main organ of active locomotion. That the condition of the foot cannot in itself be employed as a basis of classification is, however, obvious, when its differences within the limits of a class are considered. Thus it is obsolete in the pelagic *Phyllirhoë* among Gasteropods, in

the sedentary oyster among Lamellibranchs; in the pelagic Pteropods part of it forms lateral wing-like lobes used in swimming, while in *Ianthina*, which has a similar habit, its chief use is to secrete a "float" to which the egg-capsules are attached. In various Lamellibranchs, and in *Dentalium*, it is modified as a conical boring organ.

The mantle is another important Molluscan structure, and as it secretes the shell, the shape of the latter is of course determined by it. Primitively the mantle is represented by a uniform downgrowth of skin from the dorsal surface, surrounding the ventral foot, and secreting a dorsal cap-shaped shell. Such a simple condition occurs in the limpet. In the Lamellibranchs, with the lateral flattening

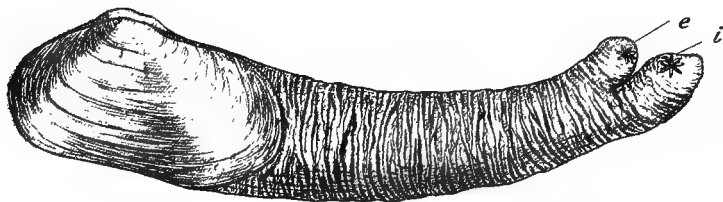

FIG. 223.—Bivalve (*Panopaea norvegica*), showing siphons.

e., Exhalant aperture; *i.*, inhalant aperture.

of the body, the mantle becomes divided into right and left halves, and the shell becomes two-valved. In most Lamellibranchs the mantle is prolonged into two tubes or siphons, through which the water of respiration enters and leaves the mantle cavity. A similar but unpaired siphon is found in many Gasteropods. In Scaphopoda the mantle folds fuse ventrally to form a continuous tube. In most Gasteropods the mantle skirt is retained, and secretes a spiral shell, as well as enclosing a space in which the gills lie; in some, both mantle and shell are absent. In the snail and its allies (Pulmonata), the mantle forms the pulmonary chamber, which opens to the exterior by a small aperture. In Cephalopoda the mantle skirt is well developed and muscular, and, besides sheltering the gills, is of much importance in locomotion.

Typically the Mollusca are bilaterally symmetrical animals, and this symmetry is marked in the Solenogastres, the Lamellibranchiata, and occurs to a less extent in the Cephalopoda (cf. the unpaired genital organs). In most Gasteropoda it is completely lost. This seems to be in some way associated with the dorsal displacement of the viscera in Gasteropods to form the (usually coiled) visceral hump. In Cephalopods there is a somewhat similar dis-

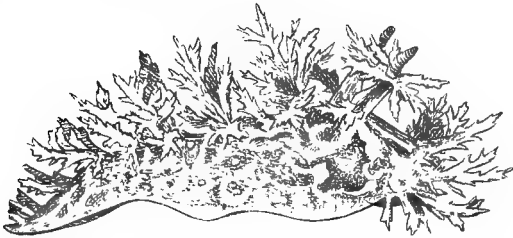

FIG. 224.—Nudibranch (*Dendronotus arborescens*), showing dorsal outgrowths forming adaptive gills.

placement in a postero-dorsal direction, in Lamellibranchs in a ventral direction, but in neither case is it so marked as in Gasteropods.

The characters of the internal organs of Mollusca must be inferred from the description of the types, but the nature of the respiratory organs may be briefly noted. Typically, these consist of two feathery gills, or ctenidia, with an axis attached to the body and bearing a double row of lamellæ. These are sheltered beneath the mantle, and bear at their bases two osphradia or smelling patches. Gills of this typical form occur in Cuttles (*Nautilus* has four), in the simplest Gasteropods (but many other Gasteropods have a simple unpaired gill), and in the lowest Lamellibranchs (*Solenomya*, *Nucula*, etc.). The respiratory organs in other Mollusca show much diversity when compared with this primitive type. Thus the gills may be totally suppressed and the mantle may directly take on a respiratory function. This occurs in many marine Gasteropods, for example, in

the common limpet (*Patella*) (Fig. 225), as well as in terrestrial forms like the snail, where the mantle cavity forms the pulmonary chamber. Even in Lamellibranchs, where the gills are present in much modified form, it is probable that the mantle has much importance in respiration, the gills being perhaps of most importance in connection with nutrition, and as brood-chambers. In those Gasteropods in which the gills are suppressed, there are often special respiratory organs ("adaptive gills"), such as the circle of plumes around the anus in *Doris* and its allies (Fig. 224). The osphradia are absent in Cephalopods, except in *Nautilus*, and one at least is usually suppressed in Gasteropods.

Shell.—On the dorsal surface of almost every mollusc embryo there is a little shell-sac in which an embryonic shell is begun; the adult shell, however, is always started and increased by the mantle. Like other cuticular products, it has an organic basis (conchiolin or conchin), along with which carbonate of lime is associated. There is a thin outer "horny" layer, a thick median "prismatic" stratum of lime, and an internal mother-of-pearl layer, which may be divided into two strata by a clear intermediate layer, well seen in the fresh-water mussel, *Margaritana margaritifera*.

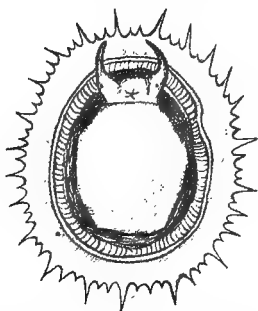

FIG. 225.—Ventral surface of *Patella vulgata*.—After Forbes and Hanley.

Note simple eyes at base of tentacles, mouth, median foot, and vascular margin of mantle replacing the absent gills.

Mr. Irvine's experiments at Granton Marine Station suggest that the lime salt originally absorbed is not the carbonate (of which there is a scant supply in sea-water), but the sulphate (which is abundant), and that the internal transformation from sulphate to carbonate is perhaps associated with the diffuse decomposition of nitrogenous waste products. Thus carbonate of ammonia, which seems to occur abundantly in the mantle of perfectly fresh mussels, would, with calcium sulphate, yield carbonate of lime and ammonium sulphate. One cannot suppose that shell-making is expressible in a chemical reaction of this simplicity, but it

is reasonable to inquire how far shell-making may express a primitive mode of excretion to which a secondary significance has come to be attached.

Pearls are formed in sacs of the external epithelium of the mantle, sometimes around a centre of a periostracum-like substance, sometimes around the larva of a Trematode or Cestode. They are to be distinguished from concretions formed around an intruded irritant particle. The latter do not show the characteristic lamination of pearls. Some pearl-like structures are fixed to the shell; true pearls are free. While some investigators insist on the parasitic origin of pearls, others are equally emphatic in declaring that they may arise independently. But all are agreed that they are pathological products.

Larvæ.—In their life history most Molluscs pass through two larval stages. The first of these is a pear-shaped or barrel-shaped form, with a curved gut, and with a ring of cilia in front of the mouth. It is a “trochosphere,” such as that occurring in the development of many “worms.”

Soon, however, the trochosphere grows into a yet more efficiently locomotor form—the veliger. Its head bears a ciliated area or “velum,” often produced into retractile lobes; its body already shows the beginning of “foot” and mantle; on the dorsal surface lies the little embryonic shell gland (Fig. 206).

But although trochosphere and veliger occur in the development of most forms, they do not in any of the three types which we have particularly described,—not in *Anodonta*, partly because it is a fresh-water animal, with a peculiarly adhesive larva of its own; not in *Helix*, partly because it is terrestrial; and not in *Sepia*, partly because the eggs are rich in yolk.

CLASSIFICATION OF MOLLUSCA

Leaving aside the difficult Solenogastres, which may not be Molluscs at all, we may rank as lowest the Isopleura, bilaterally symmetrical Gasteropods with many primitive characters. Some of these forms, like *Chiton*, are probably not far removed from the primitive Mollusca. From primitive forms, related perhaps to *Chiton*, Mollusca have diverged in two directions. In Gasteropoda, Scaphopoda, and Cephalopods, the head region becomes well developed, and the radula present in the primitive Isopleura is retained, except in rare cases, such as one of the species of *Eulima*, a semi-parasite. These three classes are therefore often placed together as Glossophora or Odontophora, in contrast to the Lamellibranchiata (Lipocephala or Acephala),

where the radula has disappeared, and the head region remains undeveloped. As already seen, however, the lowest Lamellibranchs have a flattened creeping foot and simple feathery gills, in these respects resembling Gasteropods. There is also much reason to believe that the Scaphopoda arose from a stem common to them and the lowest Gasteropods, which are central unspecialised forms. The Cephalopoda are the most highly specialised of all the Mollusca, and in their existing forms at least not nearly related to the other classes.

Class I. GASTEROPODA

Molluscs with a usually well-developed head region with tentacles and odontophore. The foot is usually a flat median sole on which the animal creeps; it is often divided into pro-, meso-, and meta-podium. Most are unsymmetrical, but there is a primitive bilateral symmetry in Isopleura and a secondary superficial bilateral symmetry in some pelagic forms such as Heteropods. The mantle or covering of the visceral sac usually forms a well-marked fold or flap where the visceral sac joins the head and foot, and thus encloses a mantle cavity. In most cases the shell is a single piece; in Chitons there are eight pieces; in many cases the shell is rudimentary or absent. There is usually a trochosphere and veliger larva, except in terrestrial forms.

Sub-class I. GASTEROPODA ISOPLEURA

The Isopleura are marine Gasteropods more or less elongated in form, with bilateral symmetry. The symmetry is not only seen in the form of the body, but in the numerous ctenidia, the paired nephridia, auricles, and genital ducts. The shell consists of eight pieces. The mouth is anterior; the anal and nephridial apertures are posterior. The mantle, which bears cuticular spicules, covers at least a great part of the body. The nervous system consists of a cerebral commissure and two paired longitudinal cords (pedal and visceral), with ganglionic cells but at most very slightly developed ganglia, which run the whole length of the body. Of these paired cords the pedals are connected by numerous cross-commissures, and the viscerals or pallials are united posteriorly by a commissure above the rectum. The bilateral symmetry is shown internally,

e.g. in the paired nephridia, auricles, and genital ducts. The class is of ancient origin, dating from the Silurian. There is one order—*Polyplacophora*, e.g. *Chiton*.

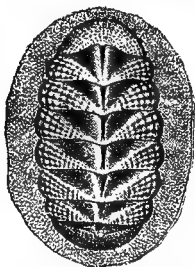

FIG. 226.—*Chiton*.—
After Prêtre.

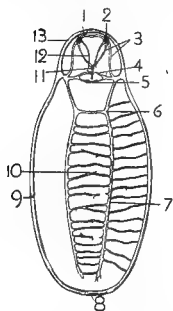
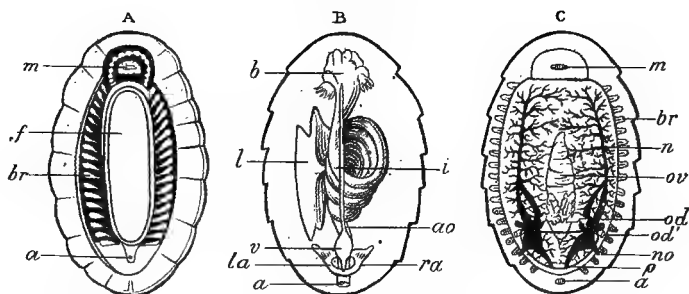

FIG. 227.—Dorsal view
of nervous system of
Acanthochiton.—After
Pelseneer.

- 1, Upper buccal commissure ;
- 2, upper buccal ganglion ;
- 3, stomatogastric commissure ;
- 4, labial commissure ;
- 5, sub-radular ganglia ;
- 6, anterior pedal commissure ;
- 7, pedal nerve with pallio-pedal connections ;
- 8, supra-rectal pallial commissure ;
- 9, pallial nerve ;
- 10, anastomosis of branches of pedal nerves ;
- 11, stomatogastric ganglia ;
- 12, œsophageal nerves ;
- 13, cerebral commissure.

The Isopleura or Polyplacophora are represented on British coasts by several species of *Chiton*, sluggish, usually vegetarian, animals, occurring from the shore to great depths. The foot is generally as long as the body ; the mantle covers the back and bears eight shell-plates (Fig. 226), perforated, in many cases at least, by numerous sensory organs, which are in part optic ; numerous gills lie in a regular row along a groove on each side between the mantle and the foot.

In most cases the eight shell-plates are jointed on one another, and the animal can roll itself up. The uncovered parts of the mantle bear spicules. Ganglia, in the strict sense, are scarcely developed, but there is a supra-œsophageal ganglionic commissure from which the visceral and pedal cords extend backwards along the whole length of the body. There are no special sense organs on the head, which is but slightly differentiated ; but the pallial sense organs are usually numerous and varied. A twisted gut runs through the body, surrounded by a diffuse digestive gland. There is a radula in the mouth. The heart is median and posterior, and consists of a ventricle and two to eight auricles. There are two symmetrical nephridia opening posteriorly, and consisting of much-branched tubes. The sexes are separate ; a single reproductive organ extends dorsally between gut and aorta almost the whole length of the body ; the genital ducts are paired and open posteriorly in front of the excretory apertures. The ova, with chitinous spiny shells, are usually retained for some time by the female between the mantle and the gills. The segmentation is holoblastic, and a gastrula is formed by invagination.

FIG. 228.—Anatomy of *Chiton*.

- A, ventral surface (after Cuvier). B, dorsal view of alimentary canal (after Lankester). C, genital and excretory organs from dorsal surface (after Lang and Haller, diagrammatic). *m*, mouth; *a*, anus; *br*, numerous simple gills; *f*, foot; *b*, buccal mass; *l*, liver; *i*, intestine; *ao*, aorta; *v*, ventricle of heart; *ra* and *la*, right and left auricles; *ov*, ovary; *od*, oviduct; *od'*, opening of oviduct; *n*, part of nephridium, represented in black throughout; *no*, external opening of nephridium; *p*, outline of pericardium.

Sub-class II. GASTEROPODA ANISOPLEURA, e.g. Snail, Whelk, Limpet

In these more or less asymmetrical Gasteropods, the head region, which is well developed, remains symmetrical, and so does the foot, which is typically a flat creeping organ. But the visceral mass or hump, with its mantle fold, is more or less twisted forwards and to the right. Thus the pallial, anal, nephridial, and genital apertures usually lie on the right side, more or less anteriorly. A further asymmetry is shown by the twisting of the morphologically right gill to the left side, while the original left gill is usually lost. Similarly, one of the nephridia, probably that which is morphologically the left, tends to disappear, and in most cases only one persists—topographically on the left side. The main torsion must be distinguished from the spiral twisting which the visceral hump often exhibits, and from the frequently associated spiral coiling of the univalve shell. Moreover, a superficial secondary bilateral symmetry tends to be acquired by free-swimming forms, e.g. Heteropods. There are never more than two gills

of the ctenidium type. The shell is usually in one piece; but it is sometimes rudimentary or absent. The foot usually contains a mucus gland, and tends to be divided into three regions—the pro-, meso-, and meta-podium. There is a single reproductive organ and genital duct.

Branch A. STREPTONEURA

In the torsion of the body one limb of the visceral loop crosses the other in a figure 8.

Order 1. ZYGOBRANCHIATA

The atrophy of the primitively left-side gills and nephridia is not carried out, or only partially, e.g. *Haliotis* (ear-shell); *Fissurella* (key-hole limpet); *Patella* (limpet).

Order 2. AZYGOBRANCHIATA

The originally left gill and the originally left nephridium have been lost. Heart with single auricle, one gill, one nephridium; operculum present.

Periwinkle (*Littorina*), buckie (*Buccinum*, Fig. 222), dog-whelk (*Purpura*), *Ianthina*, and the majority of the marine Gasteropods with coiled shells, together with some fresh-water forms. The pelagic Heteropods are also included here:—*Atlanta*, shell well developed; *Carinaria*, with small shell; *Pterotrachea*, with no shell.

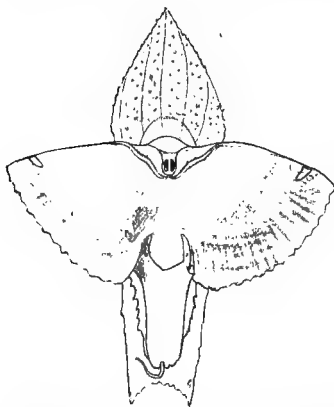

FIG. 229.—A Pteropod (*Cymbulia peronii*), showing the wing-like expansions (pteropodial lobes) of the mid-foot.

Branch B. EUTHYNEURA

The visceral loop does not share in the torsion of the visceral hump.

Order 3.

OPISTHBRANCHIATA

The visceral loop is euthyneural, as in snails; the single auricle lies behind the ventricle; the shell and mantle are often absent.

A. Tectibranchiata. A shell is present, but may be rudimentary; there is a well-developed mantle fold and a single gill, e.g.

Bulla, *Aplysia*, *Dolabella*, *Umbrella*. The Tectibranchiata also include the Pteropoda, the winged snails or sea-butterflies, which have become much modified for pelagic life. They have a secondarily acquired bilateral symmetry, and swim by two large lateral lobes of the foot. They often swim actively in shoals, and occur in all seas. They afford food for whales, etc., and the shells of some are abundant in the ooze. They include—

(a) Thecosomata, with mantle fold and shell, diet of minute animal or vegetable organisms, closely related to *Bulla* and its allies.

Examples.—*Hyalea*, *Cymbulia*.

(b) Gymnosomata, without mantle fold or shell in the adult. Closely allied to *Aplysia* and its allies.

Actively carnivorous, e.g. *Clio*, *Pneumoderma*.

B. Nudibranchiata. Shell, mantle fold, and true gill are absent; various forms of "adaptive gills" may be present, or there may be no special respiratory organs, e.g. sea-slugs, *Doris*, *Eolis*, *Dendronotus* (Fig. 224).

Order 4. PULMONATA

The visceral loop is short and untwisted, gills are absent, and the mantle cavity functions as a lung; all are hermaphrodite, e.g. the snail (*Helix*); the grey slug (*Limax*); the black slug (*Arion*); fresh-water snails, such as *Limnæa*, *Planorbis*, and *Ancylus*.

Mode of life.—From the number of diverse types which the class includes, it is evident that few general statements can be made about the life of Gasteropods. We are safe in saying, however, that though the majority are sluggish when compared with Cephalopods, they are active when compared with Lamellibranchs.

The locomotion effected by the contractions of the muscular foot is usually a leisurely creeping, but there are many gradations between the activity of Heteropods in open sea, the gliding of fresh-water snails (*Limnæa*) foot upwards across the surface of the pool, the explorations of the periwinkles on the sand of the shore, and the extreme passivity of limpets (*Patella*), which move only for short distances at a time from their resting-places on the rocks.

The number of terrestrial snails and slugs, breathing the air directly by means of a pulmonary chamber, is estimated at over 6000 living species, while the aquatic Gasteropods are reckoned at about 10,000, most of which are marine.

Of this myriad, about 9000 are streptoneural, the relatively small minority are euthyneural Opisthobranchs and Nudi-branchs, with light shells or none. The Heteropods and some Opisthobranchs live in the open sea; the great majority of aquatic Gasteropods frequent the shore and the sea bottom at relatively slight depths; the deep-sea forms are comparatively few.

Gasteropods rarely feed at such a low level as bivalves do

—indeed, some of them are fond of eating bivalves. Most Prosobranchs (streptoneural), with a respiratory siphon and a shell notch in which this lies, are carnivorous, e.g. the buckies (*Buccinum*) and “dog-whelks” (*Purpura*); on the other hand, those without this siphon, and with an unnotched shell mouth, feed on plants, e.g. the seaweed-eating periwinkles (*Littorina*). Most land snails and slugs are vegetarian. Many Gasteropods, both marine and terrestrial, are voracious and indiscriminate in their meals; others are as markedly specialists or epicures. Some marine forms partial to Echinoderms have a salivary secretion of dilute sulphuric acid, which changes the carbonate of lime in the starfish into the more brittle and readily pulverised sulphate. About ten genera are parasitic on or in Echinoderms, e.g. *Stylifer*, *Turtonia*, *Thyca*, and the extremely degenerate *Entoconcha*, within the Holothurian *Synapta*. Some species of *Eulima* also live a semi-parasitic life on certain Echinoderms.

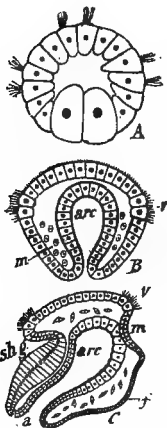

FIG. 230.—Stages in molluscan development.

A., Blastula of limpet (after Patten). B, Gastrula of *Paludina vivipara* (after Tönniges); v., beginning of velum; arc., archenteron; m., mesoderm cells. C, later stage of the same; v., velum; m., mouth invagination; arc., archenteron; a., anus; f., beginning of foot; sh.g., shell gland.

Life history.—The eggs of Gasteropods are usually small, without much yolk, but surrounded by a jelly, the surface of which often hardens. In the snail and some others there is an egg-shell of lime.

Sexual union occurs between hermaphrodites as well as between separate sexes, and fertilisation is effected inside the genital duct. Development sometimes proceeds within the parent, but in most cases the fertilised eggs are laid in gelatinous clumps, or within special capsules. The free-swimming *Ianthina* carries the eggs in capsules attached to a large raft-like float towed by the foot. On the shore one often finds numerous egg-capsules of the "buckie" (*Buccinum undatum*) united in a ball about the size of an orange. Under the ledges of rock are many little vases or cups, the egg-capsules of the dog-whelk (*Purpura lapillus*). In the buckie and whelk, and in some other forms, there is a struggle for existence—an infant cannibalism—in the cradle, for out of the numerous embryos in each capsule only a few reach maturity,—those that get the start eating the others as they develop.

The development is usually simple and typical. In other words, segmentation is total though often unequal; gastrulation is embolic or epibolic according to the amount of yolk present; the gastrula becomes a trochosphere, and later a veliger (Fig. 230).

Past history.—As the earth has grown older the Gasteropods have increased in numbers. A few have been disinterred from the Cambrian rocks; thence onwards they increase. Most of the Palæozoic genera are now quite extinct, but many modern families trace their genealogy to the Cretaceous period. Those with respiratory siphons were hardly, if at all, represented in Palæozoic ages, and the terrestrial air-breathers are comparatively modern.

Æcology.—As voracious animals, with irresistible rasps, Gasteropods commit many atrocities in the struggle for existence, and decimate many plants. Professor Stahl shows, however, that there are more than a dozen different ways in which plants are saved from snails,—by crystals, acids, ferments, etc.; in short, by constitutional characteristics sufficiently important to determine survival in the course of natural selection or elimination. As food and bait, many Gasteropods are very useful; their shells have supplied tools and utensils and objects of delight; the juices of *Purpura* and *Murex* furnished the Tyrian purple, more charming than all aniline.

Class II. SOLENOGASTRES

The members of this class are worm-like animals, in which the mantle envelops the whole body and bears numerous spicules, but no shell. It is somewhat doubtful if they are Molluscs at all. There are two families—Neomeniidae and Chætodermidae.

Of Neomeniidae, six genera are known, *e.g.* *Neomenia* and *Proneomenia*. They have a longitudinal pedal groove, an intestine without distinct digestive gland, two nephridia with a common aperture, and hermaphrodite reproductive organs. The Chætodermidae, represented by one genus *Chætoderma*, are cylindrical in form, without a pedal groove, with a radula bearing one tooth, with a distinct digestive gland, and with two nephridia opening separately into a posterior cavity, which also contains two gills. The sexes are separate.

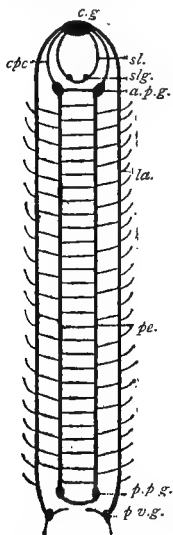

FIG. 231.—*Proneomenia*. Nervous system.—From Hubrecht.

c.g., Cerebral ganglia; *sl.g.*, sublingual; *a.p.g.*, anterior pedal; *p.p.g.*, posterior pedal; *p.v.g.*, posterior visceral; *sl.*, sublingual connectives; *c.p.c.*, cerebro-pedal connective; *p.e.*, longitudinal pedal nerves; *la.*, longitudinal lateral nerves.

truded at the anterior opening. There are cerebral and pleural ganglia near one another in the head, pedal ganglia in the foot, and a long untwisted visceral loop with olfactory ganglia near the posterior anus. Sense organs are represented by otocysts beside the pedal ganglia. There is an odontophore with a simple radula. The food consists of minute animals. There is a much reduced heart, and colourless blood circulates in the body cavity. There are two nephridial apertures, one

Class III. SCAPHOPODA

Very different in many respects from Gasteropoda are the Scaphopoda, of which *Dentalium* (Elephant's tooth-shell) is the commonest genus. They are apparently related to the Zeugobranchiate Gasteropods, and also to the simplest Bivalves. They burrow in the sand at considerable depth off the coasts of many countries. The mantle has originally two folds, which fuse ventrally, and the shell becomes cylindrical, like an elephant's tusk. It is open at both ends. The larger opening (directed downwards in the sand) is anterior, the concave side of the shell is dorsal. The mouth opens at the end of a short buccal tube, at the base of which is a circle of ciliated tentacles. The foot is long, with three small terminal lobes. It is used in slow creeping, and is pro-

on each side of the anus ; and two nephridia. The sexes are separate ; the reproductive organ is simple and dorsal in position ; the elements pass out by the right nephridium. The gastrula is succeeded by a free-swimming stage, in which there is a hint of a velum and a rudimentary shell gland.

Examples.—*Dentalium*, *Entalium*. About forty widely distributed species are known. *Dentalium entale* occurs off British coasts. The genus occurs as a fossil from Devonian strata onward.

Class IV. LAMELLIBRANCHIATA OF BIVALVES

(*Synonyms*—Acephala, Conchifera, Pelecypoda, Lipcephala, etc.)

Examples.—Cockles, Mussels, Clams, and Oysters

Lamellibranchs are bilaterally symmetrical Molluscs, in which the body is compressed from side to side and the foot more or less ploughshare-like. The head (or prostomium) region remains undeveloped, and without tentacles ; radula, horny jaws, and salivary glands are absent, but there is a pair of labial palps on each side of the mouth. The mantle skirt is divided into two flaps, which secrete the two valves of the shell, now lateral instead of dorsal in position. The valves are united by a dorsal elastic ligament, and closed by two transverse adductor muscles or by one. Internal bilateral symmetry is marked by the paired nature and disposition of the nephridia, auricles, gills, digestive gland, and reproductive organs. The gills (ctenidia) consist of numerous gill filaments, which typically grow together into large plates (hence the title *Lamellibranch*). There are usually three pairs of ganglia : (a) cerebro-pleurals in the head ; (b) pedals in the foot ; (c) viscerals at the posterior end of the body. The heart consists of a ventricle and two auricles, and is surrounded by a pericardium which is cœlomic in origin, and communicates with the exterior by means of the two nephridia. Reproductive organs are always simple, and the sexes are usually separate. The typical development includes trochosphere and veliger stages. Most *Lamellibranchs* feed on microscopic organisms and particles ; the distribution is very wide, both in salt and fresh water ; the general habit is sedentary or sluggish.

Classification.—That of Pelseneer is based on the structure of the gills.

Order 1. PROTORRANCHIA.—There are two simple posterior gills, quite similar to those of Zeugobranchs; the foot has a flattened creeping surface; the pleural and cerebral ganglia are distinct, *e.g.* *Nucula*, *Solenomya*.

Order 2. FILIBRANCHIA.—The gill filaments are greatly elongated and reflected, so that they consist of an ascending and a descending limb, *e.g.* *Arca* (Noah's-ark shell), *Mytilus* (edible mussel), *Modiola* (horse-mussel).

Order 3. PSEUDO-LAMELLIBRANCHIA.—The successive gill filaments are loosely connected together to form gill-plates, *e.g.* *Pecten* (scallop), *Ostrea* (oyster).

Order 4. EULAMELLIBRANCHIA.—The separate filaments are no longer discernible; the gills form double flattened plates. The great majority of Bivalves are included here, *e.g.* *Anodonta*, *Venus*, *Pholas* (a boring form), *Mya*.

GENERAL NOTES ON LAMELLIBRANCHS

Structure.—The organs which show most variety in bivalves are the foot, the gills, the adductor muscles, and the mantle skirt. The foot shows much diversity in size and shape; the pedal gland of Gasteropods is often represented by a "byssus" gland, which secretes attaching threads, well seen in the edible mussel (*Mytilus*). The gills show a series of gradations, from a slight interlocking of separate gill filaments to the formation, by complicated processes of "concrecence," of plate-like structures such as those of *Anodonta*. These processes are more closely related to the method of nutrition than of respiration, which, indeed, is probably largely performed by the mantle skirt. The mantle skirt is often united to a greater or less extent inferiorly, and is often prolonged and specialised posteriorly to form exhalant and inhalant "siphons" (Fig. 223). These siphons sometimes attain a considerable length; they occur especially in forms such as *Mya*, which live buried in sand or mud, or which burrow in wood or stone, *e.g.* *Pholas*. The diversities in the adductor muscles afford one basis for classification.

We may associate with the sluggish habits and sedentary life of bivalves—(1) the undeveloped state of the head region; (2) the largeness of the plate-like gills, which waft food-particles to the mouth; and (3) the thick limy shells. We may reasonably associate these and other facts of structure (*e.g.* the rarity of anterior eyes, biting or rasping organs) with the conditions of life.

In some Lamellibranchs, *e.g.* Mytilidæ, small eyes occur at the base of the most anterior filament of the inner gill-plate; in some other cases they are present in the larva, but not in the adult.

Habit.—Most bivalves, as every one knows, live in the sea, and their range extends from the sand of the shore to great depths. They occur in all parts of the world, though only a few forms, like the edible mussel (*Mytilus edulis*), can be called cosmopolitan. Some, such as oysters, can be accustomed to brackish water. The fresh-water forms may have found that habitat in two ways—(a) a few may have crept

slowly up from estuary to river, from river to lake; *Dreissensia polymorpha* has been carried on the bottom of ships from the Black Sea to the rivers and canals of Northern Europe; and it is likely that aquatic birds have assisted in distributing little bivalves like *Cyclas*; (*b*) on the other hand, it is more probable that the fresh-water mussels (*Unio*, *Anodonta*, etc.) are relics of a fauna which inhabited former inland seas, of which some lakes are the freshened residues.

Between the active *Lima* and *Pecten*, which swim by moving their shell valves and mantle flaps, and the entirely quiescent oyster, which has virtually no foot, there are many degrees of passivity, but most incline towards the oyster's habit. Of course, there is much internal activity, especially of ciliated cells, even in the most obviously sluggish. The cockle (*Cardium*) uses its bent foot to take small jumps on the sand; the razor-fish (*Solen*) not only bores in the sand, but may swim backwards by squirting out water from within the mantle cavity; many (e.g. *Teredo*, *Pholas*, *Lithodomus*, *Xylophaga*) bore holes in stone or wood; in the great majority the foot is used for slow creeping motion.

The food consists of Diatoms and other Algæ, Infusorians and other Protozoa, minute Crustaceans and organic particles, which the cilia of the gills and palps sweep towards the mouth. The bivalves are themselves eaten by worms, starfishes, gasteropods, fishes, birds, and even mammals.

Several commensal bivalves (Montacutidæ) are known,—*Montacuta* on heart-urchins, *Entovalva* in the gullet of Synaptids, *Scioberetia* on a sea-urchin, and *Jousseaumiella* on a Sipunculid.

Life history.—The eggs are sometimes laid in the water, either freely or in attached capsules, or they are fertilised by spermatozoa drawn in with the inhaled water, and are subsequently sheltered within the body during part of the development. In the Unionidæ the embryos are retained within the cavities of the outer gills; in *Cyclas* and *Pisidium* there are special brood-chambers at the base of the gills. In *Cyclas* the embryos are nourished by the maternal epithelial cells. Segmentation is always unequal; a gastrula may be formed by invagination or by overgrowth, the two cases being connected by a series of gradations. A trochosphere stage is more or less clearly indicated, being most obvious in cases where the eggs are laid in the water. The free-swimming trochosphere becomes a veliger, and this is modified into the adult. The fresh-water forms, with the exception of *Dreissensia polymorpha*, in which the habit is recently acquired, do not possess free-swimming larvæ; this must be regarded as an adaptation.

Past history of bivalves.—Even in Cambrian rocks, which we may call the second oldest, a few bivalves have been discovered; in the Upper Silurian they become abundant, and never fall off in numbers. Those with one closing muscle to the shell seem to have appeared after those which have two such muscles. Those which, from the shell markings, seem to have had an extension of the mantle into a protrusible tube or siphon, were also of later origin. The present fresh-water forms were late of appearing. Of all the fossil forms the most remarkable are large twisted shells, called *Hippurites* (Rudistæ), whose remains are often very abundant in deposits of the chalk period.

Class V. CEPHALOPODA. Cuttlefish

Examples.—*Sepia*, *Octopus* (*Polypus*), *Loligo*, *Nautilus*

The *Cephalopods* are bilaterally symmetrical and free-swimming. The head is surrounded by numerous "arms" bearing tentacles or suckers. These arms seem to be equivalent to processes of the margin of the foot. Another portion of the foot forms a partial or complete tube—the "siphon" or "funnel"—through which water is forcibly expelled from the mantle cavity. The muscular mantle flap which shelters well-developed plumose gills is posterior in position; the visceral hump shows no trace of spiral coiling, but is elongated in a direction anatomically dorsal and posterior, though it may point forwards when the animal propels itself through the water. Except in the pearly *Nautilus*, the shell of modern forms has been enclosed by the mantle, and is, in most cases, only hinted at. There is a very distinct head region, furnished with eyes and other sensitive structures, and the mouth has strong beak-like jaws, as also a well-developed radula. The nervous system shows considerable specialisation; the chief ganglia are concentrated in the head, and sheltered by cartilage. The true body cavity, pericardium of other Molluscs, is usually well developed, and frequently surrounds the chief organs. Except in the *Nautilus*, it communicates with the exterior by the nephridia. The nephridia are disposed on the walls of the afferent branchials.

The vascular system is well developed, and, except in the *Nautilus*, there are accessory branchial hearts. The sexes are separate. The gonad is in a coelomic sac and not directly continuous with the gonoduct. The ovum undergoes incomplete segmentation. Development is direct. In habit, *Cephalopods* are predominantly active and predatory; in diet, carnivorous.

The shells of the pearly *Nautilus* are common on the shores of warm seas, but the animals are much less familiar. The *Nautilus* creeps or swims gently along the bottom at no great depth, and its appearance on the surface, "floating like a tortoiseshell cat," is probably the result of storms. It is called "pearly" on account of the appearance of the

innermost layer of the shell. This is exposed after the soft organic stratum and the median porcellanous layer which bears bands of colour have been worn away, or dissolved in a dolphin's stomach, or artificially treated with acid.

The beautiful shell is a spiral in one plane, divided into a set of chambers, in the last of which the animal lives, while the others contain gas. The young creature inhabits a tiny shell curved like a horn; it grows too big for this, and proceeds to enlarge its dwelling, meanwhile drawing itself forward from the older part, and forming a door of lime behind it. This process is repeated again and again; as an addition is made in front, the animal draws itself forward a little, and shuts off a *part of* the chamber in which it has been living. All the compartments are in communication by a median tube of skin—the siphuncle—which is in part calcareous.

It has been suggested that "each septum shutting off an air-containing chamber is formed during a period of quiescence, probably after the reproductive act, when the visceral mass of the Nautilus may be slightly shrunk, and gas is secreted from the dorsal integument so as to fill up the space previously occupied by the animal."

There can be no confusion between the beautiful shell of the cuttlefish called the paper Nautilus (*Argonauta argo*) and that of our type. For it is only the female Argonaut which bears a shell; it is not chambered, and is a shelter for the eggs—a cradle, not a house. It seems to be formed by two of the arms.

It is instructive to compare the Nautilus shell with that of some Gasteropods, for there also chambers are occasionally formed. But these arise from secondary alterations of an originally continuous spiral. The Gasteropod shell is

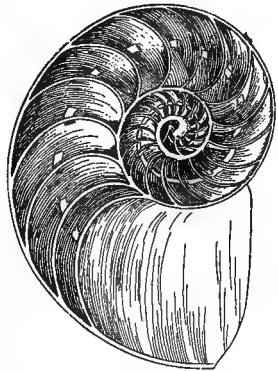

FIG. 232.—Section of shell of Nautilus.—After Lendenfeld.

usually unsymmetrical, and the foot (*ventral*) is turned towards the internal curve of the coil, while in *Nautilus* the *dorsal* part of the animal is towards the internal surface of the chamber.

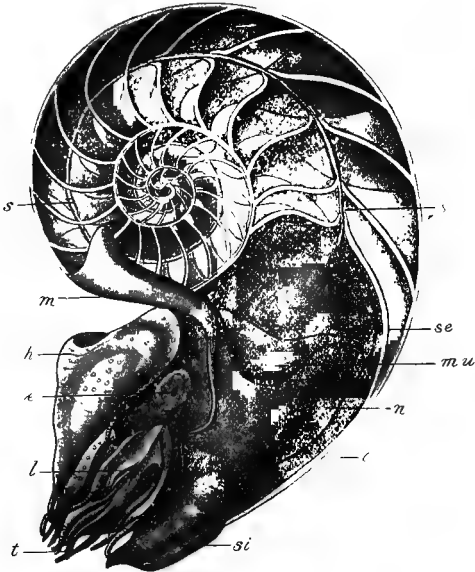

FIG. 233.—The Pearly Nautilus (*Nautilus pompilius*).
—After Owen.

The shell is represented in section, but the animal is not dissected. Part of the mantle has been removed. *c.*, Last or body chamber, separated by a septum (*se.*) from the compartment behind; *s.*, the siphuncle traversing all the compartments; *m.*, the portion of the mantle which is reflected over the shell; *h.*, the hood; *e.*, the eye with its opening to the exterior; *l.*, the lobes which bear the sheathed tentacles (*t.*); *si.*, the incomplete siphon; *mu.*, the shell muscle; *n.*, the position of the nidamental gland.

There are only about half a dozen living species of *Nautilus*, but there are many hundred fossils of this and allied genera. This list is usually swelled by the addition of the extinct Ammonites, but there are some reasons for

suspecting that these belong to the Dibranchiate section of Cephalopods.

The following table states the chief points of distinction between *Nautilus* and the other series of Cephalopods:—

CEPHALOPODA

TETRABRANCHIATA (<i>Nautilus</i>).	DIBRANCHIATA (<i>Sepia</i> , <i>Octopus</i> , etc.)
All extinct except one genus— <i>Nautilus</i> ; the extinct forms are usually ranked as Nautiloid and Ammonoid.	Numerous living genera, ranked as Decapods or Octopods; along with the former the extinct Belemnites are included.
Shell external, chambered, straight or bent or spirally coiled. That in which <i>Nautilus</i> lives has been described, with its siphuncle, gas-containing compartments, etc.	No living Dibranchiate lives in a shell. The shell was internal even in the extinct Belemnites, and in modern forms it occurs in various degrees of degeneration (cf. <i>Spirula</i> , <i>Sepia</i> , <i>Loligo</i>), or is quite absent (Octopoda).
The part of the foot surrounding the mouth bears a large number of lobes, which carry tentacles in little sheaths, but no suckers.	The part of the foot surrounding the mouth is divided into ten or eight arms, which carry suckers, stalked in Decapods, sessile in Octopods.
The two mid-lobes of the foot form a siphon, but they are not fused into a tube.	The two mid-lobes of the foot fuse to form a completely closed tubular siphon or funnel.
The eye is without a lens, and is bathed internally by sea-water, which enters by a small pinhole aperture. There are two "osphradia" or smelling patches at the bases of the gills.	The covering of the eye may be perforated, but the mouth of the retinal cup is closed by a lens. There are no osphradia, though there may be "olfactory pits" behind the eyes.
Two pairs of gills; two pairs of nephridia; two genital ducts (the left rudimentary).	One pair of gills; one pair of nephridial sacs; two oviducts in Octopoda and Oigopsida; two vasa deferentia in <i>Eledone moschata</i> ; in others an unpaired genital duct.
The cœlom sac (pericardium) opens directly to the exterior by two apertures.	The cœlom opens into the nephridia by two pores, and thus to the exterior.
The heart has two pairs of auricles, and there are no branchial hearts.	The heart has two auricles, and there are branchial hearts.
No ink-bag. No salivary glands.	Usually with an ink-bag. Salivary glands.

CLASSIFICATION OF CEPHALOPODA.

Order I. Tetrabranchiata (see Table).

Family I. Nautilidæ. *Nautilus* alone alive; but a great series of fossil forms, *Orthoceras*—*Trochoceras*.

Family II. Ammonitidæ. All extinct, but with shells well preserved, so that long series can be studied. They furnish striking evidence of progressive evolution in definite directions, e.g. *Bacrites*, *Ceratites*, *Baculites*, *Turrilites*, *Heteroceras*, and the whole series of genera formerly classed as *Ammonites*.

Order II. Dibranchiata (see Table).

Sub-Order Decapoda. Eight shorter and two longer arms. Suckers stalked and strengthened by a strong ring. Large eyes with a horizontal lid. Body elongated, with lateral fins. Mantle margin with a cartilaginous "hook-and-eye" arrangement. Some sort of internal "shell," enclosed by upgrowths of the mantle.

With calcareous internal "shell." *Spirula*; extinct *Belonitites*; *Sepia*.

With organic internal "shell."

(a) Eyes with closed cornea, Myopsida, e.g. *Loligo*.

(b) Eyes with open cornea, Oigopsida, e.g. *Ommastrephes*.

Sub-Order Octopoda. Eight arms only. Suckers sessile without horny ring. Small eyes with sphincter-like lid. Body short and rounded. No "hook-and-eye" arrangement. No "shell," except in the female *Argonauta*.

e.g. *Octopus* (*Polypus*), *Eledone* (*Moschites*), *Argonauta*, *Cirroteuthis* (with cirri on the arms and no radula).

The classification given above is that usually adopted, but it is not certain that the Ammonites should be included in the Tetrabranchiata.

The Nautiloids began in the Cambrian and died out at the end of the Palæozoic period, except the *Orthoceras* and *Nautilus*-like types. The genus *Nautilus* appeared in the Cretaceous. The Ammonite series lasted from the Silurian to the early Tertiary.

The Cephalopods are the most specialised of the Molluscs, and present much diversity of type. They swim freely in the sea, or creep sluggishly among the rocks. They are voracious eaters, and devour very diverse kinds of animals, their parrot-like jaws and powerful odontophore, as well as the numerous suckers, rendering them formidable adversaries. Many live at considerable depths, and their chief foes are the toothed whales, some of which, like the sperm whale (*Physeter*), and the bottle-nose (*Hyperoodon*), subsist almost entirely on cuttles. Some deep-sea forms have highly evolved luminous organs.

Shells of Cephalopods.—A chambered external shell, serving as a house, is present in *Nautilus* alone among living Cephalopods. Most of the extinct forms had large and efficient shells of very diverse shape, some straight like *Orthoceras*, or coiled, with chambers separated by complex septa, as in the Ammonites. In the majority of shells of the Ammonitid series, the septa between the chambers are convex towards the aperture (the opposite in the *Nautilus*); the siphuncle is marginal or ventral; the septal necks of the siphuncle project forwards (not backwards as in the *Nautilus*); there is

an initial chamber or protoconch at the apex of the spiral (perhaps represented by a cicatrix in the *Nautilus*); the suture lines marking the chambers tend to be lobed. There is often a single or paired "Aptychus," perhaps of the nature of an operculum. Most of the modern forms seem to be more active than their ancestors, and their shells have degenerated. But the line of degeneration is still debated. In *Nautilus*, although the animal lives within the shell, the mantle fold is for some distance reflected over it; in the other series of Cephalopods this process has gone farther, and, where a shell is present, it is enclosed within the mantle fold, and is much reduced in size. In the extinct *Belemnites* the internal shell was straight and chambered, but almost concealed by secondary deposits of lime, secreted by the walls of the shell-sac, and forming the "guard" or rostrum. The conical chambered shell, with a siphuncle, is known as the phragmacone. It is produced anteriorly into a gladius or pro-ostracum. In the extinct *Spirulirostra* the shell was spiral and mostly internal; it has a guard. In *Spirula* the shell can be caught sight of in the young animal, but it becomes surrounded by the secondary mantle folds that form the mantle-sac. It is a spiral chambered shell, with a ventral siphon. Its relation to the dorsal and ventral surface of the animal is the opposite of that of the *Nautilus*. The shell is inside the animal; in *Nautilus* the animal is inside the shell. It seems that *Spirula* is a swift swimmer at great depths; though the empty shells are often cast ashore, the creature itself is rarely seen. In *Sepia*, the narrowed tip of the "bone" probably represents the remains of the phragmacone; the bulk of the "bone" probably corresponds to the pro-ostracum in the *Belemnites*. Besides lime there is chitin in the "Sepia-bone." In *Loligo* there is no deposit of lime, an organic chitinous pen only being left. In *Octopus* there is no trace of shell at all, and no mantle-pocket, save a trace, in the very young animal.

CHAPTER XVII

PHYLUM CHORDATA

SUB-PHYLUM HEMICHORDA

UNDER the title Hemichorda are included a number of interesting types which seem to have affinities with Vertebrates. These affinities are clearest in certain worm-like animals with distinct gill-clefts, e.g. *Balanoglossus* and *Ptychodera*, which form the class Enteropneusta. Perhaps allied to these are two peculiar types,—*Rhabdopleura* and *Cephalodiscus*, which may be united in the class Pterobranchia. Very doubtfully in this alliance is *Phoronis*.

GENERAL CHARACTERS OF ENTEROPNEUSTA

The worm-like body has three regions—a pre-oral “proboscis,” a “collar” around and behind the mouth, and a trunk, the anterior part of which bears gill-slits. A dorsal and in part tubular nerve-cord arises from the ectoderm along the middle line, and is connected, by a ring round the pharynx, with a ventral cord. In the skin, which is covered with ciliated ectoderm, there is also a nerve plexus. From the anterior region of the gut a diverticulum grows forward for a short distance, becomes a firm support for the proboscis, and is often called the “notochord.” The gill-slits open dorsally, are very numerous, and increase in number during life. The mesoblast is formed by the outgrowth of five cœlom pouches from the archenteron. An unpaired anterior pouch forms the pre-oral or proboscis cavity of the adult; there are two collar cavities and two trunk cavities.

There are about 30 species in 9 genera, e.g. *Balanoglossus*,

Dolichoglossus, *Ptychodera*, *Schizocardium*, and *Glandiceps*. They are very widely, though locally, distributed, and most occur in the littoral area.

DESCRIPTION OF BALANOGLOSSUS

Form and habitat.—The species which form this genus are worm-like marine animals, burrowing in sand and mud in almost all seas. They vary in length from about 1 in. to over 6 in., and are brightly coloured and have a peculiar odour, like that of iodoform. The sexes are distinct, and are marked externally by slight differences in colour. The body consists of a prominent turgid and muscular "proboscis," a firm "collar," a region with gill-slits, and, finally, a long, soft, slightly coiled portion.

Skin and muscles.—

The epidermis is ciliated, and exudes abundant mucus from unicellular glands. With the addition of grains of sand, the mucus sometimes forms a tube round the body. Some species are

phosphorescent. The muscular system is best developed about the proboscis and collar, which are used in leisurely locomotion through the soft sand. There are external circular and internal radial and longitudinal muscles. The fibres are unstriped. There is great regenerative capacity.

Nervous system.—The dorsal nerve-cord is most developed in the collar, but is continued along the whole length. It arises as a longitudinal groove of ectoderm and often remains tubular, like a typical spinal cord. The dorsal nerve-cord is connected by a band round the collar with a ventral nerve. There is also a nervous plexus

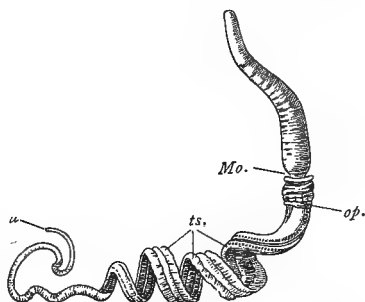

FIG. 234.—Male of *Balanoglossus* (*Dolichoglossus*) *kowalevskii*.—After Bateson.

Note anterior proboscis. *Mo.*, Mouth; *op.*, slight operculum behind the collar; then the region with gill-slits; *ts.*, testes; *a.*, anus.

beneath the epidermis. There are no special sense organs in the adult. In the larvæ of some species there are two eye-spots.

Alimentary system.—The permanently open mouth is on the ventral surface between the proboscis and the collar. Sand seems to pass into it during the wriggling movements of the animal, which are greatly aided by the turgidity of the proboscis and collar. The pharynx is divided into a dorsal and ventral region, of which the former is respiratory (Fig. 235, *g*.¹), and connected with the exterior by many gill-slits, while the latter is nutritive (Fig. 235, *g*.), and conveys the food particles onwards. Behind the region with gill-slits, the gut has a dorsal and a ventral ciliated groove, and bears, throughout the anterior part of its course, numerous glandular sacculations, which can be detected through the skin. The anus is terminal. The animal eats its way through the sand, and derives its food from the nutritive particles and small organisms therein contained.

Skeletal system.—The skeletal system is represented by the "notochord," which lies in the proboscis, and arises, like the notochord of indubitable Vertebrates, as a diverticulum from the dorsal wall of the gut in the collar region. Beneath the notochord there is a chitinous "proboscis skeleton." The septa between the gill-slits are supported by chitinous "forked primary" bars; and each slit, at first circular, is split into a V-shape by the growth downwards of a double rod of chitin called a "tongue bar"; the whole is suggestive of *Amphioxus*.

The body cavity.—The body cavity consists of five distinct parts, all of which are lined by mesoderm, and arise as pouches from the archenteron. (*a*) There is first the unpaired cavity of the proboscis, which communicates with the exterior by a dorsal pore at the base of the proboscis next the collar. (*b*) In the collar region there are two small paired cœlomic cavities, from which two funnels open to the exterior. Both these cavities and that of the proboscis tend to be obliterated by growth of connective tissue. (*c*) Two other cavities extend along the posterior region of the body, to some extent separated by the dorsal and ventral mesentery which moors the intestine. In these there is a body cavity fluid with cells.

Respiratory and vascular systems.—The respiratory system consists of many pairs of ciliated gill-slits. They open *dorsally* by minute pores behind the collar. In development they begin as a pair, increase in number from in front backwards, and they go on increasing long after

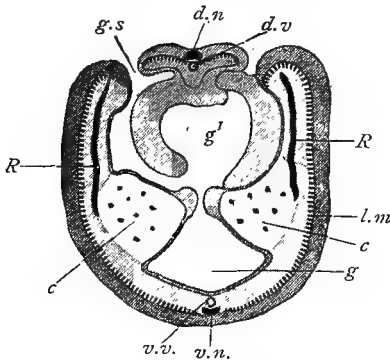

FIG. 235.—Transverse section through gill-slit region of *Ptychodera minuta*.—After Spengel.

The section, somewhat diagrammatic, shows a gill-slit (*g.s.*) to left, and a septum between two slits to the right; *d.n.*, dorsal nerve; *d.v.*, dorsal vessel; *v.n.*, ventral nerve; *v.v.*, ventral vessel; *g.*, nutritive part of gut; *g.l.*, respiratory part of gut; *c.*, lateral coelomic spaces; *l.m.*, longitudinal muscles; *R.*, reproductive organs. As the gill-slits are oblique, the whole of one could not be seen in a single cross-section.

the adult structure has been attained. Water passes in by the mouth and out by the gill-slits, where it washes branches of the dorsal blood vessel.

There is a main dorsal blood vessel, which, at its anterior end, forms a heart lying *above* the notochord, and below a closed contractile dilatation, sometimes called the “pericardium.” Beside the latter there is a paired “proboscis gland,” formed from the coelomic epithelium. There is a ventral vessel beneath the gut; and numerous smaller vessels. The almost colourless blood flows forwards dorsally, backwards ventrally. This system should be contrasted with that of *Amphioxus*.

Excretory and reproductive systems.—No nephridia are

known, but from the region of the collar two ciliated funnels open to the exterior, and the enigmatical proboscis gland is possibly excretory.

The sexes are separate. A number of simple paired genital organs lie dorsally in a series on each side of the body cavity in and behind the region with gill-slits (Fig. 235, *R.*). They open by minute dorsal pores.

Development.—The eggs are fertilised outside of the body. Segmentation is complete and approximately equal;

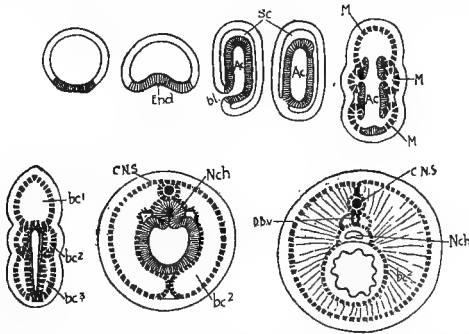

FIG. 236.—Direct development of *Dolichoglossus*.—After Bateson.

The mesoderm is represented by the broken dark line.

In the upper row, from the left—

Section of blastula; beginning of gastrulation, *End.*, endoderm; section of gastrula, *bl.*, blastopore; *Ac.*, Archenteron; *Sc.*, segmentation cavity; closure of blastopore, outgrowth of five coelom pouches (*M.*).

In the lower row, from the left—

Longitudinal section, showing the five parts of the body cavity (*bc.1*, *bc.2*, *bc.3*) or coelom.

Cross-section, *C.N.S.*, central nervous system; *Nch.*, notochord; *bc.2*, body cavity in collar region.

Section at a later stage, *D.b.v.*, dorsal blood vessel.

a blastosphere results; this is invaginated in the normal fashion, and becomes a gastrula.

The development may be direct without a larval stage, as in *Dolichoglossus kowalevskii*, or indirect with a *Tornaria* larva, as in *Balanoglossus biminensis*.

In the direct development the blastopore of the gastrula narrows and closes; the external surface of the gastrula becomes ciliated; the

endoderm lies as an independent closed sac within the ectoderm. Meanwhile the embryo has become or is becoming free from the thin egg envelope, and begins to move about at the bottom in shallow water. It elongates and becomes more worm-like; there is an anterior tuft and a posterior ring of cilia; the primitive gut forms five coelomic pouches; a mouth and an anus are perforated; there seem to be no fore-gut nor hind-gut invaginations. Two gill-slits appear; the regions of the body are defined at a very early stage.

In the indirect development, there is a *Tornaria* larva, at first bell-shaped. A ventral mouth opens into the curved gut, which is furnished with a posterior terminal anus. A "dorsal pore" leads into a thin-walled sac which becomes the proboscis cavity of the adult. There are external bands of cilia, something like those of an Echinoderm larva, and also an apical sensory plate (like that of many Annelid trochospheres), with two eye-spots. The *Tornaria* is a pelagic form. During its period of free pelagic life it gradually loses its distinctive bands of cilia, becomes diffusely ciliated, acquires a proboscis and two gill-slits, and thus approaches the form already described. It is elongated in the post-oral region, and becomes a creeping form. The *Tornaria* must be regarded as the more primitive larval form; the temporary absence of mouth and anus in the other type is probably an adaptation acquired after the pelagic habit was lost.

Johannes Müller ranked the *Tornaria* larva, whose adult form was not then known, beside the larvæ of Echinoderms, and the resemblance has been recently emphasised by Willey. The ciliated bands of the *Tornaria* resemble those of Echinoderm larvæ, but this is only a superficial characteristic. The anterior pouch, which forms the cavity of the proboscis and communicates with the exterior, has also been compared with the beginning of the water-vascular system in Echinoderms, and it is true that in both several independent coelom pouches grow out from the primitive gut. The anterior body cavity in *Balanoglossus* communicates with the exterior by a pore, which becomes the proboscis-pore of the adult, and this has been compared with the water-pore, or outlet of the water-vascular system of Echinoderms, which similarly opens from an anterior enterocoel to the exterior. On the other hand, the presence of an apical plate—a structure almost invariably absent in Echinoderms—suggests an affinity with an Annelid trochosphere.

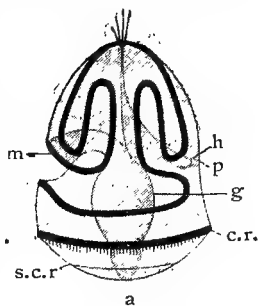

FIG. 237.—*Tornaria* larva, from the side.—After Spengel.

M., mouth; *g.*, gut; *a.*, anus; *h.*, heart; *p.*, pore entering proboscis cavity; *c.r.*, anal ring of cilia; *s.c.r.*, secondary anal ring. The dark wavy line indicates the margin of the lobes of the larval body with their bands of cilia. Note also the apical spot with cilia and sense organ.

Affinities with Vertebrates (especially emphasised by Bateson).

- (1) "*Notochord*."—A dorsal outgrowth from the anterior region of the gut grows forward for a short distance into the proboscis, and becomes a solid supporting rod (Fig. 236, *Nch.*). It may be compared with the notochord of Vertebrates, which also arises dorsally from the gut. But it lies *below* the main dorsal blood vessel, is of very limited extent, and may be merely an analogue of the notochord.
- (2) "*Gill-slits*."—Numerous gill-slits (Fig. 234) open from the anterior region of the gut to the exterior, and are separated from one another by skeletal bars, which in some ways resemble the framework of the respiratory pharynx in *Amphioxus*. There are, however, many differences in detail,—thus the slits open dorsally, not laterally; the skeletal bars are differently disposed; the blood supply is different.
- (3) "*Dorsal nerve-cord*."—A dorsal median insinking (Fig. 235, *d.n.*) of ectoderm, especially strong in the region of the collar, may be compared with the medullary canal of Vertebrates. But it must be noticed that there is also a ventral nerve-cord (Fig. 235, *v.n.*).
- (4) "*The œlom*."—The development of five enterocœlic pouches is very suggestive of affinities with *Amphioxus*.

Affinities with Annelids (after Spengel).

The larva (Tornaria) (Fig. 237) may be regarded as a modified Trochosphere, but this points at most to a far-off common stock. Moreover, the nephridia, usually present in the Trochosphere, are unrepresented in the Tornaria.

The heart lies, as in some Annelids, dorsal to the gut, not ventral as in Vertebrates; the dorsal vessel carries blood forwards, the ventral backwards, as is usual in Annelids. But the double nervous system is essentially different from that of Annelids; and the gill-slits are unrepresented there, though Salensky has described œsophageal pockets opening to the exterior in four Annelid types—*Polygordius*, *Saccocirrus*, *Spio fuliginosus*, and *Polydora cornuta*. In the last there are five pairs in the larva, and two persist. If there be a relationship between Enteropneusta and Annelids, it must be a very distant one, perhaps restricted to origin from some common stock.

CLASS PTEROBRANCHIA. (I) Cephalodiscus

Cephalodiscus dodecaopŕnus was dredged by the *Challenger* in the Magellan Straits. Others are known from Japan, the Malay Archipelago, South Africa, and the Antarctic. It was at first described by M'Intosh as a divergent Polyzoon, but the researches of Harmer point to relationship with *Balanoglossus*.

The minute individuals are associated together within a gelatinous investment; the colony may attain a size of 9 in. by 6 in. The gut is curved, the anus being beside the mouth, beneath which are 4-6 pairs of arms with ciliated tentacles. These two characters, formerly supposed to indicate Polyzoan affinities, may perhaps be adaptations to the sedentary life. With *Balanoglossus* this type has been compared, on account of the possession



FIG. 238.—Piece of a colony of *Cephelodiscus*, showing the tubes inhabited by the animals.—After Ridewood.

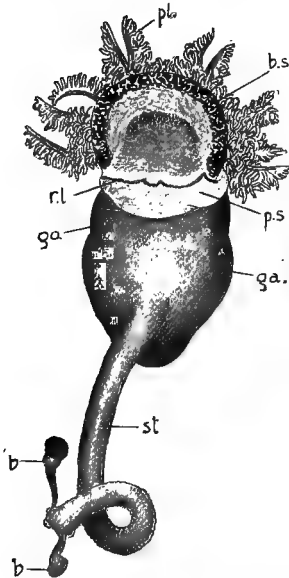

FIG. 239.—An individual *Cephelodiscus*.—After Ridewood.

b., Buds; *st.*, stolon; *go.*, to the left, bulging of the body caused by the gonad; *ga.*, to the right, bulging of the body caused by the stomach; *p.s.*, posterior lobe of buccal shield; *r.l.*, a red line on the buccal shield; *b.s.*, dark edge of the buccal shield; *pl.* tentacular plumes.

of the following characters:—(a) The body is divided into three regions, which correspond to the proboscis, collar, and trunk of *Balanoglossus*; this is especially obvious in the young bud; (b) each of the three regions contains a coelomic cavity, the most anterior being single, while the other two are divided by a median partition; (c) the anterior pre-oral cavity opens to the exterior by two pores (cf. proboscis pore of *Balanoglossus*); (d) the collar region is also furnished with two collar-pores; (e) in the collar region the dorsal nervous system is also placed, and is continued to some extent into the proboscis; (f) beneath the nervous system lies a diverticulum from the gut, which extends towards the proboscis region; this has been compared to the “notochord” of *Balanoglossus*; (g) the anterior region of the gut is perforated by

a pair of lateral gill-slits. The gonads lie between anus and pharynx. Buds are given off from a lateral stalk.

(2) Rhabdopleura

This genus is found at considerable depths in the North Sea and Atlantic. Like *Cephalodiscus*, the individuals are minute and stalked, and occur in a colony; in this case, however, they remain attached to one another by a common stolon, instead of being united only by an investment. The proboscis or buccal shield makes a thin annulated tube within which the polyp moves up and down. In the head region there are two hollow lateral arms bearing numerous ciliated tentacles, which have a skeletal support. The gut, as in *Cephalodiscus*, has a U-shaped curvature and an anterior diverticulum ("notochord"). There are five cœlomic cavities, and two collar-pores. There are no gill-slits.

CHAPTER XVIII

PHYLUM CHORDATA

SUB-PHYLUM UROCHORDA OR *TUNICATA*

(ASCIDIANS, SEA-SQUIRTS, ETC.)

THE Tunicates are remarkable animals, which seem to stumble on the border line between Invertebrates and Vertebrates. They were classified with Polyzoa and Brachiopoda as Molluscoidea, until, in 1866, Kowalevsky described the development of a simple Ascidian, and correlated it, step by step, with that of *Amphioxus*. He showed that the *larval* Ascidian has a dorsal nerve-cord, a notochord in the tail region, gill-slits opening from the pharynx to the exterior, and an eye developing from the brain. It is true that in most cases the promise of youth is unfulfilled; the active larva settles down to a sedentary life, loses tail and notochord, nerve-cord and eye, and becomes strangely deformed. Nevertheless we must now class Tunicates along with the Chordates. Of their possible relations to simpler forms nothing definite is known.

GENERAL CHARACTERS

The Tunicates are marine Chordata, but the chordate characteristics—dorsal tubular nervous system, notochord, gill-slits, and brain eye—are in most cases discernible only in the free-swimming larval stages. They usually degenerate in the course of their development, and the adults, which are in most cases sedentary, tend to diverge very widely from the Vertebrate type. Thus the nervous system is generally reduced to a single ganglion placed above the pharynx. The

body is invested by a thickened cuticular test, which contains cellulose. The relatively large pharynx is perforated by two (in Larvacea), or (in the majority) by numerous ciliated gill-slits, and is surrounded to a greater or less extent by a peribranchial chamber, which communicates with the exterior by a special dorsal (atrial) opening. The ventral heart is simple and tubular, and there is a periodic reversal in the direction of the blood current. Nephridia are absent, and the renal organs have no ducts. All are hermaphrodite. There is usually a metamorphosis in development. Colonies are frequently formed.

Type of TUNICATA—a simple Ascidian (*Ascidia mentula*)

An adult *Ascidia* is an irregular oval of 3 to 4 in. in length; one end is attached to stones or weed; the other, more tapering, bears the 8-lobed mouth; close beside this, on the morphological dorsal surface, lies the 6-lobed exhalant or atrial aperture. During life, water is constantly being drawn in by the mouth and passed out by the atrial opening. If irritated, the animal may drive a jet of water with considerable force from both apertures, whence the name "sea-squirt."

Test.—The whole body is clothed in a thick test, sometimes called a tunic, though this name is more frequently applied to the underlying body wall. From this body wall the test can be readily removed, the two being unattached except at one spot, where blood vessels pass into the test, and also to a less degree at the two openings. To begin with, this test is a true cuticle, produced by secretory prolongations of the ectoderm cells; but soon after its formation mesenchyme cells migrate into it, and give rise to patches of connective tissue cells. These cells apparently retain throughout life some phagocytic importance. In *Ascidia* outgrowths of the body wall with prolongations of blood channels enter the test, ramifying in all directions. In some Ascidians this is carried further, so that the test becomes an important accessory organ of respiration. The test consists in great part of a carbohydrate identical with the cellulose of plants. This "cellulose" or "tunicin" is common throughout the group, but the relative amount

produced varies markedly in the different forms. In some forms the "test"-cells make calcareous spicules.

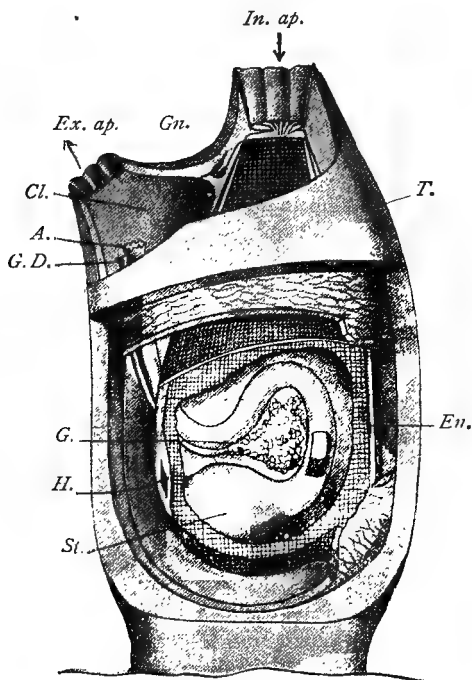

FIG. 240.—Dissection of Ascidian.—After Herdman.

In. ap., Inhalant aperture; *T.*, test, cut away below to show muscular layer, pharynx, etc.; *En.*, endostyle or ventral groove of pharynx. Note removal of pharynx to show, on the other—the left—side, stomach (*St.*), intestine (with fold seen at incision), and reproductive organs (*G.*); *H.*, opening of pharynx into oesophagus; *G.D.*, genital duct; *A.*, anus; *Cl.*, cloacal chamber; *Ex. ap.*, exhalant aperture; *Gn.*, lies above the ganglion, which is seen between the two apertures; beneath it is the sub-neural gland and its duct.

Body wall and muscular system.—The body wall, mantle, or tunic, disclosed by peeling off the test, is a structure of considerable complexity. Its outer surface is covered by a

single layer of ectoderm cells, which secrete the test. Beneath these there lies a gelatinous matrix containing numerous connective tissue cells, blood-carrying spaces, muscle cells forming slender fibres, and so on.

A true cœlom has been described in some embryos, but it is afterwards almost suppressed, being represented at most by the pericardium and small lacunar spaces. The *apparent* body cavity of the Ascidian—the space between gut and body wall—is, as we shall see, lined throughout by ectoderm.

The muscular system is not well developed. The muscle cells are much elongated and unstriped; they are aggregated into fibres of varying thickness, which form an irregular network on the right side of the body, while they are virtually absent on the left. Special sets of fibres form sphincters round the apertures.

Alimentary and respiratory systems.—The mouth opens into a short stomodæum, separated from the branchial sac itself by a sphincter muscle, whose posterior border is furnished with numerous simple elongated tentacles. Behind this lies a ciliated peripharyngeal groove. In the living animal the tentacles form a sort of sieve over the opening of the branchial sac. This sac is morphologically the pharynx, and extends almost to the posterior end of the body. It is separated from the mantle by a space whose dimensions vary greatly in the different regions of the body. This space is the peribranchial chamber, which is formed from the ectoderm, and communicates with the exterior by the atrial opening, and with the branchial sac by innumerable slits. The remainder of the alimentary canal lies on the left side of the body, between pharynx and mantle, and consists of a short œsophagus leading from the pharynx to the fusiform stomach, and of an intestine which describes an S-shaped curve, and then crosses the atrial chamber, to end in an anus lying beneath the exhalant opening. The absorbing surface of the intestine is increased by a marked infolding, corresponding to the typhlosole of the earthworm. A mass of tubules connected by a duct with the cavity of the stomach is possibly a digestive gland.

The structure of the pharynx is exceedingly complex, for it has a double function—respiratory and nutritive. More-

over, the breathing organs of sedentary animals tend to be elaborate. The water which enters by the branchial aperture is not only used in respiration, but brings with it the minute food particles. Similarly, the outgoing current carries with it the water used in respiration, the undigested residue of the food, and the spermatozoa and ova. The water of respiration passes from the pharynx through its numerous gill openings to the peribranchial chamber, and so to the exterior. On its way it purifies the blood in the vessels running in the complex framework of the pharynx wall. The water-current is produced and maintained by the action of the ciliated cells lining the gill-slits, and its force necessitates special arrangements to prevent the food particles being swept out before they have entered the digestive region of the gut. In this connection there is a longitudinal glandular groove or endostyle along the ventral surface of the pharynx, and a ciliated fold on its dorsal—the regions being defined by the nerve ganglion. According to Willey, the minute algæ and the like of the food are entangled in the abundant mucus secreted by the ventral groove or endostyle, and are swept forward in a cord of slime, until at the anterior end of the endostyle they reach the ciliated peripharyngeal groove, whose two halves surround the pharynx, and unite to form the dorsal lamina or fold. The food particles passing round the peripharyngeal groove are swept backwards by the cilia of the dorsal lamina until they reach the œsophageal opening. In many Ascidians the dorsal lamina is replaced by a series of processes—the dorsal languets, which may be sensory, as well as food-wafting structures.

Nervous system and sense organs.—In the adult both of these show marked degeneration. In the larva there is a slightly developed brain continued into a dorsal nerve-cord, and having connected with it a median eye and an otocyst. The two latter are completely absent in the adult, and the nervous system consists merely of a ganglionic mass lying between the two apertures, giving off a few nerves forwards and backwards.

A structure of doubtful utility, but of considerable morphological interest, is the small sub-neural gland which lies beneath the ganglion, and communicates by a ciliated duct with the pharynx. The opening

is usually complex, and forms the so-called dorsal tubercle, which is very distinct on the wall of the pharynx. It lies at the point where the two halves of the ciliated groove, or peripharyngeal band, already described, converge dorsally to form the dorsal lamina. In *Ascidia* the sub-neural organ is ventral to the brain, and partly

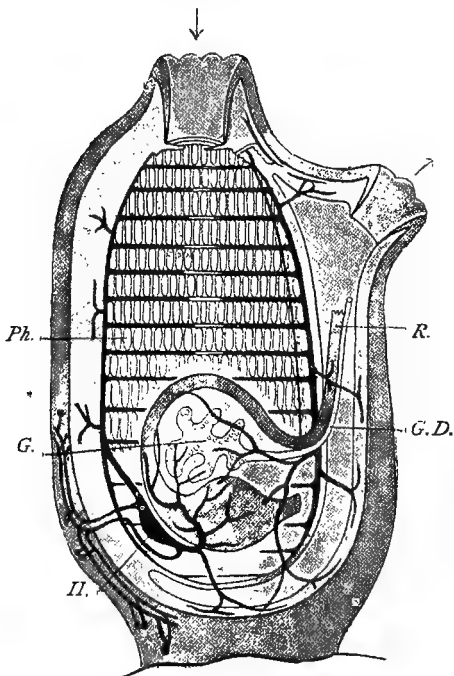

FIG. 241.—Diagram of Ascidian.—After Herdman.

The arrows indicate the two openings; the dark border the test. *Ph.*, Pharynx, with gill-slits; *G.*, reproductive organs; *H.*, heart, with blood vessels; *G.D.*, genital ducts; *R.*, rectum, ending in cloacal chamber. Surrounding the pharynx the peribranchial cavity is shown.

glandular in character, and so it is in many; in some cases, however, it is dorsal in position, and its glandular portion is reduced to nil. It is probable that the sub-neural gland and its duct correspond to the olfactory pit of *Amphioxus*, and perhaps to the hypophysis of Vertebrates.

It is probable that the pigment spots between the lobes of the apertures, the tentacles in the branchial siphon, and the dorsal lamina, or its representatives, the languets, have some sensory function.

Vascular system.—The simple tubular heart lies in a pericardial space at the ventral side of the lower end of the pharynx. In development, two diverticula grow out from the pharynx; these meet and fuse, forming the pericardium. The heart arises as an invagination from its dorsal wall, and is thus endodermal in origin, and probably not homologous with the heart of the other Vertebrates. A periodical reversal of the direction of the waves of contraction is discernible in the heart; for a certain number of beats the blood is driven upwards, and then the direction is reversed. This same reversal also occurs in *Phoronis*.

According to Herdman, the ventro-dorsal contractions occasion the following circulation:—The blood, which is spread out on the walls of the pharynx in vessels lying between the slits, collects into one large (branchio-cardiac) vessel, which, after receiving a vessel from the test, enters the ventral end of the heart. From the dorsal end it is poured into a great (cardio-visceral) trunk, which sends one branch to the test, and then breaks up among the viscera. From the visceral lacunæ the blood is again collected (in a branchio-visceral) to be distributed to the branchial sac. At the reversal of the contractions this circulation is also reversed. The reversal occurs every couple of minutes or so. The blood is very colourless, but usually contains a few pigmented corpuscles.

Excretory system.—In the loop of the intestine there lies a mass of clear vesicles containing uric acid and other waste products. This, therefore, seems to be a renal organ, but there is no duct. Bacteria are usually found in the vesicles, and their activity may make diffusion easier. It is interesting to find such a plant-like method of storing up, instead of eliminating, waste products in these very passive animals. It has been suggested that the sub-neural gland may have some renal function.

Reproductive system.—Tunicates are hermaphrodite. The reproductive organs (Fig. 240, *G.*) are very simple, and lie in the loop of the intestine. The ovary is the larger, and contains a cavity into which the ova are set free, and from which they pass outwards along an oviduct which opens into the cloacal chamber. The testis surrounds the ovary, and is mature at a different time (dichogamy); its

duct runs by the side of the oviduct. In some forms, where the gonads are near the cloaca, there are no ducts. The ova are surrounded by follicular cells, and probably fertilised in the cloaca.

Development.—The fertilised ovum divides completely and almost equally. The spherical blastosphere becomes slightly flattened, and ultimately forms a two-layered gastrula.

Along the dorsal median line of the gastrula the ectoderm cells form the medullary groove, the sides of which arch together and form a canal—the medullary canal. This opens anteriorly to the exterior by

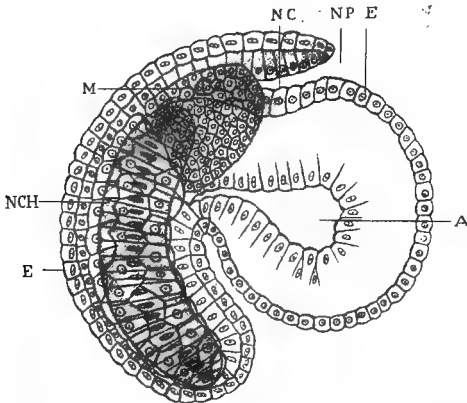

FIG. 242.—Young embryo of Ascidian (*Clavelina*).—After Van Beneden and Julin.

NP., Neuropore; *NC.*, neural canal; *NCH.*, notochord; *E.*, ectoderm; *M.*, mesoderm; *A.*, archenteron.

the neuropore, and posteriorly communicates with the archenteron by the neurenteric canal.

With regard to the origin of mesoblast and notochord, there is more difficulty. Both originate from the endoderm in the region of the blastopore, and for a time grow forward together. The notochord lies in its usual position on the roof of the gut, from a specialisation of which it arises; but its forward extension is limited,—it never extends into the anterior region, and in the posterior region—the future tail—it increases at the expense of the primitive gut, whose lumen it obliterates. The mesoderm, on the other hand, extends right forward, and becomes divided into two regions—a posterior, ultimately forming the musculature of the tail, and an anterior, giving rise to the blood, connective tissues, body muscles, excretory and genital organs. According to Van

Beneden and Julin, the mesoderm primarily originates in the form of two pockets, which grow out from the gut, as in *Amphioxus*, and whose cavity is the true cœlom. According to the majority of investigators, it originates as solid blocks of cells, and the body cavity is only represented by spaces produced by the subsequent separation of these cells.

The further processes of development result in the formation of a tadpole-like larva, with dorsal nervous system, notochord in the tail region, and well-developed sense organs. Two ectodermal invaginations form the original double peribranchial chamber, and small diverticula from the pharynx meet these and form the first gill-slits.

For some hours the larva enjoys a free-swimming life, using its tail as an organ of locomotion. Then it fixes itself by papillæ on its head,

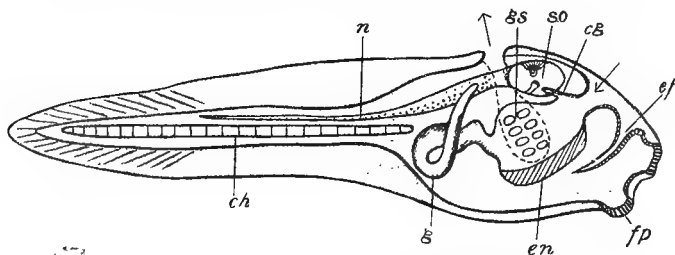

FIG. 243.—Embryo of *Clavelina*.—Modified after Seeliger.

f.p., Fixing papilla; *e.f.*, ectodermic fold; *c.g.*, ciliated groove; *en.*, endostyle; *s.o.*, cerebral vesicle with sense organs; *g.s.*, gill-slits; *n.*, nerve-cord beginning to degenerate; *ch.*, notochord; *g.*, gut curving upwards towards atrial opening. The atrial invagination is marked by a dotted line; the mouth and atrial opening are indicated by arrows.

and begins almost immediately to degenerate. The tail shrinks and disappears, being consumed by phagocytes. The nerve-cord is lost, and with it the larval sense organs, while simultaneously a change of axis results in the adult relation of parts. The peribranchial chamber becomes greatly enlarged, and its two openings fuse together to form the single atrial aperture of the adult. The gill-slits increase greatly in number, the increase being due both to the formation of new slits and to the division of those first formed, and the whole animal undergoes a metamorphosis which is one of the most signal instances of degeneration.

GENERAL NOTES ON TUNICATA

The description of *Ascidia* given above is, in its general outlines, applicable to all the simple Ascidians, which are

abundantly represented on British coasts. As contrasted with this type, we have in other members of the class most remarkable diversity in structure, habit, and life history.

The simple Ascidiæ are usually sedentary, growing fixed to stones, shells, or weed, and are widely distributed, occurring on or near the coasts of all seas. With the exception of the so-called social Ascidiæ (*e.g.* *Clavelina*), they do not reproduce by budding, but are often gregarious, great masses being found together.

To the compound Ascidiæ (*e.g.* *Botryllus*) those simple forms are linked by *Clavelina*, where each individual is surrounded by its own test, but is united to its fellows by a common blood system. In the compound Ascidiæ, on the other hand, many individuals are enveloped in a common test, and all like *Clavelina* possess the power of reproducing asexually by budding. There is, however, no doubt that the so-called compound Ascidiæ are an artificial group, whose members diverge widely in structure, though all display the two characters mentioned.

Some of the compound Ascidiæ are not fixed, but form floating colonies. These forms lead up to the beautiful *Pyrosoma* or phosphorescent fire-flame, where the whole colony with its numerous individuals swims as one creature.

All these belong to the Ascidian series, and display interesting diversity in their methods of development. The simplest case is that already described for *Ascidia*, where the tailed larva gives rise to a sexual adult without any power of budding. This occurs in almost all simple Ascidiæ, but even here there are indications of possible complication. Thus, on the one hand, in some, *e.g.* *Molgula*, there is a tendency towards abbreviation—the larval stage being suppressed, while, on the other, the adult acquires the power of reproducing asexually, *e.g.* *Clavelina*. Both processes are carried further in the compound Ascidiæ. In these the eggs have usually a considerable amount of yolk, and development takes place either in the atrial cavity of the mother, or in special brood-pouches. In consequence, the development, especially in the early stages, shows considerable modification, although the larval stage is quite distinct. Again, the tailed larva develops into an adult which has no sexual organs, but forms a colony by

budding. The individuals of the colony then give rise to eggs and so to larvæ. The development thus includes a distinct alternation of generations.

Budding takes place in many different ways in the compound Ascidiæ. In one set (the Diplosomidæ) the tailed larva is precociously reproductive, giving rise to buds before undergoing metamorphosis. This forms an interesting transition to the condition seen in *Pyrosoma*, where the fertilised egg gives rise to a rudimentary larva (cyathozoid), from which a young colony of four individuals arises by budding. These individuals again bud, until a large colony is formed, the members of which become sexual. The ova are few in number, a statement which is generally true for the pelagic Tunicates, as contrasted with sedentary forms.

While the Ascidiæ in the narrow sense include all the more typical Tunicates, there are two other sets, few in number both as regards genera and species, but of great theoretic importance.

The one set includes the free-swimming genera *Salpa* and *Doliolum*, together with the aberrant deep-water genus *Octacnemus*; the other, a few active free-swimming forms, which exhibit throughout life many of the characteristics of the larval Ascidian. Of these, *Appendicularia* is the most familiar type.

Both *Salpa* and *Doliolum* are pelagic in habit, and differ markedly in structure from the Ascidiæ. The body is fusiform (*Salpa*) or barrel-shaped (*Doliolum*), and wholly or partially encircled by definite muscle bands, which replace the scattered fibres of the Ascidiæ. The mouth is at one end of the body, and the atrial aperture at the other; the animals swim by forcing the water out of the peribranchial chamber posteriorly. Many of the most marked signs of specialisation in the Ascidiæ are here absent. Thus the test may be, as in *Doliolum*, very thin and devoid of cells, and the branchial sac is relatively simple in structure; the cilia on its walls are never so important in producing the respiratory current as in the Ascidiæ, and the gill-slits may be few in number, or, as in *Salpa*, may be represented by two large holes in the walls of the pharynx. Further, the hermaphroditism is modified by the occurrence of very marked protogyny, and the ova are never numerous—in *Salpa* each sexual individual usually produces only one.

On the other hand, the development exhibits marked alternation of generations, both solitary and colonial forms being included in one life history.

In *Doliolum* the fertilised egg gives rise to a tailed larva, which develops into an asexual "nurse," possessing the power of budding (cf.

Compound Ascidians). The ventral stolon of the nurse gives rise to a

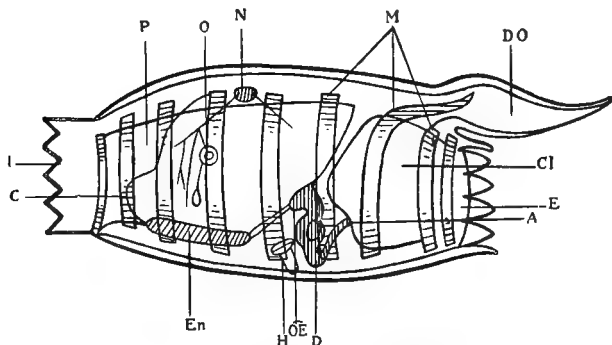

FIG. 244.—“Nurse” of *Doliolum mulleri*.—After Uljanin.

I., Inhalant, E., exhalant aperture; C., ciliated band round pharynx (P.); En., endostyle; O., “otocyst”; N., nerve-ganglion; H., heart; OE., cesophageal opening; D., stomach; A., anus; Cl., cloaca; DO., dorsal organ; M., muscle bands.

number of primitive buds, which migrate over the body until they reach a dorsal outgrowth, apparently well supplied with blood. Here they

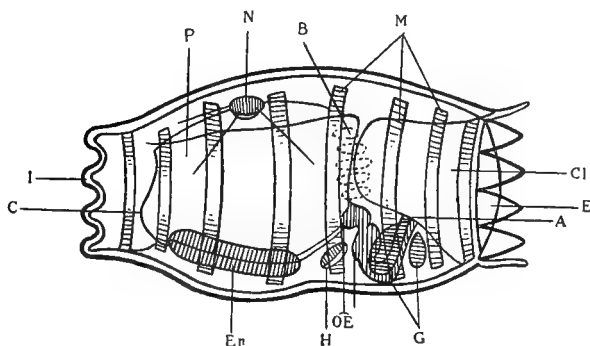

FIG. 245.—Sexual individual of *Doliolum mulleri*.—After Uljanin.

G., gonads; B., gill-slits; other letters as before. The unlettered reference line points to the stomach.

fix themselves and divide up to form three series of buds—two lateral and one median. All these buds develop into individuals belonging to

the sexual generation, but only a few become truly sexual. The two lateral series develop into nutritive forms, which supply the nurse with food. The nurse itself loses its alimentary and respiratory organs, and becomes a mere organ of locomotion. The median buds develop into "foster mothers," which ultimately go free, bearing with them other buds destined to develop into the solitary sexual forms. In these, first ova and then spermatozoa are produced, which start the life cycle afresh. It is thus obvious that there is considerable division of labour in the sexual form, accompanied by polymorphism; the whole process presents some curious analogies to the conditions seen in the Coelentera.

In *Salpa* the single egg is fertilised within the body of the mother, and becomes attached to the wall of the peribranchial chamber. Here the developing egg is nourished by means of a "placenta," and the development is in consequence much abbreviated, the tailed larva not being represented. This embryo gives rise to a solitary "nurse" form,

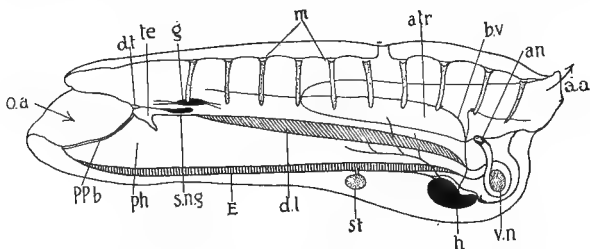

FIG. 246.—Diagram of *Salpa africana*.

o.a., Oral aperture; *d.t.*, dorsal tubercle; *te.*, tentacle; *g.*, ganglion; *m.*, muscle bands; *atr.*, atrium; *b.v.*, blood-vessel; *an.*, anus; *a.a.*, exhalant aperture; *v.n.*, visceral nucleus; *h.*, heart; *st.*, stolon; *d.l.*, dorsal lamina; *E.*, endostyle; *s.n.g.*, sub-neural gland; *ph.*, pharynx; *p.p.b.*, peri-pharyngeal band.

which by budding produces a chain of embryos. This chain is set free, its members become sexual, and, either while still united or after separation, give rise to the eggs which develop into the nurse form.

The remaining order of Tunicates includes minute simplified forms like *Appendicularia*, also pelagic in habitat, but without any power of budding, and never forming colonies. These forms have a distinct tail, which is bent at an angle to the body, and is the main-organ of locomotion. The mouth is at the anterior end; the anus, which is distinct from the atrial openings, is at the root of the tail. These atrial openings lie slightly behind the anus, and are merely small ectodermic invaginations communicating with the two gill-slits of the pharynx. They correspond to the similar invaginations in the Ascidian larva. The test may form a large investing "house," but it does not contain cells, and is periodically cast and renewed. The important points as regards internal structure are the presence of the notochord throughout life, and the structure of the nervous system. The latter consists of a lobed

ganglionic mass above the mouth, and a dorsal nerve-cord extending backward from this into the tail, where it is furnished with other ganglia. In connection with the cerebral ganglion there is a pigment spot, an otocyst (auditory?), and a tubular process communicating with the pharynx, and corresponding to the sub-neural gland and the ciliated duct of other Tunicates. We have already noted the simple structure of the pharynx, which has but two gill-slits communicating directly with the exterior. The same simplicity of structure is observable in the heart, which is without any associated vessels. The hermaphrodite

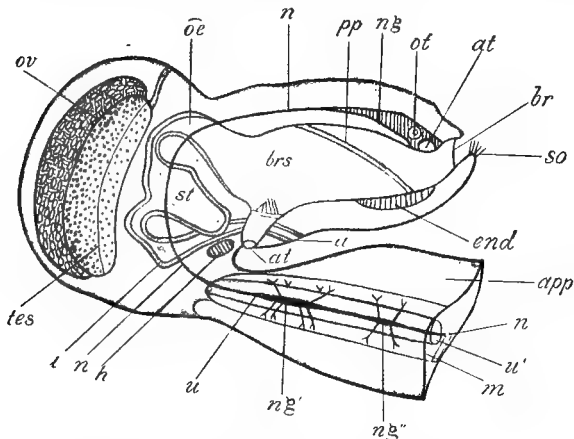

FIG. 247.—Anatomy of *Appendicularia*.—After Herdman.

s.o., Sense organ; br, branchial aperture; at, dorsal tubercle; ot, otocyst; n.g., nerve ganglion; pp, peripheral pharyngeal band; n, nerve-cord; æ, œsophagus; st, stomach; ov, ovary; tes, testes; i, intestine; h, heart; u, urochord, cut at u'; n.g', n.g'', nerve ganglia of tail; m, muscle band; app, tail cut through; a, anus; at, one of the atrial apertures; end, endostyle.

reproductive organs lie posteriorly, and open to the exterior by a very fine duct on the dorsal surface. As contrasted with *Salpa* and *Doliolum*, the animals are protandrous, and not protogynous. The development is unknown.

Classification.—

Order I. LARVACEA

Free-swimming, pelagic, and solitary forms provided with a large locomotor tail containing a notochord. The pharynx opens to the

exterior by two ventral ciliated slits, and there is no peribranchial chamber. The nervous system extends into the tail region. A relatively large cuticular "house" is formed as a secretion round the animal; it is periodically cast off and rapidly replaced. The house acts as a most efficient filtering apparatus for capturing minute diatoms and protozoa upon which the animal feeds. The Larvacea or Appendicularians are of special interest because they show little or no degeneration, and retain throughout life the chordate characters which other Tunicates lose during metamorphosis. *Appendicularia*, *Oikopleura*, *Fritillaria*, *Megalocercus*, *Kowalevskia*.

Order 2. ASCIDIACEA

Ascidians which may be fixed or free, simple or colonial, but which in the adult have no tail and no trace of notochord. There is a large branchial sac opening by many slits into the peribranchial chamber, which communicates with the exterior by a single opening. There is a permanent and well-developed cuticular test into which cells from the body migrate. Many have the power of budding, and there is frequently alternation of generations.

Sub-order 1. *Ascidia* Simplicis. Solitary fixed forms which rarely bud; when colonial, each individual has a separate test. *Ascidia*, *Phallusia*, *Ciona*.

Sub-order 2. *Ascidia* Compositæ. Fixed Ascidians which reproduce by gemmation, the individuals being embedded in a common investing mass. *Botryllus*, *Polyclinum*.

Sub-order 3. *Ascidia* Lucifera. Free-swimming Ascidians which reproduce by gemmation to form a colony, having the shape of a hollow cylinder, open at one end. There is one genus, *Pyrosoma*, widely represented, especially in tropical seas. They are brilliantly phosphorescent, and some attain a length of twelve feet.

Order 3. THALIACEA

Free-swimming pelagic forms, which may be either single or "social," and in the adult are never provided with tail or notochord. The muscles are in the form of distinct circular bands, which effect locomotion by squirting out the water from the body. The test, which may be well or ill developed, is always transparent. The life history exhibits distinct alternation of generations, and there is sometimes polymorphism.

(a) *Cyclomyaria*. Muscle bands form complete rings. *Doliolum*, *Anchinia*.

(b) *Hemimyaria*. Muscle bands are in the form of incomplete rings. *Salpa*, *Octacnemus*.

RELATIONSHIPS

The questions as to the origin of the Tunicates and the relations of the orders are too difficult to be discussed here, but we may note that

there are two possible views as to the position of *Appendicularia* and its allies. They may be regarded as the slightly modified descendants of the primitive Tunicates, from which the Ascidiæ have diverged in the direction of degeneration, or as prematurely sexual larvæ derived from an already degraded Ascidian-like form. Both views have had supporters, and the one adopted materially affects the general method of regarding the group.

In any case the Larvacea retain persistently a number of characters which were probably possessed by the primitive Tunicata.

There are several resemblances between Tunicates and Lancelets (see the next chapter), *e.g.* the relatively large respiratory pharynx and the peribranchial cavity, but this probably does not mean more than that both groups arose from a common stock of primitive chordate animals

CHAPTER XIX

PHYLUM CHORDATA

SUB-PHYLUM CEPHALOCHORDA

(*Synonyms*—ACRANIA, LEPTOCARDII, PHARYNGOBRANCHII)

THIS small sub-phylum includes about sixteen species, popularly known as lancelets. The type represents an offshoot from the primitive Vertebrate stock, lost, it is to be feared, for ever; but while some authorities regard it as a pioneer-type and as a far-off prophecy of a fish, others hold it to be degenerate—a “weed in the Vertebrate garden.” It is possible that both views are right, and that the lancelet is a somewhat degenerate pioneer.

GENERAL CHARACTERS

There is a dorsal tubular nerve-cord, but no well-defined brain region. The notochord is persistent and unsegmented; it is surrounded by a continuous sheath, and projects in a unique manner in front of the anterior end of the nerve-cord. In the adult the gill-slits are very numerous, and open into an atrial or peribranchial cavity. The body wall is built up of over fifty myotomes. From Fishes, the lancelets are widely removed by the absence of limbs, skull, jaws, differentiated brain, sympathetic nervous system, eye, ear, definite heart, spleen, and genital ducts. There are numerous separate nephridia. The gonads are numerous and arranged segmentally. The larval form is strangely asymmetrical and the larval period is prolonged. The species have a wide distribution, like many old-fashioned animals. They occur near the coasts in warm and temperate seas, are sluggish in habit, and feed on microscopic organisms or organic particles.

Amphioxus lanceolatus, the best-known species

Mode of life.—The lancelets are fond of lying in the sand in water about two fathoms deep, with only the fringed aperture of the mouth projecting. They feed on diatoms and other small organisms, which are sucked into the mouth. At times, especially in the evening, the adults start up and swim about, but they are never so active as the larvæ. The early embryo is pelagic. It is of interest to note that along with lancelets, specimens of the Annelid *Ophelia* are often obtained; they closely resemble lancelets, not only in shape and size, but also in the way they burrow and swim.

Form.—The body, between $1\frac{1}{2}$ and 2 in. in length, is pointed at both ends, as the names suggest. The living

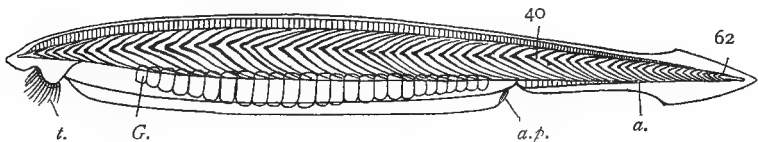

FIG. 248.—Lateral view of *Amphioxus*.—After Ray Lankester.

The notochord runs from tip to tip.

t., Tentacular cirri; *G.*, reproductive organs; *a.p.*, atriopore;
a., position of anus; 40 and 62, indicate number of myotomes.

animal is translucent, with a faint flesh colour, and is much plumper than a spirit specimen. The muscles are arranged in sixty-two segments or myotomes. There are three unpaired apertures—(*a*) the median, ventral, pre-oral hood overarching the true mouth, and fringed with tentacle-like cirri; (*b*) the atriopore in myotome thirty-six, giving exit to the water which enters by the mouth; (*c*) the anus, ventral and slightly to the left, behind the atriopore, but some distance from the posterior end of the body. Along the back there is a median fin, which is continued around the tail, and along the ventral surface as far as the atriopore. In front of this region the ventral surface is flattened, and fringed on either side by a slight fin-like “metapleural” fold. These folds are continuations downwards of the walls of the atrial or branchial chamber, which extends from

behind the mouth to the atriopore, and into which the gill-slits of the pharynx open in the adult.

Skin.—The epidermis consists of a single layer of cylindrical cells. Some of them project slightly from the surface,

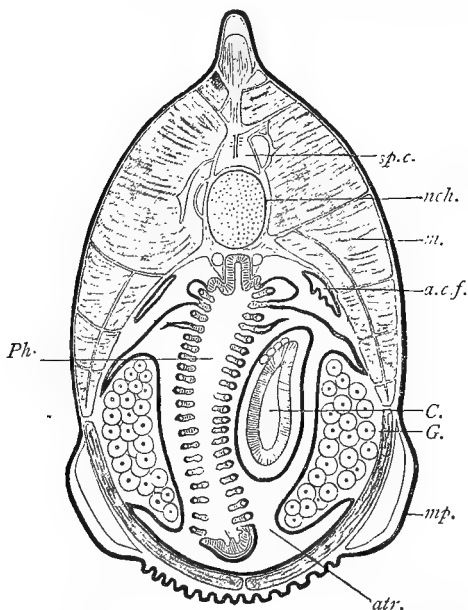

FIG. 249.—Transverse section through pharyngeal region of *Amphioxus*.—After Ray Lankester.

s.p.c., Spinal cord; *nch.*, notochord, beneath which lie the two dorsal aortæ; *m.*, myotome; *a.c.f.*, atrio-coelomic funnel, opening into sub-chordal coelom; *C.*, caecum; *G.*, a genital sac with ova; *mp.*, metapleural fold; *atr.*, atrial cavity; *Ph.*, pharynx, with dorsal and ventral grooves, and bars between gill-slits. Note in the primary bars and in the ventral groove the small coelomic spaces. The ectoderm is dark throughout.

and are connected at the base with nerve-fibres. These are sensory cells, and may be compared to the cells of the lateral line in fishes and tadpoles. Here, however, they are scattered over the surface of the body, though especially

abundant on the buccal cirri. The epidermis lies upon a thin layer of clear cutis.

Beneath this there is a layer of fine tubes, which unite in a longitudinal canal running along each metapleural fold. These metapleural canals are said by some to arise in development by a splitting of an originally solid mass (schizocœlic); but it seems more probable that they are morphologically portions of the true cœlom—ventro-lateral extensions of the “collar-cœlom” (enterocœlic).

Skeleton.—This is slightly developed, for there is not only no bone, but the material is not even definitely cartilaginous. It may be called “chordoid” tissue.

(a) The notochord runs from tip to tip. It consists of vacuolated cells, and the supporting power is probably due to their turgidity, as in many vegetable structures. Its anterior extension beyond the end of the nerve-cord is particularly characteristic.

(b) The pharynx is supported by chitinoid bars, which border the numerous gill-slits. There is also a series of paired plates underlying the mid-ventral groove.

(c) The margin of the pre-oral hood contains a supporting ring, segmented into about two dozen pieces, each of which sends a process into the adjacent cirrus.

Connective tissue.—The sheath which envelops the notochord and is continued round the nerve-cord, the septa of connective tissue (myocommas) which divide the muscle segments, and the numerous “fin rays” which support the dorsal and ventral fins, may be noticed here.

Muscular system.—The sixty-two muscle segments, myotomes, or myomeres, are dovetailed into one another like a succession of V-shaped plates, and are particularly strong dorsally. These produce the side-to-side wriggling movements by which the animal swims. On the ventral surface, between the mouth and the atriopore, there is a transverse set of fibres, which help to drive out the water from the atrial cavity. Other muscles occur in the region of the mouth, and elsewhere. Most, if not all, of the fibres are striated.

Nervous system.—The dorsal nerve-cord is shorter than the notochord, and has no definite brain. In the anterior region, however, there is some differentiation in minute structure, and the central canal widens out to form the so-

called cerebral vesicle, which in the larva communicates with the exterior by a pore (the neuropore). From the nerve-cord there arise two sets of nerves, dorsal and ventral. Of these the two anterior pairs of dorsal nerves, which go to the pre-oral hood, are called cranial, and do not correspond to the myotomes. Behind these a pair of dorsal nerves arise at each myotome, but, as is the case with most of the other segmentally arranged parts of the lancelet, the members of a pair are not directly opposite to one another. The ventral nerves are absent in the region of the two first pairs of dorsals, and behind this they divide up into many minute fibres just as they leave the nerve-cord. The two sets of nerves are compared respectively to the single-rooted sensory dorsal nerves, and to the many-rooted motor ventral nerves of higher Vertebrates. But the dorsal nerves of *Amphioxus* supply the transverse muscles as well as the skin, so that they must be partly motor. Furthermore, there is no connection between the two sets, and the dorsal nerves have no ganglia, except in so far as these are represented by aggregations of nerve nuclei. Nor are there any sympathetic ganglia.

The nervous system of the lancelet is thus very divergent from what is typical for Vertebrates:—(1) A brain is almost undeveloped; (2) the ventral roots far outnumber the dorsal roots; (3) the two sets of roots do not unite; (4) the dorsal nerves are partly motor; (5) there are no spinal ganglia; (6) there are no sympathetic ganglia.

The anterior region of the nerve-cord exhibits some histological distinctiveness; and with it the following structures are associated:—

(a) Slightly to the left side there is a ciliated pit, often called olfactory. It arises from an ectodermic invagination in the position of the neuropore or original anterior opening of the nerve-cord. Below this there is a minute diverticulum from the front dorsal wall of the nerve-cord.

(b) At the end of the nerve-cord there is a pigment spot, sometimes called an eye-spot. There are no true eyes, but numerous regularly arranged pigment spots on each side of the spinal cord appear to be optic.

(c) On the roof of the mouth there opens a small sac, the pre-oral pit, which may have a tasting or smelling function.

It is likely that the most important sensory structures of the adult are the sensitive cells of the epidermis. The feeble development of sense organs may be associated with the almost sedentary habit.

Alimentary and respiratory systems.—The true mouth lies within the projecting pre-oral hood. It is surrounded

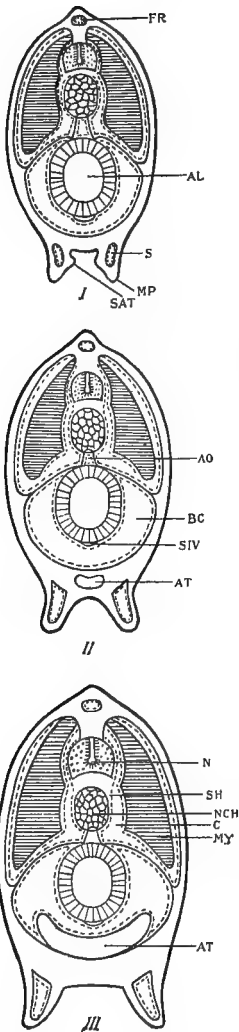

by a membrane called the velum, and is fringed by twelve velar tentacles, which must not be confused with the external cirri. In the larva the hood is absent, and the mouth is flush with the surface.

The mouth opens into the pharynx, which, like it, is richly ciliated. The pharynx, like that of Tunicates, and indeed of Fishes also, is modified for respiration (Fig. 249, *Ph.*). Its walls are perforated by numerous gill-slits on each side, and between these lie supporting bars alternately split and unsplit at their lower ends.

Along the mid-dorsal and mid-ventral lines there are grooves, respectively called hyper- and hypo-branchial. The latter is comparable to the endostyle of Ascidians, by which name it is often called. As in Ascidians,

FIG. 250.—Development of atrial chamber in *Amphioxus*.—After Lankester and Willey.

In I. the metapleural folds are seen sending a slight projection inwards. In II. the two projections have united and enclose a small space (*AT.*), which is the rudiment of the atrial chamber. In III. this space is enlarging at the expense of the coelom, which it pushes up before it. A comparison of this figure with the cross-section of the adult (Fig. 249) will show the relation of coelom and atrial chamber.

FR., coelomic space within dorsal fin; *AL.*, gut; *S.*, coelomic space of metapleural fold; *MP.*, metapleural fold; *SAT.*, projection which forms floor of atrial chamber; *AO.*, aorta; *B.C.*, coelom; *S.I.V.*, sub-intestinal vein; *N.*, nerve-cord; *SH.*, sheath of notochord; *MY.*, myotome; *C.*, remains of myocoel; *AT.*, atrial chamber. The dotted line indicates the mesodermic wall of the coelom.

two ciliated bands—the peripharyngeal bands—encircle the anterior part of the pharynx.

The water-current which enters the mouth is, as in Tunicates, connected both with respiration and nutrition. The food particles, entangled in mucus, are said to pass backwards along the hyperpharyngeal groove; the water passes down the pharynx, through its numerous gill-slits to the atrial chamber, and so to the exterior by the single atriopore. In the larva the gill-slits are few in number, and open directly to the exterior; in the adult they are concealed by the atrial chamber, and have greatly increased in number; there may be more than 100 pairs. The water-currents are kept up by the cilia, probably assisted by the transverse muscles.

The first sign of the development of the atrial chamber is the appearance of two lateral folds on the body wall, which form the metapleural folds of the adult. On their inner apposed, but not united, surfaces, two ridges appear. These grow towards one another and unite, leaving only the atriopore open. Thus the floor of the atrial chamber (Fig. 250, II.) is produced. The chamber, as first formed, is a tube with a very small lumen, but, secondarily, it becomes enlarged, and extending upwards and inwards, constricts the coelom, until it comes almost to surround the gut. The atrium eventually becomes a cavity, crescent-shaped in cross-section, surrounding the pharynx and extending backwards as a blind pouch on the right side of the intestine. At the same time, the metapleural folds increase in size until they assume the adult appearance (Fig. 250, III.). During these processes the originally few gill-slits have been increasing in number, both by the addition of new slits and by the division of those first formed. The division is effected by the downward growth of a secondary bar or tongue-bar in the middle of each slit. The primary bars differ from these tongue-bars in being split at their lower ends, in enclosing a coelomic space, and in some other respects.

The pharynx opens into the intestinal region of the gut, which is straight and simple. Near its commencement a pouch-like “liver” or cæcum (Fig. 249, C.) arises, and extends *forwards* on the right side of the pharynx. The anus is some distance from the end of the body (cf. Fishes); in the larva it is close to the caudal fin.

Body cavity.—This can only be understood when its development is studied (see Fig. 254). It is a fine example of what is called the *enterocœlic* mode of origin. From the archenteron of the embryo a hollow ridge grows out on each side, and becomes almost at once

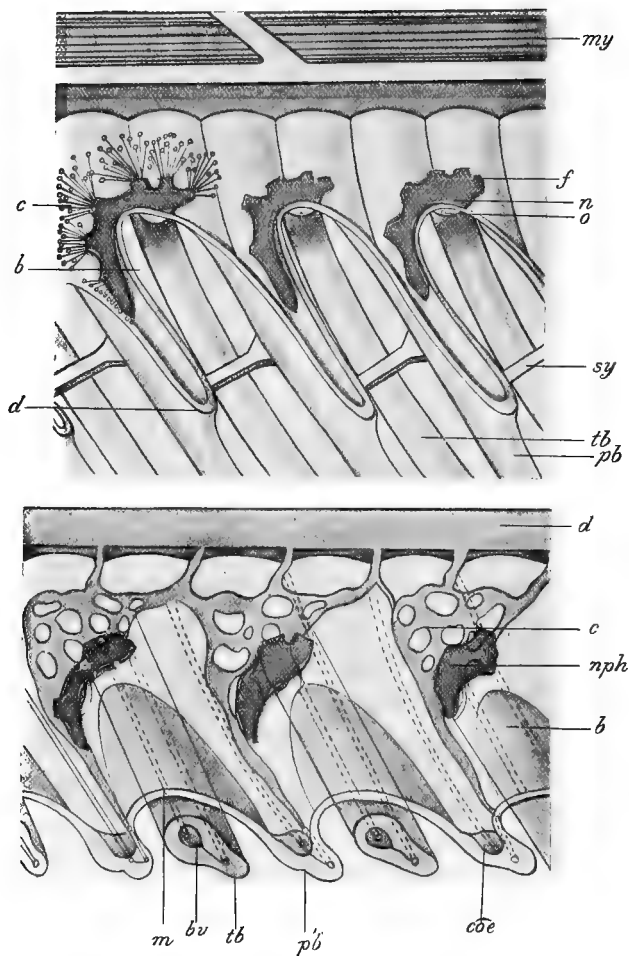

FIGS. 251 and 252.—The nephridia of *Amphioxus*.—After Boveri.

Both figures are lateral views of the upper region of the pharynx, the body wall being removed. In the upper figure the atrial chamber is laid completely open by the removal of its outer

segmented into a series of small sacs. These lie one behind the other, and lose all connection with the gut. Each ultimately divides into two—a dorsal thick-walled portion, and a ventral thin-walled portion. The dorsal portions form the body musculature, and retain their segmentation. Their cavity, the myocœl, persists to some extent in the adult, forming the system of lymph spaces and canals which lie below the cutis. In the ventral portions the septa disappear, and the enclosed spaces, bounded by somatic mesoderm and splanchnic mesoderm, unite to form the “splanchnocœl” which surrounds the gut. In the adult this space is reduced anteriorly to small spaces and cœlomic canals, by the development of the atrial chamber (see Figs. 249 and 250). The cœlomic spaces and canals contain coagulable fluid, and represent the lymphatic system of higher forms.

Besides the main trunk portion of the cœlom, there is an anterior portion, which is separated off from the very front of the gut, and is then divided into two cavities. The right becomes the cavity of the snout in the larva, but is almost obliterated in the adult. The left becomes the pre-oral pit. This anterior cœlom pouch may correspond to the head cœlom of *Balanoglossus*, and to the bilobed head cavity which lies beneath the eyes of fishes, and forms most of the eye muscles.

Thirdly, there is a pair of pouches, which form the first pair of muscle segments, and are continued out into the atrial folds. These may correspond to the collar cœlom of *Balanoglossus* (MacBride).

Two brown canals or atrio-cœlomic funnels discovered by Professor E. Ray Lankester open into the dorsal part of the atrium about the level of the junction between pharynx and intestine, while their anterior ends project into the dorso-pharyngeal cœlom about the 27th myotome. They are probably diverticula of the atrium.

Circulatory system.—The blood is colourless, with a few amœboid cells. There is no definite heart, but the branchial artery is rhythmically contractile.

This branchial artery lies in the portion of the body cavity which is enclosed by the endostyle, and is the anterior continuation of a large hepatic vein from the cœcum. From the branchial artery a series of smaller vessels arise, which pass up the primary gill-bars, and also supply the tongue-bars. These unite on the dorsal surface of the

wall, which is cut through along its line of insertion. The result is to show that the chamber is prolonged dorsally into a series of bays (*b.*), which lie on the surface of the tongue-bars (*t.b.*). Into these bays each of the nephridia (*n.*) opens by a pore (*o.*), while they also project internally by blind funnels (*f.*), fringed by very large solenocytes (*c.*). The bays are separated by ridges (*d.*), formed by a downgrowth of the walls of the cœlom over the primary bars (*p.b.*). *my.*, A myotome; *sy.*, one of the synapticula connecting the pharyngeal bars.

The lower figure is a more superficial view, to show the blood vessels which form an anastomosing plexus (*c.*) over the walls of the nephridia (*nph.*). *d.*, Dorsal aorta; *cœ.*, cœlomic space within primary bar; *b.v.*, blood vessel of secondary bar; *m.*, cut edge of the wall of the atrial chamber; other letters as before.

pharynx to form the right and left dorsal aortæ, which join at the hinder end of the pharynx to form a single vessel running backward over the intestine, and breaking up into capillaries on its wall. From the right dorsal aorta there arises a complex of vessels supplying the anterior region. From the capillaries of the intestine the blood is collected in a sub-intestinal vein, which again breaks up in the cæcum. The circle is completed by the capillaries which form the hepatic vein. The course of the circulation is essentially that of a Vertebrate.

Excretory system.—Boveri has described an elaborate system of about ninety pairs of *nephridia* lying in the dorso-lateral wall of the pharynx. They are short tubules, with a single opening into the atrial cavity. On the inner aspect there are a number of blind funnels projecting into the body cavity. On these funnels are set a number of solenocytes (like those on the nephridium of some Polychætes), which are long tubular cells (Fig. 251, *c.*), closed above by a knob containing the nucleus, from which hangs down a long flagellum. The vessels of the primary gill-bars and of the tongue-bars form an anastomosing vascular plexus, called a glomerulus, over the tubules. In number the tubules correspond to the primary gill-clefts, and are therefore in origin segmental structures. They are regarded by their discoverer as equivalent to the pronephric tubules of Vertebrates. They develop from the mesoderm.

Reproductive system.—The sexes are separate and similar. The organs are very simple, and without ducts. They form twenty-six pairs of horseshoe-shaped sacs, lying along the inner wall of the atrial cavity in segments ten to thirty-five on each side (Fig. 248, *G.*). Each lies in a "genital chamber" formed in development by constriction from the cavity of the myotome.

In the mature female the ovaries are large and conspicuous; the ova burst into the atrial cavity, whence they pass out by the atriopore.

The testes are like the ovaries; the spermatozoa burst into the atrial cavity, and pass out by the atriopore. The eggs are fertilised in the surrounding water.

Development.—The fertilised ovum is about $\frac{1}{250}$ in. in diameter. The segmentation is complete and almost equal (Fig. 253). The first cleavage is vertical, and divides the ovum into two equal parts; the second is also vertical, along a meridional plane at right angles to the first, and the result is four equal cells. The third cleavage is equatorial, and gives rise to four larger cells (or macromeres) below or towards the vegetative pole, and to four smaller cells (or micromeres) above or towards the animal pole.

The blastosphere, which is the final result of segmentation, invaginates to form a gastrula.

Along the mid-dorsal line of the gastrula the ectoderm cells sink in slightly so as to form a groove. This is the medullary groove, which here follows an unusual course of development. Instead of immediately closing to form a canal, the groove sinks inwards, and the lateral ectoderm grows over it before closing takes place. Later, the groove forms the medullary tube, which opens posteriorly into the

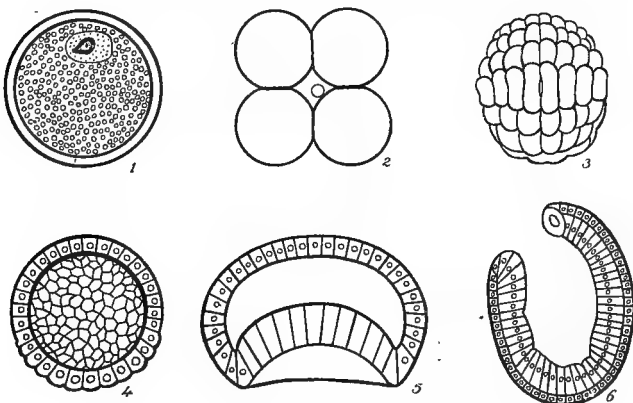

FIG. 253.—Early stages in the development of *Amphioxus*.
—After Hatschek.

1. Ovum with germinal vesicle; 2. four-cell stage; 3. external appearance of blastula; 4. blastula in section; 5. beginning of gastrula stage; 6. section of completed gastrula.

gut by a “neurenteric canal,” and to the exterior by the anterior neuropore (Fig. 254).

The cavity of the gastrula—the archenteron—becomes the gut of the adult, and gives rise to the coelomic pouches.

The notochord arises along the mid-dorsal line of the archenteron; its forward extension is secondary.

During the early part of larval life the ectoderm cells, including those forming the medullary canal, are ciliated. At this stage the larva is much more active than the adult.

The later larvæ are more sedentary, lying much on the

right side, and they are strongly asymmetrical. The mouth is placed at the left side; the gill-slits of one side appear considerably before those of the other; the primitive segments of one side are not opposite those of the other, and

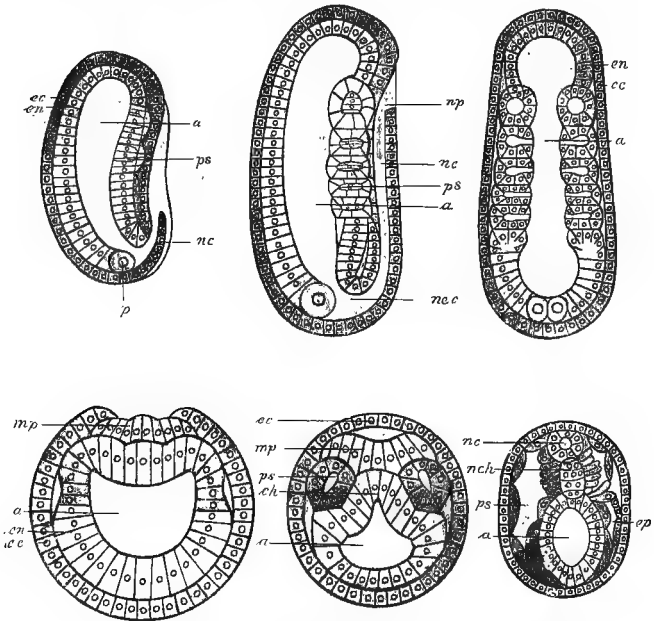

FIG. 254.—Sections through embryos of *Amphioxus*, to illustrate development of body cavity.

On the upper line, three longitudinal sections; on the lower line, three transverse sections. *ec.*, Ectoderm; *en.*, endoderm; *a.*, archenteron; *p.s.*, primitive segments (protovertebræ); *n.c.*, nerve-cord; *p.*, posterior end; *np.*, neuropore; *nec.*, neurenteric canal; *m.p.*, medullary or neural plate; *ch.*, notochord; *ep.*, splanchnocoel—above it is the myocoel.

so on. By the process known as the “symmetrisation” of the larva, the apparent symmetry of the adult is produced. The adult position of the anus and of the olfactory pit, both to the left side, and the position of the unpaired liver diverticulum, show how partial this process is.

Experimental embryology.—As an illustration of experimental embryology, and of the developmental potentiality of the early segmentation cells, reference may be made to the experiments of Professor E. B. Wilson.

By shaking the water in which the two-celled stages floated, Professor Wilson separated the two cells, and the result was two quite separate and independent twins of half the normal size. Each of the isolated cells segments like a normal ovum, and gives origin, through blastula and gastrula stages, to a half-sized metameric larva.

If the shaking has separated the two first segmentation cells incompletely, double embryos—like Siamese twins—result, and also form short-lived (twenty-four hours) segmented larvæ.

Similar experiments with the four-celled stages succeeded, though development never continued long after the first appearance of metamerism. Complete isolation of the four cells resulted in four dwarf blastulæ, gastrulæ, and even larvæ. Separation into two pairs of cells resulted in two half-sized embryos. Incomplete separation resulted in one of three types—(a) double embryos, (b) triple embryos—one twice the size of the other two—and (c) quadruple embryos, each a quarter size.

Isolated blastomeres of the eight-celled stage never formed gastrulæ. Flat plates, curved plates, even one-eighth size blastulæ were formed, but none seemed capable of full development.

Thus a unit from the four-cell stage may form an embryo, but a unit from the eight-cell stage does not. For various reasons it seems likely that this is due to qualitative limitations, not merely to the fact that the units of the eight-cell stage are smaller. For although the separated cells of the eight-cell stage have considerable vitality, and swim about actively, the difference between macromeres and micromeres has by this time been established; in fact, the cells have begun to be specialised, and have no longer the primitive completeness, the absence of differentiation, which explains the developmental potentiality of the separated units of the two-celled or four-celled stages.

Somewhat similar experiments have been made by other investigators on the developing ova of Ascidiæ, sea-urchins, etc. Specialisation of segmentation cells appears to occur at different times in different animals, but it is illogical to infer the absence of specialisation from the fact that any of the first four blastomeres, let us say, can produce an entire embryo. For specialised cells may retain a power of regeneration.

RELATIONS OF AMPHIOXUS AND TUNICATES

The above account of *Amphioxus* will in its details recall to the student the description of Tunicates. It is indeed remarkable that the resemblance should be so much stronger in minor anatomical points than in broad outline, but this is in part explained by the very marked degeneration displayed by the adult Ascidiæ,

The following important resemblances should be noticed :—In both cases the walls of the pharynx are perforated by numerous slits, which open, not directly to the exterior, but into an atrial or peribranchial chamber, formed from the ectoderm, and with a single external aperture. In both, the pharynx has a distinct ventral glandular endostyle, and a dorsal fold (Tunicates) or groove (*Amphioxus*), connected anteriorly to the endostyle by means of a ciliated band.

On the other hand, the Ascidians differ from the lancelets in many ways, *e.g.* the sessile habit, the presence of the test, of a heart, and of genital ducts; the absence of segmentation, of nephridia, and any trace of cœlom in the adult; the U-shaped alimentary canal; the power of budding, so common in sedentary animals; and the hermaphroditism.

The detailed study of development yields similar series of facts—marked resemblances coupled with marked differences; among the latter, the absence in Ascidians of the segmented cœlomic pouches of lancelets is especially noteworthy. It is probable that Lancelets and Tunicates are descended from a common primitive chordate ancestry.

In strict usage the name *Amphioxus* should be replaced by *Branchiostoma*, and another genus, *Asymmetron*, with uniserial (right) gonads and asymmetrical metapleura, should be recognised.

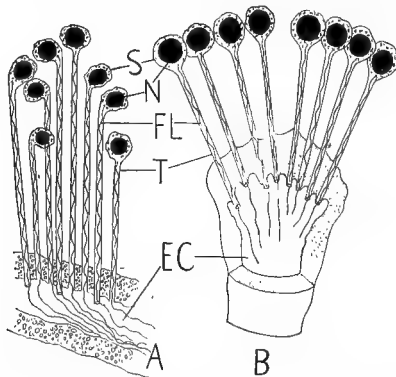

FIG. 254A.—Small portions of excretory organs of *Amphioxus* (A), and the Polychæte, *Phyllodoce* (B).—After Goodrich.

S., Solenocyte; *N.*, nucleus; *FL.*, flagellum; *T.*, tube; *EC.*, excretory canal.

CHAPTER XX

STRUCTURE AND DEVELOPMENT OF VERTEBRATA

THE obvious distinction between higher and lower animals, between the backboneed and the backboneless, was to some extent recognised by Aristotle over two thousand years ago.

Yet it was not till 1797 that the line of separation was drawn with firmness—by Lamarck.

But the doctrine of descent—the idea of organic evolution—which Darwin made current intellectual coin in 1859, suggested inquiry into the apparently abrupt apartness of the group of Vertebrates.

The inquiry bore fruit in 1866, when the Russian naturalist Kowalevsky worked out the development of the Vertebrate characteristics of *Amphioxus*, correlated this with the development of Ascidians, and discovered the pharyngeal gill-slits of *Balanoglossus*. Thus the apparent apartness of the Vertebrata was annulled.

GENERAL CHARACTERS

Vertebrates are cœlomate Metazoa, with a segmental arrangement of parts. The central nervous system lies in the dorsal median line, and is tubular in its origin. A skeletal rod or notochord, formed as an outgrowth along the dorsal median line of the primitive gut, is always present in the embryo at least, but tends to be replaced by a mesodermic axial segmented skeleton—the backbone. Pharyngeal gill-slits, which may or may not persist in adult life, are always developed, but above Amphibians they are restricted to embryonic life, are not directly functional, and have no associated gill-lamellæ. The heart is ventral. The eye begins its development as an outgrowth from the brain.

GRADUAL APPEARANCE OF VERTEBRATE CHARACTERISTICS

	BALANOGLOSSUS.	TUNICATA.	AMPHIOXUS.	CRANIATA.
Dorsal nervous system.	Dorsal and ventral nerve-cords.	In most the dorsal nervous system degenerates to a single ganglion.	Very slight hint of differentiation between brain and spinal cord.	Brain and spinal cord.
Dorsal axis.	A slight anterior supporting rod.	A supporting rod in the tail, transitory in most types.	A notochord from tip to tip.	Except in Cyclostomata and some fishes, the notochord is for the most part replaced by the backbone.
Gill-clefts.	Numerous.	A primary pair, replaced in most types by numerous secondary slits.	Numerous.	Not more than eight gill-clefts. In forms above Amphibians they have no associated gills, and are not respiratory.
Ventral heart.	The simple heart is dorsal and above the supporting rod.	Simple ventral heart of doubtful homology.	No definite heart.	Ventral heart.
Brain eye.	None.	In most cases transitory.	None.	Brain eye.
Segmentation.	Three primitive segments.	Very indistinct.	Well marked in musculature, nephridia, etc.	Well marked, especially in embryos.

General Classification of Phylum Chordata

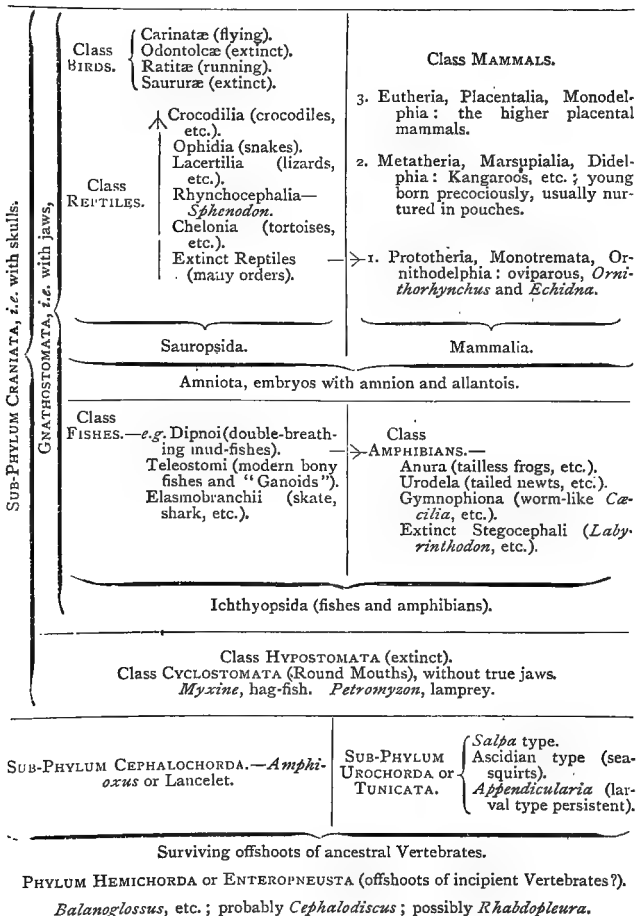

Ancestry of Vertebrates

It is not at present possible to trace the path along which Vertebrates have evolved, though our faith in the doctrine of evolution—as a modal

theory of origins—leads us to believe that Vertebrates arose from forms which were not Vertebrates.

But even when we recognise that *Amphioxus* is a Vertebrate very simple in its *general* features, and that the Tunicata, especially in their youth, are Vertebrates, we must admit that these are specialised not very primitive types.

The Enteropneusta carry us a little farther back. For, while many of their alleged Vertebrate characteristics are debatable, one cannot gainsay, for instance, the possession of pharyngeal gill-slits. But the affinities of the Enteropneusta with Invertebrate types are quite obscure.

We have, in fact, to acknowledge that the pedigree of Vertebrates remains unknown, though alleged affinities have been discovered among Annelids, Nemerteans, Arachnids, Crustaceans, Palæostraca, etc. There is almost no great class of Invertebrate Metazoa whose characters have not been ingeniously interpreted so as to reveal affinities with Vertebrates. It will be enough to select one illustration.

Annelid affinities.—Dohrn, Semper, Beard, and others maintain that Annelids have affinities with Vertebrates.

- (1) Both Annelids and Vertebrates are segmented animals.
- (2) The segmental nephridia of Annelids correspond to the primitive kidney-tubes of a Vertebrate embryo.
- (3) The ventral nerve-cord of Annelids may be compared (in altered position) to the dorsal nerve-cord of Vertebrates. Both cords are bilateral, and it is possible that the tubular character of the spinal cord and brain is the necessary result of its mode of development, and without much morphological importance.
- (4) Segmentally arranged ganglia about the appendages of some Chætopod worms may correspond to the branchial and lateral sense organs of Ichthyopsida, and the ganglia associated with some of the nerves from the brain.
- (5) The formation of the oral part of the pituitary body is suggestive of the way in which the mouth of Annelids is sometimes formed. Perhaps the pituitary body represents an old lost mouth and its ancient innervation.

To minor points, such as the red blood and well-developed body cavity of many Annelids little importance can be attached.

STRUCTURE AND DEVELOPMENT OF VERTEBRATES

Having separately discussed the Hemichorda, Urochorda, and Cephalochorda, we propose in this chapter to discuss the general structure of Craniata and the development of some of the important organs.

Skin.—This forms a continuous covering over the surface of the body, serves as a protection to the underlying tissues, in some instances retains its primitive respiratory sig-

nificance, and is frequently concerned in the excretion of waste and the regulation of the body temperature. As one or other of its many functions predominates, there are corresponding structural modifications. One function which we find oftenest emphasised, at the expense of the others, is that of protection, and yet the extinct *Glyptodon*, the sluggish *Chelonia*, the decadent "Ganoïds," seem to indicate that this, in itself, or in its correlated variations, is not conducive to the continuance of the species.

The skin includes—

(a) The epidermis, usually in several layers, the outer, "horny" stratum corneum, the inner actively growing stratum Malpighii, or mucosum; both derived from the ectoderm or epiblast of the embryo.

(b) The dermis, cutis, corium, or under-skin, derived from the mesoderm or mesoblast of the embryo.

From the epidermis are derived feathers, hairs, and some kinds of scales. The dermis, as is natural when we consider its origin from the mesoblast (mesenchyme) or vascular layer, assists in nourishing these epidermic structures. In the case of feathers and the scales of Reptiles, the dermic papilla is of primary importance, but in the case of hairs it arises late and is always small. From the dermis are derived the bony shields of armadillos, and a few related mammals, the bony scutes of crocodiles and some other reptiles, and the scales of most bony fishes. This again is readily explained by the fact that the mesoblast is also the skeletal layer of the embryo. The ordinary teeth of Vertebrates, as well as the superficial or skin-teeth of gristly fishes, are largely formed from the dermis, but are usually covered by a thin coating of ectodermic enamel.

The mesoderm is divided in the embryo into (1) a series of dorsal segments or somites, with a transient cavity (the myocœl), and (2) an unsegmented ventral portion or "lateral plate." The dorsal part

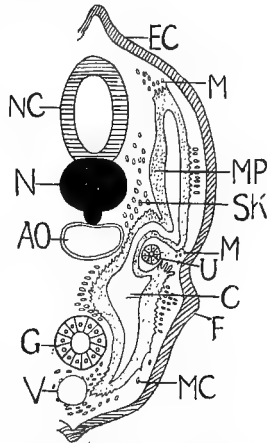

FIG. 255.—Section through Elasmobranch embryo.—Ziegler.

NC., nerve cord; N., notochord; AO., aorta; G., gut; V., sub-intestinal vein; MC., a free mesenchyme cell; F., beginning of a paired fin; C., coelom; U., segmental duct; M.-M., myotome; MP., muscle plate; SK., skeletogenous cells around notochord; EC., ectoderm.

gives rise to the myotomes forming all the segmented muscles, to out-growths into the limbs, to the cutis or dermis, to a sheath round the notochord, etc. The ventral part gives rise to the splanchnic or visceral muscles (usually unstriped), to the cœlomic epithelium, etc.

Skeletal system.—Apart from the exoskeleton of skin-teeth, scutes, shields, etc., the skeleton consists of the following parts:—

- | | | |
|-------------------------------|---|---|
| (a) Axial
Skeleton. | { | The skull and its associated "arches."
The backbone and associated ribs.
(The notochord is transitory except
in the simplest Vertebrates.) |
| (b) Appendicular
Skeleton. | } | Fore limbs, and pectoral girdle.
Hind limbs, and pelvic girdle. |

Skull.—The notochord grows forward anteriorly as far as that region of the brain known as the optic thalami. Around notochord and brain the mesenchyme forms a continuous sheath, which is the foundation of the skull.

As in the case of the notochordal sheath of the trunk region, so also here cartilage is formed in the primitive membranous cranium. The first cartilages to appear are the two parachordals, which lie on the lower surface of the head at the sides of the notochord, and the two trabeculæ lying in front. The parachordals grow round and above the notochord, producing the basilar plate, while the trabeculæ unite in front to form the ethmoid plate. The continuance of the process of cartilage formation, together with the addition of cartilaginous nasal capsules in front and auditory capsules behind, completes the formation of the primitive cartilaginous brain-box or chondrocranium of the lower Vertebrates.

Also connected with the head region, and of great importance, are the visceral or gill arches which loop around the pharynx on either side, and separate the primitive gill-clefts. At the time when cartilage begins to be formed in the membranous cranium, the arches also become chondrified, and at the same time divided into segments.

Of these arches there are never more than nine. The most anterior is the *mandibular* arch which bounds the mouth, the second the *hyoid*; these two are of great importance in the development of the skull. The others, in Fishes and at least young Amphibians, bound open gill-

slits and support the pharynx; above Amphibians, they are less completely developed.

In the Elasmobranch fishes, the mandibular and hyoid arches do not form any direct part of the cartilaginous brain-case; but in the Teleosteans and thence onwards, the cartilages or bones arising in connection with the mandibular and upper part of the hyoid arches contribute directly to the formation of the skull. The hyoid proper, or lower part of the hyoid arch, forms the skeleton supporting the tongue. Cartilages arising in the lower part of the third visceral arch assist in the formation of the hyoid bones of the higher Vertebrates, and parts of two other arches appear to help in forming the laryngeal skeleton of Mammals.

The mandibular arch in Elasmobranchs and frogs divides into a lower portion—Meckel's cartilage—which forms the lower jaw or its basis, while from the upper portion a bud grows forward, the palato-pterygoquadrate cartilage, which forms the upper jaw in shark and skate, and has a closer union with the skull in the frog. In higher Vertebrates the lower portion of the mandibular always forms the basis of the lower jaw, a quadrate element is segmented off from the upper part, but the palato-pterygoid part seems to arise more independently. The hyoid arch also divides into a lower portion, the hyoid proper, and an upper portion, the hyo-mandibular, which may connect the jaws with the skull, or from Amphibians onwards may be more remarkably displaced and modified as a columella or stapes connected with the ear.

Returning now to the brain-box itself, we must notice another complication,—the development of “membrane” bones. If we examine the skull of the skate, we find that the brain lies within a cartilaginous capsule; but this is not entirely closed, spaces (the fontanelles) being left in the roof, which during life are covered only by the tough skin with its numerous “dermal denticles.” In the sturgeon, again, the small skin-teeth are replaced by stout bony plates covering over the cartilaginous capsule. From such superficial bony plates it is supposed that the “membrane” bones, or ossifications in membrane, which form so important an element in the skull of the higher Vertebrate, have originated.

In some bony fishes, notably the salmon, we find the brain enclosed in a double capsule. Inside there is a cartilaginous brain-case in which what are called centres of ossification have appeared, and upon this a layer of membrane bones is placed, which can be readily removed without injury to the cartilage beneath. In general, however, we must recognise that, with the appearance of membrane bones, two changes tend to occur,—first, the cartilaginous cranium tends to be reduced and to exhibit considerable openings; second, in the remaining cartilage centres of ossification appear, and we thus have “cartilage” bones

formed. Further, in spite of the developmental differences, the membrane and cartilage bones become closely united to one another, or even fused, and there is thus formed "a firm, closed, bony receptacle of mixed origin," as exemplified by the skull of any of the higher Vertebrates.

We may thus say that in the evolution of the skull there is first a cartilaginous capsule, that this becomes invested to a greater or less extent by dermal ossifications, and that finally the dermal bones lose their superficial position, and, fusing with the ossified remainder of the cartilaginous cranium, form a complete bony capsule. In Cyclostomes and Elasmobranchs the brain-box is wholly cartilaginous; above Elasmobranchs the cartilage is more or less thoroughly replaced or covered by bones. In the individual development there is a parallel progress.

The segmentation of the head, in contradistinction to the unsegmented skull, is expressed, although indistinctly, by the muscle segments and by the nerves supplying these, perhaps also by the lateral sense organs, the ganglia, and the arches.

There are three pro-otic head-segments (pre-mandibular, mandibular, and hyoid), which correspond to the orbital region, their walls forming the six eye-muscles. Behind the auditory capsule there are ten or eleven head-segments.

Vertebral column.—A dorsal skeletal axis is characteristic of Vertebrata, and its usefulness is evident. It gives coherent strength to the body; it is usually associated very closely with a skull, with limb girdles, and with ribs; it affords stable insertion to muscles; its dorsal parts usually form a protective arch around the spinal cord.

To understand this skeletal axis, we must distinguish clearly between the notochord and the backbone.

The notochord is the first skeletal structure to appear in the embryo. It arises as an axial differentiation of endoderm along the dorsal wall of the embryonic gut or archenteron beneath the nerve-cord. The backbone, which in most Vertebrates replaces the notochord, has a mesoblastic origin. It develops as the substitute of the notochord, and not from it, but from a skeletogenous sheath surrounding it.

According to Kleinenberg, the notochord supplies the necessary growth stimulus for the rise of its substitute, the backbone.

A vertebra generally consists of several more or less independent parts: the substantial centrum; the neural arches which form a tube for the spinal cord, and are crowned by a neural spine; the transverse processes which project laterally, and the articular processes.

The ribs which support the body wall usually articulate with the transverse processes, or with the transverse processes and centra.

Amphibians are the first to show a breast-bone or sternum. It arises from two cartilaginous rods in a tendinous region on the ventral wall of the thorax. The sternum of some Reptiles, and of all Birds and Mammals, arises from a cartilaginous tract uniting the ventral ends of a number of ribs.

Limbs and girdles.—The pectoral girdle consists of a dorsal scapula, a ventral coracoid, and a forward growing membrane-bone, the clavicle or collar-bone.

According to Broom, frogs and some primitive Reptiles show a coracoid and a pre-coracoid; lizards and birds only a pre-coracoid; the Monotremes a coracoid and a pre-coracoid; other mammals a coracoid only.

The pelvic or hip girdle consists of a dorsal iliac portion, a ventral posterior ischiac portion, with the articulation for the limb between them, and of a ventral, usually anterior, pubic portion.

The fore limb—from Amphibians onwards—consists of a humerus articulating with the girdle, a lower arm composed of radius and ulna lying side by side, a wrist or carpus of several elements, a “hand” with metacarpal bones in the “palm,” and with fingers composed of several phalanges.

The hind limb—from Amphibians onwards—consists of a femur articulating with the girdle, a lower leg composed of a tibia and fibula lying side by side, an “ankle” region or tarsus of several elements, a foot with metatarsal bones in the “sole,” and with toes composed of several phalanges.

In Fishes the limbs are fins, *i.e.* without digits.

Distinct from the other bones are a few little sesamoids of occasional occurrence, *e.g.* the knee-pan or patella. They develop in connection with the tendons of muscles.

Nervous system.—This includes—(a) the central nervous system, consisting of brain and spinal cord; (b) the peri-

pheral system, consisting of spinal and cranial nerves; and (c) the sympathetic nervous system.

The central nervous system first appears as a superficial groove along the mid-dorsal line of the embryo. The sides of this ectodermic groove meet, and, uniting, convert the medullary groove into the medullary canal. The greater

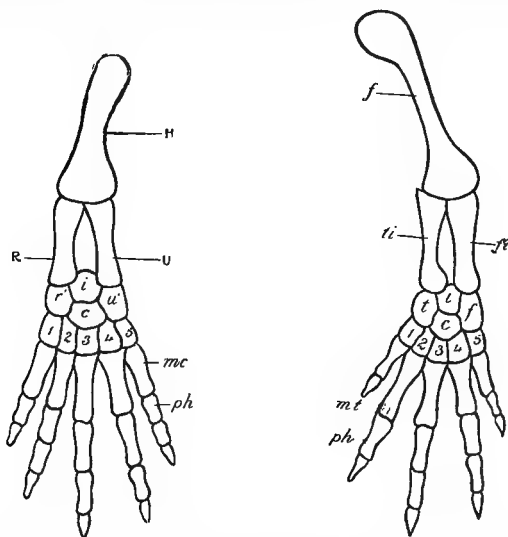

FIGS. 256 and 257.—Ideal fore and hind limb.—After Gegenbaur.

H., Humerus; R., radius; U., ulna; *r.*, radiale; *u.*, ulnare; *i.*, intermedium; *c.*, centrale; 1-5, carpalia bearing the corresponding digits with metacarpals (*mc.*) and phalanges (*ph.*).

f., Femur; *ti.*, tibia; *ft.*, fibula; *i.*, intermedium; *t.*, tibiale (*astragalus*); *f.*, fibulare (*os calcis*); *c.*, centrale; 1-5, tarsalia bearing the corresponding digits with metatarsals (*mt.*) and phalanges (*ph.*).

part of this canal forms the spinal cord; the anterior portion of it is specialised as the brain. There is at first a posterior connection between the neural canal and the primitive gut of the embryo; when this is lost the cavity of the neural tube still persists as a little ciliated canal in the centre of the cord, and as the internal cavity of the brain.

Brain.—At an early stage, even before the closing-in

process is completed, certain portions of the anterior region of the medullary canal grow more rapidly than others, and form the three primary brain vesicles. By further processes of growth and constriction, these three form the five regions of the adult brain.

When first formed the brain vesicles lie in a straight line, but as a consequence, probably, of their rapid and unequal growth, this condition is soon lost, and a marked cranial flexure is produced. In the lower forms, *e.g.* Cyclostomata, the flexure is slight, and is corrected later, but in the higher types it is very distinct, and causes the marked overlapping of parts so obvious in the adult.

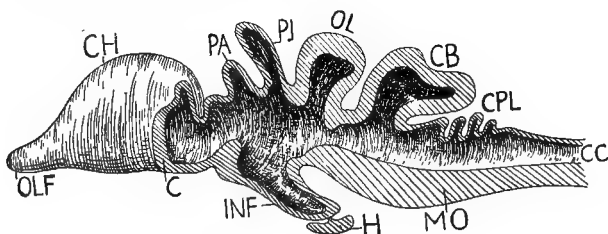

FIG. 258.—Partial section of a Vertebrate brain (diagrammatic).

OLF., Olfactory lobe; *CH.*, cerebral hemispheres; *C.*, wall of cerebrum cut to show ventricle, behind this the figure is that of a median section; *PA.*, parietal organ arising from thalamencephalon; *PI.*, pineal organ; *INF.*, infundibulum descending from thalamencephalon; *H.*, hypophysis; *OL.*, optic lobes; *CB.*, cerebellum; *CPL.*, choroid plexus on roof of fourth ventricle; *MO.*, floor of the medulla oblongata; *CC.*, central canal of spinal cord.

We must now follow the metamorphosis of the primary brain vesicles.

The first vesicle gives rise anteriorly to the cerebral hemispheres, while the remainder forms the region of the optic thalami or thalamencephalon.

The cerebral hemispheres (prosencephalon or fore-brain) are exceedingly important. They predominate more and more as we ascend in the scale of Vertebrates, and become more and more the seat of intelligence. Except in a few cases, the prosencephalon is divided into two parts—the cerebral hemispheres—which contain cavities known as the lateral ventricles. The two hemispheres are united by

bridges or commissures, which have considerable classificatory importance. With the anterior region of the hemispheres olfactory lobes are associated.

In Cyclostomata, "Ganoids," and Teleosteans, the fore-brain has no nervous roof, but is covered by an epithelial pallium which resembles what is called the choroid plexus of the third ventricle in higher Vertebrates. This choroid plexus is a thin epithelium, with blood vessels in it. But in Elasmobranchs, Dipnoi, and Amphibians the basal parts of the fore-brain have grown upwards to form a nervous roof, and this persists in higher Vertebrates.

The optic thalami (thalamencephalon or tween-brain) form the second region of the adult brain. Hence arise the optic outgrowths, which form the optic nerves and some of the most essential parts of the eyes. The original cavity persists as the third ventricle of the brain; the thin roof gives off the dorsal pineal outgrowth or epiphysis, and, uniting with the pia mater, or vascular brain membrane, forms a choroid plexus; the lateral walls become much thickened (optic thalami); the thin floor gives off a slight ventral evagination, or infundibulum, which bears the enigmatical pituitary body or hypophysis. The infundibulum also bears in most Teleosts a peculiar posterior saccus vasculosus, which seems to be a sense organ. It is not developed except in Fishes.

The pituitary body.—This is derived partly from a downgrowth from the thalamencephalon and partly from an upgrowth from the roof of the mouth. The two parts unite to form a complex little organ, whose morphological nature is very puzzling. It produces an internal secretion of importance, and a pathological state of the organ is associated in man with certain diseases, *e.g.* *acromegaly*.

The pineal body.—The dorsal upgrowth from the roof of the thalamencephalon is represented, though to a varying extent, in all Vertebrates. It consists of two parts, a pineal organ or epiphysis proper, and a parietal organ, which arises as a rule from the epiphysis but may have an independent origin in front of it. It is probable that they were originally right and left members of a pair. The parietal organ may become atrophied, but in some cases, especially in Reptiles, it is terminally differentiated into a little body known as the pineal body. This was entirely an enigma until De Graaf discovered its eye-like structure in *Anguis*, and Baldwin Spencer securely confirmed this in the New Zealand "lizard" (*Sphenodon*), where the pineal body shows distinct traces of a retina. In *Petromyzon* both the epiphysis

and the parietal organ show an eye-like structure, most marked in the case of the epiphysis.

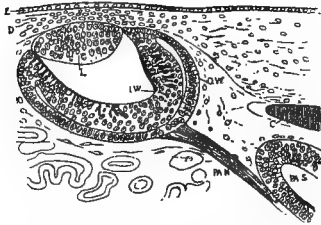

FIG. 259.—Vertical section of the pineal eye in an embryo of *Sphenodon*.—After Dendy.

E., Epidermis; *D.*, dermis; *L.*, lens; *I.W.*, inner wall of the eye; *O.W.*, outer wall of the eye; *P.A.N.*, parietal nerve; *P.A.S.*, parietal stalk; *C.*, cartilage.

of the parietal organ) receives a nerve from a "parietal centre" near the base, but independent of the epiphysis; this nerve is transitory in *Anguis*, more or less persistent in *Iguana*. Above Reptiles the pineal stalk is relatively short, and its terminal portion is glandular. Among mammals the epiphysis is absent in the dugong and some Cetaceans; the pineal body is absent in *Dasypus* and the dolphin.

The significance of the pineal body is uncertain. According to some, its primitive function is that of an unpaired, median, upward-looking eye—a function retained only in the Reptiles mentioned above, the organ having elsewhere undergone (independent) degeneration. It may be, however, that the optic function is not primitive, but the result of a secondary transformation.

In Elasmobranchs the pineal process (epiphysis) is very long, and, perforating the skull, terminates below the skin in a closed vesicle. In the young frog it also comes to the surface above the skull, but degenerates in adolescence. In *Sphenodon* the stalk passes through the skull by the "parietal foramen," so that the "eye" itself, developed from the parietal organ, lies close beneath the skin, the scales of which in this region are specialised and transparent. In *Iguana*, *Anguis*, *Lacerta*, etc., the epiphysis loses connection with the "eye" portion; and it is also to be noticed that in *Anguis* and *Iguana* the pineal body (on the end

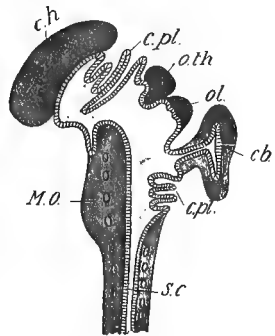

FIG. 260.—Diagram of the parts of the brain in Vertebrates.—After Gaskell.

c.h., Cerebral hemispheres; *c.pl.*, choroid plexus; *o.th.*, optic thalami; *o.l.*, optic lobes; *cb.*, cerebellum; *c.pl.*, choroid plexus; *M.O.*, medulla oblongata; *S.C.*, spinal cord.

The second primary vesicle of the brain forms the third region, that of the optic lobes (mesencephalon or mid-brain) in the adult brain. The floor and lateral walls form the thickened *crura cerebri*; the roof becomes the two optic lobes, which are hollow in almost all Vertebrates. In Mammals a transverse furrow divides each optic lobe into two (*corpora quadrigemina*). The cavity of the vesicle becomes much contracted, and forms the narrow iter or aqueduct of Sylvius, a canal connecting the third ventricle with the fourth.

The third primary vesicle gives rise to the metencephalon, or hind-brain, or region of the cerebellum, and to the myelencephalon, or after-brain, or region of the medulla oblongata.

In the metencephalon the roof develops greatly, and gives rise to the cerebellum, which often has lateral lobes, and overlaps the next region. In the higher forms the floor forms a strong band of transverse fibres—the pons Varolii.

From the region of the medulla oblongata most of the cranial nerves are given off. Here the roof, partly overlapped by the cerebellum, degenerates, becoming thin and epithelial, the cavity—called the fourth ventricle—is continuous with the canal of the spinal cord.

Summary

- | | | |
|---------------------------|---|---|
| First Embryonic Vesicle. | { | (1) Cerebral hemispheres, prosencephalon, or fore-brain. Note commissures, olfactory lobes and nerves, and first and second ventricles. |
| | | (2) Optic thalami, thalamencephalon, or tween-brain. Note—(a) optic, (b) pineal, (c) pituitary outgrowths, and the third ventricle. |
| Median Embryonic Vesicle. | { | (3) Optic lobes, mesencephalon, or mid-brain. Note <i>crura cerebri</i> , and the aqueduct of Sylvius. |
| | | (4) Cerebellum, metencephalon, or hind-brain. Note pons Varolii. |
| Third Embryonic Vesicle. | { | (5) Medulla oblongata, myelencephalon, or after-brain. Note rudimentary roof, fourth ventricle, and origin of most of the cranial nerves. |

Enswathing the brain and spinal cord, and following its irregularities, is a delicate membrane—the pia mater—rich in blood vessels, which supply the nervous system. Outside this, in higher Vertebrates, there is another membrane—the arachnoid—which does not follow the minor irregularities of the brain so carefully as does the pia mater. Thirdly, a firm membrane—the dura mater—lines the brain-case, and is continued down the spinal canal. In lower Vertebrates the dura mater is double throughout; in higher Vertebrates it is double only in the region of the spinal cord, where the outer part lines the bony tunnel, while the inner ensheathes the cord itself. In Fishes the brain-case is much larger than the brain, and a large lymph space lies between the dura and the pia mater.

An understanding of the relations of the different regions will be facilitated by a study of the following table, which Dr. Gadow gives in his great work on Birds in Bronn's Thierreich:—

REGION.	FLOOR.	SIDES.	ROOF.	CAVITY.
Spinal cord.	Anterior grey and white commissure.	White and grey substance.	Posterior commissure.	Central canal.
Myelencephalon.	Medulla oblongata.		Epithelium of choroid plexus.	Posterior part of fourth ventricle.
Metencephalon.	Commissural part.	Pedunculi of crura cerebri.	Cerebellum.	Anterior part of fourth ventricle.
Mesencephalon.	Crura cerebri.	Cortex of optic lobes.	Anterior commissure, velum of Sylvius.	Aqueduct of Sylvius and lateral extensions.
Thalamencephalon.	Infundibulum, hypophysis, chiasma.	Inner part of optic lobes and optic thalami.	Epiphysis and epithelium of choroid plexus. Corpus callosum. Anterior commissure.	Third ventricle.
Prosencephalon.	Corpus striatum. Lamina terminalis. Olfactory lobes.	Cerebral hemispheres.		Lateral ventricles.

Spinal cord.—After the formation of the brain vesicles, the remainder of the medullary canal forms the spinal cord.

The canal is for a time continuous posteriorly with the food canal beneath, so that a \supset -shaped tube results. The connection between them is called the neurenteric canal (Fig. 254, *ne.c.*), and though it is only temporary, its frequent occurrence is of much interest.

The wall of the medullary canal becomes very much thickened, the roof and floor grow less rapidly, and thus the cord is marked by ventral and dorsal longitudinal furrows. At the same time, the canal itself is constricted, and persists in the fully-formed structure only as a minute canal lined by ciliated epithelium, and continuous with the cavity of the brain.

In the cord it is usually easy to distinguish an external region of white matter, composed of medullated nerve-fibres, and an internal region of grey matter, containing ganglionic cells and non-medullated fibres.

The arrangement of the grey matter, together with the longitudinal fissures, give the cord a distinct bilateral symmetry, which is sometimes obvious at a very early stage.

The brain substance is also composed of grey and white matter, but there, at any rate in higher forms, the arrangement is very complicated.

Cranial nerves.—The origin and distribution of the cranial nerves may be summarised as follows:—

NAME.	ORIGIN.	DISTRIBUTION.	NOTES.
1. Olfactory. <i>s.*</i>	Front of fore-brain.	Olfactory organ.	Quite <i>per se</i> .
2. Optic. <i>s.</i>	Optic thalami.	Eye.	Quite <i>per se</i> . They cross before they enter the brain, and generally unite at their intersection.
3. Oculomotor or ciliary. <i>m.*</i>	Floor of mid brain.	All the muscles of the eye but two.	A ciliary ganglion at roots.
4. Pathetic or trochlear. <i>m.</i>	From posterior part of optic lobes.	Superior oblique muscle of the eye.	Perhaps belongs to 5, as a ventral root.
5. Trigeminal. <i>s. and m.</i>	Medulla oblongata.	(1) Ophthalmic to snout. <i>s.</i>	Gasserian ganglion at roots.
		(2) Maxillary to the upper jaw, etc. <i>s.</i>	The ophthalmicus profundus, often included with 5, is probably the dorsal component of 3.
		(3) Mandibular to lower jaw, lips, etc. <i>m. and s.</i>	Perhaps belongs to 7, as a ventral branch.
6. Abducens. <i>m.</i>	"	External rectus of eye.	
7. Facial. <i>s. and m.</i>	"	(1) Hyoidean and spiracular. (2) Palatine. (3) Buccal, facial, and auditory.	
8. Auditory. <i>s.</i>	"	Ear.	Ganglia at the roots of 7 and 8.
9. Glossopharyngeal. <i>s. and m.</i>	"	First gill arch.	
10. Vagus or Pneumogastric. <i>s. and m.</i>	"	Posterior gills and arches, lungs, heart, gut, and body generally.	Apparently a complex, including the elements of four or five nerves.

In higher Vertebrates there are two others, the spinal accessory (11) and the hypoglossal (12).

The fourth or pathetic nerve is peculiar among motor nerves in that it appears to arise from the extreme dorsal summit of the brain, between the mid- and hind-brain, from the region known as the "valve of Vieussens." In Fishes the seventh nerve is mainly a nerve of special sense; in higher Vertebrates it has lost most of its sensory branches, and become chiefly motor.

* The letter *s.* is a contraction for sensory or afferent, *i.e.* transmitting impulse from a sensitive area to the centre; and *m.* is a contraction for motor or efferent, *i.e.* transmitting impulses from the centre to the body.

There is much uncertainty in regard to the morphological value of the various cranial nerves, but the following conclusions may be stated:—

(1) Like the spinal nerves, the cranial nerves are primarily segmental, and there are probably about seven of them,—three pro-otic and four metotic. The olfactory and optic nerves are quite by themselves and not segmental.

(2) Like the spinal nerves, the cranial nerves have primarily two roots,—a dorsal and a ventral, but the ventral roots do not join the

dorsals, which have a more superficial course and include numerous motor fibres (correlated with the great development of visceral musculature in the head).

(3) The pre-mandibular primitive segment (I.) was probably supplied by the oculomotor (ventral) and the ophthalmicus profundus (dorsal).

The mandibular primitive segment (II.) was probably supplied by the pathetic (ventral) and the trigeminal (dorsal).

The hyoid primitive segment (III.) was probably supplied by the abducens (ventral) and the facial (dorsal). The auditory, glosso-pharyngeal, and vagus nerves have no ventral roots.

Spinal nerves.—Each spinal nerve has two roots—a dorsal, posterior, or sensory, and a ventral, anterior, or motor. These arise separately and independently, but

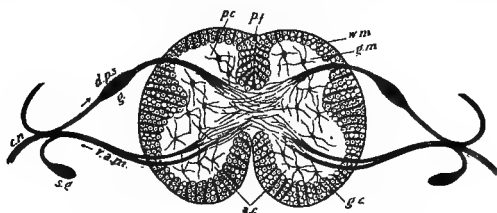

FIG. 261.—Diagrammatic section of spinal cord.

p.f., Posterior fissure; *p.c.*, posterior column of white matter; *d.p.s.*, dorsal, posterior, sensory or afferent root; *g.*, ganglion; *v.a.m.*, ventral, anterior, motor or efferent root; *c.n.*, compound spinal nerve with branches; *s.g.*, sympathetic ganglion; *a.c.*, anterior column—the anterior fissure is exaggerated; *g.c.*, ganglion cells; *g.m.*, grey matter; *w.m.*, white matter.

combine in the vicinity of the cord to form a single nerve. The dorsal root exhibits at an early period a large ganglionic swelling—the spinal ganglion; the ventral root is apparently non-ganglionated. Moreover, the dorsal root has typically a single origin (as in the cranial nerves), while that of the ventral root is often multiple.

The dorsal roots are outgrowths of a continuous ridge or crest along the median dorsal line of the cord. As the cord grows the nerve roots of each side become separated. They shift sideways and downwards to the sides of the cord. The ventral roots are later in arising; they spring as outgrowths from the latero-ventral angle of the cord.

According to most authorities, the sympathetic ganglia are offshoots from the same rudiment as that from which the dorsal ganglia arise.

They are usually connected in a chain, which is linked anteriorly to cranial nerves. They are also connected by fine fibres with the ventral roots. They give off nerves to blood vessels and viscera.

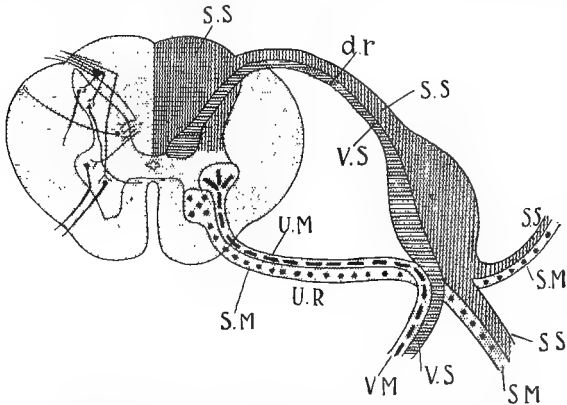

FIG. 262.—Diagram of spinal cord of man, thoracic region.—After Johnston.

S.S., Somatic sensory; *V.S.*, visceral sensory; *S.M.*, somatic motor; *V.M.* and *U.M.*, visceral motor; *d.r.*, dorsal root; *U.R.*, ventral root.

Sense organs.—The ectoderm or epiblast gives origin to the essential parts of the sense organs. The Vertebrate eye is formed in great part as an outgrowth from the brain, but as the brain is itself an involution of epiblast, the eye may be also referred to external nerve-cells.

Branchial sense organs.—In many Fishes and Amphibians there are lateral sense organs which form the “lateral lines,” while others lie in the head, and were in all likelihood primitively connected with gill-clefts. In Sauropsida and Mammals these branchial sense organs are no longer distinct as such.

The nose.—It is possible that the sensory pits of skin which form the nasal sacs were originally two branchial sense organs. They are lined by epithelium in great part sensory, and innervated by the olfactory nerves. In Fishes the nasal sacs remain blind posteriorly, but there is a peculiar condition in Dipnoi, where the grooves from

anterior nares to mouth are arched over and open posteriorly into the front of the mouth. In Amphibians, and in all the higher Vertebrates, the nasal chambers open posteriorly into the mouth, and serve for the entrance of air. The peculiar nostril of hag-fish and lamprey is referred to in the chapter on Cyclostomata.

The ear in Invertebrates develops as a simple invagination of the ectoderm, forming a little sac, which may become entirely detached from the epidermis, or may retain its primitive connection; so in Vertebrates, at an early stage, an insinking forms the auditory pit. In some Fishes (*Serranus*, salmon) and Amphibians a common ectodermic thickening seems to form the rudiment from which the ear, the lateral line, and a pre-auditory sensory patch are derived. The auditory sac sinks farther in, and the originally wide opening to the exterior becomes a long narrow tube. In Elasmobranchs, which exhibit many primitive features, this condition is usually retained in the adult; in other Vertebrates the tube loses its connection with the exterior, and becomes a blind prolongation of the inner ear—the aqueductus vestibuli, or ductus endolymphaticus. In Anura the ductus endolymphaticus gives rise to a long sac dorsal to the spinal cord giving off outgrowths in which the “calcareous bodies” lie.

The auditory vesicle, at first merely a simple sac, soon becomes very complicated. It divides into two chambers, the larger utriculus and the smaller sacculus. From the utriculus three semicircular canals are given off, except in the lamprey and hag, which have two and one respectively. From the sacculus an outgrowth called the cochlea or lagena originates; it is little more than a small hollow knob in Fishes and Amphibians, but becomes large and important in Sauropsida and Mammals.

As this differentiation of the parts of the internal ear takes place, the lining epithelium also becomes differentiated into flattened covering cells and sensory auditory cells. The auditory cells are arranged in patches to which branches of the auditory nerve are distributed. With these sensory patches calcareous concretions (otoliths) are associated, except in the cochlea of Mammals.

The fact that lime salts are often deposited in the skin, and that the ear-sac arises as an insinking of epiblast, may perhaps shed some light on the origin of otoliths.

The parts which we have so far considered constitute together the membranous labyrinth of the ear. Round about them the mesoblast (mesenchyme) forms a two-layered envelope. Its inner layer disintegrates to produce a fluid, the perilymph, which bathes the whole outer surface of the membranous labyrinth. Its outer layer forms a firm case, the cartilaginous or bony labyrinth, surrounding the internal ear. The membranous labyrinth itself contains another fluid, the endolymph.

With regard to the function of the parts of the ear, the semicircular canals are believed by many to be concerned with the appreciation of a

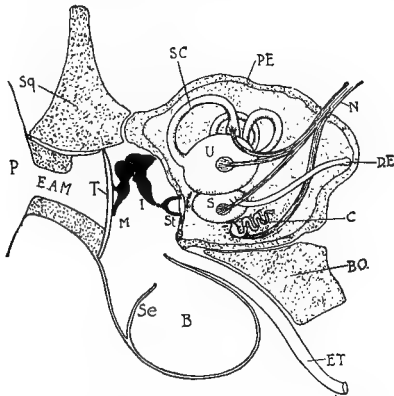

FIG. 263.—Diagram showing the ear and related parts in a young cat.

P., Pinna; *Sq.*, squamosal; *E.A.M.*, external auditory meatus; *T.*, tympanum; *M.*, malleus; *I.*, incus; *St.*, stapes abutting on foramen ovale; *B.*, bulla of tympanic bone; *Se.*, a septum in the bulla; *E.T.*, eustachian tube leading from the tympanic cavity to the back of the mouth; *B.O.*, basi-occipital; *C.*, cochlea; *S.*, sacculus; *U.*, utricle; *D.E.*, ductus endolymphaticus; *N.*, auditory nerve; *S.C.*, semicircular canal; *P.E.*, periotic bone.

change in the direction or velocity of movement. How far the ears of Invertebrates (*e.g.* Crustacea and Mollusca) are adapted for any function except this, is still doubtful, and we can hardly see that any other would be of much use to purely aquatic animals. It seems likely at any rate that the primitive function of the ear was the perception of vibrations, and that from this both the sense of hearing and the sense of equilibration have been differentiated.

It is in accordance with the facts mentioned above that we rarely find in Fishes any special path by which impressions of sound may travel from the external world to the ear. In Amphibians and higher Vertebrates, however, the ear has sunk farther into the recesses of the skull, and a special path for the sound is present. In Elasmobranchs,

the spiracle, or first gill-cleft, is situated in the vicinity of the ear; in higher forms, according to many authors, this first gill-cleft is metamorphosed into the conducting apparatus of the ear. In development, a depression beneath the closed gill-cleft unites with an outgrowth from the pharynx, and thus forms the tympanic cavity, which communicates with the back of the mouth by the Eustachian tube. The tympanic cavity is closed externally by the drum or tympanum, which may be flush with the surface, as in the frog, or may lie at the end of a narrow passage, which in many Mammals is furnished externally with a projection or pinna. In Amphibia and Sauropsida the tympanic cavity is traversed by a bony rod—the columella, which extends from the drum to the fenestra ovalis, a little aperture in the wall of the bony labyrinth. In Mammals this is replaced by a chain of three ossicles, an outermost malleus, a median incus, an internal stapes.

The homologies of these ossicles are still uncertain. One interpretation has been stated on p. 480; the following is Hertwig's:—

Malleus = Articular + angular elements of Meckel's cartilage.

Incus = Palato-quadrate of lower Vertebrates.

Stapes of Mammals has a double origin, being formed from the upper part of hyoid arch + an ossification from the wall of the ear capsule = (wholly?) columella of Birds, Reptiles, and Amphibians.

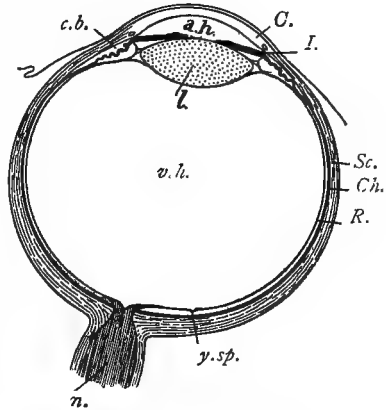

FIG. 264.—Diagram of the eye.

C., Cornea; a.h., aqueous humour; c.b., ciliary body; L., lens; I., iris; Sc., sclerotic; Ch., choroid; R., retina; v.h., vitreous humour; y.sp., yellow spot; n., optic nerve.

The eye.—There is no eye in *Amphioxus*, it is rarely more than

larval in Tunicates, it is rudimentary in *Myxine* and in the young lamprey. In higher forms the eye is always present, though occasionally degenerate, e.g. in fishes from caves or from the deep sea. It is hidden under the skin in *Proteus*, an amphibian cave-dweller, and in the subterranean amphibians like *Cæcilia*, very small in a few snakes and lizards, and its nerves are abortive in the mole.

The adult eye is more or less globular, and its walls consist of several distinct layers. The innermost layer bounding the posterior part of the globe is the sensitive retina, innervated by fine branches from the optic nerve. It may be compared to the nervous matter of the brain, from which, indeed, it arises. Outside of the retina is a pigmented epithelium, and outside of this a vascular membrane;

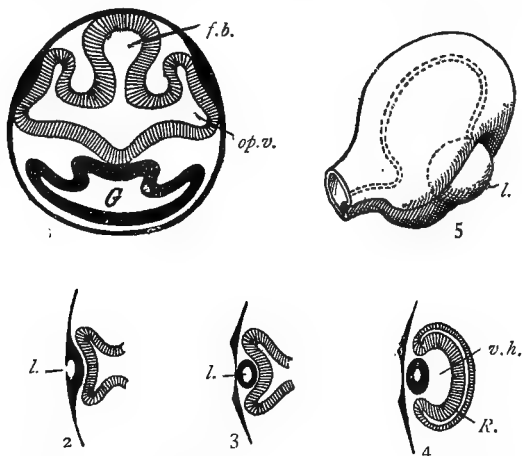

FIG. 265.—Development of the eye.—After Balfour and Hertwig.

1. Section through first embryonic vesicle, showing outgrowth of optic vesicles (*op.v.*) to meet the skin; *f.b.*, thalamencephalon; *G.*, the gut.
- 2-4. Sections illustrating the formation of the lens (*L.*) from the skin, and the modification of the optic vesicle into an optic cup; *R.*, retina; *v.h.*, vitreous humour.
5. External aspect of embryonic eye; *L.*, lens.

together these are often called the choroid. The vascular part may be compared to the pia mater covering the brain, and like it is derived from mesoblast. Outside of the choroid is a protective layer or sclerotic, comparable to, and continuous with, the dura mater covering the brain, and also mesoblastic in origin. Occupying the front of the globe is the crystalline lens, a clear ball derived directly

from the skin. It is fringed in front by a pigmented and muscular ring—the iris, which is for the most part a continuation of the choroid. The space enclosed by the iris in front of the lens is called the pupil. Protecting and closing the front of the eye is the firm cornea continuous with the sclerotic, and covered externally by the conjunctiva—a delicate epithelium continuous with the epidermis. Between the cornea and the iris is a lymph space containing aqueous humour, while the inner chamber behind the lens contains a clear jelly—the vitreous humour. The lens is moored by “ciliary processes” of the choroid, and its shape is alterable by the action of accommodating ciliary muscles arranged in a circle at the junction of iris and sclerotic. In many Reptiles, and in Birds, a vascular fold, called the pecten, projects from the back of the eye into the vitreous humour. A similar fold in Fishes (*processus falciformis*) ends in a knot-like structure in the lens. It acts as an “accommodator.” The retina is a very complex structure, with several layers of cells, partly supporting and partly nervous; the layer next the vitreous humour consists of nerve-fibres, while that farthest from the rays of light and next the pigment epithelium consists of sensitive rods and cones. The region where the optic nerve enters, and whence the fibres spread, is called the blind spot, and near this there lies the most sensitive region—the yellow spot, with its fovea centralis, where all the layers of the retina have thinned off except the cones.

Among the extrinsic structures must be noted the six muscles which move the eyeball, the upper and lower eyelids, which are often very slightly developed, and the third eyelid or nictitating membrane. Above Fishes there is a lachrymal gland associated with the upper lid, and a Harderian gland associated with the nictitating membrane. In Mammals there are also Meibomian glands. The secretions of all these glands keep the surface of the eye moist.

While the medullary groove is still open, the eyes arise from the first vesicle of the brain as hollow outgrowths or primary optic vesicles. Each grows till it reaches the skin, which forms a thickened involution in front of it. This afterwards becomes the compact lens. Meantime it sinks inwards, and the optic vesicle becomes invaginated to form a double-walled optic cup. The two walls fuse, and the

one next the cavity of the cup becomes the retina, while the outer forms the pigmented epithelium and the muscles of the iris. Meanwhile, surrounding mesoblast has insinuated itself past the lens into the cavity of the optic cup, there forming the vitreous humour, while externally the mesoblast also forms the vascular choroid, the firm often cartilaginous sclerotic, the inner layer of the cornea, etc. Along the thinned stalk of the optic cup the optic nerve is developed. Its protective sheath is continuous with the sclerotic of the eye and the dura mater of the brain. As the nerves enter the optic thalami, they cross one another in a chiasma, and their fibres usually interlace as they cross.

Alimentary system.—The alimentary tract exhibits much division of labour, for not only are there parts suited for the passage, digestion, and absorption of the food, but there are numerous outgrowths, *e.g.* lungs and allantois, which have nothing to do with the main function of the food canal.

By far the greater part of the food canal is lined by endoderm or hypoblast, and is derived from the original cavity of the gastrula—the primitive gut or archenteron. This is the mid-gut or mesenteron. But the mouth cavity is lined by ectoderm, invaginated from in front to meet the mid-gut. This region is the fore-gut or stomodæum. Finally, there is usually a slight posterior invagination of ectoderm, forming the anus. This is the hind-gut or proctodæum, but it is practically absent in Vertebrates.

Associated with the mouth cavity or stomodæum are—(a) teeth (ectodermic rudiments of enamel combined with a mesodermic papilla which forms dentine or ivory); (b) from Amphibians onwards special salivary glands; (c) a tongue,—a glandular and sensitive outgrowth from the floor. The tongue develops as a fold of mucous membrane in front of the hyoid, and afterwards becomes increased by growth of connective tissue, etc. In larval Amphibians muscle strands find their way into it, and Gegenbaur suggested that their original function was to compress the glands. As they gained strength they became able for a new function, that of moving the tongue. In all higher animals (above Fishes), the nasal sac opens posteriorly into the mouth; in some Reptiles and Birds, and in all Mammals, the cavity of the mouth is divided by a palate into an upper nasal and lower buccal portion.

The origin of the oral aperture is uncertain. In Tunicates it is formed by an ectodermic insinking which meets the archenteron; in

Amphioxus it seems to arise as a pore in an ectodermic disc; in other cases it is a simple ectodermic invagination; or it may owe its origin to the coalescence of an anterior pair of gill-clefts innervated by the fifth nerve. If the last interpretation be true, its origin illustrates that change of function which has been a frequent occurrence in evolution. But if the mouth arose from a pair of gill-clefts, and in some cases it actually has a paired origin, then there must have been an older mouth to start with. Thus Beard in his brilliant morphological studies distinguishes between "the old mouth and the new." The new mouth is supposed to have resulted, as Dohrn suggested, from a pair of gill-clefts; the old mouth was an antecedent stomodæum, of which the so-called nose of *Myxine* and the oral hypophysis of higher forms may be vestiges. This theory harmonises with the observations of Kleinenberg on the development of the mouth in some Annelids (*Lopadorhynchus*), in which the larval stomodæum is replaced by a paired ectodermic invagination.

The mouth cavity leads into the pharynx, on whose walls there are the gill-clefts. Of these the maximum number is eight, except in *Amphioxus*. If we exclude the hypothetical clefts, such as those possibly represented by the mouth, the first pair form the spiracles—well seen in skates. In the position of the spiracles the Eustachian tubes of higher Vertebrates develop. In front of the spiracle there is sometimes a spiracular cartilage, which Dohrn dignifies as a distinct arch. The other gill-clefts are associated with gills in Fishes and Amphibians, while in Sauropsida and Mammals, in which there are no gills, four "visceral" clefts persist as practically functionless vestigial structures. In some cases their openings are very evanescent. The clefts are bordered by the branchial arches, and supplied by blood vessels and nerves.

With the anterior part of the alimentary canal two strange structures are associated—the thyroid and the thymus.

The *thyroid gland* arises as a diverticulum from the ventral wall of the pharynx. It may be single (as in some Mammals), or bilobed (as in Birds), or double (as in some Mammals and Amphibians), or diffuse (as in Bony Fishes). Only in the larval lamprey does it retain its original connection with the pharynx, and is then a true gut-gland.

As to its morphological nature, its mode of origin suggests comparison with the hypobranchial groove in *Amphioxus* and the endostyle of Ascidians.

Almost the only light which has been cast on the physiological nature of the thyroid is from the pathological side. Goitre and Derbyshire neck are associated with an enlargement and diseased state of this

organ, and myxœdema with its degeneration or absence. As injection of extract of sheep's thyroid, or even eating this organ, alleviates myxœdema, it is concluded that the thyroid must have some specific effect on the large quantity of blood which flows through it. It is probably safe to say that the thyroid aids in keeping the blood at a certain standard of health, through some specific secretion.

The *thymus* arises as a dorsal endodermic thickening where the outgrowths which form the gill-clefts meet the ectoderm. It may be associated with a variable number of clefts—seven in the shark *Heptanchus*, five in the skate, four in Teleosteans, three in the lizard, one in the chick, and one (the third) in Mammals. In the young lamprey there are said to be no fewer than twenty-eight thymus rudiments. In Mammals it often seems to degenerate after youth. In the rabbit it has its maximum weight in the fourth month, and thereafter begins to be rapidly reduced. As it has from its first origin a distinct lymphoid nature, and apparently forms leucocytes, it has been interpreted (Beard) as a structure adapted for the phagocytic protection of the gills from bacteria, parasites, and the effects of injury. If this be so, we can understand its diminishing importance in Sauropsida and Mammalia, where its place may be to some extent taken by the palatal and pharyngeal tonsils, which are believed by some (Stöhr, Killian, Gulland) to have a similar phagocytic function.

The pharynx leads into the gullet or œsophagus, which is a conducting tube, and this into the digestive stomach, which is followed by the digestive, absorptive, conducting intestine, ending in the rectum and anus.

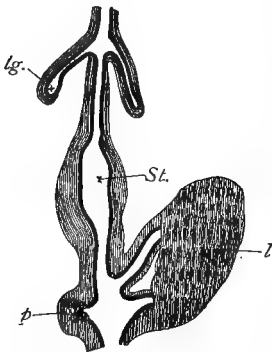

FIG. 266.—Origin of lungs, liver, and pancreas in the chick.—After Goette.

The mesoderm is shaded; the endoderm dark.

lg., One of the lungs; St., stomach; L., liver; p., pancreas.

From the œsophagus the air- or swim-bladder of most Fishes, and the lungs of higher Vertebrates, grow out. The air-bladder usually lies dorsally and is almost always single; the lungs lie ventrally and are double, though connected with the gullet by a single tube.

The beginning of the intestine gives origin to the liver, which regulates the composition of the blood and secretes bile, and to the pancreas, which secretes digestive juices. The pancreas has often a multiple rudiment.

From the hindmost region of the gut, the allantois grows out in all animals from Amphibians onwards. In Amphibians it is represented by a cloacal bladder; in the higher Vertebrates it is a vascular foetal membrane concerned with the respiration or nutrition of the embryo, or both.

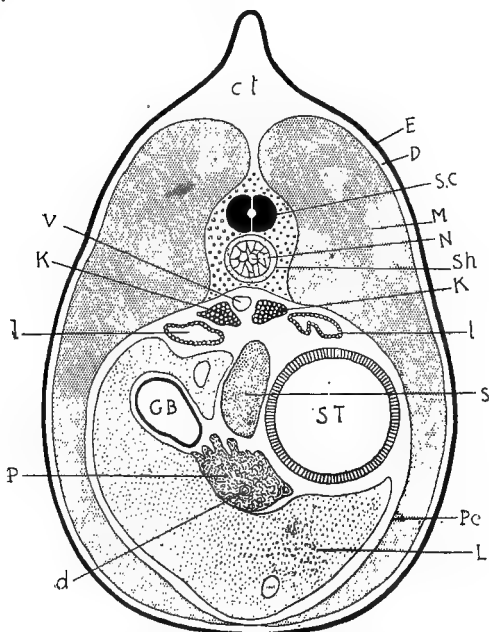

FIG. 267.—Section through a young newt.

c.t., Connective tissue; *E.*, epidermis; *D.*, dermis; *S.C.* spinal cord; *M.*, muscle; *N.*, notochord; *Sh.*, mesodermic sheath of notochord; *K.*, kidney; *l.*, lung; *S.*, spleen; *ST.*, stomach; *Pe.*, peritoneum; *L.*, liver; *d.*, duct of the pancreas (*P*); *G.B.*, gall-bladder; *V.*, dorsal aorta.

Cilia are very common on the lining of the intestine in Invertebrates, but they are much rarer in Vertebrates. Yet as they occur in *Amphioxus*, lampreys, many fishes, *Protopterus*, some Amphibians, and in embryonic Mammals, it

seems not unlikely that the alimentary tract was originally a ciliated tube.

At the posterior end an ectodermic invagination or proctodæum meets the closed archenteron, and at the junction the two epithelial layers give way, so that an open tube is formed.

The formation of the anus does not take place close to the posterior end of the primitive gut, but at a point some short distance in front of this. In consequence the so-called post-anal gut is formed. This is continuous with the neurenteric canal, and so communicates with the neural canal. The post-anal gut attains in Elasmobranchs a relatively considerable length. It has been very frequently found in Vertebrates, and is probably of universal occurrence. After a longer or shorter period it becomes completely atrophied, and with it the communication between neural and alimentary canals is completely destroyed. In some Fishes and Amphibians the anus is formed directly from the blastopore.

Speculative.—The primitive gut was probably a smooth straight tube, but the rapid multiplication of well-nourished cells would tend to its increase in diameter and in length. But on increase in both directions the slower growth of the general body would impose limitations, and in this we may find the immediate growth-condition determining the origin of folds, crypts, cæca, and coils, which would be justified by the increase of absorptive and digestive surface. There are regular longitudinal folds in *Myxine*, cross-folds traversing these would form crypts, which may be exaggerated into the pyloric cæca of Teleosteans and Ganoids, while other modifications would give rise to "spiral valves" and the like. In the same way it may be suggested that the numerous important outgrowths of the mid-gut, such as lungs, liver, pancreas, and allantois, so thoroughly justified by their usefulness, may at first have been due to necessary conditions of growth—to the high nutrition, rapid growth, and rapid multiplication of the endoderm. It may be noted that in the development of the Amphibian *Necturus*, there are hints of more numerous endodermic diverticula (Platt). It is also said that the hypochorda—a transitory structure—arising below and subsequent to the notochord, is in part due to a series of dorsal outgrowths from the gut (Stöhr). Even the notochord, which arises as a median dorsal fold, may be speculatively compared to a typhlosole—folded outwards instead of inwards. The future elaboration of the organs which arise as outgrowths of the gut would, however, depend on many factors, such as their correlation with other parts of the body, and would at each step be affected as usual by natural selection.

ALIMENTARY SYSTEM.—SUMMARY

REGION OF THE GUT.	OUTGROWTHS.	ASSOCIATED STRUCTURES.
Mouth cavity, or Stomodæum, or Fore-gut, originating as an ectodermic invagination.	Oral part of the hypophysis.	Teeth. Salivary glands. Tongue.
Pharynx, gullet or œsophagus, stomach, small intestine, large intestine, and rectum; = the mesenteron or mid-gut, originating from the cavity of the gastrula, the archenteron or primitive gut; lined by endoderm.	Thyroid } and the Thymus } gill-clefts. Air bladder; lungs. Liver. Pancreas. Allantois. The pancreas is usually the result of two ventral outgrowths and a dorsal one. In Cyclostomes and Elasmobranchs it seems to have but one rudiment; in the sturgeon four.	With the several outgrowths the surrounding mesoderm becomes associated, often to a great extent. Note also the origin of the notochord as an axial differentiation of cells along the mid-dorsal line of the embryonic gut.
Anal region, or Proctodæum, or Hind-gut, originating as an ectodermic invagination.		In some Fishes, all Amphibians, all Sauropsida, and the Prototherian Mammals, the terminal part of the gut is a cloaca or common chamber, into which the rectum, the urinary, and the genital ducts open.

Body cavity.—In *Amphioxus* the cœlom arises as pouches from the archenteron (*enterocœlic*). In the other Vertebrates, owing to modified processes of development, probably first arising from the presence of much yolk, solid cell masses grow out in place of hollow sacs, but the cavities which appear later, apparently by splitting of the cell mass (*schizocœlic*), are in reality the retarded cavities of true cœlom-pouches. A dorsal segmented portion (protovertebræ) becomes separated off from a ventral unsegmented portion (Fig. 255). It is this ventral portion which forms the body cavity of the adult. In the adult it is divided into an anterior pericardial and a posterior peritoneal portion.

The body cavity may form part of one or all of the following systems:—(1) *excretory*, voiding waste by abdominal pores or by nephrostomes; (2) *reproductive*, receiving the liberated genital elements; and (3) *lymphatic*, receiving transudations from visceral and abdominal organs.

It is probably never quite closed, but may communicate with the exterior by abdominal pores (or through nephrostomes) opening into the renal system. Both occur together in some Elasmobranchs, but they are usually mutually exclusive. In the higher Teleostei, in some Saurians, and in Mammals, there are neither abdominal pores nor nephrostomes, but only openings (stomata) into the lymphatic system.

Vascular system.—From

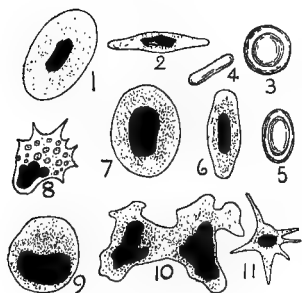

FIG. 268.—Blood corpuscles.

1. Amphibian, seen on the flat, oval, bi-convex disc (nucleated); 2, amphibian, in profile; 3, mammalian (non-nucleated), circular, bi-concave disc; 4, mammalian, in profile; 5, camel's (non-nucleated), oval; 6, mud-fish (*Lepidosiren*) in section, like Amphibian; 7, *Lepidosiren*, seen on the flat; 8, an amoeboid leucocyte with lobed nucleus and large granules; 9, a leucocyte with non-lobed nucleus and minute granules; 10, a leucocyte dividing into two; 11, a flat amoeboid corpuscle or blood platelet

Cyclostomata onwards the blood fluid contains red corpuscles, *i.e.* cells coloured with hæmoglobin—a pigment which readily forms a loose union with oxygen, and bears it from the exterior (through gills or lungs) to the tissues. These pigmented cells are usually oval and nucleated. In all Mammals except *Camelidæ* they are circular. Moreover, the full-grown red corpuscles of Mammals have no visible nuclei. The blood fluid also contains uncoloured nucleated amoeboid cells, the white corpuscles or leucocytes, of much physiological importance. Some of them, specialised as phagocytes, form "a body-guard," attacking and destroying micro-organisms within the body.

The heart receives blood from veins, and drives it forth through arteries. Its contractions in great part cause the inequality of pressure which makes the blood flow. It lies in a special part of the body cavity known as the pericardium, and develops from a single (sub-pharyngeal) vessel in Cyclostomata, Fishes, and Amphibians, from a pair in Reptiles, Birds, and Mammals.

The receiving region of the heart is formed by an auricle or by two auricles; thence the blood passes into the

muscular ventricle or ventricles, and is driven outwards. Except in adult Birds and Mammals, the veins from the body enter the auricle (or the right auricle if there are two) by a porch known as the sinus venosus. In Fishes (except Teleosteans) and in Amphibians the blood passes from the ventricle into a valved conus arteriosus, which seems to be a continuation of the ventricle. In Teleosteans there is a superficially similar structure, but without valves and non-contractile, and apparently developed from the aorta, not from the ventricle; it is called the bulbus arteriosus, and may occur along with the conus arteriosus in other Fishes. In Vertebrates higher than Amphibians there is no distinct conus.

In Cyclostomata, and in all Fishes except Dipnoi, the heart has one auricle and one ventricle, and contains only impure blood, which it receives from the body and drives to the gills, whence purified it flows to the body.

In Dipnoi the heart is incipiently three-chambered.

In Amphibians the heart has two auricles and a ventricle. The right auricle always receives venous or impure blood from the body, the left always receives arterial or pure blood from the lungs. The single ventricle of the amphibian heart drives the blood to the body and to the lungs.

In all Reptiles, except Crocodylia, the heart has two auricles and an incompletely divided ventricle. The partition in the ventricle secures that much of the venous blood is sent to the lungs; indeed, the heart, though possessing only three chambers, works almost as if it had four.

In Crocodylia there are two auricles and two ventricles. But the dorsal aorta, which supplies the posterior parts of the body, is formed from the union of two aortic arches, one from each ventricle. Therefore it contains mixed blood.

In Birds and Mammals the heart has two auricles and two ventricles, and *one* aortic arch supplies the body with wholly pure blood. This aortic arch always arises from the left ventricle, but in Birds it curves over the right bronchus, *i.e.* is a right aortic arch, and in Mammals over the left, *i.e.* is a left aortic arch. Impure blood from the body enters the right auricle, passes into the right ventricle, is driven to the lungs, returns purified to the left auricle, enters the left ventricle, and is driven to the body.

The arterial system of a fish consists of a ventral aorta continued forwards from the heart, of a number of afferent vessels diffusing the impure blood on the gills, and of efferent vessels collecting the purified blood into a dorsal aorta.

In the embryo of higher Vertebrates the same arrangement persists, though there are no gills beyond Amphibians. From a ventral arterial stem arches arise, which are connected so as to form the roots of the

dorsal aorta. This aorta gives off vessels to the body, while in embryonic life it sends important vitelline arteries to the yolk, and (in Reptiles, Birds, and Mammals) equally important allantoic arteries to the allantois.

Returning to the arterial system of a fish, we must consider the arches more carefully, and compare them with those of Sauropsida and Mammals, where they are no longer connected with functional gill-clefts, and also with those of Amphibians, where the complications due to lungs, etc., begin (see the following Table).

SUMMARY AS TO AORTIC ARCHES

FISHES.	AMPHIBIANS.	SAUROPSIDA AND MAMMALS.
(a) Mandibular aortic arch usually aborts; there is a persistent trace in Elasmobranchs (spiracular artery).	Aborts, or is not developed.	At most merely embryonic.
(b) Hyoid aortic arch aborts, or is rudimentary.	Aborts.	At most merely embryonic.
(c) 1st branchial.	Carotid.	Carotid.
(d) 2nd branchial.	Systemic arches, unite to form dorsal aorta.	Systemic. Only the right persists in Birds; only the left in Mammals.
(e) 3rd branchial.	Rudimentary or disappears in most forms.	Disappears.
(f) 4th branchial (gives off artery to "lung" of Dipnoi).	Pulmonary.	The pulmonary.

The important features in the development of the venous system are as follows:—

- (a) In the embryo the vitelline veins bring back blood from the yolk-sac, at first directly to the heart, and later to the liver. Into these veins, blood returned from the intestine is poured in increasing quantity by other veins. In the adult these persist to form the hepatic portal system, by means of which blood from the stomach and intestine is carried to the liver, and not directly to the heart.

- (b) At an early stage in development the blood is brought back from the anterior region by the superior cardinal veins, from the posterior region by the inferior cardinals. The two cardinals on each side unite to form the short transverse ductus Cuvieri, the two ducts entering the sinus venosus of the heart.

In Fishes the superior cardinals persist, the inferior cardinals bring back blood from the kidneys, and also to some extent, by means of their union with the caudal vein, from the posterior region of the body. In some cases this union with the caudal is only indirect, through the medium of the kidney (Elasmo-branches); in this way the renal portal system is constituted. In higher Vertebrates, before development is completed, the superior cardinals are replaced by the superior venæ cavæ (into which the superior cardinals open as external jugulars). The inferior cardinals at first return blood from the Wolffian bodies and the posterior region; later they atrophy, and are replaced by an unpaired inferior vena cava which brings back blood from the kidney (efferent renals), from the liver (hepatics), and from the hind-limbs except when there is a renal portal system. The azygos vein of Mammals is a persistent remnant of the inferior cardinals.

- (c) In Amphibia a vein known as the epigastric (anterior abdominal) carries blood from the hind-limbs into the hepatic portal system. This vein also receives blood from the allantoic bladder, a fact which is of great theoretical importance. In all higher Vertebrates in embryonic life, the blood from the allantois passes through the liver, and to a greater or less extent into its capillaries, on its way to the heart. In

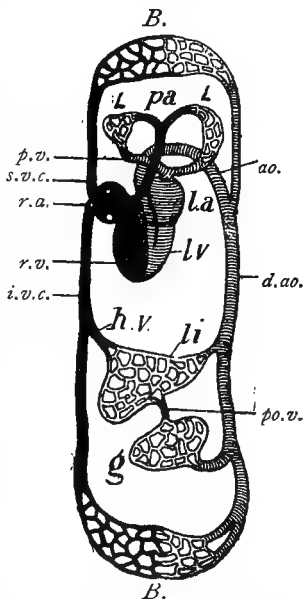

FIG. 269.—Diagram of circulation.
—After Leunis.

r.a., Right auricle receiving superior vena cava (*s.v.c.*) and inferior vena cava (*i.v.c.*); *r.v.*, right ventricle; *p.a.*, pulmonary artery to lungs (*L.*); *p.v.*, right pulmonary vein; *l.a.*, left auricle; *l.v.*, left ventricle; *ao.*, aortic arch; *d.a.o.*, dorsal aorta giving off arteries to liver (*li.*), to gut (*g.*), to body (*B.*); *p.o.v.*, portal veins; *h.v.*, hepatic vein.

Reptiles the allantoic veins persist throughout life as the epigastric vein or veins. In Birds and Mammals, on the other hand, they atrophy completely at the close of foetal life. In Birds, however, a vein is developed which connects the veins coming from the posterior region with the allantoic veins; this persists when the remainder of the allantoic veins atrophy, and thus in Birds as in Amphibia there is a connection between the components of the inferior vena cava and the portal system. In Mammals no such connection occurs.

According to many authorities, the vascular system is developed in the mesoblast from the hollowing out of strands of cells, the outer cells forming the walls of the vessels, the inner forming the constituents of the blood. The heart, with the exception of its endothelial lining, is a tubular development of the splanchnic mesoderm.

Associated with the vascular system is the spleen, which appears to be an area for the multiplication or destruction of blood corpuscles.

The *lymphatic system*, developed in mesoblastic spaces, is a special part of the vascular system. It consists of fine tubes which end blindly in the tissues and drain off fluids, of larger vessels which the tubes combine to form, and which open into veins. The lymph vessels contain amoeboid cells, and have associated lymphatic glands in which these lymphocytes are produced.

Respiratory system.—In *Balanoglossus*, Tunicates, and *Amphioxus*, the walls of the pharynx bear slits, between which the blood is exposed in superficial blood vessels to the purifying and oxygenating influence of the water.

In Cyclostomata, Fishes, all young and some adult Amphibians, there are not only clefts on the walls of the pharynx, but gills associated with these. On the large surface of the feathery or plaited gills, the blood is exposed and purified.

In Reptiles, Birds, and Mammals, traces of gill-clefts occur in the embryos, but without lamellæ or respiratory function. In the embryo the blood is purified, as will be explained afterwards, by aid of the foetal sac known as the allantois; and after birth the animals breathe by lungs. All adult Amphibians also have lungs, to which the lung or swim-bladder of Dipnoi is physiologically equivalent.

The gill-clefts arise as outgrowths of the endodermic gut which meet the ectoderm and open. The ventral paired

lungs arise from an outgrowth of the gut, as does also the swim-bladder of many Fishes, though it usually lies on the dorsal surface, has rarely more than a hydrostatic function, and usually has a blood supply different from that of the lungs. In Dipnoi and some "Ganoids" it is supplied by a pulmonary artery arising from the sixth aortic arch. There is probably a homology between lung and swim-bladder.

Excretory system.—The development of this is always complicated. In the embryos of Vertebrates at an early stage there are always traces of a *pronephros*, or so-called head-kidney. This is perhaps seen in its most primitive condition in *Amphioxus*, where, as already described, there is a series of tubules, segmentally arranged, opening on the one side into the body cavity by several flame-cells, and on the other into the atrial chamber, *i.e.* the exterior. On the surface of each tubule a vessel connecting the sub-intestinal vein with the dorsal aorta forms a vascular plexus—the so-called glomus. Such a condition of parts is never in its entirety found in the Craniata. There the tubules open not directly to the exterior, but into a longitudinal pronephric or segmental duct, and they are usually few in number; but in their segmental arrangement, as shown by the blood supply, and in the presence of glomera, they agree entirely with those of *Amphioxus*. In connection with the glomera, it may be noted that while the blood supply usually comes directly from the dorsal aorta, it has been shown by Paul Mayer and Rückert that in the embryos of Selachians connecting vessels occur between the dorsal aorta and the sub-intestinal vein, which form rudimentary networks on the tubules of the pronephros. This shows a very striking correspondence with the conditions seen in *Amphioxus*.

The pronephros develops from the parietal mesoblast at the junction of the muscle segments and the unsegmented body cavity (see Fig. 270) in the anterior region, and varies greatly in its degree of development. In *Myxine* and *Bdellostoma* it persists in adult life, though apparently, at least in part, in a degenerate condition, and is said to be the functional excretory organ of the little (degenerate?) fish *Fierasfer* and some other Bony Fishes. In most Bony Fishes, and in Amphibia, it is merely a larval organ, but is then large and important. In Elasmobranchs and Amniota, except Crocodiles and Turtles, it is from the first rudimentary and functionless.

The origin of the segmental or pronephric duct is still undetermined. It usually arises from the mesoblast, in some cases growing backwards directly from the rudiment of the pronephros, while in others the surrounding mesoblast takes an important part in its formation; in Elasmobranchs, in Mammals, and in the chick, a connection with the epiblast has been described by various observers. Rückert is of opinion that it originally arose by the fusion of the outer ends of the pronephric tubules, and that the occasional connection with the ectoderm indicates the position of former excretory pores (*cf.* *Amphioxus*).

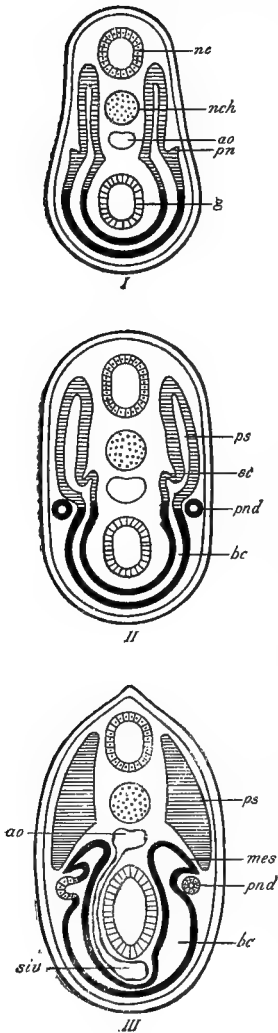

At a late period in those types in which the pronephros is a functional larval organ, but much earlier in the higher Vertebrates, another series of tubules is differentiated from the mesoblast, and, acquiring a connection with the segmental duct, constitutes the *mesonephros*, or mid-kidney. The tubules arise usually, though not invariably, nearer the posterior end of the body than the pronephros, and are formed from the portion of the mesoblast which connects the muscle segment and the lateral plate (see Fig. 270). Below the Amniota the mesonephros forms the permanent excretory organ. In higher forms another series of nephridial tubules arises still farther back in the body, and forms the *metanephros*, or permanent kidney. The mesonephric and metanephric tubules resemble each other closely, but the relation of the former to the pronephros is still a debated point. When fully developed, a mesonephric tubule consists of—(1) an internal ciliated funnel (nephrostome), which opens into the body cavity, but is only rarely represented; (2) a

FIG. 270.—Development of excretory system of Vertebrate.—In part after Boveri.

In I. the primitive segments are not separated off from the lateral plate, and the pronephros (*pn.*) is seen arising from the lower part of the primitive segment. In II. the pronephros is completely separated off from the primitive segment and lateral plate. In III. the origin of the mesonephric tubules is seen. They arise from the upper part of the lateral plate, which is now completely separated from the primitive segment, and curving round the pronephric duct come to open into it.

n.c., nerve cord; *n.ch.*, notochord; *pn.*, pronephros; *g.*, gut; *p.s.*, primitive segment; *mes.*, mesonephric tubule; *pn.d.*, pronephric duct; *bc.*, body cavity; *ao.*, aorta; *siv.*, sub-intestinal vein, with vessel to the aorta.

small cavity (Malpighian capsule) derived from the cœlom, and containing a mass of capillaries which project into the cavity of the tubule; and (3) a coiled tube in part excretory, in part a conducting canal for the waste filtered from the blood. The metanephric tubules have a quite similar structure, but the nephrostome is never present.

In all Vertebrates the primitive nephridia open into a pair of longitudinal ducts, developed like the nephridia as special portions of the cœlom. These ducts open into the end of the gut. According to their connections with the nephridia these longitudinal ducts are called pronephric, mesonephric, or metanephric ducts, and they are also called segmental ducts. In Elasmobranch fishes a Müllerian duct is separated off from in front backwards from the longitudinal duct and forms the oviduct of the female, a rudiment in the male. After the separation of the Müllerian duct, the longitudinal duct (now called mesonephric or Wolffian) forms in the male the vas deferens and also receives the tubes from the permanent kidney (mesonephros). In the female the Wolffian duct has this last function. In general it may be said that the original longitudinal duct becomes the vas deferens in the male Vertebrate, and that another duct—the Müllerian—whose development is obscure except in Elasmobranchs, forms the oviduct. The metanephric duct, developed in part from the hinder end of the mesonephric duct, is the ureter of the permanent kidney in Amniota.

Suprarenal bodies.—These are found in most Vertebrates near the reproductive organs and kidneys. They seem to increase in importance as we ascend the series. Typically, each shows a distinction into a cortical and a medullary zone. It is usually asserted that these two areas have a different origin, the medullary region being derived from the sympathetic nervous system, the cortex from the cœlomic epithelium. There is much evidence (morphological and physiological) that the suprarenals of Elasmobranchs correspond to the medullary part in Mammals, while the interrenals of Elasmobranchs and the suprarenals of Teleosts and Ganoids correspond to the cortical portion in Mammals.

With regard to function, there is some uncertainty. The suprarenal bodies are relatively very large in embryonic life, but fail to maintain their primitively rapid rate of growth. A substance, adrenalin, can be extracted from them which has a remarkable action upon the parts innervated by the sympathetic system, producing on injection the same effects as stimulation of the sympathetic would have, *e.g.* constriction of the arterioles, and consequent heightening of the blood pressure.

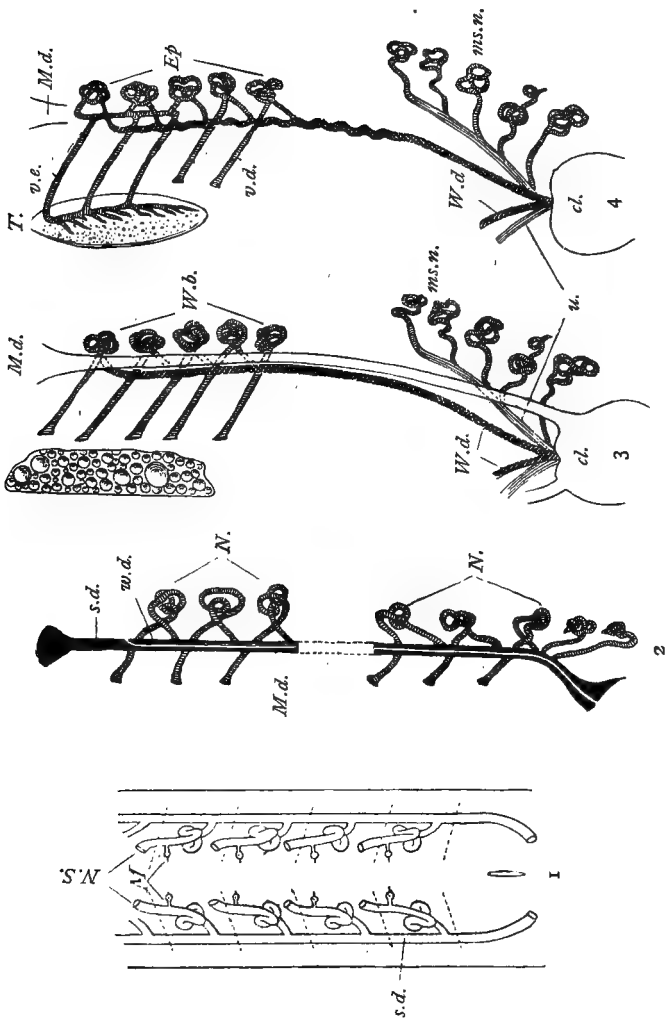

FIG. 271.—Urogenital system.

1. Ideally simple structure of excretory system (after Hatschek). 2. Primitive state of excretory system in Elasmobranch embryo. 3. Arrangement in adult female. 4. Arrangement in adult male. (2-4 after Balfour.) s.d., Longitudinal or segmental duct; N.s., nephrostomes; M., Malpighian bodies—the dotted lines represent segments; N, segmental tubes or nephridia; cl., cloaca; u., "ureter"; m.s.n., posterior mesonephros; W.d., Wolffian duct; M.d., Müllerian duct; Ov., ovary; W.b., Wolffian body; T., testis; v.e., vasa efferentia; v.d., vas deferens; Ep., epididymus

Reproductive system.—The ovaries and testes are developed from a ridge formed by a part of the epithelium lining the abdominal cavity, this ridge constituting the so-called germinal epithelium.

In the male the proliferating germinal epithelium is divided by embryonic connective tissue into numerous follicles. The cells of the follicles form seminal mother-cells, which, by their ultimate divisions, give rise to spermatozoa. From the mesonephros, tubules grow out to the embryonic testes; these form the collecting tubes of the organs and open into the Wolffian duct, the vas deferens of the adult.

In the female the ovary is similarly divided up into follicles. In this case, however, differentiation sets in among the originally equivalent cells of the follicle. One cell in each follicle is more successful than its neighbours, which are sacrificed to form an envelope of follicular cells around the single large ovum cell. The ova are usually shed into the body cavity, and pass thence to the exterior by the Müllerian ducts or oviducts.

In many cases, between the follicular cells and the ovum there is a membrane, the zona radiata, which is traversed by fine pores, and, in consequence, has a striated appearance; other egg membranes, more or less transitory in nature, also occur. In the lower Vertebrates the layer of follicle cells is single, but in Mammals (except in Monotremes) it is multiple, and a quantity of clear fluid accumulates between the cells and the ovum. The whole forms a "Graafian follicle," which bursts when the ovum is liberated.

Before fertilisation takes place, the ovum undergoes a process of maturation, during which extrusion of polar bodies typically occurs; the technical difficulties in the way of the definite observation of this fact are, however, often very great. The ova are fertilised outside the body in Cyclostomata, Ganoids, Teleosteans, Dipnoi, and tailless Amphibians; internally in the other Vertebrates.

Hermaphroditism occurs as a normal state in Tunicata, most of which are first functionally female and then male (protogynous); in *Myxine* (*g.v.*), which is first male and then female (protandrous); in some species of the Teleostean genera *Chrysophrys* and *Serranus*, of which the latter is regularly self-fertilising; and in a solitary Batrachian. It occurs casually in some Selachians, in the sturgeon, in about a score of Teleosteans, *e.g.* cod, in various Amphibians, and more rarely in Amniota. There are also embryological facts which suggest that the embryos of higher Vertebrates pass through a state of hermaphroditism before the unisexual condition is reached. On these grounds it has often been suggested that the original Vertebrate animals were hermaphrodite.

The quantity of yolk present in the egg varies very greatly in Vertebrates, and its presence or absence exercises a profound influence upon the processes of development. Following Hertwig, we may notice that the presence of yolk has both a physiological and a morphological effect. Physiologically, the presence of a store of nutriment enables the developmental process to be carried on uninterruptedly, and the period of independent life to be postponed until more or less complexity of organisation has been attained. Morphologically, the yolk acts as a check to the activity of the protoplasm, and by substituting an embryonic mode of nutrition for that for which the adult organism is fitted, tends to prevent a speedy establishment of the adult form. When much yolk is present, it usually forms a hernia-like yolk-sac, hanging down from the embryonic gut. As a further consequence, we may notice the tendency to the production of embryonic organs useful only during embryonic life. We must consider the formation of an

organic connection between mother and unborn young as a further step in the same direction as the acquisition of yolk. This is hinted at in some Fishes and Reptiles, but culminates in the placental Mammals. It may be looked at in two different ways. On the one hand, the diversion of the nourishment from the ovary, during the period of gestation, tends to starve the remaining ovarian ova, and this check to fertility is further prolonged during lactation (Ryder); on the other hand, the chance of survival is much increased, and the maternal sacrifice finds its justification in the increased specialisation of the offspring.

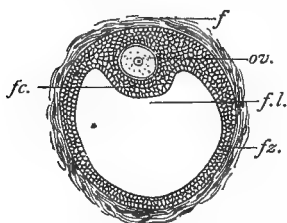

FIG. 272.—Mammalian ovum.—
After Hertwig.

ov., Ovum; f., follicular capsule; f.z., follicle cells; f.c., follicle cells forming discus proligerus; f.l., cavity occupied by liquor folliculi.

In accordance with the effect of the presence of yolk as noted above, we find that segmentation is total (holoblastic) in the ova of the lamprey, the sturgeon, *Ceratodus*, Amphibians, and all Mammals except the Monotremes. In the ova of Elasmobranchs, Teleosteans, Reptiles, Birds, and Monotremes, the activity of the protoplasm is not sufficient to overcome the inertia of the yolk, and segmentation is partial (meroblastic).

Similarly we find that a gastrula is formed, in part at least, by distinct invagination in the development of the lamprey, the sturgeon, and Amphibians (though the occurrence of invagination has been denied for the frog); it is more modified in Teleosteans and Elasmobranchs, whose ova have more yolk; it is much disguised in Sauropsida and Mammals.

Most Vertebrates lay eggs in which the young are hatched outside of the body, and to all these forms the term *ovi-*

parous is applied. In some sharks, a few Teleosteans, some tailed Amphibians, a few lizards and snakes, the young are hatched before they leave the body of the mother. To these cases the awkward term *ovo-viviparous* is applied, but there is no real distinction between this mode of birth and that called oviparous, and both may occur in one animal (*e.g.* in the grass-snake) in different conditions. In the placental Mammals there is a close organic connection between the unborn young and the mother, and the parturition in this case is usually called *viviparous*. But all the three terms are bad.

CHAPTER XXI

PHYLUM CHORDATA

SUB-PHYLUM CRANIATA

CLASS CYCLOSTOMATA

(*Synonym*, MARSIPOBRANCHII)

THE hag (*Myxine*), the lamprey (*Petromyzon*), and a few others like them, differ in so many ways from Fishes, that they must be ranked in a distinct class. They represent an archaic type, whose interest has been enhanced by the discovery of *Palæospondylus* in the Old Red Sandstone.

GENERAL CHARACTERS

Unlike all higher Vertebrates (Gnathostomata), the Cyclostomata have round suctorial mouths, without distinctly developed jaws. They are also without paired fins and without scales. Their respiratory system consists of paired gill-pouches, to which the term Marsipobranch refers. The body is vermiform, the unpaired fins have no true fin-rays. In the extant forms the skeleton is wholly cartilaginous, and the notochord persists uncontracted. The nasal organ is unpaired, there is no sympathetic nervous system, no conus arteriosus, no distinct pancreas, no spleen, no genital ducts, and the segmental duct persists as such. Their geographical distribution is wide.

FIRST TYPE. *Myxine*—The Hag

The glutinous hag (*Myxine glutinosa*) is not uncommon off the coasts of Britain and Scandinavia, the Atlantic coast of America, etc. It lives in the mud at depths of

40 to 300 fathoms. It often lies buried with only the nostril protruding from the mud, but it can swim gracefully and rapidly in eel-like fashion in search of prey. It eats the bait off the fisherman's long lines, and it also enters and devours the cod, etc., which have been caught on the hooks. According to some, the hag also bores its way into free-swimming fishes, but the evidence is not satisfactory. According to Mr. J. T. Cunningham, the young animals are hermaphrodite, containing immature ova and ripe spermatozoa, while older forms produce ova only. If the same form is first functionally a male and afterwards functionally a female, the term "protandrous hermaphroditism" is justified, and Nansen corroborated Cunningham's discovery, which is, however, disputed by Bashford Dean. A somewhat similar "protandrous" hermaphroditism is known elsewhere, e.g. in the Nemertean *Stichostemma eilhardii*, in the aberrant *Myzostoma*, and in the crustacean Cymothoidæ. Hag are said to spawn in late autumn. Of the development and early history nothing is known.

Form, skin, and muscular system.—The body is eel-like; measuring 15 to 24 in. in the adult. The colour is pinkish, the red blood shining through an unpigmented skin. There is a slight median fin around the tail; beside the mouth and nostril there are four pairs of sensitive barbules. There are no paired fins. The cloacal opening is near the posterior end of the body.

The skin is scaleless, and rich in goblet cells, which secrete mucus. There is also a double row of glandular pits, partly embedded in muscle, and arranged segmentally on each side of the ventral surface along its entire length. Each opens by a distinct pore, and so much mucus is rapidly secreted that the ancients said the hag "could turn water into glue." This makes the hag difficult to grip, and its function is doubtless in part protective. The mucus chiefly consists of strange spiral threads which uncoil when ejected from the sacs.

The zigzag muscle segments or myomeres are traceable. The rasping teeth are worked by a powerful muscular structure, sometimes called a "tongue." A section of this shows a strong muscular cylinder surrounding a cartilage.

The skeleton.—The skeleton is wholly cartilaginous. The notochord persists unsegmented within a firm sheath, the skull is a simple unroofed trough, jaws are not distinctly developed, there is only a hint of the complicated basket-work which supports the gill-pouches of the lamprey; but the tongue, the barbules, etc., are supported by cartilaginous rods. The tail is protocercal.

Nervous system.—The brain has the usual parts, but the cerebrum and cerebellum are little more than rudimentary. It is much compressed, with practical obliteration of the ventricles. The fore-brain seems to agree with that of "Ganoids" and Teleosteans in having a non-nervous roof.

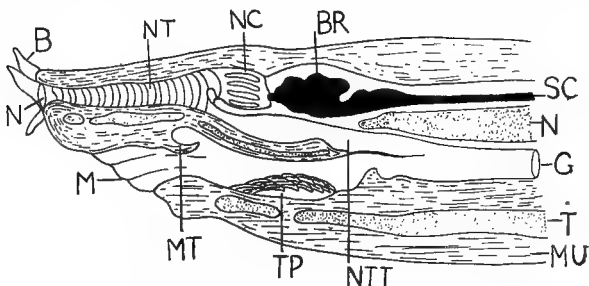

FIG. 273.—Median longitudinal section of anterior region of *Myxine*.—After Retzius and Parker.

B., Barbule; *N.*, nasal aperture; *NT.*, nasal tube with rings of cartilage; *NC.*, nasal capsule; *BR.*, brain; *SC.*, spinal cord; *N.*, notochord; *G.*, gut; *T.*, cartilage of "tongue"; *MU.*, muscle; *NTT.*, posterior part of nasal sac; *TP.*, a tooth plate; *MT.*, median tooth on roof of mouth (*M.*).

The spinal cord is somewhat flattened, and is sheltered simply by fibrous tissue. Throughout at least a portion of the cord there are two dorsal roots for each ventral root. The union of dorsal and ventral roots is only partial, and there is no sympathetic system. There is no lateral line system.

The eye is without lens, cornea, iris, or muscles, and is hidden beneath the skin; the optic nerves do not cross until they enter the brain; the ear has only one semi-circular canal. The single nasal sac (with *paired* folds of olfactory epithelium in *Bdellostoma*, an American relative) opens dorsally at the apex of the head, and communicates posteriorly with the pharynx by a naso-palatine duct. It

may be, as in the lamprey, a combination of olfactory and pituitary involutions. The absence of pigment and sensory structures in the skin, and the simple state of the eye and ear, may be partly associated with the hag's mode of life. It seems probable that the simplicity is primitive rather than degenerate.

Alimentary system. — The mouth is suctorial. There is a median tooth above, and two rows of teeth are borne on each side of the muscular "tongue." These teeth are entirely "horny," but sharp. Into the mouth, just in front of a fringed velum which separates it from the pharynx, the nasal, or, as some would say, the naso-pituitary, sac opens. Thus water passes from the nostril into the pharynx. It may be, as Beard suggests, that this passage is a persistent "old mouth," the palæostoma of Kupffer. From the gullet open six respiratory pouches, each of which has an efferent tube, and the six efferent tubes of each side unite in a common exhalant orifice. The gut is straight and uniform, with wavy longitudinal ridges internally, with a two-lobed liver and a gall-bladder, but without the usual pancreas. The anus lies within an integumentary cloacal chamber.

Respiratory system. — Water may enter by the nasal sac or by the mouth. It passes into the pharynx, down the gullet, into the six pairs of respiratory pouches and their efferent tubes, and leaves the body by the single aperture at each side. The respiratory pouches have much-plaited internal walls, on which the blood vessels are spread out. On the left side, behind the sixth pouch, a

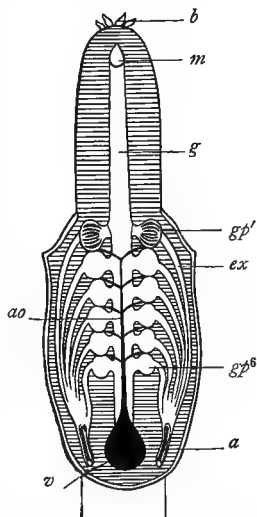

FIG. 274.—Respiratory system of hag, from ventral surface.

b., Barbules; *m.*, mouth opening on ventral surface; *g.*, gullet; *gp¹*, first gill-pouch, cut open to show internal lamellæ; *gp⁶*, sixth gill-pouch; *ex.*, exhalant canal of first gill-pouch; *v.*, ventricle of heart; *ao.*, aorta; *a.*, common exhalant aperture.

tube (the oesophago-cutaneous duct) opens from the oesophagus to the exhalant aperture. Perhaps some water enters by it in inspiration.

Vascular system.—The blood contains the usual amœboid leucocytes and red blood corpuscles, elliptical in form (circular in the lamprey). It is collected from the body in anterior and posterior cardinals, passes through a sinus venosus into the auricle of the heart, thence to the ventricle, thence along a ventral aorta, which gives off vessels to the respiratory pouches. From these the purified blood passes dorsalwards in efferent branchial vessels, which unite posteriorly, to form the dorsal aorta, while from the most anterior a branch goes to the head. The portal vein has a contractile sinus which drives blood through the liver. The pericardium is in free communication with the general body cavity.

Excretory system.—The segmental pronephric ducts persist, and give off short lateral tubules, metamericly arranged, ending in globular malpighian capsules. The pronephros is functional in the young form, and at least part of it persists throughout life, *e.g.* in a lymphoid structure beside the pericardium.

The ducts end by separate pores on a papilla within the integumentary cloaca.

Reproductive system.—*Myxine* is a protandrous hermaphrodite, spermatozoa being formed at an early period, and ova afterwards. The reproductive organ is simple, unpaired, and moored by a median dorsal fold of peritoneum. Owing to the large size of the ova, the ovary is very conspicuous in full-grown forms. When the ova are freed from the ovary, they pass into the body cavity. Each has an oval horny membrane, with a circlet of knobbed processes at each end. By these they become entangled together. There are no genital ducts, but just above the anus there is a large genital pore opening from the body cavity into the integumentary cloaca. The development is still unknown.

Besides *Myxine glutinosa*, two other species are known—one from Japan, another from the Magellan Straits. The southern *M. australis* lives in shallow water close by the shore, but the others live in deep water. The genus *Bdellostoma*, from the Pacific coasts America, off the Cape of Good Hope, etc., is nearly allied.

The best-known species, *Bdellostoma dombeyi*, resembles the hag in many ways. It lives at the bottom of the sea, at depths of a hundred fathoms or more, and is often found inside caught halibut, etc. The gill-pouches have separate openings, and are extraordinarily variable in number, from six to fourteen on either side—a variability perhaps pointing to ancestral reduction from a larger number (cf. *Amphioxus*). Large eggs are laid on a shelly or rocky bottom, become connected by polar hooks in chains or clusters, are fertilised after deposition, and exhibit meroblastic discoidal segmentation and direct development. Ayers' experiments show that the removal of one or both ears in this form does not materially affect equilibration.

SECOND TYPE

Petromyzon—The Lamprey

There are three British species—the sea lamprey (*Petromyzon marinus*), over 3 ft. in length; the river lampern (*P. fluviatilis*), nearly 2 ft. long; and the small lampern or "stone-grig" (*P. planeri*). They eat worms, small crustaceans, insect larvæ, dead animals, etc.; but they also attach themselves to living fishes, and scrape holes in their skin. As their names suggest, they also fix their mouths to stones, and some draw these together into nests.

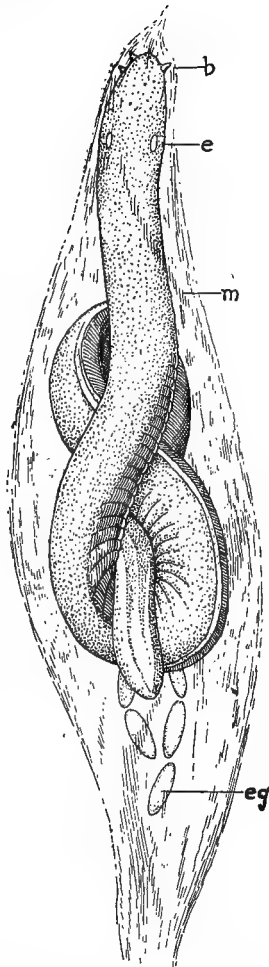

FIG. 275.—*Bdellostoma stouti* (Californian hag), enveloped in sheath of mucus.—After Bashford Dean.
b., Barbules e., eyes m. mucus; eg., eggs.

The spawning takes place in spring, usually far up rivers. Before laying the eggs, the lamprey seems to fast (cf.

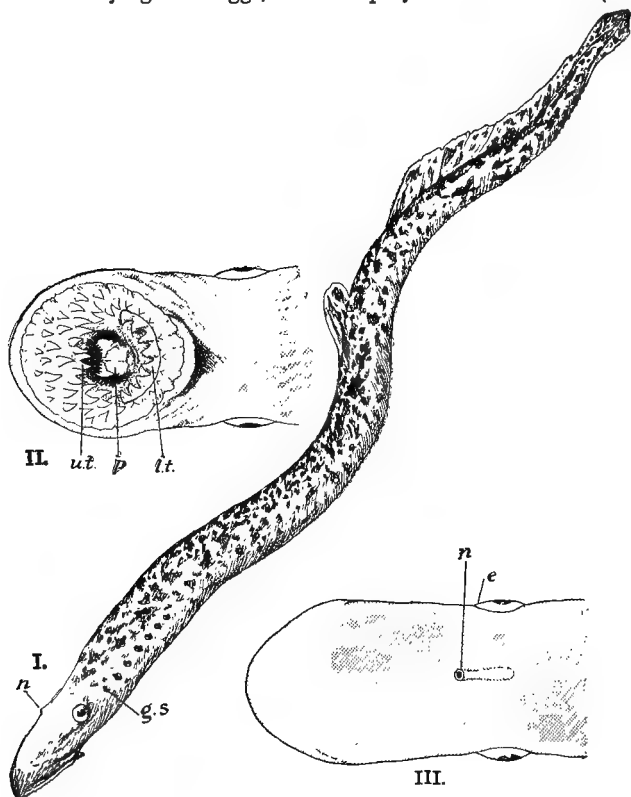

FIG. 276.—The lamprey (*Petromyzon marinus*).

- I. The entire animal; note the seven gill-slits of which the first is marked *g.s.*, the nostril *n.*, and the unpaired median fins. II. Ventral aspect of the head; *u.t.*, upper teeth; *l.t.*, lower teeth; *p.*, the piston in the mouth. III. Upper surface of the head; *n.*, the nostril with the pineal groove behind it; *e.*, the eye.

salmon, *Protopterus*, frog), and its muscles undergo a granular degeneration (cf. *Protopterus*, tadpole, etc.). Soon

after spawning the adults of both sexes die. For reproduction is often the beginning of death as well as of life, though in higher animals the nemesis may be slow. The young are in many ways unlike the parents, and after 2-4 years pass through a striking metamorphosis. To the larvæ before metamorphosis the old name *Ammocætes* is applied.

Form, skin, and muscles.—The body is eel-like, with two unpaired dorsal fins, and another round the tail.

The skin is scaleless, slimy, and pigmented. Its structure, like that of *Myxine*, is complex. Sensory structures occur on the head and along the sides, and form a lateral line system.

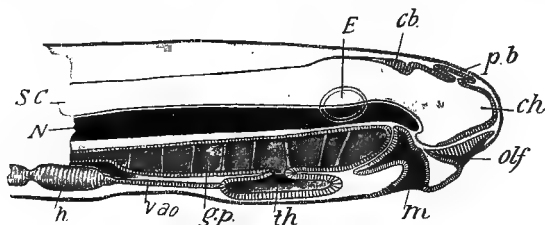

FIG. 277.—Longitudinal vertical section of anterior end of larval lamprey.—After Balfour.

m., Mouth; *th.*, thyroid; *g.p.*, one of the gill-pouches; *v.a.o.*, ventral aorta; *h.*, heart; *N.*, notochord; *S.C.*, spinal cord; *E.*, auditory vesicle; *cb.*, cerebellum; *p.b.*, pineal body; *c.h.*, cerebral hemispheres; *olf.*, olfactory invagination

The muscle segments or myomeres are well marked. The suctorial mouth and the rasping "tongue" are very muscular.

The skeleton.—The skeleton is wholly cartilaginous. The notochord persists unsegmented, but its firm sheath forms rudimentary neural arches. The skull is imperfectly roofed. There are no distinct jaws, but a cartilaginous ring supports the lips of the mouth. There is a complex basket-work around the gill-pouches, but it is *not* likely that its elements correspond to visceral arches. Endoskeletal cartilaginous rods, not comparable to the dermal fin-rays of fishes, support the dorsal and caudal fins, and other skeletal parts occur about the "tongue." The caudal end of the notochord is quite straight.

Nervous system.—The brain has the usual parts, but is small and simple; the roof of the fore-brain is composed of non-nervous epithelium; there is a distinct pineal body, with hints of an eye; the oral part of the hypophysis is developed from in front of the mouth, and becomes closely connected with the involution of epiblast which forms the nostril. A unique peculiarity in the brain is that the middle part of the roof of the *iter* is simply epithelial. The spinal cord is flattened; the dorsal and ventral roots of the spinal nerves alternate and do not unite; there is no sympathetic system.

Though the larva sometimes receives the name of “nine-eyes”—which expresses a popular estimate of the branchial apertures—it is blind, for the eyes are rudimentary and hidden. In the adult they rise to the surface, and are fairly well developed. The optic nerves do not cross until they enter the brain. The ear has only two semicircular canals instead of the usual three. The single nasal sac does not open posteriorly into the mouth as it does in *Myxine*; though prolonged backwards it ends blindly. Its external opening is at first ventral, but is shunted dorsally and posteriorly.

Alimentary system.—The oral funnel, at the base of which the mouth lies, has numerous horny teeth. It is applied to the lamprey's victim, and adheres like a vacuum sucker; the toothed “tongue” works like a piston; both flesh and blood are thus obtained. From the floor of the pharynx an endostylar groove is constricted off to form the thyroid.

From the gullet of the young larva seven gill-pouches open directly to the exterior; in the adult this larval gullet becomes wholly a respiratory tube. It is closed posteriorly, and opens anteriorly into the gullet of the adult, which is a new structure. At the junction of the respiratory tube with the gullet of the adult lie two flaps or vela.

The rest of the gut is straight and simple, with a single-lobed liver, but with only a hint of a pancreas. The gall-bladder and bile-duct disappear in the adult, and the whole intestine is partially atrophied. There is a slight spiral fold in the intestine.

Respiratory, vascular, and excretory systems.—Seven gill-pouches with plaited walls open directly to the exterior on each side, and communicate indirectly with the gullet. Water enters the pouches partly *via* the mouth, partly by the external apertures (spiracula), and the movements of the branchial basket and of the tongue-piston aid greatly in the process. In the larva there is an eighth most anterior pouch which does not open to the surface. It corresponds to the spiracle of Elasmobranchs. With each of the seven open pouches in the larva four thymus rudiments are associated.

The vascular system is essentially the same as in the hag. The red blood cells are biconcave, circular, nucleated discs.

The segmental or pronephric ducts persist as ureters, and are connected with lateral mesonephric tubules forming a kidney more complicated than that of the hag. The pronephros, which is functional in the larva, entirely disappears. The ureters unite terminally in a urogenital sinus (not present in the hag), into which there open two genital pores from the body cavity. The sinus opens, like the anus, into an integumentary cloacal chamber.

Reproductive system.—The sexes are separate, but ova sometimes occur in the testes. The reproductive organ is elongated, unpaired, and moored by a median dorsal mesentery. There are no genital ducts. The ova and spermatozoa are liberated into the body cavity, and pass by two genital pores (true abdominal pores) into the urogenital sinus, and thence to the exterior. In the male there is an ejaculatory structure, or so-called "penis." There are many more males than females.

Development of *P. planeri*.—The ripe ovum has a considerable quantity of yolk, but segmentation is total though slightly unequal. A blastosphere is succeeded by a gastrula. The blastopore persists as the anus of the animal, and there is no neurenteric canal.

The formation of the central nervous system is peculiar, for the sides of the epiblastic infolding remain in contact instead of forming an open medullary canal.

In the head region, where the gut is not surrounded by yolk-cells, the mesoblast is formed from hollow folds in "enterocelic" fashion; but in the trunk region the cushions of hypoblastic yolk-cells change gradually into mesoblast, and acquire a coelom cavity in "schizocelic"

fashion. Thus the two main ways in which a body cavity arises—(a) from coelom pouches of the archenteron, (b) from a splitting of solid mesoblast rudiments—are here combined.

Metamorphosis of Lampreys.—The larvæ live wallowing in the sand or mud of streams, and feed on minute animals. Those of *P. planeri* are so unlike the adults that they were once referred to a distinct genus *Ammocetes*, and though a Strasburg fisherman, Baldner, is said to have discovered their true nature about two hundred years ago, the fact was overlooked until August Müller traced the metamorphosis in 1856. In the small lampern the change to the adult state is sometimes postponed until the autumn of the fourth or fifth year, when it completes itself rapidly. Less is known about the metamorphosis of the other species.

In the *Ammocetes*, or larva before metamorphosis, the head is small, the dorsal fin is continuous, the upper lip is semicircular, the lower lip is small and separate, the mouth is toothless and not suctorial, the brain is long and narrow, the eyes are half made and hidden beneath the skin; the future gullet, as distinguished from the respiratory tube, is not yet developed.

Contrast between Hag and Lamprey

HAG (<i>Myxine</i>).	LAMPREY (<i>Petromyzon</i>).
<p>Exclusively marine. The fin is confined to the tail. Numerous large glands in the complex, slimy skin. Mouth with barbules, no lips, few teeth.</p> <p>Skull without any roof. Skeletal system less developed than in the lamprey. Only a hint of a branchial basket. Cerebrum and cerebellum rudimentary. Eyes hidden and rudimentary.</p> <p>Ear with one semicircular canal. Nasal sac opens posteriorly into the mouth cavity.</p> <p>Six pairs of gill-pouches, opening directly into the gullet, less directly to the exterior.</p> <p>Longitudinal ridges in the intestine.</p> <p>No urogenital sinus; one genital pore.</p> <p>Ova large and oval, with attaching threads; meroblastic in <i>Bdellostoma</i>. Development unknown in <i>Myxine</i>; direct in <i>Bdellostoma</i>.</p>	<p>In rivers and seas. Two unpaired dorsal fins. Sensory structures in the complex, slimy, pigmented skin. No barbules (except in the larva), but lips, and many teeth.</p> <p>Skull very imperfectly roofed. Hints of vertebral arches. Cartilaginous basket-work around gill-pouches. All the usual parts of the brain are distinct. Eyes hidden and retarded in the larva, exposed and complete in adult. Ear with two semicircular canals. Nasal sac ends blindly.</p> <p>Seven pairs of gill-pouches, opening directly to the exterior, less directly into the adult gullet.</p> <p>A slight spiral fold in the intestine.</p> <p>A urogenital sinus, and two genital pores.</p> <p>Ova small and spherical; holoblastic. Development with metamorphosis.</p>

Lampreys are distributed in the rivers and seas of north and south temperate regions. They are often used as food. Besides *Petromyzon* there are several related genera, e.g. *Mordacia* and *Geotria*, from the coasts of Chili and Australia, and *Ichthyomyzon*, from the west coast of N. America. Certain structures called "conodonts," from very ancient (Silurian) strata, have been interpreted as teeth of lampreys or hags.

Palæospondylus gunni.—Under this title Dr. Traquair has described a very remarkable fossil form from the Old Red Sandstone of Caithness. He speaks of it as a "strange relic of early vertebrate life."

It is a dainty little creature, somewhat tadpole-like at first sight, usually under an inch in length. The following characters point strongly to its affinities with Cyclostomata :—

(1) "The skull is apparently formed of calcified cartilage, and devoid of discrete ossifications." An anterior part is comparable to the trabecular and palatal region of a lamprey's skull; a posterior part is comparable to the parachordal region and auditory capsules.

(2) "There is a median opening or ring, surrounded with cirri, and presumably nasal, in the front of the head" (Fig. 278, *n.*).

(3) "There are neither jaws nor limbs."

(4) "The rays which support the caudal fin expansion, apparently springing from the neural and hæmal arches, are dichotomised (at least the neural ones), as are the corresponding rods in the lamprey."

Just behind the head lie two small oblong plates (Fig. 278, *x.*), closely apposed to the commencement of the vertebral column, one on each side. The notochordal sheath is calcified in the form of ring-shaped or hollow verte-

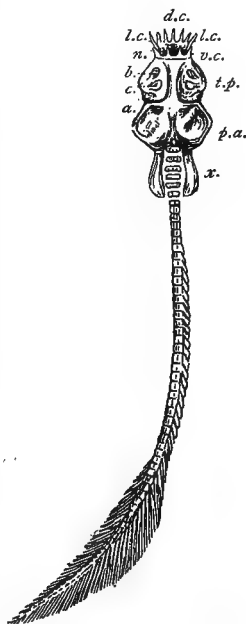

FIG. 278.—Restored skeleton of *Palæospondylus gunni*.—After Traquair.

d.c., Cirri of dorsal margin; *l.c.*, long lateral cirri; *v.c.*, cirri of ventral margin; *n.*, nasal ring; *t.p.*, anterior trabeculo-palatine part of cranium; *b.*, anterior depression or fenestra; *c.*, posterior depression or fenestra; *a.*, lobe divided off from anterior part; *p.a.*, posterior or parachordal part of cranium; *x.*, post-occipital plates.

bral centra with neural arches. Towards the tail the arches are produced into slender neural spines, opposite which are shorter hæmal ones.

Class HYPOSTOMATA or OSTRACODERMI

Extinct forms without jaws, without a segmented axial skeleton in the trunk, without any trace of girdles, with complex dermal armature,

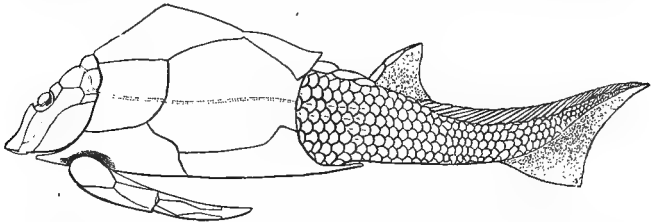

FIG. 279.—*Pterichthys milleri*. Lateral view.—Restored by Traquair.

with a head shield; Silurian and Devonian, e.g. *Pteraspis* and *Cephalaspis*, both without paired limbs; and *Pterichthys* and *Bothriolepis*, with strange armoured paddles (probably not limbs in the ordinary sense) fixed to the antero-lateral angles of the body-shield. Their systematic position is very doubtful. They are the oldest known Vertebrates.

CHAPTER XXII

CLASS PISCES—FISHES

Sub-Class I. ELASMOBRANCHII :—

Order Plagiostomi (skates and sharks).

Order Holocephali (*Chimera* and *Callorhynchus*).

Several extinct orders, *e.g.* Acanthodei.

Sub-Class II. TELEOSTOMI :—

Order Crossopterygii (*Polypterus*).

Order Chondrostei, *e.g.* sturgeon.

Order Holostei, *e.g.* bony pike.

Order Teleostei, the great majority of living fishes.

Sub-Class III. DIPNOI :—

Ceratodus, *Protopterus*, and *Lepidosiren*, and many extinct forms.

FISHES form the first markedly successful class of Vertebrates. For though the Tunicates are numerous, most of them are degenerate; the level attained by the lancelets is represented by, at most, two or three closely related genera; and the Cyclostomes are also few in number.

In the possession of a vertebrate axis and central nervous system, in the general integration of their structure, and in their great fecundity, Fishes have an easy pre-eminence over their Invertebrate inferiors. With their typically wedge-like bodies, supple muscular tails, fin-like limbs, and the like—they are well adapted to the medium in which they live.

Their success may be read in the immense number of individuals, species, and genera, not only now, but in the past; in the geological record which shows how the cartilaginous Elasmobranchs have persisted strongly from Silurian ages, or how the mysterious decadence of the "Ganoids" has been followed by a yet richer predominance of the modern Bony Fishes; and, furthermore, in

the plasticity with which many types appear to have assumed particular specialisations, such as the lungs of Dipnoi, which point forward to the epoch-making transition from water to dry land.

GENERAL CHARACTERS

Fishes are aquatic Vertebrates, breathing by gills,—vascular outgrowths of the pharynx, bordering gill-clefts and supported by gill-arches. In Dipnoi a single or double outgrowth from the gut—the air- or swim-bladder—functions as a lung, air being inspired at the surface of the water. In most Teleostomes the same structure is present, but though occasionally of some use in respiration, is typically hydrostatic.

Two pairs of non-digitate limbs, i.e. in the form of fins, are usually present, and there are also unpaired median fins, supported by dermal fin-rays (dermotrichia). There are two chief types of paired fin, but no hint of the pentadactyl type of higher Vertebrates. In Dipnoi, and in some extinct forms, the fin has a median segmented axis, which (e.g. Ceratodus) bears on each side a series of radial pieces. In other fishes the radials diverge outwards on one side from several basal pieces, and there is no median axis.

The skin usually bears numerous scales, mainly or wholly due to the dermis, but covered by a layer of epidermis, which may produce enamel. They vary greatly in form and texture, are suppressed in electric fishes, and rudimentary in eels and some other forms. Numerous glandular cells occur in the skin, but these are not compacted into multicellular glands, except in Dipnoi and a few poisonous fishes. The skin also bears sensory structures, usually aggregated on the head, and arranged in one or more "lateral lines" along the trunk. There are no muscular elements in the dermis. The muscle segments or myotomes persist as such in adult life.

In many the gut ends in a cloaca, in others a distinct anus lies in front of the genital and urinary aperture, or apertures. The nostrils are paired, and do not communicate with the mouth by posterior nares; they are exclusively olfactory organs. There is no tympanic cavity or tympanum, or ear-ossicles.*

The heart is two-chambered, and contains only venous

blood, except in the Dipnoi, where it shows hints of becoming three-chambered, and receives pure blood from the lungs as well as impure blood from the body. Apart from the Dipnoi, the heart has a single auricle receiving impure blood from the body, and a ventricle which drives this through a ventral aorta to the gills, whence the purified blood flows to the head and by a dorsal aorta to the body. In addition to the two essential chambers of the heart, there is a sinus venosus, which serves as a porch to the auricle, and there is often a muscular conus arteriosus in front of the ventricle, or a bulbus arteriosus at the base of the ventral aorta. Except in Dipnoi, there is no vein which resembles what is known in all higher Vertebrates as the inferior vena cava, i.e. a single vessel receiving hepatic veins from the liver, renal veins from the kidneys, and others from the posterior region. Its place is taken by paired posterior cardinals. The kidney is usually a persistent mesonephros.

There is no distinct indication of an outgrowth from the hind end of the gut comparable to that which forms the bladder of Amphibians or the allantois of higher Vertebrates.

Most fishes lay eggs which are fertilised in the water.

Compared with Cyclostomes, the true fishes show a distinct advance. Thus we may note—the jaws formed from the first visceral arch, the limbs, the dermal exoskeleton of scales, the frequent occurrence of bone, the true teeth, the paired nostrils, the three semicircular canals, the renal-portal system, the spleen, and the genital ducts.

First type of FISHES. The Skate (*Raja*)—one of the Elasmobranchii

The smooth skate (*R. batis*), the thornback (*R. clavata*), and the ray (*R. maculata*), and other species, are common off British coasts. They are very voracious fishes, and live on the bottom at considerable depths.

External characters.—The body is flattened from above downwards or dorso-ventrally, unlike that of the bony flat-fishes, such as plaice and flounder, which are flattened from side to side. The skate rests on its ventral surface, the flounder on its side. The triangular snout, the broad pectoral fins, the long tail with small unpaired fins, are

obvious features. On the dorsal surface the skin is pigmented and studded with placoid scales; on the top of the skull there are two unroofed areas or fontanelles; numerous jointed radials support the pectoral fins. Behind the lidless eyes are the spiracles—the first of the obvious gill-slits, opening dorsally, containing a rudimentary gill, and communicating posteriorly with the mouth cavity. On the ventral surface are seen the sensory mucus canals, the transverse mouth, and the nostrils incompletely separated from it, as if in double harelip, the five pairs of gill apertures, the cloacal aperture and two abdominal pores beside it. Pectoral and pelvic girdles support the fore- and hind-fins. In the male the hind-fins are in part modified into complex copulatory “claspers.”

The skin.—On the dorsal pigmented surface, embedded in the dermis, there are many “skin-teeth,” or “dermal denticles,” or “placoid scales.” Each is based in bone, cored with dentine or ivory, tipped with enamel. The enamel is mainly, if not wholly, due to the ectoderm (epidermis), the rest to the mesoderm (dermis); the whole arises as a skin papilla. The enamel is practically inorganic, the cells having been replaced by lime-salts; dentine has 34 per cent. of organic matter (apart from water); the bone is more obvious cellular tissue. On the ventral unpigmented or less pigmented surface there are numerous mucus canals or jelly tubes, sensory in function. Some are also present on the dorsal aspect, especially about the head. Most of the slime exudes from glandular goblet cells in the epidermis.

Muscular system.—In the posterior part of the body and in the tail, the segmental arrangement of the muscles may be recognised. The large muscles which work the jaws are noteworthy. Professor Cossar Ewart has described a small electric organ in the tail region of *Raja batis* and *R. clavata*, apparently too small to be of any use, probably incipient rather than vestigial.

Electric organs are best developed in two Teleostean fishes—a S. American eel (*Gymnotus*) and an African Siluroid (*Malapterurus*), and in the Elasmobranch *Torpedo*. In *Gymnotus* they lie ventrally along the tail, in *Malapterurus* they extend as a sheath around the body, and in *Torpedo* they lie on each side of the head, between the gills and the anterior part of the pectoral fin. In other cases where they are

slightly developed (certain Elasmobranchs and Teleosteans), they lie in the tail. Separated from one another by connective tissue partitions are numerous "electric plates," which consist of strangely modified muscle substance and numerous nerve-endings. The electric discharge is very distinct in the three forms noted above, and is controlled in some measure at least by the animal.

The skeleton.—The skeleton is for the most part cartilaginous, but here and there ossification has begun, as a crust over many parts, more deeply in the vertebræ, teeth, and scales.

The vertebral column consists of an anterior plate not divided into vertebræ, and of a posterior series of distinct vertebræ. Each of these has a biconcave or amphicœlous centrum. From each side of the centrum a transverse process projects outwards, and bears a minute hint of a rib. From the dorsal surface of each centrum two neural processes arise. Between each two vertebræ there is at each side a broad interneural plate, which not only fills what would be a gap between the neural processes and the slightly developed neural spine, but also links the vertebræ together. In the caudal vertebræ, what seem to be the transverse processes are directed downwards to form a hæmal arch enclosing the caudal artery and vein. In the lozenge-shaped spaces between the vertebræ lie gelatinous remains of the notochord.

In Selachians and Dipnoi amoeboid cartilage cells from the arcualia (paired nodules of cartilage in the mesenchyme or embryonic connective tissue outside the sheath of the notochord, which form neural and hæmal arches) migrate into the sheath of the notochord and convert it into a cylinder of cartilage (segmented into centra in Selachians). This is called a *chordacentrous* vertebral column. In Teleostomes and higher Vertebrates, the expanded bases of the arcualia fuse to form cartilaginous (eventually bony) centra, outside the sheath of the notochord. This is called an *arcicentrous* vertebral column.

The skull is a cartilaginous case, with a spacious cavity for the brain, a large posterior aperture or foramen magnum through which the spinal cord passes, two condyles working on the end of the vertebral plate, a large ear capsule on each side posteriorly, a similar nasal capsule on each side anteriorly, a long rostrum in front, two fontanelles on the roof. Compared with the skull of a cod or of a higher Vertebrate, that of a skate is simple; it is not ossified, nor divided into distinct regions, nor has it anything corresponding to the investing membrane bones, which in higher animals are added to the original foundations of the skull, nor do the visceral arches in the skate take part in forming the skull, which arises, as usual, from parachordals, trabeculæ, sense capsules, etc.

The visceral arches are primitively supports for the

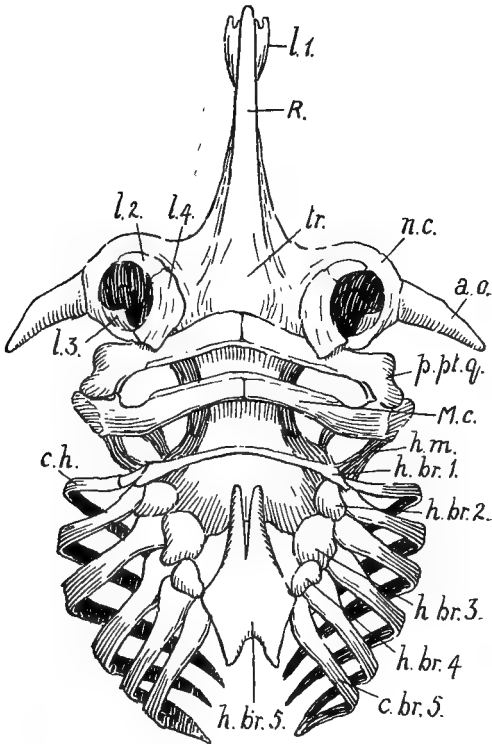

FIG. 280.—Under surface of skull and arches of skate.—After W. K. Parker.

l.1, First labial cartilage; *R.*, rostrum; *tr.*, trabecular region; *n.c.*, nasal capsule; *a.o.*, antorbital cartilage; *p.pt.q.*, palato-ptyergo-quadrate; *M.c.*, Meckel's cartilage; *h.m.*, hyo-mandibular; *h.br.1-5*, hypobranchials; *c.br.5*, fifth ceratobranchial; *c.h.*, cerato-hyal; *l.2-4*, labial cartilages.

wall of the anterior part of the food canal, but the first two of them are much modified in connection with the jaws.

The upper jaw of the skate is a strong transverse bar, formed from the union of two palato-ptyergo-quadrates. The lower jaw is a similar bar formed from the union of two Meckel's cartilages.

From the ear capsule to the articulation of upper and lower jaw there extends on each side a club-shaped cartilage, which connects the jaws with the skull, known as the hyo-mandibular or suspensorium. It is the upper half of the second arch. Attached to it is a slender four-jointed rod—the lower half of the hyoid arch.

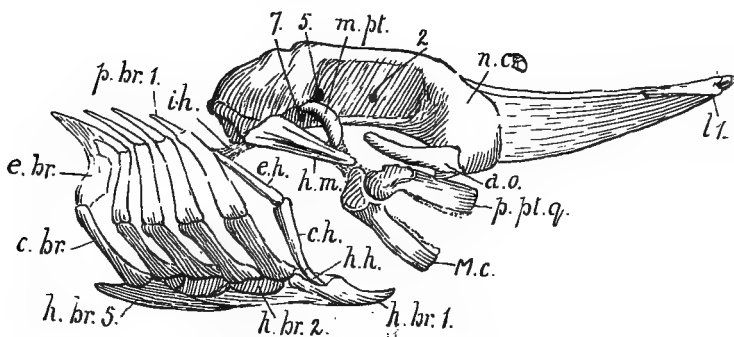

FIG. 281. —Side view of skate's skull.

—After W. K. Parker.

lx., First labial cartilage; *n.c.*, nasal capsule; *a.o.*, antorbital; *p.pt.q.*, palato-ptyergo-quadrates; *M.c.*, Meckel's cartilage; *h.m.*, hyo-mandibular; *e.h.*, epi-hyal; *c.h.*, cerato-hyal; *h.h.*, hypo-hyal; *h.br. 1-5*, hypobranchials; *c.br.*, ceratobranchial; *e.br.*, epibranchial; *p.br. 1.*, first prebranchial; *i.h.*, inter-hyal; *m.pt.*, meta-ptyergoid; 2, 5, 7, foramina of exit of the corresponding nerves.

Then follow five branchial arches, each primarily four-jointed, forming the framework of the gill-bearing region.

Of less importance are the labial cartilages about each nasal capsule, an antorbital cartilage uniting the nasal capsule with the end of the pectoral fin, and a spiracular or meta-ptyergoid cartilage supporting the rudimentary gill in the spiracle.

The pectoral girdle forms an almost complete hoop of

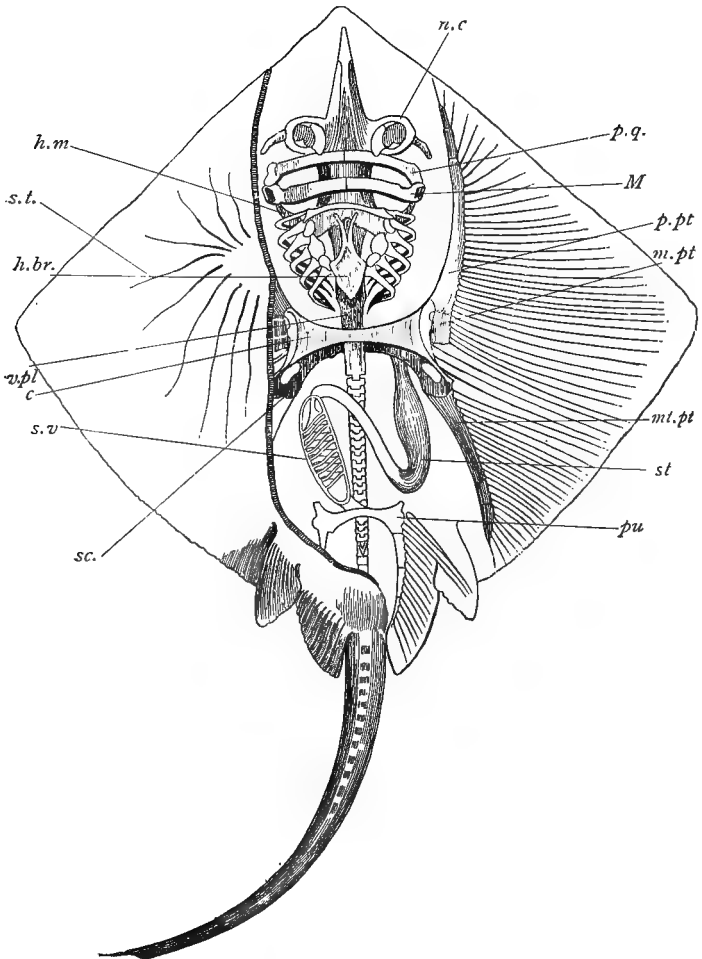

FIG. 282.—Skeleton of skate.—From a preparation.

In the skull notice the anterior rostrum, the nasal capsules (*n.c.*) with the antorbital cartilages projecting laterally; the palatopterygoquadrate cartilage (*p.q.*) or upper jaw; Meckel's

cartilage attached dorsally to the crest of the vertebral plate. The ventral region is distinguished as the coracoid, and is separated from the dorsal or scapular region by three facets, to which the three basal pieces of the pectoral fin are fixed. A separated portion of the girdle forms the supra-scapula, which connects the scapula with the crest of the vertebral plate.

Of the three basal pieces of the fin, the anterior or propterygium and the posterior or metapterygium are large, the median or mesopterygium is small. All bear jointed radials, which are parts of the endoskeleton; a few radials articulate directly with the shoulder-girdle (see Fig. 282). The true fin-rays, comparable to the dermal rays in the fins of Bony Fishes, are represented by "horny" (or, more strictly, elastoidin) fibres. These are intercellular products of mesoderm (mesenchyme) cells.

The pelvic girdle is simpler than the pectoral, and is not fixed to the vertebral column. Its dorsal region is prolonged into an iliac process, while anteriorly a prepubic process projects from the ventral (pubic) bar. The girdle bears two articulating facets, to the posterior of which the strong basal piece or metapterygium of the hind-limb is attached. From this, and from the anterior facet of the girdle, the jointed radials proceed. The claspers of the males are closely connected with the posterior part of the hind-limb, and have a complex cartilaginous skeleton and an associated gland.

The brain.—The brain (see p. 483) has the following parts:—

1. The fused cerebral hemispheres or prosencephalon, with a nervous roof, and without ventricles.

cartilage (*M.*) forming the lower jaw; and the hyo-mandibular (*h.m.*) which suspends the jaws to the skull. A little farther back are seen the five branchial arches and the anterior hyoid arch; *h.br.*, the fifth hypobranchial; *v.pl.*, the vertebral plate. At the right is seen the skeleton of the paired fins, at the left the surface of the skin with the sensory tubes (*s.t.*); *sc.*, the scapular region of the shoulder-girdle, with the scapular fontanelle; *c.*, the coracoid region; *p.pl.*, the anterior basal cartilage or pro-ptyerygium; *m.pl.*, the meso-ptyerygium; *mt.pl.*, the meta-ptyerygium—all three bear jointed radials, while a few, as shown here, articulate directly with the shoulder-girdle; *pu.*, pubic bar of pelvic girdle; *st.*, stomach; *s.v.*, spiral valve of intestine.

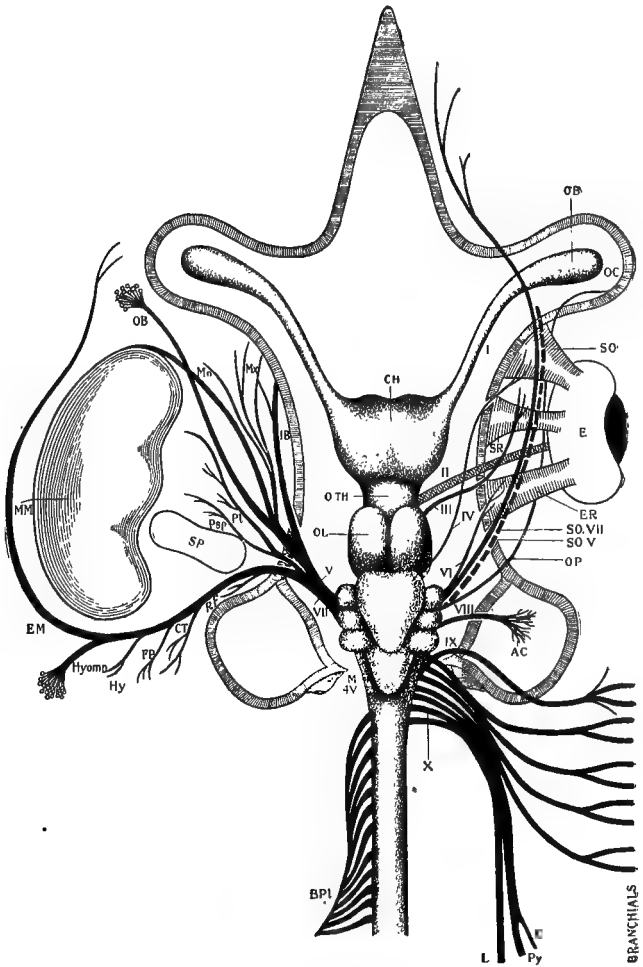

FIG. 283.—Dissection of nerves of skate.

CH., Cerebral hemispheres; O.T.H., optic thalami; O.L., optic lobes; M., medulla; 4V., posterior part of cerebellum, covering

2. The thalamencephalon or region of the optic thalami, with a thread-like pineal body above, infundibulum and pituitary body below, thinly roofed third ventricle within.
3. The mesencephalon or mid-brain, with the optic lobes above, the crura cerebri below, the iter passing between.
4. The cerebellum, with an anterior and a posterior lobe, both marked by ridges and grooves.
5. The medulla oblongata, with thin vascular roof, with dorso-lateral extensions called "restiform bodies."

The region beneath the thalamencephalon bears—(a) two ovoid inferior lobes; (b) the infundibulum, which carries the pituitary body; and (c) a thin-walled three-lobed saccus vasculosus, situated between the pituitary body and the inferior lobes.

Cranial nerves.¹—Owing to the flat form of the skate and its frequently large size, the dissection of the cranial nerves is perhaps easier than in any other Vertebrate. Expecting practical verification, we shall describe their distribution in some detail, following in regard to certain points the investigations of Professor Cossar Ewart.

- I. The *olfactory*, rising from the olfactory lobes of the cerebral hemispheres, extend to the nostrils, and there expand in olfactory bulbs, which give off small nerves to the nostrils.
- II. The *optic*, leaving the region of the optic thalami, cross in an optic chiasma, and extend to the retina of the eye.
- III. The *oculomotor* or *ciliary*, arising from the crura cerebri, near the mid-ventral line, supply four of the six muscles of the eye. There is a ciliary ganglion in connection with III.; and also with the ganglion of the ophthalmicus profundus.

¹ I have to acknowledge indebtedness to Dr. Beard for his kindness in helping me to state the distribution of these nerves.

fourth ventricle; OB., olfactory bulb; OC., olfactory capsule; SO., superior oblique muscle; E., eye; SR., superior rectus; ER., external rectus; SO.VII., superficial ophthalmic branch of VII.; SO.V., superficial ophthalmic branch of V.; OP., ophthalmicus profundus; A.C., auditory capsule; B.Pl., brachial plexus; R.F., recurrent facial; C.T., chorda tympani; F.P., facial proper; Hy., hyoidean; Hyomn., hyomandibular; E.M., external mandibular; M.M., mandibular muscle; Sp., spiracle; P.sp., prespiracular; Pl., palatine; O.B., outer buccal; Mn., mandibular; Mx., maxillary; I.B., inner buccal; L., lateral branch of X.; Py., pyloric branch; C., cardiac branch.

IV. The *pathetic* or *trochlear* are small nerves emerging dorsally from between the mid- and hind- brain, and supplying the superior oblique muscles of the eye.

V. The *trigeminal*, or nerve of the "mouth-cleft," arising from the medulla oblongata (as do all that follow), has a (Gasserian) ganglion on its root, and three main branches—the sensory *maxillary*, which unites with the inner buccal of VII.; the motor *mandibular*, which innervates the muscles of the jaws; and the sensory *superficial ophthalmic* (or orbitonasal), which runs over the eye to the snout, closely united (inside the same sheath) with a similar branch of VII.

Parallel to these superficial ophthalmics, internal to and above the inner buccal of VII., there is a ganglionated *ophthalmicus profundus*, which sends branches to the eyeball, snout, etc.

VI. The *abducens*, a slender nerve, arising near the mid-ventral line, adjacent to V. and VIII., and hidden beneath the former, supplies the external rectus muscle of the eye.

VII. The *facial*, the nerve of the spiracular cleft, supplies all the five groups of ampullæ on the head, and has numerous branches.

1. The *ophthalmicus superficialis* runs over and past the eye, in intimate association with the similar branch of V., and supplies ampullæ on the snout.
2. The inner buccal runs under the eye, through the nasal capsule, to inner buccal ampullæ. The outer buccal runs under the eye, external to the olfactory capsule, to outer buccal ampullæ.
3. The large *hyomandibular* runs directly outwards behind the spiracle to hyoid ampullæ. It gives off minor *hyoidean* nerves.
4. The external *mandibular* runs behind and outside of the mandibular muscle to mandibular ampullæ, and is a branch of the *hyo-mandibular*.
5. The *palatine* descends in front of the spiracle to the roof of the mouth. Close beside it there is a *prespiracular*.

6. The "facial proper," apparently arising from 3, supplies the muscles of the hyoid arch.
7. The "chorda tympani," apparently arising from 3, runs under the spiracle to the inner side of the jaw.

With the loss of the sensory ampullæ, the seventh nerve of higher Vertebrates becomes restricted to the last three branches (5, 6, and 7).

A recurrent branch of the facial also runs external to the auditory capsule to IX., and is equivalent to Jacobson's anastomosis in higher forms.

VIII. The *auditory*, arising just behind VII., is the nerve of the ear.

IX. The *glossopharyngeal*, the most typical of all, is the nerve of the first functional gill-cleft. Its root passes through the floor of the auditory capsule, and bears a ganglion above the cleft. Its branches, as named by Beard, are:—

1. Post-branchial, to the muscles of the first branchial arch;
2. Præ-branchial, arches over the cleft and runs along its front wall;
3. Intestinal or visceral, to the pharynx;
4. Supra-branchial or dorsal, to a few sense organs on the mid-dorsal line of the head.

X. The *vagus*, apparently made up of several cranial nerves, has numerous roots, and divides into six main ganglionated portions, which supply the four posterior clefts and arches, the posterior jelly-tubes, and the heart and stomach. It thus consists of:—

1. Ganglionated roots with nerves to the clefts and arches (2 to 5 inclusive), with post-branchial, præ-branchial, and pharyngeal branches as in IX.
2. A ganglionated root, arising in front of all the others, from which arises the lateral branch innervating all the posterior sensory tubes.
3. From the fourth branchial branch arises the ganglionated intestinal which innervates the heart and the stomach.

The spinal cord lies in the cartilaginous neural archway above the vertebral column, is divided by deep dorsal and ventral fissures, and gives off numerous spinal nerves, formed as usual from the union of dorsal (sensory) and

ventral (motor) roots. The first sixteen or eighteen nerves form the brachial plexus, which supplies the pectoral fin.

The sympathetic system consists of a longitudinal ganglionated cord along each side of the vertebral column.

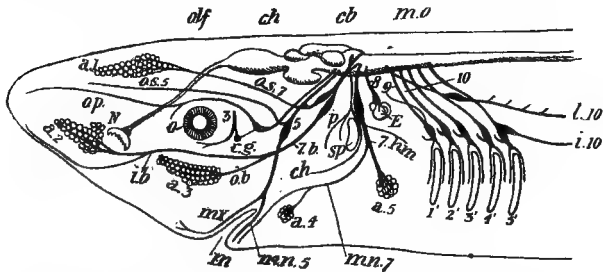

FIG. 284.—Side view of chief cranial nerves of Elasmobranchs.
—Slightly modified from Cossar Ewart.

olf., Over olfactory nerve; *ch.*, over cerebral hemispheres; *cb.*, over cerebellum; *m.o.*, over medulla oblongata; *m.*, mouth; *mx.*, maxillary branch of 5; *mn.5*, mandibular branch of 5; *mn.7*, mandibular branch of seventh nerve; *a.1-5*, groups of ampullæ; *o.s.5*, superficial ophthalmic of 5; *o.p.*, ophthalmicus profundus; *o.s.7*, superficial ophthalmic of 7; *N.*, nostril; 3, oculomotor; *c.g.*, ciliary ganglion; 5, trigeminal; *i.b.*, inner buccal; *o.b.*, outer buccal; *7.b.*, buccal of 7; *p.*, palata of 7; *sp.*, spiracle; *ch.*, chorda tympani; *7.hm.*, hyomandibular of 7; 8, auditory; *E.*, ear; *o.*, glossopharyngeal; 10, roots of vagus; *l.10*, lateral nerve of vagus; *i.10*, intestinal nerve of vagus; 1'-5', gill-clefts.

Sense organs.—

- (a) The eyes (see p. 495). The iris has a fringed upper margin.
- (b) The ears (see p. 493). The vestibule is connected with the surface by a delicate canal—the aqueductus vestibuli—a remnant of the original invagination. A small part of the wall of the auditory capsule is covered only by the skin, forming a kind of tympanum. Within the vestibule are calcareous otolithic particles surrounded by a jelly.
- (c) The nasal sacs are cup-like cavities with plaited walls.
- (d) The sensory tubes are best seen on the ventral surface, where they lie just under the skin. At their internal ends lie ampullæ, containing sensory cells. At their outer ends there are pores. It is probable that they are organs partly of touch, and partly of "chemical sense."

Alimentary system.—The mouth is a transverse aperture; the teeth borne by the jaws are numerous, and those worn away in front are replaced by fresh ones from behind; naso-

buccal grooves connect the nostrils with the corners of the mouth; the spiracles, which open dorsally behind the eyes, communicate with the buccal cavity; from the gullet five gill-clefts open ventrally on each side. The stomach, lying to the left, is bent upon itself; the large brownish liver is trilobed, and has an associated gall-bladder, from which the bile-duct extends to the duodenum—the part of the gut immediately succeeding the stomach; the whitish pancreas lies at the end of the duodenal loop, and its duct opens opposite the bile-duct. The intestine is exceedingly short, but it contains an internal spiral fold—which greatly increases the absorptive surface.

The development of this spiral intestine is of general interest. The well-nourished gut grows quickly, but its increase in calibre is hindered by the peritoneal mesodermic sheath, and the growth is expressed in an internal invagination or fold. But as the growth continues in length as well as in calibre, and as the gut is fixed at both ends, twisting or coiling or both must result. In Mammals, for instance, the result is a coiled intestine. But in Elasmobranch fishes the coiling or twisting takes place *within* the peritoneal sheath, not along with it. In the case of the skate and some other Elasmobranchs, close twisting occurs, and the so-called spiral valve is mainly due to the fusion of the walls of adjacent twists.

A small "rectal gland" of unknown significance arises as a vascular diverticulum from the end of the gut. The end of the gullet and the anterior portion of the stomach and the rectum are supported by folds of peritoneum,—the membrane which lines the body cavity; the rest of the gut lies freely. Rectum, ureters, and genital ducts all communicate with the exterior through the common terminal chamber or cloaca. An abdominal pore opens on each side of the cloacal aperture, and puts the body cavity in direct communication with the exterior. Excepting mouth cavity and cloaca, the gut is lined by endoderm.

Respiratory system.—The first apparent gill-clefts—the spiracles—open dorsally behind the eyes. Each contains a rudimentary gill on the anterior wall, supported by a



FIG. 285.—Spiral valve of skate.
—After T. J. Parker.

spiracular cartilage. Through the spiracles water may enter or leave the mouth.

There are other five pairs of gill-clefts, separated by complete partitions (Elasmobranch), and with ventral apertures. The first is bounded anteriorly by the hyoid arch, posteriorly by the first branchial arch. The hyoid bears branchial filaments on its posterior surface; the first four branchials bear gill filaments on both surfaces; the fifth branchial bears none. Each set of branchial filaments is called a half-gill; and as the first four branchial arches bear a half-gill on

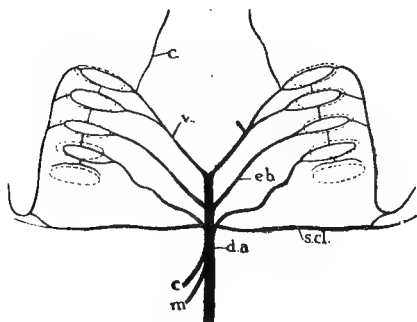

FIG. 286.—Upper part of the dorsal aorta in the skate.
—After Monro.

d.a., Dorsal aorta; *c.*, coeliac artery; *m.*, superior mesenteric;
s.c.l., subclavian; *e.b.*, efferent branchial vessels, three formed
from the union of nine; *v.*, vertebral; *c.*, carotid.

each side, and the hyoid arch a half on its posterior surface, there are four and a half gills in all. There is no operculum or gill cover.

Circulatory system.—The impure blood from the body enters the heart by a bow-shaped sinus venosus, opening into a large thin-walled auricle. Thence through a bivalved aperture the blood passes into the smaller muscular ventricle, and from this it is driven through a contractile conus arteriosus, with three longitudinal rows of five valves, into the ventral aorta.

The ventral aorta gives off a pair of posterior innominate arteries, which take blood to the three posterior gills, and a pair of anterior innominate arteries, which supply the anterior gill and the hyoid half-gill on each side.

The purified blood passes from each half-gill by an efferent branchial artery. To begin with, there are nine of these on each side, but by union they are reduced first to four and then to three efferent trunks, which combine to form the dorsal aorta.

From the efferent branchial of the hyoid arch a carotid arises, which divides into internal and external branches supplying the brain and head. The two internal carotids unite, and pass through a small hole

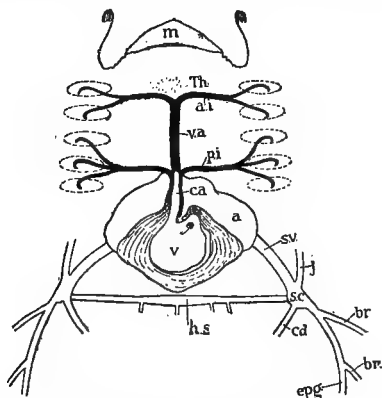

FIG. 287.—Heart and adjacent vessels of skate.—In part after Monro.

v., Ventricle; *c.a.*, conus arteriosus; *p.i.*, posterior innominate; *v.a.*, ventral aorta; *a.i.*, anterior innominate; *Th.*, thyroid; *m.*, mouth; *a.*, auricle; *sv.*, sinus venosus; *sc.*, precaval sinus or sinus of Cuvier; *h.s.*, hepatic sinus; *j.*, jugular; *br.*, brachials; *cd.*, cardinal; *epg.*, epigastric.

on the ventral surface of the skull. Just after the first and second main efferent branches have united, a vertebral is given off, which passes through a hole in the vertebral plate to the spinal cord and brain.

The dorsal aorta gives off—(1) a subclavian to each pectoral fin; (2) a celiac to the stomach, duodenum, and liver; (3) a superior mesenteric to the intestine, pancreas, and spleen; (4) spermatic arteries to the reproductive organs; (5) an inferior mesenteric to the rectum; (6) renal arteries to the kidneys; (7) arteries to the pelvic fins. It ends in the caudal artery.

At each end of the bow-shaped sinus venosus there is a precaval sinus. This receives venous blood as follows:—(a) from the head by

a jugular vein; (*b*) from the liver by a hepatic sinus, which runs from one precaval sinus to the other like the string of the bow; (*c*) from a large posterior cardinal sinus (between the reproductive organs) by a cardinal vein on each side; (*d*) from the hind-fin by an epigastric, with which brachials from the fore-limb unite anteriorly. The great cardinal sinus receives blood from the hind-limbs, the kidneys, and other posterior parts.

Blood passes into the liver (*a*) from the coeliac artery, and (*b*) by portal veins from the intestine (the hepatic portal system); blood leaves the liver by hepatic veins which enter the hepatic sinus.

Blood passes into the kidneys (*a*) from the renal arteries, and (*b*) by renal portal veins from the caudal, pelvic, and lumbar regions (the renal portal system); blood leaves the kidneys by posterior cardinal veins, which enter the cardinal sinus.

Into the precaval sinus there also opens the lymphatic trunk.

The heart lies in a pericardial cavity, which is connected with the abdominal cavity by two fine canals, and is an anterior part of the coelom. The blood contains, as usual, red blood corpuscles and leucocytes.

The dark red spleen lies in the curve of the stomach. The red thyroid gland lies just in front of the anterior end of the ventral aorta. The thymus is represented by a whitish body dorsal to each of the first four gill-clefts. Each begins as a patch of endoderm, and this is invaded by migratory mesenchyme cells which multiply as lymphocytes.

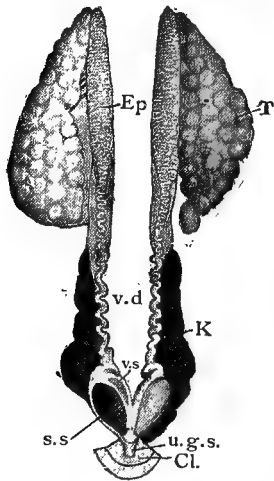

FIG. 288.—Urogenital organs of male skate.

T., Testis; *Ep.*, epididymis; *v.d.*, vas deferens; *K.*, kidney; *v.s.*, seminal vesicle; *s.s.*, sperm sac; *u.g.s.*, urogenital sinus; *Cl.*, cloaca.

Excretory and reproductive systems.—The dark red kidneys lie far back on each side of the vertebral column.

They are developed from the hind part of the mesonephros. Several tubes from each kidney combine to form a ureter. The two ureters of the male open into the urogenital sinus, whence the waste products pass out by the cloaca; in the female they open into little bladders,—the dilated ends of the Wolffian ducts,—and thence by a common aperture into the cloaca.

The segmental duct of each side divides into Wolffian and Müllerian ducts. The Wolffian duct becomes in the male the vas deferens, in the female it is an unimportant Wolffian duct; the Müllerian duct becomes in the female the oviduct, in the male it is a mere rudiment.

The muscles and other organs of Elasmobranchs retain considerable quantities of nitrogenous waste products.

There can be no doubt that the body cavity helps in excretion, and gets rid of waste through the two abdominal pores. In some Elasmobranchs these are replaced by openings (nephrostomes) into the kidney. Occasionally there are both nephrostomes and abdominal pores.

The male organs or testes lie on each side of the cardinal sinus, moored by a fold of peritoneum. Spermatozoa pass from the testis by vasa efferentia into a tube surrounded anteriorly by epididymis. The tube of the epididymis is continued into the vas deferens, which is dilated posteriorly into a seminal vesicle and an adjacent sperm-sac. Finally, the two vasa deferentia open into the urogenital sinus, whence the spermatozoa pass into the cloaca. Thence, in copulation, they pass into the complex "claspers" of the male, which are said to be inserted into the cloaca of the female.

The female organs or ovaries lie on each side of the car-

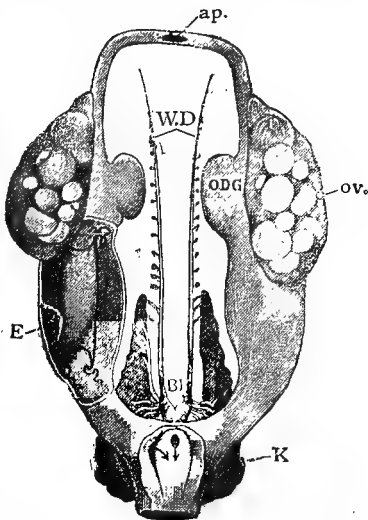

FIG. 289.—Urogenital organs of female skate.—In part after Monro.

ap., Aperture of united oviducts; *W.D.*, Wolffian duct; *ov.*, ovary; *O.D.G.*, oviducal gland; *E.*, egg in mermaid's purse; *Bl.*, bladder at base of Wolffian ducts (arrow into cloaca); *K.*, kidney (arrow from base of oviduct into cloaca).

dinal sinus, moored by a fold of peritoneum. In young skates they are like the young testes, but in the adults they are covered with large Graafian follicles, each containing an ovum. The ripe ova burst into the body cavity, and enter the single aperture of the oviducts, which are united anteriorly just behind the heart. About the middle of each oviduct there is a large oviducal gland, which secretes the horny "purse"; the elastic lower portions open into the cloaca.

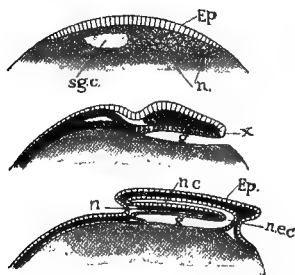

FIG. 290.—Elasmobranch development.—After Balfour.

Uppermost figure shows blastoderm at an early stage. *Ep.*, Epiblast; *sg.c.*, segmentation cavity; *n.*, yolk-nuclei. Middle figure shows the invagination which forms the gut. *x.*, Blastopore; *g.*, archenteron. Mesoderm dark. Lowest figure, a longitudinal section at a later stage. *Ep.*, epiblast; *n.c.*, neural canal; *n.e.c.*, neurenteric canal; *g.*, gut; *n.*, notochord. Mesoderm dark.

are produced into long elastic tendrils, which may twine round seaweed, and thus moor the egg. Rocked by the waves, the embryo develops, and the young skate leaves the purse at one end. Development is very slow, and takes perhaps the greater part of a year. The egg-case of some sharks, e.g. the Port Jackson shark (*Cestracion philippi*), has elastic spiral fringes, and is found securely wedged among the rocks; that of a neighbour species (*C. galeatus*) has reduced spirals ending in a couple of tendrils, which may be 90 in. in length, and serve very effectively to entangle the egg among seaweed.

Development.—The ripe ovum which bursts from the ovary is a large sphere, mostly of yolk, with the formative protoplasm concentrated at one pole.

The formation of polar bodies (maturation) takes place at an early stage. Fertilisation occurs in the upper part of the oviduct. Some observers have described the occurrence of polyspermy.

As the ovum descends farther, it is surrounded first by albuminous material, and then by the four-cornered "mermaid's purse" secreted by the walls of the oviducal gland. This purse is composed of keratin—a common skeletal substance which occurs for instance in hair and nails. Its corners

The segmentation is meroblastic, being confined to the disc of formative protoplasm. From the edge of the

blastoderm, or segmented area, some nuclei (so-called "merocytes") are formed in the outer part of the subjacent yolk (Fig. 290, *n.*). It seems most probable that these are hypoblast elements which assist in the preparation of the yolk for absorption, and eventually degenerate in the empty external yolk-sac.

At the close of segmentation the blastoderm is a lens-shaped disc with two strata of cells. It is thicker at one end—where the embryo begins to be formed. Towards the other end, between the blastoderm and the yolk, lies a segmentation cavity (Fig. 290, *sg.c.*).

At the embryonic end the outer layer or epiblast undergoes a slight invagination (Fig. 290, *x.*), beginning to form the roof of the future gut (*g.*); in other words, establishing the hypoblast. This inflected arc of the blastoderm corresponds to the blastopore or mouth of the gastrula, which is much disguised by the presence of a large quantity of yolk. As the invagination proceeds, the segmentation cavity is obliterated. The floor of the gut is formed by infolding of the lateral walls.

Along the mid-dorsal line of the epiblast a medullary groove appears—the beginning of the central nervous system. Its sides afterwards arch towards one another, and meet to form a medullary canal (Fig. 290, *n.c.*). A posterior communication between this dorsal nervous tube above and the ventral alimentary tube persists for some time as the neurenteric canal (Fig. 290, *ne.c.*).

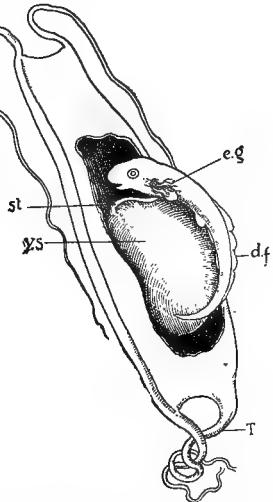

FIG. 291.—Embryo dogfish in egg-case ("mermaid's purse") which has been cut open to show contents.

e.g., "External" gills; *d.f.*, dorsal fin fold; *y.s.*, yolk-sac; *st.*, stalk of yolk-sac; *T.*, tendrils, prolongations of egg-case by means of which it is moored to seaweed, an "adaptation" in a dead substance.

The mesoblast arises as two lateral plates, one on each side of the medullary groove. The plates seem to arise as a pair of solid outgrowths from the wall of the gut. They are afterwards divided into segments. Between the mesoblast plates, along the mid-dorsal line of the gut, the notochord is established (Fig. 290, *n.*).

Besides the internal establishment and differentiation of layers, there are two important processes,—(a) the growth of the blastoderm around the yolk, (b) the folding off of the embryo from the yolk. The result of the two processes is that the yolk is enclosed in a yolk-sac, with which the embryo is finally connected only by a thin stalk—the umbilical cord.

The history of the yolk is briefly as follows:—It is accumulated by the ovum from neighbouring cells, and from the vascular fluid; it is partly prepared for absorption by the merocytes or yolk-nuclei; it is at first absorbed by the blood vessels of the yolk-sac; at a later stage, absorption by blood vessels becomes less and less important, and the yolk passes inside the embryo and into the gut, where it is digested. Then the yolk-sac, empty of all but merocytes, degenerates, shrivels, and disappears.

Second type of FISHES. The Haddock (*Gadus aeglefinus*)
—A type of Teleosteans with closed swim-bladder
(Physoclysti).

Form and external features.—The elongated wedge-like form is well adapted for rapid swimming. The lower jaw bears a short barbule,—long in the cod (*G. morrhua*), absent in the adult whiting (*G. merlangus*). The nostrils, situated near the end of the snout, have double apertures. The eyes are lidless, but covered with transparent skin. Over the gill chamber and the four gills lies the operculum, supported by several bones. Distinct from one another, but closely adjacent, are the anal, genital, and urinary apertures,—named in order from before backwards. Along the sides of the body runs the dark lateral line containing sensory cells. There are three dorsal and two anal fins, and an apparently symmetrical tail fin.

Skin.—The small scales are developed in the dermis, and consist of flexible structureless bone (vitrodentin).

Their free margin is even, a characteristic to which the term cycloid is applied, in contrast to ctenoid, which

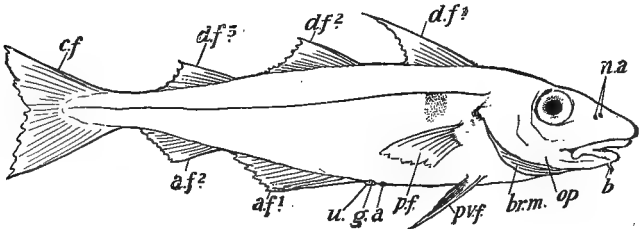

FIG. 292.—The haddock.

- n. a.*, Nasal apertures (double on each side); *d. f. 1, d. f. 2, d. f. 3*, dorsal unpaired fins; *c. f.*, the caudal fin of the homocercal tail.
b., Barbule; *op.*, operculum covering the four gills; *br. m.*, continuation of the gill-cover forming the branchiostegal membrane; *p. v. f.*, pelvic fin (=hind-limb)—note its jugular position in front of *p. f.*, the pectoral fin (=fore-limb).
a., Anus; *g.*, genital aperture; *u.*, urinary aperture; *a. f. 1, a. f. 2*, unpaired anal fins.

describes those scales which have a notched or comb-like

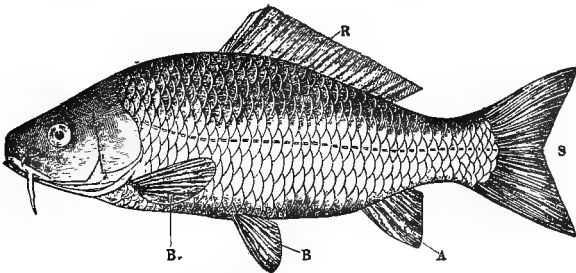

FIG. 293.—External characters of a Teleostean—a carp (*Cyprinus carpio*).—After Leunis.

- R.*, Dorsal unpaired fin; *S.*, homocercal caudal fin; *A.*, anal fin; *B., B.*, pectoral and pelvic paired fins. Note also the lateral line and barbule.

free margin. Over the scales extends a delicate partially pigmented epidermis.

Appendages.—The pectoral fins are attached to the

shoulder-girdle just behind the branchial aperture. The pelvic or ventral fins, attached to what is at most a rudiment of the pelvic girdle, lie below and slightly in front of the pectorals—far from the normal position of hind-limbs.

Muscular system.—The main muscles of the body are disposed in segments,—myotomes or myomeres, separated by partitions of connective tissue. The effective swimming organ is the posterior body and the tail, as contrasted with the pectoral fins in the skate.

Skeleton.—The vertebral column consists of biconcave or amphicœlous bony vertebræ, and is divided into two regions only, caudal and pre-caudal. The spaces between the vertebræ are filled by the remains of the notochord. Each centrum in the trunk region bears superior neural processes, uniting in a neural arch crowned by a neural spine, and transverse processes projecting from each side. Articulated to the distal ends of the transverse processes are the downward curving ribs, and also more delicate intermuscular bones which curve upwards. In the caudal vertebræ (Fig. 294), the centra (*c.*) bear not only superior neural processes (*n.a.*), but also inferior hæmal processes (*h.a.*); they are of course without ribs.

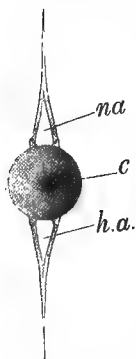

FIG. 294.—Caudal vertebra of haddock.

n.a., Neural arch;
c., centrum;
h.a., hæmal arch.

At the end of the vertebral column lies a fan-shaped hypural bone which helps to support the tail, and is developed from an enlarged hæmal arch. The fin-rays are jointed flexible rods, which in the dorsal and anal fins are attached to the ends of inter-spinous bones alternating with the neural and hæmal spines, and connected with them by fibrous tissue.

The skull includes the following bones, which may be grouped in the following regions (the membrane bones in italics):—

- (a) Around the foramen magnum: basi-occipital, two ex-occipitals, and a *supra-occipital*.
- (b) Along the roof: *supra-occipital*, *parietals*, *frontals*, mesethmoid, *nasals*. Beneath the *parietals* lie the alisphenoids.

- (c) Along the floor: basi-occipital, *parasphenoid*, *vomers*.
 (d) Around the ear on each side: sphenotic, pterotic, and épiotic (above), prootic and opisthotic (beneath).
 (e) In front of and around the orbit: *parethmoid*, *lachrymal*, *orbitals*.

Thus the haddock's skull shows in two respects an ad-

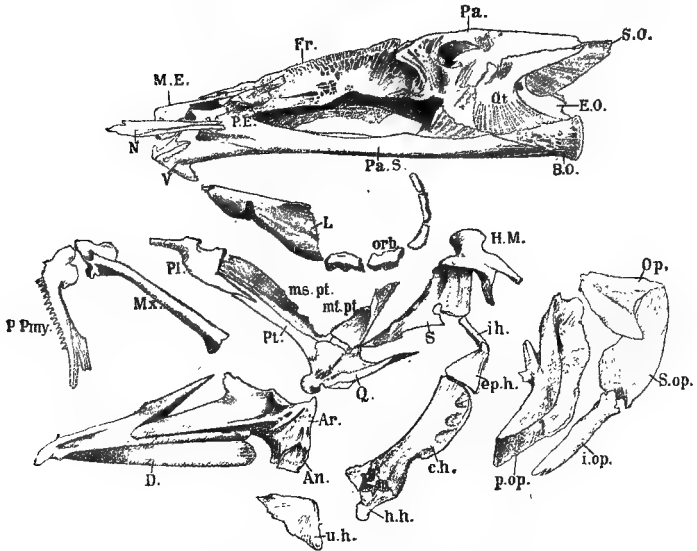

FIG. 295.—Disarticulated skull of cod.

S.O., supra-occipital; *Pa.*, parietal; *Fr.*, frontal; *M.E.*, mesethmoid; *N.*, nasal; *P.E.*, parethmoid; *Oh.*, otics; *E.O.*, ex-occipital; *B.O.*, basi-occipital; *Pa.S.*, parasphenoid; *V.*, vomer; *L.*, lachrymal; *orb.*, orbitals; *H.M.*, hyomandibular; *S.*, symplectic; *Q.*, quadrate; *Pt.*, pterygoid; *mt.pt.*, metapterygoid; *ms.pt.*, mesopterygoid; *Pl.*, palatine; *Mx.*, maxilla; *Pmy.*, premaxilla; *Ar.*, articular; *An.*, angular; *D.*, dentary; *u.h.*, urohyal; *h.h.*, hypohyal; *c.h.*, ceratohyal; *ep.h.*, epihyal; *i.h.*, interhyal; *Op.*, opercular; *S.op.*, sub-opercular; *i.op.*, inter-opercular; *p.op.*, præ-opercular.

vance upon that of the skate: first, in the ossification of the primitive cartilage; and second, in the addition of membrane bones. Of the latter, the parietals and frontals cover over the spaces which in the skate form the fontanelles.

The first or mandibular arch is believed by many to form Meckel's cartilage beneath, and the palato-ptyergo-quadrate cartilage above. Meckel's cartilage becomes the foundation of the lower jaw, and bears a large tooth-bearing membrane bone—the dentary, a small corner bone—the angular, while the articular element is a cartilage bone. Of the bones associated with the upper part, the palatine lies in front, the quadrate articulates with the lower jaw; while between palatine and quadrate lie the pterygoid, the mesopterygoid, and the metapterygoid.

The second or hyoid arch is believed by many to form the hyo-

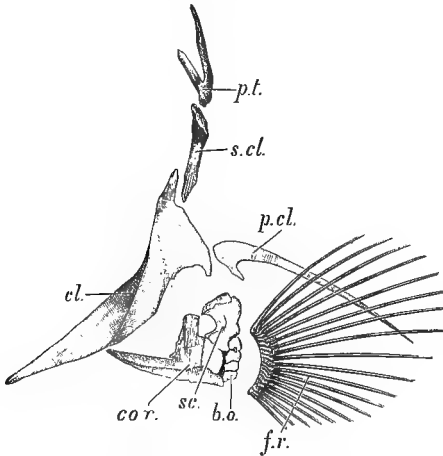

FIG. 296.—Pectoral girdle and fin of cod.

fr., Fin-rays; *b.o.*, brachial ossicles; *cor.*, coracoid; *sc.*, scapula; *cl.*, clavicle; *p.cl.*, post-clavicle; *s.cl.*, supra-clavicle; *p.t.*, post-temporal.

mandibular and the symplectic above, and various hyoid bones beneath. The hyomandibular, and its inferior segment the symplectic, connect the quadrate with the side of the skull. Of the six hyal bones, the largest and most important is the ceratohyal, which bears seven long branchiostegal rays. It is important to note that the bones formed in connection with these arches do not yet form an integral part of the skull.

The toothed premaxilla forms the upper part of the gape, while the maxilla which articulates dorsally with the vomer, and nearly reaches the quadrate posteriorly, does not enter into the gape. Both are membrane bones.

In the opercular fold are four membrane bones.

There are four pairs of complete branchial arches, which are divided into various parts. Of these the most interesting are the two superior pharyngeal bones, which lie in the roof of the pharynx and bear teeth, and are formed by the coalescence of the dorsal elements of the arches. Their teeth bite against those of the inferior pharyngeal bones, which lie on the floor of the pharynx, and represent the fifth branchial arches.

The limbs and girdles.—The dermal rays of the pectoral fin are attached to four small brachial ossicles; these articulate with a dorsal scapula and a more ventral coracoid; both of these are attached to the inner face of a large clavicle or cleithrum, which almost meets its fellow in the mid-ventral line of the throat. From the clavicle a slender post-clavicle extends backwards and downwards; while a stout supra-clavicle extends from the dorsal end of the clavicle upwards to articulate with a forked post-temporal, which articulates with the back of the skull. It must not be assumed that the elements of this girdle are directly comparable to those of a higher Vertebrate, although the nomenclature is the same.

The pelvic girdle seems to be absent, as in almost all Teleostomes, but its place is taken by a thin plate of bone, apparently due to a fusion of some basal elements of the pelvic fins.

Nervous System.—The relatively undifferentiated fore-brain with defective cortical region, the thalamencephalon with its inferior lobes and infundibulum, the large optic lobes, the tongue-shaped cerebellum which conceals most of the medulla oblongata, have their usual general relations. Each of the olfactory nerves is at first double; their bulb-like terminations lie far from the brain behind the nasal sacs. The large optic nerves cross one another *without fusion* at a slight distance from their origin; otherwise the nerves generally resemble those of the skate.

The eyes are large but lidless; the small nasal sacs with plaited walls have double anterior apertures; the vestibule of the ear contains a large solid otolith, and another very small one in a posterior chamber. The dark lateral line, covered over by modified scales, lodges sensory cells, and is innervated by a branch of the vagus.

Alimentary system.—Teeth are borne by the premaxillæ, the vomer, and the superior pharyngeal bones above, by the dentaries and the inferior pharyngeal bones beneath. There are no salivary glands, no spiracles, nor posterior nares. A small non-muscular tongue is supported by a ventral part of the hyoid arch. Five gill-clefts open from the pharynx; their inner margins are fringed by horny gill-

rakers attached to the branchial arches and serving as strainers; they prevent the food from being swept out with the respiratory current. The gullet leads into a curved stomach; at the junction of stomach and duodenum numerous tubular pyloric cæca are given off; into the duodenum opens the bile-duct from the gall-bladder and liver; the coiled intestine passes gradually into the rectum, which has an aperture apart from those of the genital and urinary

ducts. There is no spiral valve, and there are no abdominal pores. A pancreas is absent; perhaps the pyloric cæca take its place. (In some Teleostéans the pancreas, apparently absent, is combined with the liver.) The peritoneum is darkly pigmented.

Respiratory system.—Water that passes in by the mouth may pass out by the gill-clefts; the branchial chamber is also washed by water which passes both in and out under the operculum. The gill-filaments borne on the four anterior branchial arches are long triangular processes, whose free ends form a double row. As there are no partitions between the five gill-clefts, the filaments project freely into the cavity covered by the operculum. On the internal surface of the operculum lies a red patch, the pseudobranch or rudimentary hyoidean gill. Inspiration and taking food into the mouth are associated with the retraction of the hyoid apparatus; expiration and swallowing are associated with the

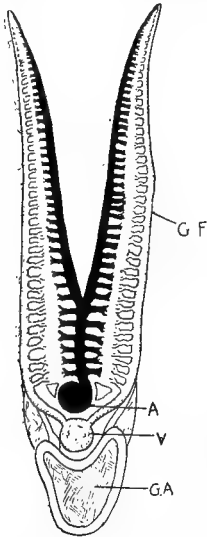

FIG. 297.—Section of a Teleostean gill.

G.F., Gill-filament; *A.*, artery (venous blood); *V.*, vein (pure blood); *G.A.*, gill-arch.

protraction of the hyoid arch. The usual retractor of the lower jaw is absent in Teleosts, and the lowering of the lower jaw comes about automatically in the retraction of the hyoid arch and the raising of the operculum,—in short in the inspiratory phase. A large and quaint parasitic copepod—*Lernæa branchialis*—is often found with its head deeply

buried in the tissues of the gills and head. Many related forms are common on fishes.

The swim-bladder lies along the dorsal wall of the abdomen; the duct which originally connected it with the gut has been closed. The dorsal wall of the bladder is so thin that the kidneys and vertebræ are seen through it; the ventral wall is thick, and bears anteriorly a large vascular network or *rete mirabile*, which receives blood from the mesenteric artery and returns blood to the portal vein.

Circulatory system.—The heart lies within a pericardial chamber, separated by a partition from the abdominal cavity. The blood from the body and liver enters the heart by the sinus venosus, passes into the thin-walled auricle, and thence to the muscular ventricle. From the ventricle it is driven up the ventral aorta, the base of which forms a white non-contractile bulbus arteriosus.

The ventral aorta gives off, on each side, four afferent branchial vessels to the gills. Thence the blood is collected by four efferent trunks, which unite on each side in an epibranchial artery. The two epibranchials are united posteriorly to form the dorsal aorta, while anteriorly they give off the carotids, which are united by a transverse vessel closing the "cephalic circle."

Blood enters the sinus venosus by two vertical precaval veins, and by hepatics from the liver. Each precaval vein is.

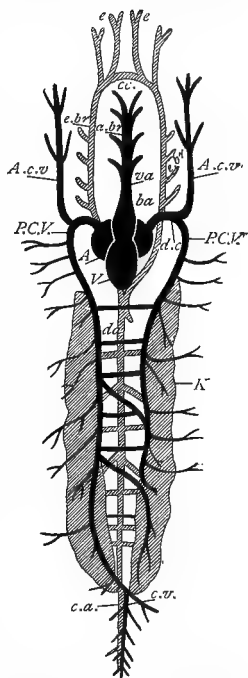

FIG. 298.—Diagram of Teleostean circulation.—After Nuhn.

A., auricle; V., ventricle; b.a., bulbus arteriosus; v.a., ventral aorta; a.br., afferent branchials; e.br., efferent branchials; c.c., cephalic circle; e., carotids; A.c.v., anterior cardinal veins; P.C.V., posterior cardinal veins; d.c., ductus Cuvieri; d.a., dorsal aorta; c.v., caudal vein; c.a., caudal artery; K., kidney.

formed from an anterior cardinal from the head and a posterior cardinal from the body. The posterior cardinals extend along the kidneys, and are continuous with the caudal vein, but the middle part of the left cardinal is obliterated. The circulation of the blood seems to be helped, in some fishes at least, by the respiratory movements and by the muscular contractions in swimming.

Excretory system.—The kidneys are very long bodies, extending above the swim-bladder under the vertebral column. The largest parts lie just in front of and just behind the swim-bladder. From the posterior part an unpaired ureter extends to the urinary aperture, before reaching which it gives off a small bilobed bladder. The pronephros degenerates; the functional kidney is a mesonephros.

Reproductive system.—The testes are long lobed organs, conspicuous in mature males at the breeding season; there is no epididymis. The ovaries of the female are more compact sacs, more posterior in position.

Two vasa deferentia combine in a single canal. The likewise single oviduct is continuous with the cavity of the ovaries. The genital aperture in either sex is in front of, but very close to, that of the ureter. The oviducts of most Teleosts seem to be backward extensions of the ovarian sacs, but they may be disguised Müllerian ducts. In salmonids the eggs are shed into the cœlom, and escape by a pair of pores opening together behind the anus.

Development.—The ova of the haddock, like those of other Teleosteans, contain a considerable quantity of yolk, are fertilised after they have been laid, and undergo meroblastic segmentation. The eggs float, *i.e.* are pelagic; while those of the herring sink, *i.e.* are dimersal.

At one pole of a transparent sphere of yolk lies a disc of formative protoplasm of a light terra-cotta colour. The ovum is surrounded by a firm vitelline membrane. After fertilisation the formative disc divides first into two, then into four, then into many cells, which form the blastoderm. From the edge of the blastoderm certain yolk-nuclei or periblast-nuclei are formed, which afterwards have some importance. At the end of segmentation the blastoderm lies in the form of a doubly convex lens in a shallow concavity of the yolk.

The blastoderm extends for some distance laterally over the yolk; the central part raises itself, and thus forms a closed segmentation

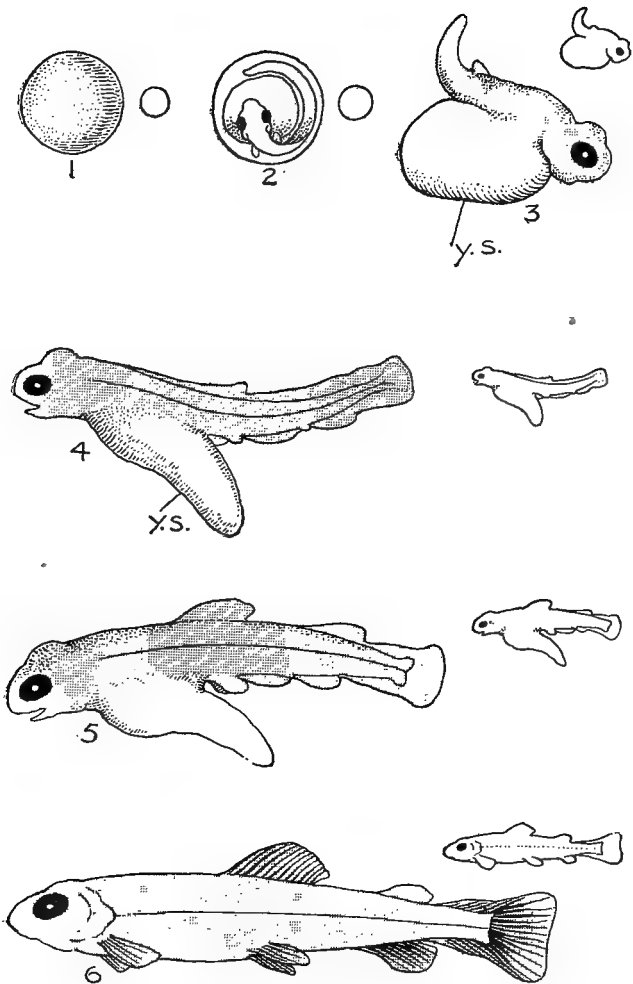

FIG. 299.—The early development of the salmon.

- 1, The fertilised egg; 2, the egg just before hatching; 3, the newly hatched salmon; 4 and 5, the larval salmon nourished from yolk-sac (*y.s.*) which is diminishing while the fish is increasing in size; 6, the salmon with yolk absorbed (about six weeks old). The small figures to the right indicate the actual sizes.

cavity ; one radius of the blastoderm becomes thicker than the rest, and forms the first hint of the embryo ; an inward growth from the edge of the blastoderm forms an invaginated layer—the dorsal hypoblast or roof of the gut ; the periblast forms the floor of the gut, and afterwards aids the mesoblast, which appears between epiblast and hypoblast ; the medullary canal is formed as usual in the dorsal epiblast. It is likely that the edge of the blastoderm represents the blastopore or mouth of the gastrula, much disguised by the presence of yolk.

The newly hatched larva is still mouthless, and lives for awhile on the residue of yolk, which, by its buoyancy, causes the young fish to be suspended in the water back downwards.

GENERAL NOTES ON THE FUNCTIONS, HABITS, AND LIFE HISTORIES OF FISHES

Movement.—A fish may well compare with a bird in its mastery of the medium in which it lives. Thus a salmon travels at the rate of about eight yards in a second, or over sixteen miles an hour. The motion depends mainly on the powerful muscles which produce the lateral strokes of the tail and posterior part of the body. It may be roughly compared to the motion of a boat propelled by an oar from the stern. So energetic are the strokes that a fish is often able to leap from the water to a considerable height. In some cases undulating movements of the unpaired fins, and even the rapid backward outrush of water from under the gill-cover, seem to help in movement. The paired fins are chiefly used in ascending and descending, in steering and balancing. The large pectoral fins of the flying-fish (*Dactylopterus* and *Exocoetus*) are used rather as *parachutes* than as wings during the long skimming leaps.

Shape in relation to habit.—The characteristic form of the body, as seen in herring or trout, is an elongated laterally compressed spindle, thinning off behind like a wedge. In most cases the trunk passes quite gradually into head and tail. This torpedo-like form is well adapted for rapid progression. Flat-fishes, whether flattened from above downwards, like the skate, or from side to side like the plaice and sole, usually live more or less on the bottom ; eel-like forms often wallow in the mud, or creep in and out of crevices ; globe-fishes, like *Diodon* and *Tetrodon*, often float passively.

Colour.—The colours of fishes are often very bright. They depend partly on the presence of pigment cells in the skin, partly on the physical structure of the scales. The common silvery colour is due to small crystals of guanin in the skin. In many cases the colours of the male are brighter than those of his mate, as in the gemmeous dragonet (*Callionymus lyra*) and the stickleback (*Gasterosteus*), and this is especially true at the breeding season. The colours of many fishes change with their surroundings. In the plaice and some others the change is rapid. Surrounding colour affects the eye, the influence passes from eye to brain, and from the brain down the sympathetic nervous system, thence by peripheral nerves to the skin, where the

distribution of the pigment granules in the cells is altered. In shallow and clear water this power of colour-change may be protective, but an appreciation of the protective value of colouring demands careful attention to the habits and habitat of the fishes, to the nature of the light in which they live, and to the enemies which are likely to attack them.

Food.—The food of Fishes is very diverse — from Protozoa to Cetaceans. Sharks and many others are voraciously carnivorous; many engulf worms, crustaceans, insects, molluscs, or other fishes; others browse on seaweeds, or swallow mud for the sake of the living and dead organisms which it contains. Their appetite is often enormous, and cases are known (*e.g.* *Chiasmodon niger*) where a fish has swallowed another larger than its own normal size. Many fishes follow their food by sight; many by a diffuse sensitiveness, to which it is difficult to give a name; a few, it would seem, by a localised sense of smell. It is important to realise that fishes depend very largely on small crustaceans, and these again on unicellular plants and animals. Just as we may say that all flesh is grass, so we may say that all fish is Diatom.

Senses, etc.—Fishes do not seem to have much sense of taste or of smell, but diffuse sensitiveness to touch, chemical stimuli, etc., is well developed, especially on the head and along the lateral line. Though there is no drum, and the ear is deeply buried, a few seem to hear. Some experiments suggest that the semicircular canals of the fish's ear are indispensable in the direction or equilibration of movement. The sense of sight is, on the whole, well developed, and many have "darkness eyes." As to the intellectual powers of their small brains we know little, but many show quickness in perceiving friends or foes, a few give evidence of memory, and many of their instincts are complex. At the breeding season there is sometimes an elaborate expression of excitement, well seen in the stickleback.

Reproduction. — Hermaphroditism is constant in some bony fishes, *e.g.* *Chrysophrys auratus* (dichogamous), and three species of *Serranus* (autogamous); almost constant in *Pagellus mormyrus*; very frequent in *Box salpa* and *Charax puntazzo*; and exceptional in over a score of fishes, such as sturgeon, cod, herring, pike, and carp. The simplicity of the genital organs and their ducts may in part explain why casual hermaphroditism is more frequent in Fishes than in higher Vertebrates. In many cases the males are smaller, brighter, and less numerous than the females. Courtship is illustrated by the sticklebacks (*Gasterosteus*, etc.), the paradise-fish (*Macropodus*), and others; and many male fishes fight with their rivals.

Most fishes lay eggs which are fertilised and develop outside of the body. They may be extruded on gravelly ground, or sown broadcast in the water. Sturgeon, salmon, and some others ascend rivers for spawning purposes, while the eels descend to the sea. In the case of trout, Barfurth has observed that the absence of suitable spawning ground may cause the fish to retain its ova. This results in ovarian disease, and in an inferior brood next season. Except in Elasmobranchs, the ova are relatively small, and large numbers are usually

laid at once. In Elasmobranchs the egg is large, and in the oviparous genera it is enclosed in a "mermaid's purse."

Most sharks and a few Teleosteans, e.g. *Sebastes marinus*, *Zoarcus viviparus*, are viviparous, the eggs being hatched in the lower part of the oviduct in sharks, in the ovary or oviduct in Teleosteans. In two viviparous sharks (*Mustelus laevis* and *Carcharias glaucus*) there is a union between the yolk-sac and the wall of the oviduct, to be compared with a similar occurrence in two lizards, and with the yolk-sac placenta of some Mammals.

As to fertilisation, the usual process is that the male deposits spermatozoa or "milt" upon the laid eggs or "spawn," but fertilisation is of course internal when the eggs are enveloped in a firm sheath, or when they are hatched within the mother.

Most fishes have a great number of offspring, and parental care is proportionately little. Moreover, the conditions of their life are not suited for the development of that virtue. When it is exhibited, it is usually by the males,—e.g. by the sea-horse (*Hippocampus*) and the pipe-fish (*Syngnathus*), which hatch the eggs in external pouches, and "the male of some species of *Arius*, who carries the ova about with him in his capacious pharynx." The female of *Aspredo* carries the eggs on the under surface of the body until they are hatched, much in the same way as the Surinam toad bears her progeny on her back; while in *Solenostoma* a pouch for the eggs is formed by the ventral fins and skin. At least a dozen kinds of fishes make nests, of which the most familiar illustration is that of the male stickleback, who twines grass stems and water-weeds together, glueing them by mucus threads exuded as semi-pathological products from the kidneys, which are compressed by the enlarged male organs.

Fishes have a less definite limit of growth than most other Vertebrates, and it is rare for a fish to exhibit any of the senile changes associated with old age in other Vertebrates. But surroundings and nutrition affect their size and colour very markedly. Some, such as the flounder, seem almost equally at home in fresh or salt water, but many are sensitive to changes of medium. Many can endure prolonged fasting, and some may survive being frozen stiff. Lowered temperature may induce torpor, as seen in the winter sleep of the pike, while in the dry season of hot countries the mud-fishes, the Siluroids, and others, encyst themselves in the mud, and remain for a long time in a state of "latent life."

Life histories.—The life histories of fishes form the subject of an endless chapter, of which we can only give a few illustrations. We know how the lusty salmon return from the sea to the possibly safer rivers, and after a period of fasting deposit their eggs and milt on the gravelly bed of the stream. A similar migration is true of the sturgeon.

In great contrast to these cases is the life history of the eel, the mystery of which has been at least partially removed. From the inland ponds and river-stretches the female eels migrate on autumn nights seawards, meet their mates lower down the rivers, and descend to very deep water in the sea (250 fathoms or more). There the eggs are laid, and there in all probability the parents die. Thence the

transparent larvæ (*Leptocephali*) rise to the surface and are for a year or so pelagic. From the open sea the young eels or elvers migrate up the streams in a marvellous procession or eel-fare, the females apparently going farther inland than the males.

Inter-relations.—Commensalism is illustrated by some small fishes which shelter inside large sea-anemones, and by *Fierasfer*, which goes in and out of sea-cucumbers and medusæ. On the outside or about the gills of Fishes, parasitic Crustaceans (fish-lice) are often found; various Flukes are also common external parasites, and many Cestodes in bladder-worm or tape-worm stage infest the viscera. The immature stages of *Bothriocephalus latus* occur in pike and burbot; a remarkable

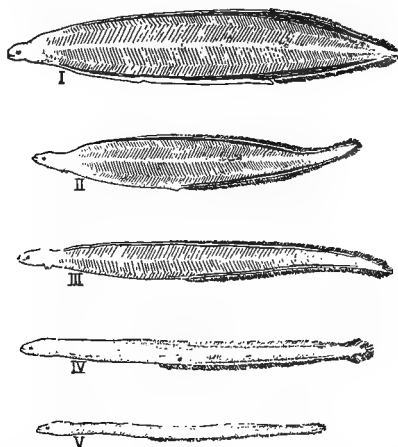

FIG. 300.—Development of eel.—After Smit.
Change from *Leptocephalus* shape (I.) to "Elver" shape (V.).

hydroid (*Polypodium*) is parasitic on the eggs of a sturgeon; the young of the fresh-water mussel are temporarily parasitic on the stickleback; and the young of the Bitterling (*Rhodeus amarus*) live for a time within the gills of fresh-water mussels.

Distribution in space.—There are about 2300 species of fresh-water fishes, three or four Dipnoi, about thirty "Ganoids," and the rest Teleosteans, over a half being included in the two families of carps (Cyprinidæ) and cat-fishes (Siluridæ).

Among marine fishes, about 3500 species frequent the coasts, rarely descending below 300 fathoms. A much smaller number, including many sharks, live and usually breed in the open sea. About 100 genera have been recorded from great depths.

In regard to the last, Dr. Günther has shown that in forms living at

depths from 80 to 200 fathoms, the eyes tend to be larger than usual, as if to make the most of the scanty light; beyond the 200-fathom line small-eyed forms occur with highly developed organs of touch, and large-eyed forms which have no such organs, but perhaps follow the gleams of "phosphorescent" organs; finally, in the greatest depths some forms occur with rudimentary eyes. Many of these abyssal fishes are phosphorescent; the colouring is usually simple, mostly blackish or silvery; the skin exudes much mucus; the skeleton tends to be light and brittle; the forms are often very quaint; the diet is necessarily carnivorous.

GENERAL NOTES ON THE STRUCTURE OF FISHES

Fins.—Along the dorsal and ventral median line of some fishes, *e.g.* flounder, there is a continuous fin—a fold of skin with dermal fin-rays (dermotrichia) and deeper skeletal supports (somactids).

In the embryos of many fishes the same continuous fringe is seen, while the adults have only isolated median fins. There is no doubt that these isolated median fins—of which there may be two dorsals, a caudal, and an anal or ventral—arise, or have arisen, from a modification of a once continuous fin.

Now, the paired fins, which correspond to limbs, often resemble unpaired fins in their general structure, and in their mode of origin. It is possible that the paired fins may have arisen by a localisation of two once continuous lateral folds. According to another theory, the origin of paired fins is to be found in the visceral arches.

The paired fins are supported by dermic fin-rays (*dermotrichia*) and by endoskeletal pieces (*somactids* or *radials*), some of which are articulated to the girdles and are then called *basalia*. Two main types of fish fin are distinguishable—(*a*) that best illustrated among living fishes by *Ceratodus*, in which a median jointed axis bears on each side a series of radial rays—a form often called an archipterygium; and (*b*) the commoner type, in which the radials arise on one side of the basal pieces (an ichthyopterygium). In the bony fishes the support of the fin beyond the base seems mainly due to dermal rays.

Tail.—In Dipnoi and a few Teleosts, *e.g.* the eels, the vertebral column runs straight to the tip of the tail, dividing it into two equal parts. This perfectly symmetrical condition is called diphycercal or protocercal.

In Elasmobranchs, Holocephali, cartilaginous and many extinct "Ganoids," the vertebral column is bent dorsally at the end of the tail, and the ventral part of the caudal fin is smaller than, and at some little distance from, the upper part. This asymmetrical condition is called heterocercal.

In most Teleostei, and in extant bony "Ganoids," the end of the vertebral column is also bent upwards, but the apex atrophies, and, by the disproportionate development of rays on the ventral side, an apparent symmetry is produced. The vertebral column usually ends in a urostyle,—the undivided ossified sheath of the notochord. Most of the fin really lies to the ventral side of this. The condition is termed homocercal.

The effect of a stroke with the heterocercal tail is to force the anterior region downwards, and thus the heterocercal tail in fish is associated with a ventral mouth and the habit of ground-feeding. The movement of the homocercal tail, on the other hand, drives the body straight forwards, and is associated with a terminal mouth.

Scales.—(1) In Elasmobranchs the scales (placoid) have the form of skin-teeth (dermal denticles), tipped with enamel, cored with dentine, and based with bone sunk in the dermis. They arise from skin papillæ, the (ectodermic) epidermis forming the enamel, the (mesodermic) dermis forming the rest. In other fishes the scales are almost wholly dermic, in marked contrast to those of Reptiles.

(2) "Ganoid" scales, as in *Lepidosteus*, are plates of bone with an enamel-like covering called ganoin.

(3) In most Teleosts the scales are relatively soft dermic plates of thin bone. In the sturgeon and many Teleosts the scales are substantial bony plates. The typical "soft" Teleost scales are called cycloid or ctenoid, as their free margins projecting from sacs in the dermis are entire or notched. The concentric rings on the scales indicate periods of growth, like the rings on a tree stem, and it is possible in some cases to tell the age of a fish from its scales, as also from the otoliths in the ear when these have a layered structure.

The scales of Elasmobranchs are homologous with teeth, and a number may fuse into a plate just as teeth often do.

Swim-bladder.—The swim-bladder of fishes is one of the numerous outgrowths of the gut. It is absent in Elasmobranchs and some Teleosts, such as most flat-fish, and it forms the lung of Dipnoi. Unlike a lung, it opens dorsally into the gut, except in Dipnoi and the Ganoid *Polypterus*, where the aperture is ventral. The original duct communicating with the gut may remain open, as in Physostomatous Teleosts, or it may be closed, as in Physoclystous Teleosts. The bladder is usually single, but it is double in *Protopterus*, *Lepidosiren*, and *Polypterus*.

In regard to the use of the swim-bladder, there is still considerable uncertainty. Where it is abundantly supplied with impure or partially purified blood, as in Dipnoi, *Polypterus*, and *Amia*, and where the gas within is periodically emptied and renewed, it is doubtless respiratory. But what of other cases, where its supply of blood is arterial, and what especially where it is entirely closed? In such cases it is usual to speak of its function as hydrostatic.

In greater detail the function of the air-bladder is—(1) to render the fish, bulk for bulk, of the same weight as the medium in which it lives; moreover (2), the volume of the contained gas varies with increased secretion and absorption, and seems to adjust itself to different external pressures as the fish descends or ascends. There is sometimes a well-developed gas-gland with a rich blood-supply on the inner wall of the bladder. (3) In many fishes the bladder may help indirectly in respiration by storing the superabundance of oxygen introduced into the blood by the gills. (4) There is in several Teleosts a remarkable connection between the swim-bladder and the ear, sometimes by an anterior process of the bladder, as in the herring and perch-like fishes, sometimes by a chain of bones, as in Siluridæ. This has suggested

the view that the connection serves to make the fish aware of the varying tensions of gas in the bladder, due to the varying hydrostatic pressure.

CLASSIFICATION OF FISHES

Sub-Class I. ELASMOBRANCHII. Cartilaginous Fishes, *e.g.* Sharks and Skates

Voracious carnivorous fishes, with cartilaginous skeleton, placoid scales, usually heterocercal tails, "claspers" on

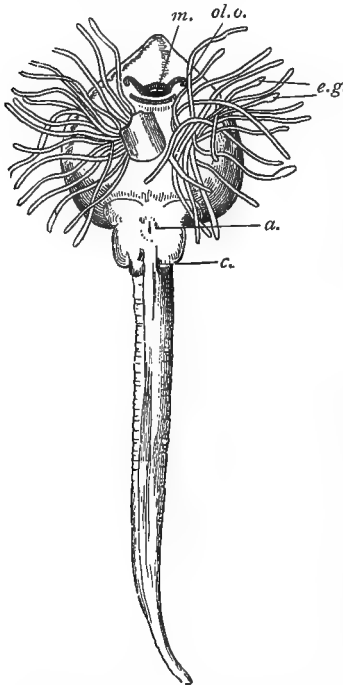

the pelvic fins of the males. Except in Holocephali there is no cover over the (5-7) gill-apertures; anterior to these there is often a spiracle—the first gill-cleft—with a rudimentary gill.

The gill-clefts are separated by complete septa, and the gill-filaments are attached throughout their length to the septa. The mouth extends transversely on the under side of the head. The nostrils are also ventral. There is no air-bladder. A spiral fold extends along the internal wall of the large intestine. Into the terminal chamber (or cloaca) of the gut the genital and urinary ducts also open. The ventricle of the heart has a contractile conus arteriosus. Fertilisation is internal. The ova are few and large, *i.e.* with much yolk.

FIG. 301.—Young skate.—From Beard.
The yolk-sac has been cut off, the yolk-stalk is left. *m.*, Mouth; *ol.o.*, nostril, *e.g.*, "external gills"; *a.*, cloaca; *c.*, claspers.

Large egg-purses are common, but some Elasmobranchs are viviparous. The embryos have gill-filaments projecting out of the gill-clefts, so-called external gills. They are really elongated internal gills. Elasmobranchs retain more embryonic features, e.g. the naso-buccal groove and auditory opening, than other fishes.

Order I. PLAGIOSTOMI or SELACHII

With transverse ventral mouth, pre-oral rostrum, uniserial paired fins, claspers, heterocercal tail, usually five pairs of open gill-clefts.

Subdivisions.—(1) The older Selachoidei, with approximately cylindrical bodies and lateral gill-openings, as in shark and dogfish; (2) the more modified Batoidei, with flattened bodies, ventral gill-openings, and pectoral fins joined to the head, as in skates or rays.

Mustelus, *Carcharias*, *Squalus*, *Torpedo*, *Acanthias*, and others, are

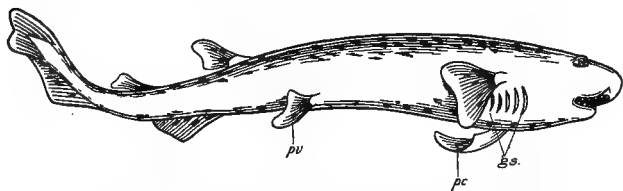

FIG. 302.—Lateral view of dogfish (*Scyllium catulus*).

Note ventral mouth with naso-buccal groove, heterocercal tail, and unpaired fins. *gs.*, Gill-slits; *pc.*, pectoral fins; *pv.*, pelvic fins.

viviparous; *Raja*, *Scyllium*, *Cestracion*, and others, are oviparous. In most species of *Mustelus* there is a placenta-like connection between the yolk-sac of the embryo and the uterus of the mother. In several viviparous genera long filaments are developed from the inner surface of the uterus which secrete a nutritive fluid. In some cases the nutriment seems to be afforded by degeneration of the uterine wall. In *Acanthias vulgaris* there is no nutritive material, and the young are unattached. This is intermediate between oviparous and specialised placental conditions. *Zygana* has a peculiar hammer-like head expansion; *Selache* reaches a length of 40 ft.; *Pristis* has the snout prolonged in a tooth-bearing saw; *Torpedo* has a powerful electric organ. The Greenland Shark (*Lamargus borealis*) is unique in having small eggs, without egg-cases, perhaps fertilised in the water. In the eel-like deep-water Japanese Shark (*Chlamydoselachus*) the mouth is anterior, the nostrils lateral, the vertebral column is imperfectly segmented, there is a slight opercular fold, and there are six pairs of gill-openings and arches. In the large viviparous Notidanidæ, e.g. *Hexanchus* (six

gills) and *Heptanchus* (seven gills), the mouth is almost inferior, the vertebral column is imperfectly segmented with persistent notochord.

History.—The Elasmobranchs appear in the Upper Silurian, are very abundant from the Carboniferous onwards, but are now greatly outnumbered by the Bony Fishes. An increasing calcification of the axial skeleton is traceable through the ages, and in some of the ancient forms the exoskeleton was greatly developed, often including long spines or ichthyodorulites firmly fixed on the dorsal fins or on the neck.

Order 2. HOLOCEPHALI

The Holocephali are represented by the sea-cat or *Chimæra* from northern seas, and *Callorhynchus* from the south. There is a fold or operculum covering the (4) gill-clefts and leaving only one external opening on each side; there is no spiracle; the vertebral column is unsegmented; the upper jaw is fused to the cartilaginous skull, and thus the hyoid does not help in its suspension (*autostylic*); the skin is naked except in the young, which have some dorsal placoid spines. There is a urogenital aperture separate from the anus. In general the Holocephali most nearly resemble Plagiostomi, but they have many affinities with Dipnoi, *e.g.* in the autostylic skull.

Teeth (of *Ptychodus*, *Rhynchodus*, etc.), which have been referred to Chimæroids, occur in Devonian rocks, and some at least of the detached spines of Carboniferous age may have belonged to fishes of this order. Undoubted Mesozoic Chimæroids are *Squaloraja*, *Myriacanthus*, *Chimæropsis*, *Ischyodus*, etc., while others, including the recent genus *Chimæra*, are found in strata of Tertiary age. The other recent genus, *Callorhynchus*, is also represented by a Cretaceous species, *C. hectori*.

EXTINCT ORDERS

Order 3. PLEUROPTERYGII

Devonian, Carboniferous, and Permian. Forms with unconstricted notochord, heterocercal tail, terminal mouth, paired fins with unsegmented parallel radials. *Cladoselache*.

Order 4. ICHTHYOTOMI

Lower Carboniferous to Permian. Forms with unconstricted notochord, diphyccercal tail, and pectoral fins with a segmented axis of basals bearing biserial radials. *Pleuracanthus*.

Order 5. ACANTHODEI

Another interesting extinct group, whose position was for long a matter of dispute, but which is now usually placed near Elasmobranchii, is that of the Acanthodei. These flourished principally in Devonian times, but lived on through the Carboniferous to the Lower Permian.

They are usually rather small fishes, with minute rhomboidal shagreen-like scales, and a strong spine in front of each fin, except the caudal. In some genera (*Parexus*, *Climatius*) there are two rows of small intermediate spines between the proper pectorals and the pelvics.

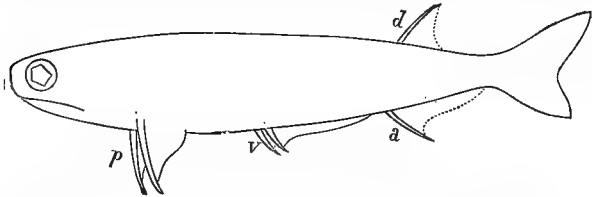

FIG. 303.—Outline of *Acanthodes sulcatus*.—After Traquair.
p., Pectoral fins; *v.*, pelvics; *a.*, anal; *d.*, dorsal.

Sub-Class II. TELEOSTOMI

Fishes with more or less ossified skeletons, especially as regards skull, jaws, operculum, and pectoral girdle. The skull is hyostylic, the jaws being supported by the hyomandibular. The pelvic girdles are usually rudimentary or absent. The mouth is usually terminal; the scales are in the majority soft and cycloid. There is always a gill-cover; the inter-branchial septa are much reduced; the gill-filaments project freely from the gill-arches. There is usually a swim-bladder. There are no claspers, no nasobuccal grooves; there is no cloaca. The fore-brain has a non-nervous roof. The ova are small and numerous, usually meroblastic, sometimes holoblastic. Fertilisation is usually external.

Order I. CROSSOPTERYGII

Ancient forms with pectoral fins obtusely lobate and uniserial or acutely lobate and biserial; with scales and dermal skull bones often covered with enamel-like ganoin; with a pair of jugular plates between the rami of the lower jaw. All are extinct except *Polypterus* and *Calamoichthys* from African rivers. Examples, *Osteolepis* (Lower Devonian), *Holoptychius* (Devonian), *Megalichthys* (Carboniferous).

In *Polypterus*, the body is covered with rhombic ganoid scales; there are numerous dorsal fins; the tail is diphycercal; the pectoral fin has three basal pieces as in Elasmobranchs, then two rows of radials, and then the dermal fin-rays or dermatrichia; the air-bladder is double and is used in respiration, its duct opens ventrally into the pharynx; the young form has an external gill on the operculum; the

oral part of the hypophysis retains its opening into the mouth. The genus *Calamoichthys* has very similar characters, but no pelvic fins. These two forms may almost be called living fossils.

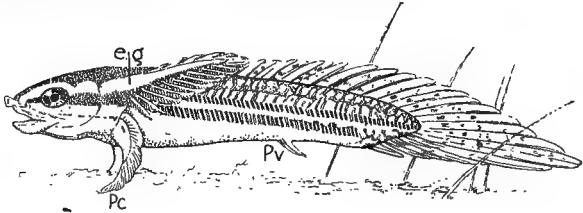

FIG. 304.—Larva of *Polypterus* (after Budgett), $1\frac{1}{4}$ inch in length.

e.g., Large external gill of the hyoid arch; *Pc.*, pectoral fins; *Pv.*, pelvic fins. The larva is drawn in a very characteristic attitude.

The following three orders are often grouped as Actinopterygii, with the following characters. The paired fins are never lobate, they have short basal pieces, and are mainly supported by dermal fin-rays.

Order 2. CHONDROSTEI—with cartilaginous internal skeleton

Living examples:—Sturgeon (*Acipenser*), *Polyodon*, *Scaphirhynchus*.

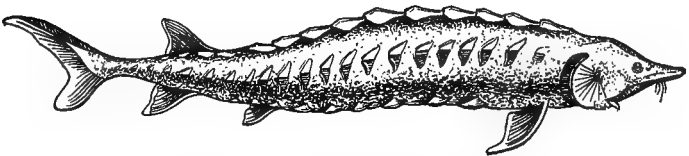

FIG. 305.—Sturgeon (*Acipenser sturio*).

Note the elongated snout, the barbules bounding the ventral mouth, the operculum covering the gills, the rows of bony scutes, the markedly heterocercal tail.

Extinct examples:—*Cheirolepis*, *Palæoniscus*, *Chondrosteus*.

In the sturgeon (*Acipenser*) the skin bears five rows of large bony scutes; the tail is heterocercal; the notochord is unsegmented. A snout, with pendent barbules, extends in front of the ventral mouth, which is rounded and toothless. Sturgeons feed on other fishes,

which they swallow whole. They are the largest fresh-water fishes, for *A. sturio* may attain a length of 18 ft. and a weight of 600 lb., while the *A. huso* of Southern Russia may measure 25 ft. and weigh nearly 3000 lb. ! Most of the species are found both in the sea and in rivers or lakes. The roes or ovaries form caviare; the gelatinous internal layer of the swim-bladder is used as isinglass.

The genus *Scaphirhynchus* is represented in Asia and the United States; *Polyodon* or *Spatularia spatula* is the paddle-fish or spoon-bill of the Mississippi.

Order 3. HOLOSTEI¹—with bony skeleton

Living examples :—*Lepidosteus* and *Amia*.

Extinct examples :—*Lepidotus*, *Pycnodus*, *Aspidorhynchus*.

The N. American bony pike—*Lepidosteus*—is covered with rows of "ganoid" scales; the whole skeleton is well ossified, and the vertebral bodies are opisthocœlous; the swim-bladder is like a lung in structure, and to some degree in function. The bow-fin, *Amia calva*, frequenting still waters in the United States, has a similar lung-like swim-bladder. Its scales are similar to those of a Teleost.

Order 4. TELEOSTEI. The "Bony Fishes"

This order includes most of the fishes now alive. Though comparatively modern fishes, they are older than was formerly supposed, as several Jurassic genera (*Thrissops*, *Leptolepis*, etc.), which used to be classed as "Ganoids,"¹ must be considered as actual Clupeoids, or herring-like Teleostei. It is, however, not until the Upper Cretaceous and Tertiary epochs that they assume among fishes that overwhelming preponderance in numbers which they possess at the present day. The physostomous type of Teleostean is the most ancient, and probably stands in a continuous genetic line with the Holostei.

The skeleton is well ossified, with numerous investing bones on the skull, others in the operculum, and on the shoulder-girdle. There is always a supra-occipital in the

¹ The term "Ganoids," which we abandon, is often used to include Crossopterygii, Chondrostei, and Holostei. Though they agree in having a conus arteriosus with many valves, as opposed to the Teleostean bulbus, an optic chiasma, as opposed to the decussate condition in Teleosts, and an intestinal spiral valve which is absent in Teleosts, they do not seem to form a natural division.

skull. The tail is sometimes quite symmetrical or diphyrceral, but in most cases it is heterocercal at first, and acquires a secondary symmetry termed homocercal; for while the end of the notochord in the young forms is bent upwards as usual, the subsequent development of rays produces an apparent symmetry. The scales are in most cases relatively soft. The roof of the fore-brain is without nervous matter. The optic nerves are remarkable, because they cross one another without interlacing (decussate). The partitions between the gill-clefts disappear; so, instead of the pouches seen in Elasmobranchs, there is, on each side, one branchial chamber, covered over by an opercular fold. Into this chamber the comb-like gills, borne by the branchial arches, project freely. There is usually a

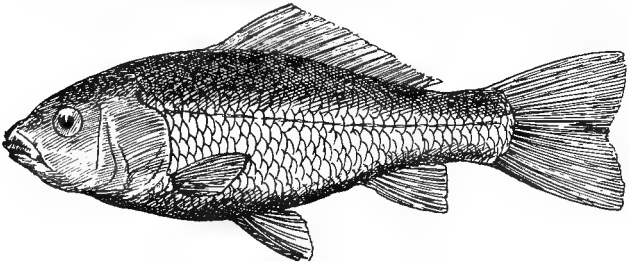

FIG. 306.—The goldfish (*Cyprinus auratus*).

rudimentary gill or pseudobranch associated with the hyoid. There is no spiracle. In most, a swim-bladder is developed from the dorsal side of the gullet. The duct of the swim-bladder may remain open (Physostomous), as in herring, salmon, and carp; or it may be closed (Physoclistous), as in perch and cod. There is no spiral valve in the intestine, and the food canal ends in front of, and separate from, the genital and urinary apertures or aperture. The base of the ventral aorta is swollen into a non-contractile bulbus arteriosus, but there is no conus, unless very exceptionally, as in *Butirinus*. A remarkable peculiarity is that the gonads are usually continuous with their ducts. The ova are numerous, usually small and fertilised in the water. The segmentation is meroblastic, and there is usually a distinct larval stage.

The Teleosts include the great majority of living fishes, which are classified in thirteen sub-orders and numerous families, *e.g.* Clupeidæ (herrings); Salmonidæ (salmon, trout); Cyprinidæ (carps); Murænidæ (eels); Esocidæ (pike); Gasterosteidæ (sticklebacks); Syngnathidæ (pipe-fish and sea-horses); Gadidæ (cod-fishes); Percidæ (perch); Scombridæ (mackerels); Pleuronectidæ (flat-fishes); Cottidæ (bull-heads); Triglidæ (gurnards); Lophiidæ (anglers); Tetrodontidæ (globe-fishes).

Sub-Class III. DIPNOI. "Mud-Fishes"

Fishes with a lung—the modified swim-bladder—as well as gills; the paired fins are of the archipterygium type, with a long segmented axis, sometimes bearing a series of lateral pieces on each side, with overlapping cycloid scales, with multicellular skin-glands, with a diphyercal tail. The notochord persists, and its sheath is unsegmented; the skull is autostylic and is largely a persistent chondrocranium with the addition of some membrane bones; there are large compound grinding teeth. The external nares are on the ventral surface of the snout, or even within the upper lip, and the arching over of the nasal grooves leads to the formation of separate internal nares. The heart is incipiently three-chambered, containing mixed blood, with a spiral conus arteriosus with numerous valves; there is a vein resembling the inferior vena cava of higher vertebrates. There is a spiral valve in the intestine. The eggs are large and exhibit total unequal segmentation, as in Amphibians.

The Dipnoi, whose name means double breathers, are now represented by three genera—*Ceratodus*, from two rivers of Queensland; *Protopterus*, from certain African rivers, *e.g.* the Gambia; and *Lepidosiren*, from the Amazons. The wide distribution is noteworthy.

They are very ancient forms, for *Ceratodus* existed in Triassic and Jurassic times (though no post-Jurassic remains are known). There were also undoubted Dipnoi far back in Palæozoic times, such as *Dipterus* and *Phaneropleuron* of the Devonian, *Ctenodus* and *Uronemus* of the Carboniferous.

The living Dipnoi are probably the survivors of an archaic group; in their teeth and autostylic skull they resemble Holocephali; in their fins and air-bladder they

recall Crossopterygii; in their cartilaginous skeleton and persistent notochord they are primitive; in their lung, heart, inferior vena cava, multicellular skin-glands, and eggs they approach Amphibians.

The Dipnoi are *physiologically* transitional between Fishes and Amphibians, having, for instance, acquired lungs while retaining gills, but it does not follow that they are *morphologically* transitional. They are intermediate, but that is not to say that they are *the* connecting links.

Ceratodus.—The genus *Ceratodus* is abundantly represented by fossils in the Mesozoic beds of Europe, America, Asia, and Australia, but the living animal is now limited to the basins of the Burnett and Mary rivers of Queensland (see Fig. 6). Like that other old-fashioned animal the duckmole, *Ceratodus* frequents the still, deep places of the river's bed, the so-called "water-holes." At the bottom of these it lies sluggishly, occasionally rising to the surface to gulp in air. Its diet was formerly supposed to be exclusively vegetarian, but Semon holds that it crops the luxuriant vegetation of the river-banks only for the sake of the associated animal life—larvæ and eggs of insects, worms, molluscs, amphibians, and fishes. Though *Ceratodus* is quite unable to live out of water, its air-breathing powers enable it to exist in

water which is laden with sand or rotten vegetable matter.

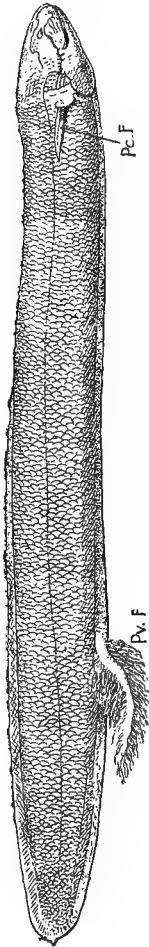

FIG. 307. — *Lepidosiren* (after Graham Kerr), showing (*Pc.f.*) pectoral fin and the tufted pelvic fin (*Pv.f.*) of the mature male.

Ceratodus sometimes attains a length of 6 ft. The body is elongated and compressed, and bears a continuous vertical fin. The paired fins are trowel-like. There are five gill-clefts, four internal gills, and a hyoid half-gill. There are no external gills.

The swim-bladder or lung is single. It is supplied with blood from the fourth branchial arches, as is the swim-bladder of *Polypterus* and *Amia*. It arises ventrally, but lies dorsally, and is divided into compartments.

The auricle of the heart has a dorsal fibrous ridge hinting at a division. A similar incomplete septum occurs in the ventricle, and the sinus venosus is divided into a left pulmonary and a right systemic portion. The conus arteriosus is peculiarly twisted, and contains a short longitudinal spiral valve and numerous large "pocket" (or "Ganoid") valves.

Protopterus. — This mud-fish lives in the Gambia, Quilimane, and some other African rivers. It is mainly but not exclusively carnivorous, and attains a length of 2 to 3 ft. or more. It has extraordinary vitality, surviving severe wounds, long fasting, and desiccation. It appears to be most active at night, and to prefer shallow water, swimming rapidly with powerful tail-strokes, or "walking" slowly along the bottom with its filamentous fins moving alternately on each side, somewhat like the legs of a newt. At short intervals it comes to the surface to take mouthfuls of air, which passes out again through the opercular aperture.

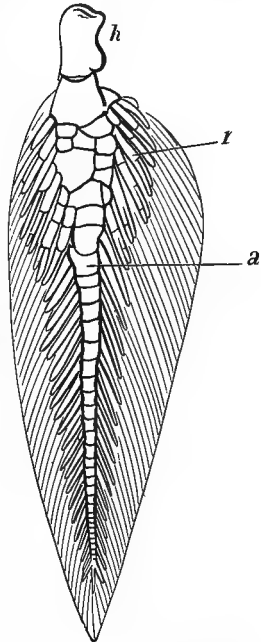

FIG. 308.—Skeleton of *Cera-todus* fin.—From Gegen-baur.

a., Central axis; r., radials;
h., basal piece.

As the dry season approaches, *Protopterus* burrows into the earth to a depth of about 18 in., coils itself up, and secretes abundant mucus from its skin glands. This secretion forms a cocoon or capsule, with adherent earth externally, with moist slime internally, and with a lid, on which there is always a small aperture. Thus encapsuled, the

animal may remain dormant for many months, *e.g.* from August to December. The air seems to pass directly from the mouth of the burrow, through the aperture of the capsule-lid (which is produced

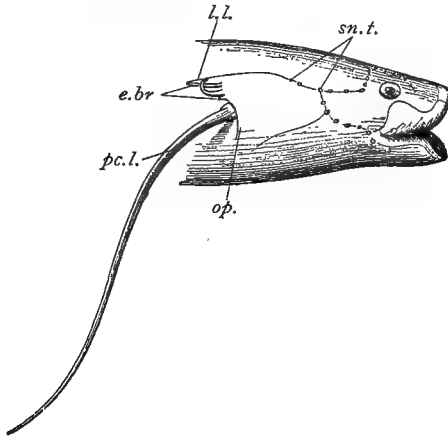

FIG. 309.—Head region of *Protopterus*.—From W. N. Parker.

sn.t., Sensory tubes; *l.l.*, lateral line; *e.br.*, external gills; *p.c.l.*, pectoral fin; *op.*, operculum.

inwards in a short pipe) to the nostrils, and thence to the lungs. The nourishment appears to be derived from a store of fat deposited in the lymphoid tissue around the reproductive organs and kidneys, and among the lateral muscles of the tail (*cf.* fatty bodies in

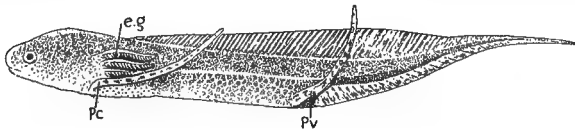

FIG. 310.—Larva of *Protopterus*.—After Budgett.

e.g., external gills; *Pc.*, pectoral fin; *Pv.*, pelvic fin.

caterpillars, amphibians, etc.). Moreover, some of the muscles are replaced by fat, and others undergo a pathological granular degeneration (*cf.* lamprey). To a certain extent, therefore, the dormant animal lives on its own tail. It is probable that leucocytes aid in the absorption and transportation of the degenerated muscles (*cf.* tadpoles):

These capsules, with the surrounding earth, have often been transported from Africa to Northern Europe, without injury to the dormant fish within. The fish makes a nest which is guarded by the male. The larvæ have four pairs of external gills, and a crescentic sucker like that of an Amphibian tadpole.

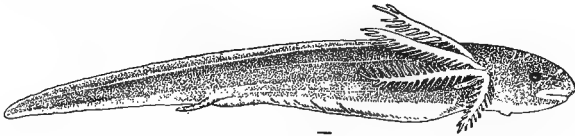

FIG. 311.—Larva of *Lepidosiren*.—After Graham Kerr.

Lepidosiren.—This mud-fish from the Amazons has an eel-shaped body, with a continuous vertical fin. The limbs are reduced to the axis only. There is a well-developed septum in the auricle, an all but complete septum in the ventricle, and a complete septum in the conus. The lung is double. The eggs are laid in burrows, and the male remains curled up beside them. The young are hatched with external gills.

CHAPTER XXIII

CLASS AMPHIBIA

- Order I. STEGOCEPHALI (extinct).
,, II. GYMNOPIHONA or APODA (a small order).
,, III. URODELA or CAUDATA, *e.g.* Newts and Salamanders.
,, IV. ANURA or ECAUDATA, *e.g.* Frogs and Toads.

AMPHIBIANS made the transition from aquatic to terrestrial life. But almost all have lagged near the water. Certain acquisitions, such as lungs and a three-chambered heart, incipient in the Dipnoi, are here firmly established. As regards bodily size, the Amphibian race has dwindled since the days of its prime, but it seems to have been progressive, for some of its members show affinities with Reptiles.

GENERAL CHARACTERS

Amphibia are Vertebrates in which the visceral arches of the larva almost always bear gills, which may be retained throughout life, though the adults normally possess functional lungs. Whence it follows that the nostrils, through which the air enters, must open into the mouth. When limbs are present, they have distinct digits. The unpaired fins, frequently present both in larvæ and adults, are without fin-rays. In existing forms there is rarely any exoskeleton, but some extinct forms had an armour of bony plates. The skull has two occipital condyles. The heart is three-chambered, with two auricles and a ventricle,—and a conus arteriosus. The gut ends in a cloaca, into which the ducts from kidneys and reproductive organs also open. A bladder, growing out from the hind region of the gut, is probably homologous with the allantois of the embryos of higher Vertebrates. The ova are small, numerous, usually pigmented, and with yolk towards one pole. They are almost always laid in water; the seg-

mentation is holoblastic, but unequal. There is usually a metamorphosis in development.

Huxley was the first to recognise the affinities between Fishes and Amphibians, and to unite the two classes under the title Ichthyopsida.

Of the characters common to the two classes, the following are important: Gill-slits are functional in respiration, but in Amphibians they may disappear after larval life, the Eustachian tube excepted; gills are always present, but they may be restricted to the larval stages in Amphibians; in fishes and larval Amphibians a single ventral aorta leaves the heart; there is no amnion, and at most a homologue of the allantois (in Amphibians); there are only ten pairs of cranial nerves; there are lateral sensory structures, such as the "branchial sense organs" and those of the "lateral line," but these may be diminished in the adults; unpaired fins are almost always represented, but may not persist in the adult life; there is a functional pronephros in early stages.

From the higher Vertebrates or Amniota the Ichthyopsida are clearly distinguished by the presence of gills (in youth at least) and by the absence of amnion and functional allantois. For though the bladder of Amphibians may be homologous with an allantoic outgrowth, it does not function as such, *i.e.* it does not aid in the respiration or the nutrition of the embryo.

It is more difficult to distinguish between Fishes and Amphibians, more especially if we include the Dipnoi in the former class. The most obvious differences are the absence of fin-rays and the development of fingers and toes. In the following table the two classes are contrasted:—

FISHES.	AMPHIBIANS.
Gills persist throughout life.	Gills may disappear as the adult form is attained.
The swim-bladder functions as a lung in Dipnoi and less markedly in some "Ganoids," but in most cases its respiratory significance is slight.	Lungs are always developed in the adults. It is doubtful whether they are directly comparable with the swim-bladder.
The heart is two-chambered (incipiently three-chambered in Dipnoi). There is no inferior vena cava, except in Dipnoi.	The heart has three chambers. There is an inferior vena cava, and paired posterior cardinals are seen only in the larva.
The limbs are fins.	The limbs have digits.
The unpaired fins are supported by fin-rays (dermotrichia).	There are no fin-rays.
The skull has, in most cases, one occipital condyle.	There are two occipital condyles. A columella runs from the tympanum to a fenestra ovalis in the ear capsule.
There is usually an exoskeleton of scales or scutes.	There is no exoskeleton, except in a few cases, and in extinct forms.
There are no true posterior nares.	There are posterior nares opening into the cavity of the mouth.
There is no certain homologue of the allantois.	The cloacal bladder seems to be the homologue of the allantois.

THE FROG AS A TYPE OF AMPHIBIANS

The common British frog (*Rana temporaria*) and the frequently imported continental species (*R. esculenta*) agree in essential features.

Though aquatic in youth, they often live in dry places, hiding in great drought, reappearing when the rain returns. Every one knows how they sit with humped back, how they leap, how they swim. They feed on living insects and slugs.



FIG. 312.—The edible frog (*Rana esculenta*).

These are caught by the large viscid tongue, which, being fixed in front of the mouth and free behind, can be jerked out to some distance, and with even greater rapidity retracted. When a frog is breathing, the nostrils are alternately opened and closed, the under side of the throat is rhythmically expanded and compressed, the mouth remains shut meanwhile. The males trumpet in the early spring to their feebly responsive mates. In our British species the pairing takes place soon after; the young are familiarly known as tadpoles, and a notable metamorphosis takes place. In winter the frogs hiber-

nate—buried in the mud of the ditches and ponds, mouth shut, nose shut, eyes shut—and breathe through their skin.

Form and external features.—The absence of neck and tail, the short fore-limbs almost without thumbs, the longer hind-limbs with five webbed nailless toes and with a long ankle region, the apparent hump-back where the hip-girdle is linked to the vertebral column. There is a very rudimentary thumb, and there is a horny knob at the base of the hallux or "great toe." At pairing time the skin of the first finger is modified in the males into a rough cushion, darkly coloured in *R. temporaria*.

The wide mouth, the valvular nostrils, the protruding eyes, the upper eyelid thick, pigmented, and slightly movable, the lower rudimentary and immovable, the third eyelid or nictitating membrane semi-transparent and moving very freely, the circular drum of the ear, the slightly dorsal cloacal aperture.

Skin.—The smooth, moist skin is loosely attached at intervals to the muscles by bands of connective tissue, which form the boundaries of over a score of lymph-sacs. These contain fluid partly absorbed through the skin, and open into the veins by two pairs of lymph-hearts. The skin consists of a two-layered (ectodermic) epidermis, and an internal (mesodermic) dermis. The transparent outer layer of the epidermis is shed periodically, and swallowed by the frog. The dermis differs markedly from that of a fish, for there is no exoskeleton, though this was present in the extinct Labyrinthodonts; there are *multicellular* glands, whose secretion keeps the skin moist and is in part poisonous; and there is a stratum of unstriped muscle fibres. Pigment cells occur in the dermis, and some extend between the cells of the epidermis. The colour changes a little according to the state of these cells, the protoplasm expanding and contracting partly through the direct influence of light and moisture on the skin, partly by a more complex reflex action in which the eyes, the brain, and the sympathetic nervous system are all implicated. In the larval salamander the pigment cell seems to contract and expand as a whole, but this is not usually the case. There are cutaneous blood vessels, by means of which the frog can, to a certain extent, breathe by its skin. The

tadpole has sensory cells in distinct lateral lines, but of this regularity the adult retains little trace, though it has many nerve-endings and "touch-spots" in various parts of its skin.

The axial skeleton.—The vertebral column consists of nine vertebræ, and an unsegmented urostyle or coccyx.

The first vertebra bears two facets for the two condyles of the skull, and an odontoid process which lies between the condyles. It has no transverse processes, and its arch is incompletely ossified. Each of the

next six has an anteriorly concave or procœlous centrum, a neural arch surrounding the spinal cord, a transverse process from each side of the base of the arch, an anterior and a posterior pair of articular processes, and a short neural spine. The eighth vertebra has

a biconcave or amphiœlous centrum. The ninth is convex in front, with two

convex tubercles behind, and bears large transverse processes with which the hip-girdle articulates. The uro-

style, formed by the fusion of several vertebræ, has anteriorly a dorsal

arch enclosing a prolongation of the spinal cord; but both arch and nerve-cord soon disappear posteriorly.

The notochord, around which the vertebral column has developed, is

finally represented only by the vestiges in the centra of the verte-

bræ.

The skull consists — (a) of the persistent parts of the original car-

tilaginous brain-box or chondrocranium, developed, as in the skate, from parachordals and trabeculæ, plus nasal

and auditory capsules; (b) of ossifications of parts of the chondrocranium, cartilage bones; (c) of membrane

or investing bones; and (d) of associated visceral arches

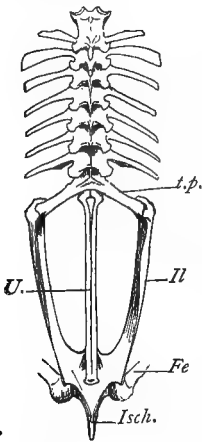

FIG. 313. — Vertebral column and pelvic girdle of bull-frog.

t.p., Transverse processes of sacral vertebra; *Il.*, ilium; *U.*, urostyle; *Fe.*, femur; *Isch.*, ischiac region.

Two ex-occipitals bounding the foramen magnum and forming the condyles, two pro-otics or ossifications of the original auditory capsule,

and an unpaired sphenethmoid forming the front of the brain-case, are cartilage bones. Probably the slender rods known as quadrato-jugals or jugals are also cartilage bones.

Two parieto-frontals and two nasals above, a paired vomer and an unpaired dagger-shaped parasphenoid beneath, and two lateral hammer-shaped squamosals (paraquadrates) are membrane bones. There is no basisphenoid ossification.

To these are added the small premaxillæ in the very front of the skull, and the long maxillæ on each side. The quadrato-jugal connects the maxillæ with a minute nodule which represents the quadrate bone.

On the roof of the mouth, extending from the quadrate forwards to near the vomers, are the triradiate pterygoids, while at right angles to the anterior end of the parasphenoid and behind the vomers are the palatines.

Each half of the lower jaw, based on Meckel's cartilage, consists of three pieces,—the largest an articular angulo-splenic, outside this a thin dentary, and anteriorly uniting with its fellow a minute mentomeckelian.

A delicate rod—the columella auris—extends from the tympanum to the fenestra ovalis in the internal capsule of the ear. According to Parker, it represents the upper part of the hyoid arch, the lower portion of which forms the cartilaginous or partially ossified hyoid plate, which lies in the floor of the mouth and is produced into two anterior and two posterior cornua.

The teeth are borne by the premaxillæ, maxillæ, and vomers.

There is no parietal foramen, but in the Labyrinthodonts it is always distinct.

The cartilage which bears the quadrate at its lower end, and runs between pterygoid and squamosal, connecting the articulation of the lower jaw with the side of the skull at the auditory capsule, is called the suspensorium. In Elasmobranchs the hyomandibular is the sus-

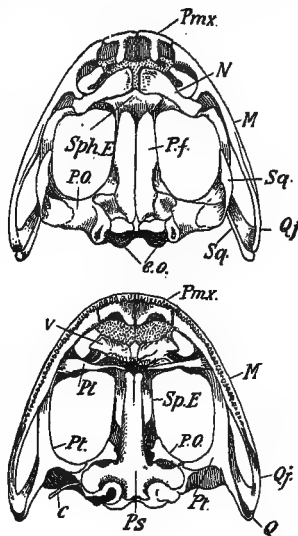

FIG. 314.—Skull of frog—upper and lower surface.—After W. K. Parker.

Upper surface—

Pmx., premaxilla; *N*, nasal; *M*, maxilla; *Sq.*, squamosal; *Qj.*, quadrato-jugal; *e.o.*, ex-occipitals; *P.f.*, parieto-frontals; *Sph.E.*, sphenethmoid; *P.O.*, pro-otic.

Lower surface—

Pmx., premaxilla; *M*, maxilla; *Qj.*, quadrato-jugal; *Q.*, quadrate; *Pt.*, pterygoid; *Ps.*, parasphenoid; *P.O.*, pro-otic; *Sp.E.*, sphenethmoid; *Pl.*, palatine; *V.*, vomer; *c.*, columella.

ensorium; in Teleosteans the name is applied to the hyomandibular and symplectic; in Sauropsida the quadrate occasionally gets the same confusing title.

When the lower jaw is connected with the skull wholly by elements of the hyoid arch, as in most Elasmobranchs and Ganoids, and all Teleosteans, the term *hyostylic* is used. When the connection is due to a quadrate element only, as in Amphibia and Sauropsida, it is called *autostylic*. When there is both a hyoid and a quadrate element, as in *Lepidosteus* among Ganoids, or a hyoid and a palato-quadrate, as in *Cestracion* among Elasmobranchs and perhaps also in Holocephali, the term *amphistylic* is used. Finally, it may be noted here that in Mammals the lower jaw articulates with the squamosal.

The first or mandibular arch gives origin inferiorly to Meckel's cartilage, which forms the basis and persistent core of the lower jaw, and superiorly to the palato-pterygo-quadrate cartilage which is represented in the adult by the minute quadrate bone, by the suspensorial cartilage, and by other cartilages which are invested by the pterygoid and palatine bones.

The second or hyoid arch gives origin inferiorly to the hyoid plate; superiorly, according to Parker, to the columella.

Of the four posterior branchial arches, there are in the adult some persistent remnants, *e.g.* in the larynx.

The limbs and girdles.—The shoulder-girdle consists of a dorsal portion—the scapula and the partially cartilaginous supra-scapula, and of a ventral portion—the coracoid and the pre-coracoid. With the latter, according to most authorities, a thin clavicle is associated. The glenoid cavity, with which the humerus articulates, is formed by the junction of scapula and coracoid.

Between the median ends of the coracoids lie two fused cartilaginous epicoracoids, behind which is a bony part of the sternum, prolonged posteriorly into a notched cartilaginous xiphisternum. Anteriorly lies a bony portion called the omosternum, which is prolonged forwards into an episternum cartilage. This sternum does not arise like that of higher Vertebrates, from a fusion of the ventral ends of ribs. Indeed, there are no ribs in the frog, unless they be minute rudiments at the ends of the transverse processes.

The true frogs (*Ranidæ*) have what is called a *firmisternal* pectoral arch, in which precoracoid and coracoid nearly abut on the middle line, and are only narrowly separated by the epicoracoids. In toads, tree-frogs, etc., the arch is *arciferal*, the precoracoid and coracoid being widely separated medianly, and connected by a large arched epicoracoid, overlapping its fellow.

The skeleton of the fore-limb consists of an upper arm

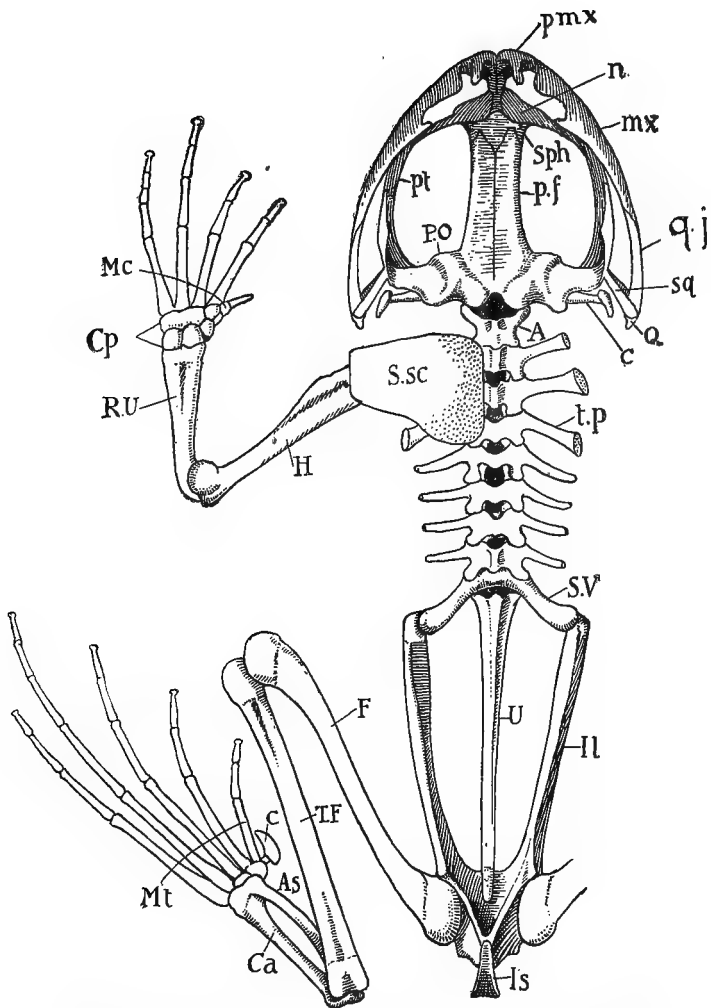

FIG. 315.—Skeleton of frog. The half of the pectoral girdle, and fore- and hind-limb of the right side are not shown.

pmx., premaxilla; *mx.*, maxilla; *n.*, nasal; *sph.*, sphenethmoid; *pf.*, parieto-frontal; *P.O.*, pro-otic; *pt.*, pterygoid; *q.j.*, quadrato-jugal; *sq.*, squamosal; *Q.*, quadrate; *c.*, columella auris; *A.*, atlas; *t.p.*, transverse process; *S.V.*, sacral vertebra; *U.*, urostyle; *S.sc.*, supra scapula; *H.*, humerus; *R.U.*, radio ulna; *Cp.*, carpals; *Mc.*, metacarpals; *Il.*, ilium; *Is.*, ischium; *F.*, femur; *T.F.*, tibio-fibula; *Ca.*, calcaneum; *As.*, astragalus; *C.*, calcar; *Mt.*, metatarsals.

or humerus, a fore-arm in which the inner radius and the outer ulna are fused, a wrist or carpus including two

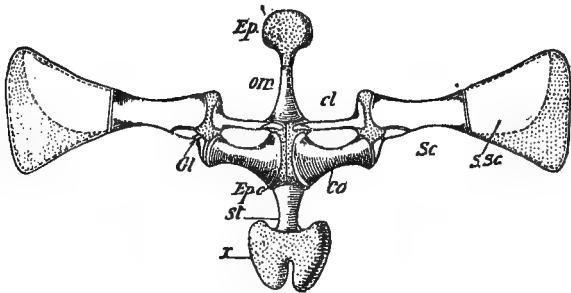

FIG. 316.—Pectoral girdle of *Rana esculenta*.

—After Ecker.

The cartilaginous parts are dotted. *Ep.*, Episternum; *om.*, omosternum; *Epc.*, epicoracoids; *st.*, sternum; *x.*, xiphisternum; *cl.*, clavicle with underlying precoracoid cartilage; *co.*, coracoid; *Sc.*, scapula; *S.sc.*, supra-scapula; *Gl.*, glenoid cavity for humerus.

proximal and three distal elements, and a central piece wedged in between them, five metacarpal bones, of which the first—corresponding to the absent thumb—is very

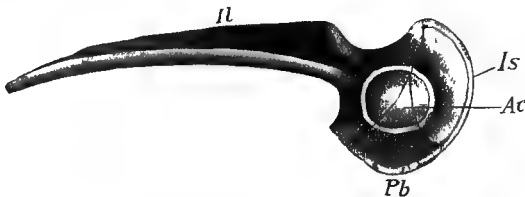

FIG. 317.—Side view of frog's pelvis.—After Ecker.

Il., Ilium; *Is.*, ischium; *Pb.*, pubis; *Ac.*, acetabulum.

small, and four fingers, of which the two innermost have two joints or phalanges, while the two others have three.

The pelvic girdle is shaped like a V, or like a pair of tongs. The ends are cartilaginous and articulate with the

expanded transverse processes of the ninth or sacral vertebra. Each limb of the V is an ilium; the united posterior part consists of a fused pair of ischia, and a ventral cartilaginous pubic portion. Ilium, ischium, and pubis unite in bounding the deep socket or acetabulum with which the femur articulates.

The skeleton of the hind-limb consists of a thigh bone or femur, a lower leg formed from the united tibia and fibula, an ankle region or tarsus including two long proximal elements—the astragalus or tibiale and the calcaneum or

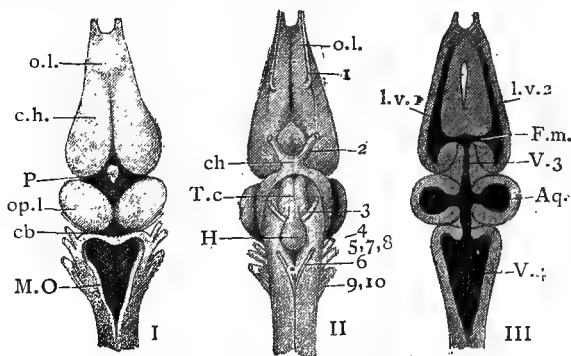

FIG. 318.—Brain of frog.—After Wiedersheim.

- I. DORSAL ASPECT.—*o.l.*, Olfactory lobes; *c.h.*, cerebral hemispheres; *P.*, pineal body, rising from region of optic thalami; *op.l.*, optic lobes; *cb.*, rudimentary cerebellum; *M.O.*, medulla oblongata.
- II. VENTRAL ASPECT.—The numbers indicate the origins of the nerves. *ch.*, Optic chiasma; *T.c.*, tuber cinereum (infundibulum); *H.*, hypophysis.
- III. HORIZONTAL SECTION.—*l.v.*, 1 and 2, lateral ventricles of cerebrum; *F.m.*, foramen of Monro; *V.*, 3 and 4, third and fourth ventricles; *Aq.*, cavities of optic lobes and aqueduct of Sylvius from third to fourth ventricle.

fibulare—and three imperfectly ossified distal elements, five metatarsal bones, and five toes. The first toe or hallux has two phalanges, the second also two, the third three, the fourth four, the fifth three, and, finally, outside the hallux there is a “calcar,” which looks like an extra toe, and consists of three pieces. The astragalus is in line with the first toe. The long bones of the skeleton show readily separable calcified terminal caps.

Muscular system.—The muscles are enswathed in connective tissue. They consist of bundles of striated fibres, and at their ends or at one of them they are usually continued into tendons,

which are more or less directly attached to parts of the skeleton.

For an account of the musculature of Vertebrate types, the student is referred to the guides to practical work cited in the Appendix.

Nervous system.—The brain, covered with a darkly pigmented pia mater, has the usual five parts.

The elongated cerebral hemispheres have "olfactory lobes" in front of them, and are connected by anterior and posterior commissures, and by a hint of a "corpus callosum" (?).

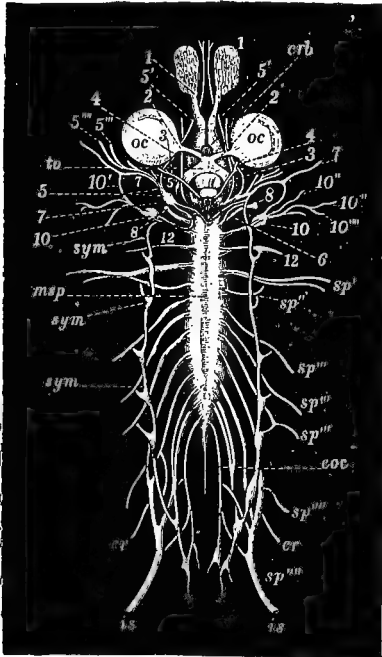

FIG. 319.—Nervous system of frog.—After Ecker.

1-10, The cranial nerves; *oc.*, eyes; *crb.*, in front of optic chiasma; *to.*, optic tract; *sym.*, sympathetic system; *map.*, spinal cord; *sp.*, spinal nerves.

The thalamencephalon gives origin dorsally to a pineal outgrowth. The pineal body lies outside the skull in the tadpole, but is partially atrophied in the adult, so that little more than the stalk is left. On the ventral side will be seen the chiasma or interlaced crossing of the optic nerves, and a tongue-shaped mass (the tuber

cinereum or infundibulum), to which the pituitary body is attached.

The optic lobes, a pair of oval bodies, between and below which is the iter.

The cerebellum, a very narrow transverse band.

The medulla oblongata, on the roof of which the pia mater forms a very vascular "choroid plexus."

The cavities of the brain and the canal of the spinal cord are in the adult lined by ciliated epithelium.

The cranial nerves are, as usual, on each side the following :—

- (1) Olfactory, from the olfactory lobe to the nose ;
- (2) Optic, crossing and interlacing with its fellow ;
- (3) Oculomotor, to four muscles of the eye ;
- (4) Pathetic, to the superior oblique eye muscle ;
- (5) Trigeminal, with ophthalmic, maxillary, and mandibular branches ;
- (6) Abducens, to the external rectus eye muscle ;
- (7) Facial, arising along with the auditory, with a ganglion uniting with the Gasserian ganglion of the trigeminal, with a palatine branch to the roof of the mouth, and a hyoid branch to the lower jaw ;
- (8) Auditory, to the ear ;
- (9) Glossopharyngeal, to the tongue and some of its muscles ; with a ganglion which unites with that of the tenth ;
- (10) Vagus, with branches to lungs, heart, stomach, etc.

The spinal cord gives origin to ten pairs of spinal nerves, and is swollen at the origin of those which go to the limbs. Around the union of the anterior and posterior roots lie sacs with crystals of carbonate of lime.

The sympathetic system consists of about ten pairs of ganglia—(a) united by branches to the spinal nerves ; (b) united to one another by longitudinal trunks which accompany the dorsal aorta and the systemic arches, and end anteriorly in the Gasserian ganglion ; (c) giving off branches to the heart, the aorta, and the viscera in the pelvic region.

Sense organs.—The eyes project on the top of the head and on the roof the mouth. There is a third eyelid. The transparent cornea in front, the firm sclerotic surrounding the eyeball, and the sheath of the optic nerve, are as usual continuous. The next layer includes the vascular and pigmented choroid and the brilliant iris. Internally is the sensitive retina, while vitreous humour fills the cavity behind the lens.

The internal ears have the usual parts, and lie within the auditory capsules, which are in great part bounded by the

pro-otics. Connecting the fenestra ovalis of the ear with the tympanic membrane, which is flush with the skin, there is a delicate bony rod—the columella. This lies in the Eustachian tube, which opens into the mouth at the corner of the gape.

The nostrils open into small nasal cavities, with folded walls of sensitive membrane; the posterior nares open into the front of the mouth.

There are taste papillæ on the tongue, and touch-spots on the skin.

Alimentary system.—The frog feeds in great part on insects, which it catches dexterously with its tongue. This is fixed in front and loose behind. There are teeth on the premaxillæ, maxillæ, and vomers. Into the cavity of the mouth the nasal sacs open anteriorly, and the Eustachian tubes posteriorly. The males of *Rana esculenta* have a pair of resonating sacs which open into the mouth cavity at the angle of the jaw, and are dilated during croaking. The tongue bears numerous taste papillæ. Behind the tongue on the floor of the mouth is the glottis, the opening of the short larynx which leads to the lungs. The larynx is supported by two arytenoid cartilages, and also by a ring; with the arytenoids the vocal cords are closely associated. The lungs lie so near the mouth that laryngeal, tracheal, and bronchial regions are hardly distinguishable. On the floor of the mouth is the hyoid cartilage, which serves for the insertion of muscles to tongue, etc.

Of the (4) gill-clefts which are borne on the walls of the pharynx in the tadpole, there are no distinct traces in the adult. The lungs develop as outgrowths from the gullet.

The gullet leads into a tubular stomach, which is not sharply separated from it. There is a pyloric constriction dividing the stomach from the duodenum, or first part of the small intestine. After several coils the small intestine opens into the wider large intestine or rectum, which enters the cloaca.

The liver has a right and a left lobe, the latter again subdivided. The gall-bladder lies between the right and left lobes; bile flows into it from the liver by a number of hepatic ducts, which are continued onwards to the duodenum in a common bile-duct. The pancreas lies in the mesentery

between stomach and duodenum, and its secretion enters the distal portion of the bile-duct. The bladder is a ventral outgrowth of the cloaca, has no connection with the ureters, and seems to be homologous with the allantois of Reptiles, Birds, and Mammals.

Vascular system.—The heart, enclosed in a pericardium, is three-chambered, consisting of a muscular conical ventricle, which drives the blood to the body and the lungs, of a thin-walled right auricle receiving impure blood from the body, and of a thin-walled left auricle receiving purified blood from the lungs. From each of the auricles blood enters the ventricle. The two superior venæ cavæ which bring back blood from the anterior regions of the body, and the inferior vena cava which brings back blood from the posterior parts, unite on the dorsal surface of the heart in a thin-walled sinus venosus, which serves as a porch to the right auricle. From the ventricle the blood is driven up a truncus arteriosus, which is at first single (the *pylangium*) and then multiple (the *synangium*).

Thus we may distinguish five regions in the heart,—the ventricle, the right auricle, the left auricle, the sinus venosus, and the truncus arteriosus. The sinus venosus is the hindmost, the truncus arteriosus the most anterior part. The opening of the pylangium into the ventricle is guarded by two semilunar valves; the cavity of the pylangium is incompletely divided by a longitudinal valve; there are also valves separating pylangium from synangium, and in the cavity of the latter. The complex mechanism is interesting because it determines the course of the blood leaving the ventricle. The truncus arteriosus corresponds, in part at least, to the conus arteriosus of many fishes.

As the heart continues to live after the frog is really dead, its contractions can be readily observed. The sinus venosus contracts first, then the two auricles simultaneously, and finally the ventricle. Although the ventricle receives both impure and pure blood, the structural arrangements are such that most of the impure blood is driven to the lungs, the purest blood to the head, and somewhat mixed blood to the body.

The blood contains in its fluid plasma—(a) the oval “red” corpuscles, with a definite rind, a distinct nucleus, and the pigment hæmoglobin; (b) white corpuscles or leucocytes, like small amœbæ in form and movements; (c) very minute bodies, usually colourless and variable in shape. When the blood clots, the plasma becomes a colourless serum, traversed by coagulated fibrin filaments,

the red corpuscles often arrange themselves in rows, and the white corpuscles are entangled in the coagulated shreds. When the web of a living frog is examined under the microscope, it will be seen that the flow of blood is most rapid in

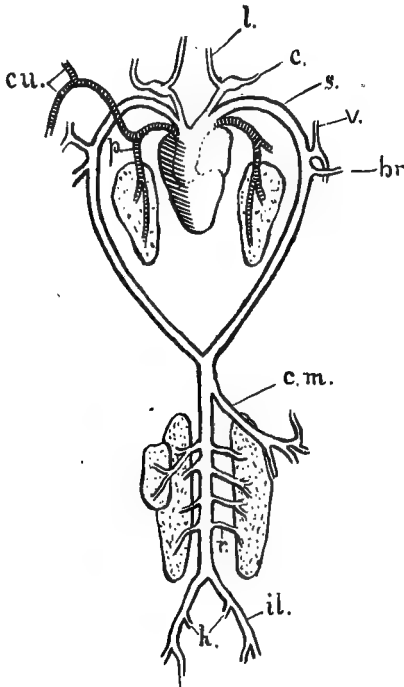

FIG. 320.—Arterial system of frog.

l., Lingual; **c.**, carotid; **s.**, systemic; **cu.**, cutaneous; **p.**, pulmonary; **v.**, occipito-vertebral; **br.**, brachial; **c.m.**, coeliacomesenteric; **r.**, renal; **il.**, common iliac; **h.**, hæmorrhoidal.

the arteries, more sluggish in the veins, most sluggish in the capillaries or fine branches which connect the arteries and the veins. The red corpuscles are swept along most rapidly, and are often deformed by pressure; the leucocytes tend to

cling to the walls of the capillaries, and may indeed pass through them (diapedesis).

The arterial system.—Each branch of the truncus arteriosus is triple, and divides into three arches:—

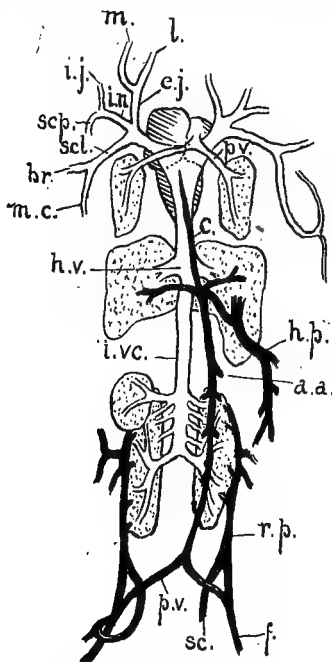

FIG. 321.—Venous system of frog.

m., *l.*, Mandibular and lingual; *e.j.*, external jugular; *i.j.*, internal jugular; *scp.*, subscapular; *in.*, innominate; *scl.*, subclavian; *br.*, brachial; *m.c.*, musculo-cutaneous; *h.v.*, hepatic vein; *h.p.*, hepatic portal; *a.a.*, anterior abdominal; *r.p.*, renal portal; *p.v.*, pelvic; *sc.*, sciatic; *f.*, femoral; *i.v.c.*, inferior vena cava; *c.*, cardiac vein.

I. The carotid arch, the most anterior, corresponding to the first efferent branchial of the tadpole, gives off—

A lingual artery to the tongue;

A carotid artery, which bears near the origin of the lingual a spongy swelling (the "carotid gland"), and gives off an

external carotid to the mouth and the orbit, and an internal carotid to the brain.

II. The systemic arch, the median one of the three, corresponding to the second efferent branchial in the tadpole, gives off—

The laryngeal artery to the larynx ;
 The œsophageal to the œsophagus ;
 The occipito-vertebral to the head and vertebral column ;
 The subclavian or brachial to the fore-limb.

From the left aortic arch, just as it unites with its fellow of the other side to form the dorsal aorta, or from the beginning of the dorsal aorta, there is given off the cœliaco-mesenteric to the stomach, intestine, liver, and spleen.

Farther back the dorsal aorta gives off—

The renal arteries to the kidneys, and the genital arteries to the reproductive organs ;

The inferior mesenteric to the large intestine.

Then it divides into two iliacs, each of which supplies the bladder (hypogastric), the ventral body wall (epigastric), and the leg (sciatic).

III. The pulmocutaneous arch, the most posterior, corresponding to the fourth efferent branchial in the tadpole, gives off—

the cutaneous artery to the skin,
 and the pulmonary artery to the lungs.

The venous system. — I. Each superior vena cava is formed from the union of three veins, and each of these three is formed from two smaller vessels.

Superior vena cava.	{	External jugular.	{	Lingual from the mouth and tongue.
				Mandibular from the lower jaw.
		Innominate.	{	Internal jugular from the inside of the skull.
				Subscapular from the back of the arm and the shoulder.
		Subclavian.	{	Brachial from the arm.
				Musculo-cutaneous from the skin and sides of the body.

II. The inferior vena cava begins between the kidneys, and ends in the sinus venosus. Its components are as follows :—

Inferior vena cava.	{	Efferent renal veins from the kidneys.
		Genital veins from the reproductive organs.
		Efferent hepatic veins from the liver.

The renal portal system, by which venous blood from the posterior region filters through the kidneys on its way back to the heart, is as follows on each side:—

Renal portal system.	{	A posterior branch of the femoral vein from the hind-limb forms the renal portal vein, which receives the sciatic from the back of the leg, and the dorso-lumbar veins from the dorsal wall of the body, and oviducal veins in the female.
----------------------	---	--

The anterior branch of the femoral vein is called the pelvic, and unites with its fellow of the opposite side, and gives origin to a median vein which runs to the liver—the anterior abdominal. By means of an anastomosing branch, the anterior branch of the femoral is also connected to the sciatic.

The hepatic portal system, by which venous blood from the posterior region and from the gut passes through the liver on its way back to the heart, is as follows:—

Hepatic portal system.	{	Anterior abdominal vein, from the union of the two pelvics, receiving tributaries from the bladder, ventral body wall, and truncus arteriosus.
		Hepatic portal vein, from the union of veins from the stomach, intestine, and spleen.

III. The pulmonary veins, which bring back purified blood from the lungs, unite just before they enter the left auricle. There are numerous valves in the veins of the frog.

Lymphatic system.—The lymph is a colourless fluid, like blood without red corpuscles. It is found in the spaces between the loose skin and the subjacent muscles, in the pleuro-peritoneal cavity in which heart, lungs, and other organs lie, in a sub-vertebral sinus extending along the backbone, and in special lymphatic vessels which pass fatty materials absorbed from the intestine into the venous system. There are two pairs of contractile “lymph hearts” at two regions where the lymphatic system communicates with the veins. A pair lie near the posterior end of the urostyle; the other two lie between the transverse processes of the third and fourth vertebræ. Their pulsations can be seen on the back of the living frog.

Mechanism of the heart.—The right half of the ventricle, being nearer the right auricle, contains more impure blood, and it is from the right side of the ventricle that the truncus arteriosus arises.

The middle of the ventricular cavity contains mixed blood. The left corner contains pure blood received from the pulmonary veins.

The various valves and the conditions of pressure are such that the venous blood passes by the pulmonary artery to the lungs, the next quantum of blood enters the systemic arches, and the nearly pure arterial blood from the left side of the ventricle passes into the carotids. To understand the mechanism, it is necessary to consult some book with a complete anatomical description, especially Gaupp's edition of Ecker and Wiedersheim's *Anatomie des Frosches* (1899).

Spleen, thyroid, and thymus.—The spleen is a small red organ lying in the mesentery near the beginning of the large intestine. The thyroid is represented by two little bodies near the roots of the aortic arches. The thymus, perhaps originally associated with the gill-clefts, lies on each side just behind the angle of the lower jaw.

Respiratory system.—The larval frog breathes at first through its skin, then by gills. The adult frog breathes chiefly by its lungs, but some cutaneous respiration is still retained, for even without its lungs a frog may live for some time, and it does not use them when hibernating.

The lungs arise as outgrowths of the œsophageal region of the gut, and are connected with the back of the mouth by a short laryngo-tracheal tube, whose slit-like aperture is the glottis. Each lung is a transparent oval sac, with muscle fibres in its walls. The cavity is lessened by the spongy nature of the internal walls, which form numerous little chambers bearing the fine branches of blood vessels.

In respiration the mouth is kept shut, and air passes in and out through the nostrils. A frog will die of asphyxia if its mouth be artificially kept open for a considerable time. When the floor of the mouth is lowered, and the buccal cavity thus increased, air passes in. When the nostrils and the opening of the gullet are shut, and the floor of the mouth at the same time raised, air is forced through the glottis into the lungs. When the pressure on the lungs is relaxed, and when the muscles of the sides of the body contract, the air passes out. •

Excretory system.—The paired kidneys are elongated organs situated dorsally and posteriorly beside the urostyle. The waste products which they filter out of the blood pass backward by two ureters which open separately on the dorsal wall of the cloaca, and are not directly connected with the bladder. The ureter or Wolffian duct is seen as a white line along the outer side of each kidney; in the male it functions also as the duct of the testis. On the ventral surface of each kidney is a longitudinal yellowish

streak, the adrenal gland, and little spots mark ciliated apertures or nephrostomes, which remain as communications between the abdominal cavity and the renal veins, though they are originally connected with the urinary tubules. There are also, as in higher Vertebrates, openings from the abdominal cavity into the lymphatic system.

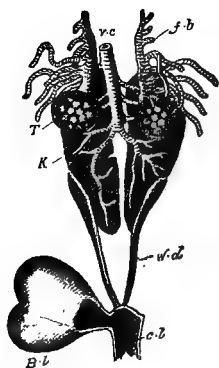

FIG. 322.—Urogenital system of male edible frog.—After Ecker.

f.b., Fatty bodies; *v.c.*, vena cava; *T.*, testis; *K.*, kidney; *w.d.*, Wolffian duct; *cl.*, cloaca; *Bl.*, bladder.

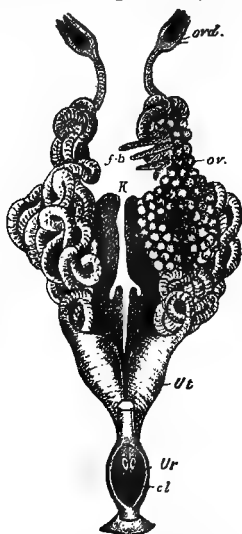

FIG. 323.—Urogenital system of female frog.—After Ecker.

ovd., Opening of oviduct; *ov.*, ovary; *f.b.*, fatty body; *K.*, kidney; *Ut.*, uterus; *Ur.*, opening of ureters into cloaca (*cl.*), in front of the openings of the oviducts.

Reproductive system.—The males are distinguishable from the females by the swollen cushions on the first fingers. At the breeding season in spring, they trumpet to their mates. The male clasps the female with his fore-limbs, and retains his hold for several days, fertilising the ova as they pass out into the water.

The paired testes are oval yellowish bodies lying in front of the kidneys; the spermatozoa pass by vasa efferentia

through the anterior part of the kidney into the Wolffian duct, which functions both as a ureter and as a vas deferens. In the male of *R. esculenta* the vas deferens is dilated for some distance after leaving the kidney; in *R. temporaria* it bears on the outer side near the cloaca a dilated glandular mass or "seminal vesicle." In the males, rudiments of the Müllerian ducts are sometimes seen. In the male toad a small rudimentary ovary, known as Bidder's organ, occurs at the anterior end of the testis.

The paired ovaries when mature are large plaited organs, bearing numerous follicles or sacs containing the pigmented ova. The spawn laid by a single frog may consist of several thousand eggs. The ripe ova are liberated into the body cavity, and moved anteriorly towards the heart, near which the oviducts open. The movement of the ova is mainly due to the action of peritoneal ciliated cells, which converge towards the mouths of the oviducts, but partly to muscular contraction, including the beating of the heart. The oviducts are long convoluted tubes, anteriorly thin-walled and straight, then glandular and coiled, terminally thin-walled and dilated. In the median part the ova are surrounded with jelly; the terminal uterine parts open on the dorsal wall of the cloaca. In the females the Wolffian ducts act solely as ureters. Attached to the anterior end of the reproductive organs are yellow, lobed, "fatty bodies," largest in the males. It has been suggested that they contain stores of reserve material, which is absorbed at certain seasons. They seem to be fatty degenerations of the anterior part of the genital ridges. The head kidney or pronephros persists for some time in the embryo, but eventually degenerates. It does not seem to have anything to do with the fatty bodies.

Development of the frog.—The ripe ovum exhibits "polar differentiation"; its upper portion is deeply pigmented, the lower has no pigment and contains much yolk. This yolk-containing hemisphere is the heavier, and consequently is always the lower half of the egg, however this may be turned about. Round the ovum there is a delicate vitelline membrane, and this is again surrounded by a gelatinous investment which swells up in water. The formation of polar bodies takes place before the liberation of the eggs.

The spheres of jelly preserve the eggs and embryos from friction, prevent their being eaten by most birds, appear to be distasteful to Gammarids, and often enclose in their interspaces groups of green Algæ, which help in aeration. The spheres may also be of use in relation to the absorption and radiation of heat.

Fertilisation occurs immediately after the eggs are laid. The spermatozoa, which exhibit the usual features of male elements, work their way through the gelatinous envelopes, and one fertilises each ovum.

The first cleavage is vertical, and divides the ovum into a right and a left half. If one of these two cells be punc-

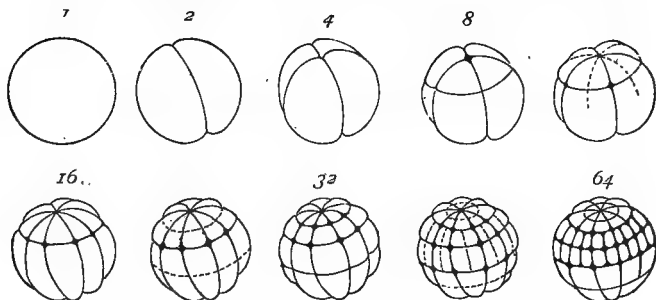

FIG. 324.—Division of frog's ovum.—After Ecker.

The numbers indicate the number of cells or blastomeres.

tured, and the ovum be kept still, the other half will, according to Roux, form a one-sided half-embryo. At a certain stage Roux's half-embryo regenerated the missing half, usually by re-vitalising the remains of the cell which was punctured. If the ovum be shaken about after puncturing, a readjustment of material is effected, and a half-sized embryo is formed (Morgan). The second cleavage is also vertical, and at right angles to the first, dividing an anterior from a posterior half. The third cleavage is equatorial, at right angles to the first two, dividing the dorsal region from the ventral.

The segmentation is total but unequal, and results in the formation of a ball of cells, those of the upper hemisphere being smaller and more numerous than the yolk-laden cells

below. Within there is a small segmentation cavity. Since the presence of yolk acts as a check on the activity of the protoplasm, we can understand why the smaller cells continue to divide much more rapidly than the large yolk-containing cells, and so how the smaller epiblastic cells gradually spread over the egg, covering in the larger ones. At one point, where upper and lower cells meet, a groove is formed. This groove represents the dorsal lip of the blastopore. It becomes crescentic and moves as a whole down over the large yolk-cells. Invagination of the small cells of the upper hemisphere goes on rapidly all round this crescentic groove, and the archenteron is thus formed. The

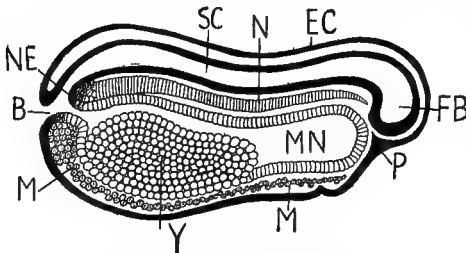

FIG. 325.—Longitudinal vertical section of frog embryo, shortly before closure of blastopore.—After Ziegler's model and Marshall.

FB., fore-brain; *EC.*, ectoderm; *N.*, notochord; *SC.*, canal of spinal cord; *NE.*, neurenteric canal; *B.*, blastopore; *M.*, mesoderm cells; *Y.*, Yolk-laden cells; *MN.*, mesenteron; *P.*, beginning of pituitary invagination.

horns of the crescent meet at a point near the lower pole of the egg to form the ventral lip of the blastopore. The blastopore now becomes reduced, by the ingrowing of its margins, to a small circular area which appears white, the colour being due to a plug of yolk-cells which almost obliterates its

opening. The whole egg now rotates backwards through a little more than a right angle, so that the blastopore is carried up into the position previously occupied by the first trace of its dorsal lip. The blastopore now marks the posterior end of the embryo. The archenteron has by this time greatly enlarged, and has pushed the segmentation cavity almost out of existence. The embryo elongates slightly, but the mass of yolk-laden cells which lie on the floor of the gut prevents the body acquiring at once the fish-like shape.

Along the mid-dorsal line the usual neural plate forms the medullary canal. At the posterior end this communicates with the archenteron for a time by the neurenteric canal.

Internally, a differentiation of hypoblast forms the notochord along the mid-dorsal line of the archenteron. At each side of this lie masses of mesoblast which have been split off from the hypoblast. Each of these divides into the primitive segments (proto-vertebræ) above, and the unsegmented lateral plates below. The lateral plates split into two layers, the splanchnic or inner investing the gut, the somatic or outer layer being applied to the epiblast; the space between the two layers is the body cavity. The body now becomes distinctly divided into regions, the eyes bud out from the brain, a rudiment of the gills appears, and the larva, still within its gelatinous case, exhibits peculiar lashing movements of the tail.

Eventually, about a fortnight after the eggs are laid, the larva escapes from the surrounding jelly and swims in the water. At this stage and for some time the ectoderm is ciliated. There is a cloacal opening, but the mouth is not yet more than a dimple. A glandular crescent, often mis-named a sucker, lies on the under surface of the head, and secretes a sticky slime, by means of which the tadpole attaches itself to foreign objects. The protruding gills soon become branched. There are three of them on each side, the first the largest. They are covered with ectoderm, and are borne on the outside of the first

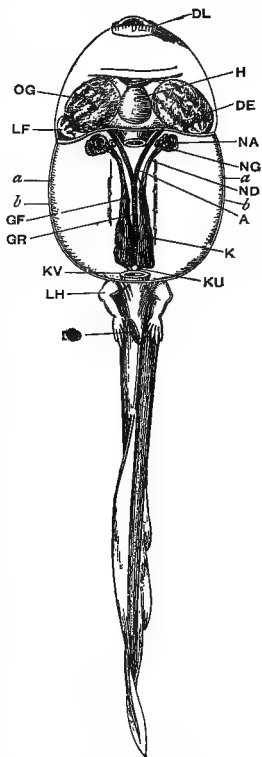

FIG. 326. — Dissection of tadpole. — After Milnes Marshall and Bles.

DL., Lower lip; *H.*, ventricle of heart; *DE.*, oesophagus; *NA.*, head kidney; *A.*, aorta; *K.*, kidney; *KU.*, ureter; *DO.*, cloaca; *LH.*, hind-limb; *KV.*, opening of ureter into cloaca; *GR.*, genital ridge; *GF.*, fatty body; *LF.*, fore-limb; *OG.*, gills; *a.*, epidermis; *b.*, dermis.

three branchial arches. The mouth, which has previously been merely a blind pit, opens into the gut, the gut itself lengthens rapidly, and becomes coiled like a watch-spring; the larvæ feed eagerly on vegetable matter and increase in size. The glandular crescent forms two small discs, which gradually disappear as the power of locomotion increases. About the time when the mouth is opened, four gill clefts open from the pharynx to the exterior.

A second period, the true tadpole stage, now begins. A skin-fold or operculum covers the external gills, which then atrophy, and are replaced by "internal" gills developed on the ventral halves of four branchial arches. These gills, though called internal, are covered with ectoderm like their predecessors, and are comparable not to ordinary fish-gills, but to the external gills of *Polypterus*, *Protopterus*, and *Lepidosiren*. The mouth acquires horny jaws, and the fleshy lips bear horny papillæ. By the continued growth of the opercular fold the gill-chambers are closed, with the exception of a single exhalant aperture on the left side. Through this opening, the water which is taken in by the mouth in respiration passes outwards, having washed the gills on its way.

In the third period the rudiments of the limbs appear. The fore-limbs are concealed within the gill-chambers, and so are not obvious until later; but the hind-legs may be watched in the progress of development from small papillæ to the complete limb.

The lungs are developed as outgrowths from the œsophagus, even before hatching, but grow very slowly. After the appearance of the hind-legs, the larvæ come to the surface of the water to breathe, showing that the lungs are now to some extent functional. At this stage the tadpoles, now about two months old, are at the level of Dipnoi.

The changes in the relations of the blood vessels, which accompany the successive changes in the methods of respiration, and render these possible, are somewhat complicated.

When respiration is by the gills only, the circulation

is essentially that of a fish. From the two-chambered heart the blood is driven by afferent branchials to the gills; from these it collects in efferent vessels which unite on each side to form two aortæ. The aortæ send arteries to the head, and passing backwards unite to form the single dorsal aorta which supplies the body. For a time there are two dorsal aortæ. When the first set of gills is replaced by the second set, new gill-capillaries are developed, but the circulation remains the same. As in *Ceratodus*, a pulmonary artery arises from the fourth efferent branchial. At the time when the hind-legs begin to be developed, a direct communication is established between afferent and efferent branchial vessels, so that blood can pass from the heart to the dorsal aorta without going through the gills. As the pulmonary circulation becomes increasingly important, the single auricle of the heart becomes divided into two by a septum, and the pulmonary veins are established. At the time of the metamorphosis an increasing quantity of blood avoids the gills in the manner indicated above, and these, being thrown out of connection with the rest of the body, soon atrophy, while the lungs become the important respiratory organs. The fate of the various branchial arteries is shown in the table on the following page.

The tadpole has by this time grown large and strong, feeding in great part on water-weeds. Now it seems to fast, but the tail, which begins to break up internally, furnishes, with the help of phagocytes, some nourishment to other parts of the body. The habit becomes less active, the structural adaptations to the aquatic life disappear. "The horny jaws are thrown off; the large frilled lips shrink up; the mouth loses its rounded suctorial form and becomes much wider; the tongue, previously small, increases considerably in size; the eyes, which as yet have been beneath the skin, become exposed; the fore-limbs appear, the left one being pushed through the spout-like opening of the branchial chamber, and the right one forcing its way through the opercular fold, in which it leaves a ragged hole" (Marshall).

SKELETAL ARCHES.	CLEFTS.	AORTIC ARCHES IN THE EMBRYO.	AORTIC ARCHES IN THE ADULT.
Mandibular.	...	Late in development vessels appear which represent a modification of those of a branchial arch.	Only a trace persists.
Hyoid.	Eustachian tube.	The arch is represented in a less modified form.	Disappears entirely.
First branchial.	First cleft.	First branchial arch.	Carotid arch.
Second branchial.	Second cleft.	Second "	Systemic arch.
Third branchial.	Third cleft.	Third "	Atrophies.
Fourth branchial.	Fourth cleft.	Fourth "	Pulmo-cutaneous.

While these changes are in progress, and as the supply of food afforded by the tail begins to be exhausted, the tadpole recovers its appetite, but is now exclusively carnivorous, feeding on any available animal matter, or even on its fellows. The change is not, however, so great as it seems, for even at a very early stage animal food is eagerly devoured.

With the change of diet, the abdomen shrinks, stomach and liver enlarge, the intestine becomes relatively narrower and shorter. The tail shortens more and more, and as it does so the disinclination for a purely aquatic life seems to increase. Eventually it is completely absorbed, the hindlimbs lengthen, and the conversion into a frog is completed.

In the reduction of the tail the epidermis thickens and is partly cast, partly dissolved; the muscles break up, and their substance undergoes intracellular digestion or is dissolved in the body juices; the notochord is repeatedly bent on itself and is also disrupted; the same is true of nervous system and blood vessels. It is a pathological process which has become normal. Some credit the phagocytes with playing a very important part in the reduction of the tail; but others restrict their function to engulfing solid particles, such as pigment granules, and say that most of the material degenerates until it becomes almost liquid, when it passes directly into the vascular fluid.

In many respects the development of the tadpole is very interesting, especially because it is a modified recapitulation

of that transition from aquatic to aerial respiration which must have marked one of the most momentous epochs in the evolution of Vertebrates.

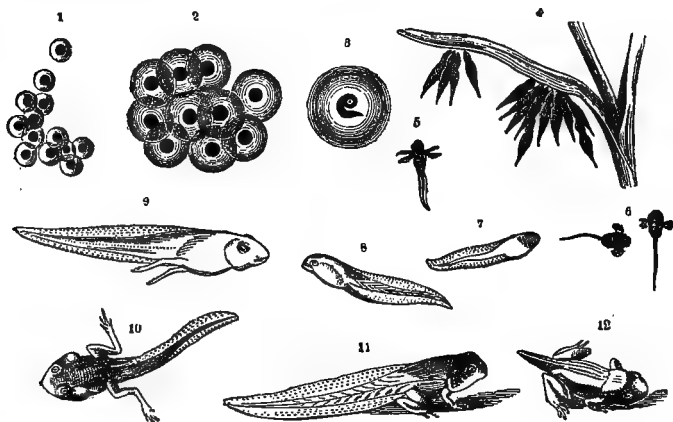

FIG. 327.—Life history of a frog.—After Brehm.

1-3, Developing ova; 4, newly hatched forms hanging to water-weeds; 5, 6, stages with external gills; 7-10, tadpoles during emergence of limbs; 11, tadpoles with both pairs of limbs apparent; 12, metamorphosis to frog.

CLASSIFICATION OF AMPHIBIA

Order ANURA or ECAUDATA

The adults have no tail or external gills or open gill-clefts. There are always four limbs.

Sub-order Phaneroglossa.—Tongue present; the Eustachian tubes open separately into the pharynx.

Series A. *Arcifera* (see p. 584), *e.g.* the toothless toads (*Bufo*); the tree-frogs (*Hyla*), with adhesive glandular discs on the ends of the digits; the obstetric frog (*Alytes*); *Bombinator*, *Pelobates*, and others.

Series B. *Firmisternia* (see p. 584), the frogs proper (*Ranidæ*), *e.g.* the grass-frog (*R. temporaria*), the edible frog (*R. esculenta*), the N. American bull-frog (*R. catesbiana*), sometimes 8 in. in length, and with a sonorous croak.

Sub-order Aglossa.—Tongueless; the Eustachian tubes have a common median aperture into the pharynx. The Surinam toad (*Pipa americana*), and the allied African genus *Xenopus*.

Order URODELA or CAUDATA

The tail persists in adult life; the larval gills and gill-slits may also persist; the limbs are weak when compared with those of Anura, and the hind pair may be absent.

Family 1. Amphiumidæ.—The N. American *Amphiuma*, with two pairs of rudimentary legs, with a slit persisting in adult life as a remnant of the gilled state; *Cryptobranchus maximus*, the largest living Amphibian, found in Japan and Thibet, attains a length of over 3 ft.

Family 2. Salamandridæ.—*Salamandra maculosa* and *S. atra*, both European, both viviparous; the usually oviparous newts—*Triton* or *Molge*—of which *Triton alpestris* becomes sexually mature while still larval (*pædogenesis*). *Desmognathus fusca*, the common lungless water salamander of the United States, lays its eggs in a wreath which the female twines round its body. The N. American *Amblystoma*, with its sometimes persistent larval form the Axolotl, formerly thought to be a different species.

Family 3. Proteidæ.—With persistent gills. Several species of *Proteus* inhabit the caves of Carinthia and Dalmatia. There are two pairs of limbs. The eyes are degenerate and the skin white, as we should expect in cave-animals. Two species of *Necturus* (or *Menobranchnus*) occur in N. American rivers and lakes.

Family 4. Sirenidæ.—Two extant genera, *Siren* and *Pseudobranchus*, both N. American, both with persistent gills, and only anterior limbs. Papillæ in the lower dermic layer in *Siren*, hidden by looser superficial dermis and epidermis, look like vestiges of ancestral scales.

Order GYMNOPHIONA or APODA

Worm-like or snake-like forms, subterranean in habit; without limbs or girdles; with extremely short tail; with dermic calcified scales concealed in transverse rows in the skin; in at least some forms (*Hypogeophis*) external gills are present in the very young stages, but disappear before hatching; there may be no larval stage; if there is, the respiration is pulmonary. There are many other striking peculiarities:—the eyes are small, covered up, and functionless; there is no tympanum or tympanic cavity; there is a peculiar protrusible tentacle in a pit behind the nostril; there are only two pairs of aortic arches (systemic and pulmonary). The notochord is largely persistent; the vertebræ are amphicelous; the frontals are distinct

from the parietals; the palatines are fused with the maxillæ. The eggs are large and meroblastic. They are altogether peculiar archaic Amphibians. Examples:—*Cæcilia* (S. America); *Ichthyophis* (Ceylon, India, Malay); *Hypogeophis* (E. Africa); *Siphonops*, without scales (America).

Order STEGOCEPHALI

Extinct forms, occurring from Carboniferous to Triassic strata. The earliest known digitate animals.

Dermal armour is present, the teeth are frequently folded in a complex manner (Labyrinthodonts). *Mastodonsaurus*, *Dendroperon*, *Archegosaurus*, *Branchiosaurus*.

LIFE OF AMPHIBIANS

Most Amphibians live in or near fresh-water ponds, swamps, and marshes. They are fatally sensitive to salt. Even those adults which have lost all trace of gills are usually fond of water. The tree-toads, such as *Hyla*, are usually arboreal in habit, while the Gymnophiona and some toads are subterranean.

The black salamander (*Salamandra atra*) of the Alps lives where pools of water are scarce, and instead of bringing forth gilled young, as its relative the spotted salamander (*S. maculosa*) does, bears them as lung-breathers, and only a pair at a time. The unborn young have gills which are pressed against the vascular wall of the uterus. It is said that the respiration (and nutrition) of the young is helped by crowds of red blood corpuscles which are discharged from the walls of the uterus; the debris of unsuccessful eggs and embryos seems also to be used for food.

Species of *Hylodes*, such as *H. martinicensis* of the West Indian Islands, live in regions where there are few pools. In such cases the development is completed within the egg-case, and a lung-breathing tailed larva is hatched in about fourteen days.

In some Mexican and N. American lakes there is an interesting amphibian known as *Amblystoma* or *Siredon*. It has two forms—one losing its gills (*Amblystoma*), the other retaining them (Axolotl). Both these forms reproduce, and both may occur in the same lake. Formerly they were referred to different genera. But the fact that some Axolotls kept in the Jardin des Plantes in Paris lost their gills when their surroundings were allowed to become less moist than usual, led

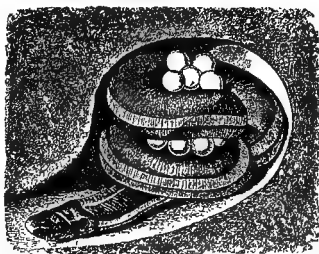

FIG. 328.—Cæcilian (*Ichthyophis*) with eggs.—After Sarasin.

naturalists to recognise that the two forms were but different phases of one species. It has been shown repeatedly that a gilled Axolotl may be transformed into a form without gills; and this metamorphosis seems to occur constantly in one of the Rocky Mountain lakes. Abundant food and moisture favour the persistence of the Axolotl stage.

Amphibians are very defenceless, but their colours often conceal them. Not a few have considerable power of colour-change. The secretion of the skin is often nauseous, and therefore protective. In a few cases, such as *Ceratophrys dorsata*, there is a bony shield on the back made of a number of small pieces arising as ossifications of the inner stratum of the dermis and of the subcutaneous connective tissue. It is interesting to notice the occurrence of numerous hair-like filaments on the sides and thighs of the males of a Kamerun frog (*Astylosternus robustus*).

Many Amphibians live alone, but they usually congregate at the breeding seasons, when the amorous males often croak noisily. Alike in their love and their hunger, they are most active in the twilight.

Their food usually consists of worms, insects, slugs, and other small animals, but some of the larval forms are for a time vegetarian in diet. They are able to survive prolonged fasting, and many hibernate in the mud. Though the familiar tales of "toads within stones" are for the most part inaccurate, there is no doubt that both frogs and toads can survive prolonged imprisonment. Besides having great vital tenacity, Amphibians have considerable power of repairing injuries to the tail or limbs.

Although the life of Amphibians seems to have on an average a low potential, even the most sluggish wake up in connection with reproduction. The males often differ from their mates in size and colour. Some of their parental habits seem like strange experiments.

Thus in the Surinam toad (*Pipa americana*) the large eggs are fertilised internally and placed by the everted cloaca of the female upon the back, the male apparently helping in the process. The skin becomes much changed—doubtless in response to the strange irritation—and each fertilised ovum sinks into a little pocket, which is closed by a gelatinous lid. In these pockets the embryos develop, perhaps absorbing some nutritive material from the skin. They are hatched as miniature adults. In *Nototrema* the female has a dorsal pouch of skin opening posteriorly, and within this tadpoles are hatched. In *Rhinoderma darwinii* the male carries the ova in his capacious croaking-sacs. In the case of the obstetric toad (*Alytes obstetricans*), not uncommon in some parts of the Continent, the male carries the strings of ova on his back and about his hind-legs, buries himself in damp earth until the development of the embryos is approaching completion, then plunges into a pool, where he is freed from his living burden.

In the Anura the ova are fertilised by the male as they leave the oviduct; in most Urodela fertilisation is internal, sometimes by approximation of cloacæ, sometimes by means of complex spermatophores which the male deposits in the water close to the female.

The eggs of the frog are laid in masses, each being surrounded by a globe of jelly; those of the toad are laid in long strings; those of newts are fixed singly to water-plants; those of some tree-toads, such as *Hylodes*, are laid on or under leaves in moist places.

There are about 900 living species of Amphibia, most of them tailless. All are averse to salt water, hence their absence from almost all oceanic islands. The anura are well-nigh cosmopolitan; the Urodela are almost limited to the temperate parts of the northern hemisphere.

History.—It is likely that Amphibians were derived from a Piscine stock related to the Dipnoi and perhaps also to the Crossopterygians. The Stegocephali were the first pentadactyl animals (Lower Carboniferous). Of living forms, the Gymnophiona are more old-fashioned than the others. The modern types gradually appear in Tertiary times. Some of the extinct forms were gigantic.

Huxley emphasised the following affinities between Amphibians and Mammals:—The Amphibia, like Mammals, have two condyles on the skull; the pectoral girdle of Mammals is as much amphibian as it is sauropsidian; the mammalian carpus is directly reducible to that of Amphibians. In Amphibians only does the articular element of the mandibular arch remain cartilaginous; the quadrate ossification is small, and the squamosal extends down over it to the osseous elements of the mandible, thus affording easy transition to the mammalian condition of these parts. But Mammals are, on the whole, more nearly related to Reptiles.

There are some remarkable affinities between the Stegocephali and some of the extinct Reptiles, such as the Anomodonts, which in their turn have affinities with Mammals.

CHAPTER XXIV

CLASS REPTILIA

CHELONIA. RHYNCHOCEPHALIA. LACERTILIA. OPHIDIA.
CROCODILIA. MANY EXTINCT ORDERS

THE diverse animals—Tortoises, Lizards, Snakes, Crocodilians, etc.—which are classed together as Reptiles, are the modern representatives of those Vertebrates which first became independent of the water, and began to possess the dry land. While almost all Amphibians spend at least their youth in the water, breathing by gills, this is not necessary for Reptiles, in which embryonic respiration is secured by a vascular foetal membrane known as the allantois. As in still higher Vertebrates, gill-slits are present in the embryos; but they are not functional, and are without gills. Reptiles seem to form among Vertebrates a great central assemblage, like “worms” among Invertebrates, more like a number of classes than a single class, exhibiting close affinities with Birds and Mammals, and more distant affinities with Amphibians.

Reptiles, Birds, and Mammals are distinguished, as Amniota, from Amphibians and Fishes, which are called Anamnia, the terms referring to the presence or absence of a protective foetal membrane—the amnion—with which another, the allantois, is always associated. Among other common characters the following may be noted:—the generally terrestrial habit, the absence of gills, the absence of a conus arteriosus, the breaking up of the ventral aorta, the presence of twelve cranial nerves, the importance of the hyo-mandibular gill-cleft.

SOME OF THE CONTRASTS BETWEEN ICHTHYOPSIDA, SAUROPSIDA, AND MAMMALIA

<p>ICHTHYOPSIDA. FISHES AND AMPHIBIANS.</p>	<p>SAUROPSIDA. REPTILES AND BIRDS.</p>	<p>MAMMALIA. MONOTREMES, MARSUPIALS, & PLACENTALS.</p>
<p>There is no amnion nor allantois, except in so far as the latter is represented by the cloacal bladder of Amphibians.</p> <p>There are gills, during early life at least.</p> <p>The scales of fishes are in great part dermic, while in almost all modern Amphibians there is no exoskeleton.</p> <p>There is a system of lateral sense organs, at least during early life.</p> <p>The vertebral column is often incompletely ossified; on the ends of the vertebral centra, etc., there are no separate ossifications or epiphyses. Much of the cartilaginous brain-box may persist; there is often a large parasphenoid; the basisphenoid is small or absent; the basioccipital is at most incompletely ossified; the condyle may be single or double, and in the latter case is due to the exoccipitals; at least four branchial arches are developed; there are usually several membrane bones present Meckel's cartilage. The sternum, if present, is not formed from the ventral ends of ribs.</p>	<p>The amnion of the embryo forms a protective membrane; the allantois secures embryonic respiration, and sometimes helps in absorbing food.</p> <p>Respiration is never discharged by gills.</p> <p>There is an epidermic exoskeleton of scales or feathers.</p> <p>No distinct trace of lateral line.</p> <p>There are rarely any epiphyses to the bones; there is no separate parasphenoid in the adult; the basisphenoid is a well-developed bone; the occipital region is completely ossified; there is a single (or sometimes triple) condyle formed from basioccipital and exoccipitals; in reptiles the pro-, epi-, and opisth-otic bones remain separate from one another, and fuse with adjacent bones; in birds they fuse with one another and with adjacent bones about the same time; the mandible consists of one cartilage bone—the articulare—and four to five membrane bones; it articulates with the skull by means of the quadrate. The sternum is formed from the ventral ends of ribs.</p>	<p>The amnion is in part a protective membrane, in part it aids the allantois in forming the placenta, which is developed in all Mammals except Monotremes and the majority of the Marsupials, in which the allantois is usually degenerate.</p> <p>Respiration is never discharged by gills.</p> <p>There is an epidermic covering of hair, in most cases well developed. Mammary glands are developed in the females.</p> <p>No distinct trace of lateral line system.</p> <p>There are epiphyses at the ends of the vertebral centra (except in Monotremes and Sirenia), and also at the ends of most of the bones; with two or three exceptions, there are seven cervical vertebrae; the otic bones fuse to form the complex petrotic; there are two condyles, usually formed from the exoccipitals, sometimes with the help of the basioccipital; the mandible of the adult is a single bone, articulating with the squamosal; there are three characteristic auditory ossicles—malleus, incus, and stapes—which perhaps correspond to the articular, quadrate, and hyomandibular of lower Vertebrates. Except in Monotremes, the coracoid is rudimentary; the sternum is homologous with that of Sauropsida.</p>
<p>There are but ten cranial nerves.</p> <p>The gut often ends in a cloaca.</p> <p>The heart is two- or three-chambered; there are at least two persistent aortic arches; the red blood corpuscles are oval and nucleated.</p> <p>The great majority are oviparous.</p> <p>The ova are generally numerous, with meroblastic or holoblastic segmentation.</p>	<p>There are twelve cranial nerves, except in snakes.</p> <p>The gut always ends in a cloaca.</p> <p>The heart is three- or four-chambered; in birds there is one aortic arch (to the right), in reptiles there are at least two aortic arches; the red blood corpuscles are oval and nucleated.</p> <p>Except a few reptiles, all are oviparous.</p> <p>The ova are large, with much yolk, usually with a calcareous shell, with meroblastic segmentation.</p>	<p>There are twelve cranial nerves.</p> <p>Only in Monotremes is there a true cloaca.</p> <p>The heart is four-chambered; there is one aortic arch (to the left); the red blood corpuscles are non-nucleated, and almost always circular; a muscular diaphragm separates thorax from abdomen.</p> <p>Except Monotremes, all are viviparous.</p> <p>Except in Monotremes, the ova are small, with little or no yolk, with holoblastic segmentation.</p>

Some of the main contrasts between living Reptiles and Birds are summarised in the following table:—

REPTILES.	BIRDS.
<p>The exoskeleton consists of horny epidermal scales, sometimes augmented by bony dermal scutes.</p> <p>The centra of the vertebræ are rarely like those of birds.</p> <p>When there is a sacrum, its vertebræ (usually two in number) have large expanded ribs with the ends of which the ilia articulate.</p> <p>The cartilaginous sternum may become bony, but is not replaced by membrane bones, unless perhaps in Pterodactyls.</p> <p>When there is an interclavicle or episternum, it remains distinct from the clavicle and sternum.</p> <p>The hand has more than three digits, and at least the three radial digits are clawed.</p> <p>In living reptiles the ilia are prolonged farther behind than in front of the acetabulum; the pubes slope downward and forward; there are usually pubic and ischiac symphyses.</p> <p>There are often five toes; the tarsals and the metatarsals remain distinct.</p> <p>At least two aortic arches persist; only the Crocodilia have a structurally four-chambered heart; more or less mixed blood always goes to the posterior body.</p> <p>The body has approximately the temperature of the surrounding medium.</p> <p>The optic lobes lie on the upper surface of the brain.</p>	<p>There is an outer covering of feathers, and though there may be a few scales, there are never scutes.</p> <p>The centra of the cervical vertebræ have usually a saddle-shaped terminal curvature.</p> <p>The two sacral vertebræ have no expanded ribs, they fuse with others to form a long composite "synsacrum."</p> <p>The cartilaginous sternum is replaced by membrane bone from several centres.</p> <p>When there is an interclavicle, it is confluent with the clavicles.</p> <p>The hand has not more than three digits, and at most two digits are clawed. The fore-limbs are modified as wings; some carpals fuse with the fused metacarpals.</p> <p>The ilia are greatly prolonged in front of the acetabulum, the inner wall of which is membranous. The pubes slope backwards, parallel with the ischia; only in <i>Struthio</i> is there a pubic symphysis, only in <i>Rhea</i> is there an ischiac one.</p> <p>There are not more than four toes; the proximal tarsals unite with the tibia, forming a tibio-tarsus; the first metatarsal if present is free, but the three others are fused to one another and to the distal tarsals, forming a tarso-metatarsus.</p> <p>There is but one aortic arch, to the right; the heart is four-chambered; the blood sent to the body is purely arterial.</p> <p>The body temperature is high and almost constant.</p> <p>The optic lobes lie on the sides of the brain.</p> <p>The lungs have associated air-sacs.</p> <p>The sutures between the bones of the skull are usually obliterated at an early stage.</p> <p>The right ovary atrophies.</p>

Order CHELONIA. Tortoises and Turtles

GENERAL CHARACTERS.—*The broad trunk is encased in the bones which form a dorsal and a ventral shield, within the*

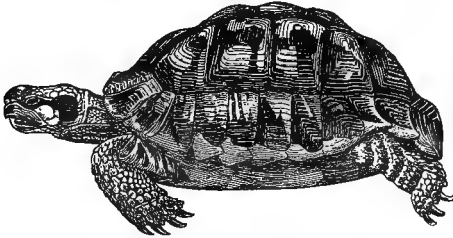

FIG. 329.—External appearance of tortoise.

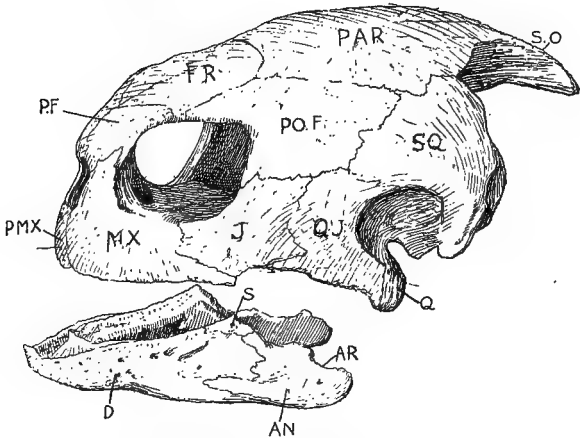

FIG. 330.—Skull of turtle.

S.O., supra-occipital; *PAR.*, parietal; *FR.*, frontal; *P.F.*, pre-frontal; *P.O.F.*, post-frontal; *SQ.*, squamosal; *PMX.*, pre-maxilla; *MX.*, maxilla; *J.*, jugal; *Q.J.*, quadrato-jugal; *Q.*, quadrate; *D.*, dentary; *AN.*, angular; *AR.*, articular; *S.*, surangular.

shelter of which the head and neck, tail and limbs, can be more or less retracted. The dorsal carapace is usually formed

from—(a) the flattened neural spines (plus dermal scutes); (b) expanded and more or less coalesced ribs (plus costal dermal scutes); (c) a series of dermal marginal scutes around the outer edge. In the *Athece* the dorsal vertebræ and ribs are not fused to the dermal plates which form the carapace. The ventral shield or plastron is formed of nine or so dermal bones. There is no sternum.

Overlapping, but not corresponding to the bony plates, there are (except in *Trionychia* and *Athece*) epidermic horny plates of "tortoise shell," which, though very hard, are not without sensitiveness, numerous nerves ending upon them.

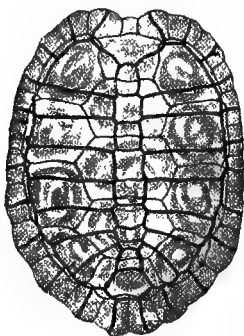

FIG. 331.—Carapace of tortoise.

The dark contours are those of the bony pieces; the lighter contours are those of the scales which have been removed.

The quadrate is immovably united with the skull. There is only a lower temporal arcade. The jaws are covered by a horny sheath, and are without teeth, though hints of these have been seen in some embryos. There is a single anterior nasal opening. The scapular arch is internal to the ribs. The limbs are pentadactyl, but often in the form of paddles.

The average life of Chelonians is sluggish. Perhaps this is in part due to the way in which the ribs are lost in the carapace, for this must tend to make respiration less active. The lungs are divided into a number of compartments.

The cloacal aperture is usually longitudinal, never transverse; the copulatory organ is unpaired.

All are oviparous. The eggs have firm, usually calcareous, shells.

Some Peculiarities in the Skeleton of Chelonia

The (10) dorsal vertebræ are without transverse or articular processes, and along with the ribs are for the most part immovably fused in the carapace. The tail and neck are the only flexible regions. There are two sacral vertebræ.

The greater part of the dorsal shield is due to a coalescence of eight ribs with eight costal plates derived from the dermis.

Similarly, the median pieces are the result of fusion between median dermal bones and the neural spines of the vertebræ. The plastron usually consists of nine dermal bones, and the three anterior pieces perhaps represent clavicles and interclavicle (or episternum).

The eight cervical vertebræ have at most little rudiments of ribs, are remarkably varied as regards their articular faces, and give the neck many possibilities of motion. There are no lumbar vertebræ.

The bones of the skull are immovably united; there is only a lower temporal arcade, formed by jugal and quadrato-jugal; there are no ossified alisphenoids, but downward prolongations of the large parietals

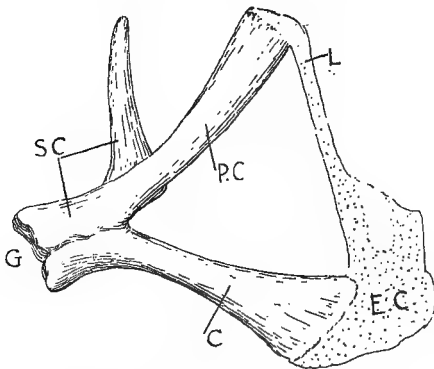

FIG. 332.—Pectoral girdle of a Chelonian.

G., Glenoid cavity; *SC.*, scapula; *P.C.*, procoracoid fused to the scapula; *C.*, coracoid; *E.C.*, epicoracoid cartilage; *L.*, ligament.

take their place; neither presphenoid nor orbitosphenoids are ossified; there are no distinct nasal bones in modern Chelonians, their place being taken by the prefrontals; the premaxillæ are very small; there are no teeth.

There is no sternum. The pectoral girdle on each side consists of a ventral coracoid and a dorsal scapula attached to the carapace. The scapula bears an anterior process of large size, usually regarded as a "precoracoid" or procoracoid.

The pelvic girdle consists of dorsal ilia attached to the carapace, posterior ischia, and anterior pubes, with pre-pubic processes and an epi-pubic cartilage. There is a pubic and an ischiac symphysis.

The girdles originally lie in front of, or behind the ribs, but are over-arched by the carapace in the course of its development.

Some Peculiarities in the Organs of Chelonia

In Chelonians and in all higher animals except serpents, there are twelve cranial nerves, for, in addition to the usual ten, a spinal accessory to cervical muscles, and a hypoglossal to the tongue, are ranked as the eleventh and twelfth.

The gullet of the turtle shows in great development what is hinted at in others, long horny papillæ pointing downwards; it is probable that these help to tear up the food (seaweed in the case of the turtle).

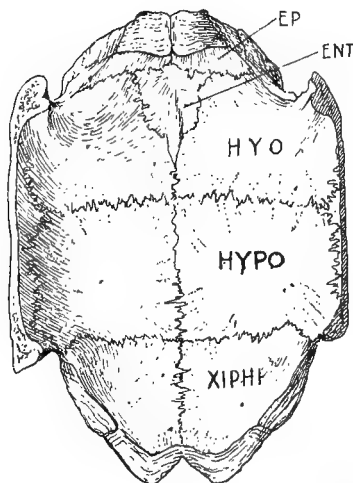

FIG. 333.—Internal view of the plastron of the Greek tortoise.

EP., Epiplastron (clavicle?); *ENT.*, entoplastron (inter-clavicle?); *HYO.*, hyoplastron; *HYPO.*, hypoplastron; *XIPHI.*, xiphiplastron.

The heart is three-chambered, but an incomplete septum divides the ventricle into a right portion, from which the pulmonary arteries and the left aortic arch arise, and a left portion, from which the right aortic arch issues. From the right aortic arch, which contains more pure blood than the left, the carotid and subclavian arteries are given off. The left aortic arch gives off the cœliac artery before it unites with the right.

The lungs are attached to the dorsal wall of the thorax, and have only a ventral investment of peritoneum; each is divided into a series

of compartments into which branches of the bronchus open. There is a slight muscular "diaphragm." The filling and emptying of the lungs is helped by the protrusion and retraction of the head and legs, but there are also "swallowing movements." There are no vocal chords, but there is sometimes a feeble voice.

In the males, the kidney, the epididymis, and the testes lie adjacent

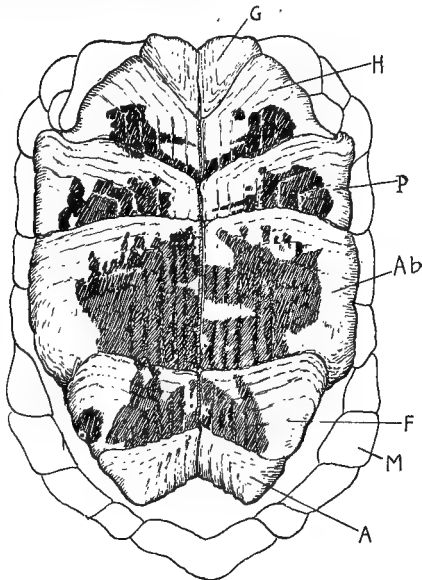

FIG. 334.—Scales on ventral surface of plastron of Greek tortoise.

G., Gular; H., humeral; P., pectoral; Ab., abdominal; F., femoral; A., anal; M., marginal.

to one another on each side. The males have a grooved penis attached to the anterior wall of the cloaca. There is a urinary bladder.

Classification of Chelonia

I. ATHECÆ. Vertebrae and ribs free from carapace. Skull without descending processes from parietals.

Sphargidæ, leathery-skinned turtles, with flexible carapace. *Sphargis* (*Dermatochelys*) *coriacea*, the only living species, the largest modern

Chelonian, sometimes measuring 6 ft. in length. It is widely, but now sparsely, distributed in intertropical seas, and is said to be herbivorous.

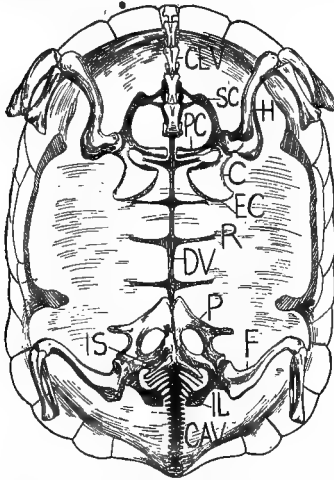

FIG. 335.—Internal view of tortoise skeleton.

H., humerus; *SC.*, scapula running dorsally; *PC.*, precoracoid; *C.*, coracoid; *EC.*, epicoracoid cartilage; *P.*, pubis; *IL.*, ilium running dorsally to sacral vertebrae; *IS.*, ischium; *DV.*, dorsal vertebrae fused in carapace; *R.*, head of a rib; *CEV.*, cervical vertebrae free; *CAV.*, caudal vertebrae free.

World, but not in Australia. In diet they are vegetarian. The common tortoise (*Testudo græca*) and the nearly exterminated giant tortoises of the Mascarene and Galapagos Islands are good representatives. The latter may reach the age of 150 years.

Order RHYNCHOCEPHALIA

The only *living* representative of this "class" is the New Zealand "Lizard" or Tuatara — *Hatteria* (*Sphenodon*) *punctata*. Lizard-

II. THECOPHORA.

Dorsal vertebrae and ribs fused in the carapace. Parietals prolonged downwards. Including the following and other families:—

Chelonidæ, marine turtles, with fin-like feet, and partially ossified carapace. They occur in intertropical seas, and bury their soft-shelled eggs on sandy shores. The green turtle (*Chelone viridis*) is much esteemed as food; the hawk's-bill turtle (*Caretta imbricata*) furnishes much of the commercial tortoise-shell.

Testudinidæ, land tortoises, with convex perfectly ossified carapace, and feet adapted for walking. They are found in the warmer regions of both the Old and the New

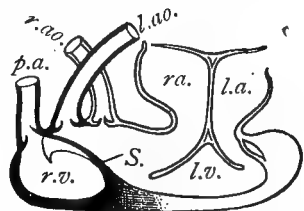

FIG. 336.—Dissection of Chelonian heart.—After Huxley.

r.v., Right half of ventricle; *S.*, septum; *l.v.*, left half of ventricle; *r.a.*, right auricle; *l.a.*, left auricle; *l.a.o.*, left aortic arch; *r.a.o.*, right aortic arch; *p.a.*, pulmonary arch.

like in appearance, it measures from one to two feet in length, has a compressed crested tail, is dull olive-green spotted with yellow above and whitish below. It is now rare, but is preserved in some small islands off the New Zealand coast. It lives in holes among the rocks or in small burrows, feeds on small animals, and is nocturnal in habit.

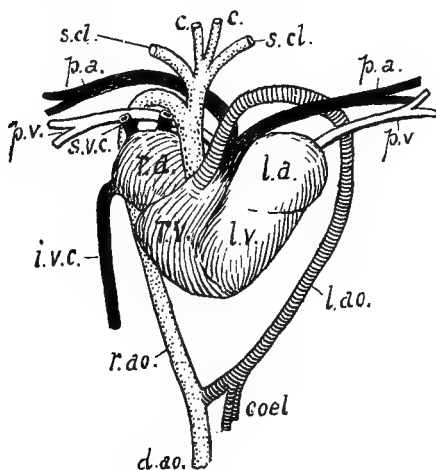

FIG. 337.—Heart and associated vessels of tortoise.—After Nuhn.

r.a., Right auricle; superior venæ cavæ (*s.v.c.*) and inferior vena cava (*i.v.c.*) enter it. *r.v.*, Right half of ventricle; pulmonary arteries (*p.a.*) and left aortic arch (*l.a.o.*) leave it; *coel.*, coeliac; *d.a.o.*, dorsal aorta. *l.a.*, Left auricle; *p.v.*, pulmonary veins enter it. *l.v.*, Left half of ventricle; right aortic arch (*r.a.o.*), giving off carotids (*c.*) and subclavians (*s.cl.*).

The skull, unlike that of any lizard, has an ossified quadrato-jugal, and therefore a complete infra-temporal arcade; the quadrate is firmly united to pterygoid, squamosal, and quadrato-jugal; the pterygoids meet the vomer and separate the palatines; there are teeth on the palatine in a single longitudinal row, parallel with those on maxilla and mandible, and the three sets seem to wear one another away; there is also a single tooth on each side of a kind of beak formed by the premaxillæ; the nares are divided.

The vertebræ are amphicelous or biconcave, as in geckos among lizards and in many extinct Reptiles. Some of the ribs bear uncinæ

processes, as in Birds; as in crocodiles, there are numerous "abdominal ribs," ossifications in the subcutaneous fibrous tissue of the abdomen. The anterior end of the "plastron" thus formed overlaps the posterior end of the sternum. The inner ends of the clavicle rest on a median episternum (interclavicle).

The pineal or parietal eye, which reaches the skin on the top of the head, is less degenerate than in other animals, retaining, for instance, distinct traces of a complex retina.

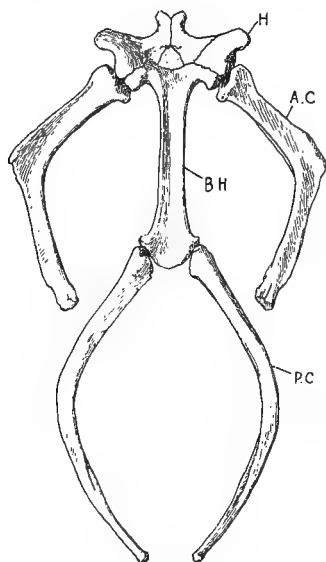

FIG. 338.—Hyoid apparatus of a Chelonian.

BH., Body of the hyoid (basihyal); *H.*, representing another part of the hyoid arch; *A.C.*, anterior cornu, representing the first branchial arch; *P.C.*, posterior cornu, representing the second branchial arch.

pelvic girdles are always present, in rudiment at least. There is a sternum and a T-shaped episternum. Unlike snakes, lizards have non-expandible mouths. The maxillæ, palatines, and pterygoids are fixed, and there is usually a mandibular symphysis. There are almost always

Near the living *Sphenodon*, the Permian *Palæohatteria*, the Triassic *Hyperodapedon*, and some other important types may be ranked. Along with these may be included the remarkable *Proterosaurus* from the Permian, though Seeley establishes for it a special order—Proterosauria, as distinguished from Rhynchocephalia. According to Baur, quoted by Nicholson and Lydekker, "the Rhynchocephalia, together with the Proterosauria, to which they are closely allied, are certainly the most generalised group of all Reptiles, and come nearest, in many respects, to that order of Reptiles from which all others took their origin."

Order LACERTILIA

Lizards

GENERAL CHARACTERS.

—*The body is usually well covered with scales. In most, both fore- and hind-limbs are developed and bear clawed digits, but either pair or both pairs may be absent. The pectoral and*

movable eyelids and external ear-openings. The teeth are fused to the edge or to the ridge of the jaws, never planted in sockets. The tongue, broad and short in some, e.g. Geckos and Iguanas, long and terminally clubbed in Chamæleons, is oftenest a narrow bifid organ of touch.

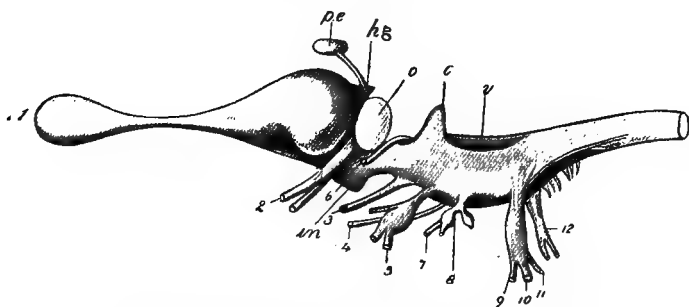

FIG. 339.—Lateral view of brain of *Hatteria punctata*.
—After Osawa.

1-12, Cranial nerves; *pe.*, parietal eye; *hg.*, pineal gland; *o.*, optic lobe; *c.*, cerebellum; *v.*, fourth ventricle; *in.*, infundibulum and pituitary body.

The opening of the cloaca is transverse. There is a urinary bladder, corresponding to that of the frog, and a double penis. Most are oviparous, but in a few the eggs are hatched within the body. They are usually active, agile animals, beautifully and often protectively coloured. The tail is readily thrown off by a reflex action; lost tails and even legs may be regenerated.



FIG. 340.—*Hatteria* or *Sphenodon*.—After Hayek.

The food generally consists of insects, worms, and other small animals, but some prey upon larger animals, and others are vegetarian. Most are terrestrial, some arboreal, a few semi-aquatic, and there is one marine form. Lizards are most abundant in the tropics, and are absent from very cold regions.

DESCRIPTION OF A LIZARD AS A TYPE OF REPTILES

The following description applies especially to the long-tailed green lizard (*Lacerta viridis*), found abundantly in Jersey, but, except in minor points, it will be found to apply equally to the small British grey lizard (*Lacerta agilis*) and to the viviparous lizard (*Lacerta vivipara*):—

Form and external features.—The depressed head is separated from the body by a distinct neck, but the posterior region of the body passes gradually into the long tail, which is often mutilated in captured specimens. Both fore- and hind-limbs are present, and both are furnished with five clawed digits. Of the apertures of the body, the large mouth is terminal, the external nares are close to the end of the snout, and the cloacal aperture is a considerable transverse opening placed at the root of the tail. There is no external ear, but the tympanic membrane at either side is slightly depressed below the level of the skin of the head. The eyes are furnished with both upper and lower eyelids, and also with a nictitating membrane.

Skin.—As contrasted with that of the frog, the skin has a distinct exoskeleton of epidermic scales, the external covering of which is shed from time to time. In the head region these exhibit a definite arrangement characteristic of the species. With the presence of an exoskeleton we must associate the absence of the numerous cutaneous glands of the frog. Peculiar tubular ingrowths of epidermis form a row of so-called “femoral glands,” which open by pores on the ventral surface of the thigh. Their product (débris of epidermic cells) is most obvious in the male at pairing time. The structure of the skin is very similar to that of the frog. Pigment is deposited here also in two layers, of which the outer is greenish, the inner black. Over the parietal foramen on the top of the skull the black pigment is absent, the green only feebly represented; in this region, therefore, the skin is almost transparent. In moulting—which means casting off the outermost portions of the scales—there is a distension of the blood vessels and a great increase of blood pressure.

Many lizards, such as the Chamæleons, exhibit in a remarkable degree the power of rapidly changing the colour of their skin. This is due to

the fact that the protoplasm of the pigment cells contracts or expands under nervous control. The change of colour is sometimes advantageously protective, but it seems often to be merely a reflex symptom of the nervous condition of the animals.

In many cases, *e.g.* in some of the skinks, in *Anguis*, *Heloderma*, there are minute dermal ossifications beneath the scales.

Skeleton.—The backbone consists of a variable number of vertebræ, and is divisible into cervical, dorsal, lumbar, sacral, and caudal regions. Except the atlas and the last caudal, all the vertebræ are procœlous, as in all living Lacertilians except Geckos, where they are amphicœlous.

The atlas consists of three separate pieces; its centrum ossifies as usual as the odontoid process of the axis. There are two sacral vertebræ with large expanded sacral ribs. To the ventral surfaces of many of the caudal vertebræ Y-shaped "chevron" bones are attached. Across the centre of the caudal vertebræ there extends a median unossified zone; it is in this region that separation takes place when a startled lizard loses its tail.

The ribs are numerous, but only five reach the sternum.

The skull is well ossified, but in the region of the nares, in the interorbital septum, etc., the primitive cartilaginous brain-box persists. On the dorsal surface the bones exhibit numerous impressions made by the epidermic scales, which render it difficult to distinguish the true sutures of the bones. As in Reptiles in general, the brain-case is small in comparison with the skull, and is largely covered by investing bones, between some of which are spaces or fossæ.

Two fused parietals with the rounded median "parietal foramen," two frontals, and the two nasals, are the most important constituents of the roof of the skull. Anteriorly, the premaxillæ appear between the nasals, while posteriorly the sickle-shaped squamosal is attached to a suture to the parietal, and is overlapped by one of the two small supra-temporal bones. The orbit is roofed by a series of small bones, of which the anterior and posterior are respectively known as pre- and post-frontal.

On the floor of the adult skull there is a large basal bone, composed of fused occipital and sphenoidal elements, and continued forward as a slender bar (parasphenoid). This bone gives off two stout processes, the basiptyergoid processes, which articulate with the pterygoids. Each pterygoid is connected posteriorly with the quadrate bone of the corresponding side, and anteriorly with the palatine. From the union of pterygoid and palatine, a stout os transversum or transpalatine extends outwards to the maxilla. In front of the palatines lie the small vomers, which, in their turn, articulate with the premaxilla and maxilla, both of

which are furnished with small pointed teeth. In the posterior region of the skull we have still to notice the large ex-occipitals with which the opisthotics are fused, and which are continued into the conspicuous parotic processes. The lateral walls of the brain-case are largely formed by the paired pro-otics. Internally, an important bone, the epipterygoid or "columella" (not to be confounded with the columella or stapes of the ear), extends from the pro-otic to the pterygoid. The orbit is

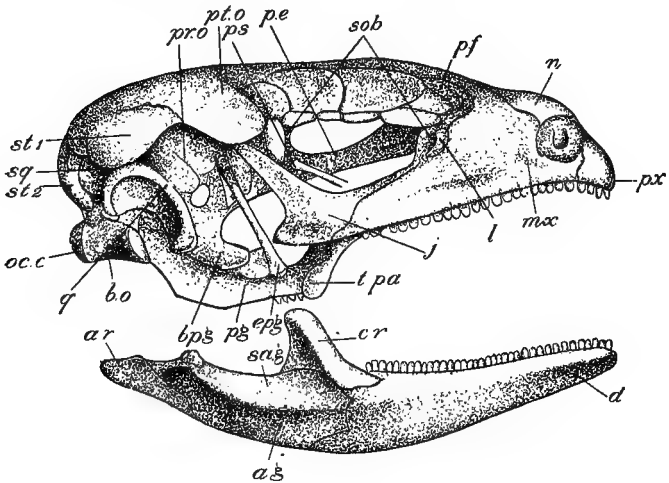

FIG. 341.—Side view of skull of *Lacerta*.—After W. K. Parker.

px., Premaxilla; *mx.*, maxilla; *l.*, lachrymal; *j.*, jugal; *t.pa.*, transpalatine; *epg.*, epipterygoid; *pg.*, pterygoid; *bpg.*, basipterygoid; *b.o.*, basioccipital; *q.*, quadrate; *occ.*, occipital condyle; *sq.*, squamosal; *pr.o.*, pro-otic; *pt.o.*, postorbital; *st.1.*, *st.2.*, supratemporals; *ps.*, presphenoid (the optic nerve is seen issuing in front of the end of the reference line); *p.e.*, mesethmoid; *s.ob.*, supraorbital; *pf.*, prefrontal; *n.*, nasal; *ar.*, articular; *ag.*, angular; *sag.*, surangular; *cr.*, coronary; *d.*, dentary.

bounded posteriorly and inferiorly by the jugals. There is no ossified quadrato-jugal, and thus the lateral temporal fossa is open below in the dried skull (contrast *Hatteria*). The other fossæ of the dried skull are the supra-temporal on the upper surface, and the posterior-temporal on the posterior surface.

Each half of the lower jaw is composed of six bones, which use in the adult. The two rami are sutured to one another in front.

Limbs and girdles.—In the shoulder-girdle, the flat coracoids, with an anterior precoracoid region, articulate with the sternum, which is represented by a cartilaginous plate of rhomboidal shape. Over it projects the long limb of the T-shaped episternum or interclavicle (a membrane bone), which, at the sides, is continued outwards by the curved clavicles. The remaining elements are the scapulæ, which are continuous with the cartilaginous supra-scapulæ.

The fore-limbs have the usual parts. In the carpus all the typical nine bones are represented, and there is in addition an accessory "pisiform" bone.

In the pelvic girdle, ilium, pubis, and ischium are represented as usual; there are both pubic and ischial symphyses.

In the tarsus the fibulare and tibiale are united, and the distal row consists of only two bones.

Nervous system.—The brain consists of the usual parts. The cerebellum is small and only partially overlaps the fourth ventricle. In the region of the thalamus the epiphysis is distinct and conspicuous, but in the adult the pineal body is quite separated from it, and lies in its connective tissue capsule below the skin.

Alimentary system.—Small pointed teeth are present on the maxillæ, premaxillæ, palatines, and on the lower jaw. They are fixed without sockets inside the edge of the jaw-bones (pleurodont); in many Lacertilians they are implanted along the ridge (acrodont). Salivary glands occur on the floor of the mouth cavity. The narrow gullet passes gradually into the muscular stomach, which again passes into the coiled small intestine. Near the commencement of the large intestine there is a small cæcum. A voluminous liver, with a gall-bladder embedded in it, and a pancreas, are present as usual.

Embedded in the mesentery below the stomach lies the rounded spleen. A whitish thyroid gland lies on the ventral surface of the trachea a short distance in front of the heart.

Vascular system.—The heart is completely enveloped by the pericardium, and is three-chambered, consisting of two thin-walled auricles and a muscular ventricle. From the ventral surface of the ventricle arises the conspicuous truncus arteriosus, which is formed by the bases of the aortic arches, and exhibits a division into two parts. From

the more ventral part arises the left aortic arch, which curves round to the left side, first giving off a short connecting vessel (*ductus Botallii*) to the carotid arch. From the other division of the truncus arteriosus, a great arterial trunk arises, and this gives off the right aortic arch and the right and left carotid arches. The right aortic arch sends a *ductus Botallii* to the carotid arch of the right side, and then curves round the heart to join the left arch, the two thus

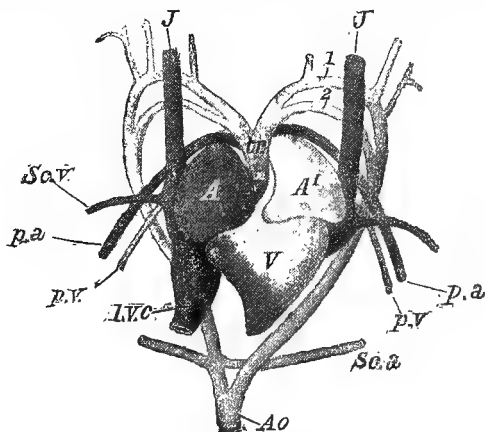

FIG. 342.—Heart and associated vessels of a lizard.
—After Nuhn.

A., Right auricle; jugulars (*J.*), subclavians (*Sc.v.*), and inferior vena cava (*I.V.C.*) enter it. *V.*, ventricle; *tr.*, truncus arteriosus; 1, first aortic arch giving off carotids; 2, second aortic arch; *p.a.*, pulmonary artery; *Sc.a.*, subclavian artery; *Ao.*, dorsal aorta. *A.1*, left auricle; pulmonary veins (*p.v.*) enter it. In the lizard described, the left jugular is not developed.

forming the dorsal aorta. The carotid arches supply the head region with blood. From the base of the truncus arteriosus, the right and left pulmonary arteries also arise (Fig. 342).

From the right aortic arch as it curves round, arise the right and left subclavian arteries, which carry blood to the fore-limbs. A cœliaco-mesenteric artery arises from the dorsal aorta and supplies the viscera. Smaller vessels are also given off to the genital organs, etc., and then at the anterior end of the kidneys the aorta divides into two femoral arteries, which break up into a network of small vessels, supplying hind-

limbs and kidneys, and finally, at the posterior end of the kidneys, reunite to form the caudal artery, which runs down the tail.

The blood from the anterior region of the body is returned to the heart by the right and left precaval veins or superior venæ cavæ. The right precaval is formed by the junction of external and internal jugulars with the subclavian vein; on the left side the jugular is absent. From the posterior region of the body, blood is brought back by the postcaval vein or inferior vena cava. The three great veins open into a thin-walled sinus venosus, which opens into the right auricle.

The postcaval is formed by the union of two veins which run along the genital organs, and receive renal veins from the kidneys. In passing through the liver the postcaval receives important hepatic veins.

From the tail region the blood is brought back by a caudal, which bifurcates in the region of the kidneys into two pelvics. The pelvic veins give off renal-portals to the kidneys, and receive the femoral and sciatic veins from the hind-limbs. They then unite to form the

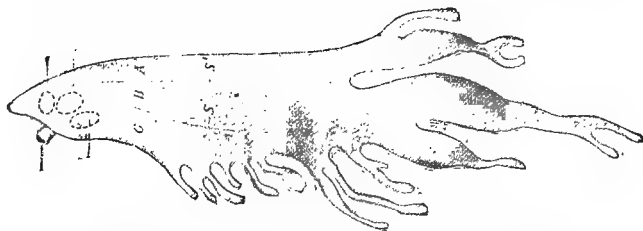

FIG. 343.—Lung of *Chamæleo vulgaris*, showing air-sacs.
—After Wiedersheim.

epigastric or anterior abdominal, which carries blood to the liver. Except through the medium of the renal-portal system, there is no connection between the anterior abdominal and the postcaval. To the liver, blood is carried as usual from the stomach, etc., by the portal vein.

From the lungs blood is brought to the left auricle by the pulmonary veins.

There is, as usual, a lymphatic system, including a pair of lymph hearts.

Respiratory system.—The lungs are elongated oval structures which taper away posteriorly. The mouth does not, as in the frog, play an important part in the respiratory movements. In some lizards (*Chamæleon* and *Geckos*) the lungs are prolonged in air-sacs, suggesting those of Birds (Fig. 343).

Excretory system.—The paired kidneys lie in the extreme posterior region of the abdominal cavity, and

extend a little farther back than the level of the cloaca. Each is furnished with a very short ureter. In the male the ureters unite with the vasa deferentia; in the female they open separately into the cloaca. Into the cloaca opens also a large thin-walled "urinary bladder"; this is a remnant of the foetal allantois, and has no functional connection with excretion. The urine is semi-solid, and consists largely of uric acid.

Reproductive system.—In the male the testes are two white oval bodies suspended in a dorsal fold of mesentery. Along the inner surface of each runs the epididymis, which receives the vasa efferentia, and is continuous posteriorly with the vas deferens. The two vasa deferentia, after receiving the ureters, open by small papillæ into the cloaca. In connection with the cloaca there is a pair of eversible copulatory organs, postero-lateral in position.

In the female the ovaries occupy a similar position to that of the testes in the male. The oviducts open far forward by wide ciliated funnels; as they pass backward they show a gradual increase in cross-section, but there is no line of demarcation between oviducal and uterine portions. Posteriorly, the oviducts open into the cloaca.

The right reproductive organ tends to be larger and in front of the left. In many of the males the Wolffian body is well developed. Viviparous, or what is clumsily called ovo-viviparous, parturition is well illustrated by *Lacerta vivipara*, *Anguis fragilis*, *Seps*, etc., but most lay eggs with more or less calcareous shells. In *Trachydosaurus* and *Cyclodus* the embryo seems to absorb food from the wall of the uterus. It is likely that Lacertilians existed in Permian ages, but their remains are not numerous before the Tertiary strata.

Many instructive illustrations of evolutionary change are afforded by lizards. Thus there are numerous gradations in the reduction of the limbs, from a decrease in the toes to entire absence of limbs. The diverse forms of tongue and the varied positions of the teeth are also connected by gradations. From the variations of the wall-lizard (*Lacerta muralis*), Eimer elaborated most of his theory of evolution.

Some Families of Lacertilia

In the Geckos (Geckonidæ) the vertebræ are biconcave or amphicoelous, the tongue is short and fleshy, the eyelids are rudimentary, the teeth are pleurodont, the toes bear numerous platis, by means of which they adhere to smooth surfaces, e.g. *Platydactylus*.

The Agamas (Agamidæ) are acrodont lizards common in the Eastern hemisphere. Examples.—*Agama*; *Draco*, with the skin extended on long prolongations of five or six posterior ribs; *Chlamydosaurus*, an Australian lizard, with a large scaled frill around the neck; *Moloch*, another Australian form bristling with sharp spikes.

Iguanas (Iguanidæ) are pleurodont lizards, represented in the warmer parts of the New World. Examples.—*Iguana*, an arboreal lizard, with a large distensible dewlap; *Amblyrhynchus* or *Oreocephalus cristatus*, a marine lizard confined to the Galapagos Islands; *Anolis*, the American chamæleon, with powers of rapid colour-change; *Phrynosoma*, the American “horned toad,” with numerous horny scales, and a collar of sharp spines suggesting in miniature that of some of the extinct Reptiles.

The slow-worms (Anguidæ) are limbless lizards, with serpentine body, long tail, rudimentary girdles and sternum. The British *Anguis fragilis* is not blind or poisonous, as popularly asserted; the tail breaks readily; the young are hatched within the mother.

The poisonous Mexican and Arizona lizards (*Heloderma horridum* and *H. suspectum*) are over a foot in length, and are covered with bead-like scales.

The Varanidæ are large carnivorous forms, most at home in Africa, but represented also in Asia and Australia. The Monitor of the Nile, *Varanus niloticus*, 5 or 6 ft. long, destroys eggs and young of Crocodiles.

The Amphisbænidæ are degenerate subterranean lizards, without limbs, with rudimentary girdles, with no sternum, with small covered eyes, with hardly any scales.

The Lacertidæ are Old World pleurodont lizards, such as *Pseudopus* (Europe and S. Asia) and *Lacerta viridis*, the green lizard of Jersey and S. Europe.

The Chamæleons (Chamæleontidæ) are very divergent lizards, mostly African. There is one genus, *Chamæleo*. The head and the body are compressed; the scales are minute; the eyes are very large and separately movable, with circular eyelids pierced by a hole; the tympanum is hidden; the tongue is club-shaped and viscid; the digits are divided into two sets, and well adapted for prehension; the tail is prehensile; the power of colour-change is remarkably developed.

The Chamæleons exhibit numerous anatomical peculiarities. As in the Amphisbænas, there is no epipterygoid. The pterygoid does not directly articulate with the quadrate, which is ankylosed to the adjacent bones of the skull.

Order OPHIDIA. Serpents or Snakes

The elongated limbless form of snakes seems at first sight almost enough to define this order from other Reptiles, but it must be carefully noticed that there are limbless Lizards, limbless Amphibians, and limbless Fishes, which resemble snakes in shape though they are very different in internal

structure. For the external shape is in great part an adaptation to the mode of life, to the habit of creeping through crevices or among obstacles. But the limblessness of serpents is not a merely superficial abortion; there is no pectoral girdle nor sternum, and never more than a hint of a pelvis.

GENERAL CHARACTERS.—*The skin is covered with scales, and the outermost epidermal layer is periodically shed in a continuous slough.*

There are never any hints of anterior appendages, girdles,

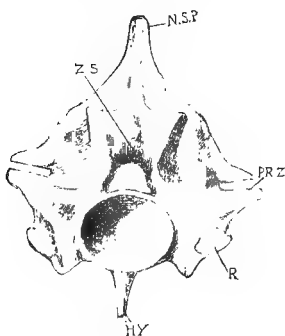

FIG. 344.—Anterior view of Python's vertebra.

N.S.P., neural spine; *Z.S.*, zygosphenes (a projecting wedge); *P.R.Z.*, pre-zygapophysis (smooth articular surface seen from above); *R.*, articulation-surface for a rib; *H.Y.*, hypapophysis.

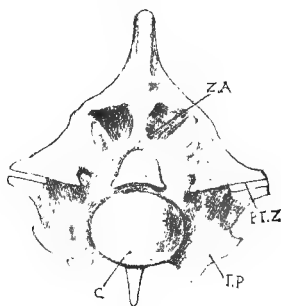

FIG. 345.—Posterior view of Python's vertebra.

Z.A., zygantrum, a double cavity for the zygosphenes; *P.T.Z.*, post-zygapophysis (smooth articular surface seen from below); *T.P.*, transverse process; *C.*, centrum.

sternum, or episternum; but in pythons, boas, and a few others, there are rudiments of a pelvis, and even small clawed structures which represent hind-legs.

The mouth is expansible; maxillæ, palatines, pterygoids, and quadrates are movable; and the rami of the mandible are connected only by elastic ligament. The teeth are fused to the jaws; there are no movable eyelids. Snakes have no external ear openings nor drum, nor tympanic cavity, nor Eustachian tube. The nostrils lie near the tip of the head.

The bifid, mobile, retractile tongue is a specialised organ of touch. In the mouth there is often a poison gland, which is a specialised salivary gland.

There are many peculiarities in the skeleton. The numerous vertebræ are all proœolous.

The brain has only ten nerves.

The heart is three-chambered, the ventricular septum being incomplete, as in all Reptiles except Crocodilians.

There is a transverse cloacal aperture. In the males a double saccular and spiny copulatory organ is eversible from the cloaca.

Snakes are widely distributed, but are most abundant in the tropics.

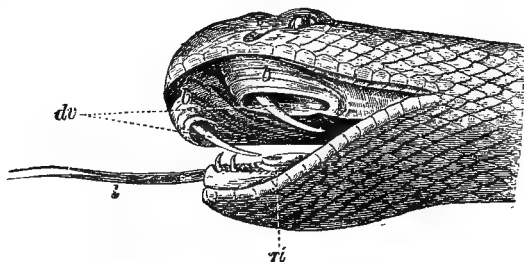

FIG. 346.—Snake's head.—After Nuhn.

dv., Poison fangs; *b.*, sheath of fang; *l.*, tongue; *rl.*, muscles of tongue.

General notes on snakes.—Snakes, especially when poisonous, are often brightly coloured. The scales on the head form large plates, and those on the ventral surface are transverse shields. In many cases there are odoriferous glands near the cloacal aperture.

The muscular system is very highly developed, and the limbless serpent, Owen says, “can outclimb the monkey, outswim the fish, outleap the zebra, outwrestle the athlete, and crush the tiger.”

The vertebræ are very numerous, some pythons having four hundred; they are proœolous, and are distinguishable only into a pre-caudal and caudal series.

All the pre caudal vertebræ except the first—the atlas—have associated ribs, which are movably articulated, and

used as limbs in locomotion, being attached to the large ventral scales which grip the ground. In the caudal region the transverse processes, which are elsewhere very small, take the place of ribs.

One of the most distinctive characteristics of the skull is the mobility of some of the bones. Many of the Ophidians swallow animals which are larger than the normal size of the mouth and throat. The mobility of the skull bones is an adaptation to this habit. Thus the rami of the mandible are united by an elastic ligament; the quadrates and the squamosals are also movable, forming "a kind of jointed lever, the straightening of which permits of the separation of the mandibles from the base of the skull." The nasal region may also be movable. On the other hand, the bones of the brain-case proper are firmly united. The premaxillæ are very small and rarely bear teeth; the palatines are usually connected with the maxillæ by transverse bones, and through the pterygoids with the movable quadrates.

Teeth, fused to the bones which bear them, occur on the dentaries beneath, and above on the maxillæ, palatines, and pterygoids, and very rarely on the premaxillæ. The fang-like teeth of venomous serpents are borne by the maxillæ, and are few in number. Each fang has a groove or canal down which the poison flows. When the functional fangs are broken, they are replaced by reserve fangs which lie behind them. In the egg-eating African *Dasypeltis* the teeth are rudimentary, but the inferior spines of some of the anterior vertebræ project on the dorsal wall of the gullet, and serve to break the egg-shells.

When a venomous snake strikes, the mandible is lowered, the distal end of the quadrate is thrust forward (this pushes forward the pterygoid), the pterygo-palatine joint is bent, the maxilla is rotated on its lachrymal joint, the fangs borne by the maxilla are erected into a vertical position, the poison gland is compressed by a muscle, and the venom is forced through the fang.

Some of the peculiarities in the internal organs of Ophidia may be connected with the elongated and narrow shape of the body. Thus one lung, usually the left, is always smaller than its neighbour, or only one is developed; the liver

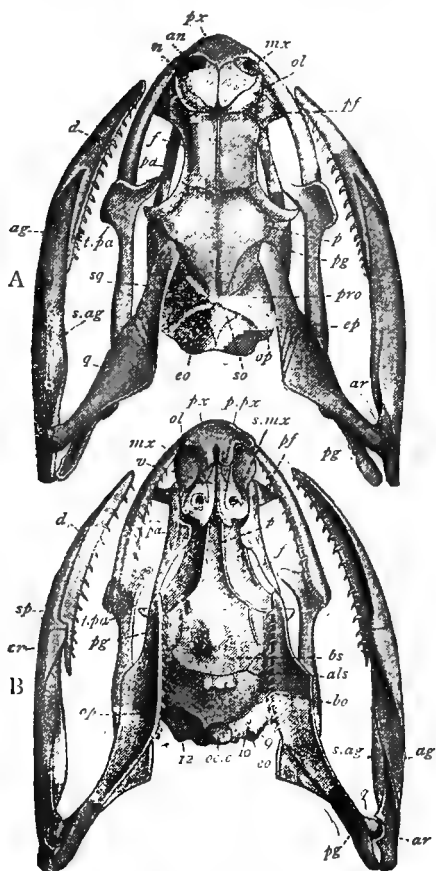

FIG. 347.—Skull of grass-snake.—From W. K. Parker.

A, Dorsal surface—*px.*, premaxilla; *mx.*, maxilla; *an.*, external nostril; *n.*, nasal; *ol.*, nasal cartilages; *pf.*, prefronto-lachrymal; *p.*, parietal; *f.*, frontal; *pa.*, palatine; *t.pa.*, transpalatine; *pg.*, pterygoid; *pro.*, pro-otic; *ep.*, epiotic; *op.*, opisthotic; *so.*, supraoccipital; *eo.*, exoccipital; *ar.*, articular; *s.ag.*, surangular; *ag.*, angular; *d.*, dentary; *q.*, quadrate; *sq.*, squamosal. B, Ventral surface—*px.*, premaxilla; *ol.*, nasal cartilage; *mx.*, maxilla; *v.*, vomer; *pa.*, palatine; *p.*, parasphenoid; *f.*, frontal; *pf.*, prefrontal; *pg.*, pterygoid; *bs.*, basisphenoid; *als.*, alisphenoid; *bo.*, basioccipital; *cc.c.*, occipital condyle; *eo.*, exoccipital; *q.*, quadrate; *ar.*, articular; *ag.*, angular; *s.ag.*, surangular; *cr.*, coronary; *sp.*, splenial; *d.*, dentary; *op.*, opisthotic region.

is much elongated; the kidneys are not opposite one another.

The poison is useful in defence, and in killing the prey, which is always swallowed whole. It is interesting to notice a recent discovery, requiring amplification, that the bile of a poisonous snake is an antidote to its venom.

The British adder (*Pelias berus*) is viviparous, and so are a few others. The great majority are oviparous, but confinement and abnormal conditions may make oviparous forms, like the *Boa constrictor* and the British grass-snake (*Tropidonotus natrix*), viviparous. The female python incubates its eggs.

Many Ophidians become lethargic during extremes of temperature, or after a heavy meal.

Snakes are especially abundant in the tropics, but occur in most parts of the world. They are absent from many islands; thus there are none in New Zealand, and we all know that there are no snakes in Iceland. Most are terrestrial, but not a few readily take to the water, and there are many habitual sea-serpents.

The serpent still bites the heel of progressive man, the number of deaths from snake-bite in India alone amounting to many thousands yearly.

True Ophidians first occur in Tertiary strata.

Some Examples of Ophidia

Typhlopidae. The lowest and most divergent Ophidians, occurring in most of the warmer parts of the earth, generally smaller than earthworms, usually subterranean burrowers, with eyes hidden under scales, with a non-distensible mouth, with teeth restricted either to the upper or to the lower jaw. "The palatine bones meet, or nearly meet, in the base of the skull, and their long axes are transverse; there is no transverse bone; the pterygoids are not connected with the quadrates." The quadrate articulates with the pro-otic, for there is no squamosal.

Example.—*Typhlops*, very widely distributed.

In other Ophidians the palatines are widely separated, and their long axes are longitudinal; there are transverse bones connecting palatines and maxillæ; the pterygoids are connected with the quadrates.

In innocuous snakes the poison gland is not developed as such; the maxillary teeth are not grooved.

Examples.—The British smooth snake (*Coronella lavis*); the British grass-snake (*Tropidonotus natrix*); the Pythons; the Boas, of which the Anaconda (*Boa murina*) (30 feet) is the largest living Ophidian.

In venomous snakes some of the maxillary teeth are grooved, and in the most venomous the groove becomes a canal open at both ends.

Examples.—Cobras, *Naja tripudians* (Indian), *Naja haje* (African); the Hamadryad (*Ophiophagus elaps*), eating other snakes; Coral-snakes (*Elaps*, etc.); Sea-snakes (*Hydrophis*, etc.), with paddle-shaped tails. The British adder (*Pelias berus*); the rattlesnake (*Crotalus*), with a rattle formed chiefly from epidermic remnants of successive sloughings; the African Puff-adder (*Clotho arietans*).

Order CROCODILIA. Crocodiles, Alligators; Gavials

GENERAL CHARACTERS.—*The Crocodylians are carnivorous fresh-water reptiles of large size, now represented by a few genera, e.g. Crocodylus, Alligator, and Gavialis.*

The skin bears epidermic scales, underneath some of which there are dermic bones or scutes.

The tail is laterally compressed, and assists in swimming.

Teeth occur in distinct sockets in the premaxillæ, maxillæ, and dentaries.

In modern Crocodylians, almost all the vertebræ are procœlous.

The skull has many characteristic features, such as the union of maxillæ, palatines, and pterygoids in the middle line on the roof of the mouth, and the consequent shunting of the posterior nares to the very back of the mouth.

Some of the ribs have double articulating heads, and bear small uncinæ processes; transverse ossifications form so-called abdominal ribs.

The heart is four-chambered; a muscular diaphragm partially separates the thoracic from the abdominal cavity.

The cloaca has a longitudinal opening. The males have a grooved penis.

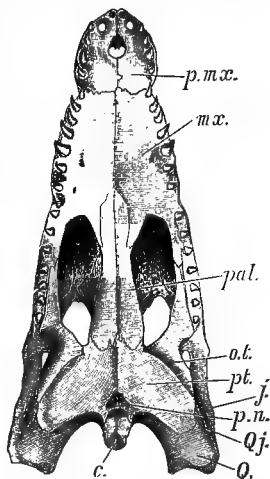

FIG. 348.—Lower surface of skull of a young crocodile.

p.mx., Premaxilla; *mx.*, maxilla; *pal.*, palatine; *o.t.*, os transversum; *pt.*, pterygoid; *j.*, jugal; *Qj.*, quadrato-jugal; *Q.*, quadrate; *p.n.*, posterior nares; *c.*, condyle.

The Crocodilians are oviparous. The eggs have firm calcareous shells, and are laid in holes in the ground.

Skeletal system.—Numerous transverse rows of sculptured bony plates or scutes, ossified in the dermis, form a dorsal shield. On the ventral surface the scutes are absent, except in some alligators, in which they are partially ossified. But besides and above the scutes, there are horny epidermic scales like those in other Reptiles. The hide is often used as leather.

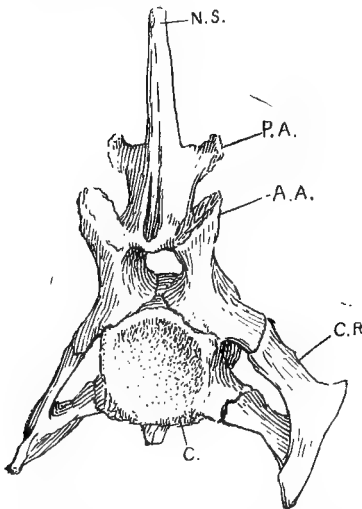

FIG. 349.—Cervical vertebra of crocodile.

N.S., Neural spine; P.A., posterior articular process; A.A., anterior articular process; C.R., cervical rib; C., procœlous centrum.

The vertebral column consists of distinct cervical, dorsal, lumbar, sacral, and caudal vertebræ, all procœlous except the first two cervicals, the two sacrals, and the first caudal. In most of the pre-cretaceous Crocodilians, however, the vertebræ were amphicœlous. The centra of the vertebræ are united by fibro-cartilages, and the sutures between the neural arch and the centrum persist at least for a long time. Chevron bones are formed beneath the centra of many of the caudal vertebræ.

Many of the ribs have two heads—capitulum and tubercle—by which they articulate with the vertebræ. From seven to nine of the anterior dorsal ribs are connected with the sternum by sternal ribs, and from several of these anterior ribs cartilaginous or partially ossified uncinæ project backwards.

The so-called abdominal ribs have nothing to do with ribs, but are ossifications in the fibrous tissue which lies under the skin and above the muscles. They form seven transverse series, each composed of several ossicles.

As to the skull, there is an interorbital septum with large alisphenoids; the presphenoid and orbitosphenoids are at best incompletely ossified; all the bones are firmly united by persistent sutures; both upper and lower temporal arcades are completely ossified; the maxillæ, the palatines, and the pterygoids meet in the middle line of the roof of

the mouth, covering the vomers, and determining the position of the posterior nares—at the very back of the mouth; an os transversum or transpalatine extends between the maxilla and the junction of palatine and pterygoid; a postorbital rod (epipterygoid or columella) is formed by a downward process of the postfrontal meeting an upward process from the jugal; the quadrate is large and immovable; there are large

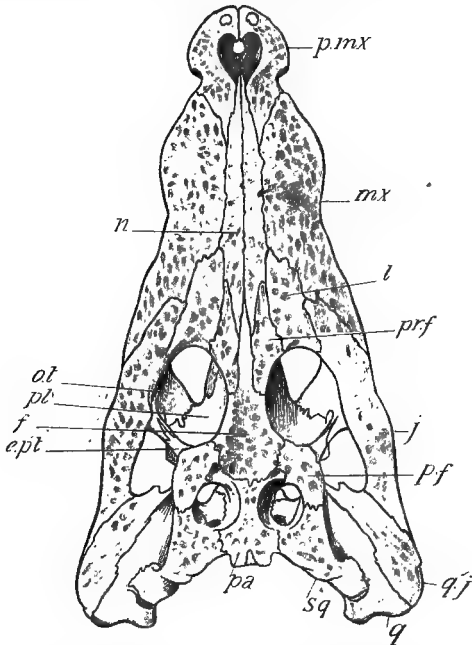

FIG. 350.—Crocodile's skull from dorsal surface.

p.mx., Premaxilla; *mx.*, maxilla; *l.*, lachrymal; *pr.f.*, prefrontal; *j.*, jugal; *pf.*, postfrontal; *q.j.*, quadrato-jugal; *q.*, quadrate; *sq.*, squamosal; *pa.*, parietal; *e.pt.*, epipterygoid; *f.*, frontal; *pl.*, pterygoid (on lower surface); *o.t.*, os transversum (on lower surface); *n.*, nasal.

parotic processes; the tympanic cavity is completely bounded by bone; the teeth, which are borne by premaxillæ, maxillæ, and dentaries, are lodged in distinct cavities; beside and eventually beneath the teeth lie reserve "germs" of others.

Each ramus of the mandible consists, as in most Reptiles, of a cartilage bone—the articular—working on the quadrate, and five

membrane bones — dentary, splenial, coronoid, angular, and surangular.

The hyoid region is very simple.

The pectoral arch includes a dorsal scapula and a ventral coracoid (with a characteristic foramen); there are no clavicles; the epicoracoids are thin strips between the ventral ends of the coracoids and the front of the sternum; there is an episternum; the fore-limb is well though not strongly developed; there are five digits, webbed and clawed.

In the pelvic arch, large ilia are united to the strong ribs of the two sacral vertebræ: the pubes, or more strictly the epipubes, slope forward and inward, and have a cartilaginous symphysis; the ischia slope

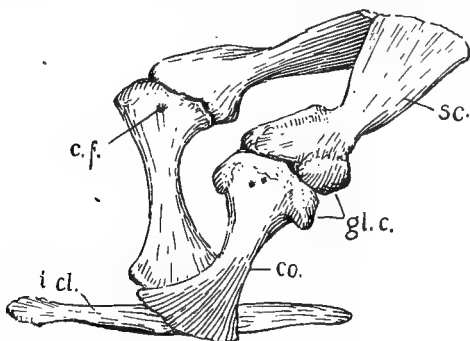

FIG. 351.—Pectoral girdle of crocodile.

sc., Scapula; *gl.c.*, glenoid cavity; *co.*, coracoid; *c.f.*, coracoid foramen; *i.cl.*, episternum.

backward and have a symphysis; ilia and ischia form almost the whole of the acetabulum, a small part being occupied by the true pubes. The hind-limbs bear four digits, webbed and clawed.

Organs of Crocodylians.—The Crocodylians are seen to best advantage in the water, swimming by powerful tail-strokes. The limbs are too weak for very effective locomotion on land, the body drags on the ground, and the animals are stiff-necked. Although many, especially in their youth, feed on fishes and small animals, the larger forms lurk by the edge of the water, lying in wait for mammals of considerable size. These they grasp in their extremely powerful jaws, and drown by holding them under water. If the dead booty cannot be readily torn, it is often buried and left until it begins to rot. In connection with their way of feeding, we should notice several peculiarities of structure; the nostrils are at the upper end of the snout, and the eyes and ears are also near the upper surface, so that the Crocodylians can breathe, see, and hear while the body is altogether immersed except the upper surface of the head; the nostrils can

be closed by valves, and the eyes by transparent third eyelids, and the ears by movable flaps, so that the head can be comfortably immersed; a flat tongue is fixed to the floor of the mouth, and the cavity of the mouth is bounded behind by two soft transverse membranes, which, meeting when the reptile is drowning its prey, prevent water rushing down the gullet; the posterior opening of the nostrils is situated at the very back of the mouth, and when the booty is being drowned, the Crocodilian keeps the tip of its snout above water, the glottis is pushed forward to meet the posterior nares, a complete channel for the passage of air is thus established, and respiration can go on unimpeded. For their shore work the Crocodilians prefer the darkness, but they often float basking in the sun, with only the tip of the snout and the ridge of the back exposed.

Glands with a secretion which smells like musk are usually developed on the margin of the lower jaw, at the side of the cloacal aperture, and on the posterior margins of the dorsal scutes. The musky odour is very strong during the pairing season, and when the animals are attacked.

In connection with the muscular system, the presence of what is often called an incipient diaphragm between the thoracic and the abdominal cavity is of interest.

The brain seems very small in relation to the size of the skull.

The eyes are provided with a third eyelid, as in most Reptiles, Birds, and Mammals; there are large lachrymal glands, but there is no special deceitfulness about "crocodile's tears."

The ears open by horizontal slits, over which lies a flap of skin; three Eustachian passages—one median and one on each side—open into the mouth behind the posterior nares.

The nostrils also can be closed, and, as we have already noticed, their internal opening lies at the back of the mouth.

The stomach suggests a bird's gizzard, for it has strong muscular walls, and its pyloric end is twisted upward so as to lie near the cardiac part.

The heart is four-chambered, the septum between the ventricles being complete, as in Birds and Mammals. But as the dorsal aorta is formed from the union of a left aortic arch containing venous blood, and a right aortic arch containing arterial blood, the blood which is driven to many parts of the body is "mixed blood," *i.e.* blood partly venous, partly arterial, with some of its red blood corpuscles carrying hæmoglobin and others oxyhæmoglobin. At the roots of the two aortic arches there is a minute communication between them—the foramen Panizzæ.

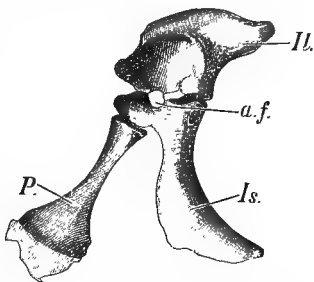

FIG. 352.—Half of the pelvic girdle of a young crocodile.

Il., Ilium; *a.f.*, acetabulum; *Is.*, ischium; *P.*, pubis or epipubis.

Into the right auricle venous blood is brought by the two superior venæ cavæ and by the inferior vena cava. The blood passes through a valved aperture into the right ventricle, and is driven thence—(a) by the pulmonary artery to either lung, or (b) by the left aortic arch to the body. From this left aortic arch, before it unites with its fellow on the right to form the dorsal aorta, is given off the great cœliac artery. The anterior viscera thus receive wholly venous blood from the heart.

The blood driven to the lungs is purified there, and returns by pulmonary veins to the left auricle. Thence it passes through a valved aperture into the left ventricle. Thence it is driven into the right aortic arch. From this the carotids to the head and the subclavians to the fore-limbs are given off. These parts of the body thus receive wholly arterial blood from the heart.

The venous blood returning from the posterior regions may pass through the kidneys in a renal-portal system, and thence into the inferior vena cava; or it may pass through the liver in a hepatic-portal system, and thence by hepatic veins into the inferior vena cava; or some of it may pass directly into the inferior vena cava. The renal-portal veins arise from a transverse vessel uniting the two branches of the caudal, but the latter are also continued forward as lateral epigastrics which enter the liver.

The temperature of the blood is not above that of the surrounding medium.

In regard to the respiratory system, we should notice that the lungs are invested by pleural sacs, as is the case in Mammals.

The ureters of the kidneys, the vasa deferentia from the testes in the male, the oviducts from the ovaries in the female, open into the cloaca, which has a longitudinal opening. The penis is on the anterior surface of the cloaca.

The eggs, which in size are like those of geese, have a thin calcareous shell, are buried in excavated hollows, and, warmed by the sun, hatch without incubation.

Of one species of crocodile it is known that the mother opens up the nest when the young, ready to be hatched, are heard to cry from within the eggs. The mothers take some care of the young, which require to be defended even from the appetite of the males.

Crocodiles are relatively sluggish, and fond of basking passively, sometimes hiding in the mud during the hot season. They are remarkable for the long continuance of growth, which does not seem to have so definite a limit as in most other animals.

Classification of Crocodilia

(a) The true Crocodiles, of the genus *Crocodylus*, occur in Africa, Southern Asia, tropical Australia, Central America, and the West Indies.

The Indian crocodile (*C. porosus*) may measure about 18 ft. in length, and even larger forms have been recorded. The sacred African

crocodile (*C. vulgaris*) is still formidably common in some of the fresh waters of tropical Africa.

The eggs and the young are often eaten by a mammal called the Ichneumon, and by a species of lizard. The adults have few enemies except man. They seem to live in friendly partnership with little birds (*Pluvianus aegypticus*), which remove parasites from the body, and in their familiarity almost justify the account which Herodotus gives of their cleaning the reptile's teeth.

(b) The Alligators, of the genus *Alligator*, are, with the exception of one Chinese species, confined to N. and S. America. In N. America, *A. mississippiensis*, in S. America *A. sclerops*, is common.

(c) The Gavials or Gharials, of the genus *Gavialis*, are distinguished by their long narrow snout. In the Ganges and its tributaries, *G. gangeticus*, said to attain a length of 20 ft., is common. They feed chiefly on fishes. "Old males have a large cartilaginous hump on the extremity of the snout, containing a small cavity for the retention of the air, by which means these individuals are enabled to remain under water for a longer time than females or young."

DIFFERENCES BETWEEN CROCODILES, ALLIGATORS, AND GAVIALS

ALLIGATORS.	CROCODILES.	GAVIALS.
The head is short and broad.	Longer.	The snout is very long.
First and fourth lower teeth bite into pits in the upper jaw.	The first bites into a pit; the fourth into a groove.	First and fourth lower teeth bite into grooves in the upper jaw.
The union of the two rami of the lower jaw does not extend beyond the fifth tooth.	Not beyond the eighth.	The union extends at least to the fourteenth.
The nasal bones form part of the nasal aperture.	As in the alligator.	The nasal bones do not form part of the nasal aperture.
The teeth are very unequal.	Unequal.	Almost equal.
The scutes on the neck are distinct from those on the back.	Sometimes distinct, sometimes continuous.	Continuous.

History of Crocodilians.—These giant reptiles form a decadent stock. Fossil forms are found in Triassic strata (*e.g. Belodon, Parasuchus*, and *Stagonolepis*); their remains are abundant in Jurassic rocks. In Cretaceous strata, crocodilians with procelous vertebrae first occur, the pre-Cretaceous forms having centra of the amphicelous type. The oldest crocodilians have the posterior nares situated farther forward, behind the palatines. Huxley has worked out an "almost unbroken" series from the ancient Triassic crocodilians down to those of to-day.

Development of Reptiles

The ovum contains much yolk, at one pole of which there is a small quantity of formative protoplasm surrounding the germinal vesicle. The segmentation is necessarily meroblastic and discoidal, as in Birds.

The segmented area or blastoderm, originally at one pole, gradually grows round the yolk. The central region of the dorsal blastoderm,

is separated from the yolk by a shallow space filled with fluid, and is clearer than the rest of the blastoderm. In this central region or area pellucida, the germinal layers and subsequently the parts of the embryo are established, while the rest of the blastoderm — the area opaca — simply forms a sac round the yolk. One of the first signs of development is the appearance of a thickened band of cells extending forward in the middle line from the posterior margin of the area pellucida. This band is called the primitive streak, and seems to represent a fusion of the two edges of the blastoderm behind the future embryonic region. The embryo develops in front of the primitive streak, and one of the first signs of its development is the formation of a primitive or medullary groove in a line with the primitive streak. As development proceeds, folds appear around the embryo, constricting it off from the subjacent yolk or yolk-sac.

It is with Reptiles that the series of higher Vertebrates or Amniota begins.

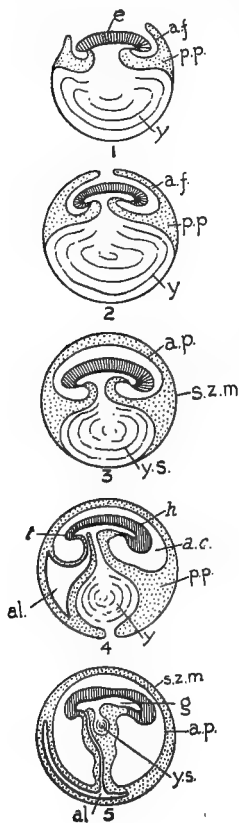

FIG. 353.—Origin of amnion and allantois.—After Balfour.

1. Rise of amniotic folds (*a.f.*) around embryo (*e*); *p.p.*, pleuro-peritoneal cavity; *y.*, yolk.
2. Further growth of amniotic folds (*a.f.*) over embryo and around yolk.
3. Fusion of amniotic folds above embryo; *a.p.*, amnion proper; *s.z.m.*, subzonal membrane; *y.s.*, yolk-sac.
4. Outgrowth of allantois (*al.*); amniotic cavity (*a.c.*); *h.*, head end; *t.*, tail end.
5. Complete enclosure and reduction of yolk-sac (*y.s.*); *s.z.m.*, subzonal membrane; *a.p.*, amnion proper; *al.*, allantois; *g.*, gut of embryo.

It is here that the foetal membranes known as amnion and allantois are first formed.

(a) *The Amnion*.—At an early stage in development the head end of the embryo seems to sink into the subjacent yolk. A semilunar fold of the blastoderm, including epiblast and mesoblast, rises up in front. Similar folds appear laterally. All the folds increase in size, arch upwards, and unite above, forming a dome over the embryo. Each of these folds is double; the inner limbs unite to form “the true amnion”; the outer limbs unite to form “the false amnion,” “serous membrane,” or subzonal membrane. The cavity bounded by the true amnion contains an amniotic fluid bathing the outer surface of the embryo; the cavity between the true and the false amnion is lined by mesoblast, and is continuous with the pleuro-peritoneal or body cavity of the embryo. The amniotic folds extend not only over the embryo, but ventrally around the yolk-sac, which they completely invest.

(b) *The Allantois*.—While the amnion is being formed, a sac grows out from the hind end of the embryonic gut. This is the allantois lined internally by hypoblast, externally by mesoblast. It rapidly insinuates itself between the two limbs of the amnion, eventually surrounding both embryo and yolk-sac.

The amnion is a protective membrane, forming a kind of water-bag around the embryo.

The allantoic sac is vascular, and has respiratory and perhaps also some yolk-absorbing functions. It seems to be homologous with the outgrowth which forms the cloacal bladder of Amphibians; it has been called “a precociously developed urinary bladder.”

Before the amnion is developed, the heavy head end of the embryo has already sunk into a depression (in Lizards, Chelonians, Birds (?), and Mammals), and is surrounded by a modification of the head fold termed the pro-amnion. This does not include any mesoblast, and is afterwards replaced by the amnion.

Hints of a placenta before Mammals.—As will be explained afterwards, the placenta, which characterises most Mammals, is an organic connection between mother and unborn young. Its embryonic part is chiefly formed from a union of the serous or subzonal membrane and the allantois, but in some cases the yolk-sac and the subzonal membrane form a provisional placenta. The placenta establishes a vital union between the embryo and the mother.

Now it is interesting to notice that there are some hints of placental connection in animals which are much lower than Mammals. In some species of *Mustelus* and *Carcharias* there is a connection between the yolk-sac and the wall of the uterus; in the Teleostean *Anableps* the yolk-sac has small absorbing outgrowths or villi; in *Trachydosaurus* and *Cyclodus* among Lizards, the vascular yolk-sac is separated from the wall of the uterus “only by the porous and friable rudiment of the egg-shell; in *Clemmys* among Chelonians, there is an absorbing protrusion of the foetal membranes. In Birds also, small villi of the yolk-sac absorb yolk, and others on the allantois absorb albumen.” (See A. C. Haddon's *Embryology*.)

Extinct Reptiles

The first known occurrence of fossil Reptiles is in Permian strata ; in the Trias most of the orders or classes are represented ; while the "golden age" of the group was undoubtedly during Jurassic and Cretaceous times.

Some of the modern Reptiles are linked by a series of fine gradations to very ancient progenitors,—the Crocodiles of to-day lead back to those of the Trias, the New Zealand *Hatteria* to the Triassic Rhynchocephalia ; but we have no example of a Reptilian genus which has persisted from age to age as *Ceratodus* has done among Fishes. Among the fossil forms we find "generalised" types, which exhibit affinities with groups which in our classification of recent forms may be very widely separated.

The following types of extinct reptiles seem to have entirely disappeared :—

Theromorpha.—Lizard-like terrestrial animals with limbs adapted for walking, found in the Permian and Trias. The group shows a remarkable combination of reptilian and mammalian characters. In illustration of *reptilian* characters we may note the pineal foramen, the complex lower jaw, usually articulating with a firmly fixed quadrate, the usual presence of pre- and post-frontals. *Mammalian* features are illustrated in some types by the differentiation of the teeth into incisors, canines, and molars ; by a single temporal arcade like a zygomatic arch ; by the way the limbs raise the body off the ground ; by the union of the pelvic bones into an os innominatum (pubes and ischia forming a stout ventral symphysis) ; by the reduction of the quadrate ; by the share the squamosal may take in forming the articulation for the lower jaw.

Examples.—*Pareiosaurus*, *Dicynodon*, *Elginia*.

Plesiosauria.—Amphibious and marine reptiles represented from the Trias to the Chalk, without exoskeleton, usually with a long neck and short tail. The skull has a single broad temporal arcade, pterygoids meeting in the middle line, fixed quadrates, and a pineal foramen. There are strongly developed pectoral and pelvic girdles. The limbs vary ; in the earlier, more generalised, forms they are adapted for walking on land ; but in the more specialised types they are modified into powerful paddles, like those of Chelonia. The nearest affinities are with the Chelonia. *Nothosaurus* had limbs adapted for progression on land ; *Plesiosaurus* (40 ft. in length) and *Pliosaurus* were carnivorous forms adapted to an aquatic life.

Ichthyosauria.—Large marine carnivorous Reptiles, represented from the Trias to the Chalk, with tapering body like that of a shark, large dorsal and caudal fins, and two pairs of paddle-like limbs. In

the paddle the number of digits may be more than five, and the phalanges of each digit are often very numerous. The pectoral arch consists of coracoids, scapulæ, clavicles, and a T-shaped episternum, but there is no sternum. The skull has a long tapering rostrum, large orbits, a large parietal foramen, and usually sharp conical teeth in a continuous groove. The vertebræ are deeply amphicœlous. There was no dermal armour. The length of the body is sometimes 30 to 40 ft. Some species were viviparous.

Examples.—*Ichthyosaurus*, *Ophthalmosaurus*.

Pythonomorpha.—These strange Cretaceous Reptiles should probably be placed near the Lacertilia and the Rhynchocephalia. They are specially characterised by the enormous elongation of the body, which sometimes reached a length of 75 to 80 ft. The skull is like that of the Monitor among the lizards, but, according to Cope, it also presents affinities with snakes. The body is snake-like, but there are two well-developed pairs of limbs, forming swimming-paddles. All were carnivorous and marine; the distribution was cosmopolitan.

Examples.—*Mosasaurus*, *Clidastes*, *Liodon*, *Dolichosaurus*.

Dinosauria.—Terrestrial Reptiles, ranging from the Trias to the Chalk, often very large, and, like Marsupials, specialised in various directions. They were long-necked and long-tailed forms, some bipedal, some quadrupedal. The skull has a superior and an inferior temporal arcade, a fixed quadrate, teeth in sockets, and confined to the margins of the jaws. They exhibit many points of resemblance to Crocodiles and Rhynchocephalia on the one side and to Birds on the other. The pelvis and hind-limbs are particularly avian, e.g. in the tendency to form a tibio-tarsus. *Brontosaurus*, a gigantic, herbivorous form, nearly 60 ft. in length, was probably amphibious. *Atlantosaurus* was even larger, the femur measuring over 6 ft. in length. *Compsognathus*, *Iguanodon*, and *Camptosaurus* are examples of the "bird-footed" herbivorous Dinosaurs. *Compsognathus* only reached a length of 2 ft., and hopped on its hind-legs like a bird. *Iguanodon* habitually walked on its hind-limbs, and, like several others, had hollow bones; it reached a height of 15 ft. Of the carnivorous Dinosaurs, *Megalosaurus* is a good type. The limbs were furnished with powerful claws, and the teeth show much specialisation.

Pterosauria or *Pterodactyls*.—Flying Reptiles, represented from the Lower Jurassic to the Upper Chalk, exhibiting many points of resemblance to Carinate Birds, but still distinctly Reptilian in type. They resemble birds especially in some features of the skull and pectoral girdle, but they differ markedly in their vertebral column, pelvis, and organ of flight. An expansion of the skin seems to have been stretched on the much-elongated outermost finger, and to have extended backwards to the hind-legs and the tail. The long bones are hollow. The sternum is keeled, and teeth are often present on the margin of both jaws. There is both a superior and an inferior temporal arcade. The quadrate is fixed. Some were no larger than sparrows, but others—the giants with which the race ended—had in some cases a spread of wing of nearly 20 ft. It is probable that the resemblances of these forms to Birds indicate similar habits, and not any close true affinity.

Examples.—*Pterodactylus*, *Rhamphorhynchus*, *Pteranodon*.

RELATIONSHIPS

Reptiles, in their widest sense, form a central assemblage among Vertebrates. Some of the extinct forms exhibit affinities with Amphibians, others with Birds, others again with Mammals. Though we cannot with certainty point to any of the extinct types as directly ancestral to Birds or Mammals, it seems likely that the ancestors of both were derived from the plastic Reptilian stock.

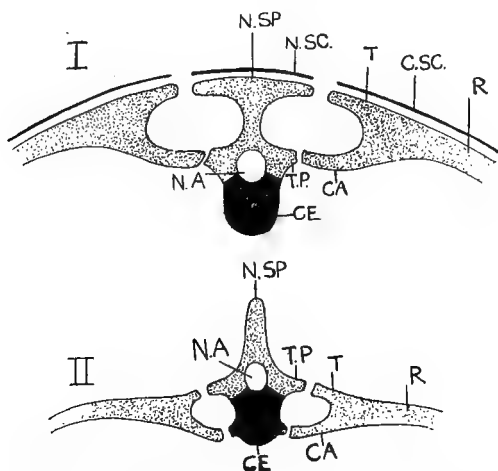

FIG. 353A.—Vertical section through backbone and ribs of Chelonian (I.) and Mammal (II.).—In part after Jaekel.

N.SP., neural spine; *N.SC.*, neural scute; *T.*, tubercle of rib; *C.SC.*, costal scute over rib (*R.*); *CA.*, capitulum of rib; *T.P.*, transverse process; *CE.*, centrum; *NA.*, cavity of neural canal. In the Chelonian the tubercle abuts against the flattened neural spine, and the capitulum against the transverse process. In the Mammal, the tubercle articulates with the transverse process and the capitulum with the centrum.

CHAPTER XXV

CLASS AVES—BIRDS

- I. Sub-class ARCHÆORNITHES (or Saururæ); extinct *Archæopteryx*.
- II. Sub-class NEORNITHES.
 1. Division Ratitæ. "Running Birds." Ostrich, etc.
 2. Division Odontolcæ. Extinct *Hesperornis*.
 3. Division Carinataæ. "Flying Birds" with keeled sternum.

BIRDS share with Mammals the rank of the highest Vertebrates. For although Mammals excel in brain development, and in the closer organic connection between mother and unborn young, it must be allowed that as regards muscles and skeleton, heart and lungs, indeed most of their structure, the two classes are almost equally differentiated. They are not, however, in any way nearly related, but represent quite divergent lines of evolution. They are related to one another indirectly, since they have in all probability a common ancestry among Reptiles.

Like Insects among Invertebrates, so Birds among Vertebrates are pre-eminently creatures of the air, and the analogies between these two widely separated classes are many, *e.g.* as regards power of flight, elaborate respiratory system, bright colouring, sexual dimorphism, preferential mating, and parental instincts. The high body temperature of Birds, exceeding that of all other animals, is a physiological index of their rapid metabolism or intense activity.

Compared with lower Vertebrates, Birds show a marked increase of emotional life, as seen in their affection for their mates, in their care of the young, and in the joyousness of their mood, often bursting forth in song.

GENERAL CHARACTERS OF BIRDS

Warm-blooded, oviparous, feathered bipeds.

The fore-limbs are modified as wings, generally capable of flight; the neck is long and the tail is short, except in the extinct Archæopteryx.

The epidermic exoskeleton is represented by the feathers, which are usually arranged in definite feather tracts (pterylia), with bare patches between, and also by scales on the legs similar to those of reptiles. Almost the only skin gland is an oil or preen gland, lying dorsally at the root of the tail.

The pectoral muscles used in flight are generally large; in many there is a muscular gizzard; there is no diaphragm comparable to that of Mammals.

In the brain, which fills the large cranial cavity, the predominance of the basal parts of cerebrum and cerebellum has resulted in displacing the optic lobes to the sides. The spinal cord is at an angle to the medulla oblongata, not in a line with it as in lower Vertebrates.

The nostrils are often surrounded by a sensitive cere; there is never more than a very rudimentary pinna outside the external auditory meatus; the connection between tympanum and inner ear is by means of a columella; the eyeball is strengthened by sclerotic ossicles; there is a well-developed third eyelid, and a large nutritive and secretory pecten.

There are no epiphyses on the bones. Many bones contain prolongations of the air-sacs connected with the lungs. When a long bone contains an air-sac, there is little or no marrow. The curvature of the vertebral centra, especially in the cervical region, viewed from in front, is typically concave from side to side, and convex from above downwards (heterocœlous), but other shapes occur, e.g. opisthocœlous in thoracic region of gulls and penguins. The cervical vertebræ have small ribs, fused in most cases with the transverse processes. The thoracic vertebræ tend to fuse; and numerous vertebræ (one to three dorsals, all the lumbar, and some caudals) fuse with the two or three true sacra. The terminal vertebræ usually fuse as a ploughshare bone.

In most birds the bones of the brain-case fuse very early, the sutures being obliterated. Only the lower jaw, the quadrate, the columella, and hyoid are always movable; but

the pterygoids usually articulate freely with the basisphenoid, the lachrymals may remain free, and there may be a joint in the beak at the end of the premaxillæ. There is but one condyle. A membrane bone called the basitemporal covers the basisphenoid. There is an interorbital septum formed from presphenoid and mesethmoid. The otic bones fuse with adjacent bones and with one another about the same time. In modern birds there are no teeth, but the jaws are covered

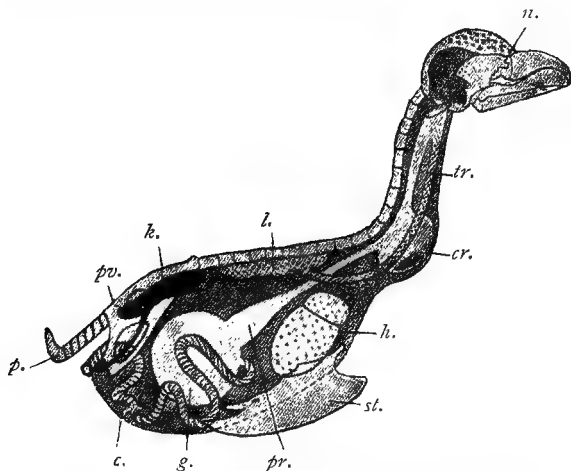

FIG. 354.—Position of organs in a bird.—After Selenka.

n., Nostrils; *tr.*, trachea; *cr.*, crop; *h.*, heart; *st.*, sternum; *pv.*, proventriculus; *g.*, gizzard; *c.*, cæca; *p.*, pygostyle; *pv.*, pelvis; *k.*, kidney; *L.*, lung.

by horny sheaths. The premaxillæ are large, and form most of the beak. There is a complete infra-temporal arcade formed by a delicate jugal and quadrato-jugal reaching back to the quadrate. The supra-temporal arcade is usually incomplete, but in some cases a process of the squamosal joins a postorbital process of the frontal. The lower jaw consists on each side of five membrane bones and a cartilage bone—the articular—which works on the quadrate. Many of the skull bones have a spongy texture, due to cavities filled with air from the nasal and Eustachian tubes.

There is a well-developed sternum, generally with a keel, with a separate centre of ossification, to which the pectoral muscles are in part attached. The strong coracoids reach and articulate with the sternum. In flying birds the clavicles

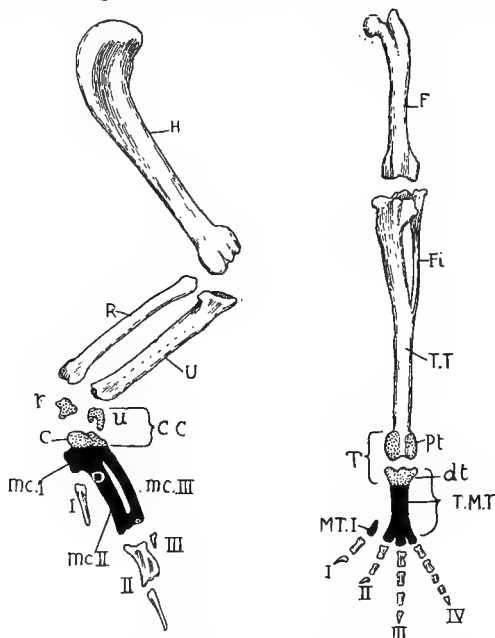

FIG. 355.—Fore-limb and hind-limb compared.

H., Humerus; *R.*, radius; *U.*, ulna; *r.*, radiale; *u.*, ulnare; *C.*, distal carpals united to carpo-metacarpus; *CC.*, the whole carpal region; *MC.I.*, metacarpal of the thumb; *I.*, phalanx of the thumb; *MC.II.*, second metacarpus; *II.*, second digit; *MC.III.*, third metacarpus; *III.*, third digit. *F.*, femur; *T.T.*, tibio-tarsus; *Fi.*, fibula; *Pt.*, proximal tarsals united to lower end of tibia; *dt.*, distal tarsals united to upper end of tarso-metatarsus (*T.M.T.*); *T.*, entire tarsal region; *MT.I.*, first metatarsal, free; *I.-IV.*, toes.

are usually well developed, and connected by an interclavicle, which may be connected with the apex of the sternum. The fore-limb has not more than three digits (*I.*, *II.*, and *III.*), the three metacarpals are fused (except in *Archæopteryx*), and

there are only two separate carpals, the others fusing with the metacarpals, and thus forming a carpo-metacarpus. The thumb is often clawed, the second digit rarely.

The ilia of the pelvis may be firmly fused to the complex sacrum; the acetabulum is incompletely ossified; the pubes are directed backwards parallel to the ischia. There is no pubic symphysis except in the African ostrich (*Struthio*), and no ischiac symphysis except in the American ostrich (*Rhea*). In the hind-limb the fibula is incomplete, and more or less united to the tibia; the proximal tarsal bones are united to the distal end of the tibia (which is therefore called a tibio-tarsus), the others being united to the proximal end of three united metatarsals (which thus form a tarso-metatarsus). As in Reptiles, the ankle-joint is therefore intertarsal. The maximum number of toes is four, of which the first is the hallux: if there be four, the metatarsal of the hallux is free from the other three fused metatarsals; if there are only three, the hallux has been suppressed.

In regard to the alimentary system, the absence of teeth, the frequent occurrence of a crop and a gizzard, the usual shortness of the large intestine, the presence of a cloaca, may be noted.

The heart is four-chambered; the single aortic arch curves to the right side; only the pulmonary artery rises from the right ventricle; the two valves between the right auricle and the right ventricle are in part muscular; there is no renal portal system; the red blood corpuscles are oval and nucleated; the blood temperature is from 2° – 14° F. higher than that of Mammals.

The non-expandible lungs are fixed to the dorsal wall of the thorax; the bronchial tubes expand in irregular branches in the lungs; the ends of some of these branches are continued into surrounding air-sacs; these may be continued into the bones, and end in minute air-spaces. The trachea has bony rings, a larynx (without vocal chords) at its upper end, and a

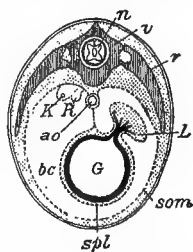

FIG. 356.—Diagrammatic section of young bird.—After Gadow.

n., Spinal cord; v., vertebra; r., rib; L., liver; G., gut; som. (dotted), somatic layer of mesoblast; spl. (dotted), splanchnic layer of mesoblast; ao., aorta; R., reproductive organ; K., kidney.

syrinx or song-box (with vocal chords) at the origin of the

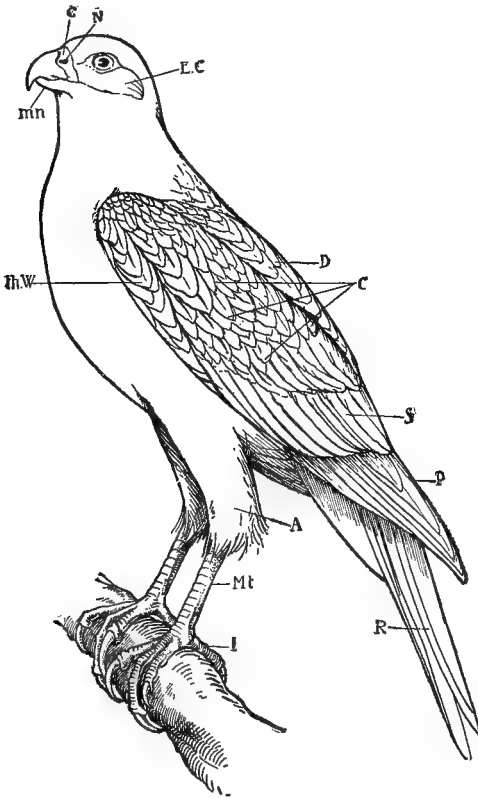

FIG. 357.—A falcon.

mn., Mandible; *C.*, cere; *N.*, nostril; *E.C.*, ear covert; *th.W.*, thumb wing; *C.*, wing coverts; *D.*, dorsal coverts; *S.*, secondaries; *P.*, primaries; *R.*, rectrices; *A.*, ankle; *Mt.*, tarso-metatarsus; *I.*, first toe.

bronchi. *Expiration is the more active part of the respiratory process.*

The (metanephric) kidneys are three-lobed, and lie embedded in the pelvis; the ureters open into the cloaca; there is no bladder; the urine is semi-solid, and consists chiefly of urates. Water must be mainly got rid of by evaporation from the walls of the air-sacs and air-passages.

The testes lie beside the kidneys; the vasa deferentia run

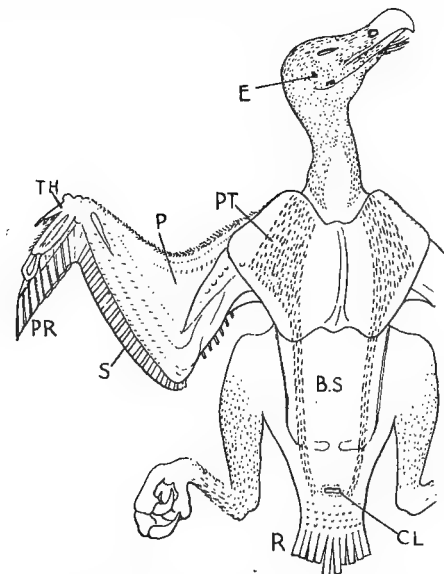

FIG. 358.—Young bearded griffin (*Gypaëtus barbatus*).—After Nitzsch.

Showing the feather-tracts or pterylæ, for instance those on the breast (*PT.*). *E.*, ear; *P.*, web or propatagium; *TH.*, thumb; *PR.*, bases of primary feathers; *S.*, bases of secondary feathers; *B.S.*, bare streak without pterylæ; *CL.*, cloaca; *R.*, bases of rectrices or tail feathers.

outside the ureters, and open into the middle region of the cloaca. The right ovary atrophies, the right oviduct is rudimentary. There is rarely any copulatory organ, but it is large in ostriches, ducks, geese, and some other birds.

The eggs have much yolk and hard calcareous shells. The segmentation is meroblastic and discoidal. The allantois is chiefly respiratory, though it helps in absorbing the nutritive

substance of the egg, and acts as a receptacle for the embryo's waste products.

THE PIGEON (*Columba*) AS A TYPE OF BIRDS

The numerous varieties of domesticated pigeon (pouter, fantail, tumbler, etc.) are all descended from the rock-dove, *Columba livia*, and afford vivid illustrations of variation, and of the results of artificial selection. Certain variations, e.g. in beak or tail, crop up, we know not how; and similar forms are bred together until a new breed is established.

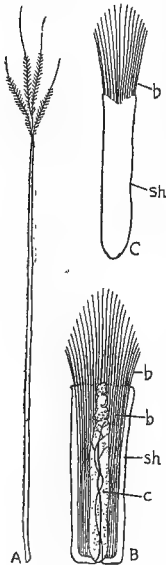

FIG. 359.—After Nitzsch.

A., Filoplume. B., very young feather within its sheath (*sh.*); *c.*, the core of dermis; *b.*, the barbs. C., the same, external view.

External characters.—The form of the body, well suited for rapid flight, ceases to be graceful when stripped of its feathers. The cere above the nostrils, the third eyelid in the anterior upper corner of the orbit, the external opening of the ear concealed by the feathers, the preen gland on the dorsal surface at the root of the tail, and the cloacal aperture, are external features easily recognised.

The feathers most important in flight are the twenty-three remiges of the wing, divided into eleven primaries borne by the metacarpals and phalanges of the two fingers, and twelve secondaries borne by the ulna. Twelve tail feathers or rectrices serve as a brake, and help a little in steering. A distinct tuft of feathers borne by the thumb is called the bastard wing. Covering the bases of the large feathers are the coverts, —wing-coverts and tail-coverts,—which belong to the series of contour feathers which give shape to the whole body. In the pigeon there are no true down-feathers or plumules, but among the ordinary contour feathers or pennæ there are little hair-like feathers (filoplumes) with only a few

terminal barbs. In herons and some other birds some of the down-feathers are covered with dusty powder (powder-down) formed from the brittle ends of the barbs. Apart from their use in flight, the feathers, being bad conductors of heat, serve to sustain the high temperature of the bird. There is usually pigment in feathers, and the coloration thus produced is often enhanced by structural peculiarities of texture and surface. In perfectly white feathers the whiteness is due to gas-bubbles.

Any one of the large feathers consists of an axis or scapus, divided into a lower hollow portion—the calamus or quill, and an upper solid portion—the rachis, which forms the axis of the vane. This vane consists of parallel rows of lateral barbs, linked to one another by barbules, which may be joined to one another by microscopic hooklets. In the running birds the barbs are free. The quill is fixed in a pit or follicle of the skin, from which muscle fibres pass to the feather and effect individual movement. At the base of the quill there is a little hole—the inferior umbilicus—through which a nutritive papilla of dermis is continued into the growing feather. At the base of the vane there is a little chink—the superior umbilicus—but this has no importance, except that parasites sometimes enter by it. Close to this region, however, in many birds, a tuft or branch arises, called the aftershaft. In the Emu and Cassowary the aftershaft is so long that each feather seems double.

A feather begins as a papilla of skin, but the whole is formed from the cornification of the inner layer of the epidermis. The papillæ rarely occur all over the skin (*e.g.* penguin), but are usually disposed along definite feather-tracts. Each papilla consists externally of epidermis and internally of dermis, and becomes surrounded at the foot by a moat, which deepens to form the feather-follicle in which the base of the quill is sunk. The epidermis has two layers—(a) an outer stratum corneum, which in the developing feather forms merely a protective external sheath, and (b) an inner stratum Malpighii, which becomes cornified and forms the whole feather. The process by which this cylinder of cells becomes horny is remarkable; in the upper part ridges are formed, which separate from one another as a set of barbs, the lower part remaining intact as the quill. When we pull off the horny sheath of a young feather, we disclose a set of barbs lying almost parallel with one another, yet slightly divergent. The central pair predominate, and fuse to form the rachis; their neighbours gradually become the lateral barbs. The external sheath falls off; the core of dermis is wholly nutritive, and disappears as the feather ceases to grow.

On the four toes and on the base of the legs there are horny epidermic scales, the presence of which reminds us of the affinities between Birds and Reptiles. The toes are always clawed. The thumb of Birds is often clawed; the second digit very rarely. Only in the embryo of the ostrich (*Struthio*) is the third digit clawed. The beak is covered by

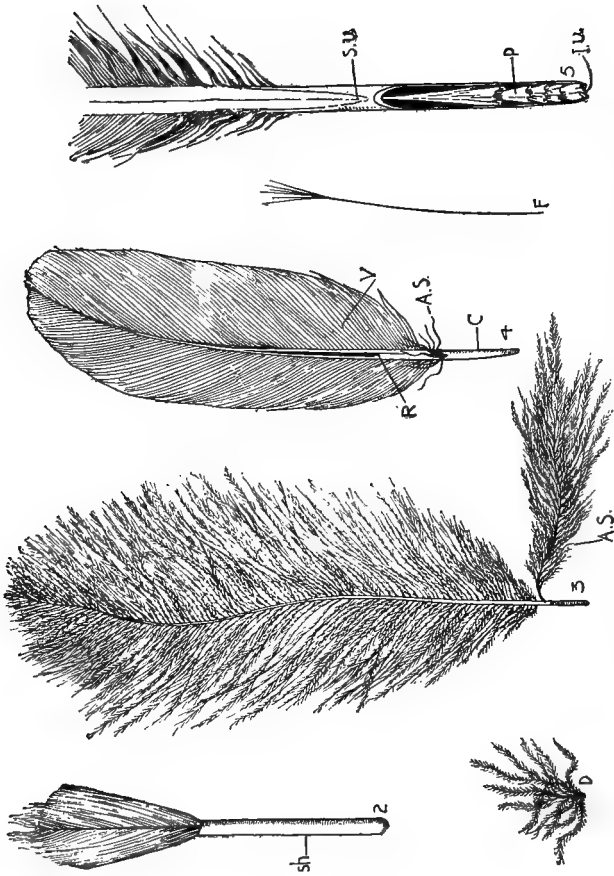

FIG. 360.—Types of feathers.

D., Down. 2, Developing feather in sheath (*sh.*), 3, Cover of heron showing shaft (*A.S.*), 4, Secondary feather of pigeon—*C.*, calamus; *A.S.*, shaft; *R.*, rachis; *V.*, vane, *S.*, Portion of quill showing inferior umbilicus (*I.U.*), superior umbilicus (*S.U.*), pith (*P.*); *F.*, floplume.

a horny sheath, which is annually moulted in the puffin. A moulting of claws occurs in the grouse. The dermis is thin and vascular, and is rich in tactile nerve-endings or Pacinian corpuscles, especially abundant in the cere. The only skin gland—the preen gland—secretes an oily fluid, which some birds use in preening their feathers. It is absent in the ostrich, emu, cassowary, and in a few Carinate birds.

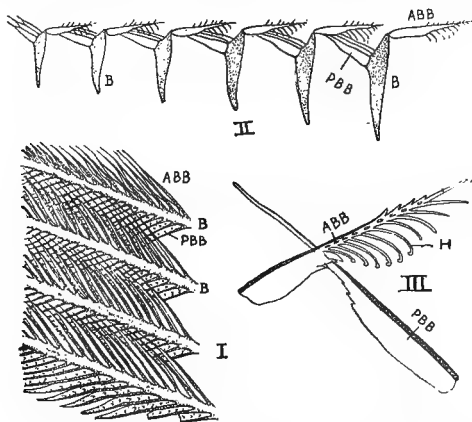

FIG. 361.—Parts of a feather.—After Nitzsch.

I., Four barbs (*B.*) bearing anterior barbules (*A.B.B.*) and posterior barbules (*P.B.B.*); *II.*, six barbs (*B.*) in section, showing interlocking of barbules; *III.*, anterior barbule with barbicels (*H.*).

Muscular system.—The largest breast muscle (pectoralis major) arises from the sternum and its keel, and from the clavicle, is inserted on the *ventral* surface of the humerus, and *depresses* the wing. The smaller but longer pectoralis minor or subclavian, exposed when the large one is reflected, *raises* the wing. It arises from the keel and sides of the sternum, and is continued over the shoulder (through the *foramen triosseum*, which serves as a pulley) to its insertion on the *dorsal* surface of the humerus. Arising chiefly from the coracoid, but in part from the sternum, and inserted on the humerus, is a small coraco-brachialis, which helps a little in depressing the wing. There are several yet smaller muscles.

Interesting also is the mechanism of perching. When the bird sits on its perch, the toes clasp this tightly. The flexor tendons of the

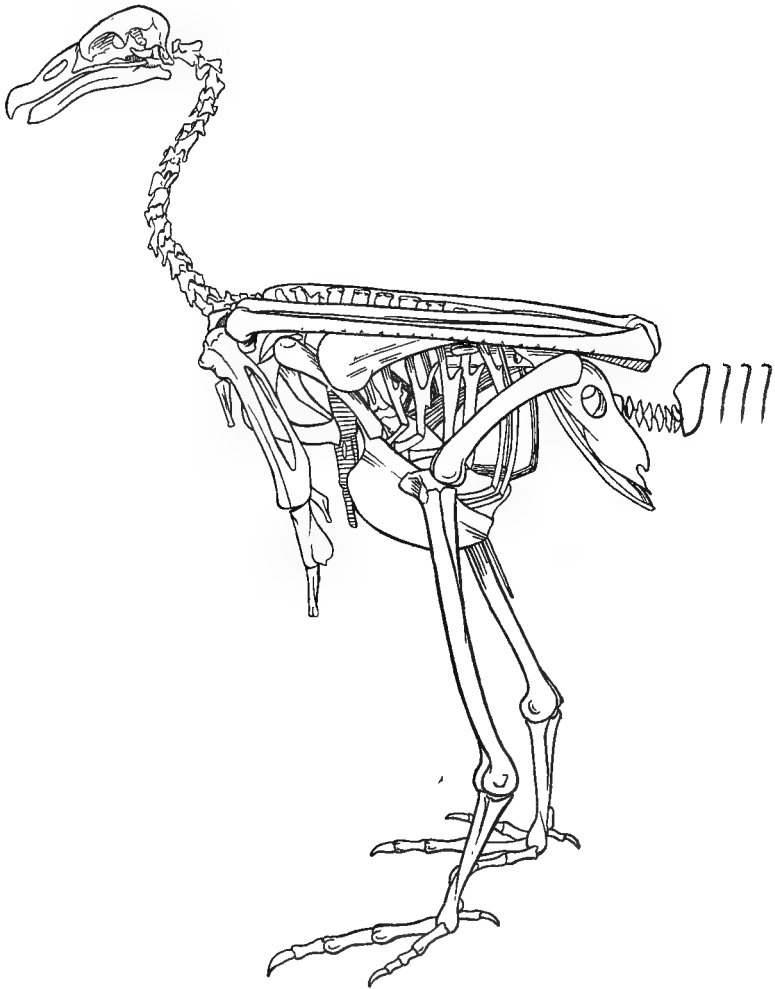

FIG. 362.—Entire skeleton of condor, showing the relative positions of the chief bones.

toes (perforati muscles) are stretched automatically when the ankle is bent in perching. In some birds, an ambiens muscle, inserted on the front of the pubis, is continued down the anterior side of the femur, and its tendon, bending round the knee to the opposite side of the tibia, is inferiorly connected with the tendon of the flexor of the second or third toe, or with the third and fourth. It has nothing to do with bending the first toe, and its importance has been exaggerated. The bending of the toes is mainly due to the perforati muscles.

In connection with the muscular system, it may also be noted that the walls of the gizzard consist of thick muscles radiating around tendinous discs. Two small sterno-tracheal muscles ascend from sternum to trachea, and are apt to be confused in dissection with the carotid arteries. Complex muscles are associated with the song-box.

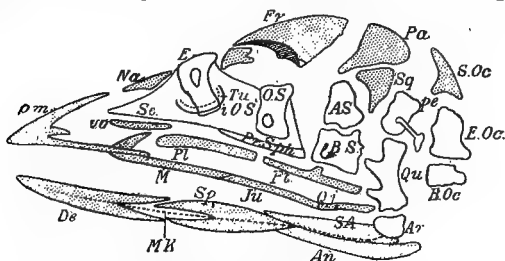

FIG. 363.—Disarticulation of bird's skull.—After Gadow. Membrane bones shaded.

B.Oc., basioccipital; *E.Oc.*, exoccipital; *S.Oc.*, supraoccipital; *Pa.*, parietal; *Fr.*, frontal; *Na.*, nasal; *pm.*, premaxilla; *M.*, maxilla; *Ju.*, jugal; *Qj.*, quadrato-jugal; *Qu.*, quadrate; *pe.*, periotic; *Sq.*, squamosal; *AS.*, alisphenoid; *B.S.*, basisphenoid; *O.S.*, orbito-sphenoid; *Pr.Sph.*, presphenoid; *vo.*, vomer; *iOS.*, interorbital septum; *E.*, ethmoid; *Se.*, nasal septum; *De.*, dentary; *Sp.*, splenial; *An.*, angular; *Sa.*, surangular; *Ar.*, articular; *MK.*, Meckel's cartilage.

Skeleton.—The skeleton of birds is lightly built, with much strength and surface for its weight, on the hollow girder principle. The texture of the bone is often very spongy, and air-sacs from the lungs may be continued into many of the bones, which are then more or less completely destitute of marrow in adult life. In the pigeon, most of the bones, except those of the tail, forearm, hand, and hind-limb, contain air-spaces. Another general character is the marked tendency to fusion of bones, as seen in the skull, dorsal vertebræ, sacral vertebræ, ploughshare bone, carpo-metacarpus, and tarso-metatarsus.

The vertebral column is divided into five regions—cer-

vical, thoracic, lumbar, sacral, and caudal. The mobile neck consists of fourteen cervical vertebræ; from the third to the twelfth these bear short ribs fused to the centra and transverse processes; the thirteenth and fourteenth have them free and well developed, but not reaching the sternum. Of the thoracic vertebræ, namely, those whose ribs reach the sternum, the anterior three are fused to one another, while the fourth is free. The complex sacral region consists of the fifth thoracic (with free ribs reaching the sternum), five or six lumbar, two sacral, and five caudals, all fused. Lastly, there are six free caudals ending in a pygostyle or ploughshare bone,—a fusion of about four vertebræ (cf. coccyx in man). This bone serves as a base for the rectrices.

A cervical vertebra shows on the anterior surface of the centrum a distinctive curvature, described as saddle-shaped or heterocœlous. It is concave from side to side, convex from above downwards. Posteriorly the curvatures are, of course, the reverse.

The ribs have two heads—a capitulum articulating with a centrum, a tubercle articulating with a transverse process. The ventral part of the rib, which reaches the sternum, is called the sternal rib, and is joined at an angle to the dorsal part, which articulates with a vertebra. In Birds the sternal ribs are always bony; in Mammals they are usually cartilaginous. On the posterior surface of each of the first four thoracic ribs there is an uncinatè process, absent only in the S. American screamers (*Palamedæ*).

The skull has a rounded cranial cavity, large orbits, and a narrow beak, which is mostly composed of the premaxillæ. All the bones are fixed except the quadrate, lower jaw, columella, and hyoid. The surface is polished; the sutures are obliterated very early in life.

The back part of the skull is formed by the basioccipital, the two exoccipitals, and the supraoccipital, surrounding the foramen magnum. The basioccipital forms most of the single condyle.

The roof of the skull is formed from the paired parietals, frontals, and nasals, the last being small and in part superseded by the upward extension of the premaxillæ.

The line of the upper jaw consists of premaxilla, small

maxilla, jugal, and quadrato-jugal, the last abutting on the movable quadrate.

Of the membrane bones on the side of the skull, the lachrymal in front of the orbit, and the squamosal between the quadrate and the parietal, are the most important.

On the roof of the mouth, the basisphenoid, which lies just in front of the basioccipital, is covered over by a membrane bone—the basitemporal. In front of this is a sharp “basisphenoid rostrum” or parasphenoid, also a membrane bone. Articulating with the quadrate and with the rostrum are the pterygoids; in front of these lie the palatines. The vomer is vestigial. The bony front of the palate is formed from inward extensions of the premaxillæ and maxillæ. The interorbital septum is formed chiefly from the mesethmoid, but also from the presphenoid. From the tympanum to the inner ear extends the rod-like columella. The lower jaw originally consists of four membrane bones—dentary, splenial, angular, and surangular; and one cartilage bone—the articular. The

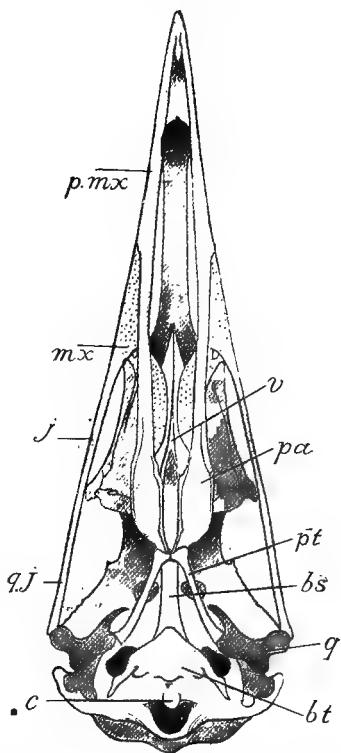

FIG. 364.—Under surface of gull's skull.—From Royal Scottish Museum, Edinburgh.

c., Condyle; *bt.*, basitemporal; *bs.*, basisphenoidal rostrum; *pt.*, pterygoid; *pa.*, palatine; *v.*, vomer; *p.mx.*, premaxilla; *mx.*, maxilla; *j.*, jugal; *q.j.*, quadrato-jugal; *q.*, quadrate.

lower jaw originally consists of four membrane bones—dentary, splenial, angular, and surangular; and one cartilage bone—the articular. The

hyoid consists of a flat "body," with anterior and posterior "horns," the latter derived from the first branchial arch.

The pectoral girdle consists of sabre-like scapulæ extending dorsally over the ribs, of stout coracoids sloping ventrally



FIG. 365.—Wing of dove.

h., Humerus ; *s.f.*, secondary feathers ; *r.*, radius ; *u.*, ulna ; *c.*, carpals ; *mc.*, carpo-metacarpus ; *p.f.*, primary feathers.

and articulating with the sternum, of the clavicles which are united by the interclavicle to form the merrythought or furcula. The opening left where the upper ends of the clavicles touch the scapula and coracoid is called the *foramen triosseum*.

The sternum bears a conspicuous keel, is produced laterally and posteriorly into two xiphoid processes, and

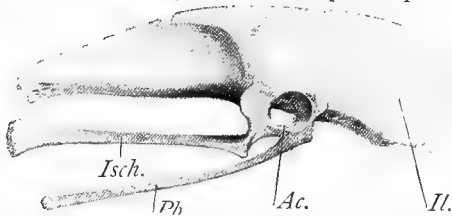

FIG. 366.—Side view of pelvis of cassowary.
Il., Ilium; *Isch.*, ischium; *Pb.*, pubis; *Ac.*, acetabulum.

bears articular surfaces for the coracoids anteriorly, for the sternal ribs laterally.

The skeleton of the wing includes the stout humerus, the separate radius and ulna (the latter the larger), two free carpals, a carpo-metacarpus of one another to one another, and three digits—the thumb with one joint, the first finger with two joints, the second with one. In adaptation to flight, the wing of a bird has much less flexibility of parts than the arm of a Mammal. The radius and ulna do not move upon each other.

The pelvic girdle consists of dorsal ilia fused to the complex sacral region, of ischia sloping backwards, and of pubes running parallel to the ischia. The incomplete ossification of the acetabulum and the absence of ventral symphyses are noteworthy.

The hind-limb consists of a short stout femur, a tibia to which the proximal tarsals (astragalus and os calcis) are fused (forming a tibio-tarsus), an incomplete fibula joined to

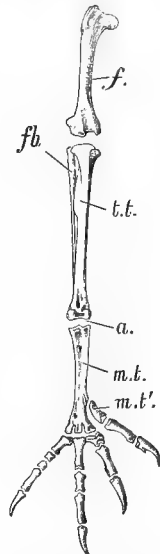

FIG. 367.—Bones of hind-limb of eagle.
f., Femur; *t.t.*, tibio-tarsus; *fb.*, fibula; *a.*, ankle-joint; *m.t.*, tarso-metatarsus; *m.t'*, first metatarsal (free).

the tibia, three metatarsals fused to one another and to the distal tarsals (forming the tarso-metatarsus), a free first metatarsal, and, finally, the four toes. The first, turned backwards, has two phalanges, the second three, the third four, and the fourth five.

Nervous system.—In contrast to the brain of crocodiles and other Reptiles, the brain of the pigeon and other Birds fills the cranial cavity. The cerebral hemispheres

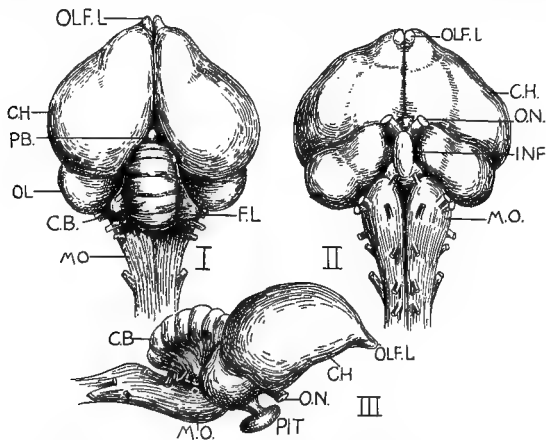

FIG. 368.—Brain of pigeon (I. dorsal, II. ventral, III. lateral aspects).

OLF.L., Olfactory lobes; *C.H.*, cerebral hemispheres; *P.B.*, pineal body; *O.L.*, optic lobes; *C.B.*, cerebellum; *F.L.*, flocculus or lateral extension of cerebellum; *M.O.*, medulla oblongata; *PIT.*, pituitary body at end of infundibulum (*INF.*); *O.N.*, optic nerves crossing in the chiasma.

are large and smooth. Their roof is thin, their main mass consists of the large corpora striata which bulge into the ventricles. They meet the cerebellum and throw the solid optic lobes to the sides. The olfactory lobes are very small (cf. deficient sense of smell). Between the cerebral hemispheres and the cerebellum, the pineal body rises to the surface, and a slight posterior separation of the hemispheres will disclose the region of the optic thalami. The large cerebellum is ridged transversely and divided into a median lobe and two small lateral flocculi. The

curvature of the brain is well marked in the adult; thus the medulla is quite hidden by, and descends almost vertically from, the cerebellum.

There are as usual twelve cranial nerves.

In connection with the spinal cord, the brachial plexus of nerves to the forearm, and the sacral plexus to the leg, should be noticed. In the lumbar region the halves of the cords diverge for a short distance, forming a wide space—the rhomboidal sinus—roofed only by membrane. The cervical part of the sympathetic nervous system is double on each side.

Sense organs.—The sense of smell is not well developed in Birds. The nostrils are longitudinal slits overhung by the swollen, more or less tactile, cere. Apart from the cere, there is only a diffuse sense of touch, and the sense of taste is also slightly developed.

The sense of hearing is acute. Externally the ear is marked by an open tube—the external auditory meatus; the aperture of which lies behind the eye, concealed beneath the feathers. Within the tube, a little beneath the surface, lies the drum or tympanum; connecting this with the fenestra ovalis of the inner ear is the columella; the tympanic chamber is continued past the ear as the Eustachian tube, which unites with that of the opposite side, and opens into the mouth cavity in front of the basisphenoid bone. The cochlea, or curved protuberance of the sacculus, which is incipient in Amphibians, and larger in Reptiles, is yet more marked in Birds.

The eye has an upper, a lower, and a third eyelid or nictitating membrane. The last is frequently twitched across the eye, and helps to keep the front clean; it is present in many Reptiles and most Mammals. The front of the sclerotic protrudes in a rounded cone, and is strengthened by a ring of little bones. Into the vitreous humour a vascular pigmented pecten protrudes from the region of the blind spot where the optic nerve enters. Birds have remarkable powers of optic accommodation.

Alimentary system.—The jaws are ensheathed in horn, and this sheath takes the place of teeth, and is sometimes ridged, as in ducks. It is interesting to notice that this horny beak was absent in some of the extinct toothed birds. In modern birds there are no hints of teeth,

except that "a dental ridge" (see Mammals) has been detected in some embryos. A narrow tongue lies in the floor of the mouth; it is unimportant in the pigeon, but is often useful, as in parrots, woodpeckers, and humming-birds. Associated with the tongue there are numerous glands. On the roof of the mouth lie the posterior nares, and behind them the *single* aperture of the Eustachian tubes. The gullet expands into a thin-walled, bilobed, non-glandular crop, in which the hurriedly swallowed seeds are stored and softened. Especially at the breeding season, the cells lining the crop degenerate, and form "pigeon's milk," which both sexes give to the young birds.

From the crop the food canal is continued into the glandular part of the stomach (the proventriculus), where gastric juice is secreted from large glands.

Beneath the proventriculus is the gizzard, in which the food is ground. The walls are very muscular, the fibres radiating from two tendinous discs; the internal surface is lined by a hard, horny epithelium; and within the cavity are small stones which the bird has swallowed. In hawks and fish-eating birds the gizzard region is, naturally enough, soft. The pyloric opening, from the gizzard into the duodenum, is very near the cardiac opening from the proventriculus into the gizzard.

In the fold of the long duodenum lies the pancreas with three ducts, whose number points to the triple origin of the pancreatic rudiment in the embryo. Into the same region open two bile-ducts from the two-lobed liver, which is without a gall-bladder in the common pigeon, though this is present in some birds, and even in some species of pigeon.

The small intestine is long; the large intestine very short,—not more than a rectum two inches in length: At the junction of the small and the large intestine there are two short cæca. In some birds, *e.g.* the fowl, these are of considerable length; in the ostrich they are very long; there are three in many ducks and birds of prey; there is only one in some fish-eating birds; in hornbills, parakeets, etc., they are absent.

The cloaca has three divisions (see Fig. 369),—an upper part into which the rectum opens, a median part into which the ureters and the genital ducts open, and a posterior region (proctodæum), opening into

which from the dorsal surface is a sac of obscure function, the bursa Fabricii, which usually disappears during adolescence. It is at first a blood-forming organ, but often becomes a mass of fibrous connective tissue.

Vascular system.—The relatively large four-chambered heart, the complete separation of arterial and venous blood, the single aortic arch bending over to the *right* side, and the hot blood (about 38° C., 100° F.), are important characteristics. The heart-beats are more rapid in birds than in other Vertebrates, being about 120 per minute when the bird is at rest, and far more when it is flying.

The impure blood returned by the venæ cavæ to the right auricle passes into the right ventricle through the auriculo-ventricular valve (which has two *muscular* flaps without chordæ tendineæ or papillary muscles). From the right ventricle it is driven to the lungs. From the lungs the purified blood returns to the left auricle, and passes through two *membranous* valves (with chordæ tendineæ and papillary muscles) into the left ventricle. Thence it is driven through the arterial trunk into the carotids, the subclavians, and the dorsal aorta. The bases of the aortic and pulmonary trunks are guarded by three semilunar valves. From the capillaries the impure blood is collected anteriorly in two superior venæ cavæ (precavals), and posteriorly in an inferior vena cava (postcaval), composed of veins from hind-legs and kidneys, and receiving as it approaches the heart the hepatic veins from the liver.

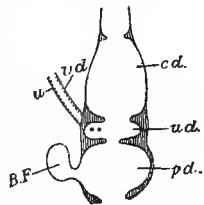

FIG. 369.—Diagrammatic section of cloaca of male bird.—After Gadow.

cd., Upper region of cloaca into which rectum opens; *ud.*, median region into which ureter (*u.*) and vas deferens (*vd.*) open from each side; *pd.*, posterior region into which bursa Fabricii (*B.F.*) opens.

The right auricle of the heart is larger than the left; the right ventricle has thin walls, and partly surrounds the more muscular left ventricle. The muscular right auriculo-ventricular valve does not quite encircle the opening from the auricle, an imperfect differentiation which recurs in the Monotreme Mammals.

The *arterial* system consists of the following vessels (Fig. 370):—

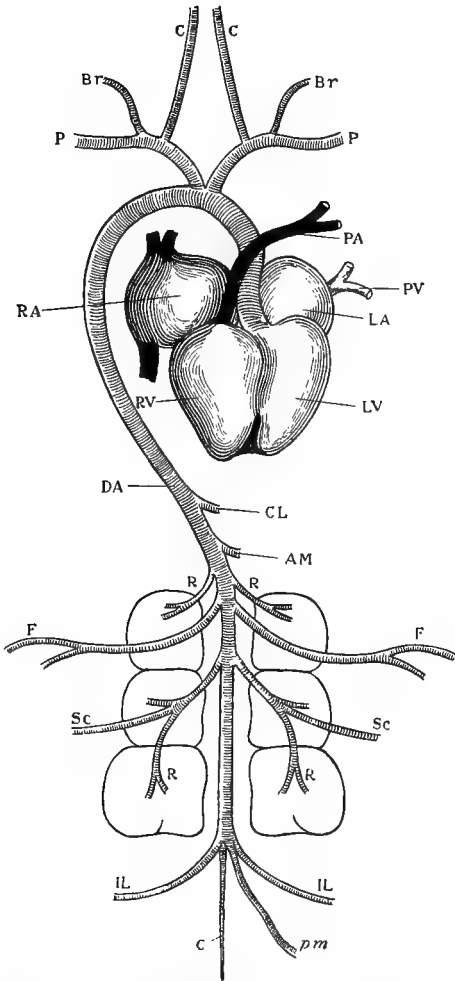

FIG. 370.—Heart and arterial system of pigeon.

R.A., right auricle; *R.V.*, right ventricle; *L.V.*, left ventricle; *L.A.*, left auricle; *P.V.*, pulmonary veins; *P.*, pectoral artery; *Br.*, brachial artery; *C.*, carotid artery; *D.A.*, dorsal aorta; *C.L.*, coeliac; *A.M.*, anterior mesenteric; *R.*, renals; *F.*, femoral; *Sc.*, sciatic; *IL.*, iliac; *p.m.*, posterior mesenteric; *C.*, caudal.

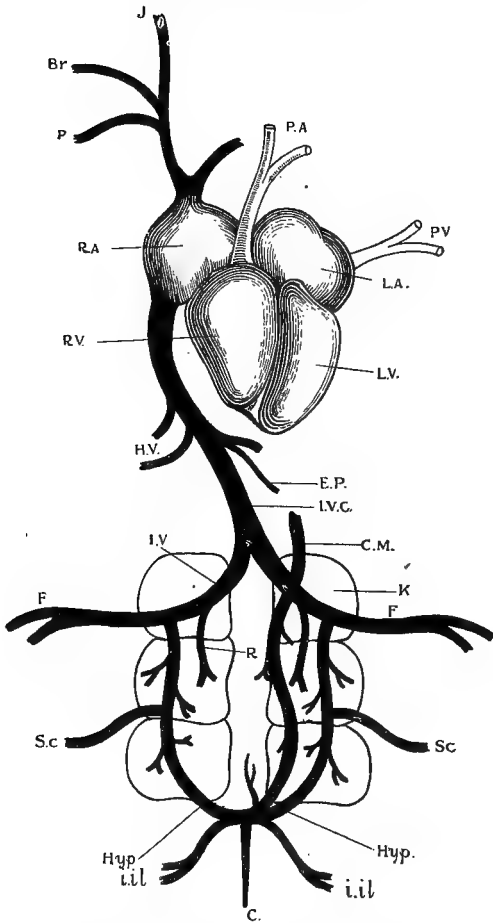

FIG. 371.—Heart and venous system of pigeon.

R.A., Right auricle; *R.V.*, right ventricle; *L.V.*, left ventricle; *L.A.*, left auricle; *P.V.*, pulmonary veins; *P.A.*, pulmonary arteries; *J.*, jugular; *Br.*, brachial; *P.*, pectoral; *H.V.*, hepatic; *E.P.*, epigastric; *I.V.C.*, inferior vena cava; *C.M.*, coccygeo-mesenteric; *I.V.*, iliac; *F.*, femoral; *R.*, renal; *Sc.*, sciatic; *Hyp.*, hypogastric or "renal-portal"; *i.il.*, internal iliac; *C.*, caudal.

- (a) The arterial trunk, as it rises from the heart, gives off on each side an innominate artery. Each innominate gives off a carotid and a subclavian, and the subclavian immediately divides into a brachial to the arm and a pectoral to the breast muscles.
- (b) The dorsal aorta, formed by a continuation of the arterial trunk bending round on the right side, gives off cœliac, mesenteric, renal, femoral, sciatic, iliac, and other arteries.
- (c) The pulmonary arteries carry impure blood from right ventricle to lungs.

The *venous* system consists of the following vessels (Fig. 371):—

- (a) Two superior venæ cavæ, each formed from the union of jugulars from the head, a brachial from the arm, and a pectoral from the breast.
- (b) The inferior vena cava is formed from the junction of two iliac veins just in front of the kidneys. Each of these iliacs results from the union of a femoral from the leg, an efferent renal from the kidney, and a “renal-portal,” or hypogastric, which passes upwards through the kidney. To understand this hypogastric, it is convenient to begin at the tail. A short caudal vein divides anteriorly into right and left branches, each of which receives an internal iliac from the sides of the pelvic region. Thus the hypogastric is formed at each side, and this, passing upwards through the kidney, receives the sciatic, and finally joins with the femoral and with the renal.
- (c) The pulmonary veins carry pure blood from lungs to left auricle.

The hepatic portal system is as usual,—mesenteric veins from the intestine combine in portal veins; the blood filters through the liver, and is collected in hepatic veins, which unite with the anterior end of the inferior vena cava.

A hint of a renal-portal system is represented by small branches, which the femorals give off to the kidney.

From the transverse vein formed between the two hypogastrics or by the division of the caudal vein, a coccygeo-mesenteric arises, which receives vessels from the cloaca and large intestine, and is continued along the mesentery to join the hepatic portal system.

As there are rarely any valves in the hypogastric veins, the blood from the viscera and hind-limbs can pass freely either through the iliac veins and thence to the inferior vena cava, or through the coccygeo-mesenteric vein to the hepatic portal system.

The epigastric vein of the bird takes blood from the fat-laden sheet or great omentum which covers the abdominal viscera. It leads not into the liver, but into one of the hepatic veins.

Associated with the blood-vascular system there is a lymphatic system with a few lymphatic glands.

The spleen lies on the right side of the proventriculus, the paired thyroid lies beside the origin of the carotids, and a paired thymus is found in young birds in the neck region. Small yellowish (suprarenal) glands lie on the front part of the kidneys.

Respiratory system.—The important facts are,—that there is no true diaphragm; that some of the bronchial branches in the lungs are continued into adjacent air-sacs; that expiration is a more active process than inspiration.

The nostrils lie at the base of the beak overlapped by the cere. Only in the kiwi are they at the tip of the beak. The glottis behind the root of the tongue leads into the trachea, which has a voiceless larynx at its anterior end, and a syrinx, with vocal chords, at its base. The trachea is strengthened by bony rings, and is moved by two sternotracheal muscles from the sternum. The bronchial tubes branch irregularly, in a kind of tree-like fashion, in the lungs and end in very fine air-tubes. These lie attached to the dorsal wall of the thorax, indented by the ribs, and covered with pleural (peritoneal) membrane on their ventral surface only.

Around the lungs, and connected with the ends of the main bronchial branches, are the nine air-sacs. In order from behind forwards, lie the abdominals, the posterior thoracics, the anterior thoracics, the cervicals, and the interclavicular in the middle line in front. The interclavicular sac is in connection with both lungs, and is continued into two axillary sacs in the arm-pits. The anterior and posterior air-sacs are continuous with air-spaces in the bones. In the resting bird the sternum rises and falls; in the flying birds the thoracic region compresses the lungs and air-sacs; in either case, expiration is the more active part of the respiratory process.

Excretory system.—The kidneys are three-lobed, and lie embedded in the pelvis. They receive blood from the dorsal aorta by renal arteries, and the filtered blood leaves them by renal veins which unite with femorals and renal portals to form the iliacs, or, we may almost say, the inferior vena cava. But the kidney also receives a little venous blood from branches of the femoral veins. Thus, there is just a hint of a renal-portal system, which does not occur in Mammals. The kidneys are metanephric in origin.

The waste products, consisting for the most part of urates, pass in semi-solid form down the ureters into the median compartment of the cloaca.

In front of each kidney, at the base of the iliac vein, there lies a suprarenal body.

Reproductive system.—The testes lie in front of the kidneys. Like the ovary, they increase in size at the breeding season, and dwindle afterwards; the sexual period in

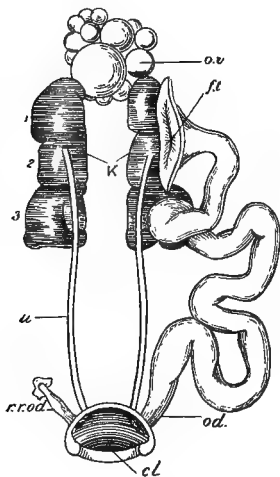

FIG. 372.—Female urogenital organs of pigeon.

K., Kidney with three lobes; *u.*, ureter; *cl.*, cloaca; *ov.*, ovary; *od.*, oviduct; *ft.*, funnel at end of oviduct; *r.r.od.*, rudimentary right oviduct.

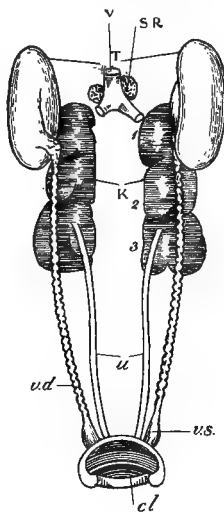

FIG. 373.—Male urogenital organs of pigeon.

T., testes; *V.*, base of inferior vena cava; *S.R.*, suprarenal bodies; *K.*, kidneys with three lobes (1, 2, 3); *u.*, ureter; *v.d.*, vas deferens; *vs.*, seminal vesicle; *cl.*, cloaca.

birds being much more narrowly limited than in most other Vertebrates.

The spermatozoa pass from the testis into a vas deferens, which lies to the outside of the corresponding ureter. The vasa deferentia, slightly convoluted when full of sperms, and with a posterior swelling or seminal vesicle, open separately into the median compartment of the cloaca.

In the adult pigeon, and in most birds, there is only one

ovary; that of the right side usually atrophies early in life. The right oviduct is represented by a small rudiment close to the cloaca.

The ovary is covered with follicles containing ova at various stages of ripeness. As these ova become dilated with yolk and otherwise mature, they burst from the ovary, and are caught by the dilated end of the oviduct which opens into the cœlom. The first part of the oviduct is a funnel or ostium tubæ, which grips the ovum and probably form the thin (chalaziferous) layer of dense albumin next the yolk. The second part is the albumin-secreting portion, which forms dense albumin. The third portion, called the isthmus, makes the shell-membrane and more albumin. The fourth region, badly called the uterus, makes the shell and 30-40 per cent. of the albumin, which passes by diffusion through the shell-membrane before the shell is formed. The fifth portion, called the vagina, is very muscular and expels the egg. It has only unicellular glands which perhaps secrete the external cuticle of the shell, plus pigment.

A section through the oviduct shows—a peritoneal investment, longitudinal muscles, connective tissue with blood vessels, circular muscles, connective tissue, a thick layer of convoluted branched tubular glands except in the funnel and the vagina, and most internally ciliated epithelium, except in the anterior part of the funnel.

In sexual union the cloaca of the male is closely apposed to that of the female; only in a few cases (in ducks and geese, *Crax*, *Tinamus*, and in the *Ratitæ*) is there a copulatory organ. The eggs are incubated by the parents for a fortnight, a high temperature of about 40° C. being sustained throughout.

HABITS AND FUNCTIONS OF BIRDS.

Flight.—As birds are characteristically flying animals, many of their peculiarities may be interpreted in adaptation to this mode of motion.

(a) *Shape and general structure of the body.*—The resistance offered by the air to the passage of a body through it depends in part on the shape of the body, and the boat-like shape of the bird is such that it

offers relatively little resistance. The attachment of the wings high up on the thorax, the high position of such light organs as lungs and air-sacs, the low position of the heavy muscles, the sternum, and the digestive organs, the consequently low centre of gravity, are also structural facts of importance. But it must be remembered, that the frictional resistance of the air is slight.

(b) *The muscles of flight.*—The pectoralis major brings the wing downward, forward, and backward, keeping

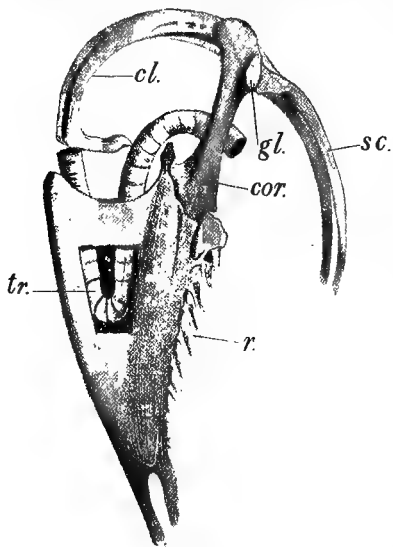

FIG. 374.—Pectoral girdle and sternum of Bewick's swan.

A part of carina removed shows peculiar loop of trachea (*tr.*); *cl.*, clavicle; *cor.*, coracoid; *sc.*, scapula; *gl.*, glenoid cavity for head of humerus; *r.*, parts of sternal ribs.

the bird up and carrying it onward. As it has most work to do, it is by far the largest. The pectoralis minor raises the wing for the next stroke. There are others of minor importance. On an average these muscles weigh about one-sixth of the whole bird, nearly one-half in some pigeons. Buffon noted that eagles disappeared from sight in about three minutes, and a common rate of flight is about fifty feet per second. In migration many birds fly at a rate of over 100 miles an hour.

(c) *The skeleton.*—The rigidity of the dorsal part of the backbone, due to fusion of vertebræ, is of advantage in affording a firm fulcrum for the wing-strokes, while the arched clavicles (meeting in an interclavicle and often fused in front to the sternum) and the strong coracoids (which articulate with the sternum) are adapted to resist the inward pressure of the

down-stroke. As the keel of the breast-bone serves in part for the insertion of the two chief muscles, its size bears some proportion to the strength of flight. It is absent in the running birds, such as the ostriches, and has degenerated in the New Zealand parrot (*Stringops*), which has ceased to fly and taken to burrowing.

(d) *Air-sacs and air-spaces.*—The lungs of birds open into a number of air-sacs, which have a larger cubic content than the lungs, and in many cases these air-sacs are continued into the bones, among the

viscera, and even under the skin. From a broken bone it is possible to inflate the air-sacs, and through a broken bone a bird with choked windpipe may for a time breathe. The whole system of air-containing cavities is continuous, except in the case of the skull bones, whose spaces receive air from the nasal and Eustachian tubes. The air must lessen the specific gravity of the bird, but a few mouthfuls of food are sufficient to counteract the lightening. Moreover, in many small birds of powerful flight, all the large bones, or all except the humerus, contain marrow, and are therefore not "pneumatic"; and the hornbill,

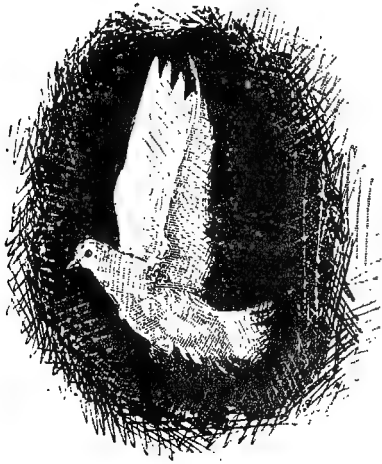

FIG. 375.—Position of wings in pigeon at maximum elevation.
From Marey.

which has no great power of flight, is one of the most pneumatic of birds. It is certain that in ordinary flight the lightest of birds has to keep itself from falling by constant effort. The air-sacs increase the bird's respiratory content, secure more perfect aeration of the lungs, and assist in internal perspiration, thus helping in the regulation of the body temperature.

To carry the weight of the bird, the wings strike vertically; to carry the bird onwards, they strike obliquely. Sometimes the direction of the stroke is more vertical, and then the bird mounts upward; sometimes it is more oblique, and then the bird speeds onwards; usually both

directions are combined. The raising of the wing after each stroke requires relatively little effort, the resistance to be overcome being very slight. In steering, the feathers of the tail often bear to the wings a relation comparable to that between rudder and sail.



FIG. 376.—Wings coming down.—From Marey.

Modes of flight.—There are three chief modes of flight:—

1. By gliding or skimming, during which the bird has its wings spread, but does not flap them, depending for its movement on the

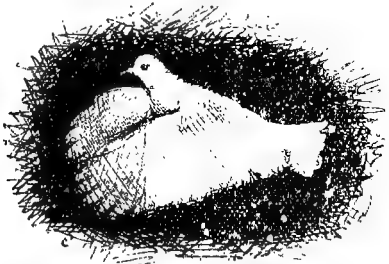

FIG. 377.—Wings completely depressed.—From Marey.

velocity acquired by previous strokes, by descending from a higher to a lower level, or by the wind. This may be readily observed in gull and heron, in a pigeon gliding from its loft to the ground, or in a falcon swooping upon its quarry.

2. By active strokes of the wings, in which the wings move downward and forward, backward and upward, in a complex curve. This is of course the commonest mode of flight.

3. By sailing or soaring with motionless spread wings, in which the bird does not necessarily lose in velocity, or in vertical position, as is the case in gliding. It is illustrated by such birds as crow, falcon, stork, albatross, and has been observed only when there was wind.

Song of birds.—Singing is a natural expression of emotional intensity. It is richest at the breeding season, and is always best and often solely developed in the males. But song in any excellence is the gift of comparatively few birds, though nearly all have a voice of some sort, often so characteristic that the species may be recognised by its call. The parrot and the jackdaw, and others, can be taught to pronounce articulate words; and the power of imitation is widespread among birds, which are notorious plagiarists. This power of imitation is important in relation to the general theory of instinct, for the song of all birds is probably in great part imitative, though to a limited extent inherited. Young birds taken away from their nests when very young, so that they have hardly heard the voices of their kind, may utter the characteristic note of the species, but they sing the song imperfectly.

Many birds, apart from those who have been educated, have "words," expressing pleasure, pain, sense of danger, presence of food, and the like. But there is a difference between uttering words and having a language, which implies the expression of a judgment.

Courtship.—Birds usually pair in the springtime, but there are many exceptions. A few, *e.g.* some of the birds of prey, live alone except at the pairing time; others, notably the doves, always live together in pairs; many, such as rooks, parrots, and cranes, are sociable, gregarious birds. A few, like the fowls, are polygamous; the cuckoo is polyandrous.

In most cases, however, birds pair, and the mates are true to one another for a season. The pairing is often preceded by a courtship, in which the more decorative, more vocal males win their desired mates, being, according to Darwin, chosen by them. Darwin attributed the captivating characteristics of the males, well seen in peacocks and birds of paradise, or as regards musical powers in most of our own British songsters, to the sexual selection exercised by the females; for if the more decorative or the more melodious males always got the preference in courtship, the qualities which contributed to their success would tend to predominate in the race. He believed, moreover, that characteristics of male parents were entailed on male offspring. Wallace regarded the differences between males and females in another way, arguing that in the course of natural selection the more conspicuous females had been eliminated, brightness being disadvantageous during incubation. It seems likely enough that both conclusions are to some extent true, while there is much to be said in favour of a deeper explanation, to which Wallace inclines, that the secondary differences between the sexes are correlated with the fundamental constitutional differences involved in maleness and femaleness.

Nests.—After pairing, the work of nest-building is begun. Almost all birds build nests; the well-known habit is a characteristic expression

of their parental care. Other creatures, indeed, such as sticklebacks among Fishes, and squirrels among Mammals, besides numerous Insects, build nests, but the habit is most perfectly developed among Birds. As is well known, each species has its own peculiar style of nest, and builds it of special materials. Generally the nest is solitary, hidden in some private nook. The perfection of art which is reached by some birds in the making of their nests is marvellous; they use their bills and their feet, and smooth the inside by twisting round and round. Usually the hen does most of the work, but her mate sometimes helps, both in building the nests and in hatching the young.

The nest is a cradle rather than a house, for its chief use is to secure an approximately constant warmth for the young which are being formed within the eggs; and to afford protection for the helpless fledglings. At the same time, the nest secures the comfort of the parent-bird during the days and nights of brooding.

The variety of nests may be illustrated by mentioning the burrowed nests of sand-martins and kingfishers, the ground-nests of game-birds and gulls, the mud-nests of house-martin and flamingo, the holes which the woodpecker fashions in the tree-stem, the platforms built by doves and eagles, storks and cranes, the basket-nests of most singing-birds, the structures delicately woven by the goldfinch, bullfinch, and humming-birds, the sewed nest of the tailor-bird, the mossy nests of the wrens, the edible nest of the *Collocalia*, which is chiefly composed of mucin secreted by the salivary glands.

Eggs of birds.—When the nest is finished, the eggs are ready to be laid. After they are laid, the patience of brooding begins. With the great care that Birds take of their young we may associate the comparatively small number of the eggs; but there are probably other reasons why the number of offspring decreases as animals become more highly evolved.

The size of the egg usually bears some relation to the size of the bird. Of European birds, the swans have the largest eggs, the golden-crested wrens the smallest. It is said that the egg of the extinct *Moa* sometimes measured 9 in. in breadth and 12 in. in length; while that of the extinct *Aepyornis* held over two gallons, some six times as much as an ostrich's egg, or a hundred and fifty times as much as a fowl's. Yet the size of the egg is only generally proportional to that of the bird; for, while the cuckoo is much larger than the lark, the eggs of the two are about the same size; and while the guillemot and the raven are almost of equal size, the eggs of the former are in volume about ten times larger than those of the latter. The eggs of birds whose young are rapidly hatched and soon leave the nests are large. Professor Newton remarks that "the number of eggs to be covered at one time seems also to have some relation to their size," while from what one notices in the poultry-yard, and from a comparison of the habits of different birds, it seems probable that a highly nutritive, sluggish bird will have larger eggs than a bird of more active habit and sparser diet.

The shell of the egg is often very beautifully coloured; there is a predominant tint upon which are spots, streaks, and blotches of varied colour and disposition, so that the egg is almost always characteristic of

the species. Pigments related to those of the blood and the bile are deposited while the shell is being formed in the lower part of the oviduct. As the eggs may move before the pigments are fixed, blotchings and markings naturally result. The coloration is often protectively harmonious with that of the surroundings. Thus eggs laid almost on the ground are often brownish like the soil, those laid near the seashore often look very like stones, while conspicuous eggs are usually found in covered nests.

Some newly hatched young are naked, blind, and helpless, and have to be carefully fed by their parents until they are fully fledged. This is true of the thrush and of many other song-birds. Others are born covered with down, but still helpless; while a few, like the chicks, are able to run about and feed themselves a few hours after they leave the egg. Those which require to be fed and brooded over are called *Altrices*; those which are at once able to feed themselves are called *Præcoces*.

Moulting.—Every year birds lose their old feathers. This moulting generally takes place after the fatigue of the breeding season, but in the case of the swallows, and the diurnal birds of prey and some others, the moult is in mid-winter. The process is comparable to the casting of scales in Reptiles, and to the shedding of hair in Mammals. Feathers are so easily injured that the advantage of the annual renewal is evident, especially when it takes place just before the time at which it may be necessary to set forth on a long migratory flight.

In moulting, the feathers fall out and are replaced gradually, but sometimes they are shed so rapidly that the bird is left very bare; thus moulting geese, ducks, and rails lose all their quills at once and are unable to fly. There are many birds that moult, more or less completely, more than once a year; thus the garden warbler sheds its feathers twice. The males of many birds assume special decorations after a partial or complete moult before the time of pairing (ruff, knot, golden plover). The ptarmigan changes its dress three times in the year; after the breeding season the plumage becomes grey; as the winter sets in it grows white, and suited to the surrounding snow; in the spring, the season of courtship, the mottled brown wedding robes are put on.

Diet.—The food of birds varies greatly, not only in different kinds, but also at different seasons. Many are herbivorous, feeding on the soft green parts of plants, and in these birds the intestine is long. Some confine themselves to grain, and these have large crops and strong grinding gizzards, while those which combine cereals and insects have in most cases no crop. A few sip honey, and may even help in the cross-fertilisation of flowers; those that feed on fruits play an important part in the dissemination of seeds; those that devour insects are of great service to man. In fruit-eating and insectivorous birds the crop is usually small, and the gizzard only slightly muscular. But many birds feed on worms, molluscs, fishes, and small mammals; in these the glandular part of the stomach is more developed than the muscular part. The nature of the stomach in the Shetland gull changes twice

a year, as the bird changes a summer diet of grain and seeds for a winter diet of fish, and *vice versa*. In the case of canaries, bullfinches, parrots, etc., it has been noted that the food influences the colouring of the plumage.

Migration of birds.—Migration remains in no small degree a zoological mystery. On certain points we need more facts, and even where facts are abundant we but imperfectly understand them. Let us first state some of the outstanding facts.

1. Most birds seem to be more or less migratory, but the range differs greatly. It is said that the dotterel may sup on the North African steppe and breakfast next morning on the Arctic tundra; and although the alleged rate may not be demonstrable, there is no doubt that a distance of about 2000 miles is traversed by this bird and by many others. In the tropics, on the other hand, the migration may simply be from valley to hillside.

2. Observers in temperate countries long ago noticed that the birds they saw might be grouped in reference to their migrations. Thus (a) some arrive in spring from the South, remain to breed, and leave for the South in autumn, *e.g.* swallow and cuckoo in Britain; (b) some arrive in autumn, chiefly from the North, stay throughout the winter, and fly northwards again in spring, *e.g.* the fieldfare and the redwing in Britain; (c) some—the “birds of passage”—are seen only for a short time twice a year on their way to colder or warmer countries in spring or autumn, *e.g.* sandpipers; and (d) some seem to deserve the name of “residents,” but really exhibit a partial migration, such as the song-thrush and redbreast in Britain. In Europe the spring migration is on the whole northwards and north-eastwards, in autumn southwards and south-eastwards, but the paths are great curves.

3. There is a striking regularity in the advent and departure of many of the migrants. In spite of the immense distances which many of our immigrants travel, and in spite of unpropitious weather, they are often punctual within a day or two to their average time of arrival for many years. Similarly some birds, such as the swifts, are hardly less precise in leaving our shores.

4. It has been proved in a few cases that individual birds may find their way back to where they made their nest in previous years. Not less marvellous is the security with which the flight from country to country is continued in darkness, at great heights, and over the trackless sea. At the same time it must be noticed that the mortality during migration is very great.

Having stated a few of the outstanding facts, let us note some of the interpretations and suggestions which help us to understand them.

The impulse to migrate is instinctive; but it is likely that there are always immediate causes which prompt the instinct, such as scarcity of food, the shortening daylight, and the increasing cold in the case of many birds which leave us in autumn. It is more difficult to recognise the immediate causes prompting their return. In leaving Britain the young birds usually fly first; in returning, the sexual adults lead the way.

It seems likely that the origin of the migrating habit is wrapped up with the history of climates, and we can understand how the setting in

of glacial conditions from the north would gradually force birds, century by century, to a longer flight southwards. And if the climatic conditions limit the area of safe and comfortable breeding to one country (the more northerly), and the possibility of food during winter to another country (the more southerly), we can understand, with Wallace, "that those birds which do not leave the breeding area at the proper season will suffer, and ultimately become extinct; which will also be the fate of those which do not leave the feeding area at the proper time." In short, given environmental changes of climate on the one hand, and a measure of plasticity and initiative on the part of the organism, the instinct of migrating would be perfected in the course of natural elimination.

But while this view is so far satisfactory, it leaves us face to face with the problem how birds migrate as safely and surely as they do on their pathless way. For to point out that the merciless elimination which continually goes on keeps up the standard of racial fitness, leaves us still wondering how any became fit at all.

One welcomes therefore any suggestion as to the manner in which birds learn or have learned to find their way. The power has been compared to the "homing" faculty of some pigeons, but most believe that pigeons are guided largely by noticing landmarks, which could hardly be done over 10,000 miles of land, and obviously not over 1000 miles of sea, or during the night. Some have urged that birds follow river valleys, the lines of old "land bridges" connecting continents, the roll of the waves, and so forth, but the difficulty remains of flight by night and at very great heights. Attractive is the suggestion that birds are guided by what may be called a "tradition" based on experience; those guide well one year who have followed well in previous years. But many young birds fly apart from their parents, and some birds do not fly in flocks at all. Moreover, it is difficult to understand how the experience could be gained except by sight, which in many cases is excluded by the darkness. In face of these difficulties, many authorities, such as Professor Newton, have been led to believe that birds have, in an unusual degree, "a sense of direction."

DEVELOPMENT OF THE CHICK

The ovarian ovum of the hen is a large spherical body, consisting chiefly of yolk, but exhibiting at one region a disc of formative protoplasm with a large nucleus. The ripe ovarian egg is surrounded by a vitelline capsule, mainly due to the follicular theca in which it is formed. There is an innermost non-cellular membrane, then an epithelium, then a connective tissue outer membrane. The ripening of the egg is accompanied by the disappearance of the nuclear membrane, and also by the formation of polar bodies; but the details of the process are obscure.

Either before it leaves the ovary, or in the upper part of the oviduct, the egg is fertilised by a spermatozoon. During its passage down the oviduct it undergoes two sets of changes. On the one hand it is surrounded by various envelopes added to the delicate vitelline membrane

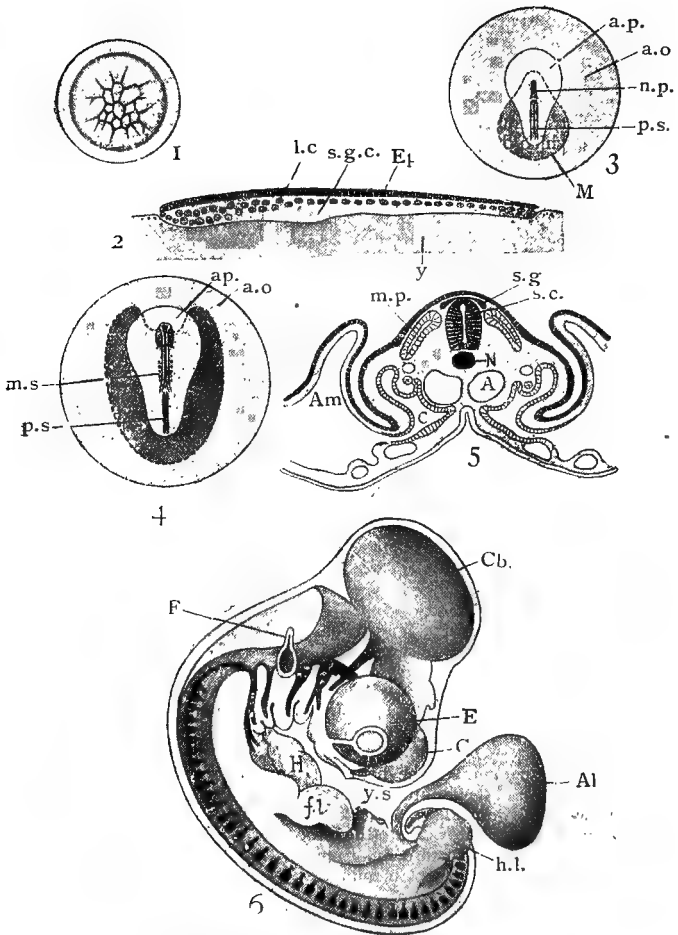

FIG. 378.—Stages in development of chick.—After Marshall.

1. Segmentation, superficial view of blastoderm.
2. Vertical section of blastoderm. *Ep.*, Epiblast; *l.c.*, lower layer of cells; *s.g.c.*, sub-germinal cavity; *y.*, yolk.

with which it is already invested ; on the other hand, segmentation goes on rapidly in the formative area.

The fully formed and laid egg is surrounded by a firm porous shell of carbonate of lime, and beneath this there is a double shell membrane, the two layers of which are separated at the broad end of the shell to form an air-chamber. This chamber grows larger as development proceeds, and is of some importance in connection with respiration, as an intermediate region between the embryo and the external medium. Beneath the shell membranes lies the albumen, or "white of egg," which is secreted by the thin-walled region of the oviduct ; in it lie two spirally-twisted cords or chalazæ, produced by the rotation of the egg in the oviduct. Within the enveloping albumen lies the ovum proper, with its enormous mass of yolk. The yolk is not homogeneous, but consists of two substances, known respectively as white and yellow yolk. The white yolk forms a central flask-shaped mass, and occurs also as thin concentric layers in the yellow yolk.

The minimum temperature at which a hen's egg will develop normally is 28° C. If the temperature fall below this, development stops.

In early stages the interruption may last for days without fatal results, though always with a tendency to induce subsequent abnormalities. Towards the end of incubation more than a day's cooling is usually quite fatal.

On the upper surface of the yolk, in whatever position the egg be held, lies the segmented blastoderm, whose exact origin we must consider more precisely.

As we have seen, yolk is to be regarded as an inert and passive substance. In the hen's egg we have an increased specialisation along the line indicated by the egg of the frog. For there is a small patch of formative protoplasm at one pole, and a large aggregate of yolk composing the remainder of the egg. In consequence, the activity of

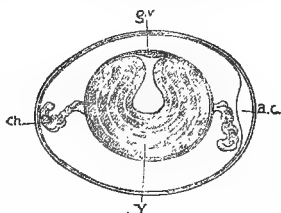

FIG. 379.—Diagrammatic section of egg.—After Allen Thomson.

g.v., Position of germinal vesicle ;
a.c., air-chamber ; *y.*, yolk (alternate layers of "yellow" and "white") ; *ch.*, chalaza.

3. Diagrammatic surface view. *a.p.*, Area pellucida ; *a.o.* area opaca ; *n.p.*, neural groove ; *p.s.*, primitive streak ; *M.*, mesoblast spreading over yolk.
4. Diagrammatic surface view at later stage. *a.p.*, Area pellucida ; *a.o.*, area opaca ; *m.s.*, mesoblast segments ; *p.s.*, primitive streak. The dark border shows the spreading of the mesoblast over the yolk.
5. Cross-section. *s.c.*, Spinal cord ; *s.g.*, rudiment of spinal ganglia ; *N.*, notochord ; *m.p.*, mesoblastic plates ; *A.*, aorta ; *Am.*, amnion fold ; *c.*, coelom or pleuro-peritoneal cavity.
6. Embryo. *Cb.*, Cerebellum ; *F.*, ear ; *H.*, heart ; *fl.*, fore-limb ; *hl.*, hind-limb ; *y.s.*, stalk of cut-off yolk-sac ; *AL.*, allantois ; *E.*, eye ; *C.*, cerebrum. On the dorsal surface the mesoblastic somites are indicated.

the protoplasm is unable to overcome the inertia of the yolk, and segmentation is meroblastic and discoidal (cf. Elasmobranchs).

In the protoplasm of the egg horizontal and vertical furrows appear in rapid succession. The result, as exhibited by vertical sections, is to produce an upper epithelial layer of cells, separated by a small space from larger, more irregular cells, which are still in connection with the yolk on which they lie. At the circular border of the germinal disc the two sets of cells are continuous. According to some authorities, this stage represents the blastula, the upper layer of cells corresponding to the cells of the animal pole in the frog, the lower with the enormous mass of yolk on which they lie to the cells of the vegetative pole, the space to the segmentation cavity.

At the next stage there appears a crescent-shaped groove. In this region there is an ingrowth of cells, which probably represents a modified process of gastrulation, and results in the obliteration of the segmentation cavity, and the formation of a "sub-germinal" cavity or archenteron. The floor of the sub-germinal cavity is formed by the yolk, in which, by a process of supplementary cleavage, yolk-nuclei appear.

This condition is that attained when the egg is laid. On surface view we see a central ill-defined "pellucid area." This, which becomes much more distinct during the early hours of incubation, is the area of the blastoderm which overlies the sub-germinal cavity, and is contrasted with the surrounding "opaque area," which lies directly on the yolk. At the posterior region of the opaque area, as already noted, there is the crescentic groove, where the outer and inner layers are continuous.

After the commencement of incubation, the blastoderm spreads rapidly over the yolk, chiefly by the extension of the area opaca; the area pellucida meanwhile elongates and becomes oval.

Another important change which also occurs in the early hours of incubation is the conversion of the transverse crescentic groove into the longitudinal primitive streak. The precise meaning of this change is difficult and uncertain, but there seems no doubt that the primitive streak represents the anterior lip of the blastopore of the frog. It runs down the centre of the area pellucida and is marked by a central furrow, the primitive groove. At its sides two wings of cells are obvious; these soon spread out laterally and anteriorly, and constitute the mesoblast. All three layers of the embryo are connected at the sides of the primitive streak, as at the margin of the blastopore in the frog.

In the region in front of the primitive streak, a row of hypoblast cells becomes differentiated to form the notochord. At its sides the sheets of mesoblastic cells split into an inner or splanchnic layer, and an outer or somatic layer. A little later the mesoblast divides into the segmentally arranged mesoblastic somites, lying at the sides of the notochord, and the unsegmented lateral plate, whose outer and inner walls form the corresponding boundaries of the coelom.

At the time when the notochord has appeared internally, the external epiblast becomes differentiated to form the medullary groove, which gives rise in the usual way to the medullary canal. The folds at first diverge posteriorly on either side of the primitive streak, but as the union travels backwards, this is included in the medullary canal, and so disappears.

During the course of the second day the embryo seems to sink farther into the yolk, while both anteriorly and posteriorly double folds, known respectively as the head and tail folds, rise up. In the course of their development the embryo becomes completely "folded off" from the yolk. At a slightly later stage, side folds also appear; all the folds now consist of a double layer of somatic mesoderm covered by epiblast. The folds meet above the back of the embryo and coalesce. The inner layer forms the true amnion, the outer the false amnion or subzonal membrane. Into the space between the amniotic folds, a diverticulum from the posterior region of the gut, the allantois, grows out.

Before the end of the first day, blood vessels begin to be developed in the extra-embryonic region of the blastoderm. These form the beginning of the vitelline vessels, which are of great importance in the early stages of development, and have probably at first some respiratory importance. As development proceeds, the allantois increases greatly, and, fusing with the subzonal membrane, approaches close to the egg-shell. It has a large blood supply, and functions as an organ of respiration; in addition it absorbs the white of egg, thus serving as an organ of nutrition; it also receives deposits of urates, thus functioning in connection with excretion.

We have spoken of the "folding off" of the embryo; as a result of this, the embryo is attached by a relatively narrow stalk to the large yolk-sac, over which the blastoderm is now slowly spreading. In this respect the embryo strongly resembles that of the dogfish; it differs from the latter in the presence of the overarching amniotic folds, and in the respiratory allantois, which functionally replaces the protruding gills of the young dogfish. In the young tadpole the yolk lies heaped up on the floor of the gut, and causes a certain amount of distortion. In the chick, as in the embryo dogfish, the amount of yolk is so great that it forms a hernia-like protrusion of the gut, and only at a very late stage is the greatly reduced sac withdrawn into the body cavity, after which the dermal and intestinal umbilical openings are closed.

The chick embryo never exhibits any trace of gills, but the gill-clefts perforate the pharynx. The embryonic organ of respiration is the allantois, but that arrangement of aortic arches by means of which in the tadpole blood is carried to the gills is repeated here.



FIG. 380.—Diagrammatic section of embryo within egg.—After Kennel.

D., Yolk-sac; *d.*, wall of yolk-sac; *da.*, gut of embryo; *al.*, *al'*, inner and outer wall of the allantois; *am.*, amnion proper (the reference line should extend farther inwards); *a.*, within amniotic cavity; *s.*, subzonal membrane; *l* is placed within the extra-embryonic body cavity into which the allantois grows.

About the twentieth day the beak, which has a hard "tooth" on the tip, perforates the membranes of the air-chamber, and the air, rushing in, expands the hitherto functionless lungs. At the same time important changes occur in the circulatory system, "the umbilicus becomes completely closed, the allantois shrivels up, and the chick, piercing the broad end of the shell with repeated blows of its beak, steps out into the world."

CLASSIFICATION OF BIRDS

I. Sub-Class ARCHÆORNITHES or SAURURÆ. Ancient extinct birds, connecting Birds and Reptiles

The oldest known bird is *Archæopteryx*, two specimens of which have been found in the Solenhofen Lithographic Stone (Upper Jurassic) of Bavaria. "The stone is so fine-grained that, besides the bones of the wings, the furculum or merrythought, the pelvis, the legs, and the tail, we have actually casts or impressions on the stone (made when it was as yet only soft mud) of all the feathers of the wings, and of the tail."—Nicholson and Lydekker.

This link between Birds and Reptiles seems to have been a land bird about the size of a crow. The skull is like that of a typical bird. The upper jaw shows thirteen pairs of conical teeth, the lower about three pairs. They are embedded in sockets. Each of the twenty vertebræ of the long tail bears a pair of lateral rectrices—a unique arrangement. There is no pygostyle. The vertebræ seem to have been either amphicelous or with flat ends; the ribs are very slender, without uncinatè processes; there seem to have been "abdominal ribs"; the sternum is not clearly known; there is a U-shaped furcula. The metacarpals seem to have remained separate; the first finger has two phalanges, the second three, the third three or four, and all are clawed. There is a tarso-metatarsus and four toes, as in the pigeon.

II. Sub-Class NEORNITHES

The metacarpals are fused. The second finger is the longest, and the third is reduced. Only in *Opisthocomus* are the three digits of the fore-limb clawed; in most cases claws are confined to the thumbs. Caudal vertebræ are apparently not more than thirteen in number.

1. Division RATITÆ. Running Birds with raft-like unkeeled breast-bone

The African ostrich (*Struthio*) is represented by two or three species, at home in the plains and deserts of Africa, and notable for their size, swiftness of foot, and beauty. There are but two toes, the third and the fourth, with stunted nails. There are no clavicles. The pubes form a ventral symphysis. The enormous size of rectum and cæca is a unique character. The ostrich is polygamous, and at the breeding season the hens lay the eggs, at intervals, in a hollow dug out in the sand by the male. The eggs are incubated by both parents, but especially by the cock.

The American ostrich (*Rhea*) is represented by three species in the S. American Pampas. In the *Rhea* there are three toes, all clawed, and the ischia form a ventral symphysis. There are no clavicles. Only here among *Ratitæ* is there a well-developed syrinx. The cæca are large. The male excavates a shallow nest in the ground, and there, surrounded by a few leaves and grasses, the numerous eggs are usually laid. It seems that the male bird alone hatches the eggs. Single eggs are often laid here and there on the plains, but these are not incubated.

The Emu (*Dromæus*) is represented by two species in Australian deserts and plains. The fore-limb is greatly reduced, the feathers have long aftershafts. Nearly related are the Cassowaries (*Casuarinus*) living in the Austral-Malayan region, eight species in the Papuan Islands, one in N.-E. Australia, and one in Ceram. They live in the forests and scrub. The fore-limb is very small, with the shafts of the wing feathers reduced to spines; the ordinary feathers have long aftershafts. On the top of the skull there is a horny helmet, covering a core of light spongy bone; this protects the bent head as the bird rushes through the scrub. There are three toes, the inner one with a long sharp claw—a formidable weapon. In Emu and Cassowary the clavicles are represented by separate rudiments and the cæca are small.

The Kiwi (*Apteryx*) forms a very distinct genus of *Ratitæ*, represented by four species, restricted to New Zealand. It is not larger than a hen, and has simple hair-like or bristle-like feathers, a long bill and terminal nostrils, a very rudimentary wing and no clavicles, and no distinct tail feathers. There are four clawed toes. The cæca are large. It is a nocturnal bird, swift and noiseless in its movements, feeding in great part on earthworms. The egg is very large for the size of the bird. Among the extinct *Ratitæ* are the gigantic Moas (*Dinornis*), which seem to have been exterminated in New Zealand in comparatively recent times. The fore-limbs were almost completely reduced, the hind-legs were very large, and some forms attained a height of 10 ft. or even more.

Another recently lost order of giant birds is represented by remains of *Æpyornis* found in Madagascar. Some of these indicate birds as large as ostriches, but eggs have been found holding six times as much as that of an ostrich.

We may think of the *Ratitæ*, according to W. K. Parker, as "overgrown, degenerate birds that were once on the right road for becoming flying fowl, but through greediness and idleness never reached the 'goal,'—went back, indeed, and lost their sternal keel, and almost lost their unexercised wings."

2. Division ODONTOLCÆ. Represented by *Hesperornis* from N. American Cretaceous strata, somewhat like a swimming ostrich, with sharp teeth sunk in a groove, with saddle-shaped cervical vertebræ as in modern birds, with a rudimentary fore-limb, but with a powerful swimming leg. In an English representative—*Enaliornis*—the vertebræ are chiefly biconcave. These extinct birds have many *Ratite* skeletal characters, and they have also interesting resemblances to some old-fashioned living *Carinatæ*, notably the divers (*Colymbidæ*).

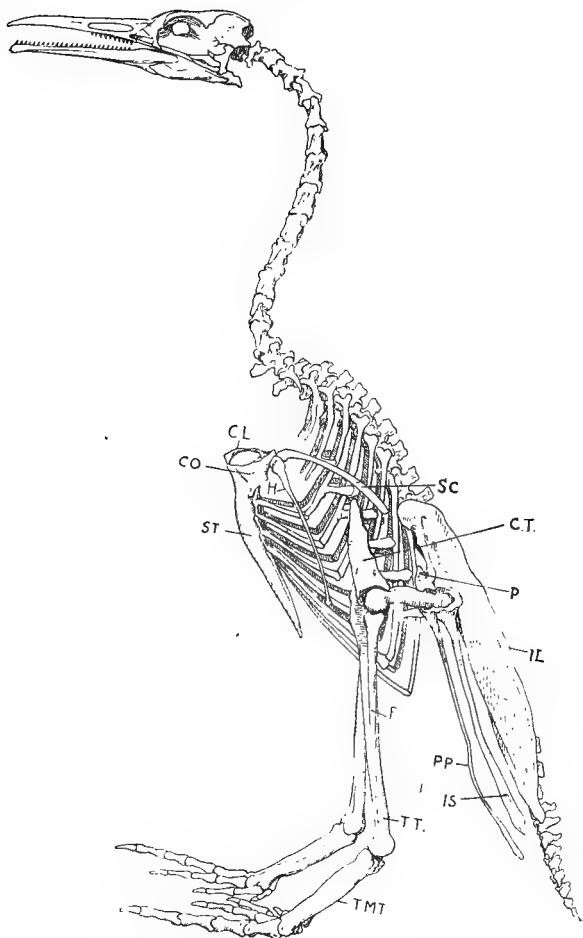

FIG. 381.—*Hesperornis*.—After Marsh.

ST., Sternum; CO., coracoid; CL., clavicle; H., rudimentary humerus; SC., scapula; P., pectineal pubic process; IL., ilium; IS., ischium; P.P., post-pubis; C.T., crest of tibia; F., fibula; T.T., base of tibio-tarsus; T.M.T., tarso-metatarsus.

3. Division CARINATÆ. Flying birds with a keeled breast-bone

Apart from the extinct types of Carinatæ, such as *Ichthyornis* (with teeth and biconcave vertebræ), and the large Tertiary *Odontopteryx*, with tooth-like pegs of bone on its jaws, there seem to be over 11,000 living species. These may be grouped in twenty-one orders, such as Passeres (thrushes, etc.), Accipitres (hawks, etc.), Columbæ (doves), Gallinæ (pheasants, etc.), Gaviæ (gulls, etc.), Psittaci (parrots). Of the twenty-one orders only three are unrepresented in Britain.

The old classification of birds into snatchers, perchers, climbers, scratchers, stilt-walkers, and swimmers was interesting and suggestive, but an arrangement of this sort is bound to be misleading, since birds of very different structure may have very similar habits.

It may be of interest to contrast the two divisions of living birds.

SOME CONTRASTS BETWEEN MODERN RATITÆ AND MODERN CARINATÆ

RATITÆ.	CARINATÆ.
<p>Running Birds, with wings more or less degenerate and unused in flight, with a keelless raft-like breast-bone.</p>	<p>Flying Birds, with wings almost always well exercised in flight, with a keeled breast-bone.</p>
<p>The skull is dromæognathous, <i>i.e.</i> the vomer is interposed between the palatines, the pterygoids, and the basisphenoidal rostrum.</p>	<p>(The keel is rudimentary in the New Zealand parrot <i>Stringops</i>, in the exterminated Dodo (<i>Didus</i>), and in the extinct <i>Aptornis</i>—one of the rails. The penguins do not fly at all; the Tinamou, the Hoatzin, and some other birds, fly very little.)</p>
<p>The sutures in the skull remain for a long time distinct. The quadrate articulates with the skull by a single head.</p>	<p>Except in the Tinamou, the skull is never dromæognathous, <i>i.e.</i> the vomer is not fused with the neighbouring bones of the palate, and the palatines articulate with the basisphenoidal rostrum.</p>
<p>The long axes of the adjacent portions of the scapula and coracoid lie almost in the same line, or form a very obtuse angle, and the two bones are fused.</p>	<p>The sutures in the skull almost always disappear very early. The quadrate articulates by a double head.</p>
<p>The clavicles are small or absent.</p>	<p>The scapula and coracoid meet almost at right angles, and are connected with one another by ligament only.</p>
<p>The ilium and ischium are not united behind, except in old Rheas and Emus. No pygostyle.</p>	<p>The clavicles are in most cases very well developed.</p>
<p>The feathers of the adult have free barbs, the barbules have no hooks. There is no oil gland, except in the kiwi. There are no regularly arranged pteryliæ.</p>	<p>The ilium and ischium unite, enclosing a sciatic foramen. Usually a pygostyle.</p>
<p>The male has a penis.</p>	<p>The barbs of the feathers are generally united, the barbules have hooks. There is usually an oil gland.</p>
<p>The young are always præcoces.</p>	<p>The male has rarely a penis. The young may be præcoces or altrices.</p>

Pedigree.—Birds have many structural affinities with Reptiles; some of the ancient Dinosaurs present approximations to Birds; the extinct flying Pterodactyls show that it was possible for flight to be developed among Reptiles; the oldest bird—*Archæopteryx*—is in many ways a connecting link between the two classes; and the development of some Birds reveals many remarkable resemblances with that of Reptiles,—therefore, with the strength of the general argument for evolution to corroborate us, we conclude that Birds evolved from a Reptile stock.

It is likely, then, that Birds arose from an ancient Saurian stock, but by what steps and under what impulses we do not know. To some it seems enough to say that the evolution was accomplished gradually in the course of natural selection by the fostering of fit variations and the elimination of the disadvantageous; to others it seems that the incipient birds were “*fevered* representatives of reptiles, progressing in the direction of greater and greater constitutional activity”; but both these suggestions leave much in the dark, leave us still to “wonder how the slow, cold-blooded, scaly beast ever became transformed into the quick, hot-blooded, feathered bird, the joy of creation.”

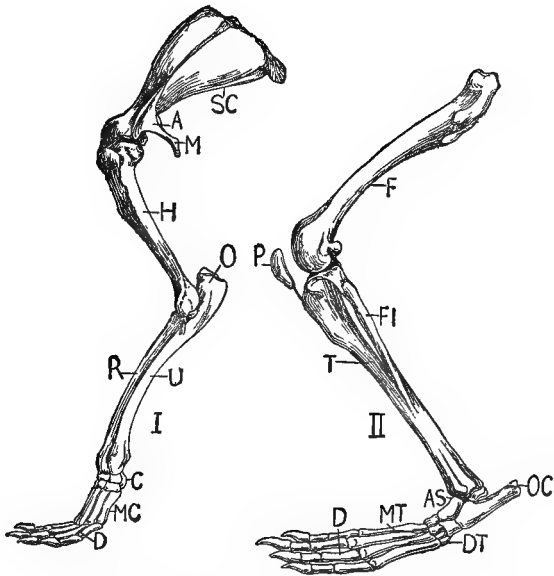

FIG. 381A.—Fore-limb and shoulder-girdle (I.) and hind-limb (II.) of rabbit.

SC., Scapula; *A.*, acromion; *M.*, metacromion process; *H.*, humerus; *O.*, olecranon process; *U.*, ulna; *R.*, radius; *C.*, carpals; *MC.*, metacarpals; *D.*, five digits; *F.*, femur; *P.*, patella; *FI.*, fibula; *T.*, tibia; *OC.*, os calcis; *AS.*, astragalus; *DT.*, distal tarsals; *MT.*, metatarsals; *D.*, four digits.

CHAPTER XXVI

CLASS MAMMALIA

1. PROTOTHERIA; 2. METATHERIA; 3. EUTHERIA

BIRDS and Mammals have evolved along very different lines, Birds possessing the air and Mammals the earth, and it is difficult to say that either class is the higher. But apart from the fact, which prejudices us, that man himself is zoologically included among Mammals, this class is superior to Birds in two ways—in brain development, and in the relation between mother and offspring. In most Mammals there is a prolonged organic connection between the mother and the unborn young, which may have been, as Robert Chambers suggested, one of the conditions of progress. It is also characteristic of Mammals that the young are nourished after birth by their mother's milk, and it has been suggested that the usually prolonged infancy was one of the factors in the evolution of the humaner feelings. It is certain at least that the carefulness and sacrifice of the mothers has been one factor in the survival and success of Mammals, and we may find in the term *Mammalia*, which Linnæus first applied to the class, a hint of the idea that in the evolution of this class the mothers led the way.

GENERAL SURVEY OF MAMMALS

There are three grades of Mammalian evolution:—

A. The duckmole (*Ornithorhynchus*) and the spiny ant-eaters (*Echidna* and *Proechidna*) differ very markedly from all other Mammals. The young are hatched outside

of the body; in other words, the mothers are oviparous. The brain is poorly developed when compared with that of other Mammals. Some of the characteristics of the skeleton, etc., suggest Reptilian affinities. To this small sub-class the titles Prototheria, Ornithodelphia, and Monotremata are applied.

B. The kangaroos and bandicoots, phalangers and opossums, and the like, form the second sub-class. In these the young are born prematurely after a short gestation, during which the organic connection between the mother and the young is comparatively slight. Most female Marsupials have an external pouch or marsupium, to which the tender young are transferred, and within which they are nourished and protected for some time. Moreover, the brains even of the most intelligent Marsupials are not so well developed as those of higher Mammals. To this heterogeneous sub-class the titles Metatheria, Didelphia, and Marsupialia are applied.

C. In all the other Mammals there is a well-developed allantoic placenta uniting the unborn young to the mother, while in Marsupials this is only known in *Perameles*, where it is of relatively little importance. It is among these placental Mammals that the brain begins to be much convoluted,—as it were, wrinkled with thought. To this sub-class the titles Eutheria, Placentalia, and Monodelphia are applied.

Among the extant orders of placental Mammals the Edentata and the archaic Sirenia stand very much apart. The rest may be provisionally grouped in three sets, perhaps representing three main lines of evolution.

On one side we place the great series of hoofed animals or Ungulates, including—(*a*) those with an even number of toes (Artiodactyla), such as pigs, hippopotamus, camels, cattle, and deer; (*b*) those with an odd number of toes (Perissodactyla), such as tapir, rhinoceros, and horse; (*c*) the elephants (Proboscidea); (*d*) the Hyraxes (Hyracoidea). And not far from the Ungulates it seems legitimate to rank (*a*) the whales and dolphins (Cetacea), and (*b*) the rabbits and hares, rats and mice, etc. (Rodentia).

On the other side we place the great series of Carnivora, such as cats, dogs, bears, and seals. Beside these may be ranked the Insectivora, such as hedgehog, mole, and shrew, and the bats or Chiroptera, which seem to be specialised Insectivores.

In the middle we place the series which, beginning with the Lemurs, leads through various grades of monkeys to a climax in man.

But it must be carefully noted that these orders are often linked by extinct types. Thus, to take one instance only, it is believed by some that the extinct *Phenacodus* has affinities with Ungulates, Carnivores, and Lemurs.

GENERAL CHARACTERS OF MAMMALS

All Mammals are quadrupeds, except the Cetaceans and Sirenians, in which the hind-limbs have disappeared, leaving at most internal vestiges. There is generally a distinct neck between the head and the trunk, and the vertebral column is, in most cases, prolonged into a tail.

Hairs are never entirely absent. In most they form a thick covering, but they are scanty in Sirenians and in the hippopotamus, and almost absent in Cetaceans, in which they are sometimes restricted to early stages in life. The skin has abundant sebaceous and sudorific glands. In the female, milk-giving or mammary glands develop as specialisations of sebaceous glands, except in Monotremes, where they are nearer the sudorific type.

A complete muscular partition or diaphragm separates the chest cavity, containing the heart and lungs, from the abdominal cavity, and is of great importance in respiration.

The vertebræ and long bones have terminal ossifications or epiphyses, absent or very rudimentary, however, in the vertebræ of Monotremes and Sirenia. The centra of the vertebræ have generally flat or slightly rounded faces, and there are usually seven cervical vertebræ.¹

The bones of the skull are firmly united by sutures, which generally persist. Only the lower jaw, the ear ossicles, and the hyoid are movable. There are two occipital condyles, as in Amphibians.² The lower jaw on each side consists, in adult life, of a single bone which works on the squamosal; the

¹ In the Manatee there are, however, only six; the pangolin *Manis* has sometimes eight; and it is often said that the two-toed sloth (*Cholæpus hoffmanni*) has only six, and the three-toed sloth (*Bradypus tridactylus*) nine; but in the case of the sloths there is apparently considerable variation. It will be noticed that these deviations from type occur only in the case of the two most old-fashioned orders of Eutherian Mammals.

² It may be noted, however, that for various reasons, e.g. that some Birds and Reptiles are not very clearly single-condyled, morphologists no longer attach so much importance to this character as they once did.

quadrate which intervenes in *Sauropsida* has disappeared, or has been shunted to become one of the ear ossicles. For it is a plausible theory of the three ossicles—malleus, incus, and stapes—which connect the drum with the inner ear, that they correspond respectively to the articular, quadrate, and columella or hyo-mandibular of other *Vertebrates*.¹ The otic bones fuse with each other to form a compact periotic. A bony palate, formed from premaxillæ, maxillæ, and palatines, separates the buccal cavity from the nasal passages. In most cases there are teeth, borne in sockets by the premaxillæ, maxillæ, and mandible.

Except in *Monotremes*, the coracoid is represented by a small process from the scapula, and sometimes by a small ossification, forming part of the glenoid cavity in which the head of the humerus works. The sternum includes—(a) a præsternum, with which the clavicles (if well developed) articulate; (b) a mesosternum divided into segments, with which the sternal parts of the ribs articulate; and (c) a xiphisternum, often cartilaginous. There are generally two sacral vertebræ, but several caudals, and more rarely a lumbar, may be fused to these. The ilio-sacral articulation is in front of the acetabulum. The ventral symphysis is usually restricted to the pubes, but in some *Insectivores* and *Bats* these do not meet. Except in *Echidna*, the acetabulum is completely ossified, and there is often a special acetabular bone. The ankle joint is *cruro-tarsal*.

The cerebral hemispheres have usually a convoluted surface, and always cover the optic thalami and the optic lobes (now fourfold *corpora quadrigemina*), and in higher forms the cerebellum as well. The commissural system is well developed, being especially represented by a large *corpus callosum*, except in *Monotremes* and *Marsupials*, in which the anterior commissure is large and the *corpus callosum* absent or very small. There is also an important set of longitudinal fibres called the *fornix*.

Except in *Monotremes*, in which there is a cloaca, the food canal ends separately from the urogenital aperture.

The heart is four-chambered, and the temperature of the blood is high, though lower than that of *Birds*. There is but

¹ There are many other theories as to the quadrate, e.g. that it forms the malleus.

one aortic trunk, which curves over the left bronchus. The red blood corpuscles are, when fully formed, non-nucleated, and appear as slightly biconcave discs, circular in outline, except in the Camelidæ, where they are elliptical. There is no renal-portal system.

Mammals are warm-blooded or stenothermal, i.e. their body-temperature does not change with that of the surrounding medium. In this they agree with Birds, and differ from other Vertebrates, which are cold-blooded or poikilothermal.

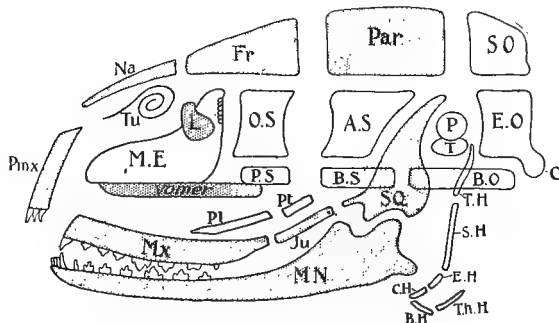

FIG. 382.—Diagram of skull bones (partly after Flower and Weber), the membrane bones shaded.

BO., Basioccipital; EO., exoccipital; C., condyle; SO., supraoccipital; Par., parietal; Fr., frontal; Na., nasal; Pmx., premaxilla; ME., mesethmoid; L., lachrymal; Tu., turbinal; PS., presphenoid; OS., orbitosphenoid; AS., alisphenoid; BS., basisphenoid; SQ., squamosal; P., periotic; T., tympanic; Pl., palatine; Pt., pterygoid; Mx., maxilla; Ju., jugal; T.H., thyro-hyal; S.H., stylo-hyal; E.H., epi-hyal; C.H., cerato-hyal; B.H., basi-hyal; Th.H., thyro-hyal.

The lungs are invested by pleural sacs, and lie freely in the chest cavity. Within the lungs the bronchial tubes fork repeatedly into finer and finer branches. At the top of the trachea there is a complex larynx with the vocal chords.

The kidneys are generally compact and rounded bodies; the ureters open into the bladder, except in Monotremes, in which they enter a urogenital sinus. Except in Monotremes, the outlet or urethra of the bladder unites in the male with the genital duct, to form a urogenital canal; in the female,

except in *Monotremes* and a few other cases, the urethra and the genital duct open into a common vestibule.

In the more primitive *Mammals* the testes lie in the abdomen; in the majority they descend permanently (or in a few cases temporarily) into a single or paired scrotal sac, lying, except in *Marsupials*, behind the penis.

The ovaries are small. Except in *Monotremes*, the genital ducts of the female are differentiated into—(a) Fallopian tubes, which catch the ova as they burst from the ovaries; (b) a uterine portion in which the young develop; and (c) a vaginal portion ending in the urogenital aperture. In *Monotremes* the two ducts are simple, and open separately into the cloaca; in *Marsupials* there are two uteri and two vaginæ; in *Eutherian Mammals* the uterine regions are more or less united, and the vaginal regions are always completely fused.

In *Monotremes* the eggs are large and rich in yolk; in all others they are small and almost yolkless. In the ovary each ovum lies embedded in a nest of cells, within a swelling or Graafian follicle, which eventually bursts and liberates the egg-cell. In *Monotremes* the segmentation, as might be expected, is meroblastic; in other cases it is holoblastic. As in *Sauropsida*, there are two fœtal membranes—the amnion and the allantois, both of which share in forming the placenta of the Placental *Mammals*. In *Marsupials* the allantois is usually small and degenerate.

The *Monotremes* are oviparous; the *Marsupials* bring forth their young prematurely after a short gestation, but a true allantoic placenta may be represented, as in *Perameles*; the *Eutherian Mammals* have a longer gestation, during which the young are vitally connected to the wall of the uterus by means of the placenta, which is always well developed, and of great importance in the nutrition of the embryo.

In all *Mammals* the young are for a longer or shorter period dependent upon the milk secreted by the mammary glands of the mother; in *Marsupials* this dependence is especially marked.

THE RABBIT AS A TYPE OF MAMMALS

The rabbit (*Lepus cuniculus*) is a familiar representative of the Rodent order, to which rats and mice, voles and beavers,

lemmings and marmots, also belong. Like the hare (*Lepus timidus*) and other species of the same genus, and like the Picas or tailless hares (*Lagomys*), the rabbit has two pairs of incisors in the upper jaw, while other Rodents have a single pair. Therefore the genera *Lepus* and *Lagomys* are sometimes ranked as Duplicidentata, in contrast to all other Rodents (Simplicidentata).

With the rabbit's mode of life all are familiar. It is herbivorous, and often leaves softer food for the succulent bark of young trees; it is gregarious and a burrower; it is very prolific, frequently breeding four times in a year. It is said to live, in normal conditions, seven or eight years. The rabbit seems to have had its original home in the western Mediterranean region, but it has spread widely throughout Europe, and is now abundant in regions, such as the Highlands of Scotland, in which, a few generations ago, it was rare. Introduced into Australia and New Zealand, it has multiplied exceedingly, and has become a scourge. There are many varieties of rabbit, some in isolated regions perhaps illustrating the effect of segregation in fostering divergent types. According to Darwin, the rabbits introduced early in the fifteenth century into Porto Santo, an island near Madeira, are now represented by a dwarf race of about half the normal size, and these are said to be incapable of breeding with the ordinary forms. But the varieties with which we are familiar in the breeds of tame rabbits illustrate variation under domestication and the efficacy of artificial selection.

External appearance.—The head bears long external ears, which are freely movable. The black patch at the tip of the ears in the hare is either absent or very small in the wild rabbit. This external ear is characteristic of most Mammals, and collects the sound like an ear-trumpet. In the rabbit it is longitudinally folded, thin and soft towards its tip, firm and cartilaginous at its base. The eyes have two eyelids with few eyelashes, and a third eyelid or nictitating membrane—a white fold of skin—in the anterior upper corner. This third eyelid, which also occurs in Reptiles and Birds, is present in most Mammals, and is of use in cleaning the cornea. It is absent in Cetaceans, where the front of the eye is bathed by the water, and it is rudimentary in man and monkeys, where its absence is compensated for

by the habitual winking of the upper eyelid. The nostrils are two slits at the end of the snout, and are connected with the mouth by a "hare-lip" cleft in the middle of the upper lip. In front of the mouth are seen the chisel-edged incisors, a pair on the mandibles, and two pairs on the premaxillæ—the smaller pair hidden behind the larger pair. The first milk incisors above and below never cut the gum, but are absorbed before birth; the second milk incisors above (there are none below) are functional, but are shed about the third week of extra-uterine life; the same is true of the milk premolars. Into the toothless gap or diastema between the front and back teeth the hairy skin of the lips projects into the mouth. This generally occurs in Rodents, and is said to prevent the inedible substances which they gnaw from passing backwards to the gullet. On the sides of the snout, and about the eyes, there are tactile hairs or vibrissæ.

The plump trunk is separated from the head by a short neck. The tail is very short, but in the scampering wild rabbit it is conspicuous as a white tuft, which some naturalists interpret as a directive signal. Beneath the base of the tail the food canal ends, and beside the anus are the openings of the perineal glands, whose secretion has a characteristic odour. In front of the anus is the urogenital aperture,—in the male at the end of an ensheathed penis, in the female a slit or vulva, with an anterior process or clitoris—the homologue of the penis. Beside the penis in the male lie the scrotal sacs, into which the testes descend when the rabbit becomes sexually mature. Along the ventral surface of the thorax and abdomen in the female there are four or five pairs of small teats or mammæ.

The limbs have clawed digits, five on the fore-feet, four on the hind-feet; they are very hairy.

Skin and muscles.—The skin is thickly covered with hair, and has the usual sebaceous and sudorific glands, besides special glands, such as the perineal glands beside the anus, the glands of the eyelids, the lachrymal glands, and the mammary glands developed in the females. Between the skin and the subjacent muscles there is a layer of fatty tissue, known as the panniculus adiposus; it is usually present in Mammals, but absent in the common

hare; it forms the blubber of whales. Beneath the skin is a thin sheet of muscle (the panniculus carnosus), by means of which the skin can be twitched, as in horses, etc., and when this is removed with the skin, many of the muscles of head and neck, limbs and trunk, are disclosed (see Parker's *Zootomy*).

Skeleton.—The bones, like those of other Vertebrates, are developed either as replacements of pre-existent cartilages, or independent of any such preformations, but in all cases through the agency of active periosteal membranes. By themselves, however, must be ranked little sesamoid bones, which are developed within tendons and near joints, notably, for instance, the patella or knee-pan. There is no bony exoskeleton in any mammals except the armadillos, unless we rank the teeth, which develop in connection with the skin of the jaws, as in a sense exoskeletal.

The vertebræ may be grouped in five sets:—cervical (seven in number), thoracic (with well-developed] ribs), lumbar (without ribs), sacral (fused to support the pelvis), and caudal. The faces of the centra are more or less flat, and between adjacent vertebræ there are intervertebral discs of fibro-cartilage. A vestige of the notochord is found in Mammals in the gelatinous nucleus pulposus in the centre of the intervertebral discs.

The first vertebra or atlas is ring-like, its neural canal being very large, its centrum unrepresented except by the odontoid process, which fuses to the second vertebra. The ring is divided transversely by a ligament, through the upper part the spinal cord passes, into the lower the odontoid process projects. The transverse processes are very broad; the articular surfaces for the two condyles of the skull are large and deep.

The second vertebra or axis has a broad flat centrum produced in front in the odontoid process. The neural spine forms a prominent crest, the transverse processes are small, the anterior articular surfaces are large.

A typical lumbar vertebra will show the centrum and its epiphyses, the neural arch and neural spine, the transverse processes, the anterior and posterior articular processes or zygapophyses, the median ventral hypapophysis, the small anapophyses from the neural arch below the posterior

zygapophyses, below the anapophyses the posterior intervertebral notches—passages through which the spinal nerves pass out, and anteriorly a similar pair of notches. There are twelve or thirteen pairs of ribs which support the wall of the thorax and aid in the mechanism of respiration. The first seven pairs articulate with the breast-bone, the eighth and ninth are connected to the ribs in front, the others are free. Any one of the first seven or more typical ribs consists of two parts, a vertebral portion articulating with a vertebra, an imperfectly ossified sternal portion connecting the end of

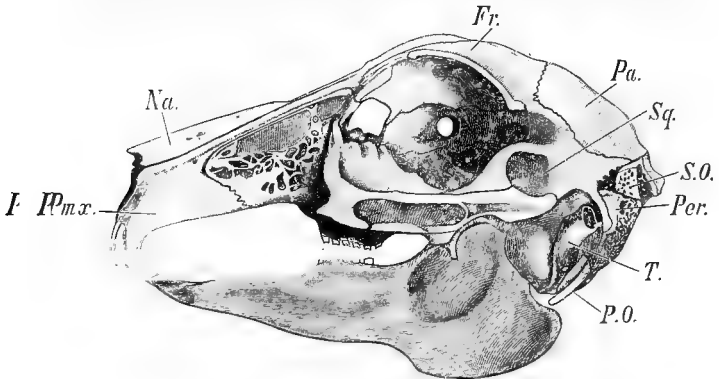

FIG. 383.—Side view of rabbit's skull.

Pmx., Premaxilla; *Na.*, nasal; *Fr.*, frontal; *Pa.*, parietal; *Sq.*, squamo-al; *S.O.*, supraoccipital; *Per.*, petriotic; *T.*, tympanic (the reference line points to the bony external auditory meatus, beneath it lies the inflated bulla); *P.O.*, paroccipital process.

the vertebral portion with the sternum. Each of the first nine ribs has a double head—the capitulum articulating with the centrum of the corresponding vertebra, and partly with that of the one in front, the tubercle articulating with the transverse process of the corresponding vertebra. The posterior ribs have no tubercles, and the capitular articulations are restricted to the corresponding vertebræ.

The sternum is a narrow jointed plate, with a large keeled præsternum or manubrium, then five segments composing the mesosternum, then a posterior xiphisternum ending in cartilage.

The *skull* consists, as in all the higher Vertebrates, of two sets of bones,—cartilage bones preformed in the cartilage of the original gristly brain-box and its associated arches, and membrane bones developing in the investing membrane and not preformed in cartilage. (The names of the membrane bones are printed in italics.)

We have already noticed the chief characteristics of the mammalian skull, such as the usual persistence of sutures,

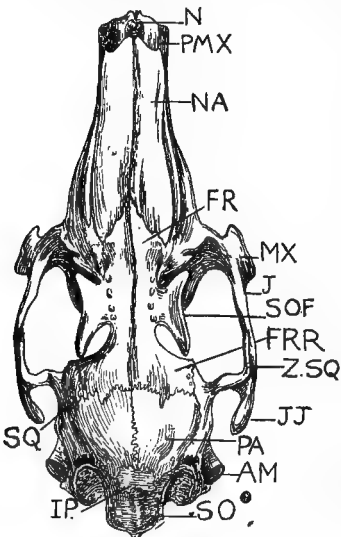

FIG. 384.—Upper surface of rabbit's skull.

N., Anterior nostril; *PMX.*, premaxilla; *NA.*, nasal; *FR.*, anterior part of frontal; *MX.*, posterior part of maxilla; *J.*, anterior part of jugal; *SOF.*, supraorbital process of frontal; *FRR.*, posterior part of frontal; *JJ.*, posterior end of jugal protruding below zygomatic portion of squamosal (*Z.SQ.*); *PA.*, parietal; *AM.*, external auditory meatus; *SO.*, supraoccipital; *IP.*, interparietal; *SQ.*, squamosal.

the two condyles, the bony palate, the fusion of the periotic bones, the articulation of the mandible with the squamosal, the fusion of the parts of each ramus of the mandible into a single bone in the adult, and the three ossicles of the ear.

The foramen magnum is bounded by the basioccipital beneath, the exoccipitals on the sides, the supraoccipital above. The exoccipitals form most of the occipital condyles, but the basioccipital contributes a small part. In many Mammals the exoccipitals alone form the condyles. From each exoccipital a paroccipital process descends, and is applied to the tympanic bulla—a dilatation at the base of the *tympanic* bone which protects the external auditory tube.

Along the roof of the skull lie the supraoccipital, the *interparietal*, the *parietals*, the *frontals*, and the *nasals*.

On the very front of the skull are the *premaxillæ*, bearing the incisor teeth. Behind each *premaxilla* is a *maxilla*, bearing the premolars and molars; behind this, along the zygomatic or temporal arch projecting beneath the orbit, is the *jugal* or *malar*, which unites posteriorly with the *squamosal*. This zygomatic arch bridges over the deep temporal fossa behind the orbit, and serves for the insertion of muscles, and its "squamoso-maxillary" structure occurs outside of Mammalia in the

Anomodont reptiles only. The fact that in Rodents the *malar* does not form part of the face is of considerable systematic importance. The *squamosals* form a great part of the posterior side walls of the skull, and articulate with the *parietals*, *frontals*, orbitosphenoids, and alisphenoids. At the posterior end of the zygomatic arch is the longitudinally elongated glenoid fossa in which the mandible moves backwards and forwards.

In connection with the floor of the skull and the roof of the mouth, there lie from behind forwards the following components:—The median basioccipital; the median basisphenoid, which lodges the pituitary body in a dorsal depression called the sella turcica; the paired alisphenoids fused to the sides of the basisphenoid; the median presphenoid, which forms the lower margin of the optic foramen between the two orbits; the paired orbitosphenoids, fused to the presphenoid, sutured to the alisphenoids and *squamosals*, and surrounding the optic foramen; the vertical *pterygoids* attached at the junction of basisphenoid and alisphenoids; the partly vertical *palatines*, united above to the presphenoid and behind to the *pterygoids* and alisphenoids, separating the posterior nasal passages from the orbits, and uniting to a slight extent in front to form the posterior part of the bony palate; the median vertical mesethmoid cartilage extending in front of the presphenoid, separating the two nasal cavities, posteriorly ossified and expanded into the sieve-like cribriform plates through the apertures of which the branches of the olfactory nerves pass to the nose; the paired *vomers* along the ventral edge of the mesethmoid; and lastly, the anterior bony palate (formed from inward extensions of *maxillæ* and *premaxillæ*), which in the rabbit is very incomplete.

Wedged in between the occipitals, the *squamosals*, and the bones of the basisphenoid region, there is on each side a periotic bone surround-

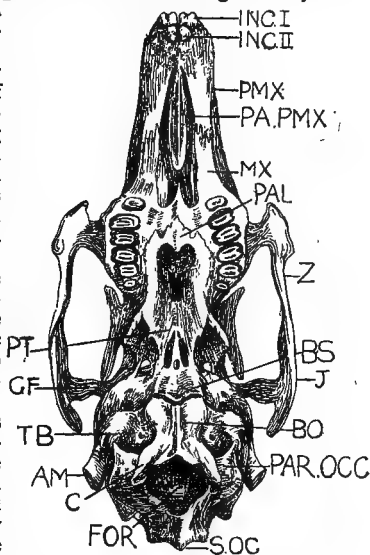

FIG. 385.—Under surface of rabbit's skull.

Inc. I., First incisors; *Inc. II.*, second incisors; *PMX.*, premaxilla; *PA.PMX.*, palatal process of premaxilla; *MX.*, maxilla; *PAL.*, palatine; *Z.*, zygomatic arch; *BS.*, basisphenoid; *J.*, posterior part of jugal; *BO.*, basioccipital; *PAR.OCC.*, paroccipital process of exoccipital; *SOC.*, supraoccipital; *C.*, one of the condyles; *AM.*, external auditory meatus; *TB.*, tympanic bulla; *GF.*, glenoid fossa; *PT.*, pterygoid.

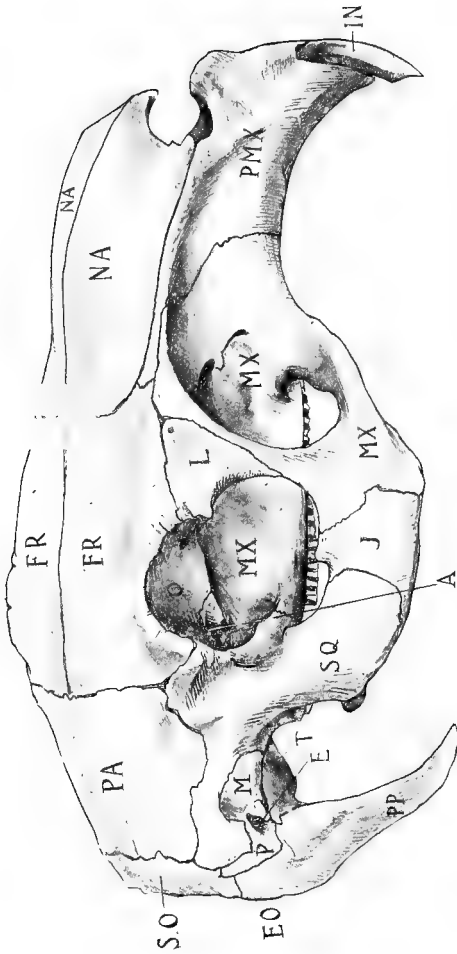

FIG. 386.—Skull of capybara.

S.O., Supraoccipital; PA., parietal; FR., frontal; NA., nasal; IN., incisor; PMX., premaxilla; MX., maxilla; L., lachrymal; J., jugal; A., alisphenoid; SQ., squamosal; T., tympanic; M., mastoid portion of petriotic; P., petriotic; E., ear opening; P.P., paroccipital process; EO., exoccipital.

ing the internal ear. It ossifies from three centres in the cartilaginous auditory capsule, and consists of a dense petrous portion enclosing the essential part of the ear and a more external porous mastoid portion which is produced downwards into a mastoid process in front of the paroccipital process. From each petiotic a *tympanic* bone extends outwards, swollen basally into a tympanic bulla in which the tympanum or drum of the ear is stretched, and continued around the external auditory meatus. From an aperture between the *tympanic* and the petiotic the Eustachian tube passes to the pharynx. Stretching from the tympanum to the fenestra ovalis of the inner ear is the chain of minute ear ossicles, the three links of which—malleus, incus, and stapes—possibly correspond respectively to the articular, the quadrate, and hyo-mandibular or columella of most other Vertebrates.

The orbits are bounded anteriorly by the *lacrimal*s and the *maxilla*, and above by the *frontals*. The interorbital septum is formed above and behind by the orbito-sphenoids, below by the presphenoid.

Associated with the olfactory chambers are the *nasals* above, the *vomers* beneath, the mesethmoid in the median line, while internally there are several thin scroll-like turbinal bones. As special characters of the skull should be noted the incomplete ossification of certain of the bones, *e.g.* of the *maxilla*, and the development of slender rod-like processes from some of them, *e.g.* the *squamosal*, which help to keep the parts of the skull firmly connected.

The lower jaw or *mandible* consists in adult life of a single bone or ramus on each side, but this is formed around Meckel's cartilage from several centres of ossification. Its condyle works on the *squamosal*.

The hyoid lies between the rami of the *mandible*, in the back of the mouth, and consists of a median "body," and two pairs of horns or cornua extending backwards.

The appendicular skeleton consists of the bones of the limbs and the girdles.

The pectoral girdle, which supports the fore-limbs, and is itself attached by muscles and ligaments to the vertebral column, virtually consists of one bone—the scapula—on each side. For in all Mammals, except Monotremes, the coracoid is vestigial. It is represented by an "epicoracoid" process overhanging the edge of the glenoid cavity in which the head of the humerus works, and there is also in some cases a small independent ossification (coracoid or metacoracoid) on the ventral surface of the glenoid cavity. The clavicle is much reduced in the rabbit, being only about an inch in length and very slender. The triangular scapula has a prominent external ridge or spine, continued ventrally into an acromion with a long metacromion process. The scapula is usually strong and the clavicle is

as a rule present in Mammals which grasp or climb or burrow.

The fore-limb consists of an upper arm or humerus, a forearm of two bones—the radius and the ulna, a wrist or carpus, five palm-bones or metacarpals, and five digits with joints or phalanges.

The head of the humerus works in the glenoid cavity formed by the scapula.

When the arm of a mammal is directed outwards at right angles to the body, with the palm vertical and the thumb uppermost, the thumb and the radius are in a preaxial position, the little finger and the ulna are in a postaxial position. But in the normal position of the limb in most mammals, the radius and the ulna cross one another in the forearm, so that the preaxial radius is external at the upper end, internal at the lower end. The hand is borne by the expanded end of the radius.

The typical mammalian wrist or carpus consists of two rows of bones with a central bone between the two rows. In the rabbit all the bones—nine in number—are present, viz. :—

FIRST	} Ulnare or Cuneiform.	Intermedium or Lunar.		} Radiale or Scaphoid.
ROW		Centrale.		
SECOND	} Carpale 5 and 4 or Unciform.	Carpale 3	Carpale 2	} Carpale 1 or Trapezium
ROW		Os magnum.	Trapezoid.	

In Mammals the fourth and fifth carpals are never represented by two distinct bones; the centrale is often absent. In the tendons of the flexor muscles there are often two sesamoid bones, of which the ulnar is called the pisiform.

In the rabbit there are five metacarpal bones and five digits, each with three phalanges, except the thumb or pollex, which has but two.

The pelvic girdle is articulated to the backbone, and bears externally a cup-like socket or acetabulum in which the head of the thigh-bone works. Each half of the girdle—forming what is called the innominate bone—really consists of three bones, which meet in the acetabulum. The dorsal bone or ilium, which corresponds to the scapula, articulates with the sacral vertebræ; the pubis—the anterior of the two lower bones—unites with its fellow on the opposite side in the pubic symphysis; the two ischia, which correspond to the coracoids, extend backwards, separated from the pubes by the large obturator foramen,

and expand into posterior tuberosities. The ischia of Mammals may touch one another ventrally, but do not fuse in a symphysis; the pubic symphysis is almost invariably present. Only in Cetacea and Sirenia is the pelvis markedly rudimentary.

The hind-leg consists of a thigh or femur, a lower leg with two bones—the tibia and the fibula, an ankle or tarsus, the sole-bones or metatarsals, the toes with several joints or phalanges.

The head of the femur works in the acetabulum of the pelvis. Near the head are several processes or trochanters, serving for the insertion of muscles; in the rabbit there are three—the great trochanter, the lesser trochanter, and the third trochanter.

In front of the knee there is a sesamoid bone—the knee-pan or patella—and posteriorly there are smaller fabellæ.

In the lower leg, the tibia, which corresponds to the radius, is pre-axial, and in the normal position interior; the fibula, which corresponds to the ulna, is postaxial, and in the normal position exterior. There is no crossing of bones as in the forearm. In the rabbit the fibula is slender, and is fused distally with the tibia.

In the mammalian tarsus there are two rows of bones, and a central bone interposed between the two rows on the inner or tibial side.

FIRST ROW	}	Calcaneum or Fibulare.		}	Astragalus or Tibiale. Centrale or Navicular.
SECOND ROW	}	Tarsalia 5 and 4 = Cuboid.	Tarsale 3 or External Cuneiform.	}	Tarsale 2 or Middle Cuneiform.
					Tarsale 1 or Internal Cuneiform.

In the rabbit the first cuneiform and the corresponding hallux are wanting. There are thus only four metatarsals and digits. Each digit has three phalanges, and ends in a claw.

Nervous system.—The brain has the usual five parts—cerebral hemispheres, optic thalami, optic lobes, cerebellum, and medulla oblongata, but the cerebral hemispheres cover the next two parts, and the cerebellum conceals the medulla. Of the brain membranes, the dura mater lines the cranial cavity, projecting longitudinally between the cerebral hemispheres, and transversely between the latter and the cerebellum, while the vascular pia mater invests the brain closely. There are the usual twelve pairs of cranial nerves. The spinal cord gives off the usual spinal nerves,

and there is a sympathetic system as in most other Vertebrates.

The cerebral hemispheres of the rabbit are very slightly convoluted, and they leave the cerebellum quite uncovered. They are connected

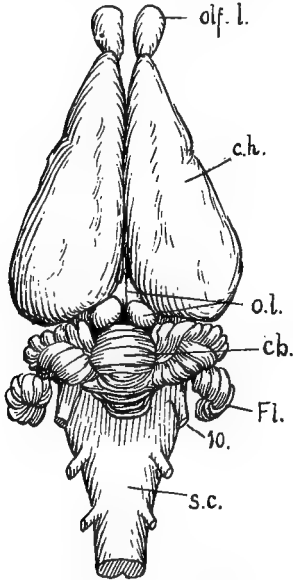

FIG. 387.—Dorsal view of rabbit's brain.

olf. l., Olfactory lobes; *c. h.*, cerebral h. mispheres; *o. l.*, optic lobes (corpora quadrigemina); *cb.*, median part of cerebellum; *Fl.*, flocculus of cerebellum; *10.*, root of the tenth or vagus nerve; *s. c.*, spinal cord.

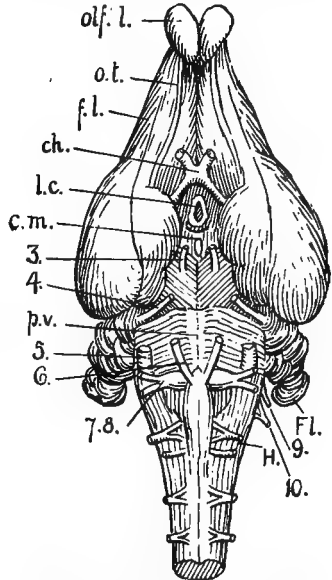

FIG. 388.—Under surface of rabbit's brain.—After Krause.

olf. l., Olfactory lobes; *o. t.*, olfactory tract; *f. l.*, frontal lobe of cerebral hemisphere; *ch.*, optic chiasma; *l. c.*, infundibulum; *c. m.*, corpus mammillare; 3, root of oculomotor; 4, root of pathetic; 5, root of trigeminal; 6, root of abducens; 7-8, roots of facial and auditory; *Fl.*, flocculus of cerebellum; 9, root of glossopharyngeal; 10, roots of vagus; *H.*, 12th, or hypoglossal; *p. v.*, pons Varolii.

transversely by a broad bridge—the corpus callosum, and beneath this there is a longitudinal band of fibres—the fornix. The corpus callosum is readily disclosed by gently separating the hemispheres. The outer wall and floor of the anterior part of the cavity or ventricle of each

hemisphere is formed by a thick mass, called the corpus striatum, and the internal cavity is lessened by a prominent convex ridge, called the hippocampus major. The ventricles of the cerebrum communicate with the third ventricle, between the optic thalami, by a small aperture, called the foramen of Monro. In front of the hemispheres two club-shaped olfactory lobes project. The thin cortical layer of the cerebrum consists of grey (ganglionic) matter, and so does the thick corpus striatum, while the central part consists of white matter (nerve fibres).

The thalamencephalon is entirely hidden, but gives origin as usual to the dorsal epiphysis, ending in a pineal body, which lies on the surface between the cerebrum and cerebellum, and to the ventral infundibulum, at the end of which the pituitary body lies, lodged in a fossa of the basisphenoid. Immediately in front of the infundibulum the optic nerves cross in a chiasma, from which optic tracts can be traced to the optic lobes. Immediately behind the infundibulum lies a rounded elevation, called the mammillary body. Anteriorly, on the ventral surface of each side of the thalamencephalon, there is a rounded swelling, called the corpus geniculatum. The roof of the third ventricle is formed by a thin membrane or velum, with a plexus of blood vessels. In the anterior wall of the third ventricle lies the small anterior commissure; across the third ventricle the large middle commissure runs; in the roof of the hind part of the ventricle lies a small posterior commissure.

The optic lobes are fourfold—*corpora quadrigemina*. They are in large part covered by the cerebrum. Between them runs the iter connecting the third ventricle and the fourth. The floor of this passage is formed by the thick *crura cerebri* which connect the medulla with the cerebrum.

The cerebellum has a median and two lateral lobes (with accessory flocculi), and is marked by numerous folds, mostly transverse. The two sides are connected ventrally by the pons Varolii, lying across the anterior ventral surface of the medulla.

The medulla oblongata lies beneath and behind the cerebellum, and is continued into the spinal cord. The cavity of the fourth ventricle is roofed by a thin membrane or velum, above which lies the cerebellum. On the ventral surface the medulla is marked by a deep fissure, bordered by two narrow bands or ventral pyramids.

The spinal cord presents its usual appearance, with its dorsal sensory nerve-roots with ganglia, its ventral motor nerve-roots apparently without ganglia, and the spinal nerves formed from the union of these. The ganglia of the adjacent sympathetic system perhaps belong to the ventral roots of the spinal nerves.

A large number of nerves pass down the neck. Of these the following are most important:—

1. The eleventh cranial nerve or spinal accessory, leaving the skull with the ninth and tenth, and distributed to the muscles of the neck.
2. The twelfth cranial nerve or hypoglossal, lying at first close to the ninth, tenth, and eleventh, turning, however, to the muscles of the tongue.

3. The tenth cranial nerve, the pneumogastric or vagus, lies outside the carotid artery, and gives off a superior laryngeal to the larynx with a depressor branch to the heart, an inferior or recurrent laryngeal, which loops round the subclavian artery and runs forward to the larynx, and other branches to the heart, lungs, and gullet.
4. The cervical part of the sympathetic, lying alongside of the trachea, with two ganglia.
5. The great auricular, a branch of the third spinal nerve, running to the outer ear.
6. The phrenic nerve, a branch of the fourth cervical nerve, with branch from the fifth and sometimes from the sixth, runs along the backbone to the diaphragm.

For details as to these nerves, the student should consult the practical manuals of Marshall and Hurst and of Parker.

As to the sense organs little need be said, for their general structure is like that of other Vertebrates, while the detailed peculiarities are beyond our present scope.

The third eyelid is well developed. The lachrymal gland (absent in Cetacea) lies under the upper lid, and the lids are kept moist by the secretion of Harderian and Meibomian glands. The external ear or pinna is conspicuously large. The cochlea of the inner ear is large and spirally twisted. The nostrils are externally connected with the mouth by a characteristic cleft lip. The tongue bears numerous papillæ with taste bulbs. The long hairs or vibrissæ on the snout are tactile.

Alimentary system.—In connection with the cavity of the mouth we notice the characteristic dentition, the hairy pad of skin intruded in the gap between incisors and premolars, the long and narrow, in part bony, palate separating the nasal from the buccal cavity, the muscular tongue with taste papillæ, the glottis leading into the windpipe, the bilobed epiglottis guarding the opening, the paired apertures of the Eustachian tubes opening into the posterior nasal passage, the end of this passage above the glottis, and the beginning of the pharynx. The organs of Jacobson are paired tubular bodies, vascular and richly innervated, lying enclosed in bone in the front of the nasal chamber, and communicating with the nostrils above, and on the other hand with the mouth by two naso-palatine canals which open behind the posterior incisors. Opening into the mouth and conducting the salivary juice, whose ferment alters the starchy parts of the food, are the ducts of four pairs of salivary glands. The parotid, which is largest, lies between the external ear-chamber and the angle of the mandible; the infra-orbital lies below and in

front of the eye; the submaxillary lies between the angles of the mandible; the small sublinguals lie along the inner side of each ramus of the mandible.

The pharynx passes into the gullet, and that leads through the diaphragm to the expanded stomach, which is dilated at its upper or cardiac end, and narrows to the curved pyloric end. Partly covering the stomach is the large liver. The first portion of the intestine, which is called the duodenum, receives the bile duct, and has the pancreas in its folds. Then follows the much-coiled small intestine, measuring many feet in length. It should be noted that, in adaptation to the more slowly digestible food and the larger amount of indigestible residue,

the intestine of herbivorous mammals is relatively longer than that of carnivorous types. The lower end of the small intestine is expanded into a sacculus rotundus. Here the large cæcum—a blind diverticulum—is given off; it ends in a finger-like vermiform appendix. Its proximal end is continuous with the colon or first part of the large intestine, the beginning of which is much sacculated. The large intestine

narrows into the long rectum, in which lie little fecal pellets. On the last two inches of the rectum there are paired yellowish glands. Beside the anus are two bare patches of skin, with the openings of the ducts of the perineal glands, whose secretion has a characteristic and strong odour.

The liver is attached to the diaphragm by a fold of peritoneum—the glistening membrane which lines the abdominal cavity. In the liver there are five lobes. From these lobes the bile is collected by hepatic ducts into a common bile duct, which is also connected to the gall-bladder by the cystic duct.

The very diffuse pancreas lies in the mesentery of the duodenal loop. Its secretion is gathered by several

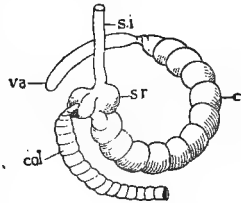

FIG. 389.—Diagram of cæcum in rabbit.

s.i., Small intestine; *s.r.*, sacculus rotundus; *col.*, sacculated colon; *c.*, cæcum; *v.a.*, vermiform appendix.

tubes into the pancreatic duct which opens into the duodenum.

The mesentery, which supports the alimentary canal, is a double layer of peritoneum reflected from the dorsal abdominal wall.

The dark red spleen lies behind the stomach. In the mesentery, not far from the top of the right kidney, lie a pair of coeliac ganglia, which receive nerves from the thoracic sympathetic system, and give off branches to the gut.

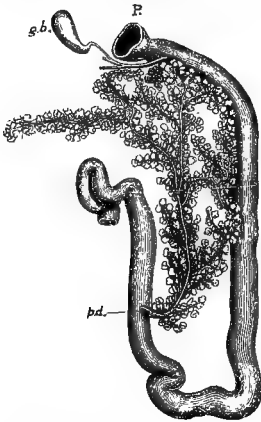

FIG. 390.—Duodenum of rabbit.
—From Krause, in part after
Claude Bernard.

P., Pyloric end of stomach; *g.b.*, gall-bladder with bile duct and hepatic ducts; *p.d.*, pancreatic duct.

Vascular system.—The blood of Mammals contains, as in other Vertebrates, red blood corpuscles (erythrocytes) and white blood corpuscles (leucocytes), but the former are non-nucleated except in their young stages. It is probable that the nuclear material becomes diffused through the cell. They appear as slightly biconcave circular discs (elliptical in *Camelidæ*), but many good observers describe spherical or cup-shaped or bell-shaped red blood corpuscles. It is not certain how far these shapes are normal. The four-chambered heart lies in the thoracic cavity between the lungs. It

is surrounded by a thin pericardium, and immediately in front of it there lies the soft thymus, which is larger in the young than in the adult animal.

By two superior venæ cavæ, and by the inferior vena cava, the venous blood collected from the body enters the right auricle. Thence the blood passes into the right ventricle through a crescentic opening, bordered by a threefold (tricuspid) membranous valve (worked by chordæ tendinæ attached to papillary muscles projecting from the wall of the ventricle).

The right ventricle is not so muscular as the left, which it partly surrounds. By its contraction the blood is driven into the pulmonary trunk, whose orifice is guarded by three semilunar valves. During contraction the tricuspid valves are pressed together, so that no regurgitation into the right auricle can take place.

The pulmonary trunk divides into two pulmonary arteries, which branch into capillaries on the walls of the lungs. There the red blood corpuscles gain oxygen, and the blood is freed from much

FIG. 391.—Circulatory system of the rabbit.

(a) Letters to right—

- e.c.* External carotid.
- i.c.* Internal carotid.
- e.j.* External jugular.
- scl.a.* Subclavian artery.
- scl.v.* Subclavian vein.
- p.a.* Pulmonary artery (cut short).
- p.v.* Pulmonary vein.
- L.A.* Left auricle.
- L.V.* Left ventricle.
- d.ao.* Dorsal aorta.
- h.v.* Hepatic veins.
- c.* Coeliac artery.
- a.m.* Anterior mesenteric.
- s.r.b.* Suprarenal body.
- l.r.a.* Left renal artery.
- l.r.v.* Left renal vein.
- K.* Kidney.
- p.m.* Posterior mesenteric artery (inadvertently shown as if paired).
- spm.* Spermatic arteries and veins.
- c.il.a.* Common iliac artery.

(b) Letters to left—

- p.f.* and *a.f.* Posterior and anterior facial.
- e.j.* External jugular vein.
- i.j.* Internal jugular.
- R.Scl.* Right subclavian artery.
- S.V.C.* Superior vena cava.
- R.A.* Right auricle.
- R.V.* Right ventricle.
- I.V.C.* Inferior vena cava.
- r.r.a.* Right renal artery.
- r.r.v.* Right renal vein.
- s.r.b.* Suprarenal body.
- spm.* Spermatic arteries and veins.
- i.l.* Ilio-lumbar vein.
- f.v.* Femoral vein.
- i.il.v.* Internal iliac veins.

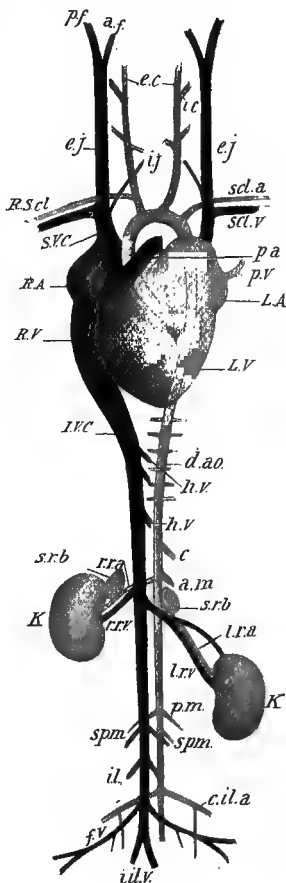

of the carbonic acid gas which it has borne away from the tissues. The purified blood returns to the heart by two pulmonary veins, which unite as they enter the left auricle.

From the left auricle the pure blood passes into the left ventricle through a funnel-like opening, bordered by a (mitral) valve with two membranous flaps, with chordæ tendineæ and muscoli papillares as on the right side, but the muscles here are larger.

The left ventricle receives the pure blood and drives it to the body. During contraction the mitral valve is closed, so that no blood can flow back into the auricle. The blood leaves the left ventricle by an aortic trunk, whose base is guarded by three semilunar valves, just above which coronary arteries arise from the aortic trunk and supply the heart itself.

The aortic trunk bends over to the left, and passes backward under the backbone, dividing near the pelvis into two common iliac arteries, which supply the hind-legs and posterior parts. The chief blood vessels may be grouped as follows:—

The aortic trunk

gives off the innominate artery,

which divides into (a) the right subclavian, continued as the brachial to the fore-limb, but giving off the vertebral to the spinal cord and brain, and the internal mammary to the ventral wall of the thorax;

(b) the right carotid, running along the trachea, dividing into the right internal carotid to the brain, and the right external carotid to the head and face;

(c) the left carotid, with a similar course;

thereafter the aorta gives off—

the left subclavian artery, which branches like the right;

the coeliac artery to the liver, stomach, and spleen;

the anterior mesenteric to the pancreas and intestine;

the renal arteries to the kidneys;

the single posterior mesenteric to the rectum;

the paired spermatic or ovarian arteries to the reproductive organs;

the lumbar arteries to the posterior body walls.

The aorta is continued terminally in the median sacral artery to the tail, and laterally in the common iliacs, which form the femorals of

the hind-legs, and give off in the abdomen several branches to the abdominal walls, the pelvic cavity, the bladder, and the uterus.

The two superior venæ cavæ bring blood from the head, neck, thorax, and fore-limbs. Each is formed from the union of—

- a subclavian from the shoulder and fore-limb,
- an external jugular from the face and ear,
- an internal jugular from the brain,
- an anterior intercostal from the spaces between the anterior ribs,
- an internal mammary from the ventral wall of the thorax ;

and the right superior vena cava also receives an azygos cardinal vein, which runs along the mid-dorsal line and collects blood from the posterior intercostal spaces.

The inferior vena cava is a large median vein lying beside the aorta beneath the backbone. Anteriorly it is embedded in the liver, and receives the hepatic veins. Thence it passes through the diaphragm into the right auricle. Posteriorly the inferior vena cava has the following components :—

- Internal iliacs from the back of the thighs, forming by their union the beginning of the inferior vena cava ;
- femoral veins from the inner borders of the thighs, continued into external iliacs which open into the inferior vena cava ;
- paired ilio-lumbar from the posterior abdominal walls ;
- spermatic or ovarian veins from the reproductive organs ;
- renal veins from the kidneys.

There is no renal-portal system.

The food which has been digested—rendered soluble and diffusible—passes from the food canal into the vascular system by two paths—

- (a) All except the fatty material is absorbed by veins from the stomach and intestine. These unite in a main trunk, the portal vein. The components of the portal vein are—the lienogastric from the stomach (and also from the spleen), the duodenal from the duodenum (and also from the pancreas), the anterior mesenteric from the intestine, the posterior mesenteric from the rectum. The portal vein breaks up into branches in the liver, whence the modified blood passes by hepatic veins into the inferior vena cava.
- (b) The fat passes through the intestinal villi into the lymphatic vessels, which combine to form a thoracic duct, which runs forward and opens into the left subclavian vein at its junction with the left external jugular. Here and there lie lymphatic glands.

Respiratory system.—The lungs are pink, spongy bodies, lying in the thorax, connected with the exterior by the bronchial tubes and the trachea, and with the heart by blood vessels. The pleural membrane which invests the surface of the lungs is reflected from the sides of the thoracic cavity. When the lungs expand, the pleural cavity—between the two folds of pleural membrane—is

almost obliterated. The thoracic cavity is separated from the abdominal cavity by a partly muscular diaphragm, which is supplied by two phrenic nerves, arising from the fourth cervical spinal nerves. By its contraction the diaphragm alters the size of the thoracic cavity, and thus

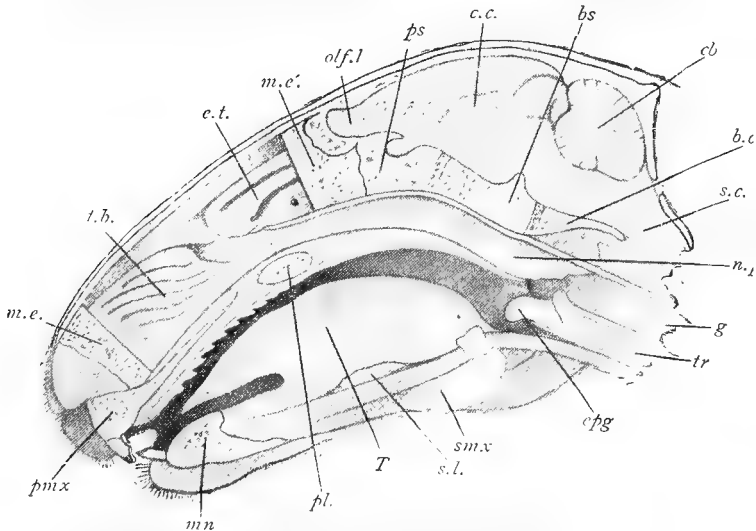

FIG. 392.—Vertical section through rabbit's head.—From a section, with help from Parker's *Zootomy* and Krause.

pmx., Premaxilla with incisors; *m.e.*, part of mesethmoid partition; *t.b.*, maxillary turbinals; *e.t.*, ethmoidal turbinal; *m.e.*, part of mesethmoid; *olf.l.*, olfactory lobe of cerebrum; *ps.*, presphenoid; *c.c.*, position of corpus callosum; *bs.*, basisphenoid with depression for pituitary body; *cb.*, cerebellum; *b.o.*, basioccipital; *s.c.*, spinal cord; *n.p.*, nasal passage; *g.*, gullet; *tr.*, trachea; *epg.*, epiglottis; *smx.*, submaxillary salivary gland; *s.l.*, sublingual salivary gland; *T.*, tongue; *pl.*, transverse portion of palatine; *mn.*, anterior end of mandible.

shares in the mechanism of respiration. At the top of the trachea lies the complex larynx, the seat of the voice in Mammals.

Anteriorly the larynx is supported on its sides and beneath by the thyroid cartilage; behind this lies the ring-like cricoid; dorsally to the cricoid are two small triangular arytenoids.

Within the larynx there are stretched membranous bands—the vocal chords. Beside the larynx is the paired thyroid gland.

Excretory system.—This includes the blood-filtering kidneys, their ducts the ureters, and a reservoir or bladder, into which these open. The kidneys and their ducts are formed from the metanephros and metanephric ducts of the embryo. The bladder arises as a diverticulum from the hind end of the gut, being in fact a remnant of the intra-embryonic part of the allantois. It loses its connection with the gut, and the ureters which originally opened into the rectum follow the bladder and open into it.

The kidneys are dark red ovoid bodies lying on the dorsal wall of the abdomen; the one on the left is farther down than that on the right, because of the position of the stomach on the left side. When a kidney is dissected, a marked difference is seen between the superficial cortical part and the deeper medullary substance. On papillæ or pyramids in the very centre the coiled excretory tubules open, and empty the water and waste products into the “pelvis” or mouth of the ureter.

The ureters run backward along the dorsal wall of the abdomen, and open into the bladder, a thin-walled sac lying in front of the pelvic girdle.

In front of each kidney lies a yellow suprarenal body.

Reproductive organs.—(a) *Male.*—The testes arise on the dorsal abdominal wall near the kidney, but as the rabbit becomes sexually mature, they are loosened from their original attachment, and pass out on the ventral surface, as if by a normal rupture, into the scrotal sac. A spermatic cord, consisting of an artery, a vein, and a little connective tissue, runs from the abdomen to the testis.

The testis is attached to the base of the scrotal sac, and is bordered by a mass of convoluted tubes—the epididymis—consisting of the caput epididymis anteriorly, the larger cauda epididymis posteriorly, and a narrow band between them. The cauda epididymis is connected to the scrotal sac by a short cord or gubernaculum.

Through the tubes of the epididymis (the modified mesonephros) the spermatozoa developed in the testis are

collected into the vas deferens (the modified Wolffian duct), which arises from the cauda epididymis, ascends to

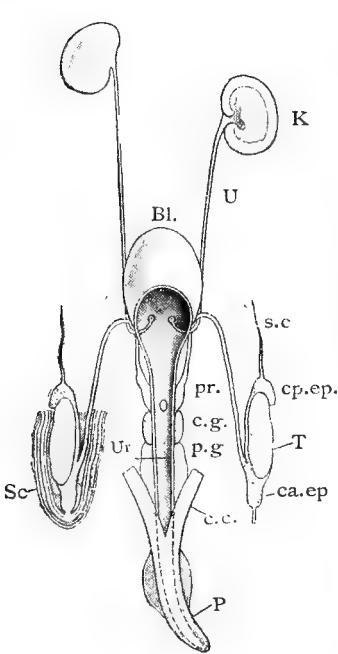

FIG. 393.—Urogenital organs of male rabbit.

K., Kidney; *U.*, ureter; *Bl.*, bladder; *T.*, testis; *s.c.*, spermatic cord; *cp.ep.*, caput epididymis; *ca.ep.*, cauda epididymis; *Sc.*, scrotal sac; *p.*, one of the lobes of the prostate; *c.g.*, Cowper's glands; *p.g.*, perineal glands; *Ur.*, urethra; *c.c.*, corpus cavernosum; *P.*, penis.

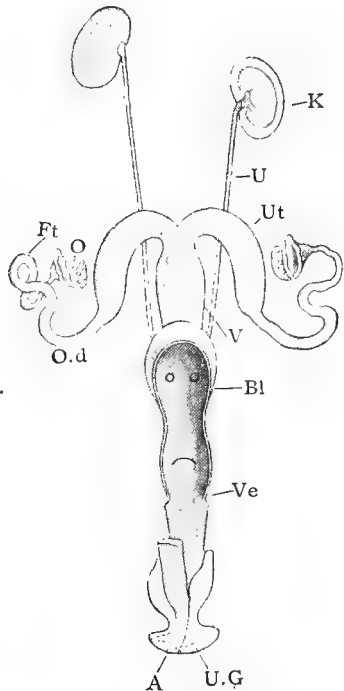

FIG. 394.—Urogenital organs of female rabbit.

K., Kidney; *U.*, ureter; *O.*, ovary; *F.t.*, Fallopian tube; *O.d.*, oviduct; *Ut.*, uterus; *V.*, vagina; *Bl.*, bladder; *Ve.*, vestibule or female urethra; *U.G.*, urogenital aperture; *A.*, anus. Bladder and vestibule are cut open.

the abdomen, loops round the ureter, and, passing dorsally to the bladder, opens beside its fellow into a median sac

called the uterus masculinus. In many Mammals; paired diverticula, known as seminal vesicles, are connected with the ends of the vasa deferentia, but they are not developed in the rabbit.

The uterus masculinus is the homologue of the vagina in the female, and seems to arise from the Müllerian ducts. It opens into the urethra, which runs backwards from the bladder, and the urogenital canal thus formed is continued through the penis.

Beside the uterus masculinus and the vasa deferentia, there are lobed prostate glands opening by several ducts into the urogenital canal. Behind the prostate, on the dorsal wall of the urogenital canal, lie two Cowper's glands.

The penis projects in front of the anus behind the pubic symphysis, has vascular dorsal walls (*corpus spongiosum*), stiff ventral walls (*corpora cavernosa*), and is invested by a loose sheath of skin—the prepuce. At the side of the penis lie two perineal glands.

(*b*) *Female*.—The ovaries are small oval bodies about three-quarters of an inch in length, attached behind the kidneys to the dorsal abdominal wall, exhibiting on their surface several clear projections or Graafian follicles, each of which encloses an ovum.

The ova, when mature, burst from the ovaries, and are caught by the adjacent anterior openings of the oviducts. The oviducts are modified Müllerian ducts, differentiated into three regions. The anterior portion or Fallopian tube is narrow, slightly convoluted, with a funnel-shaped, fimbriated mouth lying close to the ovary. The median portion or uterus is the region in which the fertilised ova become attached and develop. In the rabbit the uterine regions of the two oviducts are distinct, forming what is called a double uterus. In most Mammals the uterine regions of the oviducts coalesce, forming a bicornuate or a single uterus, according to the completeness of the fusion. In all Mammals above Marsupials the posterior parts of the two oviducts unite in a median tube—the vagina.

The vagina unites with the neck of the bladder, and forms the wide but short urogenital canal or vestibule, which opens at the vulva, ventral to the anus. On the ventral wall

of the vestibule lies the clitoris, a small rod-like body—the homologue of the penis. On the dorsal wall lie two small Cowper's glands, and there are also perineal glands as in the male.

The fertilised egg develops within the uterus, and in the rabbit, as in all Eutherian Mammals, the allantois of the embryo becomes intimately connected with the wall of the uterus to form the vascular placenta, the organ by means of which the nutrition and respiration of the embryo are provided for. In the rabbit, and in other Rodents, there is, before the development of the allantoic placenta, a provisional yolk-sac placenta—a structure of similar function but of much less morphological complexity. The details of the placentation of Mammals will be considered later.

NOTES ON COMPARATIVE ANATOMY OF MAMMALS

Skin.—This consists of a superficial epidermis (ectodermic) and of a subjacent mesodermic dermis or cutis.

The most characteristic modification of the mammalian epidermis is the hair. Each hair arises from the cornification of an ingrowing epidermic papilla of the Malpighian stratum of the epidermis, surrounded at its base by a moat-like follicle, and nourished during growth by a vascular projection of the dermis.

Each hair consists of a spongy central part and a denser cortex, but there are many diversities of form and structure, such as short fur and long tresses, the soft wool of sheep and the bristles of pigs, the spines of hedgehog, porcupine, and *Echidna*, the cilia of the eyelids and the tactile vibrissæ of the lips and cheeks.

The hair keeps the animal dry and warm; in the practically hairless Cetacea the layer of fat or blubber underneath the skin also serves to sustain the temperature of the body. Like feathers, hairs die away and are cast off, being replaced by fresh growths.

Among other tegumentary structures are the scales which occur along with hairs on the pangolins (*Manis*); the scales on the tails of rats and beavers and some other forms; the thickened skin-pads or callosities on the ischia of apes, the breast of camels, the legs of horses; the nails, claws, or hoofs which ensheath the ends of the digits in all Mammals except Cetaceans. Unique is the armature of the armadillos,

for it consists of bony plates developed in the dermis, overlaid by epidermic scales. The median solid horns of the rhinoceros are epidermic outgrowths, comparable to exaggerated warts; the paired horns of the Ruminants consist of epidermic sheaths covering outgrowths of the frontal bones, but extending far beyond these; the antlers of stags are outgrowths of the frontal bones, are cast and regrown each year, and are possessed by the males only, except in the reindeer.

The skin of Mammals, unlike that of Birds, is rich in glands. Sebaceous glands are always associated with the hair follicles, and sudorific or sweat glands are scattered over the skin.

Specialised glands are also very common, especially those which secrete some strongly odoriferous stuff, scenting which the animals recognise their fellows, their mates, or their young. Often they are most developed in the males, and their activity increases at the pairing season.

Among the numerous special glands may be noted those which are connected with a perforated spur on the hind-legs of male Monotremes, the sub-orbital glands of antelopes and deer, the anal glands of carnivores, the perineal glands of the civet, the preputial glands of the musk-deer and beaver, the inter-digital glands of the sheep.

Most characteristic, however, are the mammary glands, functional in female Mammals after parturition. They seem to be specialisations of sebaceous glands, except in Monotremes, in which they are nearer the sudorific type. They consist of branching tubes opening by one or several apertures on the skin.

In Monotremes the simple glands, compressed by muscles, open by many pores on a bare patch of skin. This is depressed into a slight cup, from which the young lick the milk. In Marsupials the glands open by teats or mammæ, generally hidden within a marsupium; and again the action of surrounding muscles forces the milk into the mouths of the young, which do not seem to be able to suck. An anterior prolongation of the larynx to meet the posterior nares establishes a complete air passage, and enables the young to continue breathing while they are being fed. In Cetacea the milk ducts are dilated into large reservoirs, the contents of which can be rapidly injected into the mouth of

the young. In all other Mammals the young suck the milk from the mammæ.

Dentition.—The teeth of Mammals are developed in the gum or soft tissue which covers the borders of the premaxillæ, maxillæ, and mandibles. As in other animals, they are in part of epidermic, in part of dermic origin. In the course of their development their bases are usually enclosed in sockets formed in the subjacent bones.

In most teeth there are three or four different kinds of tissue. The greater part consists of *dentine* or ivory (of which about a third is organic matter); outside of this there is a layer of very hard glistening *enamel* (practically inorganic); in the interior there is a cavity which in growing teeth contains a gelatinous tissue or *pulp* supplied by blood vessels and by branches of the fifth nerve, and contributing to the increase of the dentine; lastly, around the narrowed bases or roots of the tooth, or between the folds of the enamel if these have been developed, there is a bone-like tissue called the *crusta petrosa* or *cement*.

The development of teeth begins with the formation of a dental ridge, an invagination of the ectodermic epithelium. From this ridge a number of bud-like "enamel germs" are next differentiated. Beneath each germ a papilla of the vascular mesodermic dermis is defined off as the "dentine germ." The crown of this papilla becomes hard, and the ossification proceeds downwards and inwards, while above the dentine crown the enamel begins to form a hard cap. Meantime the tissue around the base of the tooth papilla becomes differentiated into an enclosing follicle or sac, from the inner layer of which the cement is developed. The papilla forms the pulp,—consisting of connective tissue, with blood vessels and nerves, and an enveloping zone of dentine-forming cells or odontoblasts.

The base of a tooth may remain unconstricted, and the core of pulp may persist. Such a tooth goes on growing, its growth usually keeping pace with the rate at which the apex is worn away with use, and it is described as "rootless" and "with persistent pulp." The incisors of Rodents and of elephants illustrate this condition.

In the development of most teeth, however, the base is narrowed and prolonged into a root or several roots which become firmly fixed in the socket. Through a minute aperture at the end of the root, blood vessels and nerves still enter the pulp-cavity and keep the tooth

alive, but, as the limit of growth is reached, the residue of soft pulp tends to disappear.

The two most marked characteristics of the teeth of Mammals are that they are typically *heterodont*—that is, different from one another in form and function—and that the succession is practically reduced to two sets, a condition described as *diphyodont* as contrasted with the *polyphyodont* condition seen in Fishes and Reptiles, where the succession is practically unlimited.

As exceptions, there are cases like that of the dolphins, where the teeth are uniform or *homodont* and very numerous. This, however, is not a primitive but a secondarily acquired condition.

In the typical dentition of Mammals there are forty-four permanent teeth, eleven on each side above and below ; but it is rare in the Eutherian Mammals to find the full number developed, and the dentitions of the Marsupials, of the Edentates, and of the Cetacea cannot be reduced to this type. The eleven on each of the upper jaws may be divided in the typical case into four sets. Most anteriorly, associated with the premaxilla, are three simple, single-rooted teeth, usually adapted for cutting or seizing. These are called incisors. Posteriorly there are crushing or grinding teeth, whose crowns bear cusps or cones, or are variously ridged, and which have two or more roots associated with the maxilla. But of these grinders the last three occur as one set, having no calcified successors, or, as others maintain, having no milk predecessors. They are therefore distinguished, as true molars, from the four more anterior and often simpler premolars, which usually occur in two sets, the milk set being replaced by a permanent set. In many cases, however, the first premolar seems to be only once represented. Finally, the tooth just behind the incisors—that is to say, immediately posterior to the suture between premaxilla and maxilla—is distinguished as the canine, and is often long and sharp.

This classification of teeth is in great part one of convenience : thus the distinction between incisors and grinding teeth is anatomical, that between molars and premolars refers to the history of these teeth ; the connection between the teeth and the subjacent bones is a secondary matter ; there is often little to differentiate canine from premolar. Moreover, the teeth of the lower jaw, which is a single bone on each side, cannot be so certainly classified as those of the upper jaw. Here the lower canine is defined as the tooth which bites in front of the upper, and the incisors as the teeth in front of this tooth.

The typical mammalian dentition already referred to may be expressed as follows:—

Incisors $\frac{3-3}{3-3}$, canines $\frac{1-1}{1-1}$, premolars $\frac{4-4}{4-4}$, molars $\frac{3-3}{3-3} = \frac{11-11}{11-11} = \text{total, } 44$;

or, using initial letters—

i. $\frac{3-3}{3-3}$, c. $\frac{1-1}{1-1}$, pm. $\frac{4-4}{4-4}$, m. $\frac{3-3}{3-3} = 44$;

or, recognising that the right and left side are almost invariably identical, and omitting the initial letters— $\frac{3143}{3143}$.

The formulæ for the adult dentition of some representative Mammals are the following:—

Opossum $\frac{5134}{4134}$, Thylacine $\frac{4134}{3134}$, Kangaroo $\frac{3124}{1024}$, Wombat $\frac{1014}{1014}$, Pig $\frac{3143}{3143}$, Camel $\frac{1133}{3123}$,
 Sheep $\frac{0033}{3133}$, Horse $\frac{3143}{3143}$, Rabbit $\frac{2033}{1023}$, Cat $\frac{3131}{3121}$, Dog $\frac{3142}{3143}$, Bear $\frac{3142}{3143}$, Seal $\frac{3141}{2141}$,
 Hedgehog $\frac{3133}{2123}$, Marmoset $\frac{2132}{2132}$, New World Monkey $\frac{2133}{2133}$, Old World Monkey $\frac{2123}{2123}$,
 Man $\frac{2123}{2123}$.

It is interesting to note the relation in particular cases between the diet and the form of the teeth. Thus the dolphins, which feed on fish and swallow them whole, have numerous, almost uniform, sharp, recurved, conical teeth, well suited to take a firm grasp of the slippery and struggling booty. To a slight extent the same piscivorous dentition may be seen in seals. In the more strictly carnivorous Mammals the incisors are small, the canines are long and sharp, piercing the prey with a deathful grip, while the back teeth have more or less knife-like edges, which sever flesh and bone. In typical insectivorous Mammals the upper and lower incisors meet precisely, "so as readily to secure small active prey, quick to elude capture but powerless to resist when once seized," while the crowns of the molars bear many sharp points. Herbivorous Mammals have front teeth suited for cropping the herbage or gnawing parts of plants, the canines are small or absent, the molars have broad grinding crowns with transverse ridges. In omnivorous Mammals the incisors are suited for cutting; the canines are often formidable weapons in the male sex; the molars have crowns raised into rounded tubercles.

A primitive form of tooth with three cusps in one plane is called *triconodont*; when the three cusps form a triangle, the tooth is called *tritubercular*; when the crown has a number of blunt or pointed cusps, it is called *bunodont*; when the cusps run into ridges, the term *lophodont* is used; when the cusps form a crescent, the tooth is called *selenodont*; when there is a long crown with the neck (the junction region between crown and root) deep in the socket, the tooth is called *hypsodont*; when there is a short crown with the neck at the surface of the gum, the term *brachyodont* is used.

Development and placentation.—The ova of Mammals, except Monotremes, are small; even those of the Whales are

“no larger than fern seed.” They are formed from germinal epithelium, the cells of which grow inwards in clustered masses into the connective tissue or stroma of the ovary. In each cluster one cell predominates over its neighbours; it becomes an ovum; the others invest and nourish it, and are called follicle cells.

In the middle of each clump or Graafian follicle a cavity is formed containing fluid, and into this cavity the follicle cells immediately surrounding the ovum project, forming what is called the *discus proligerus* (see Fig. 272, p. 514).

When mature, the ovum protrudes on the surface of the ovary, and is liberated by the bursting of the Graafian follicle. Ovulation may occur spontaneously—as in man, monkeys, horse, cattle, pig, dogs; or after sexual union—as in rabbit, guinea-pig, mouse, and cat. An ingrowth of epithelial cells surrounding the follicle develops into a glandular body called the corpus luteum. Its secretion is believed to be very important—influencing the preparation of the uterus, the early nutrition of the embryo, and the multiplication of cells in the milk glands. It seems that the ovary, besides producing ova, is a gland whose internal secretion, passing into the blood, induces, directly or indirectly, the phenomena of heat and menstruation, and influences the uterus during pregnancy.

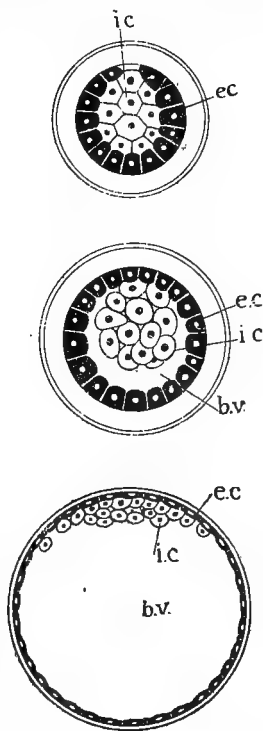

FIG. 395.—Segmentation of rabbit's ovum.—After Van Beneden.

e.c., External cells (epiblast); *i.c.*, internal cells (hypoblast); *b.v.*, blastodermic vesicle.

The spermatozoa are formed from germinal epithelium in the testes. The primitive male cells or spermatogonia give rise by division to daughter cells or spermatocytes, which, with or without further division, form spermatozoa.

The homologue of the ovum is the spermatogonium or mother sperm cell, but the physiological equivalent of the ovum is the spermatozoon.

The ovum, having burst from the ovary, is immediately caught by the fimbriated mouth of the Fallopian tube, and begins to pass down the oviduct. There it is met by ascending spermatozoa, received by the female as the result of sexual union, and is fertilised. One of the spermatozoa enters the ovum, and sperm nucleus unites with ovum nucleus in an intimate and orderly manner.

The connection between embryo and mother.—(a) The lowest Mammals, the Duckmole (*Ornithorhynchus*) and the Porcupine Ant-Eater (*Echidna*), resemble Birds and most Reptiles in bringing forth their young as eggs, *i.e.* in being oviparous. The eggs are large, with a considerable quantity of yolk, and after fertilisation divide partially, *i.e.* exhibit meroblastic segmentation like the eggs of Birds and Reptiles. The tunic formed round about them in the Graafian follicles of the ovary consists, as in Birds and Reptiles, of a single layer of cells. Development begins in the oviducts, but the eggs are in no way attached to the wall. They are

laid in a nest by the Duckmole; in the *Echidna* they are hatched in a slight, periodically developed, external pouch.

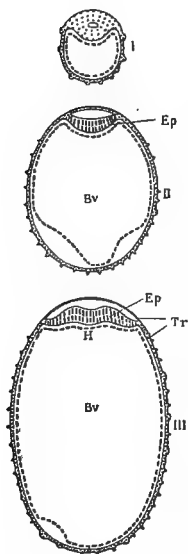

FIG. 396. — Development of hedgehog. Three early stages.— After Hubrecht.

- I. Shows internal vesicle of hypoblast; the disc and external sheath of epiblast. II. Shows villi arising from trophoblast; the disc of formative epiblast (*Ep.*); the blastodermic vesicle (*B.v.*). III. A more advanced stage; *Tr.*, trophoblast; *Ep.*, disc of formative epiblast; *B.v.*, blastodermic vesicle; *H.*, hypoblast.

(b) In the Marsupials the embryo is born prematurely after a short gestation. It is very small and helpless. Till recently it was believed that during its intra-uterine life it was either not attached to the wall of the uterus at all, or only to a slight extent by a yolk-sac placenta. It is now known, however, that, in *Perameles* at least, there is not only an efficient yolk-sac placenta, but a distinct, though small, allantoic placenta. The general absence of a

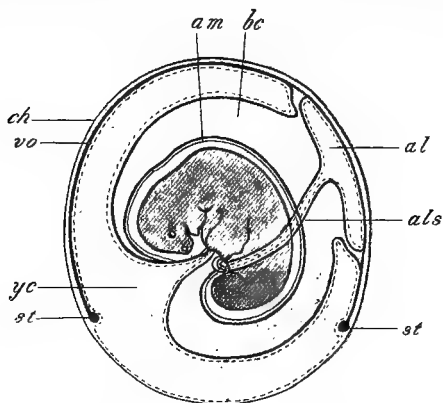

FIG. 397.—Embryo of *Perameles* with its foetal membranes.
—After Hill.

am., True amnion; *al.*, allantois; *als.*, allantoic stalk; *yc.*, cavity of yolk-sac; *ch.*, chorion or false amnion; *s.t.*, sinus terminalis; *b.c.*, extra-embryonic body cavity; *v.o.*, vascular omphalopleura, or area of non-separation between yolk-sac wall and chorion, constituting the yolk-sac placenta. The endoderm is dotted throughout. Note the large size of the yolk-sac, and the sinking of the embryo into it.

placenta in Marsupials, and the small size of the allantois, must therefore be ascribed to degeneration, and not to a primitive condition. The presence of a yolk-sac placenta in Marsupials is not in itself of great importance, for a connection between the yolk-sac of the embryo and the wall of the oviduct exists in two Elasmobranch fishes and in two lizards, but the similarity between the allantoic placenta of *Perameles* and that of the Eutheria seems to point indisputably to a common origin for the two structures.

(c) In the Eutherian Mammals, although a temporary yolk-sac placenta may occur, there is always a well-developed and exceedingly important allantoic placenta, which is the main organ for the nutrition of the embryo. The placenta, in rough physiological language, is a double vascular sponge, partly embryonic, partly maternal, by means of which the blood of the mother nourishes and purifies that of the embryo. It is formed by the interlocking of foetal and maternal tissue.

In giving an account of the placentation of the Eutheria, we shall mainly follow Hubrecht in his account of the

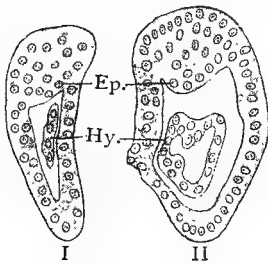

FIG. 398.—Two stages in segmented ovum of hedgehog. — After Hubrecht.

Ep., Epiblast; *Hy.*, hypoblast.

placentation of the hedgehog, which is at once a simple and central type.

Before doing so, it may be well to note briefly certain facts in regard to the early development of the egg. In Eutheria, segmentation is holoblastic and yolk is absent, but the process of development is very different from a simple case like that of *Amphioxus*. In the latter, all the cells of the blastosphere form part of the embryo; in the former, only a few take a direct part in the process; the remainder form the wall of the embryonic sac or blastocyst, from which the yolkless yolk-sac or umbilical vesicle is later developed. A process of folding-off of the embryo occurs therefore in Mammals as in Birds and Reptiles, the chief difference being that, roughly speaking, in the former the yolk-sac has a cellular wall from the first, in the latter the germinal layers slowly spread over the yolk as development proceeds.

Bearing these facts in mind, let us then seek to define the embryonic and maternal structures which are associated with placentation. (1) At a very early stage the divided ovum of the hedgehog consists of a sac of cells, an outer layer, epiblastic or ectodermic, enclosing another aggregate

—the future inner layer, endoderm or hypoblast (Fig. 398, I.).
 (2) The epiblast divides into an embryonic disc, which will form the epidermis, nervous system, etc., of the embryo, and an external layer, the wall of the embryonic sac or blastocyst, with which the disc retains a slight connection until the protective amnion is formed. In the outer epiblastic wall lacunæ develop, which are bathed by the maternal blood, and the pillars of tissue between the lacunæ grow out into villi, which aid in this earliest connection between mother and offspring. Long before any vascular area or foetal placenta is developed, the outer epiblastic wall has the above nutritive function, and deserves its name of *trophoblast* (Fig. 396, *Tr.*).
 (3) The hypoblast or inner mass, which is at first a solid aggregate of cells (Fig. 395, *i.c.*), becomes a sac, as a morula may become a blastosphere. The upper part

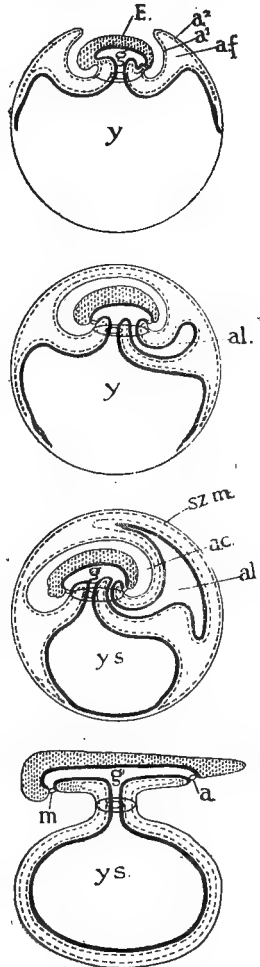

FIG. 399.—Development of foetal membranes.—After Hertwig.

Uppermost figure shows up-growth and down-growth of amnion folds. *E.*, Embryo; *a.f.*, amnion fold; *a.1*, amnion proper; *a.2*, subzonal membrane; *g.*, the gut; *y.*, umbilical vesicle or yolk-sac. The dotted line represents mesoderm; the dark, hypoblast. The second figure shows origin of allantois, and the amnion folds have met. The third figure shows increase of allantois (*al.*); the dwindling yolk-sac (*ys.*); *a.c.*, amniotic cavity; *sz.m.*, subzonal membrane. The fourth figure shows the embryo apart from its membranes: *m.*, mouth; *a.*, anus. Note umbilical connection with yolk-sac.

of this sac forms the lining of the incipient gut, while the lower portion, following the contour of the blastocyst wall, forms the lining of the umbilical vesicle (cf. the Chick). From this vesicle or yolk-sac the embryo becomes folded off, and the connection between the two is narrowed, just as in the chick, into a canal—the vitelline duct, which is part of the “umbilical cord,” entering the embryo at the future navel. (4) Between the epiblast and the hypoblast

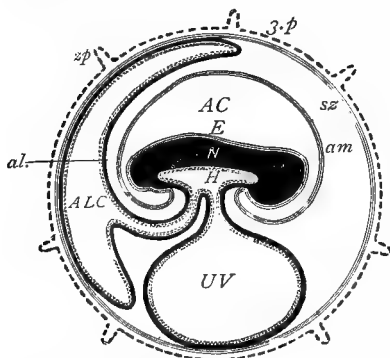

FIG. 400.—Diagram of foetal membranes
—After Turner.

E., Embryo; H., gut lined by hypoblast, dotted—the dark is mesoblast; UV., umbilical vesicle or yolk-sac; AC., amniotic cavity; am., amnion proper; sz., subzonal membrane; ALC., allantoic cavity; al., allantois; z.p., may be here taken to represent the early epiblastic trophoblast. The figure does not show that the amnion folds consist of both epiblast and mesoblast.

of the embryo, the mesoblast develops, splitting into an outer, parietal, or somatic, and an inner, visceral, or splanchnic layer. The cavity between these is the incipient body cavity. A double fold of somatic mesoblast, carrying with it a single sheet of epiblast, rises up round about the embryo, arching over it to form the amnion. Over the embryo the folds of amnion meet in a cupola, and the inner layers of the double fold

unite to form the “amnion proper,” while the outer layers also unite to form a layer lying internally to the epiblastic blastocyst wall,—and termed by Sir William Turner *the subzonal membrane*. The folds of amnion are continued, as the diagram shows, ventrally as well as dorsally, so that the subzonal membrane surrounds the embryo beneath the blastocyst wall, while a splanchnic layer of mesoblast grows round about the hypoblastic yolk-sac. The space between the two layers of mesoblast is continuous with the body cavity of the embryo. The epiblastic outer wall or tropho-

blast, and the mesoblastic subzonal membrane, are included in Hubrecht's term—diplotrophoblast. (5) From the hind-wall of the gut there grows out a hypoblastic sac, the allantois, insinuating itself and spreading out in the space between the two layers of mesoblast. As an outgrowth of the gut, homologous with the bladder of the frog, the allantois is lined by hypoblast or endoderm, but it is covered externally by a layer of mesoblast, which it bears with it as it grows. In all placental Mammals, the allantois, which becomes richly vascular, unites with the subzonal membrane, and therefore with the external epiblast as well, to form the foetal part of the placenta, with outgrowing vascular processes or villi, which fit into corresponding depressions or crypts on the wall of the uterus. To the mesoblastic wall of the allantois, plus the subzonal membrane, the term "chorion" is sometimes applied; but as the word has been used in many different senses, its abandonment is almost imperative. The complex union of allantois with diplotrophoblast Hubrecht calls the allantoidean trophoblast. (6) But in the hedgehog, rabbit, and some other Eutherian types, as well as in certain Marsupials, there is a mode of embryonic nutrition between that attained by the epiblastic trophoblast and that affected by the final placenta. The wall of the yolk-sac, hypoblastic internally, mesoblastic externally, unites with the subzonal membrane, and becomes the seat of villous processes, which through the external epiblast are connected with the uterine wall. Thus is formed what Hubrecht calls an omphaloidean trophoblast or yolk-sac placenta. In connection with this yolk-sac placenta it will be recollected that the yolk-sac, here as in the Bird, is a vascular structure well fitted for a placental function. In the Bird and in most Mammals, however, the splitting of the mesoblast as it follows the contour of the yolk-sac forms a space—the extra-embryonic body cavity—between the yolk-sac and the subzonal membrane. When a yolk-sac placenta is developed, the splitting of the mesoblast is retarded, so that the vascular yolk-sac comes to lie close under the subzonal membrane. This is especially well seen in *Perameles* (see Fig. 397), and is of much importance in the formation of an efficient yolk-sac placenta.

(7) The embryo lay at first in a groove of the uterine wall,

moored by the preliminary blastocyst villi, which are as it were pathfinders for those subsequently developed from yolk-sac and allantoic regions. At the point of attachment the mucous lining of the uterus ceases to be glandular, and becomes much more vascular. As the embryo becomes fixed, the blastocyst almost eating its way in, the outer epithelium degenerates and disappears; below this the next layer of the mucous membrane becomes spongy and exhibits unique blood spaces, forming what Hubrecht calls the trophospongia; below this there is the vascular and vitally active remainder of the mucosa, less modified than the above-mentioned sponge; below this again there are the muscular and other elements of the uterine wall, with which we are not now concerned. The most important fact to emphasise is, that the maternal blood in the spaces of the spongy outer layer of the mucous membrane directly bathes the foetal tissue represented by the trophoblast. By the activity of the trophoblast cells, the nutritive and respiratory advantages of the maternal blood are secured for the villi of the allantois and yolk-sac. It ought also to be mentioned that, mainly by a folding of the uterine wall, the hedgehog embryo is virtually enclosed in a maternal sheath, homologous with a fold called the decidua reflexa in human embryology, and analogous with a similar capsule in the rabbit.

To sum up—

1. At an early stage a wall of epiblast encloses an aggregate of hypoblast (Figs. 395, 396, I., 398).
2. The epiblast divides into an embryonic disc and an outer blastocyst wall, with fixing and nutritive functions,—the trophoblast (Fig. 396, I. and II.).
3. The hypoblast becomes a sac, of which the upper portion lines the gut, while the lower part forms the yolk-sac (Fig. 396, III.).
4. The mesoblast divides into somatic and splanchnic layers; a double fold of the somatic layer (along with a slight sheet of epiblast) forms the amnion, of which the outer limbs unite as the subzonal membrane, and form, along with the external epiblast, the diplotrophoblast. The splanchnic layer of the mesoblast is continued round the yolk-sac (Fig. 399).
5. The allantois grows out from the hind region of the gut, being lined internally by hypoblast, externally by splanchnic mesoblast. The allantois plus the diplotrophoblast always forms the true placenta (Fig. 400).
6. Part of the yolk-sac wall, uniting with the diplotrophoblast, also forms an efficient but temporary placenta.

7. At the area of fixing, the uterine epithelium degenerates, the glands disappear, vascularity increases. The outer part of the modified mucous membrane (or decidua) becomes a spongy tissue, with spaces filled with maternal blood. This maternal blood bathes the trophoblast, which is intermediate between it and the placental villi.

The three modes of embryonic nutrition are as follows :—

- (a) At first the maternal blood bathes the lacunæ in the epiblastic outer wall—the trophoblast with its preliminary pathfinding villi.

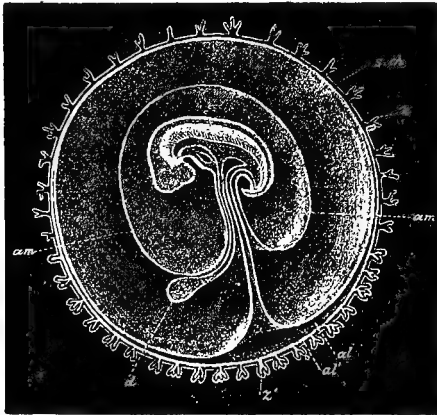

FIG. 401.—View of embryo, with its foetal membranes.
—After Kennel.

am., Amnion proper; *d.*, dwindled yolk-sac; *al.*, allantois; *al.*, subzonal membrane; *z.*, *z'*, villi. Outside the subzonal membrane there is the delicate ectodermic trophoblast (*s.ch.*).

- (b) An efficient yolk-sac placenta functions for a time, but decreases and shrivels as the final allantoidean placenta develops. The maternal blood in the spaces of the outer layer of the mucous layer of the uterus bathes the trophoblast. Thus it comes into indirect connection with the vascular villi from the region where the yolk-sac wall unites with the diplotrophoblast. This yolk-sac placenta is well seen in Insectivora, Chiroptera, Rodentia, the horse, etc., and seems to be to some extent developed in all Mammals (except Monotremes) as yet examined.
- (c) The final placenta is allantoidean.

In the above description the yolk-sac placenta has been emphasised on account of its comparative importance, but it must be clearly under-

stood that the allantoic placenta is often the only one well developed, and is always of supreme importance in reference to the nutrition of the embryo.

From the comparative standpoint the most important variations in regard to the placenta are—first, the method of distribution of the villi on the surface of the allantois; and second, the extent of the connection between maternal and foetal tissues. Where the connection is very intimate, parts of the maternal tissue come away at birth, and the placenta is said to be deciduate. Where there is a less close interlocking, the foetal villi are simply withdrawn from the maternal crypts, and the placenta is indeciduate. In *Perameles*, and to a less extent in the mole (*Talpa*), not only is there no loss of maternal tissue, but part—in *Perameles* the greater part—of the foetal portion of the placenta is absorbed *in situ* by maternal leucocytes, a condition described by Hubrecht as contra-deciduate. The distinction between the deciduate and indeciduate forms is not perfectly sharp, and Hubrecht prefers the older terms, Caducous and Non-Caducous.

THE CUSTOMARY CLASSIFICATION OF PLACENTATION

Caducous or Deciduate. (Vascular parts of maternal placenta come away at birth.)	}	<i>Meta-Discoidal</i> .—Villi, at first scattered, are } <i>Homo</i> and restricted to a disc. } Monkeys.	
		}	Around the embryo the maternal mucous membrane forms a capsule (<i>decidua reflexa</i>), also seen in hedge- hog.
			<i>Discoidal</i> .—Villi on a circular cake-like disc. } Rodentia. Insectivora (in the mole inde- ciduate and in part contra- deciduate) and Chiroptera. Most Edentata. <i>Perameles</i> (contra-decidu- ate).
Non-Caducous or Indeciduate. (Maternal part of placenta does not come away at birth.)	}	<i>Zonary</i> .—Villi on a partial or complete girdle round the embryo. } Carnivora. Elephants and Hyrax. <i>Orycteropus</i> and <i>Dasypus</i> among Edentata. Dugong (wholly or in great part non-deciduate).	
		<i>Cotyledonary</i> .—Villi in patches. Ruminants.	
}	}	<i>Diffuse</i> .—Scattered Villi. } Lemurs. Most Ungulates, except Ruminants. Cetacea. <i>Manis</i> among Edentata.	

There is some uncertainty as to the primitive form of the placenta, but the fact that it is discoidal in *Perameles* seems to confirm Balfour's view that this form must be placed lowest.

The formation of the allantoic placenta in *Perameles* is in essentials the same as in Eutherian Mammals, but in details there are some striking differences. The most noteworthy of these is, perhaps, that the cells of the uterine epithelium, instead of disappearing at an early stage, as in Eutherian Mammals, proliferate greatly, lose their cell outlines, and by the increase of the nuclei form what is known as a syncytium. Later this syncytial layer becomes highly vascular, and forms the maternal portion of the placenta, whereas, as already seen, in Eutheria it is the uterine mucosa which forms the maternal part of the placenta. Into the vascular syncytium the allantoic capillaries grow down, until ultimately maternal and foetal vessels are separated merely by their endothelial walls and a mere trace of syncytial protoplasm. The connection between the yolk-sac wall and the uterus is effected in a similar manner.

GENERAL LIFE OF MAMMALS

Most Mammals live on dry land. The bats, however, have the power of flight, and various forms are able to take long swooping leaps from tree to tree. Thus there are "flying phalangers," such as *Petaurus*, among Marsupials; "flying squirrels," such as *Pteromys*, among Rodents; "flying lemurs" (*Galeopithecus*), allied to Insectivores. Not a few are aquatic,—all the Cetaceans, the two Sirenians, and the Pinniped Carnivores, such as seals and walruses; while water-voles, beavers, otters, polar bear, and many others are also at home in the water. Burrowers are well represented by moles and rabbits; arboreal forms by squirrels and monkeys.

As to diet, man, many monkeys, the pigs, and many others, may be called omnivorous; kangaroos, hoofed animals, and most rodents are herbivorous; the Echidna, the ant-eaters, hedgehogs and shrews, and most bats, are insectivorous; most of the Carnivora are carnivorous; dolphins and seals feed chiefly on fishes; but in most cases the diet varies not a little with the available food-supply.

The struggle for existence among Mammals is sometimes keen among fellows of the same kind; thus the brown rat (*Mus decumanus*) tends to drive away the black rat (*M. rattus*); but stress, due to over-population, is sometimes mitigated by migration, as in the case of the lemmings. The struggle seems to be keener between foes of different kinds,

between carnivores and herbivores, between birds of prey and small mammals; but combination for mutual defence often mitigates the intensity of the conflict. Teeth and claws, hoofs and horns, are the chief weapons, while the scales of pangolins, the bony shields of armadillos, the spines of hedgehogs and porcupines, and the thick hide of the rhinoceros, may be regarded as protective armature. In keeping their foothold some Mammals are helped by the harmony between their colouring and that of their surroundings; thus the white Arctic fox and hare are inconspicuous on the snow, the striped tiger is hidden in the jungle; and many tawny animals harmonise with the sandy background of the desert.

The majority of Mammals are gregarious; witness the herds of herbivores, the cities of the prairie-dogs, the packs of wolves, the schools of porpoises, the bands of monkeys. Combinations for attack and for defence are common; sentinels are posted and social conventions are respected; such migrations as those of the lemming and reindeer are characteristically social. In the beaver village and among monkeys there is combination in work, and their communal life seems prophetic of that sociality which is distinctively human.

Among Birds, mates are won by beauty of song and plumage; Mammals not less characteristically woo by force. Rival males fight with one another, and are usually larger and stronger than their mates. The antlers of male deer, the tusk of the male narwhal, the large canine teeth of boars, illustrate secondary sexual characters useful as weapons. But manes and beards, bright colours and odoriferous glands, are often more developed in the males than in the females, and may be of advantage in the rough mammalian courtship. At the breeding season a remarkable organic reaction often affects the animal: the timid hare becomes a fierce combatant, and love is often stronger than hunger. The courtship of Mammals is usually like a storm—violent but passing; for, after pairing, the males return to their ordinary life and the females become maternal. Some monkeys are faithfully monogamous; and exceptional pairs, such as beavers and some antelopes, remain constant year after year; but this is not the way of the majority.

The duckmole lays eggs and brings up her young in the shelter of the burrow; the Echidna has a temporary pouch. In Marsupials the time of gestation is very short, and there is rarely a true placental union between the unborn young and the mother. The new-born Marsupials are very helpless, and are in most cases transferred to an external pouch or marsupium, within which they are nurtured. In Eutherian Mammals the gestation usually lasts much longer than in Marsupials,—its duration varying to some extent with the rank in the mammalian series: but there are great differences in the condition of the young at birth. “In those forms,” Sir W. H. Flower says, “which habitually live in holes, like many Rodents, the young are always very helpless at birth; and the same is also true of many of the Carnivora, which are well able to defend their young from attack. In the great order of Ungulates or Hoofed Mammals, where in the majority of cases defence from foes depends upon fleetness of foot, or upon huge corporeal bulk, the young are born in a very highly developed condition, and are able almost at once to run by the side of the parent. This state of relative maturity at birth reaches its highest development in the Cetacea, where it is evidently associated with the peculiar conditions under which these animals pass their existence.”

The maternal sacrifice involved in the placental union between the mother and her “foetal parasite,” in the prolonged gestation, in the nourishment of the young on milk, and in the frequently brave defence of the young against attack, has been rewarded in the success of the mammalian race, and has been justified in the course of natural selection. But it is important to recognise that the maternal sacrifice—whatever its origin may have been—expresses a subordination of self-preserving to species-maintaining. Thus other-regarding as well as self-regarding activities have been factors in evolution.

Pedigree.—The origin of Mammals remains obscure, but there is much to be said for their affiliation to some ancient Reptilian stock, such as the Anomodontia (especially the Theriodontia).

In several features the Monotremes link the Mammals to living Reptiles, *e.g.* the structure of the pectoral girdle, the cloaca, the condition of the genital ducts, the relatively large ova with meroblastic segmentation, but it is out of the question to think of any of the

living types of Reptiles as near the direct line of Mammalian pedigree.

In "Anomodontia" there are so many mammalian features in the skeleton that in spite of the complex lower jaw articulating with a fixed quadrate, the presence of an os transversum, pre- and post-frontals, etc., some have doubted whether they should be ranked as Reptiles at all. We may note that they were purely terrestrial animals (of large size) with limbs lifting the body high off the ground, that the squamosal sometimes descends far down outside the quadrate and may share in the articulation for the lower jaw, that the quadrate is often small, that there is a single temporal arcade comparable to the mammalian zygomatic arch, that the teeth are heterodont, that the pelvic bones unite in an os innominatum with a continuous ischiac symphysis, that the scapula often has a spine, that the occipital condyle may be double, that there is a beginning of reduction and consolidation of skull bones, and so on.

But it may quite well be that the Anomodontia are not in the direct line of Mammalian ancestry, but represent a side-branch from transitional forms connecting Reptiles and Mammals.

The student should look back to the characters common to the Amniota (Reptiles, Birds, and Mammals), *e.g.* the presence of amnion and allantois, the absence of gills, etc., for these indicate a close alliance far apart from Ichthyopsida, and it seems therefore unprofitable to look for the roots of the Mammalian stock so low down as among Amphibians.

Nevertheless, amid so much uncertainty, we may recall the facts that in Amphibians we find two occipital condyles, a reduced quadrate, a somewhat mammalian carpus, holoblastic ova, and so on.

The oldest Mammalian fossils are from Triassic strata, but they throw little or no light on pedigree, partly perhaps because they are few and fragmentary, partly also because they seem already specialised forms. They are often grouped together as Allotheria or Multituberculata and placed near the Monotremes.

In the Jurassic period there are more of the dubious Allotheria, *e.g.* *Plagiaulax*, some "triconodont" Marsupials, *e.g.* *Triconodon* and *Amphilestes*, and the Trituberculata, *e.g.* *Amphitherium*, some of which suggest primitive Insectivora. There are few Cretaceous fossil remains of Mammals, but some of them suggest that the orders of Eutheria were incipient.

In the earliest Eocene strata, Mammals related to modern types begin to be abundant, but we cannot do more than notice two points—(a) there were some generalised types, *e.g.* Creodonts and Condylarthra, with relationships to several extant orders; (b) that the early forms were mostly small animals with small brains, pentadactyle, with 44 teeth including small canines and bunodont molars.

Professor Osborn has suggested that there were two main lines of mammalian evolution—(a) the "Mesoplacentalia," *e.g.* Amblypoda, Coryphodontia, Dinocerata, Tillodontia, and many Condylarthra and Creodonts, in which the brain remained small and unspecialised, which died out in the Miocene (unless the Marsupials, Insectivores, and Lemurs represent their descendants), and (b) the successful lines of

“Cenoplacentalia,” which made, so to speak, a fresh start, with a premium on brains, and led to most of the modern types. In almost every case, it may be said that an order begins with small representatives, and that the giant forms almost always indicate the end of a race.

SYSTEMATIC SURVEY OF THE ORDERS OF MAMMALIA

- I. Sub-class PROTOTHERIA or ORNITHODELPHIA, Orders
 Monotremata, and (?) Allotheria or
 Multituberculata.
- II. „ METATHERIA or DIDELPHIA, Orders Poly-
 protodontia and Diprotodontia.
- III. „ EUTHERIA or MONODELPHIA.

Orders of EUTHERIA.

1. Xenarthra. }
 2. Nomarthra. } “Edentates.”
3. Sirenia.
4. Ungulata.
 Artiodactyla. } Ungulata Vera.
 Perissodactyla. }
 Hyracoidea.
 Proboscidea.
 Extinct sub-orders.
5. Cetacea.
 Mystacoceti—baleen cetaceans.
 Archæoceti—(extinct types).
 Odontoceti—toothed cetaceans.
6. Rodentia.
 Simplicidentata.
 Duplicidentata.
7. Carnivora.
8. Pinnipedia.
9. Insectivora.
10. Galeopithecidæ or Dermaptera.
11. Chiroptera.
 Megachiroptera.
 Microchiroptera.
12. Prosimiæ or Lemuroidea. } = Primates.
 13. Anthropoidea. }

Sub-Class PROTOTHERIA (*Syn.* ORNITHODELPHIA),
Orders Monotremata and (?) Allotheria

The Monotremes include the duckmole (*Ornithorhynchus anatinus*), the spiny ant-eater (*Echidna aculeata*), and a third form resembling *Echidna*, but often referred to a distinct genus as *Proechidna*. These are the lowest Mammals, very different from all the rest, and they exhibit affinities with Reptiles.

The duckmole is found in the rivers of Australia and Tasmania; *Echidna* in Australia, Tasmania, and New Guinea; *Proechidna* in New Guinea.

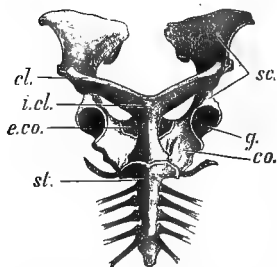

FIG. 402.—Pectoral girdle
of *Echidna*.

sc., Scapula; *cl.*, clavicle; *i.cl.*, prosternum or "interclavicle"; *co.*, coracoid or metacoracoid; *e.co.*, procoracoid or precoracoid; *st.*, mesosternum.

In *Ornithorhynchus* the skin is covered with soft fur; in *Echidna* and *Proechidna* there are spines among the hairs. The mammary glands in the female *Ornithorhynchus* open on a flat patch; in *Echidna*, in a depressed area around which a temporary pouch seems to be developed. There are no distinct mammæ.

The vertebral centra have weak epiphyses in *Ornithorhynchus*, and apparently none in *Echidna*. In the duckmole the post-sacral vertebræ are stronger than the pre-sacral. The skull is smooth and polished as in Birds, for the sutures disappear. The rami of the lower jaw do not unite in front, have no ascending process, and have a slightly inflected angle. In *Ornithorhynchus* there are true mammalian teeth, but only in the young; in *Echidna* none are present. Cervical ribs remain distinct for a time at least; the odontoid process of the second vertebra is for a long time free from the centrum. Except on the atlas of *Echidna*, the cervical vertebræ are without zygapophyses or articular processes. The (meta-) coracoids reach the sternum; there are also large precoracoids (often called epicoracoids, but homologous with the precoracoids of many

SOME CONTRASTS BETWEEN THE THREE SUB-CLASSES OF MAMMALS

<p>PROTHERIA. ORNITHODELPHIA, MONOTREMES.</p>	<p>METATHERIA. DIDELPHIA, MARSUPIALS.</p>	<p>EUTHERIA. MONODELPHIA, PLACENTALS.</p>
<p>Oviparous. No mammae are developed.</p> <p>Large ova, with much yolk; meroblastic segmentation.</p> <p>Large anterior commissure. Corpus callosum, small or absent. A cloaca into which the rectum and the urogenital sinus open.</p> <p>The vasa deferentia open into the urogenital sinus; the canal of the penis is not continuous with the vasa deferentia. The oviducts (without differentiated regions) open separately into the urogenital sinus; the ureters open not into the bladder but into the urogenital sinus. Pre- and meta-coracoids reach the sternum. A strong prosternum (not = interclavicle or episternum).</p> <p>Many other skeletal peculiarities, thus: the sutures of the skull close, the vertebral centra have indistinct epiphyses, or none. Two epipubic bones.</p> <p>..</p> <p>Blood temperature, 25°-28° C.</p>	<p>Young born prematurely after very short gestation; after birth they are usually nurtured in a pouch; there is rarely a true allantoic placenta.</p> <p>Small ova; holoblastic segmentation; large yolk-sac, with villi from its surface.</p> <p>Large anterior commissure. Corpus callosum, small or absent. Anus and urogenital aperture surrounded by the same sphincter muscle; in the females there is a rudimentary cloaca, except in kangaroos. The scrotum is in front of the penis.</p> <p>Two uteri and two vaginæ; sometimes the proximal portions of the vaginæ fuse in a medium cæcum or tube; ureters open into the bladder. Epicoracoids occur as small processes of the scapula. At most, hints of meta-coracoids. The epicoracoids may reach the sternum in the fetus.</p> <p>..</p> <p>Generally two epipubic bones. The angle of the lower jaw is inflected (except in <i>Tarsipes</i>).</p> <p>Blood temperature, 32°-36° C.</p>	<p>During gestation the young are vitally united to the mother by a well-developed allantoic placenta.</p> <p>Small ova virtually without yolk; holoblastic segmentation. The yolk-sacs small, except in Rodentia, Insectivora, and Chiroptera, where it forms a provisional yolk-sac placenta. Small anterior commissure. Large corpus callosum. Anus and urogenital aperture quite distinct.</p> <p>The scrotum (when present) is behind the penis.</p> <p>The uteri are generally more or less united in one; the vaginal portions are united; the ureters open into the bladder. Epicoracoids occur as small processes of the scapula. At most, hints of meta-coracoids.</p> <p>..</p> <p>Only hints of epipubic bones (some foetal Carnivores and Ungulates).</p> <p>Blood temperature, 35°-40° C.</p>

Reptiles and Amphibians) and a T-shaped prosternum (sometimes called interclavicle), on which the inner ends of the clavicles rest, the outer ends abutting on the acromion of the scapulæ. In *Ornithorhynchus* the ischia form a long ventral symphysis; in *Echidna* the acetabulum socket for the femur is incompletely ossified (remining one of Birds, though it is only a secondary peculiarity); the pubes bear epipubic bones, as in Marsupials. On the side of the tarsus, in the duckmole, there is a spur perforated by the duct of a gland. This spur is well developed in the males, but rudimentary in the females. The male *Echidna* has a similar but smaller spur.

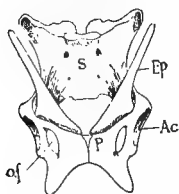

FIG. 403.—Pelvis of *Echidna*.

S., Sacrum; Ep., epipubic bones; Ac., acetabulum; of., obturator foramen between ischium and pubis (p.).

The fibula has a proximal process like an olecranon.

The brain is smooth in the duckmole, convoluted in *Echidna*; the cerebellum is not covered by the cerebrum, there is a large anterior commissure, and the corpus callosum is rudimentary or absent.

The food canal ends in a cloaca.

The right auriculo-ventricular valve in *Ornithorhynchus* is partly muscular as in Birds, while in other Mammals it is membranous and worked by papillary muscles attached to it by tendon-like cords (chordæ tendineæ). The temperature of the blood is about 25°–28° C., and is noteworthy in being unusually variable. In fact, the Monotremes are imperfectly warm blooded.

The ureters open, not into the bladder, but into the urogenital canal, as they do in the embryos of higher Mammals.

The testes remain in the abdomen. The left ovary is larger than the right, as in Birds. The vasa deferentia open separately into the urogenital canal. So in the female do the oviducts, and these have no fringed fimbriated apertures nor distinct uterine region. The penis is attached to the ventral wall of the cloaca, and the urogenital canal communicates both with the cloaca and with the canal of the penis. The whole structure resembles in

many ways the copulatory organ of certain Reptiles and Birds.

The ova are large, with abundant yolk, and undergo meroblastic segmentation. The Prototheria are oviparous.

The duckmole, or duck-billed platypus, lives beside lakes and rivers. It swims by means of its fore-limbs, which are webbed as well as clawed; it grubs for aquatic insects, crustaceans, and worms, in the mud at the bottom of the water or among the floating weeds. It collects small animals in its cheek pouches, and chews them at leisure with its eight horny jaw-plates. It makes long burrows in the banks, often with two openings, one above, one under the water. The animal is shy, and dives swiftly when alarmed. When about to sleep, it rolls itself into a ball. In the recesses of the burrows the eggs are laid, two at a time. The egg measures about three-quarters of an inch in length, and is enclosed in a flexible white shell, through which the young animal has to break its way.

The full-grown duckmole measures from 18 to 20 in. in length; the male slightly exceeds his mate. The fur is short and soft, dark brown above, lighter beneath. The jaws are flattened like the bill of a duck, and covered with naked skin, which forms a soft, sensitive collar around the region where the bill joins the rest of the skull. The eyes are very small. There is a well-developed but inconspicuous pinna; the nostrils lie near the end of the upper part of the bill. The tail is flat.

True teeth, three on each jaw above and below, are calcified, last for about a year, and are then lost, being replaced by horny plates, two on each jaw, above and below. The spur borne on the heel seems to be sometimes used as a weapon, and as it persists only in the males, is perhaps useful in contests between rivals.

Echidna and *Proechidna* live in rocky regions, are mainly nocturnal in habit, and burrow rapidly, legs foremost. They feed on ants, which are caught on the rapidly mobile, slender, viscid tongue. No traces of teeth have as yet been seen.

Strong spines occur thickly in *Echidna*, more sparsely in *Proechidna* among the hairs. The snout is prolonged into a slender tube. There is a distinct pinna about an inch long. The limbs bear five toes, two of which in *Proechidna* are often without claws and somewhat rudimentary. In *Echidna* the eggs seem to be hatched in a temporarily developed pouch, which is apparently comparable to a much-expanded mamma of the type seen in the cow.

The Allotheria or Multituberculata include small extinct Mammals (from Triassic to Eocene) with multituberculate molars, e.g. *Plagiaulax*, *Microlestes*, *Tritylodon*. They are often classed with the Marsupials.

Sub-Class METATHERIA, DIDELPHIA, OR MARSUPIALIA

With the exception of the American opossums, and a little-known mouse-like animal (*Canolestes*) from S. America, all the Marsupials now alive are natives of

Australasia. But fossil remains found in Europe and America show that they once had a wide range. As there are no higher Mammals indisputably indigenous to Australasia, it seems as if the insulation of that region had occurred after the Marsupials had gained possession, but before higher mammalian competitors had arrived. Thus saved and insulated, the Marsupials have evolved in many different directions.

The brain is less developed than in Eutherian Mammals, for the convolutions are simple or absent, the anterior commissure is large, the corpus callosum is practically absent. In the skeleton there are several peculiarities: thus the angle of the lower jaw is more or less inflected, except in the genus *Tarsipes*; the jugal reaches far back to share in making the glenoid cavity; there is practically only one set of teeth; there are more incisors above than below (except in the wombat), and the number of incisors sometimes exceeds three on each side. There are usually epipubic or marsupial bones in front of the pubic symphysis. These have no connection with the marsupium, as is evident from the fact that they occur in both sexes; they are sesamoids developed in the inner tendon of the external oblique muscle of the abdomen.

The teeth cannot be readily reduced to the typical Eutherian formula. According to recent research, the milk set is degenerate, and is usually represented only by the last premolar, which in most cases cuts the gum, and is for a time functional. The other teeth correspond to the permanent set of the Eutheria. According to another view, the functional teeth are milk-teeth. In living Marsupials there seems to be a suppression of what in typical placentals would be called the second premolar.

A common sphincter muscle surrounds the anus and the urogenital aperture, and in the majority of cases the anus lies so much within the urogenital sinus that the arrangement may be described as cloacal. The scrotal sac containing the testes lies in front of the penis—a unique position. The genital ducts of the females are often separate throughout, so that there are two uteri and two vaginæ. But the bent proximal parts of the vaginæ sometimes fuse and form a cæcum, which, according to the degree of fusion, may be a single tube or divided by a

partition. Moreover, in Bennett's kangaroo, the cæcum opens independently into the sinus between the apertures of the distal portions of the vaginæ, and forms the so-called third vagina. In *Perameles*, although such a median passage does not exist in the young female, it is formed by a process of rupture at the period of parturition. The true vaginæ are apparently too narrow for the passage of the embryos.

The allantois in *Perameles*, as already seen, forms a true allantoic placenta; in *Phascolarctos* it fuses with the subzonal membrane, becomes highly vascular, and functions as an embryonic respiratory organ, but does not unite with the uterine wall; in all other Marsupials, so far as is known, it is small, only projects slightly into the extra-embryonic body cavity, and is apparently functionless. Accord-

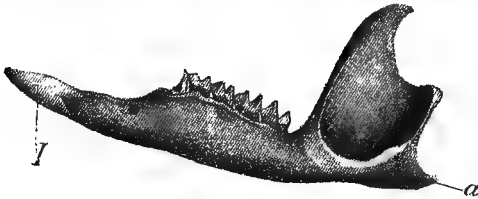

FIG. 404.—Lower jaw of kangaroo.
a., Inflected angle; I., single incisor.

ing to Hill, the condition seen in *Perameles* is primitive, and the other Marsupials show degeneration. The wall of the umbilical vesicle or yolk-sac is highly vascular, and may unite with the uterine wall to form a yolk-sac placenta.

The gestation is short, only lasting a fortnight in the opossum, about five weeks in the kangaroo; whereas that of the mare, for instance, is about eleven months. Except in some opossums, there is a marsupial pouch, usually with a forward-directed aperture. Within this pouch are the teats, and here the delicate young are nurtured after birth. As they are unable to suck, the milk is forced down their throat, the mammary gland being compressed by the cremaster muscle which covers it. Vague vestiges of a marsupium are said to be visible in some Placentals.

Classification of Marsupials.—The Marsupials are divided into two sub-orders, each of which contains four families. The two

sets are defined by the characters of the teeth, which are, of course, adapted to habit. In the members of the first sub-order the incisors are numerous (not less than $\frac{4}{3}$), small, and almost equal in size; while the canines are large, and the molars furnished with sharp cusps. The whole dentition presents a striking resemblance to that of the Eutherian Carnivores. To this group the name Polyprotodontia is applied, and the forms included in it are typically carnivorous or insectivorous. The cæcum is absent or very small.

In the remaining families the incisors are usually $\frac{3}{1}$ in number, and those above are of unequal size, the centre ones being largest. The canines are usually small or absent; the molars are furnished with blunt tubercles, or transverse ridges. To these typically herbivorous forms the name Diprotodont is applied; they are more highly specialised than the Polyprotodonts, and are more modern.

A. POLYPROTODONTIA

1. Family Didelphyidæ.—American opossums, distributed from the United States to Patagonia, arboreal in habit, usually carnivorous or insectivorous in diet. The limbs have five clawed digits; the hallux is opposable. The tail is generally long, and often prehensile. The stomach is simple; the cæcum small. The pouch is generally absent, but the young are often carried on the back of the mother, their tails coiled round hers. Dentition, $\frac{5134}{4134}$.

Examples.—The Virginian or crab-eating opossum (*Didelphys marsupialis*), with a pouch; the woolly opossum (*D. lanigera*); the aquatic Yapock (*Chironectes*), which feeds on fish and smaller water animals.

2. Family Dasyuridæ.—Carnivorous or insectivorous Marsupials. The limbs have clawed digits, five in front, four or five behind. The canines are generally large. The stomach is simple; there is no cæcum.

Examples.—The Tasmanian wolf (*Thylacinus*), of dog-like form, dentition $\frac{4134}{3134}$, and the Dasyure (*Dasyurus*), civet-like, dentition $\frac{4124}{3124}$, are specialised as carnivores. The members of the genus *Phascogale* are small and insectivorous. The banded ant-eater (*Myrmecobius*) of W. and S. Australia, a somewhat squirrel-like animal, has a long thread-like protrusible tongue, and more teeth than any other Marsupial, $\frac{4135 \text{ or } 6}{3135 \text{ or } 6}$. It differs markedly from the other members of the family.

3. Family Notoryctidæ.—This family has been erected for the mole-like Marsupial (*Notoryctes typhlops*), found in the sandy deserts of S. Australia. It lives underground, is a rapid burrower, and in its rudimentary eyes, keeled sternum, and some other respects,

markedly resembles the Cape golden mole. It is thus a good illustration of "convergence," *i.e.* the appearance of similar characters in forms not nearly related, apparently in indirect response to similar conditions of life.

4. Family Peramelidæ.—The burrowing bandicoots, all small in size, insectivorous or omnivorous in diet. In the fore-feet two or three of the middle toes are well developed and clawed, the others being rudimentary; in the hind-feet the hallux is small or absent, the second and third toes are very slender and united in the same fold of skin, the fourth toe is very large, the fifth smaller,—the whole foot suggesting that of the kangaroo. The stomach is simple; the cæcum not large. Clavicles are absent in the adult but present in the fœtus. Dentition, $\frac{4 \text{ or } 5 \times 34}{3 \times 34}$.

Examples.—The true bandicoot (*Perameles*), remarkable for its allantoic placenta; the native rabbit (*Peragale lagotis*); the rat-like *Charopus*.

B. DIPROTODONTIA

1. Family Epanorthidæ.—The selvas, a family of S. American forms, till recently believed to be entirely extinct. The existing forms are included in the genus *Cænolestes*, with two species. They are remarkable in having the upper jaw of the polyprotodont type, and the lower distinctly diprotodont; and also in having all the digits of the hind-foot free, whereas in all other living Diprotodonts certain of these are united by skin (syndactylous). They are probably primitive forms, and their presence in S. America is highly important. There seems little doubt that the Diprotodonts have been evolved in the Australian area from a primitive widely-spread polyprotodont stock. If, therefore, the Epanorthidæ are really allied to the Diprotodonts, their existence in S. America seems to indicate a former connection between that continent and Australia.
2. Family Phascolomyidæ.—The wombats, terrestrial, vegetarian, nocturnal Marsupials, somewhat bear-like in appearance. The dentition is rodent-like, $\frac{1014}{1014}$, the teeth have persistent pulps, the incisors are chisel-edged, there being no enamel except in front. In the embryo, however, there are four upper incisors, of which the first persists, and five lower incisors, of which the third persists. The fore-feet have five distinct toes, with strong nails; the hind-feet have a small nailless hallux, the second, third, and fourth toes partly united by skin, the fifth distinct. The tail is very short. The stomach is simple; the cæcum very short. There is but one living genus—*Phascolomys*, with three species.
3. Family Phalangeridæ.—Small woolly arboreal nocturnal Marsupials, with vegetarian or mixed diet. The fore-feet have five distinct toes; the hind-feet have a large, nailless, opposable hallux, the

second and third toes are narrow and bound together by skin, the fourth and fifth free. The tail is generally long and prehensile. The stomach is simple, the cæcum usually large.

Average dental formula, $\frac{3, 1, 2-3, 3-4}{1, 0, 0-2, 3-4}$.

Examples.—The grey Cuscus (*Phalanger orientalis*); *Tarsipes*, a small mouse-like animal which feeds on honey, and is remarkable in having no inflection of the angle of the mandible and no cæcum; the flying phalangers (*Petaurus*), with a parachute of skin extending from the little finger to the ankle; the Koala, or “native bear” (*Phascolarctos cinereus*), a relatively large form, about 2 ft. in length. An extinct form, *Thylacoleo*, of the late Tertiary period of Australia, is interesting in its extraordinary dentition, the functional teeth being reduced to large front incisors and the third premolars, both adapted for sharp cutting.



4. Family Macropodidæ. — Kangaroos, herbivorous terrestrial Marsupials. Dentition, $\frac{3, 0-1, 2, 4}{1, 0, 2, 4}$. The incisors are sharp, and suited for cropping herbage. The hind-legs are usually larger than the fore-legs, and the animals move by leaps.

Examples. — The true kangaroos, e.g. *Macropus*; the rat-kangaroos or potoroos (*Potorous*); the genus *Hypsiprymnodon*, with a foot approaching that of the Phalangers.

FIG. 405.—Foot of young kangaroo.

2, 3, Small syndactylous toes; 4, large fourth toe; 5, fifth toe.

The true kangaroos, belonging to the genus *Macropus*, include the largest living Marsupials; but within the genus there is much difference in size.

The grey kangaroo (*M. giganteus*) lives on the grassy plains of Eastern Australia and Tasmania, and is as tall as a man; the Wallabies, at home in the bush, are smaller, and some are no bigger than rabbits.

The hind-limbs seem disproportionately long, and are well suited for rapid bounding. The long tail, carried horizontally, helps to balance the stooping body as the animal leaps, and it gives additional stability to the erect pose. The fore-limbs sometimes come to the ground when the animal is feeding, and in the largest species they are strong enough to throttle a man.

The fore-limbs bear five clawed digits; the hind-feet have only four. The hallux is absent; the fourth toe is very long; the fifth is about half as large; the third and second are too slender to be useful for more than scratching, and are bound together by the skin (syndactylous). The length of the hind-limb is due to the tibia and fibula, and to the

foot. The clavicles and fore-arm are well developed. The epipubic or marsupial bones are large.

The kangaroos feed on herbage, and are often hunted down on account of the damage which they do to pastures and crops. The sharp incisors are suited for cropping the grass and herbs, which the ridged and tuberculated molars crush.

As the kangaroos are exclusively herbivorous, it is not surprising to find that the stomach is large and complex, with numerous saccules on its walls. The whole gut is long, and there is a well-developed cæcum.

Numerous fossil forms related to the kangaroos are found in Australia, some considerably larger than the existing forms. The gigantic *Diprotodon australis*, which was as large as a rhinoceros, is related both to the kangaroos and the phalangers. Except the S. American forms already mentioned, Diprotodont marsupials are unknown, either living or fossil, outside the Australian area. Forms related to the Polyprotodonts are, on the other hand, common as fossils in both Europe and America. In S. America, further, fossil marsupials related to the Dasyuridæ occur; and as these are not known elsewhere, their presence affords a further confirmation of the view that Australia and Patagonia were once connected.

Sub-Class EUTHERIA

EDENTATES

The Edentates include a number of very distinct types, which require at least two orders—(a) the New World sloths, ant-eaters, and armadillos; (b) the Old World pangolins and aard-varks. The modern forms are specialised survivors of waning and probably primitive stocks, and they show many interesting protective peculiarities of structure and habit which secure their persistence. Thus some are arboreal, others are burrowers, and many are covered with strong armature.

While the existing sloths, ant-eaters, and armadillos are not nearly related to one another, the numerous fossil Edentates found in S. America connect them to a common stock. It is otherwise, however, with the pangolins and the aard-varks. Some authorities separate them (as *Nomarthra* or *Effodientia*) from the American Edentates (*Xenarthra*); but according to others there is little evidence that the pangolins and aard-varks are related to each other. In view of the uncertainty, it will be readily understood that few "general characters" of Edentates can be given. Almost the only common characters of Edentates concern the dentition. Functional teeth may be absent, but the ant-eaters (*Myrmecophagidæ*) are the only forms which still appear strictly edentulous. When present, the teeth are uniform, usually simple, without roots, and with persistent pulp. They are never present in the very front of the mouth, and they have not

more than hints of enamel. Till recently the dentition was described as monophyodont, but there is evidence of two sets in *Tatusia*, *Orycteropus*, *Dasypus*, and others. It is the milk set which disappears.

A common *primitive* character is the persistence of the testes in the abdominal cavity.

The placenta shows much diversity, but the reproductive phenomena are imperfectly known. In the sloths and ant-eaters the placenta is usually described as dome-shaped; but according to some authorities this is merely a stage in the growth of a placenta, which is at first poly-cotyledonary, and later discoidal. The discoidal deciduate type appears again in the armadillos, but in *Dasypus* among them it is said to be zonary. In the pangolins it is diffuse and indeciduate; in *Orycteropus*, apparently by a suppression of the polar villi of a diffuse type, it is zonary, and doubtfully deciduate.

Order XENARTHRA

1. *Bradypodidæ*—Sloths.—The three-toed sloths (*Bradypus*) and the two-toed sloths (*Choloepus*) are restricted to the forests of S. and Central America. They are the most arboreal of mammals, passing their whole life among the branches, to which they hang, and along which they move back downwards. They are solitary, nocturnal, vegetarian animals, sluggish, as their name suggests, and with a very firm grip of life. Their shaggy hides harmonise with the mosses and lichens on the branches, and the protective resemblance is increased by the presence of a green alga on the hair. Their food consists of leaves and shoots and fruits.

The body is covered with coarse shaggy hair; the head is rounded, and bears very small external ears; the fore-limbs are longer than the hind-limbs, and the two or three digits are bound together by skin, and have long claws; the tail is rudimentary.

Concerning the skeleton we may note the rootless, unenamelled, peg-like teeth, the incomplete zygomatic arch with a descending process from the jugal, the presence of clavicles, the rod-like appearance of the embryonic stapes, the occurrence of nine cervical vertebræ in *Bradypus*, of six in *Choloepus* (but see p. 694). The adult *Bradypus* has sometimes a separate coracoid or epicoracoid.

As in most herbivorous animals, the stomach is complex, but there is no cæcum. In the limbs the main blood vessels break up into numerous parallel branches. The uterus is simple; the vagina seems to be originally divided by a median partition; the placenta is deciduate, and changes in shape during development. One young one is born at a time.

2. *Megatheriidæ* or Ground Sloths—extinct forms of large size, intermediate between the sloths and the ant-eaters. Their remains are found in Pleistocene deposits in N. and S. America. *Megatherium* exceeded the rhinoceros in size. Near the *Megatheriidæ* the recently exterminated or still living *Neomylodon* may be included.

3. Myrmecophagidæ—the Ant-eaters, hairy animals, without even traces of teeth, with long thread-like protrusible tongue, viscid with the secretion of greatly enlarged submaxillary glands. One form, *Myrmecophaga jubata*, is terrestrial; the others, belonging to the genera *Tamandua* and *Cycloturus*, are arboreal. All feed on insects. All are Neotropical. The skull is long; the third finger is greatly developed, the others are small; the pes has four or five almost equal clawed toes; the clavicles are rudimentary; the tail is long and sometimes prehensile. The brain is well convoluted. The uterus is simple: the placenta is dome-like or discoidal.
4. Dasypodidæ—the Armadillos, all S. American except *Tatusia novemcincta*, which extends as far north as Texas. They are nocturnal, omnivorous animals, able to run and burrow rapidly. They are unique among living Mammals in having a dermal armature of bony scutes united into shields and rings, and covered by horny epidermis. The teeth are numerous, simple, and of persistent growth. Clavicles are well developed. The digits have strong claws or nails. The brain has large olfactory lobes; the cerebral hemispheres have few convolutions. The tongue is long and protrusible, and the submaxillary glands are large. The stomach is simple. The uterus is simple; the placenta is discoidal and deciduate, except in *Dasyfus*.
Examples.—*Dasyfus*, *Chlamyphorus*, *Tatusia*.
5. Glyptodontidæ—extinct Pleistocene types, mostly S. American, but represented in Mexico and Texas. The body was often huge, and was covered by a solid carapace of great strength.

Order NOMARTHRA

1. Manidæ—the Ethiopian and Oriental Pangolins, covered dorsally with overlapping horny scales. They are terrestrial, burrowing animals, but sometimes climb trees. They usually feed on termites. Teeth are rudimentary, the tongue is long and protrusible. The uterus is bicornuate; the placenta diffuse and indeciduate. There is one extant genus, *Manis*.
2. Orycteropodidæ—the Ethiopian Aard-varks, represented by two species of *Orycteropus*, ranging from S. Africa to Egypt. They are shy, nocturnal animals, living in burrows, feeding on termites. There are numerous complex teeth, differing in structure from those of any other known Mammal. The skin bears scanty bristles. The mouth is tubular, and the tongue is narrow and protrusible. The digits bear nails suited for digging. The uterus is bicornuate, the placenta broadly zonary. The relation to the other Edentates, or, indeed, to other Mammals, is uncertain.

Order SIRENIA. Sea-Cows

A small decadent order of sluggish, aquatic, vegetarian Mammals, in no direct way connected with Cetaceans, to which they have some superficial resemblance (convergence). There are two living genera, — *Halicore* (Dugong) and *Manatus* (Manatee), and one was recently exterminated (*Rhytina*).

The Sirenia are sluggish, with massive heavy bones, a plump body, some oil, and sparse hair on the thick tough skin. In adaptation to aquatic life, they have a fish-like form, a powerful tail with a "caudal fin," no external trace of hind-limbs, flipper-like fore-limbs, no external ear, valved nostrils at the end of the snout, networks (retia mirabilia) in the arteries (useful in prolonged immersion). They are herbivorous, feeding on algæ and estuarine plants; and, like others of similar habit, have a chambered stomach, a long intestine, and a cæcum.

They are primitive, and with this fact may be associated the abdominal testes, the absence of *distinct* epiphyses on the vertebræ (cf. Prototheria), and the small brain with few convolutions.

The paddle-shaped fore-limbs have, at most, rudimentary nails; the digits have never more than three phalanges, and the elbow and wrist joints are distinctly movable, whereas in the Cetacea the fore-limbs are more or less stiff from the shoulder. There are no clavicles. The skull is not like that of Cetaceans. The nasals are, at most, rudimentary. There are no canine teeth. There are chevron bones below the tail. There are no hind-limbs. The pelvis is rudimentary, and there is no sacrum. In the extinct *Haliitherium* there was a vestigial femur.

The small eyes have imperfect eyelids, but have a nictitating membrane. In the mouth there are horny crushing plates. The ventricles are separated by a cleft. The uterus is bicornuate. Two teats lie behind the armpits. The placenta of the dugong is zonary, wholly or in great part non-deciduate. The placenta of the manatee has not yet been investigated.

MANATEE (<i>Manatus</i>).	DUGONG (<i>Halicore</i>).
<p>Neck vertebræ reduced to six. Abortive incisors ($\frac{2}{2}$) in both sexes.</p> <p>Molars ($\frac{11}{11}$) six or so at a time, uniform, with square enamelled crowns, and tuberculated transverse grinding ridges. Premaxillæ almost straight. Tail rounded. Rudimentary nails on fingers. Cæcum divided. <i>M. australis</i> and <i>M. senegalensis</i> live in the mouths of great rivers which flow into the tropical Atlantic.</p>	<p>The usual seven neck vertebræ. Two tusk-like incisors persist in the male. Molars ($\frac{5}{5}$ or $\frac{6}{6}$, 2 or 3 at a time), primitive, with persistent pulps and no enamel.</p> <p>Premaxillæ crooked downwards. Deeply notched tail. Nailless digits. Thick and single cæcum. <i>H. tabernaculi</i>, E. African coast and Red Sea; <i>H. dugong</i>, Indian and Pacific Oceans, eastward from the home of the last species to the Philippines; <i>H. australis</i>, E. and N. Australia.</p>

The genus *Rhytina* was toothless, with a slightly crooked snout, small head and arms, and thick naked skin. Steller's sea-cow (*R. stelleri*)—the only known species, from the North Pacific—seems to have been exterminated about 1768. The tertiary *Halitherium* had traces of hind-limbs.

Order UNGULATA

Hoofed Animals—Artiodactyla, Perissodactyla, Hyracoidea, Proboscidea, and extinct sub-orders.

This large and somewhat heterogeneous order includes pigs, hippopotamus, camels, cattle, deer, tapirs, rhinoceros, horses, hyrax, elephants, and some other distinct types.

They are terrestrial, and for the most part herbivorous animals. Their digits generally end in hoofs or at least in broad flat nails. In the adults of the modern types there are no clavicles. The teeth are diverse, the milk set in part persistent until the animal attains maturity.

In the typical Ungulates the feet are never plantigrade. In modern types there are never more than four functional toes. The os magnum of the carpus articulates freely with the scaphoid. The brain is well convoluted. The testes descend into a scrotum. The uterus is bicornuate. The

placenta is (a) indeciduate, and diffuse or cotyledonary; or (b) deciduate and zonary.

Ungulata Vera : ARTIODACTYLA and PERISSODACTYLA

ARTIODACTYLA—PIGS, CAMELS, CHEVROTAINS, AND RUMINANTS.	PERISSODACTYLA—TAPIRS, RHINOCEROS, HORSES.
<p>The third and fourth digits of each foot are equally developed, and the line halving the foot runs between them.</p> <p>The premolars and molars are usually different, but generally bunodont or selenodont.</p> <p>There are nineteen dorso-lumbar vertebræ.</p> <p>The femur has no third trochanter.</p> <p>The astragalus has always equal articular facets for the navicular and for the cuboid. The calcaneum has an articular facet for the fibula, if that bone is fully developed.</p> <p>The stomach tends to be complex, and the cæcum is small.</p> <p>The mammae are few and inguinal, or numerous and abdominal.</p> <p>The placenta is diffuse or cotyledonary.</p> <p>There are often bony outgrowths from the frontals.</p> <p>There is no alisphenoid canal.</p>	<p>The third digit occupies the middle of the foot, is largest, and is symmetrical on itself, so that the line halving the foot bisects the third digit.</p> <p>The premolars resemble the molars.</p> <p>There are almost always twenty-three dorso-lumbar vertebræ.</p> <p>The femur has a third trochanter.</p> <p>The astragalus has a large facet for the navicular, a small facet for the cuboid. The calcaneum does not articulate with the lower end of the fibula (except <i>Macrauchenia</i>).</p> <p>The stomach is always simple, and the cæcum is large.</p> <p>The mammae are always inguinal.</p> <p>The placenta is always diffuse.</p> <p>There are never bony outgrowths from the frontals.</p> <p>There is an alisphenoid canal transmitting the external carotid artery.</p>

Sub-Order ARTIODACTYLA. Even-toed Ungulates

Pigs and Hippopotamus (*Suina*), Camels (*Tylopoda*), Chevrotains (*Tragulina*), and Ruminants (*Pecora*) like Cattle and Deer.

The general characters of this sub-order have been stated above in contrast to those of Perissodactyla. The equal development of the third and fourth digits, the fact that the premolars have a single lobe while the molars have two, the

nature of the tarsal bones, the tendency that the stomach has to be complex (as in Camels and Ruminants), are important characteristics. There are others of less obvious importance, such as the absence of the alisphenoid canal, which in Perissodactyla encloses the external carotid artery as it passes along the alisphenoid.

There are primitive extinct Artiodactyla which connect the four modern groups—Suina, Tylopoda, Tragulina, and Pecora. Thus they unite the bunodont types, such as pigs, with cone-like tubercles on the crowns of the molars, and the selenodont types, such as cattle, with the tubercles expanded from before backwards, and curved in crescents.

Group 1. Suina—hippopotamus, pigs, and peccaries. The molars are bunodont; the third and fourth metacarpals and metatarsals are not completely fused as “cannon bones.”

Hippopotamidæ.—Huge African mammals, included in the single genus *Hippopotamus*. They spend the day in the rivers and lakes, swimming and diving well, but usually remaining concealed. At night they come on land and browse on grass and herbage. The skin is extremely thick, with a few hairs restricted to the snout, head, neck, and tail. There are four toes on each foot, all reaching the ground. The rootless incisors continue growing; so do the large curved canines; the dental formula is $\frac{2-3, 143}{1-3, 143}$.

The stomach has three chambers; there is no cæcum.

Suidæ.—The Old World boars and pigs, characterised by the mobile snout and terminal nostrils. There are four well-developed digits on the narrow feet, but the second and fifth do not reach the ground in walking. The incisors are rooted; the upper canine curves outwards or upwards. The stomach is almost simple, but has more or less of a cardiac pouch and several short blind sacculæ; there is a cæcum.

Examples.—*Sus*, $\frac{3143}{3143}$; *Babirusa*, $\frac{2123}{3123}$, the male with remarkable canines, the upper pair growing upwards from their base through the skin, arching backwards as far as the forehead, and sometimes forwards and downwards again, the lower pair with a more or less parallel course; *Phacochærus*, the wart-hog.

Dicotylidæ.—The New World peccaries (*Dicotyles*), with a snout like that of pigs, with four toes on the fore-feet, and three behind. The incisors are rooted, the upper canines are directed downwards, the dental formula is $\frac{2133}{3133}$. The stomach is complex, and there is a cæcum.

Group 2.—Tylopoda, comprising the family Camelidæ—the camels of the Old World and the llamas of S. America. The limbs

are long, with only the third and fourth digits developed; the two metacarpals and metatarsals are united for the greater part of their length, but there is a deep distal cleft; the tips of the digits have very incomplete hoofs, and the animals walk on a broad pad of skin surrounding the middle phalanges. The femur is long and vertical, and the knee is low down. Of the three upper incisors only one persists in adult life, as an isolated sharp tooth, those of the lower jaw are long and slope forwards. There are canines both above and below. The molars are selenodont. The stomach shows a complex rumen with glandular "water-cells," a tubular psalterium, and an abomasum. The

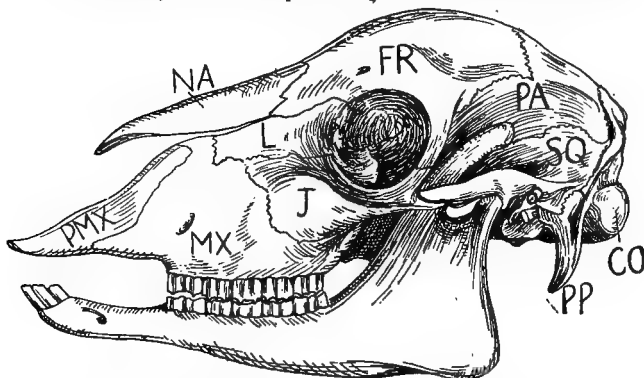

FIG. 406.—Side view of sheep's skull.

PMX., Premaxilla; *MX.*, maxilla; *NA.*, nasal; *J.*, Jugal; *L.*, lacrimal; *FR.*, frontal; *PA.*, parietal; *SQ.*, squamosal; *CO.*, condyle; *PP.*, paroccipital process.

Camelidæ are unique among Mammals in having oval instead of circular red blood corpuscles. The placenta is diffuse.

Examples.—*Camelus*, $\frac{1133}{3123}$, the Arabian camel (*C. dromedarius*)

has a dorsal hump of fat, the Bactrian camel (*C. bactrianus*) has two humps. The camel has a very small area of visible perspiration on the back of the neck, and seems to have a somewhat variable body-temperature, two associated facts which may be adapted to conserving the animal's water-supply in arid countries. The genus *Auchenia*, $\frac{1123}{3123}$, includes the llama, alpaca, huanaco, and vicugna of S. America, smaller forms than the camels, and without humps.

Group 3.—Tragulina or Chevrotains, small animals, "intermediate in their structure between the deer, the camels, and the pigs." There are four complete toes on each foot, but the second and fifth are slender; the third and fourth metacarpals and meta-

tarsals are fused in *Tragulus*, free in the other genus *Dorcatherium*; the fibula is complete. There are no upper incisors, the upper canines are long and pointed, especially in the males; the lower canines are like incisors; the dental formula is $\frac{0133}{3133}$. The Chevrotains ruminates, and the stomach is divided into three chambers, the many-plies being rudimentary. The placenta is diffuse. The Chevrotains are often confusedly associated with the musk-deer (*Moschus*), with which they have no special affinities.

Species of *Tragulus* (smallest among living Ungulates) occur in Indo-Malaya, India, and Ceylon; one species of *Dorcatherium*, of aquatic pig-like habits, is found on the west coast of Africa.

Group 4.—Pecora or Cetylphora — the true ruminants, including deer, giraffes, cattle, and sheep. Only the third and fourth

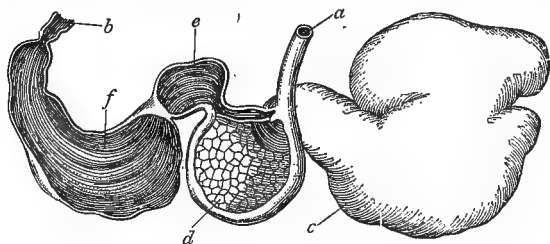

FIG. 407.—Stomach of sheep.—From Leunis.

a, Esophagus; *c*, rumen or paunch; *d*, reticulum or honeycomb-bag; *e*, psalterium or many-plies; *f*, abomasum or reed; *b*, beginning of duodenum.

digits are complete, the fused third and fourth metacarpals and metatarsals form "cannon bones." In the embryos of ox and sheep, the second and fifth metacarpals and metatarsals are also represented; the second metacarpal and fifth metatarsal are unstable and soon disappear; small traces of the fifth metacarpal and second metatarsal persist. The fibula is represented by a small nodular bone articulating with the lower end of the tibia, and forming the external malleolus. There may be in addition a rudiment of the proximal end attached to the upper part of the tibia, but the two parts are never united. Paired outgrowths of the frontal bones are common, capped with horny sheaths in the Bovidæ, deciduous and restricted to the males in almost all Cervidæ. There are no upper incisors, and rarely upper canines; there are three pairs of lower incisors, which bite against the hardened gum above; and the lower canine resembles and is in the same series as the incisors; the typical dentition is

$\frac{0033}{3133}$. The stomach has four distinct compartments. The placenta

is cotyledonary, the villi occurring on a number of distinct patches.

The process of rumination or chewing the cud cannot be understood without considering the complex stomach. It is divided into four chambers,—the paunch or rumen, the honeycomb-bag or reticulum, the many-plies or psalterium, the reed or abomasum. The swallowed food passes into the capacious paunch, the walls of which are beset with close-set villi resembling velvet pile. After the food has been softened in the paunch, it is regurgitated into the mouth, where it is chewed over again and mixed with more saliva. Swallowed a second time, the food passes not into the paunch, but along a muscular groove on the upper wall of the globular honeycomb-bag into the third chamber or many-plies. The honeycomb-bag owes its name to the hexagonal pattern formed by the mucous membrane on its walls. The many-plies or psalterium is a filter, its lining membrane being raised into numerous leaf-like folds covered with papillæ. Along these the food passes to the reed, which secretes the gastric juice. The first three chambers are strictly œsophageal, not stomachic.

Cervidæ—the widely distributed deer, absent only from the Ethiopian and Australian regions. The second and fifth digits are usually represented, often along with the distal parts of the corresponding metacarpals and metatarsals. The upper canines are usually present in both sexes. The horns, if present, are antlers, deciduous, and usually confined to the males. In the reindeer, they are possessed by both sexes. They are outgrowths of the frontal bones, are covered during growth by vascular skin—the velvet—and attain each year to a certain limit of growth. After the breeding season the blood supply ceases, the velvet dies off, and an annular absorption occurs near the base. Then the antlers are shed, leaving a stump, from which a fresh but larger growth takes place in the next year. The earliest (Lower Miocene) deer had no antlers, thus resembling young stags of the first year; the Middle Miocene deer had simple antlers, with not more than two branches, thus resembling two-year-old stags. Thus there is a parallelism between the history of the race and the individual development.

Examples.—*Cervus*, most Old World deer; *Rangifer*, the reindeer; *Alces*, the elk or moose; *Capreolus*, the roe-deer; *Hydropotes*, the water-deer, without antlers; *Moschus*, the musk-deer, without antlers, with long sharp upper canines and large musk glands in the males.

Giraffidæ, represented by the giraffe (*Giraffa camelopardalis*), a tall Ethiopian animal, notable for its enormously elongated cervical vertebrae, and for its long limbs. It is gregarious in its habits, and feeds on the leaves of trees. The lateral digits are entirely absent. The dental formula is $\frac{0033}{3133}$. In both sexes there are on the forehead short erect prominences, over the union of parietals and frontals, which arise from two distinct centres of ossification, but afterwards fuse with the skull. In front of these there is a median protuberance. The Okapi (*Okapia*),

from a West African forest, has a shorter neck, and the horns are on the frontals. It links the giraffe to the extinct *Palæotragus*.

Antilocapridæ, represented solely by the prongbuck (*Antilocapra americana*), a North American animal, with most of the characteristics of Bovidæ. The horny sheath bears one branch, and is periodically detached from the bony core.

Bovidæ, the hollow-horned Ruminants, widely distributed throughout the world, but without indigenous representatives in Australia, South or Central America. The second and fifth digits may be completely absent, but are often represented by minute hoofs and supporting nodules of bone. The frontal appendages, if present, consist of a solid bony core growing from the frontal, and a much longer sheath of horn, which grows at the base as it is worn away at the tip. They are not deciduous, and are usually present in both sexes, though larger in the males.

Examples.—*Antelope, Gazella, Capra, Ovis, Bos.*

Sub-Order PERISSODACTYLA

Horses, Tapirs, Rhinoceros, and their extinct allies.

The middle or third digit of fore- and hind- feet is larger than the others, and symmetrical on itself. It may be the only complete digit, as in the horse, or it may be accompanied by the second and the fourth, and in the fore-foot of tapirs and some extinct forms by the fifth, digit. No modern forms have any trace of the first digit. The astragalus has a pulley-like surface above for articulation with the tibia; its distal surface is flattened and unites to a much greater extent with the navicular than with the cuboid. The last-named bone is of less importance than in the Artiodactyla. The calcaneum does not articulate with the lower or distal extremity of the fibula. The femur has a third trochanter or process for the insertion of muscles. There are usually twenty-three dorso-lumbar vertebræ.

As to the dentition, the premolars and molars form a continuous series, with broad transversely ridged crowns, the last premolars often very like the molars.

The stomach is simple; the cæcum is large; there is no gall-bladder.

The mammæ are inguinal; the placenta is diffuse and non-deciduate.

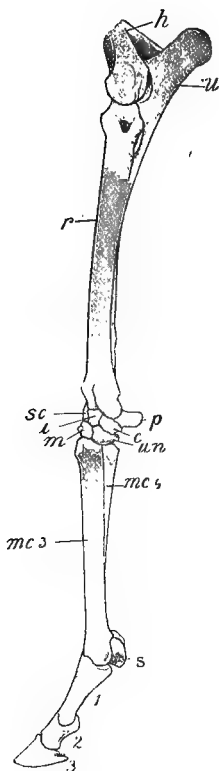

FIG. 408.—Side view of lower part of pony's fore-leg.

h., Distal end of humerus; *u.*, olecranon process of ulna; *r.*, radius; *sc.*, scaphoid; *l.*, lunar; *c.*, cuneiform; *m.*, os magnum; *un.*, unciform; *p.*, pisiform; *mc.4*, splint of fourth metacarpal; *mc.3*, third metacarpal; *s.*, sesamoid; 1, 2, 3, phalanges of third digit.

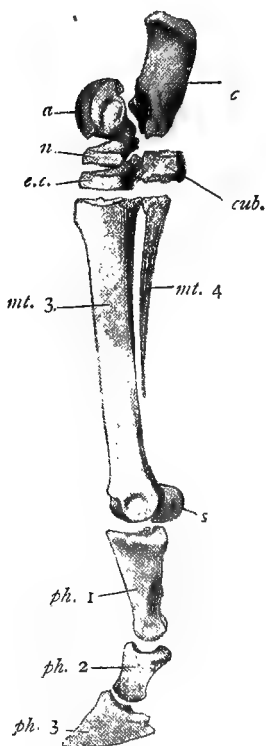

FIG. 409.—Side view of ankle and foot of horse.

a., Astragalus; *c.*, calcaneum; *n.*, navicular; *e.c.*, external cuneiform; *cub.*, cuboid; *mt.3*, third metatarsal; *mt.4*, splint of fourth metatarsal; *s.*, sesamoid; *ph. 1-3*, phalanges of third digit.

Families of Perissodactyla

Family Tapiridæ.—In the Tapirs (*Tapirus*) there are four digits in the manus, but the third finger is still practically median, as the fifth digit scarcely reaches the ground. The hind-foot has three digits. The dentition of the genus is $\frac{3^{14}3}{3^{13}3}$. The orbit and temporal fossa are continuous. The nose and upper lip form a short proboscis. The thick skin has but scanty hair. In habit, the tapirs are shy and nocturnal, fond of forests and water, feeding on tender shoots and leaves. The distribution is somewhat remarkable, for four species live in Central and South America, while a fifth is Malayan. The genus was once widespread, but has survived in these two far-separated regions.

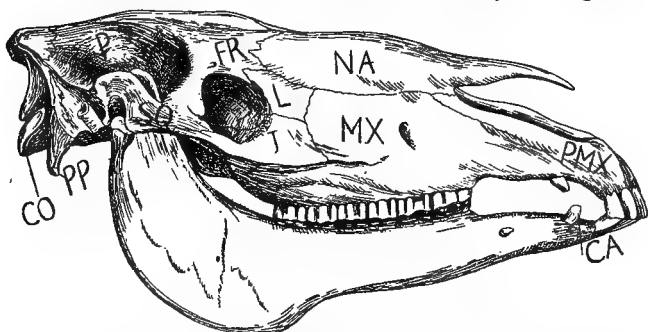

FIG. 410.—Side view of horse's skull.

P., Parietal; FR., frontal; NA., nasal; PMX., premaxilla; MX., maxilla; J., jugal; L., lachrymal; SQ., squamosal; PP., paroccipital process; CO., condyle; CA., canine.

Family Equidæ.—In the modern horses (*Equus*) there is on each foot one functional digit—the third, with splints representing the metacarpals and metatarsals of the second and fourth. Professor Cossar Ewart has demonstrated in the embryo of the horse the rudiments of the three phalanges of the second and fourth digits. The vestigial phalanges of these digits subsequently fuse with one another and with the respective metacarpals or metatarsals, forming “buttons” at the end of the splints. The ulna and fibula are incomplete, but the former is quite complete in the foetus. The dentition is $\frac{3^{14}3}{3^{14}3}$, but the first premolar is rudimentary, and soon lost in both sexes, and the canines are rarely present in the mare. The orbit is complete.

The modern horses are connected by a very complete series of forms with ancestral Eocene types, but it is not clearly proved that these forms were actually in the line of descent of the genus *Equus*. The progress shows an increase of size, a diminution in the number of

digits, an increased folding of the back teeth, and other differentiations. The Eocene *Phenacodus* is regarded by some as near the origin of the stock, it had five complete digits on each foot; *Hyracotherium* and *Systemodon* had only four functional digits in the manus; *Anchitherium* from the Miocene, an animal about the size of a sheep, had three digits, or three and a rudiment; *Hippotherium* and *Protohippus* from the Pliocene were as large as donkeys, and show a marked diminution of the second and fourth digits; in the Pliocene also, the modern forms appeared.

The living species are the horses (*Equus caballus*), apparently originating in Asia, domesticated in prehistoric times, artificially selected

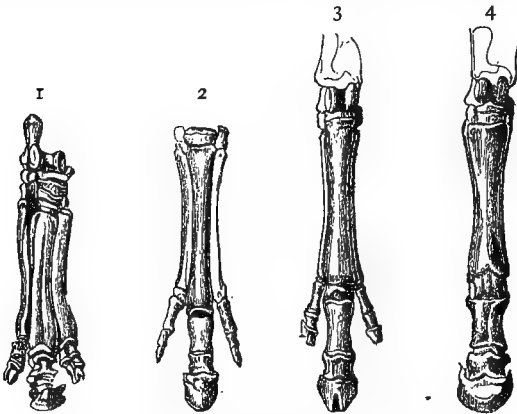

FIG. 411.—Feet of horse and its predecessors.—
From Neumayr.

1, Palæotherium; 2, Anchitherium; 3, Hippotherium; 4, Equus.

into many breeds, sometimes reverting to wildness, as in the case of those imported into America and Australia by European settlers; the wild horse of Central Asia (*E. przewalskii*); the donkey (*E. asinus*) of African origin; the wild asses of Africa and Asia; the striped African species—the zebras and the (exterminated) quagga.

Family Rhinocerotidæ.—There is now but one genus, *Rhinoceros*, species of which occur in Africa and in some parts of India and Indo-Malaya. They are large, heavy Ungulates, shy and nocturnal, fond of wallowing in water or mud, feeding on herbage, shoots, and leaves. The skin is very thick, with scanty hair. One or two median horns grow as huge warts from the snout and forehead. The dentition is very variable, but the back teeth $\frac{4}{4} \frac{3}{3}$ are almost uniform; there are no upper canines, but

sometimes a large lower pair ; there are a few incisors, but these are often small and deciduous.

There are several entirely extinct families of Perissodactyla, such as—*Lophiodontidæ* (Eocene), *e.g. Lophiodon, Hyracotherium, Systemodon*,—a family perhaps ancestral to most of the modern Perissodactyla.

Palæotheriidæ (Eocene to Miocene), *e.g. Palæotherium* and *Anchitherium*.

Other remarkable types—*Lambdotherium, Chalicotherium, Titanotherium*, of elephantine size, and the specialised *Macrauchenia*—are referred to distinct families.

Sub-Order HYRACOIDEA

An isolated order of small Rodent-like Ungulates, represented by *Hyrax (Procavia)* and *Dendrohyrax*, living in rocky regions and on trees in Africa and Syria. The species (14) are adept climbers.

The upper incisors have persistent pulps, and are curved as in Rodents, but they are sharply pointed, not chisel-edged. The outer lower incisors are straight, and have trilobed crowns. There are no canines in the second set, but the upper milk canine sometimes persists ; and there is a wide space between incisors and premolars. The back teeth are very uniform, and like those of Perissodactyla. The milk dentition is $\frac{314}{214}$, the permanent is $\frac{1043}{2043}$. *Hyrax* is one of the few Mammals in which the first premolar is a replacing tooth. The jugal forms part of the glenoid cavity (cf. Marsupials).

In the fore-feet the thumb is rudimentary, the little finger is smaller than the median three, which are almost equal. In the hind-feet, which are like miniatures of those of the rhinoceros, the hallux is absent, and the fifth toe is rudimentary. There are no hoofs in the strict sense. There are no clavicles. The tail is very short.

The brain is like that of Ungulates. The stomach is divided into two parts by a constriction. In addition to the short but broad cæcum, there are two supplemental cæca lower down on the intestine. The testes are abdominal. Of the mammæ, four are on the groin and two are axillary. The placenta is zonary, as in the Proboscidea and Carnivora. A few extinct forms are known.

Sub-Order PROBOSCIDEA

The sub-order is now represented by two species of elephant (*Elephas*). They occupy a somewhat isolated position, though distinctly Ungulates. As regards skull, proboscis, and teeth, they are highly specialised, but their limbs are of a generalised type.

The elephants are confined to the Ethiopian and Oriental regions. They feed on leaves, young branches, and herbage. By means of the mobile proboscis they gather their food, and they drink by filling the proboscis and then ejecting the water into the mouth.

The proboscis is a muscular extension of the nose, and bears the nostrils at its tip. The skin is strong, and the hair somewhat scanty.

In the limbs, radius and ulna, tibia and fibula, are quite distinct; the radius and ulna are fixed in a crossed position; owing to the length of the humerus, and yet more of the femur, and the vertical position in which they are carried, elbow and knee are lower than usual, and the gait is peculiar; the carpal and tarsal bones have flat surfaces; the feet are broad, and bear five hoofed toes embedded in a common integument. There are no clavicles.

The skull is very large, being adapted to support the proboscis and tusks, and to afford a broad insertion for the large muscles. In most of the bones there is during growth an extraordinary development of air-spaces, which communicate with the nasal passages. The supra-occipital is very large; the nasal bones are very short; the zygomatic arch is slender and straight, its anterior part is formed by the maxilla, for the elephant differs from the typical Ungulates in the fact that the jugal merely forms the median part of the zygoma, and does not extend on to the face. The lachrymal is also small, and placed almost entirely within the orbit (cf. the Rabbit).

The dentition is unique. The two upper incisors or tusks are mainly composed of solid ivory; the enamel is restricted to the apex, and soon wears off. As the tusks grow, their roots sink through the premaxillæ into the maxillæ. There are no canines nor premolars. The

molars are very large, and the enamel is very much plaited, forming a series of transverse ridges enclosing the dentine, and united to one another by cement. Thus on the worn tooth there are numerous successive layers of enamel, dentine, and cement. Extinct forms show transitions between this complex type and the horse's tooth. In a lifetime there may be six molar teeth on each side of each jaw, but of these only one, or portions of two, can find space at a time. The series gradually moves forward as the front parts are worn away and cast out.

The brain is highly developed.

The stomach is simple, and there is a large cæcum.

There are two superior venæ cavæ entering the right auricle. The kidneys have several lobes, separated by muscular partitions.

The testes remain abdominal in position.

There are two pectoral-mammæ; the uterus is bicornuate; the placenta is non-deciduate and zonary.

Elephas, $\frac{106}{006}$, now represented by the Indian Elephant (*E. indicus*), with parallel folds of enamel on the molars, and ears of moderate size, and the African Elephant (*E. africanus*), with lozenge-shaped folds of enamel, and very large ears.

The mammoth (*E. primigenius*) belonged to the Pleistocene period, and had a wide geographical range, occurring, for instance, in Britain.

The genus *Mastodon* is represented by fossil remains in Miocene, Pliocene, and even in Pleistocene strata, in Europe, India, and America. The molar teeth show transitions between those of elephants and those of other Ungulates.

In *Dinotherium*, found in Miocene and Pliocene strata in Europe and Asia, the lower jaw bore an enormous pair of tusks projecting vertically downwards, and all the back teeth seem to have been in use at the same time.

SEVERAL EXTINCT SUB-ORDERS

Although we cannot describe the following remarkable types, it is important to notice their existence, for they serve to impress us with the original connectedness of what are now separate orders.

The huge Amblypoda, in Eocene formations in America and Europe, had usually remarkable protuberances on the top of the skull, a very small brain, large upper canines, especially in the males, and six back teeth.

Example.—*Uintatherium* (*Dinoceras*), with no upper incisors.

Some Tertiary American forms, e.g. *Toxodon* and *Nesodon*, varying

in size from that of a sheep to that of a rhinoceros, form the sub-order Toxodontia.

Cope includes a number of generalised Eocene Ungulates under the title Condylarthra. Some seem ancestral to the Perissodactyla and Artiodactyla; some suggest a union of ancestral Ungulates and ancestral Carnivores. The genus *Periptychus* may be regarded as an ancestral Bunodont, and *Phenacodus* as near the origin of the horse stock. But *Phenacodus* is so generalised that Cope suggested affinities between it and not only Ungulates, but also Carnivores and Lemurs.

From the Eocene of N. America, Marsh disintombed a group of animals which he called Tillodontia, e.g. *Tillotherium*, which seem to combine the characters of the Ungulata, Rodentia, and Carnivora.

Few orders of Mammals are of more interest to the palæontologist than the Ungulates. Not only are fossil representatives numerous, but their usually large size, and the fact that the teeth are frequently an index of general structure, makes the determination of affinities much easier than in most cases. In consequence, problems like that of the origin of the horse, or the relations of the different proboscidians, have been worked out with a completeness rare elsewhere.

Order CETACEA

The Cetaceans, including whales and dolphins and their numerous relatives, are aquatic mammals of fish-like form.

The spindle-shaped body has no distinct neck between the relatively large head and the trunk, and tapers to a notched tail, horizontally flattened into flukes. The fore-limbs are paddle-like flippers, and there are no external hints of hind-limbs beyond mere button-like knobs in some embryos. Most forms have a median dorsal fin. Hairs are generally absent, though a few bristles may persist near the mouth. The thick layer of fat or blubber beneath the skin retains the warmth of the body, and compensates for the absence of hair. In one of the dolphins dermal ossicles occur, a fact which has suggested the idea that the toothed whales may have had mailed ancestors. Traces of dermal armour have also been found in the extinct Zeuglodonts.

The spindle shape, the absence of external ears, the absence of an eye-cleansing nictitating membrane, the dorsal position and valvular aperture of the single or double nostril, the sponginess of the bones, the retia mirabilia storing

arterial blood in different parts of the body, may be associated with the aquatic life.

The cervical vertebræ are thin, and more or less fused. There is no union of vertebræ to form a sacrum, for the

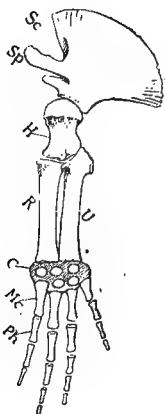

FIG. 412.—Left fore-limb of *Balanoptera*.

Sc., Scapula with spine (*sp.*); H., humerus; R., radius; U., ulna; C., carpals embedded in matrix; Mc., metacarpals; Ph., phalanges.



FIG. 413.—Fore-limb of whale (*Megaptera longimana*).—After Struthers.

hind-limbs are at most very rudimentary. Under the caudal vertebræ there are wedge-shaped chevron bones.

The brain-case is almost spherical; the supraoccipital meets the frontals and shuts out the parietals from the roof of the skull; the frontals arch over the orbit; the snout or rostrum of the skull is composed of premaxillæ, maxillæ,

and vomer, and of the mesethmoid cartilage. The periotic in whales is an exceedingly dense bone, and is of interest because it is the only part of the skeleton found at great depths on the floor of the ocean, and is often preserved as a fossil.

There are at least rudiments of two sets of teeth, as in other Mammals, but in baleen whales only the teeth of the milk set are calcified, and they come withal to nothing, being to some extent replaced by the horny baleen-plates developed on the palate. In toothed whales the two sets are said by Kükenthal to fuse, but the usual interpretation is that the functional teeth belong to the milk set. It is possible that the simple, homodont, conical teeth of *Odontoceti* have resulted from a splitting of more complex cusped teeth. No clavicles are developed. The bones of the fore-limb are flattened, and, except at the shoulder, articular surfaces are not developed, so that the limbs form stiff paddles. The carpals are fixed in a fibrous matrix, tend to be rudimentary, and are often unossified. They cannot be readily compared with the members of the typical mammalian carpus. In the absence of true joints, a slight flexibility is given by the absence of ossification. There are four or five nailless digits, of which the second and third, and sometimes the first, may have more than the usual number of phalanges (see Fig. 413), a peculiarity possibly due to a duplication and separation of epiphyses. The pelvis may exhibit a rudimentary ischium, with small vestiges of femur and tibia.

The rounded brain is relatively large, with well-convoluted cerebral hemispheres.

As to the alimentary system,—salivary glands are rudimentary or absent, the stomach is chambered, the intestine has rarely a cæcum, the liver is but slightly lobed, there is no gall-bladder.

The heart is often cleft between the ventricles. Both arteries and veins tend to form *retia mirabilia*.

The larynx is elongated, so that it meets the posterior nares, and forms a continuous canal, down which air passes from nostrils to lungs. The inspiration and expiration occur at longer intervals than in terrestrial mammals. The water-vapour expelled along with the air from the lungs

condenses into a cloud, which is sometimes increased by an accidental puff of spray.

The kidneys are lobulated. The testes are abdominal. There are no seminal vesicles. The uterus is bicornuate. The placenta is non-deciduate and diffuse. The two mammæ lie in depressions beside the genital aperture, and

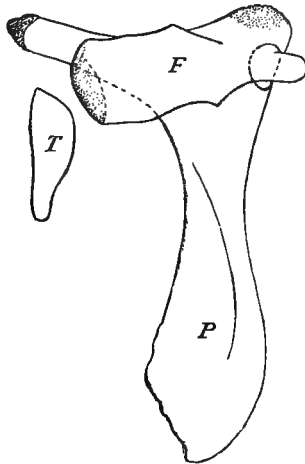

FIG. 414.—Pelvis and hind-limb of Greenland whale (*Balena*).
—After Struthers.

P., Pelvis; *F.*, femur; *T.*, tibia.

the milk is squeezed from special reservoirs into the mouth of the young. Usually a single young one is born at a time, and there are never more than two.

All are carnivorous; but, while many feed on small pelagic animals, other swallow cuttles and fish, and *Orca* attacks other Cetaceans and seals. Most are gregarious, and live in schools or herds.

CONTRASTS BETWEEN THE TWO SUB-ORDERS OF
LIVING CETACEANS

MYSTACOCETI or BALÆNOIDEA, baleen Cetaceans.	ODONTOCETI or DELPHINOIDEA, toothed Cetaceans.
The teeth are absorbed before birth.	The teeth persist after birth, and are generally numerous and functional.
Whalebone or baleen-plates develop as processes from the palate.	There is no baleen.
The skull is symmetrical.	The skull on its upper surface is more or less asymmetrical.
The nasals roof the anterior nasal passages, which are directed upwards and forwards.	The nasals, always small, do not roof the anterior nasal passages, which are directed upwards and backwards.
The maxilla does not overlap the orbital process of the frontal.	The maxilla covers most of the orbital process of the frontal.
The lachrymal is small, and distinct from the jugal.	The lachrymal is fused to the jugal, or is large, and helps to roof the orbit.
The tympanic is ankylosed to the periotic.	The tympanic is not ankylosed to the periotic.
The rami of the mandible are arched outwards, and have no true symphysis.	The rami of the mandible are straight, and form a symphysis.
All the ribs articulate only with the transverse processes of the vertebræ, the capitulum being imperfect.	Several anterior 2-headed ribs articulate by capitula with the centra.
The sternum is a single piece, and articulates with a single pair of ribs; the sternal ribs are not ossified.	The sternum has usually several segments, with which several usually ossified sternal ribs articulate.
The external nostrils are separate.	The nostrils unite in a single blow-hole on the top of the head.
The olfactory organ is distinctly developed.	The olfactory organ is rudimentary or absent.
There is a short cæcum.	There is no cæcum, except in <i>Platanista</i> .
Examples.— The right-whale (<i>Balæna</i>), the hump-back (<i>Megaptera</i>), the roqual (<i>Balænoptera</i>).	Examples.— The sperm-whale (<i>Physeter</i>), the dolphin (<i>Delphinus</i>), the porpoise (<i>Phocæna</i>), the "Grampus" (<i>Orca</i>), the Ca'ing-whale (<i>Globicephalus</i>), <i>Grampus</i> , the narwhal (<i>Monodon</i>), with an enormous tusk in the male.

The two sub-orders of living Cetaceans—the Mysticoceti, without functional teeth, but with baleen-plates on the palate, and the Odontoceti, with functional teeth and without baleen, do not seem closely related, and it may be that many of their resemblances are due to convergence. The toothed whales seem to be the older stock.

The Odontoceti have probably arisen from the Zeuglodonts and these from the Creodonts. Like the Sirenia, the Cetacea appeared in the Lower Eocene and evolved very rapidly, attaining full adaptation by the Mid-Eocene. They found the seas clear of the great Reptiles, and the change from walking to floating led to many readjustments of

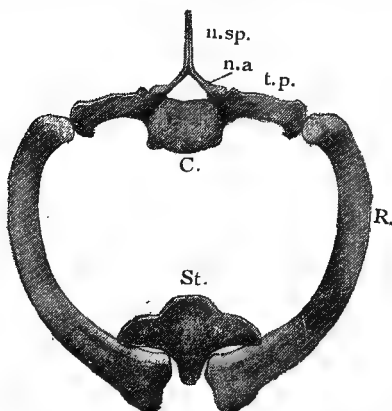

FIG. 415.—Vertebra, rib, and sternum of *Balanoptera*.—
From specimen in Anatomical Museum, Edinburgh.

C., Centrum; *n.a.*, neural arch; *n.sp.*, neural spine; *t.p.*, transverse process; *R.*, rib; *St.*, sternum.

a thoroughgoing sort. It is interesting to notice that flippers must have arisen several times independently—in Ichthyosaurs (post-Triassic), Plesiosaurs, Cetacea (twice?), Sirenia, and Pinnipedia.

Order RODENTIA

Rodents are represented in all parts of the world, and by more species than any other order of Mammals. Most of them are small and terrestrial. They are typically vegetarian, and gnaw their food in a characteristic way.

The dentition is quite distinctive. The incisors are chisel-edged, for, as the enamel is either restricted to the front or is at most thin posteriorly, the back part wears away more

rapidly. The incisors are rootless, growing from persistent pulps, and the same is sometimes true of the bunodont or lophodont back teeth. There is never more than a pair of lower incisors, and in most cases the upper jaw has only a pair. There are no canines, and the skin projects as a hairy pad into the mouth through the gap between incisors and premolars.

The feet are plantigrade or semi-plantigrade, generally with five clawed or slightly hoofed digits. Clavicles, though often rudimentary, are generally present. The scapula has usually a long acromion process, sometimes with a metacromion.

The condyle of the mandible (and the corresponding articular surface for it) is usually elongated, and the jaw moves backward and forward. The mandible has an abruptly narrowed and rounded symphysis, and a very large angular portion. The orbits are confluent with the temporal fossæ. The zygomatic arch is complete, but the jugal is restricted to the middle of it. The premaxillæ are large, the palatines small. There is generally a distinct interparietal bone. The tympanic bullæ are always developed, and often large.

The cerebral hemispheres are almost without convolutions, and leave the cerebellum uncovered. The skin is generally thin, and the panniculus carnosus but slightly developed. The intestine has a large cæcum, except in Myoxidæ. Special anal or perineal or other glands secreting odoriferous substances are frequent.

The testes are inguinal or abdominal; only in the hares and rabbits do they completely descend into scrotal sacs.

The mammæ are on the abdomen, or on the abdomen and thorax. The uterus is double or very markedly bicornuate. There is a provisional yolk-sac placenta; the allantoic placenta is discoidal and deciduate.

The Rodents are very widely distributed, but are most abundant in S. America, where they form a very characteristic part of the fauna. Out of seventeen existing families, nine are represented there, and four are peculiar to it.

The Rodents are divided into four sub-orders:—

1. Sciuromorpha.—Squirrels (*Sciurus*), marmots (*Arctomys*), prairie-dogs (*Cynomys*), and beavers (*Castor*).
2. Myomorpha.—Rats and mice (*Mus*), voles (*Arvicola*), lemmings (*Myodes*), and jerboas (*Dipus*).

3. Hystricomorpha.—Porcupines (*Hystrix*), agoutis (*Dasyprocta*), guinea-pigs (*Cavia*), and the S. American capybara (*Hydrochærus*), the largest living Rodent, measuring about 4 ft. in length.
4. Lagomorpha.—Hares and rabbits (*Lepus*), and the picas or tailless hares (*Lagomys*), with incisors $\frac{2}{1}$.

In the first three sub-orders there is only a single pair of upper incisors, and the three may be united as Simplicidentata, in contrast with the Duplicidentata, where there are two pairs. Only in the latter does the enamel extend to the posterior surface of the incisors, which are also peculiar (in this order) in having well-developed milk predecessors.

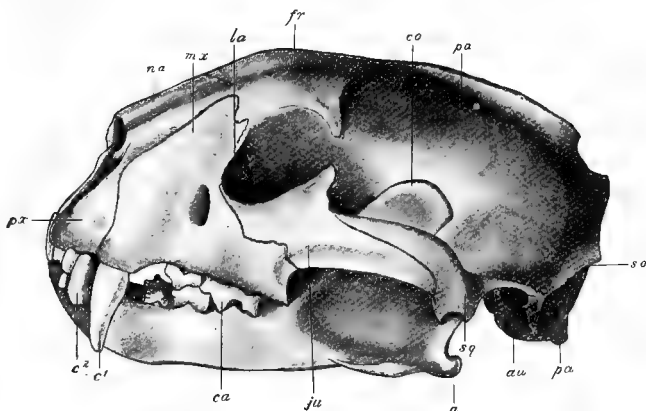

FIG. 416.—Skull of tiger, lateral view.

px., Premaxilla; *mx.*, maxilla. Note the insertion of upper canine (*c.1*) just behind the suture line, and the fact that the lower canine (*c.2*) bites in front of it. *na.*, Nasals; *la.*, lachrymal bone with foramen; *fr.*, frontal; *pa.*, parietal; *so.*, supra-occipital; *pa.*, paroccipital process; *au.*, auditory aperture (the reference line crosses the inflated bulla); *sq.*, zygomatic process of squamosal; *a.*, angle of lower jaw; *ju.*, jugal; *ca.*, carnassial tooth of upper jaw; *co.*, coronoid process of lower jaw.

Order CARNIVORA

This order includes lions and tigers, foxes and dogs, bears and otters, etc.

Most of the Carnivora feed on animal food, and the most typical forms prey upon other animals and devour their

warm flesh. Most are bold and fierce animals, with keen senses and quick intelligence, and often much beauty of form and marking.

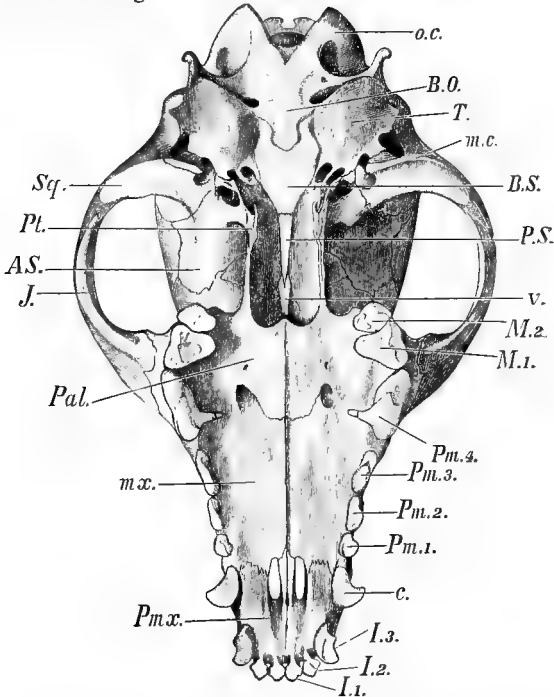

FIG. 417.—Lower surface of dog's skull.

o.c., Occipital condyle; *B.O.*, basioccipital; *T.*, tympanic bulla; *m.c.*, postglenoid process behind fossa for condyle of mandible; *B.S.*, basisphenoid; *P.S.*, base of presphenoid; *V.*, vomer; *M.2*, second molar; *M.1*, first molar; *Pm.1-4*, premolars, the 4th the large carnassial; *c.*, canine; *I.1-3*, incisors; *Pm.x.*, premaxilla; *mx.*, maxilla; *Pal.*, palatine; *J.*, jugal; *A.S.*, alisphenoid; *Pt.*, pterygoid; *Sq.*, squamosal (the reference line points to the glenoid fossa).

Almost all have well-developed claws; there are never fewer than four toes. The teeth are always rooted, except in the case of the tusks of the walrus; the canines are

strong and sharp; some of the back teeth are generally sharp, and specially adapted for cutting.

There are generally strong occipital and sagittal crests for the insertion of muscles of neck and jaw. The glenoid fossa for the articulation of the lower jaw is deeply concave, and bounded by a large postglenoid process, the result being that the lower jaw can only move up and down. This is important, as it minimises the risk of any failure of grip in seizing living prey. The muscles of the lower jaw are very strongly developed, and with this may be associated the strength and the protrusion of the zygomatic arch in the more specialised types. The widening of this arch has prevented the formation of a frontal bridge behind the orbit, so that the orbit is confluent with the temporal fossa. There is a strongly developed and ossified tentorium descending between cerebrum and cerebellum. The tympanic bullæ are in most cases large.

The clavicles are incomplete or absent (an important contrast with all Insectivora except *Potamogale*); the radius and ulna are always distinct; the fibula is slender but distinct. The scaphoid and lunar bones are fused.

The cerebrum is well convoluted, and the cerebellum is more or less covered by the cerebrum.

The stomach is always simple; the cæcum is absent, or short, or simple; the colon is not sacculated.

There are no vesiculæ seminales. The uterus is bicornuate. The mammæ are abdominal. The placenta is deciduate and zonary.

Representatives of Carnivora are found in all parts of the world.

The true Carnivores are for the most part terrestrial. The incisors are almost always $\frac{3}{2}$, the canines are usually large; one of the back teeth is modified as a trenchant carnassial or sectorial. The digits generally have sharp claws, which may be retractile. Within the sub-order there are three sections—Æluroidæ, Cynoidea, and Arctoidea—represented respectively by cat, dog, and bear, but these types are connected by extinct forms.

In retractile claws, the last phalanx of the digit with its attached claw is drawn back into a sheath on the outer side of the middle phalanx in the fore-foot, on the upper side in the hind-foot. When the animal is at rest or is walking, the claw is retained in this bent

position by an elastic ligament, and is in this way protected from wear. When the animal straightens the phalanges, the claws are protruded.

(1) ÆLUROIDEA, <i>e.g.</i> cat, civet, hyæna.	(2) CYNOIDEA, <i>e.g.</i> dog, fox, wolf, jackal.	(3) ARCTOIDEA, <i>e.g.</i> bear, otter.
Digitigrade.	Digitigrade.	Plantigrade or sub-plantigrade.
Typical dentition, $\frac{3131}{3121}$.	Typical dentition, $\frac{3142}{3143}$.	Typical dentition, $\frac{3142}{3143}$.
The tympanic bulla is much dilated, rounded, and thin-walled, and is divided into two chambers by an internal septum (except in Hyænidæ).	The tympanic bulla is dilated, but the internal septum is rudimentary.	The tympanic bulla is often depressed, and there is no hint of an internal septum.
The paroccipital process of the exoccipital is applied to the hinder part of the tympanic bulla.	The paroccipital process is in contact with the bulla, but it is prominent.	The paroccipital process is quite apart from the bulla.
The cæcum is small, rarely absent.	The cæcum is sometimes short and simple, sometimes long and peculiarly folded.	The cæcum is absent.

Digitigrade animals walk on their toes only; plantigrade forms rest the whole sole of the foot on the ground; but between these conditions there are all possible gradations. Many Carnivores are sub-plantigrade often when at rest applying the whole of the sole to the ground, but keeping the heel raised to a greater or less extent when walking.

(1) ÆLUROIDEA—Cat-like Carnivores

Family Felidæ, including the most specialised forms. The canines are large, the molars are reduced to $\frac{1}{2}$, the carnassials are the last premolars above (with a three-lobed blade), and the molars beneath (with a two-lobed blade). The tuberculate upper molars are very small, and of little use in mastication. The skull is generally rounded, the zygomatic arches are wide and strong, and the tympanic bullæ are large and smooth. The limbs are digitigrade, the claws retractile

There is no alisphenoid canal. The dentition of the typical genus *Felis* is $\frac{3131}{3121}$. The cats are the most specialised of all Carnivores, and are exclusively adapted for a flesh diet. The sharp claws and pointed canines form powerful offensive weapons; the cusped cheek-teeth and rasping tongue are employed to separate the flesh from the bones of the prey.

Examples.—The lion (*Felis leo*), in Africa, Mesopotamia, Persia, N.-W. India; the tiger (*F. tigris*), widely distributed in Asia; the leopard (*F. pardus*), in Africa, India, Ceylon, Sumatra, Borneo, etc.; the wild cat (*F. catus*); the Caffre cat (*F. caffra*) of Africa and S. Asia, venerated and mummified by the Egyptians, perhaps ancestral to the domestic cat.

A high degree of specialisation for carnivorous habit is well illustrated by the sabre-toothed tigers (*Machærodus*) of Tertiary ages, whose serrated upper canines were sometimes 7 in. long.

Family Viverridæ—Old World forms, such as civets (*Viverra*), of Africa and India; genets (*Genetta*), of S. Europe, Africa, and S.-W. Asia; ichneumons or mongooses (*Herpestes*), in Spain, Africa, India, Indo-Malaya.

Family Proteleidæ—represented by *Proteles cristatus*, the hyæna-like aard-wolf of S. Africa.

Family Hyænidæ—represented by the genus *Hyæna*, found in Africa and S. Asia. The tympanic bulla is not divided by a septum.

(2) CYNOIDEA—Dog-like Carnivores

Family Canidæ—including forms intermediate between the cats and the bears. The dentition is more generalised than in the Felidæ, its usual formula is $\frac{3142}{3143}$. Within the tympanic bulla there is only a rudimentary septum. The paroccipital process in contact with the bulla is prominent. The cæcum is either short and simple or long and peculiarly folded upon itself.

Examples.—The genus *Canis* has representatives in all parts of the world,—the wolves (*C. lupus*, etc.), the jackals (*C. aureus*, *mesomelas*, etc.), the domestic dogs (*C. familiaris*), the foxes (*C. vulpes*, etc.), the Cape hunting dog (*Lycaon*), the bush-dog (*Icticyon*) of Guiana and Brazil, and the primitive *Otocyon megalotis* from S. Africa. In the dog the dental formula is $\frac{3142}{3143}$; the upper carnassial or fourth premolar has a stout bilobed blade, the lower carnassial or first molar has a compressed bilobed blade. The skull is more elongated than in the cats; the orbits are very widely open posteriorly; the clavicles are very small; the limbs are digitigrade; there are five toes on the fore-feet, but the short thumb does not reach the ground; there are only four toes on the hind-feet, but in domestic dogs the rudiment of the hallux is sometimes enlarged as the “dew-claw”; the claws are non-retractile and blunt.

(3) ARCTOIDEA—Bear-like Carnivores

The tympanic bulla shows no trace of an internal septum; the paroccipital process of the exoccipital is quite apart from the bulla, and widely separated from the mastoid process of the petrotic. The limbs are plantigrade or sub-plantigrade, and always bear five toes. There is no cæcum.

Family Ursidæ—Bears. The molars have broad tuberculated crowns used for grinding. The three anterior premolars are usually rudimentary. The auditory bulla is depressed. In relation to the character of the teeth, it should be noted that the diet is at least in part vegetarian; even the polar bear eats herbs in the summer. *Ursus*, $\frac{3^{142}}{3^{143}}$, absent from Ethiopian and Australian regions, represented in the Neotropical region by only one species, elsewhere widespread.

Family Procyonidæ—The Himalayan Panda (*Ælurus fulgens*), the American raccoon (*Procyon*).

Family Mustelidæ—The otter (*Lutra*), the sea-otter (*Latax lutris*), the skunk (*Mephitis*), the badger (*Meles*), the ratel (*Mellivora*), the marten, sable, polecat, stoat, weasel (*Mustela*).

CREODONTA (extinct)

In Eocene and early Miocene strata, in Europe and America, there are remains of what seem to be generalised Carnivora, ancestral to the modern types, and apparently related to Insectivora as well. Those included in the sub-order Creodonta have strong canines but no single carnassials, while the molars are often like those of Marsupials. The brain seems to have been small.

Examples.—*Hyænodon*, *Proviverra*, *Arctocyon*.

Order PINNIPEDIA. Seals, Eared Seals, and Walruses

Marine Carnivores, unable to move readily on land, but coming ashore for breeding purposes. They feed for the most part on fish, molluscs, and crustaceans. Absent from the tropics, they are represented on most of the coasts in temperate and Arctic zones. Many are markedly gregarious.

The upper parts of the limbs are included within the skin and general contour of the body. There are five well-developed digits connected by a web of skin. In the hind-foot the first and fifth toes are generally stouter and longer than the rest. There are no clavicles. The tail is very short.

The small milk-teeth are absorbed before or immediately after birth. The incisors are always fewer than $\frac{3}{3}$; there are no carnassials; the back teeth have pointed cusps, often sloping slightly backwards.

The cranial cavity is rounded; there is a characteristic interorbital constriction.

The brain is large and well convoluted. The eyes are large and prominent, with a flat cornea. The external ear is small or absent.

The cæcum is very short. The kidneys are divided into lobules. The mammæ are two or four in number, and lie on the abdomen. The young are "precocious."

Family Otariidæ.—Eared or fur-seals, connecting the Pinnipeds with the Fissipeds. The hind-feet can be turned forward and used on land in the normal fashion. The palms and soles are naked. There is a small external ear. The testes lie in an external scrotum.

The sea-lion *Otaria*, $\frac{3, 1, 4, 1-2}{2, 1, 4, 1}$, Pacific and S. Temperate seas.

Family Trichechidæ.—Walruses, intermediate between the Otariidæ and the seals. The hind-feet can be turned forwards and used on land. The upper canines form large tusks; the other teeth are small, single rooted, and apt to fall out; those generally in use are $\frac{1130}{0130}$, but the dentition of the foetus is $\frac{3132}{3131}$.

The jaw seems relatively short, an adaptation perhaps to mussel-crushing instead of fish-catching.

There are no external ears.

The walrus or morse, *Trichechus* (Arctic).

Family Phocidæ.—Seals, the most specialised Pinnipeds. The hind-limbs are stretched out behind, and the strange jumping movements on land are effected by the trunk, sometimes helped by the fore-limbs. The palms and soles are hairy. There are well-developed canines; the upper incisors have pointed crowns; there are $\frac{5}{5}$ back teeth. There is no external ear. The testes are abdominal.

The common seal (*Phoca*), $\frac{3141}{2141}$, the grey seal (*Halichærus*), the monk seal (*Monachus*), the large elephant seal (*Macrorhinus leoninus*).

Order INSECTIVORA

This order includes hedgehog, mole, shrews, and related mammals usually of small size. There is much diversity of type, so that a statement of general characters is very difficult.

Most Insectivores run about on the earth; the mole (*Talpa*), and others like it, are burrowers; *Potamogale*, *Myogale*, and others are aquatic; *Tupaia* and its relatives live like squirrels among the branches.

Most feed on insects; some arboreal forms eat leaves as well; the moles eat worms; *Potamogale* is said to feed on fish.

The body is usually covered with soft fur, but the hedgehog (*Erinaceus*) is spiny, and so to a less extent is *Centetes*, the ground-hog of Madagascar. The digits, usually five in

number, are clawed, and the animals walk in plantigrade or semi-plantigrade fashion. In most, the mammæ are thoracic or abdominal.

The cranial cavity is small; the skull is never high; the facial region is long; the zygomatic arch is slender or incomplete. Except in *Potamogale*, there are clavicles.

There are never fewer than two pairs of lower incisors. The enamelled molars have tuberculated crowns and well-developed roots. In many cases it is not easy to distinguish the usual division of the teeth into incisors, canines, premolars, and molars, but in many the dentition is typical—3, 1, 4, 3 = 44.

In the hedgehog, according to Leche, i. 3, pm. 2, m. 1-3, of the upper jaw, and i. 3, c., pm. 3, m. 1-3, of the lower jaw, are persistent milk-teeth, but, according to others, the milk-teeth are represented by mere rudiments ("prelacteal germs"), and the functional teeth correspond to the permanent set of other mammals.

The cerebral hemispheres are smooth, and leave the cerebellum (and sometimes the corpora quadrigemina) uncovered; the olfactory lobes are large; the corpus callosum is short and thin. Thus, as regards the brain, the Insectivora represent a low grade of organisation.

The stomach is a simple sac; the intestine is long and simple, but the vegetarian forms have a cæcum. In most there are odoriferous glands, axillary in shrews, but usually near the anus.

The testes are inguinal or in the groin, or near the kidneys, not in a scrotum. The penis may be pendent from the wall of the abdomen, but is usually retractile. There is a bicornuate uterus. Several and usually many offspring are born at once.

The allantoic placenta is discoidal and deciduate. There is a provisional yolk-sac placenta.

Insectivora are represented in the temperate and tropical zones of both hemispheres, but not in S. America (except in the Northern Andes) nor Australia. In the former continent their place is taken by the insectivorous opossums.

Examples.—The hedgehogs (*Erinaceus*), throughout Europe, Africa, and most of Asia, dentition $\frac{3133}{2123}$; the shrews (*Sorex*), in

Europe, Asia, and N. America, dentition $\frac{3133}{2013}$; the moles (*Talpa*), throughout the Palæarctic region; the tailless tenrec (*Centetes*) of Madagascar; the S. African golden moles (*Chrysochloris*), probably the most primitive of all Eutheria; the African jumping shrew (*Macroscelides*); the Oriental tree-shrews (*Tupaia*).

Order GALEOPITHECIDÆ

It seems justifiable to recognise a separate order for the very divergent *Galeopithecus*, from the Malay Archipelago and the Philippines. They are arboreal vegetarian animals. The fore- and hind- limbs are connected by a parachute, and the animals can glide from tree to tree, "sometimes traversing a space of seventy yards with a descent of only about one in five." The structure of the incisors is unique among Mammals. They are expanded laterally, compressed from before backwards, and furnished with many cusps. The lower are pectinated, the flattened crowns being penetrated by numerous vertical slits, and the outer of the two upper pairs have double roots. The dentition is $\frac{2123}{3123}$. The molars are multicuspidate. The orbit has an almost complete bony ring. There is a tympanic bulla. The cerebral hemispheres have a few furrows. There is a simple stomach and a large sacculated cæcum. The testes are scrotal, the penis pendulous. There are two pairs of pectoral mammæ, and one young one at a birth.

Order CHIROPTERA. Bats

Bats are specialised Mammals related to Insectivores. They have the power of flight, the fore-limbs being modified as wings. The wing is formed by a fold of skin which usually begins from the shoulder, extends along the upper margin of the arm to the base of the thumb, thence between the long fingers, and along the sides of the body to the hind-legs or even to the tail. Contrasted with the wing of a bird, that of a bat has a rudimentary ulna beside a long curved radius, a wrist with six bones, five free digits, four of which have very long metacarpals, while the thumb is short. The phalanges are usually reduced to two. The pectoral girdle is strong; there is a long curved clavicle, a large triangular scapula, a long coracoid process; the pre-sternum bears a slight keel on which are inserted some of the muscles used in flight. The thumb is always clawed; the other digits are unclawed, except in most frugivorous bats, where the second digit bears a claw.

The hind-limb is relatively short and weak, the pelvic girdle is also weak, and in most cases the pubic symphysis

is loose in the males, unformed in the females. The knee is turned backwards like the elbow; the ankle has a cartilaginous prolongation or calcar, which supports the fold of skin between limb and tail; the five toes are clawed.

The vertebral column is short; there is little mobility between the vertebræ; neural spines are absent behind the third cervical, except in Pteropidæ; the caudal vertebræ are very simple. The ribs are usually flat. The maximum dentition is $\frac{2133}{3133}$; the milk-teeth are very different from the permanent set. All the bones are slender, and the long bones have relatively large medullary canals.

The cerebral hemispheres are smooth, or with few convolutions, and leave the cerebellum uncovered. The spinal cord is at first very broad, but narrows rapidly behind the neck. The sense of touch is remarkably developed in the hot skin of the wing, the large mobile external ears, the whisker hairs of the snout, and in the strange plaited "nose leaves" around the nostrils. Even when deprived of sight, hearing, and smell, bats will fly about in a room without striking numerous wires stretched across it. The stomach is usually simple, but there is a long pyloric diverticulum, filled with coagulated blood, in the blood-sucking *Desmodus*. The whole gut is very short in insectivorous forms. There is never more than a very short cæcum.

The temperature of the body is high. The testes are abdominal or inguinal; the penis is pendent. The uterus is simple, bicornuate, or duplex. There is usually but one offspring at a time, and there are never more than two. The mammæ are two in number, thoracic, generally post-axillary in position. As in Insectivora and Rodentia, the yolk-sac forms a provisional placenta, and the allantoic placenta is discoidal and deciduate. What looks like menstrual flux has been noticed in some bats. In most European bats sexual union occurs in autumn, but the sperms are simply stored in the uterus, for ovulation and fertilisation do not take place till spring—after the winter sleep. In exceptional cases, especially in young forms which were not mature in autumn, pairing occurs in spring.

Fossil Chiroptera occur in Upper Eocene strata, but are quite like the modern forms.

SUB-ORDER MEGACHIROPTERA.	SUB-ORDER MICROCHIROPTERA.
<p>Frugivorous bats, usually large.</p> <p>The molars have smooth crowns, with a longitudinal groove.</p> <p>The thumb is clawed, and generally also the second digit.</p> <p>The tail, if present, is below, not bound up with the interfemoral membrane.</p> <p>The pyloric part of the stomach is in most cases much elongated.</p> <p>Found in warm and tropical parts of the eastern hemisphere.</p> <p>Examples.—</p> <p>The "flying-foxes" or fox-bats (<i>Pteropus</i>), large, tailless bats, distributed from Madagascar to India, Ceylon, Malaya, S. Japan, Australia, Polynesia. The largest species (<i>P. edulis</i>) measures 5 ft. across its spread wings. Dentition, $\frac{2132}{2133}$.</p> <p>In India, <i>Cynopterus marginatus</i> is very common. <i>Xantharpyia ægyptiaca</i> inhabits the Pyramids.</p>	<p>Usually insectivorous bats, small in size.</p> <p>The molars have cusped crowns, with transverse grooves.</p> <p>In the hand the thumb only is clawed.</p> <p>The tail, if present, is bound up with the interfemoral membrane, or lies along its upper surface.</p> <p>Except in one family, the stomach is simple.</p> <p>Found in the tropical and temperate regions of both hemispheres.</p> <p>Examples.—</p> <p>The horseshoe-bats (<i>Rhinolophus</i>); the common pipistrelle (<i>Vesperugo pipistrellus</i>); the genus <i>Vespertilio</i>, with four British species; <i>Vampyrus spectrum</i>, a large Brazilian form, which seems to have been erroneously credited with blood-sucking habits; the common vampire (<i>Desmodus rufus</i>), an American bat—a formidable blood-sucker.</p>

Order PROSIMIÆ (Syn. LEMUROIDEA, Lemurs)

These monkey-like animals are sometimes ranked with monkeys as a sub-order of Primates; but there seems more warrant for placing them in a separate order. They agree with monkeys in many respects, *e.g.* in having pollex and hallux opposable, flattened digits, pectoral mammæ (except in *Chiromys*), and a "Simian fissure" in the brain. They differ from monkeys (Anthropoidea) in the following points: The cranial cavity is usually elongated, and the face more fox-like than monkey-like; the orbit opens freely into the temporal fossa (except in *Tarsius*); the lachrymal foramen lies in front of the orbit; the first pair of upper incisors is separated in the middle line (except in *Tarsius*); the second digit of the foot always bears a pointed claw, but the others usually have flat nails; the cerebral hemi-

spheres are but slightly convoluted, and do not completely overlap the cerebellum (except in *Indrisinæ*); the middle or transverse portion of the colon is almost always folded or convoluted on itself; there may be abdominal and inguinal as well as pectoral mammæ; the uterus is bicornuate; the urethra perforates the clitoris (except in *Chiromys*); the placenta is diffuse and non-deciduate except in *Tarsius*, where it is metadiscoidal and deciduate. Among other features we may note that the Lemurs are plantigrade and usually pentadactyl; the tail (sometimes reduced) is never prehensile; the mandibles are often unfused at the junction; in the Madagascar forms the tympanic remains a half-ring within the bulla which is due to the periotic; the carpus has a centrale usually free; there is a large cæcum without a vermiform appendix; there are often retia mirabilia on some of the arteries and veins.

The lemurs are small, furry quadrupeds, with fox-like faces but the general appearance of monkeys. Most are nocturnal, all arboreal. They feed on fruits and leaves, on eggs and small animals. Most are loud-voiced. They are usually uniparous.

- A. Madagascar Lemurs, with the tympanic annulus free in the bulla. Family Lemurinæ, with long faces. Some have interesting tufts of vibrissæ on the forearm, and a strange forearm gland, with spines in the male. Family *Indrisinæ*, with short faces, cerebrum covering cerebellum. Family *Chiromyinae*, with one type *Chiromys*, the Aye-Aye, highly specialised, e.g. with very long slender third finger, with a flat nail on the thumb only, with rodent-like permanent incisors ($\frac{1113}{1003}$), with inguinal mammæ.
- B. Ethiopian and Oriental Lemurs, with the tympanic sharing in making the bulla. Family *Galaginæ*, with one type *Galago*, with elongated calcaneum and navicular. It occurs right across Africa. Family *Lorisinæ*. Asiatic and African.
- C. The aberrant Indo-Malayan *Tarsius*, with many peculiarities, e.g. the orbit communicates with the temporal fossa only by a fissure, the upper incisors are close together, the calcaneum and navicular are greatly elongated like the calcaneum and astragalus in the frog, the placenta is metadiscoidal and deciduate as in monkeys.

The lemurs are interesting, both because they link the Anthropoidea to lower Mammals, and because of their distribution. In Eocene

times or even earlier they appeared in Europe and N. America, and were then of more generalised type. In the latter continent they became extinct; but in the Old World they appear to have migrated southwards at an early period into Ethiopian and Oriental regions. They reached Madagascar at a time when that island was connected to the continent, and before the advent of the larger carnivores. There they have been isolated and have developed in a fashion comparable to that which has occurred in the case of the Australian Marsupials. Of fifty living species thirty-six are confined to Madagascar, and these are very abundantly represented. Outside of Madagascar lemurs maintain a precarious footing in forests or islands, and are usually few in number. They are handicapped by the absence of defensive weapons, the frequent slowness of movement, and the feeble intelligence; they are saved by their arboreal and usually nocturnal habits, by their quiet movements, and by their shyness.

Order ANTHROPOIDEA (= PRIMATES or SIMIÆ)

This order includes five families.

Family 5.	Hominidæ.	Man.	} Old World Catarrhina. New World Platyrrhina.
„ 4.	Anthropomorphidæ or Simi- idæ.	Anthropoid Apes.	
„ 3.	Cercopithecidæ.	Baboons, etc.	
„ 2.	Cebidæ.	American Monkeys.	
„ 1.	Hapalidæ.	Marmosets.	

The following characteristics are generally true:—

The body is hairy, least so in man; the incisors do not exceed $\frac{2}{2}$; the molars are $\frac{3}{3}$, except in the marmosets, where they are $\frac{2}{2}$; the back teeth are bunodont, the premolars with two cusps, the molars usually with four; the cranial cavity is relatively large; the axis of the orbit is directed forward, and the orbit is closed off from the temporal fossa by ingrowths of frontal and jugal meeting the alisphenoid; the lachrymal foramen is infra-orbital; the clavicles are well developed; the radius and ulna move freely on one another in pronation and supination; the scapnoid, the lunar, and usually the os centrale are distinct; there are usually five fingers and toes, but the thumb may be absent or rudimentary; the thumb (or pollex) if present is opposable except in marmosets; the big toe (or hallux) is opposable.

except in man; the nails are almost invariably flat, except in marmosets; the cerebral hemispheres have in most cases numerous convolutions, and usually cover the cerebellum; the stomach is simple except in *Semnopithecus* and its relatives, in which it is sacculated; there is a cæcum which is often large; there are two mammæ on the breast; the uterus is simple; the testes lie in a scrotum; the penis is pendent; the placenta is metadiscoidal, being developed by the concentration of the villi from a diffuse area into a well-defined disc. Most Anthropoidea are arboreal, gregarious, uniparous, and tropical or sub-tropical.

CONTRAST BETWEEN PLATYRRHINA AND CATARRHINA

The New World Platyrrhina are in many ways so different from the Old World Catarrhina that a twofold (diphyletic) origin of the monkey order is not improbable. There are no transitional forms, and the distribution of the extinct representatives corresponds with that of the living forms.

PLATYRRHINA	CATARRHINA
Broad cartilaginous internarial septum.	Narrow.
Nostril directed outwards.	Downwards.
Tympanic bone not more than a ring. No bony external auditory meatus.	Forms a bony external auditory meatus.
Tympanic bulla.	None.
Alisphenoid usually meets the parietal on the side of the skull, and the orbital plate of the jugal meets the parietal.	Frontal usually meets the squamosal, and the jugal does not meet the parietal, being hindered by the frontal and alisphenoid.
A large orbito-temporal foramen.	Small.
Three premolars.	Two premolars.
Tail often prehensile, with never fewer than 14 vertebrae.	Tail not prehensile, sometimes practically absent.
No cheek-pouches.	Usually present, except in Apes.
No ischial callosities.	Present, except in Gorilla, Orang, and Chimpanzee.

PLATYRRHINA.

CATARRHINA.

- | | |
|--|---|
| No sigmoid flexure in the colon descendens. | A sigmoid flexure. |
| Never more than a slight narrowing at the end of the cæcum, which is usually bent like a hook. | The cæcum is conical; with a vermiform appendix in Apes. |
| No hints of a "secondary discoidal placenta." | A "secondary discoidal placenta" (only hinted at in Anthropoid Apes). |

Family 1. HAPALIDÆ (= Arctopithecini). Marmosets

The marmosets are the smallest monkeys, not much larger than squirrels. They live in companies in the Neotropical forests, especially in Brazil, and feed on insects and fruit.

In addition to the general Platyrrhine characters, the following are noteworthy.

Their dentition, $\frac{2132}{2132}$, is distinctive, for other Anthropeida have $\frac{3}{3}$ molars. The molars have three main tubercles instead of the usual four. The pinna of the ear is very hairy. The tail is long, bushy, and non-prehensile. The pollex is long, but not opposable; all the digits have a pointed claw except the short opposable hallux. The cerebral hemispheres have few convolutions. The marmosets often bear three young ones at a birth, whereas the other monkeys usually bear but one. There are two genera, *Hapale* and *Midas*.

Family 2. CEBIDÆ. American Monkeys

The American monkeys occur throughout tropical America, but are most at home in Brazil. In addition to the general Platyrrhine characters, the following are noteworthy. The tail is long except in *Brachyurus*, and is often prehensile. The digits have nails, not claws; the thumb if present is opposable. The pinnæ are more or less naked. The dentition is characteristic, for there are six back teeth; the formula being 2133. All are uniparous.

Examples.—The howling monkeys (*Myctes* or *Alouata*), with diverticula from the larynx and enormously dilated hyoid, protected by the expanded mandibles; the sakis (*Pithecia*), with very long non-prehensile tail; the spider-monkey (*Ateles*), with exceedingly prehensile tail and a thumbless hand; the capuchins (*Cebus*), often imported into Europe.

Family 3. CERCOPITHECIDÆ (= Cynomorph Catarrhina). Old World Monkeys

The Old World monkeys are plantigrade quadrupeds, and the snout or muzzle often justifies the term Cynomorph or dog-like. Besides the general Catarrhine characters, the following are noteworthy: The sternum is long and narrow; there are 19–20 dorso-lumbar vertebræ; the foramen magnum is directed backwards; the arms are shorter than the legs; the hairs of the arm are all directed towards the hand; the skin forms callosities, often brightly coloured over the ischia; there are usually cheek-pouches; the cæcum is conical and without a vermiform appendix.

In the sub-family Cercopithecinae there are cheek-pouches, the stomach is simple, and the fore- and hind- limbs are almost equal.

Examples.—The African baboons (*Cynocephalus* or *Papio*), e.g. the mandrill (*C. maimon*), notable for the bright colours of the face and hips in the adult males; the macaques (*Macacus*), all Asiatic except the tailless Barbary ape (*M. inuus*) of N. Africa and Gibraltar; the African *Cercopithecus*.

In the sub-family Semnopithecinae there are no cheek-pouches, the stomach is sacculated in a complex fashion, and the hind-limbs are longer than the fore-limbs.

Examples.—The sacred Indian apes (*Semnopithecus*), the African *Colobus*, and the proboscis monkey (*Nasalis*) of Borneo.

Family 4. ANTHROPOMORPHIDÆ or SIMIIDÆ (= Anthropomorph Catarrhina). Anthropoid Apes

This family includes the Gibbons (*Hylobates*), the Orang (*Simia*), the Chimpanzees (*Anthropopithecus*), and the Gorilla (*Gorilla*). As they are most like man, they are called Anthropoid.

Along with the general Catarrhine characters the following are noteworthy: The sternum is short and broad; there are 16–18 dorso-lumbar vertebræ; the arms are longer than the legs; the hairs of the upper arm are directed down-

wards, those of the forearm upwards; except the plantigrade gibbons, the apes tend to walk on the edges of their feet; there are no cheek-pouches; there are no ischial callosities except in gibbons; the cæcum has a vermiform appendix.

The Gibbons (*Hylobates*) live in S.-E. Asia, especially in the Malayan region. The largest attains a height of 3 ft. They walk erect with

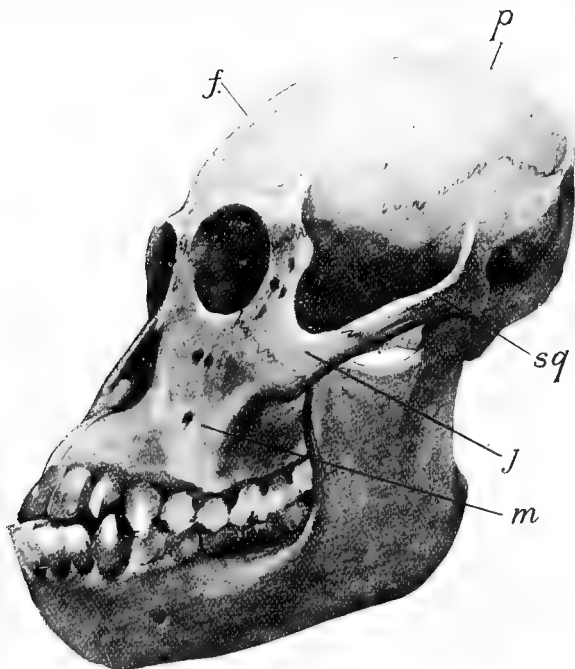

FIG. 418.—Skull of Orang-Utan.

p., Parietal; *f.*, frontal; *sq.*, squamosal; *j.*, jugal; *m.*, maxilla.

the hands reaching the ground. The skull is not prolonged into a vertical crest. There is an os centrale in the carpus. The hallux is well developed. The only flat nails are those of pollex and hallux. There are 13 ribs and 18 dorso-lumbar vertebræ. There are small ischial callosities,—the only instance in Anthropoids. They are mainly arboreal in their habits. They feed on fruits, leaves, shoots, eggs,

young birds, spiders, and insects. Their voice is powerful, and one species (the Siamang) has a laryngeal sac. As regards teeth, the gibbons are most like man. Some authorities rank the gibbons in a separate family apart from the three other Anthropoids.

The Orangs (*Simia*) live in swampy forests in Sumatra and Borneo. The males measure over 4 ft. They walk on their knuckles and on the outer edges of the feet. The skull is prolonged into a vertical crest. There are but slight supra-orbital ridges. The canines are very large. There are twelve ribs as in man, and sixteen dorso-lumbar



FIG. 419.—Skull of gorilla.

vertebræ. The larynx is connected with two large sacs which unite ventrally. They are arboreal in their habits, and make nests in the branches. They are exclusively vegetarian. As regards the structure of the brain, the Orangs are most like man.

The Gorillas (*Gorilla*) live in Western Equatorial Africa. They are larger than all other apes, and larger than man, though not over 5½ ft. in height. The arms reach to the middle of the lower leg, and the animals walk with the backs of their closed hands and the flat soles of their feet on the ground. There are prominent supra-orbital ridges. The canines of the males are very large. The cervical vertebræ bear very high neural spines, on which are inserted the muscles which support the heavy skull. There are thirteen ribs, and seventeen

dorso-lumbar vertebræ. There is no os centrale in the carpus. They live in families in the forest, and feed on fruits. As regards size, the gorillas are most like man. The males are much larger than the females.

The Chimpanzees (*Anthropopithecus*) live in Western and Central Equatorial Africa. They do not exceed a height of 5 ft. The arms reach a little below the knee: They walk on the backs of their closed hands and on their soles or closed toes. The skull has no high crests. The supra-orbital ridges are distinct. The canines are smaller than in gorilla or orang. There is no centrale in the carpus. There are vocal sacs. The chimpanzees live in families in the forest, and are chiefly arboreal, making nests in trees. They seem to feed on fruits. In the sigmoid curvature of the vertebral column the chimpanzees are most like man.

In connection with the anthropoid apes may be noticed *Pithecanthropus erectus*, a new genus erected by Dubois from the top of a skull, some teeth, and a femur found by him (fossil) in Java, and believed to represent a form intermediate between man and the Anthropoid apes.

Family 5. HOMINIDÆ Genus *Homo*

The distinctiveness of man from his nearest allies depends on his power of building up ideas and of guiding his conduct by ideals. But there are some structural peculiarities of interest.

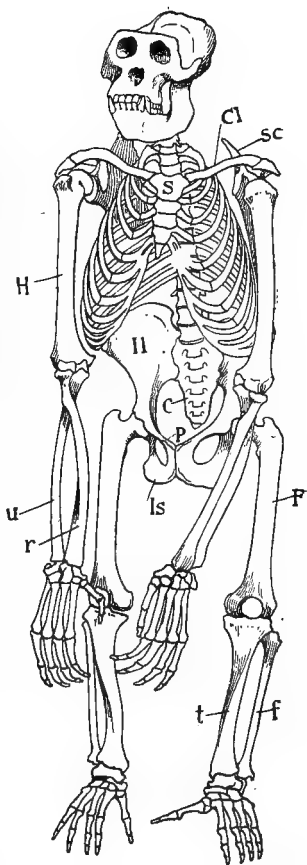

FIG. 420.—Skeleton of male gorilla.

cl., Clavicle; *sc.*, tip of scapula; *S.*, præsternum; *H.*, humerus; *r.*, radius; *u.*, ulna; *Il.*, ilium; *C.*, coccyx; *P.*, pubis; *Is.*, ischium; *F.*, femur; *t.*, tibia; *f.*, fibula.

Man alone, after his infancy is past, walks thoroughly erect. Though his head is weighted by a heavy brain, it does not droop forwards. With his upright attitude the increased command of vocal mechanism is perhaps in part connected. Man plants the soles of his feet flat on the ground; the great toes are often longer, never shorter than the others, and lie in a line with them; he has a better heel than monkeys have. The arms are shorter than the legs. There is no os centrale. There are 12 ribs and 17 dorso-lumbar vertebræ.

Compared with the anthropoid apes, man has a bigger forehead, a less protrusive face, smaller cheek-bones and supra-orbital ridges, no sagittal or occipital crests, projecting nasals, an early disappearance of the suture between premaxilla and maxilla, a true chin (hinted at in the Gibbon), more uniform teeth forming an uninterrupted horseshoe-shaped series without conspicuous canines. The body is very naked; the legs are relatively longer; the hallux is practically non-opposable; there are no vocal sacs; there is at most a vestige of an os penis.

More important, however, is the fact that the weight of the gorilla's brain bears to that of the smallest brain of an adult man the ratio of 2 : 3, and to the largest human brain the ratio of 1 : 3; in other words, a man *may* have a brain three times as heavy as that of a gorilla. The brain of a healthy human adult never weighs less than 31 or 32 oz.; the average human brain weighs 48 or 49 oz.; the heaviest gorilla brain does not exceed 20 oz. "The cranial capacity is never less than 55 cubic in. in any normal human subject, while in the orang and chimpanzee it is but 26 and 27½ cubic in. respectively."

But, as Owen allowed long since, there is an "all-pervading similitude of structure" between man and the anthropoid apes. As far as structure is concerned, there is much less difference between man and the gorilla than there is between the gorilla and the marmoset.

As regards the much-discussed question of a tail in man, it may be noted that if we define a tail as *that part of the body which contains postsacral vertebræ and sundry other parts of primitive caudal segments, and which is, moreover, completely surrounded by integument*, then such tails occur always in early embryos of man, and as abnormalities after

birth. The abnormalities may be either altogether soft or they may contain bone, but in no case adequately known is there any increase in the number of vertebræ which normally fuse to form the terminal portion of the human vertebral column, known as the coccyx.

The arguments by which Darwin and others have sought to show that man arose from an ancestral type common to him and to the higher apes, are the same as those used to substantiate the general doctrine of descent. The *Descent of Man* is the expansion of a chapter in the *Origin of Species*. The arguments may be briefly summarised:—

(1) Physiological. The bodily life of man is like that of monkeys; men and monkeys are subject to similar diseases; various human traits of gesture, expression, etc., are paralleled among the “brutes”; “theromorphic” monsters corroborate the alliance.

(2) Morphological. The structure of man is like that of the anthropoid apes; none of his anatomical distinctions, except that of a heavy brain, are momentous; there are about eighty vestigial structures in his muscular, skeletal, and other systems.

(3) Historical. Certainties in regard to remains of primitive man are few, but his individual development reads like a recapitulation of ancestral history.

To many, man seems too marvellous to have been naturally evolved; to others the evidence seems insufficient; but if the doctrine of descent is true for other organisms, it is likely to be true for man also.

As to the antiquity of the human race, it is certain that men lived in Europe in the later stages of the Ice Age, and there are indications of human life in Pliocene times. No fossil remains are known till the Pleistocene. But, as it is certain that man could not have arisen from any of the known anthropoid apes, and as it is likely that he arose from an ancestral stock common to them and to him, it seems justifiable to date the antiquity of the human race not later than the time when the anthropoid apes are known to have been established as a distinct family. This takes us back to Miocene ages.

If man was naturally evolved, the factors in the process require elucidation, but in regard to these we can only speculate. From what we know of men and monkeys, it

seems likely that, in the struggles of primitive man, wits were of more use than strength. When the habits of walking erect, of using sticks and stones, of building shelters, of living in families began—and they have begun among monkeys—it is likely that wits would grow rapidly. The prolonged infancy, characteristic of human offspring, would help to evolve gentleness. But even more important is the fact that among monkeys there are distinct societies. Families combine for protection; the combination favours the development of emotional and intellectual strength. “Man did not make society; society made man.”

Finally, it is plain that all repugnance to the doctrine of descent as applied to man should disappear when we clearly realise the great truism of evolution, that “there is nothing in the end which was not also in the beginning.”

CHAPTER XXVII

GEOGRAPHICAL DISTRIBUTION OF ANIMALS

As similar animals tend to occur where the conditions of life are similar, we are warranted in speaking of a *pelagic* fauna, an *abyssal* fauna, a *littoral* fauna, and so on. Let us briefly consider this grouping of animals according to their haunts.

Pelagic.—The pelagic fauna includes all the animals of the open sea, both drifters (*Plankton*) and swimmers (*Nekton*). The physical conditions in which they live are very favourable,—there is room for all, sunshine without risk of drought, and an even life throughout the day and throughout the year than is to be found elsewhere except in the abysses of the deep sea. Moreover, the minute pelagic Algæ afford an inexhaustible food-supply to the animals. It is not surprising, therefore, to find that the open sea has been peopled from the earliest times of which the rocks give us any life record.

The fauna is representative, exhibiting great variety of types, from the minute *Noctiluca* which sets the waves aflame in the short summer darkness, to the giants of modern times—the whales. It includes a few genera of Foraminifera, rich in species, most Radiolarians, Dinoflagellata, many Infusorians, Medusæ and Medusoids, Siphonophora and Ctenophora, many “worms,” a few Holothurians, a legion of Crustaceans, a few Insects (Holo-batidæ), such Molluscs as Pteropods, Heteropods, and many of the Cephalopods, such Tunicates as *Salpa* and *Pyrosoma*, many fishes, a few turtles and snakes, besides some well-known birds and mammals. There are also hosts of *larval* forms which are pelagic for a time.

The fauna of the open sea is representative, but there are

few of the types which we can suppose to have lived there always. It may be that forms like the minute water-fleas have been there almost from the first, but most bear the impress of lessons which the open sea could never have taught them.

Pelagic animals tend to be delicate and translucent; many are phosphorescent. The number of species, differing from one another within a relatively narrow range, is often enormous; thus about 5000 species of Radiolarians are known. The huge number of individuals, which frequently occur in great swarms, is equally characteristic. Perhaps both facts indicate that the conditions of life are relatively easy, as is also implied in the limitless food-supply afforded by the unicellular Algæ. The pelagic fauna is richest in the colder seas.

Abyssal.—Through the researches of the *Challenger* and similar expeditions, we know that there is practically no depth-limit to the distribution of animal life, though the population is denser at moderate depths than in the deepest abysses, and though there is probably a thinly-peopled zone between the light-limit and the greatest depths. We know, too, that there are abyssal representatives of most types from Protozoa to Fishes, and that the distribution tends to be cosmopolitan, in correspondence with the uniformity of the physical conditions.

The abyssal fauna includes some Foraminifera and Radiolarians, many flinty sponges, some corals, sea-anemones, and Alcyonarians, a few medusæ, annelids and other "worms" on the so-called red clay, representatives of the five extant orders of Echinoderms, abundant Crustaceans, representatives of most of the Mollusc types, and peculiarly modified Fishes, some with small eyes, others with large eyes, which probably catch the fitful gleams of phosphorescence.

As to the physical conditions, the deep-sea world is in darkness, for a photographic plate is not influenced below 250–500 fathoms; it is extremely cold, about the freezing-point of fresh water, for the sun's heat is virtually lost at about 150 fathoms; the pressure is enormous—thus at 2500 fathoms it is about $2\frac{1}{2}$ tons per square inch; the cold water in sinking from the polar regions brings down much

oxygen ; it is quite calm, for even the greatest storms are relatively shallow in their influence ; there are no plants (except perhaps the resting phases of some Algæ), for typical vegetable life depends upon light, and not even bacteria, otherwise almost omnipresent, are known to flourish in the great depths. A strange, silent, cold, dark, plantless world ! The animals feed upon one another and upon the débris which sinks from above.

We do not clearly know when the colonising of the depths began, but there is much to be said for the view that an abyssal fauna was, at most, scanty before Cretaceous ages. But whensoever the peopling of the abysses occurred, it must have been gradual. It is likely that most of the pioneers migrated outwards and downwards from the shore region (in a wide sense), following the drift of food ; it is possible that others, *e.g.* some Crustaceans, sank from the surface of the open sea. The boreal character of many deep-sea animals has been often remarked, and it is plausible to suppose that there was a particularly abundant colonisation in the Polar regions, and a gradual spreading towards the Equator as the Poles became colder. Perhaps the richness of the fauna at the Equator may be thought of as in part due to the meeting of two great waves of life from the Poles.

The abyssal conditions of life tend to uniformity over vast areas, just as in the open sea. But, on the whole, life must always have been harder in the depths than on the surface. The absence of plants, for instance, involves a keener struggle for existence among animals. Thus, although many abyssal forms, *e.g.* sea-anemones, live a passive sedentary life, waiting for food to drop into their mouths, the majority are less easy-going. The deep sea has been a sterner school of life than the surface.

Littoral.—At a very early date the shores were peopled, and the fauna is very rich and representative. From the strictly Littoral zone, exposed at low tide, with its acorn-shells and periwinkles, limpets and cockles, to the Laminarian zone (to 15 fathoms), with its sea-slugs and oysters, where the great seaweeds wave listlessly amid an extremely keen battle, to the Coralline zone (15–40 fathoms), with its carnivorous buckies, what variety and abundance, what crowding and struggle !

There are Infusorians and Foraminifera, horny, flinty, and calcareous Sponges, zoophytes and sea-anemones, many “worms,” star-fishes and sea-urchins, crabs and shrimps,

acorn-shells on the rocks and sandhoppers among the jetsam, a few insects about high-tide mark, sea-spiders clambering on the seaweeds, abundant bivalves and gasteropods, sea-squirts in their degeneracy, besides fishes, a few reptiles, numerous shore birds, and an occasional mammal. The shore fauna is thus very representative, rivalling in its range that of the open sea, far exceeding that of the abysses.

The conditions of life on the shore are in some ways the most stimulating in the world. It is the meeting-place of air, water, and land. Vicissitudes are not exceptional, but normal. Ebb and flow of tides, fresh-water floods and desiccation under a hot sun, the alternation of day and night, felt much more markedly than on the open sea, the endless variations between gently lapping waves and blasting breakers, the slow changes of subsidence or elevation,—these are some of the vicissitudes to which shore animals are exposed. The shore is rich in illustrations of keen struggle for existence and of life-saving shifts or adaptations, such as masking, protective coloration, surrender of parts, and “death feigning.” We may think of it as a great school where many of the primary lessons of life, such as moving head foremost, were learnt.

Fresh water.—Perhaps the most striking fact in regard to the animals which live in fresh water is their uniformity. The number of individuals in a lake is often immense, but the number of species is relatively small, the number of types still smaller. In widely separated basins and in different countries the same forms occur.

We may distinguish a littoral, a surface, and a deep-water lacustrine fauna. The deep-water forms are chiefly Rhizopods, Turbellarians, Nematodes, Leeches, Chætopods, Amphipods, Isopods, Entomostraca, a few Arachnids, some insect larvæ, and molluscs, and the general opinion is that these are derivable from the shore fauna of the lake, which includes similar forms, along with a few others, such as the fresh-water sponge and Hydra. On the other hand, the surface lacustrine fauna, consisting of water-fleas, Rotifers, Infusorians, etc., widely and uniformly distributed, is said not to be derivable from the shore fauna. In transparency, in gregariousness, in nocturnal habit, and in other ways, they present a marked analogy with the marine Plankton.

How are we to account for their origin and wide distribution?

1. To explain the uniformity, Darwin referred to the birds which carry organisms from watershed to watershed, to the carrying power of the wind, and to changes of land level which bring different river-beds into communication. But this is not enough.

2. It seems very likely that some of the fresh-water forms have migrated from the sea and seashore through brackish water to rivers and lakes. As the possibility of making the transition depends on the constitution of the animal, it is intelligible that similar forms should succeed in different areas:

3. There seems much force in what Credner and Sollas emphasise, that many lakes are dwindling relict-seas of ancient origin. Granted a fairly uniform Pelagic fauna, *e.g.* before Cretaceous times, we can understand that the conversion of land-locked seas into lakes would imply a decimating elimination, and, as the conditions of elimination would be much the same everywhere, the result would be uniformity in the survivors.

Minor faunas.—(a) *Of brackish water.*—We are warranted in speaking of a brackish-water fauna, because of its uniformity in widely-separated regions. It does not seem to be a mere physiological assemblage, varying in each locality, but rather a transition fauna of ancient date, a relic of a littoral fauna once more uniform. The fact is that the power to live in brackish water is not very common; it runs in families.

(b) *Cave fauna.*—In America, thanks very largely to the labours of Packard, about 100 cave animals are known; in Europe the number is about 300, the increase being largely due to the occurrence of about 100 species of two genera of beetles in European caves. In the famous Mammoth Cave of Kentucky, which has over 100 miles of passages, with streams, pools, and dry ground, there are over 40 different species of animals. The temperature is very equable, varying little more than a degree throughout the year; it is, of course, dark; and there are no plants other than a few Fungi. Thus the conditions present some analogy with those of the deep sea. The fauna is of much interest to evolutionists, for we wonder how far the peculiarities of the cave-animals, *e.g.* absence of coloration and frequent blindness, are due to the cumulative effect of the environment and of disuse, or how far they represent the survival of germinal variations, and the result of the cessation of natural selection along certain lines. Have the seeing animals found their way out, leaving only the blind sports, which crop up even in daylight? or is the loss of eyes the result of disuse and absence of stimulus? Or again, if it be granted that pigment is an organic constitutional necessity, *e.g.* a waste product, while coloration is explicable as an adaptation wrought out in the course of natural elimination, then the question arises, whether the cessation of natural selection—a condition awkwardly called “panmixia”—which might account for the disappearance of the coloration when there is no premium set upon it, can also account for the loss of pigment—that is, of a character which was not acquired in the course of natural selection?

(see Beddard's *Animal Coloration*). Our only answer at present is that there is need for experiment.

(c) *Parasitic fauna*.—It seems legitimate to rank together those animals whose habitat is in or on other organisms, from which they derive subsistence, without in most cases killing them quickly, if at all, or, on the other hand, rendering them any service. Among ectoparasites there are such forms as fish-lice and many other Crustaceans, numerous insects such as lice and fleas, and Arachnids such as mites. Among endoparasites there are Sporozoa, some Mesozoa, many Nematodes, most Trematodes, all the Cestodes, many Crustaceans, insect larvæ, and Arachnids.

The parasitic habit implies degeneration (varying according to the degree of dependence), great nutritive security, prolific reproduction, and enormous hazards in the fulfilment of the life history.

Parasitic animals must be distinguished—(a) from epiphytic or epizoic animals which live attached to plants or animals, but are in no way dependent upon them, *e.g.* acorn-shells on Norway lobster; (b) from commensals (p. 178), who live in some degree of partnership, but without in any way preying upon one another, *e.g.* crab and sea-anemone; and (c) from symbions, who live in close partnership, or symbiosis (p. 119), *e.g.* Radiolarians and Algæ. But between these habits there are many gradations, and from close association there is always an easy transition to parasitism.

Terrestrial.—The colonising of dry land has doubtless been a gradual process, as different types wandered inland from the shore, or became able to survive the drying up of fresh-water basins. The fauna includes some Protozoa, *e.g.* *Amæba terricola*, which lives in moist earth, some of the Planarians, Nematodes, Leeches, Chætopods, and other "worms," a few Crustaceans like the wood-lice (*Oniscus*), many insects and Arachnids, a legion of slugs and snails, most adult Amphibians, most Reptiles, many Birds, and most Mammals. Among Vertebrates certain fishes are of interest in having learned to gulp mouthfuls of air at the surface of the water, to clamber on the roots of the mangrove trees, or to lie dormant through seasons of drought. But among Vertebrates, Amphibians were the first successfully to make the transition from water to dry land.

It is important to bear in mind that many a stock may, in the course of its evolution, have passed through a variety of environments. Thus the thoroughly aquatic Cetaceans were probably derived from a land stock common to them and to the Ungulates, and may have passed through a fresh-water stage. Without going farther back, we have here an illustration of the zigzag course of evolution.

We cannot believe in any abrupt transition from the shore to *terra firma*. It has been a slow ascent, slow as the origin of dry land itself. Thus mud-inhabiting worms, dwellers in damp humus, bank-frequenting animals, those which find a safe retreat in rottenness or inside bolder forms, dot the path from the shore inland. Many have lingered by the way, many have diverged into cul-de-sacs, many have been content to keep within hearing of the sea's lullaby, which soothed them in their cradles.

Simroth, in his work on the origin of land animals, seeks to show that hard skins, cross-striped muscle, brains worthy of the name, red blood, and so on, were acquired as the transition to terrestrial life was effected. Let us take the last point by way of illustration. Iron in some form seems essential to the making of hæmoglobin, but iron compounds are relatively scarce and not readily available in the sea; they are more abundant in fresh water, and yet more so as the land is reached. Therefore it is suggested that it was as littoral animals forsook the shore for the land, *via* fresh-water paths, that iron, in some form, entered into their composition, became part and parcel of them, helped to form hæmoglobin or some analogous pigment, and thus opened the way to a higher and more vigorous life.

Aerial.—The last region to be conquered was the air. Insects were the first to possess it, but it was long before they were followed. The flying-fishes vibrated their fins above the foam as they leapt; the web-footed tree-frogs, *Draco volans* with its skin spread out on elongated ribs, and various lizards, began to swoop from branch to branch; some of the ancient Saurians flopped their leathery skin-wings; a few arboreal mammals essayed what the bats perfected; and the feverish birds flew aloft gladly.

Perhaps a keen struggle among insects, or such events as floods, storms, and lava-flows would prompt to flight; perhaps it was the eager males who led the way; perhaps the additional respiratory efficiency, produced by the outgrowth of wings, gave these a new use. Perhaps the high temperature of birds—an index to the intensity of their metabolism—may have had to do with the development of those most elaborate epidermic growths which we call feathers. But we must still be resigned to a more or less ingenious “perhaps.”

Evolution of faunas.—The problem of the evolution of faunas is still beyond solution, but various possibilities may be stated.

(a) According to Moseley, “the fauna of the coast has not only given origin to the terrestrial and fresh-water faunas, it has throughout all time, since life originated, given additions to the Pelagic fauna in return for having received from it its starting-point. It has also received some of these Pelagic forms back again to assume a fresh littoral

existence. The terrestrial fauna has returned some forms to the shores, such as certain shore birds, seals, and the polar bear; and some of these, such as the whales and a small oceanic insect, *Halobates*, have returned thence to Pelagic life."

"The deep sea has probably been formed almost entirely from the littoral, not in the most remote antiquity, but only after food, derived from the débris of the littoral and terrestrial faunas and floras, became abundant in deep water."

"It was in the littoral region that all the primary branches of the zoological family tree were formed; all terrestrial and deep-sea forms have passed through a littoral phase, and amongst the representatives of the littoral fauna the recapitulative history, in the form of series of larval conditions, is most completely retained."

(b) According to Agassiz, Simroth, and others, if one may venture to compress their views into a sentence, a littoral fauna was the original one, whence have been derived, on the one hand, the Pelagic and abyssal faunas; on the other hand, the fresh-water and terrestrial faunas.

(c) According to Brooks, a Pelagic fauna was primitive, whence have been derived the tenants of the shore and the inhabitants of the deep sea. To the latter, however, a possibility of ascending again is not denied.

(d) Sir John Murray has emphasised the importance of "the mud-line"—the lower boundary of the littoral area—as an important headquarters of animal life, and as the area from which the abysses were peopled. The possibilities may be expressed in a diagram.

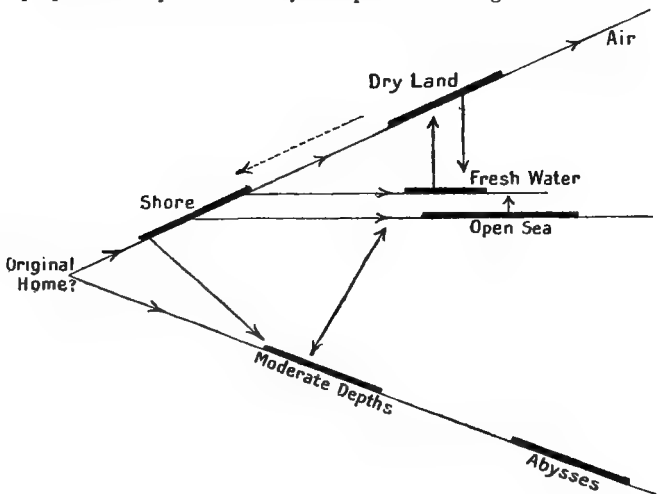

MORE DETAILED PROBLEMS OF GEOGRAPHICAL
DISTRIBUTION

Leaving the general, and at present very obscure, problem of the evolution of faunas, let us briefly notice some of the more detailed questions of distribution. We shall content ourselves with stating (1) a few of the outstanding facts; (2) the factors determining why some animals are here and others there; and (3) the usually recognised zoo-geographical regions.

Outstanding facts.—(a) Widely separated countries may have an essentially similar fauna. Thus, there is much in common between Britain and Northern Japan, and there is so much agreement between the North European (Palæ-arctic) and the North American (Nearctic) fauna, that many unite the two regions in one (Holarctic).

(b) Closely adjacent countries may have quite different faunas. Thus the Bahamas and Florida, Australia and New Zealand, are peopled by very different animals. Two little islands, Bali and Lombok, in the Malay Archipelago, which are separated by "Wallace's Line," a strait only fifteen miles wide at its narrowest part, differ from each other in their birds and quadrupeds more widely than Britain and Japan.

(c) Regions with very different faunas are in many cases connected by transition areas. Thus a journey from the North of Canada to Brazil would show a fairly *gradual* transition from an Arctic to a tropical fauna.

(d) At the same time there are regions whose fauna is exceedingly distinctive and sharply defined. Thus the Mammalian fauna of Australia is distinctively Marsupial, and nowadays the American opossums and *Cœnolestes* are the only Marsupials beyond the Australasian limits.

(e) Another striking fact is the "discontinuous distribution" of certain types, by which we mean that examples of a type may occur in widely separated regions without there being any representatives in the intermediate area. The general explanation is that the type in question once enjoyed a wide distribution, as the rock record shows, and that the conditions favourable to survival have been found in widely separated places. Thus of the genus *Tapir*

there are some four species in South and Central America, while the only other species occurs in Malacca and Borneo. Similarly the Camelidæ are represented by one genus in the Old World and another in South America, and the insectivorous Centetidæ are represented by five genera in Madagascar, and one in Cuba and Hayti.

The factors determining distribution.—There are six factors which combine to determine the particular distribution of an animal. These may be conveniently considered in pairs.

(a) Distribution is in part determined by the constitution of the animal and by the physical conditions of the region. Thus snakes diminish rapidly in numbers towards the poles, their constitution being in most cases ill-adapted to withstand cold; thus crayfishes are absent from districts where the fresh water does not contain sufficient lime salts for their needs.

(b) Distribution is in part determined by the position of the animal's original home (which is often an unknown fact), and by the available means of dispersal. Thus, so far as we know, the Old World has been the exclusive home of the anthropoid apes, and there they have remained; thus bats, being able to fly, have a more cosmopolitan distribution than most other mammals; thus amphibians, being unable to withstand salt water, are absent from almost all oceanic islands.

(c) Distribution is in part determined by the actual changes (geological, climatic, etc.) which have affected different regions, and by 'bionomic' factors, *i.e.* the relations between the animal in question and other organisms, whether animals, plants, or man. Thus it is plain that we cannot understand the fauna of Australia without knowing the geological fact that part of this island was once connected with the Oriental continent by a bridge of land across the Java Sea. The Australasian mammalian fauna consists of survivals and descendants of Mesozoic Marsupials which have been exterminated everywhere else, except the American opossums and *Canolestes*. The original Australian mammals were saved, not by any virtue of their own, but by the earth-change which insulated them. Similarly, it is the geologist who helps us to understand the faunal diversity on the two sides of "Wallace's line," or the absence of amphibians, reptiles, and mammals from the Canaries. That much will also depend on the animal's power of surviving the struggle for existence in different regions is too obvious to require exposition. We need only think of the way in which man has in a few years altered the distribution of many birds and mammals, sometimes indeed reducing it to *nil*, or increasing it with disastrous results.

To sum up: the chief factors determining geographical distribution are—(1) the constitution of the animal, (2) the physical conditions of the region, (3) the position of the original home, (4) the means of dispersal, (5) the historical

changes of the earth and its climate, and (6) the bionomic relations.

Zoo-geographical regions.—I shall simply quote a paragraph from Professor Heilprin's work, *The Geographical and Geological Distribution of Animals* (Internat. Sci. Series. London, 1887), a very valuable book for the student, especially as it considers distribution in space and time together.

"By most naturalists (Wallace, Sclater, and others) the terrestrial portion of the earth's surface is recognised as consisting of six primary zoological regions, which correspond in considerable part with the continental masses of geographers. These six regions are—

"1. The *Palæarctic*, which comprises Europe, temperate Asia (with Japan), and Africa north of the Atlas Mountains; also Iceland, and the numerous oceanic islands of the North Atlantic;

"2. The *Ethiopian*, embracing all of Africa south of the Atlas Mountains, the southern portion of the Arabian Peninsula, Madagascar, and the Mascarene Islands, and which, consequently, nearly coincides with the Africa of geographers;

"3. The *Oriental* or Indian, which embraces India south of the Himalayas, Farther India, Southern China, Sumatra, Java, Bali, Borneo, and the Philippines;

"4. The *Australian*, comprising the continent of Australia, with Papua or New Guinea, Celebes, Lombok, and the numerous islands of the Pacific;

"5. The *Nearctic*, which embraces Greenland, and the greater portion of the continent of North America (excluding Mexico);

"6. The *Neotropical*, corresponding to the continent of South America, with Central America, the West Indies, and the greater portion of Mexico."

Professor Heilprin makes several modifications on this scheme of distribution: (*a*) uniting Palæarctic and Nearctic in one Holarctic realm; (*b*) establishing a special Polynesian realm for the scattered island groups of the Pacific; and (*c*) defining three transition regions—(1) around the Mediterranean, intermediate between Palæarctic, Ethiopian, and Oriental, (2) Lower California between Western Hol-

CHAPTER XXVIII

THEORY OF EVOLUTION

IN Chapter VI. we indicated the nature of the evidence which has led naturalists to accept the doctrine of descent as a modal interpretation of organic nature. The data of physiology and morphology, combined with what is known of the history of the race and the development of the individual, have led us to believe that the forms of life now around us are descended from simpler ancestors (except in cases of degeneration), and these from still simpler, and so on, back to the mist of life's beginnings. In other words, we believe that the present is the child of the past and the parent of the future. This is the general idea of evolution.

But while this general idea, which is a very grand one, is usually recognised as the simplest interpretation of the facts, we remain in doubt as to the *factors* of the process by which the world of life has come to be what it is. This uncertainty is in part due to the complexity of the problem, in part to the relative novelty of the inquiry—for precise ætiology is not yet fifty years old—in part also to the fact that, while there has been much theorising, there has been comparatively little experimenting or connected observation as to the modes and causes of evolution.

With the exception of Dr. Alfred Russel Wallace and a few others, who believe that it is necessary to postulate spiritual influxes to account for certain obscure beginnings, *e.g.* of the higher human qualities, evolutionists are agreed in seeking to explain the evolution of plants and animals as a continuous "natural" process, the end of which was implicit in the beginning. In so doing, they follow the method of analysis, endeavouring to explain the facts in their lowest terms. But as the biologist's lowest term is

living matter, and as one aspect of this is, in favourable conditions, known as thought, there is no reason to call the evolutionist's analysis "materialistic"—if anything opprobrious be meant by that adjective. The common denominator of the biologist is as inexpressibly marvellous as the philosopher's greatest common measure—if, indeed, the two are not practically the same.

Two great problems.—Our uncertainty in regard to the factors of evolution is so great that I cannot venture here to do more than indicate (*a*) what the great problems are, and (*b*) the general drift of the most important suggestions which have been made towards their solution.

The two great problems before the evolutionist are:—

- (1) What is the nature and origin of variations, *i.e.* of those organic changes which make an organism appreciably different from its parents or its species?
- (2) What are the directive factors which may operate upon given variations, determining their elimination or their persistence, and helping towards the familiar but puzzling result—the existence of distinct and relatively well-adapted species?

Secure answers to these two questions must be found in reference to the present; as our data accumulate, it will be more possible to argue back to the past.

It may be convenient to speak of the factors which *cause* variation as *primary* or *originative*, and of the factors which operate upon or *direct* the course of variation as *secondary* or *directive*. As far as practical results are concerned, the two sets of factors are of equal importance.

Nature of variations.—We mean by variations those changes in organisms which make them appreciably different from their parents or from their species.

The term of course includes not only material differences, but also those whose only demonstrable expression is psychical. Thus an increase in maternal affection is as important and real a variation as the sharpening of a canine tooth.

It may also be useful to distinguish variations in size, symmetry, number of appendages, and so on, from more *qualitative* variations in chemical composition, such as the

appearance of a new pigment ; but this distinction is only a matter of convenience, as it is only a matter of degree.

Again, variations occur which may be called *continuous*, being merely minute increments or diminutions of certain parental or specific characters. These are related to one another much in the same way as are the successive stages in the continuous growth of an individual.

But other variations occur which deserve to be called *discontinuous*. For, without the appearance of transitional stages, marked variations crop up, reaching with apparent suddenness to what must be called *new*, and may withal exhibit a measure of perfectness.

That both kinds of variations occur is a fact of life ; the possibility of both is probably a primary quality of organisms ; but we are only beginning to know the relative frequency of the two kinds and their respective limits (see Bateson's *Materials for the Study of Variation*, 1894, and De Vries's *Species and Varieties*, 1905).

Primary or originative factors.—What causes variation ? This is the fundamental question, but it is the least answerable.

It is, indeed, an axiom or a truism that changes in any animate system are evoked by changes in the larger system of which the organism forms a part. In other words, the *stimulus* to organic change must always be ultimately traceable to the environment ; but this is implied in our conception of living matter, and does not help us to understand the immediate conditions which lead to the change.

In the absence of sufficiently precise data, we can do little more than point out various possibilities :—

(a) *Changes due to Environment* (= *Environmental Modifications*)

There is abundant proof that changes in surrounding pressure, in the chemical composition of the medium, in food-supply, in heat, light, etc., may be followed by changes in the organism upon which these influences play. Changes in the body of the organism follow changes in the environment. But (1) it is difficult to discriminate between changes which may be spoken of as the direct results of environmental influence, and those to which the organism

was already definitely predisposed, and to which the environmental change supplied only the stimulus. (2) We have not at present sufficient data to enable us to state that changes arising in or acquired by the *body* of an individual organism as the result of surrounding change do as such in any degree specifically affect the reproductive cells. In other words, we cannot at present say that "environmental modifications" are transmissible. And if they are not, their importance in evolution is only indirect.

(b) *Changes due to Function (= Functional Modifications)*

It is an undoubted fact that the bodily structure of an animal may be changed by the increased use of certain parts, or the disuse of others,—in short, by some change of function, which may be directly prompted by some change in the external conditions of life. But important as these functional changes and their results are to the *individual*, we are uncertain as to their importance for the *race*, for we do not know to what extent (if any) the results are transmissible.

(c) *Variations due to Changes in the Germ Cells*

In many cases of variation, particularly those which appear in early life, it is not possible to suggest any environmental or functional condition which may be regarded as the stimulus or the cause. We are led in such cases to believe that the variation in bodily structure or habit is the expression of some novelty in the protoplasmic constitution of the germ cells. Then, hiding our ignorance, we say that the variation is germinal, constitutional, congenital, or blastogenic. It seems to lead to clearness if we call these germinal changes and their results *variations*, keeping the term *modifications* for those changes [(a) and (b)] wrought upon the body as the result of environmental or functional influences.

But why should there be changes in the germ cells? Perhaps because living matter is very complex and unstable, and because it is of its very nature to differentiate and integrate and *grow*; perhaps because the immediate environment of the germ cells (blood, body cavity fluid, sea-water, etc.) is complex and variable. Moreover, every

multicellular organism, reproduced in the usual way, arises from an egg-cell fertilised by a spermatozoon, and the changes involved in and preparatory to this fertilisation, or "amphimixis," may make new permutations and combinations of living substances or vital qualities not only possible but necessary.

Secondary or directive factors.—1. *Natural Selection.*—The distinctive contribution which Charles Darwin and Alfred Russel Wallace made to ætiology was their theory of Natural Selection.

By natural selection is meant that process whereby, in the ordinary course of nature, certain organisms, *e.g.* certain members of the same species, are more or less rapidly and discriminately eliminated, while others are allowed to survive.

That some forms, *e.g.* in one family, should succeed less well than others, depends obviously on the fact that all are not born alike,—depends, in other words, on the fact of variation.

That there should be elimination is necessary—(*a*) because a pair of animals usually produce many more than a pair, and the population tends to outrun the means of subsistence; and (*b*) because organisms are at the best only relatively well adapted to their conditions of life, which are variable. These two primary facts and their subsequent consequences, *e.g.* that some animals feed upon others, that there may be more males than females, etc., render some struggle for existence necessary, though this phrase must be used, as Darwin said, "in a wide and metaphorical sense," including all endeavours for the well-being, not only of the individual, but of its offspring.

The facts then are—that variations constantly occur, that some members of a species or family are necessarily less fitly adapted than others, and that the course of nature is such that these relatively less fit forms will tend to be eliminated, while the relatively more fit will tend to survive. As many variations reappear generation after generation, and may become gradually increased in amount, the continuance of the selective or eliminating process will work towards the origin of new adaptations and new species.

The importance of natural selection as a secondary

factor in evolution will vary according to stringency of the eliminating process, and it must be noted that the "struggle for existence" varies in intensity within wide limits, that it requires to be investigated for each case, and cannot be postulated as a force of nature.

The importance of the factor will also depend on the number, nature, and limits of the variations which occur. Thus a new species might arise, either by the occurrence of a discontinuous variation of considerable magnitude, or by the eliminating process acting for many generations on a series of minute continuous variations.

Darwin also believed in the importance of sexual selection, in which the females choose the more attractive males, which, succeeding in reproduction better than their neighbours, tend to transmit their qualities to their numerous male heirs. But this and other forms of reproductive selection may be regarded as special cases of natural selection.

2. "*Isolation.*"—Under this title, Romanes, Gulick, and others include the various ways in which free intercrossing is prevented between members of a species, *e.g.* by geographical separation, or by a reproductive variation causing mutual sterility between two sections of a species living on a common area. Without some "isolation" tending to limit the range of mutual fertility within a species, or bringing similar variations to breed together, a new variation is liable, they say, to be "swamped" by intercrossing. But definite facts as to this "swamping," and in many cases as to the alleged "isolation," are hard to find, nor can we say that a strong variation will not persist unless it be "isolated." In fact, much evidence has been gathered in recent years which shows that certain kinds of variations are very strongly heritable and do anything but "blend." Romanes' view, however, was that "without isolation, or the prevention of free intercrossing, organic evolution is in no case possible. Isolation has been the universal condition of modification. Heredity and variability being given, the whole theory of organic evolution becomes a theory of the causes and conditions which lead to isolation." It must be admitted that some forms of isolation lead to inbreeding, and this to "prepotency," which often implies the persistence of individual variations.

SUMMARY OF EVOLUTION THEORIES

(Axiom or Truism.)				
Changes are all ultimately due to the External Influences and the Nature of the Organism, <i>i.e.</i> of Protoplasm.				
Primary (Originative) Factors.	<p>(<i>Environment.</i>)</p> <p>Changes in the environment are followed by changes in the organism, either — or (<i>b</i>) in (<i>a</i>) in its its germ body, cells, or (<i>c</i>) in (<i>b</i>) through (<i>a</i>) (?).</p>	<p>(<i>Organism.</i>)</p> <p>Germinal variations arising from the nature of protoplasm, or from changes in the nutritive environment of the germ cells, or from the changes necessarily associated with fertilisation, may be continuous or discontinuous, quantitative or qualitative, etc.</p>	<p>(<i>Function.</i>)</p> <p>Use and disuse of parts, or change of function (due to change of environment or to germinal change), are followed by changes in—(<i>a</i>) the body of the organism, or (<i>b</i>) in the germ cells, either directly or (?) through (<i>a</i>).</p>	Origin of Changes.
	<p>(<i>Result of (a) "Environmental Modifications."</i>)</p>	<p>(<i>Variations.</i>)</p>	<p>(<i>Result of (a) "Functional Modifications."</i>)</p>	
	<p>Degree of transmissibility unknown.</p>	<p>Transmissible.</p>	<p>Degree of transmissibility unknown.</p>	
Secondary (Directive) Factors.	<p>Such environmental <i>modifications</i>, IF transmissible, and if the originating conditions persist for some time, might perhaps give rise to new species, especially if favoured by natural selection and isolation. In the individual lifetime they may serve to shield the incipient stages of <i>variations</i> in a similar direction.//</p>	<p>Such variations probably supply the usual material for the origin of new species, for the establishment of which, more or less natural selection (elimination) and isolation must be necessary, according to the nature of the variation.</p>	<p>Such functional <i>modifications</i>, IF transmissible, and if the originating conditions persist for some time, might perhaps give rise to new species, especially if favoured by natural selection and isolation. In the individual lifetime they may serve to shield the incipient stages of <i>variations</i> in a similar direction.</p>	Origin of Species.

APPENDIX

SOME ZOOLOGICAL BOOKS

INTRODUCTORY :—

- F. Jeffrey Bell, "Comparative Anatomy and Physiology."
- C. Lloyd Morgan, "Animal Biology."
- T. Jeffery Parker, "Elementary Biology."
- T. J. Parker and W. A. Haswell, "A Manual of Zoology."
- J. Arthur Thomson, "The Study of Animal Life."
- J. G. Needham, "General Biology."
- O. Latter, "Natural History of Common Animals."
- R. Lulham, "Introduction to Zoology."
- M. I. Newbigin, "Life by the Seashore."
- F. W. Gamble, "Animal Life."
- J. Graham Kerr, "Zoology."
- Huxley's "Crayfish."
- Milne Marshall's "Frog."

TEXT-BOOKS OF ZOOLOGY :—

- T. H. Huxley, "Anatomy of Invertebrates" (1877), and "Anatomy of Vertebrated Animals" (1871).
- T. J. Parker and W. A. Haswell, "Text-Book of Zoology" (2 vols., Lond. 1898).
- Hatchett Jackson's edition of Rolleston's "Forms of Animal Life" (Oxford, 1888).
- A. Sedgwick, "Student's Text-Book of Zoology," Part I. (Lond. 1898), Part II. (1905), Part III. (1909).
- Shipley and MacBride, "Zoology, an Elementary Text-Book."
- G. C. Bourne, "An Introduction to the Study of the Comparative Anatomy of Animals."
- J. Ritzema Bos, "Agricultural Zoology" (translated by Davis, Lond. 1894).
- Borradaile, "Text-Book of Zoology."

BOOKS AS GUIDES TO PRACTICAL WORK :—

- C. Vogt and E. Yung, "Traité d'Anatomie Comparée pratique" (Paris, 1885-95); also in German.
- T. J. Parker, "Zootomy" (Lond. 1884).
- T. J. and W. N. Parker, "Practical Zoology."

Huxley and Martin, "Practical Biology."

A. Milnes Marshall and C. H. Hurst, "Practical Zoology."

W. K. Brooks, "Handbook of Invertebrate Zoology for Laboratories and Seaside Work" (Boston, 1882).

Monographs on Sea-urchins, Lob-worm, Limpet, Ascidian, etc., published by Liverpool Biological Committee (Williams & Norgate, London).

A. Bolles Lee, "Microtomist's Vade-Mecum" (4th ed., 1896).

M. F. Guyer, "Animal Micrology" (Chicago, 1909).

G. B. Howes, "Atlas of Practical Elementary Biology" (Lond. 1885).

GENERAL MORPHOLOGY :—

Ernst Haeckel, "Generelle Morphologie" (Berlin, 1866), reprinted in condensed form, 1906.

Herbert Spencer, "Principles of Biology" (London, 1864-66).

W. His, "Unsere Körperform" (1875).

G. Jaeger, "Allgemeine Zoologie" (1878).

P. Geddes, article "Morphology" ("Encycl. Brit.").

CLASSIFICATION, see :—

E. Ray Lankester, article "Zoology" ("Encycl. Brit.").

W. A. Herdman, "Phylogenetic Classification of Animals."

H. Gadow, "Classification of Vertebrata" (1898).

Articles in last edition of "Encyclopædia Britannica."

WORKS ON COMPARATIVE ANATOMY :—

Richard Owen, "Comparative Anatomy of Vertebrate Animals" (4th ed., 1871).

T. H. Huxley, *op. cit.*

C. Gegenbaur, "Elements of Comparative Anatomy" (trans. by F. Jeffrey Bell, Lond. 1878. New edition in German, 1898).

A. Lang, "Text-Book of Comparative Anatomy" (trans. by H. M. and M. Bernard). New German edition, 1900 *et seq.*

R. Wiedersheim, "Comparative Anatomy of Vertebrata" (trans. by W. N. Parker, Lond. 1886 ; new ed., 1907).

Oppel, "Vergleichende mikroskopische Anatomie" (1896-1905).

Reynolds, "The Vertebrate Skeleton" (1897).

Schimkewitsch, "Vergleichende Anatomie der Wirbeltiere" (1909).

Bütschli, "Vorlesungen über vergleichende Anatomie" (3 vols.).

WORKS ON COMPARATIVE PHYSIOLOGY :—

Claude Bernard, "Phénomènes de la Vie Commune aux Animaux et aux Végétaux" (1878).

Paul Bert, "Léçons sur la Physiologie comparée de la Respiration" (1870).

- C. F. W. Krukenberg, "Vergleichend-Physiologische Studien" and "Vorträge" (1881-89).
 F. Jeffrey Bell, "Comparative Anatomy and Physiology" (Lond. 1887).
 A. B. Griffiths, "Comparative Physiology" (1891).
 Halliburton, "Physiological Chemistry" (1891).
 Bunge, "Physiological and Pathological Chemistry" (translated 1890).
 M. I. Newbigin, "Colour in Nature" (Lond. 1898).
 O. von Fürth, "Vergleichende chemische Physiologie der niederen Tiere" (1903).
 C. S. Sherrington, "Integrative Action of the Nervous System" (1906).
 M. Verworn, "General Physiology."
 Geddes and Thomson, "Evolution of Sex."
 M. Hartog, "Problems of Life and Reproduction."

EMBRYOLOGY :—

- F. M. Balfour, "Comparative Embryology" (2 vols., Lond. 1880-81).
 M. Foster and F. M. Balfour, revised by A. Sedgwick and W. Heape, "Elements of Embryology" (Lond. 1883).
 A. C. Haddon, "Introduction to the Study of Embryology" (Lond. 1887).
 O. Hertwig, "Lehrbuch der Entwicklungsgeschichte des Menschen und der Wirbelthiere" (translated by E. L. Mark, 3rd ed., 1893.)
 E. Korschelt and K. Heider, "Lehrbuch der Vergleichenden Entwicklungsgeschichte der Wirbellosen Thiere" (Jena, 1890-93; translated).
 L. Roule, "Embryologie Générale" (Paris, 1892), and "Embryologie Comparée" (Paris, 1894).
 A. Milnes Marshall, "Vertebrate Embryology" (1893).
 C. S. Minot, "Human Embryology" (1892).
 E. B. Wilson, "The Cell in Development and in Inheritance" (1900).
 F. R. Lilley, "Embryology of the Chick."
 O. Hertwig, "Allgemeine Biologie" (1906).
 Jenkinson's "Experimental Embryology."

PALÆONTOLOGY :—

- H. A. Nicholson and R. Lydekker, "Manual of Palæontology" (2 vols., Lond. and Edin. 1889).
 K. A. von Zittel, "Handbuch der Palæontologie" (completed 1893). Translated.
 A. Smith Woodward, "Vertebrate Palæontology" (1898).
 M. Neumayr, "Die Stämme des Thierreichs" (vol. i., Wien und Prag, 1889).
 Gaudry, "Les Enchainements du Monde Animal" (1889-90).

- Carus Sterne (Ernst Krause), "Werden und Vergehen" (4th ed., Berlin, 1905).
 C. Depéret, "Les Transformations du Monde animale" (1907; translated).

GEOGRAPHICAL DISTRIBUTION :—

- A. R. Wallace, "Geographical Distribution" (2 vols., Lond. 1876).
 A. Heilprin, "The Geographical and Geological Distribution of Animals" (Lond. 1887).
 R. Lydekker, "Geographical Distribution of Mammals" (Cambridge).
 F. E. Beddard, "Geographical Distribution" (Oxford).
 Trouessart, "La Géographie Zoologique" (Paris, 1890).
 W. Marshall, in Berghaus' "Physikal Atlas" (Leipzig, 1887).

BOOKS OF NATURALIST TRAVELLERS, *e.g.* :—

- Charles Darwin, "Voyage of the *Beagle*" (London, 1844; new ed., 1890).
 H. W. Bates, "Naturalist on the Amazons" (new ed., Lond. 1892).
 T. Belt, "Naturalist in Nicaragua" (2nd ed., 1888).
 A. R. Wallace, "Malay Archipelago" (1869), "Tropical Nature" (1878), "Island Life" (1880).
 Wyville Thomson, "The Depths of the Sea" (1873), "Voyage of the *Challenger*" (1885).
 H. N. Moseley, "Naturalist on the *Challenger*" (1879, new ed., 1892).
 W. H. Hudson, "Naturalist in La Plata."
 A. E. Brehm, "From North Pole to Equator" (translation, edited by J. Arthur Thomson, with bibliography, 1895).
 S. J. Hickson, "Naturalist in the Celebes."
 A. Alcock, "Naturalist in the Indian Ocean."
 Sir John Murray and Dr. J. Hjort, "The Deep Sea."

COMPARATIVE PSYCHOLOGY :—

- G. J. Romanes, "Animal Intelligence" and "Mental Evolution of Animals."
 C. Lloyd Morgan, "Animal Behaviour"; "Introduction to Comparative Psychology" (London, 1894); "Habit and Instinct" (Lond. 1897).
 Jennings, "Behaviour of the Lower Organisms."

GENERAL NATURAL HISTORY :—

- Brehm's "Thierleben" (10 vols., Leipzig und Wien).
 Cassell's "Natural History" (edited by P. Martin Duncan, 6 vols., 1882).

- “Standard or Riverside Natural History” (edited by J. S. Kingsley, 6 vols., 1888).
 “Royal Natural History” (edited by R. Lydekker, 6 vols.).
 Hesse and Doflein, “Tierbau und Tierleben” (2 vols.).
 Hiltzheimer, “Handbuch der Biologie der Wirbeltiere.”
 Nusbaum, Karsten and Weber, “Lehrbuch der Biologie.”
 W. P. Pycraft and others, “History of Birds, Reptiles, Fishes” (2 vols.).

BOOKS ON EVOLUTION:—

- Charles Darwin, “Origin of Species” (1859, etc.).
 Alfred Russel Wallace, “Darwinism” (1889).
 Herbert Spencer, “Principles of Biology” (1866; new ed., vol. i., 1898).
 Ernst Haeckel, “Generelle Morphologie” (1866).

For more recent books, see J. Arthur Thomson, “Study of Animal Life.” To the list there given must be added Weismann’s “Germ-Plasm” (1893), Bateson’s “Materials for the Study of Variation” (1894), Delage’s “L’Hérédité” (1895), Weismann’s “Evolution Theory” (2 vols., Lond. 1905), De Vries’s “Species and Varieties” (1905), T. H. Morgan’s “Experimental Zoology” (1906), Thomson’s “Heredity” (1908), Bateson’s “Mendel’s Principles of Heredity” (1909), Thomson’s “Darwinism and Human Life” (1910), Bateson’s “Problems of Genetics,” Thomson and Geddes’s “Evolution,” Dendy’s “Outlines of Evolutionary Biology.”

GENERAL WORKS OF REFERENCE:—

- “Treatise on Zoology,” by E. Ray Lankester and others (several volumes published).
 W. Hatchett Jackson’s edition of Rolleston’s “Forms of Animal Life” (Oxford, 1888). A very valuable work, with special bibliographies.
 Leunis, “Synopsis des Thierreichs” (re-edited by Ludwig, Hanover, 1886).
 Bronn, “Klassen und Ordnungen des Thierreichs.”
 E. Ray Lankester and others, “Zoological Articles reprinted from ‘Encycl. Brit.’” (Lond. 1891).
 Yves Delage and others, “Traité de Zoologie Concrète” (Paris, many vols.).
 Shipley and Harmer, “Cambridge Natural History” (10 vols.).

MONOGRAPHIC SERIES, *e.g.*:—

- “Reports of the Voyage of H.M.S. *Challenger*.”
 “Fauna und Flora des Golfes von Neapel.”
 “Catalogues of the British Museum—Natural History.”
 “Ray Society Publications.”

RECORDS OF RESEARCH, *e.g.*—

- Journal of Royal Microscopical Society* (6 parts in the year).
Zoologisches Jahresbericht (Naples ; yearly).
Anatomische Ergebnisse (Merkel & Bonnet ; yearly).
Zoologisches Zentralblatt (monthly).

HISTORY OF ZOOLOGY :—

- W. Whewell, "History of Inductive Sciences" (1840).
 J. V. Carus, "Geschichte der Zoologie" (1872).
 E. Perrier, "La Philosophie Zoologique avant Darwin" (1884).
 E. Haeckel, "Natural History of Creation" (trans., Lond. 1870).
 E. Ray Lankester, article "Zoology" ("Encycl. Brit.").
 H. A. Nicholson, "Natural History : Its Rise and Progress in Britain" (1888).
 E. Krause, "Die Allgemeine Weltanschauungen" (1889).
 H. F. Osborn, "From the Greeks to Darwin" (1894).
 J. Arthur Thomson, "The Science of Life" (1899).
 J. Arthur Thomson, "The Progress of Science" (1902).
 Locy, "Biology and its Makers."

INDEX

INDEX



	PAGE		PAGE
AARD-VARK	751	Adamsia	177
Aard-wolf	707	Adder	634
Abdominal pores	504, 543	Adhesive cells	175
" ribs	620	Adrenal body of rabbit	717
Abducens nerve	490, 540	Adrenalin	511
Abomasum	758	Æginopsis	173
Absorption	28	Æluroidea	776
Abyssal fauna	796	Ælurus	778
Acanthias	567	Æpyornis	687
Acanthobdella	244	Aërial fauna	801
	200	Æthaliæ	107
Acanthodes	568	Agamidæ	629
Acarina	372	Aglossa	606
Acephala	425	Agouti	773
Acetabulum	706	Air-bladder of Fishes	565
Achromatin	46	Air-sacs of Birds	670, 674
Acineta	111	" " of Lizards	627
Acinetaria	111	Albumen gland of snail	388
Acipenser	570	" of bird's egg	683
Accela	182	" of frog's egg	599
Acontia	162	Alces	758
Acorn-shell	305	Alcyonacea	767
Acquired characters	73, 809	Alcyonaria	167
Acrania = Cephalochorda	459	" and Zoantharia	164
Acraspeda	173	Alcyonidium	250
Acrodont teeth	625	Alcyonium	169
Acromion	705	Alecithal	65
Actinia	162	Alimentary system of—	
Actiniaria	174	" Amphioxus	463
Actinomma	111	" Anodonta	396
Actinophrys	90	" Arenicola	226
Actinosphærium	92	" Ascidian	446
Actinotrocha (larva)	248	" Aurelia	154
Actinozoa	174	" Balanoglossus	435
Adambulacra	255	" bee	336

	PAGE		PAGE
Alimentary system of—		Ametabolic Insects	352
" Birds	651	Amia	571
" cockroach	330	Amitosis	48
" crayfish	288	Ammocoetes	526
" Crinoidea	274	Ammonites	432
" Crustacea	312	Ammonothea	379
" Distomum	184	Amnion 610, 642, 685,	729
" earthworm	215	Amniota	610
" frog	590	Amœba	89
" haddock	555	" functions of	112
" Helix	386	" physiology of	22
" Hirudo	239	Amphibia	578
" Holothurian	269	" classification of	605
" Insects	344	" Fishes compared with	579
" Lizards	625	" history of	608
" Myxine	519	" life of	607
" Nematoda	203	" Mammals and	609
" Nemertean	199	Amphiblastula	131
" Peripatus	320	Amphicœlous vertebra	533
" Petromyzon	524	Amphidiscs	130
" pigeon	665	Amphilina	196
" rabbit	710	Amphimixis	811
" Rotifera	246	Amphioxus	459
" scorpion	365	Amphipoda	308
" sea-urchin	264	Amphiporus	197
" Sepia	407	Amphisbœnidæ	629
" skate	542	Amphistylic	584
" spider	369	Amphiuma	606
" starfish	257	Ampullæ of starfish	258
" Vertebrates	498	Anableps, "placenta" of	643
Alisphenoid canal	755	Anabolism	33, 55
Allantois 38, 610, 642, 685,	731	Anaconda	634
Alligators	641	Anal cerci of cockroach	329
Alloiocœla	182	Analogous organs	37
Allotheria 738, 743		Anamnia	610
Alpaca	756	Anapophyses	700
Alternation of generations	57	Anaspides	308
" in Aurelia	155	Anchinia	457
" in Coelentera	141	Anchitherium	762
" in Distomum	186	Ancylus	421
" in Nematodes	205	Anemonia	174
" in Spongilla	130	Angiostomum	205
" in Tunicates	453	Anguis	629
Altrices	679	Angular bone	554
Ambiens muscle	659	Animal Kingdom—General	
Amblypoda	765	survey of	1-19
Amblyrhynchus	629	Animalculists	63
Amblystoma	606	Animals and Plants contrasted	22-24
Ambulacral areas	264	Annelids	209
" ossicles	255	" development of	228

	PAGE		PAGE
Annelids and Vertebrates	476	Appendages of spider	367
Anodonta	392	" of Trilobita	378
Anolis	629	Appendicular skeleton of	
Anomodontia	609, 738	Vertebrates	482
Anopheles	359	Appendicularia	457
Anoplodium	182	Appendix vermiformis	711
Ant-eaters	751	Apterygota	361
Antedon	272	Apteryx	687
Antennæ of cockroach	327	Aptornis	689
" of crayfish	284	Apus	299
" of Myriopods	325	Aquatic Mammals	735
" of Peripatus	319	Aqueduct of Sylvius	487
" of Trilobites	378	Aqueductus Vestibuli	475
Antennules of crayfish	284	Aqueous humour of eye.	497
Anthomedusæ	171	Arachnactis	163
Anthozoa	170, 174	Arachnoid fluid	470
Anthropoid Apes	788	" membrane	488
Anthropoidea	785	Arachnoidea	363
Anthropomorph monkeys	788	Araneidæ	367
Anthropopithecus	791	Arca	426
Antilocapra	759	Arcella	108, 116
Antilope	759	Archæoceti	739
Antipatharia	166	Archæopteryx	686
Antiquity of man	793	Archæornithes	686
Antlers	758	Archenteron	67, 469
Ants	360	Archi-Annelida	234
Anura	605	Archicœle	198
Anus of Vertebrates	502	Archigetes	190, 195
Apes	788	Archipterygium of Fishes	564
Aphides	360	Archoplasm	46
Aphrodite	233	Arcifera	584
Apis	332	Arctocyon	778
Aplysia	421	Arctoidea	778
Apneustic Insects	346	Arctomys	772
Apoda (Echinoderma)	272	Arctopithecini	787
Apoda = Gymnophiona	606	Area opaca	642, 684
Apodemata (crayfish)	286	Area pellucida	642, 684
Appendages of Arachnoidea	363	Arenicola	222
" of Arenicola	224	Argonauta	432
" of cockroach	327	Argulus	303
" of crayfish	284	Argyroneta	372
" of Crustacea	281	Arion	421
" of Eurypterina	377	Aristotle's lantern	265
" of haddock	555	Arius	562
" of Insects	339	Armadillos	751
" of Limulus	376	Arrow-worms	244
" of Myriopods	325	Artemia	299
" of Peripatus	319	Arterial arches of Vertebrates	506
" of Polychæta	230	" system. <i>See</i> Vascular	
" of scorpion	365	system.	

	PAGE		PAGE
Arterial system of embryo of higher Vertebrates	507	Aves (<i>see</i> Birds)	647
Arthrobranchs of crayfish	291	Axial skeleton (<i>see</i> Backbone)	478
Arthropoda, classes of	9	Axifera	169
, general characters of	280	Axis vertebra	700
Articular	554	Axolotl	606, 607
Artiodactyla	754	Aye-Aye	784
, and Perissodac- tyla contrasted	754	Azygobranchs	420
Ascaridæ	208	BABIRUSA	755
Ascaris	202	Baboons	788
Ascetta	125	Backbone	481
Ascidia	444	Bactrites	432
Asciacea	457	Baculites	432
Ascon type (of sponge)	127	Badger	778
Asexual reproduction	54	Balæna	770
Aspidocotylea	190	Balænoidea	770
Aspredo	562	Balænoptera	770
Astacus	281	Balanoglossus	435
Asteracanthion	255	, Vertebrate char- acters of	440
Asterias	255	Balanus	305
Asteroidea	254	Baleen	771
Astronyx	262	Bandicoot	747
Astropecten	260	Barbary ape	788
Astrophyton	262	Barbule	550
Astrorhizidæ	119	Barnacle	303
Atavisms or reversions	86	Basitemporal	649
Atax	373	Batoidei	567
Ateles	788	Bats	781
Athecæ	617	Bdellostoma	521
Atlanta	421	Bears	778
Atlantosaurus	645	Beaver	772
Atlas vertebra	700	Bee	332
Atrial cavity	446, 465	Beetles	360
Atriopore of Amphioxus	460	Belemnites	432
Attidæ	372	Belinurus	377
Auchenia	756	Belodon	641
Auditory capsules of skull	478	Beroe	175
Auditory nerve	490	Bilateral symmetry	35
, organs of Insects	344	Bile	27
Aulostoma	244	Bilharzia	190
Aurelia	152	Bionomics. <i>See</i> Ecology.	
, life history of	155	, Crustacea	315
, relatives of	157	, Fishes	563
Auricularia (of Holothuria)	278	, Insects	356
Australian region	805	, Mollusca	423, 426
Autogamy	56	, Protozoa	118
Autophagæ	679	, Sponges	133
Autostylic	584	Bipalium	182
Autozooid	168	Bipinnaria	278

	PAGE		PAGE
Bird lice	361	Botryllus	457
Birds	647	Bougainvillea	150, 171
" and Reptiles	612	Bovidæ	759
" classification of	686	Brachiodont	724
" courtship of	677	Brachiolaria	278
" diet of	679	Brachionus	246
" eggs of	678	Brachiopoda	251
" feathers of	655	Brachyura	309
" flight of	673	Brackish water fauna	799
" general characters of	648	Bradypodidæ	750
" migration of	680	Bradypus	750
" moulting of	679	Brain of pigeon	664
" nests of	677	" of skate	537
" pedigree of	690	" of Vertebrates	483
" song of	677	" summary of parts of	487
Birgus	309	Branchellion	244
Bivalves	425	Branchiæ = Gills	530
Bivium of starfish	258	Branchial arches	478
Bladder of frog	591	" sense organs	492
" of lizard	628	Branchiobdella	230, 243
" of Mammals	717	Branchiopoda	299
" worms	190, 195	Branchiostegal rays	554
Blastocyst	728	Branchiura	299
Blastoderm	67	Branchiura	230
Blastoidea	275	Breast bone	482
Blastomere	471	Brisinga	261
Blastopore	67	Brittle-stars	261
Blastosphere	67	Bryozoa	249
Blastula	67	Buccinum	420
Blatta	326	Buckie = Buccinum	412
Blind spot of eye	497	Budding	54
Blood	28, 42	Bugs	360
" of frog	591	Bulbus arteriosus	505
" of Mammals	696, 712	Bulla	421
Boa	634	Bunodont	724
Body cavity	347	Bursa Fabricii	667
" " of Amphioxus	465	Butterflies	360
" " of Arenicola	226	Byssus	412
" " of Balanoglossus	436	CADDIS flies	360
" " of crayfish	290	Cæca	666
" " of earthworm	213	Cæcilia	607
" " of Insects	347	Cæcum of rabbit	711
" " of Teleostean	504	Ca'ing whale	770
" " of Vertebrates	503	Calamoichthys	569
Bone	42	Calcaneum	707
Bonellia	233	Calcarea	133
Bony pike	571	Callorhynchus	568
Book scorpions	366	Calymene	378
Bos	759	Calyptoblastic	171
Bothriocephalus	196		

	PAGE		PAGE
Camelidæ	755	Cell cycle among Protozoa	107
Camelus	756	,, division	47-50
Campanularia	171	,, ,, rationale of	50
Campodea	361	,, nucleus of	45
Campodeiform larva	354	,, substance of	45
Cancer	310	,, theory	40, 70
Canidæ	777	,, wall of	47
Canis	777	Cells	44
Cannon-bone	757	,, forms of	44
Capitellidæ	231	,, structure of	44
Capitulum of rib	701	Cellulose in Tunicates	444
Capra	759	Cenoplacentalia	739
Caprella	308	Centetes	781
Capreolus	758	Centipedes	323
Capybara	773	,, and millipedes	325
Carapace of Chelonia	613	Central corpuscles	46
Carcharias	567	Centrolethical	67
Carchesium	97	Centrosomes	46
Carcinus	310	Cephalaspis	528
Cardium	427	Cephalochorda	459
Cardo	327	Cephalodiscus	440
Caretta	618	Cephalopoda	428
Carina of Cirripedia	303	Cephalothorax of crayfish	282
,, or keel of Birds	674	Cephalothrix	201
Carinaria	420	Ceratites	432
Carinatae	689	Ceratodus	574
,, and Ratitæ con- trasted	689	Ceratosæ	133
Carinella	199, 201	Cercariæ	188
Carinoma	201	Cerci of cockroach	327
Carmarina	173	Cercopithecidæ	788
Carnassial teeth	777	Cercopithecus	780
Carnivora	773	Cere of pigeon	665
Carpo-metacarpus	650	Cerebellum	487
Carpus	706	Cerebral hemispheres	484
Cartilage	42	Cerebratulus	201
,, -bones	702	Cerianthus	164, 174
Caryophyllæus	190, 196	Cervidæ	758
Cassiopeia	158	Cervus	758
Cassowary	687	Cestoda	190
Castor	772	Cestracion	567
Casuarus	687	Cestum Veneris	175
Cat	776	Cetacea	766
Catarrhini	786	Cetochilus	303
Caterpillar	354	Chætoderma	424
Caudata	606	Chætognatha	244
Cave fauna	799	Chætopoda	209
Cavia	773	Chætopteris	233
Cebidæ	787	Chalaza	683
Cebus	788	Chalicotherium	763
		Chalina	133

	PAGE		PAGE
Chamæleo	627	Circulatory system. <i>See</i> Vas-	
Charybdea	174	cular system.	
Chelicerae of <i>Limulus</i>	376	Cirri of Chætopods	230
" scorpion	365	" of Crinoids	273
" spider	367	Cirripedia	303
Chelifer	366	Cirrus sac	185
Chelone	618	Cladocera	301
Chelonia	613	Claspers of skate	532
Chelonidæ	618	Classification, grades of	14
Chemotaxis	113	" of Animals	16, 17
Chernes	366	" of organs	40
Chevron bones	636	" the basis of	14
Chevrotain	756	Clavelina	452
Chiasma of optic nerves	498	Clavicle	482
Chilognatha	325	Clepsine	244
Chilopoda	325	Clio	421
Chimæra	568	Cliona	134
Chimpanzee	791	Clitellum of earthworm	212
Chiromys	784	Clitoris	699
Chiroptera	781	Cloaca of Vertebrates	503
Chiton	418	Clypeaster	267
Chlamydomyxa	108	Cneme	165
Chlamydosaurus	629	Cnidoblasts	142, 146
Chlorophyll	25	Cnidocil	142
Choanocytes	125	Cobra	635
Chœropus	747	Coccidiidia	111
Cholœpus	750	Coccidium	103
Chondracanthus	303	Coccus Insects	360
Chondrocranium	478	Cochlea	493
Chordæ tendinæ	712	Cockle	427
Chordata and Non-chor-		Cockroach	326
data	8	Cocoon	354
Chordotonal organs	344	Cod	550
Chorion	731	Codosiga	110
Choroid of eye	497	Coelentera	137
" plexus	485	Coeliac ganglia	712
Chromatin	46	Coelom (<i>see</i> Body cavity)	347
Chromosmes	46	Coelom pouches	69
Chrysalis	354	Coelomata and Coelentera	12, 138
Chrysaora	158	Coenolestes	747
Chrysochloris	781	Coenurus	195
Chyle	28	Cold-blooded	696
Chyme	27	Coleoptera	360
Cicada	352	Collembola	361
Cidaris	267	Collozoum	110
Cilia	112	Colobus	788
Ciliary nerve	490	Colon	711
" process	497	Columba	654
Ciliata	111	" livia	86, 654
Ciona	457	Columela of Vertebrate ear	495

	PAGE		PAGE
Columella or epi-ptyergoid	637	Courtship of Birds	677
" in corals	165	" of Spiders	371
" in snail	384	Cowper's glands	720
Comatula	272	Coxa	327
Commensalism among Crustacea	316	Coxal glands of scorpion	365
" " Fishes	563	Crab	296
" of sea-anemone	177	Crangon	309
Commissures of Mammalian brain	708	Crania	251
Complemental males among Cirripedia	303	Cranial nerves	489
" Myzostomata	235	Craniata	16, 475
Conchifera (<i>see</i> Bivalves)	425	Craspedon of swimming-bell	150
Conchin = Conchiolin	384	Craspedota	159
Condylarthra	766	" and Acraspeda	159
Condyles, occipital	694, 702	Crayfish, the fresh water	281
Conjugation, dimorphic	56	" the sea	281
" multiple	55	Cremaster	745
" of Paramœcium	95	Creodonta	778
" of Protozoa	55, 117	Cribriform plate	703
" of Vorticella	98	Crickets	344
Conjunctiva	497	Crinoidea	272
Connective tissue	41	Cristatella	250
Contractile vacuoles	113	Crocodyles, Alligators, and Gavials	641
Contraction of muscle	42	Crocodylia	635
Conus arteriosus	505	Crop of earthworm	205
Convergence	37, 747	" leech	239
Convoluta	182	" pigeon	666
Copepoda	303	Crossopterygii	569
Coracoid	482, 705	Crotalus	635
Coral, making of	164	Crumb of bread sponge	133
Corallium	168	Crura cerebri	487
Corals	164	Crural glands	321
Cordylophora	171	Crusta petrosa	722
Corium	477	Crustacea	281
Cornea	497	" general characters of	281
Coronary	604	" systematic survey of	298
Coronella	634	Cryptobranchus	606
Corpora quadrigemina	695	Cryptoniscidæ	291
Corpus callosum	695	Crystalline style	397
" geniculatum	709	Ctenidia	382
" luteum	725	Cteniza	372
" striatum	471, 664	Ctenoid scale	565
Correlation of organs	36	Ctenophora	174
Corrodentia	361	Cubomedusæ	174
Corticata	106	Cucullianus	205
Cotylophora	757	Cucumaria	272
Couguar	754	Cuma	308
		Cuscus	748
		Cuticle	282
		Cutis	477

	PAGE		PAGE
Cuttlebone	433	Dermis of Vertebrates	477
Cuttlefish	402	Descent, doctrine of	84, 807
Cuvierian organs	269	Desmodus	783
Cyanea	158, 173	Deutoplasm	65
Cyclas	427	Development of—	
Cyclodus, "placenta" of	628	" Amphioxus	468
Cycloid scale	565	" Annelids	228
Cyclops	303	" Anodonta	400
Cyclostomata	516	" Ascidia	450
Cydippe	175	" Balanoglossus	438
Cymbulia	420	" Chætognatha	245
Cynocephalus	788	" chick	681
Cynoidea	777	" crayfish	293
Cynomorph Monkeys	788	" Crustacea	313
Cypridina	301	" earthworm	220
Cypris	301	" Echinoderma	275
Cysticercus	195	" eye	497
Cystidea	275	" feather	655
Cysts of Protozoa	115	" frog	598
Cytoplasm	44	" haddock	558
		" hair	720
DAPHNIA	301	" Hydra	147
Dart sac of snail	392	" Insects	349
Dasyplefis	632	" Mammalian teeth	722
Dasypodidæ	751	" Mammals	724
Dasyprocta	773	" Nemerteans	200
Dasypus	751	" Peripatus	322
Dasyuridæ	746	" Petromyzon	525
Dasyurus	746	" placenta	728
Dead-Man's-fingers	164	" Polychæta	228
Decapoda (Cephalopods)	432	" Reptilia	642
" (Crustacea)	308	" scorpion	366
Decidua	733	" skate	548
Decidua reflexa	732	" skull	478
Deciduate	734	" Sponges	131
Deep sea	796	" Teeth	722
Deer	758	" Tunicata	450
Degeneration	39	" Vertebrata	476
Delamination	69, 163	Diapedesis	593
Delphinoidea	770	Diaphragm	694, 716
Delphinus	770	Diastema	699
Demodex	373	Dibranchiata	431
Demospongiæ	133	Dichogamy	56, 449
Dendrocœlum	182	Dichogamy	56
Dentalium	424	" in Tunicates	449
Dentary	554	Dicotyles	755
Dentine	722	Dicyemidæ	135
Dentition of Mammals	722	Dicynodon	644
Dermal denticles	532	Didelphyidæ	746
Dermaptera	361	Didelphys	746

	PAGE		PAGE
Differentiation	36	Duckmole	740
Digestion	27	Ductus botallii	626
Digitigrade	776	„ endolymphaticus	494
Dimorphism of sexes	54	Dugong	752
Dinoflagellata	111	Duodenum	543
Dinophilus	234	Duplicidentata	698
Dinornis	687	Dura mater	488
Dinosauria	645	EAR of Arenicola	224
Dinotherium	765	„ of crayfish	288
Diphycercal	564	„ of Myxine	518
Diphyes	173	„ of Vertebrates	493
Diphyodont dentition	723	Earthworm	210
Diploblastic	144	Earwigs	361
Diplopoda = Millipedes	325	Ecaudata	605
Diplotrophoblast	731	Ecdysis or moulting of Ar-	
Diplozoon	188	thropods	282
Dipnoi	573	Echidna	740
Diporpo	188	Echinococcus	195
Diprotodon	749	Echinoderma	252
Diprotodontia	746	„ contrast between	
Diptera	360	the classes of	263
Dipterus	573	Echinoidea	262
Direct division	48	Echinorhynchus	208
Discoidal segmentation	67	Echinus	262
Discomedusæ	173	Echiuridæ	233
Discophora	235	Ectoderm	40, 67, 69
Discus proligerus	725	Ectoplasm	91
Distomum	183	Ectoprocta	249
Distribution, geographical	803	Edentata	749
„ geological	82	Edible bird's nest	678
Division of labour	22	Edrioasteroidea	275
Doehmius	205, 206	Egg-case of skate	548
Doctrine of descent	84, 807	„ cell	58
Dodo	689	Eggs of Birds	677
Dog	777	Elasipoda	272
Dogfish	567	Elasmobranchii	566
Dogwhelk	420	Electric organs	532
Doliolum	457	Eledone	432
Dolphin	770	Elephant's tooth shells	424
Donkey	762	Elephas	764
Dorcatherium	757	Elginia	644
Doris	421	Elimination	811
Draco	629	Elpidia	272
Dracunculus	206	Embolé	67
Dragon-flies	361	Embryology	58
Dreissensia	427	Emu	687
Drepanophorus	201	Enaliornis	687
Dromæognathous	689	Enamel	722
Dromæus	687	Encystation	90
Dromia	310		

	PAGE		PAGE
Endoderm	40, 70	Eutheria	741
Endolymph	494	Euthyneura	420
Endoplasm	91	Evolution, evidences of	85
Endopodite (crayfish)	283	,, factors in	807
Endosternite	364	,, of sex	54
Endostyle of Tunicates	447	,, summary of theories of	813
Enoplidæ	205	Excretion in Animals	30
Enterocœle	244	Excretory system of—	
Enteron = gut	498	,, Amphioxus	458
Enteropneusta	434	,, Anodonta	399
Entomostraca	298	,, Arenicola	227
Entoprocta	250	,, Balanoglossus	437
Eolis	421	,, cockroach	331
Epanorthidæ	747	,, crayfish	291
Epeira	372	,, Crustacea	313
Ephemeridæ	361	,, earthworm	217
Ephyra	156	,, frog	596
Epiblast	40, 69	,, haddock	558
Epibolé	69	,, Helix	388
Epicoracoid	705	,, Hirudo	241
Epidermis of Vertebrates	477	,, Insects	347
Epididymis of rabbit	717	,, Myxine	520
,, of skate	547	,, Peripatus	320
Epiglottis	710	,, Petromyzon	525
Epimeron (crayfish)	286	,, pigeon	671
Epiphragm of snail	384	,, rabbit	717
Epiphyses	694	,, scorpion	365
Epiphysis = Pineal body	485	,, Sepia	409
Epipodite of crayfish	291	,, skate	546
Epipterygoid	637	,, Tunicates	449
Epipubic bones	638	,, Vertebrates	509
Episternum	625, 638	Exopodite (crayfish)	283
Epistoma (crayfish)	286	Exoskeleton of Vertebrates	477
Epithelial tissue	41	Extinct Reptiles	644
Equidæ	761	Extinction of Animals	80
Equus	761	Eyes of Insects	343
Erinaceus	779	,, of pigeon	665
Eruciform	354	,, of Vertebrata	495
Erythrocytes	712	FABELLÆ	707
Ethiopian region	805	Facial nerve	490
Eucyrtidium	110	Fæces	28
Euglena	110	Fallopian tube	719
Eulamellibranchia	426	Fangs of Ophidia	632
Eupagurus	309	Fat	29
Euphausia	308	Fatigue	26
Euplectella	133	Feather-stars	272
Eurypterina	377	Feathers, development of	656
Euspongia	133	,, of pigeon	654
Eustachian tube	705		
Eustrongylus	207		

	PAGE		PAGE
Feathers, parts of	657	Foraminifera	108
Felidæ	776	Fore-brain = Prosencephalon	484
Felis	777	Fore-gut = Stomodæum	498
Femur	482	Fornix	695
Ferments	27	Fossils	78, 79
Fertilisation	65	Fox	777
Fibula	482	Fresh-water fauna	798
Fierasfer	178	" mussel	392
Filaria	206	Fritillaria	457
Filibranchia	426	Frog	580
Filoplume	654	Fuligo	107
Fins	564	Functions, change of	38
Firmisternia	586	" of Animals	24
Fishes, abyssal	563	" secondary, of organs	38
" and Amphibians com- pared	579	GADUS	550
" colour of	560	Galago	784
" commensalism in	563	Galathea	309
" fins of	564	Galea	327
" food of	561	Galeodes	367
" general characters of	530	Galeopithecidæ	781
" hermaphrodite	561	Galeopithecus	781
" orders of	566	Gall-bladder	711
" parental care among	564	Galton's law	74
" reproduction of	561	Gamasus	372
" senses of	561	Gammarus	308
" viviparous	562	Ganglion	43
Fission	54	Ganoid scales	565
Flagella	112	Ganoids	571
Flagellata	110	Gapes	208
Flagellum of snail	390	Garden spider	372
Flame cells	180	Gasteropoda	417
Fleas	360	" life history of	422
Flies	360	" parasitic	422
Flight of Birds	673	Gastræa theory	71
Flocculus	664, 708	Gastric filaments	154
Floridine in Sponges	130	" juice	27
Floscularia	246	" mill of crayfish	289
Flustra	250	Gastroliths of crayfish	289
Flying Mammals	735	Gastrula	67
Fœtal membranes of Birds	685	Gavials	641
" " of Mammals	730	Gecarcinus	310
" " of Reptiles	643	Geckonidæ	628
Follicle cells	725	Gemmation = Budding	54
Food vacuoles	90	Genealogical tree	15
Foot of Molluscs	388	Genetta	777
Foramen magnum	702	Geodesmus	182
" of Monro	709	Geographical distribution	803
" Panizzæ	639	Geological record	77
" triosseum	657	Geophilus	325

	PAGE		PAGE
Gephyrea	247	Gymnomyxa	106
Germ cells	53	Gymnophiona	606
" plasm	73	Gymnosomata	421
Germinial vesicle	58	Gyrodactylus	188
Gestation	737		
Gharials = Gavials	641	HADDOCK	550
Gibbon	789	Hæmadipsa	244
Gill-clefts	474	Hæmoccele	290
Gills. <i>See</i> Respiratory system.		Hæmocyanin	291
Giraffe	758	Hæmoglobin of blood	30
Gizzard of cockroach	334	Hæmopis	244
" of crayfish	289	Hag	516
" of crocodile	639	Hair	699, 720
" of earthworm	215	Halichærus	779
" of pigeon	659, 666	Halichondria	133
Glass-rope sponge	133	Halicore	752
Glenoid cavity	695, 705	Haliotis	420
Glenoid fossa	703, 775	Halisarca	133
Globe fishes	560	Halitherium	752
Globigerina	109	Halobates	357
Glochidium of Anodonta	400	Hamadryad	635
Glossopharyngeal nerve	490	Hapalidæ	787
Glycogen	28	Harderian gland	710
Glyptodontidæ	751	Hare	668
Gnathobdellidæ	244	Harelip	699
Gnathostomata	516	Harvest men	367
Gnats	359	" mites	373
Goldfish	572	Hastigerina	110
Gonads = Reproductive organs	40	Hatteria	618
Gonapophyses of cockroach	327	Heart of Vertebrates	504
Gonophores	152	Hectocotylus of cuttlefish	411
Gordiidæ	208	Hedgehog, dentition of	780
Gorgonia	169	" development of	728
Gorgonocephalus	262	" placenta of	730
Gorilla	790	Heliopora	169
Graafian follicle	719	Heliozoa	108
Graafilla	182	Helix	382
Grampus	770	" shell of	384
Grantia	133	Heloderma	629
Graptolites	173	Hemichorda	434
Grass snake	634	Hemimetabolic Insects :	352
Green gland of crayfish	291	Hemiptera	361
Gregarina	102	Hepatopancreas	290
Grey matter of brain	709	Heredity	72
Gromia	109	Hermaphrodite duct of snail	388
Gubernaculum	717	Hermaphroditism	56
Guinea-pig	773	" of Cestodes	191
" worm	206	" of Cirripedia	303
Gunda	182	" of earthworm	217
Gymnoblasic	171	" of leech	242

	PAGE		PAGE
Hermaphroditism of Myxine .	520	Hydra, development of .	147
,, of Trematoda .	184	,, minute structure of .	145
,, of Tunicata .	449	,, physiology of .	22
Herpestes	777	,, reproduction of .	53, 147
Hesperornis	687	Hydractinia	140
Heterocercal	564	Hydra-tuba of Aurelia	156
Heterocoela	133	Hydrochærus	773
Heterocœlous vertebræ .	648	Hydrocorallinæ	171
Heterodera	208	Hydroid colonies	171
Heterodont dentition . .	723	Hydromedusæ	170
Heteropods	420	Hydrophis	635
Heteronereis	231	Hydrophora	171
Hexacanth	192	Hydropotes	758
Hexacoralla	164	Hydrozoa	170
Hexactinellida	133	Hylobates	789
Hind-gut = Proctodæum .	498	Hymenoptera	360
Hippocampus of brain . .	709	Hyoid arch of Vertebrates .	480
Hippopotamus	755	Hyo-mandibular	480
Hippotherium	762	Hyostylic	584
Hirudinea	235	Hypopophysis	700
Hirudo	236	Hypoblast	40, 70
Histology	41	Hypodermis = Epidermis . .	328
Histriodrilus	234	Hypophysis	485
Hoatzin = Opisthocomus .	690	Hypostomata	528
Holoblastic segmentation .	65	Hypostome	144
Holocephali	568	Hypsodont	724
Holophytic	113	Hypural bone	552
Holopneustic	346	Hyracoidea	763
Holothuria	272	Hyracotherium	762
Holothuroidea	268	Hyrax	763
Homarus	281	Hystericomorpha	773
Homo	791	Hystrix	773
Homocercal	564	IANTHINA	420
Homocoela	133	Ichneumon	777
Homodont dentition . . .	723	Ichthyodorulites	568
Homology of organs . . .	14, 37	Ichthyomyzon	527
Homoplastic	37	Ichthyophis	607
Honeycomb bag	758	Ichthyopsida	475
Horns	721	,, Sauropsida, and	
Horse	761	Mammalia contrasted . .	611
Huanaco	756	Ichthyopterygium of Fishes .	564
Humerus	482	Ichthyornis	689
Hyæna	777	Ichthyosauria	644
Hyænodon	778	Idotea	308
Hyalea	421	Iguanidæ	629
Hyalonema	133	Iguanodon	645
Hybrids	75	Ilium	482
Hydatina	246	Incus of ear	695, 705
Hydra	42, 143	Indirect development . . .	253
,, budding of	144		

	PAGE		PAGE
Indirect division	48	Labial palp of Insects	34I
Indrisinæ	784	Labium of Insects	34I
Infundibulum	485	Labrum of Insects	327
Infusoria	110	Labyrinth of ear	494
,, ciliary movement in	112	Labyrinthodontia	607
Ink-bag of Cephalopods	408	Labyrinthulidea	108
Innominate bone	706	Lacerta	622
Insecta	325	Lacertilia	620
,, classification of	360	Lachrymal gland	710
Insectivora	779	Lacinia	327
Insects and disease	358	Lacteals	28
,, and flowers	357	Lactic acid	26
,, injurious	358	Lagena = Cochlea	493
,, pedigree of	359	Lagomys	773
Integration of individual	36	Lambdotherium	763
Interclavicle	625	Lamellibranchiata	425
Intervertebral disc	700	Lamprey	52I
Intracellular digestion	27	Lampshells	25I
Invagination	67	Lancelet	459
Invertebrata, classes of	8	Lanice	233
,, and Vertebrata	8	Larva of Amphibians	602
Iris	497	,, of Anodonta	400
Ischium	482	,, of Antedon	276
Isolation	812	,, of Ascidian	45I
Isopleura	417	,, of Aurelia	156
Isopoda	308	,, of Chætopods	230
Ister	487	,, of Crustaceans	314
Ixodes	373	,, of Holothuria	278
JACKAL	777	,, of Insects	352
Jacobson's organ	710	,, of lamprey	526
Jellyfish	152	,, of Molluscs	382
Jerboa	772	,, of Nemerteans	200
Jugal	480	,, of Ophiuroids	278
Julus	325	,, of Polygordius	228
KANGAROO	749	,, of sea-urchin	278
Karyokinesis	48	,, of starfish	278
Katabolism	32, 55	Larvacea	456
Keber's organ	398	Larynx	716
Keratin	548	Lateral line system	492
Kidney, functions of	30	Laurer-Stieda canal	186
,, of Vertebrates	509	Layers of Coelomata and Hy-	
King-crab	375	dra contrasted	147
Kiwi	687	,, the germinal	40
Kolga	272	Leech	236
Kowalevskia	457	Lemming	772
LABIAL cartilages of skull	535	Lemur	783
,, palp of cockroach	327	Lemuroidea	783
		Lens of eye	496
		Leopard	777
		Lepas	303

	PAGE		PAGE
Lepidoptera	360	Limnocnida	149
Lepidosiren	577	Limpet	420
Lepidosteus	571	Limulus	375
Lepisma	361	Lineus	201
Leptocardii = Cephalochorda .	459	Linguatulida	374
Leptodera	205	Lingula	251
Leptodora	301	Lion	777
Leptoplana	182	Lipocephala	425
Leptostraca	306	Lithobius	325
Lepus	773	Littoral life	797
Leucocytes of blood	712	Littorina	420
Leucon type of sponge	127	Liver fluke	183
Leucosolenia	133	" functions of	28
Lice	360	" of Vertebrates	500
Life history of Amœba	90	Lizards	620
" of Anodonta	400	Llama	756
" of Aurelia	155	Lobosa	108
" of Cestodes	195	Lobster	309
" Coccidium	104	Lobworm	222
" of Distomum	186	Locust	361
" of Fishes	562	Loligo	432
" of Frog	601	Lophiodontidæ	763
" of Gregarina	103	Lophodont	724
" of Insects	352	Lophophore	250
" of Monocystis	100	Lophopus	250
" of Nematodes	205	Loxosoma	250
" of Paramœcium	96	Lucernaria	158, 173
" of Polystomella	92	Luidia	260
" of Spongilla	130	Lumbricus	210
" of Tænia	191	Lung-books of scorpion	366
" of Trichina	207	Lungs	508
" of Tunicates	450	" function of	29
" of Vorticella	98	Lutra	778
" of Volvox	99	Lycaon	777
Ligula	196	Lycosa	372
Lima	427	Lymph	28
Limax	421	" hearts	627
Limbs and girdles of—		Lymphatic system of frog	595
" " Chelonia	615	" " of rabbit	715
" " Crocodilia	638	" " of Vertebrates	508
" " frog	584		
" " haddock	555	MACACUS	788
" " lizard	625	Machærodus	777
" " pigeon	662	Macrauchenia	754
" " rabbit	705	Macrobdella	243
" " skate	537	Macromere	468
Limbs, Theories as to origin		Macronucleus	96
of	564	Macropodidæ	748
Limnæus	186, 411	Macropus	748
Limnocodium	149, 177		

	PAGE		PAGE
Macrorhinus	779	Maturation	60
Macroscelides	781	Maxillæ of crayfish	284
Macrura	309	" of Insects	341
Madreporaria	164	" of Myriopods	325
Madreporic plate of brittle-star	261	" of Vertebrates	480
" " of sea-urchin	264	Maxillipedes of crayfish	284
" " of star-fish	255	May-flies	361
Malacobdella	201	Meckel's cartilage	480
Malacostraca	298	Medulla	487
Malapterurus, electric organ of	532	Medullary canal	469
Malar or jugal	480	" groove	469
Malaria parasites	121	Medusæ	152
Malleus of ear	605	Medusoids	149
Malpighian body of kidney		Megachiroptera	783
tubule	511	Megalopa	315
" tubules of cock-		Megalosaurus	645
roach	331	Megascolides	230
Mammalia	692	Megatherium	750
" development of	724	Meibomian gland	710
" general characters		Meiotic division	61
of	694	Meles	778
" " classifica-		Mellivora	778
tion of	739	Membrane bones	702
" " life of	735	Membranipora	250
" " survey of	692	Mendel's Law	74
" history of	737	Menognatha	360
Mammary glands	721	Menorhyncha	360
Mammillary body	709	Mento-meckelian	583
Mammoth	765	Mentum of cockroach	327
Manatee (Manatus)	752	" of Insects	341
Mandible of crayfish	284	Mephitis	778
Mandibular arch of Verte-		Merlia	133
brates	479	Mermaid's purse	548
Mandrill	788	Mermis	205
Manis	751	Meroblastic segmentation	67
Mantle of Molluscs	380	Merozoite	105
Manubrium of sternum	701	Mesencephalon	487
" of swimming-bell	150	Mesenchyme cells	69
Many-plics	758	Mesenteric filaments	161
Marmosets	787	Mesenteries of sea-anemone	161
Marmot	772	Mesenteron	503
Marsipobranchii (<i>see</i> Cyclo-		Mesentery	712
stomata)	516	Mesoderm (or mesoblast)	40, 70
Marsupial bones	744	" segments	601
Marsupials	743	Mesogloea	69
" families of	745	" of Coelentera	138
Marsupium	721	" of Sponges	128
Marten	778	Mesonephrös	511
Mastodon	765	Mesoplacentalia	738
Mastoid process	705	Mesopterygium	537

	PAGE		PAGE
Mesosma (of scorpion)	364	Modification	74, 810
Mesosternum	695	Moina	301
Mesozoa	134	Molars	723
Metabola	325	Mole	781
Metabolism	21	Mollusca	380
Metacarpals	482	,, classification of	416
Metacoracoid	705	,, general characters of	380
Metacromion	705	,, shell of	415
Metagenesis, or alteration of generations	57	Molluscoidea	248
Metagnatha	360	Moloch	629
Metakinesis	49	Monachus	779
Metamorphosis of—		Monaxonida	133
,, Anodonta	401	Monera	114
,, Crustacea	314	Monitor	629
,, Echinoderma	277	Monkeys	787
,, frog	604	Monocystis	100
,, Insects	352	Monodon	770
,, lamprey	526	Monomeniscous eyes	344
,, Tunicata	451	Monostomum	190
Metanephros	511	Monotremata	740
Metapleural fold	460	Moose	758
Metapterygium	537	Morphology	34
Metasoma (scorpion)	364	Morse	779
Metatarsals	482	Morula	67
Metatheria	741	Moschus	758
Metazoa	13	Mosquito	359
,, and Protozoa	122	Mother of pearl	415
Metencephalon	487	Moths	360
Microchiroptera	783	Moulting of birds	679
Microhydra	149	,, of cuticle of cray- fish	282
Microlestes	743	Mouth origin of Vertebrate	498
Micromere	468	Mucous canals of skate	532
Micronucleus	96	,, glands of Myxine	517
Micropyle	350	,, ,, of snail	391
Microstoma	182	Mud fishes	573
Microzooids	98	,, line	802
Midas	787	Müllerian duct	511
Midge	360	Multiple conjugation	117
Mid-gut = Mesenteron	503	Multituberculata	738
Migration of Birds	680	Murex	423
Milk	721	Mus	772
Millepora	171	Muscle, contraction of	42
Millipedes	325	,, fibres	26, 42
Milt	562	,, smooth	26, 42
Miracidium	186	,, striped	26, 42
Mites	372	Muscular activity in Animals	26
Mitosis	48	Muscular system of—	
Moa	687	,, Amphioxus	464
Modes of inheritance	74	,, Anodonta	395

	PAGE		PAGE
Muscular system of—		NAIS	230
„ Arenicola	224	Naja	635
„ Ascidian	445	Narwhal	770
„ Aurelia	153	Nasal capsule	478
„ Balanoglossus	435	Nasilis	788
„ Birds	657	Natural selection	811
„ cockroach	328	Nauplius	314
„ crayfish	286	Nautilus	428
„ earthworm	213	Navel	730
„ frog	588	Nearctic region	805
„ haddock	552	Nebelia	306
„ Helix	385	Nectonema	208
„ Hirudo	237	Necturus	606
„ Insects	343	Nekton	795
„ Myxine	517	Nematocysts	142
„ Peripatus	320	Nematoda	202
„ Petromyzon	523	Nematohelminthes	201
„ pigeon	657	Nemertea or Nemertines	197
„ rabbit	699	Neomenia	424
„ Sepia	403	Neomyxodon	750
„ skate	532	Neornithes	686
„ starfish	256	Neotropical region	805
Muscular tissue	42	Nephelis	244
Musk deer	758	Nephridia of crayfish	291
„ glands	758	„ of earthworm	217
Mussel	426	„ of leech	241
„ fresh-water	392	„ of mussel	399
Mustela	778	„ of Peripatus	320
Mustelus	567	„ of Vertebrates	509
Mya	426	Nephridioblast	222
Mycetes	788	Nephrops	281
Mycetozoa	107	Nephrostoma of kidney	510
Myelencephalon	487	Nephthys	233
Mygale	372	Nereis	233
Myodes	772	Nerve cells	43
Myomeres or Myotomes	460	Nerve fatigue	26
Myomorpha	772	„ fibres	43
Myotomes	478	„ tissue	43
Myriopoda	323	Nerves, cranial	490
Myrmecobius	746	Nervous activities in Animals	24
Myrmecophagidæ	751	Nervous system of—	
Myrmecophagus	751	„ Amphioxus	462
Mysis	308	„ Anodonta	396
Mystacoceti	770	„ Arenicola	224
Mytilus	426	„ Ascidian	447
Myxine	516	„ Aurelia	153
„ and Petromyzon con-		„ Balanoglossus	435
trasted	526	„ bee	334
Myxospongida	133	„ Cephalopoda	428
Myzostomata	235	„ Chætognatha	244

	PAGE		PAGE
Nervous system of—		Nucleus pulposus	700
,, cockroach	329	Nudibranchs	421
,, crayfish	286	Nummulites	109
,, Crinoid	274	Nymph	354
,, Distomum	184	Nymphon	372
,, earthworm	214		
,, frog	588	OBELIA	171
,, haddock	555	Obstetric toad	608
,, Helix	385	Obturator foramen	706
,, Hirudo	237	Ocellatæ	151
,, Holothurian	269	Ocelli	343
,, Hydra	146	Octanemus	457
,, Insects	343	Octocoralla	164
,, Lizards	625	Octopoda	432
,, Myxine	518	Octopus	432
,, Nematoda	203	Oculomotor nerve	490
,, Nemerteans	197	Odonata	361
,, Peripatus	320	Odontoceti	770
,, Petromyzon	524	Odontoid process	700
,, pigeon	664	Odontolcæ	687
,, rabbit	707	Odontophora (see Glosso-	
,, scorpion	365	phora)	416
,, sea-urchin	266	Odontophore	381
,, Sepia	405	Ecology—	
,, skate	537	,, Birds	677
,, spider	368	,, Cœlentera	176
,, starfish	256	Œsophagus of Vertebrates	500
,, Vertebrates	482	Okapi	758
Nervures	341	Oikapleura	457
Nests of Birds	677	Olfactory lobes	485
Neurapophysis = Neural spine	630	,, nerves	490
Neurilemma	43	Oligochaeta	210
Neuroblast	222	Omentum	670
Neuro-muscular cells	43	Ommastrephes	432
Neurones	42	Omphaloidean trophoblast	731
Neuropodium	230	Omphalopleura	727
Neuroptera	361	Oniscus	308
Newts	606	Ontogeny	72
Nictitating membrane of eye	479, 665, 698	Oocyst	105
Noctiluca	111	Ooze, Atlantic	110
Nomarthra	750	Opalina	115
Nose, the	492	Operculum of Gasteropods	384
,, of Myxine	519	,, of Limulus	376
Nothosaurus	644	,, of scorpion	365
Notochord of Balanoglossus	436	,, of Teleostei	550
Notopodium	230	Ophidia	629
Notoryctes	746	Ophiocoma	262
Nucleus	45	Ophiopholis	262
,, division of	48	Ophiothrix	262
		Ophiuroidea	261

	PAGE		PAGE
Opisthobranchs	420	Ova of—Vertebrates	513
Opisthocelous	571	Oviducal gland of skate	548
Opisthocomus	686, 690	Oviduct of Vertebrates	511
Opposums	746	Oviparous Vertebrates	514
Optic chiasma	709	Ovis	759
,, foramen	703	Ovo-testis of snail	388
,, lobes	487	Ovo-viviparous Vertebrates	515
,, nerves	490	Ovulation	725
,, thalami	485	Ovum, the	58
Orang	790	,, maturation of the	61
Orca	770	,, membranes around the Vertebrates	513
Orchestia	308	,, theory	70
Organs	36	Oxyuris	206
,, origin of	69	Oyster	426
,, rudimentary	39		
Oriental region	805	PACHYMATISMA	133
Ornithodelphia	740	Pacinian corpuscles	657
Ornithorhynchus	740	Pagurus	309
Orthoptera	361	Palæarctic region	805
Orycteropus	751	Palæmon	309
Oscarella	133	Palæontological series	79
Osculum	125	Palæontology	77
Osphradium of Molluscs	382	Palæospondylus	527
Ossicles of ear	695, 705	Palæostraca	375
Osteoblasts	42	Palæotherium	763
Ostracoda	301	Palato-pterygo quadrate car- tilage	479
Ostracodermi	528	Palinurus	309
Ostrea	426	Palisade worm	207
Ostriches	686	Pallium	380
Otaria	779	Palmipes	255
Otocyon	777	Palp	284, 327
Otocysts = Otoliths	386	Paludicella	250
Otoliths of Vertebrates	493	Paludina	80
Otter	778	Pancreatic juice	27
Ova of—		Panda	778
,, Anodonta	400	Pandalus	309
,, Birds	681	Pangolin	751
,, cockroach	331	Panmixia	799
,, crayfish	294	Panniculus adiposus	699
,, earthworm	221	,, carnosus	700
,, Echinoderms	275	Panorpata	361
,, Fishes	561	Pantopoda	378
,, fluke	185	Papillary muscles	712
,, frog	598	Parachordals of skull	478
,, Hydra	147	Paraglossæ	327
,, Monotremes	697, 743	Paramœcium	94
,, Myxine	520	Parapodia	230
,, Peripatus	321		
,, Placental Mammals	697		
,, Reptilia	642		

	PAGE		PAGE
Parasitic fauna	800	Pelagothuria	268
Parasitism of—		Pelecypoda (<i>see</i> Bivalves)	425
,, Acarina	372	Pelias	634
,, Cestoda	191	Pelomyxa	108
,, Cirripedia	306	Pelvic girdle	482
,, Copepoda	303	Penæus	315
,, Crustacea	316	Penella	287, 303
,, Gasteropods	422	Penis of Mammals	719
,, Insects	357	Pennatula	164, 169
,, Nematoda	204	Pentacrinus	272
,, Pentastomum	374	Pentastomum	374
,, Trematoda	188	Pepsin	27
Parasphenoid	553, 583	Peragale	747
Parasuchus	641	Perameles	747
Parazoa	134	Peramelidæ	747
Pareiosaurus	644	Perch	573
Parental care in—		Perching of Birds	657
,, Amphibians	608	Peribranchial cavity	446
,, Asteroids	260	Pericalpa	174
,, Birds	679	Pericardium	504
,, crocodiles	640	Perilymph	494
,, Fishes	562	Perineal glands	699
,, Mammals	737	Peripatus	319-323
Paroccipital process	702	,, and Annelids	323
Parthenogenesis	56	Peripheral segmentation	67
,, in Apus	300	Periplaneta	326
,, in Artemia	299	Periptychus	766
,, in Insects	349	Perisarc	140
Patella	420	Perissodactyla	754
Pathetic nerve	490	Peristaltic action	28
Paunch	758	Peritoneum	711
Pauropoda	325	Perivisceral fluids	784
Paupopus	325	Periwinkle	420
Peccaries	755	Perla	361
Pearl	196	Petaurus	748
Pecora	757	Petromyzon	521
Pecten	427	,, and Myxine con-	
,, of eye of Birds	665	trasted	526
Pectines of scorpion	365	Petrous portion of periotic	705
Pectoral girdle	482	Phacochærus	755
Pedal ganglion	385, 396, 405	Phacops	377
Pedalion	246	Phagocytosis	292
Pedicellariæ	264	Phalanger	748
Pedicellina	250	Phalangeridæ	747
Pedipalpi	366	Phalanges	482
Pedipalps of scorpion	365	Phalangidæ	367
,, of spider	368	Phalangium	367
Pelagia	141	Phallusia	457
Pelagic life	795	Pharyngobranchii	460
Pelagonemertes	198, 201	Pharynx	499

	PAGE		PAGE
Phaseogale	746	Plagraulax	738
Phascolarctos	748	Planaria	182
Phascolomyidæ	747	Plankton	795
Phascolomys	747	Planorbis	421
Phascolosoma	247	Plantigrade	776
Phenacodus	3, 694	Plants and Animals	22-24
Phoca	779	Planula larva	151
Pnocæna	770	Plasmodium	55, 107
Phocidæ	779	Plastron	615
Pholas	426	Platanista	770
Phormosoma	267	Platyedactylus	628
Phoronidea	248	Platyhelminthes	180
Phoronis	248	Platypus	743
Phrynosoma	629	Platyrrhina	786
Phrynos	366	Plesiosauria	644
Phyllopora	299	Pleura of crayfish	286
Phyllosoma	309	Pleuracanthus	569
Phylloxera	339	Pleural membrane	689
Phylogeny	72	Pleural sacs	640
Physalia	173	Pleurobranchs of crayfish	291
Physeter	770	Pleurodont teeth	625
Physiology	20	Pleuronectidæ	573
Physoclistous	572	Pleuro-peritoneal cavity	643
Physostomous	572	Pliosaurus	644
Phytoptids	373	Ploughshare bone	648
Phytophagæ	137	Plumularia	171
Pia mater	488	Pluteus larva	278
Pica	773	Pluvianus	641
Pigeon	654	Pneumatic bones	675
Pigeon's milk	667	Pneumoderma	421
Pigs	755	Pneumogastric nerve	490
Pilidium larva	199	Podical plate of cock- roach	327
Pineal body	485	Podobranchs of crayfish	291
" in Sphenodon	485	Podura	339
" in Iguana	485	Poikilothermal	696
Pinnipedia	778	Poison gland of snakes	631
Pinnotheres	310	Polar globules	61
Pipa	606	" " in earthworm	220
Pipe-fishes	573	" " in Vertebrates	513
Pipistrelle	783	Polecat	778
Piropasma	121	Polian vesicle (Holothuria)	270
Pisces (<i>see</i> Fishes)	529	Polychæta	210
Pisiform	625, 706	Polycladida	182
Pi-hecanthropus	791	Polyclinium	457
Pituitary body	468, 485	Polygordius	228, 231
Placenta, Hints of a, before Mammalia	643	Polymeniscous eyes	344
" of Mammals	728	Polymorphism	140
Placentation, classification of	734	Polyodon	570
Placoid scales	532	Polyphemus	301

	PAGE		PAGE
Polyplacophora	418	Proscoplex	190
Polypodium	149, 167	Prosencephalon	484
Polyprotodontia	746	Prosimiæ	783
Polypterus	570	Prostate glands	719
Polyspermy	63	Protandrous	520
Polystomella	92	Protective colouring of Insects	357
Polystomum	188	Proteles	777
Polyzoa	249	Proteomyxa	107
Pond snail	421	Proterosauria	620
Pons Varolii	709	Proterospongia	134
Pontobdella	244	Proteus	606
Porcellenaster	260	,, animalcule (<i>see</i>	
Porcellio	308	Amœba)	89
Porcupine	773	Protobranchia	426
Porifera	124	Protocercal	564
Porocytes	126	Protodrilus	234
Porpita	173	Protogynous	453
Porpoise	770	Protohippus	762
Portal vein	715	Protohydra	149
Portuguese man-of-war	173	Protomyxa	107
Portunus	310	Protoplasm	31, 45, 51
Post-anal gut	502	Protopterus	575
,, caval vein	627, 643	Protospongia	133
Potamogale	779	Prototheria	740
Powder-down	655	Prototracheata	318
Præcoces	679	Protovertebræ = Mesoblastic	
Præsternum	695	segments	601
Prairie-dog	772	Protozoa	88
Prawn	309	,, and Disease	120
Precaval veins	627	,, and Metazoa	122
Preen gland of pigeon	657	,, classification of	106
Prepuce	719	,, functions in the	112
Priapulidæ	247	,, general interest of	122
Priapulidæ	247	,, history of the	119
Primary vesicles of brain	487	,, immortality of	122
Primates	785	,, reproduction in	116
Primitive groove	642, 684	,, structure of	114
,, streak	642, 684	,, survey of the	107
Pristis	567	Proventriculus	666
Pro-amnion	643	Provortex	182
Proboscidea	764	Psalterium	758
Procvavia	763	Pseudaxonia	169
Procœlous	582	Pseud-hæmal system	259
Proctodæum	498	Pseudobranch	556
Procyon	778	Pseudogastrula	432
Proechidna	740	Pseudolamellibranchia	426
Proneomenia	424	Pseudonavicellæ	101
Pronephros	509	Pseudopodia	89
Prongbuck	759	Pseudopus	629
Propterygium	537	Pseudoscorpionidæ	366

	PAGE		PAGE
Psolus	272	Recapitulation of ancestral	
Pteranodon	645	history	71
Pteraster	260	Rectal gland	543
Pterichthys	528	Red coral	169
Pterobranchia	440	Redia	186
Pterodactyl	645	Reducing division	61
Pteropods	421	Reed	758
Pteropus	783	Reindeer	758
Pterosauria	645	Relative antiquity of	
Pterotrachea	420	Animals	82
Pterygota	360	Renal-portal system	595, 671
Pteryllæ	653	Reproduction	52
Ptyalin	27	" of Amphibia	608
Ptychodera	435	" of Crustacea	313
Puff-adder	635	" of Fishes	561
Pulmonary sacs of Arachnids	363	" of Insects	349
" " of scorpion	366	" of Mammals	736
" " of spider	369	" modes of	54
Pulmonata	421	Reproductive system of—	
Pupa	354	" Amphioxus	468
Pupil of eye	497	" Anodonta	399
Purpura	422	" Arenicola	227
Pycnogonidæ	378	" Ascidian	449
Pycnogonum	379	" Aurelia	154
Pygostyle	660	" Balanoglossus	437
Pyloric cæca of Insects	345	" bee	338
Pyrosoma	457	" cockroach	331
Python	634	" crayfish	292
Pythonomorpha	645	" Crocodilia	640
QUADRATE	480	" Distomum	185
Quagga	762	" earthworm	217
RABBIT	697	" frog	597
Raccoon	778	" haddock	558
Radial symmetry	35	" Helix	308
Radials of a fin	564	" Hirudo	342
Radiolaria	109	" Holothurian	270
Radius	482	" Insects'	348
Radula of cuttlefish	407	" Lizards	628
" of gasteropods	411	" Myxine	520
" of snail	386	" Nematoda	204
Raja. <i>See</i> Skate.		" Nemertean	200
Rana. <i>See</i> Frog.		" Peripatus	321
Rangifer	758	" Petromyzon	525
Rat	735	" pigeon	672
Ratitæ	686	" rabbit	717
Rattlesnake	635	" sea-urchin	267
Ray	567	" Sepia	410
Razor-shell	427	" skate	546
		" spider	370
		" starfish	260

	PAGE		PAGE
Reproductive system of—		Rhamphorhynchus	645
" Vertebrates	513	Rhea	686
Reptilia	610	Rhinoceros	762
" and Birds	612	Rhinoderma	608
" development of	642	Rhinolophus	783
" extinct	644	Rhizocrinus	275
" relationships of	646	Rhizopoda	108
Respiration in Animals	29	Rhomboidal sinus	665
Respiratory system of—		Rhopalura	135
" Acarina	372	Rhynchobdellidæ	244
" Amphioxus	463	Rhynchocephalia	618
" Anodonta	398	Rhynchota	360
" Arenicola	227	Rhytina	752
" Ascidian	446	Ribs of Vertebrates	482
" Balanoglossus	437	Rock-dove	654
" bee	337	Rodentia	771
" cockroach	330	Roe-deer	758
" crayfish	291	Rorqual	770
" Crocodilia	640	Rostrum of crayfish	286
" Crustacea	313	Rotatoria = Rotifers	245
" frog	596	Rudimentary organs	39, 630
" haddock	556	Rumen	758
" Helix	388	Ruminants	757
" Insects	345	Rumination	758
" Limulus	376		
" Lizards	627	SABELLARIA	233
" Myxine	519	Saccocirrus	234
" Peripatus	320	Sacculina	306
" Petromyzon	525	Sacculus of ear	493
" pigeon	671	" rotundus	711
" rabbit	715	Sacrum	695
" scorpion	366	Sagitta	244
" sea-urchin	267	Salamander	606
" Sepia	408	Salinella	136
" skate	543	Saliva	27
" spider	369	Salivary glands of ant-eaters	751
" starfish	259	" " of cockroach	330
" Tracheata	318	" " of Collocalia	678
" Vertebrates	508	" " of Helix	386
Retia mirabilia of Cetacea	768	" " of Hirudo	239
" " of Sirenia	752	" " of Insects	345
Reticulum	758	" " of rabbit	710
Retina	497	Salmon	562
Retinula	288	Salpa	457
Reversion	86	Sarcolemma	42
Rhabdites	180	Sarcoptes	372
Rhabdocelida	182	Sauropsida, Ichthyopsida and	
Rhabdom	288	Mammalia	611
Rhabdonema	205	Saururæ	680
Rhabdopleura	442	Saw-flies	366

	PAGE		PAGE
Scales of Birds	655	Segmentation of Ovum—	
" of Fishes	565	" in Crustacea	313
" of Mammals	720	" " earthworm	220
" of Reptiles	612	" " Echinoderms	275
Scallop	426	" " fowl	683
Scalpellum	305	" " frog	599
Scaphirhynchus	570	" " Gasteropoda	423
Scaphopoda	424	" " haddock	558
Scapula	482	" " Hydra	148
Schizocardium	435	" " Insects	350
Schizocœle	199	" " Lamprey	525
Schizont	105	" " Monotremata	697
Schizopoda	308	" " placental Mam-	
Sciuromorpha	772	mals	728
Sciurus	772	" " Reptilia	642
Sclerotic	497	" " scorpion	366
" ossicles	665	" " skate	548
Scolex	190	" " Teleosteans	558
Scolopendra	325	" " Vertebrata	514
Scolopendrella	325	Seison	246
Scorpion	364	Selachii = Elasmobranchs	567
Scrotum	717	Selection	811
Scuta	303	Selenodont	724
Scutes	477	Self-fertilisation in Hydra	147
Scyllium	567	" " Serranus	561
Scyphistoma	157	" " tapeworms	191
Scyphomedusæ	173	" " Trematoda	186
Sea-anemone	159	Sella turcica	703
" butterflies	421	Semicircular canals of ear	494
" cows	752	Seminal vesicle	719
" cucumbers	268	Semnopithecus	788
" horse	562	Sense organs of—	
" lion	779	" Amphioxus	463
" mouse	233	" Ascidian	447
" otter	778	" Aurelia	153
" pen	164	" crayfish	287
" snakes	635	" Crocodilia	639
" squirts (<i>vide</i> Tunicata)	443	" Crustacea	312
" urchin	262	" frog	589
Seals	779	" haddock	555
Sebaceous glands	721	" hag	518
Sectorial tooth	775	" Helix	385
Sedentaria	231	" Hirudo	237
Segmental duct of Vertebrates	511	" Holothurian	269
Segmentation of Ovum	65	" Insects	343
" in Amphioxus	468	" Lamprey	524
" " Anodonta	400	" pigeon	665
" " Ascidian	450	" rabbit	710
" " Balanoglossus	438	" Sepia	406
" " Chætognatha	245	" skate	542

	PAGE		PAGE
Sense organs of—		Sipunculidæ	247
,, spider	368	Sipunculus	247
,, starfish	256	Siren	606
,, Vertebrates	492	Sirenia	752
Sepia	402	Skate	531
Sepiostaire	405	,, development of	548
Serpents	628	Skeleton of—	
Serpula	233	,, Amphioxus	462
Serranus	561	,, Balanoglossus	436
Sertularians	171	,, bat	781
Sesamoid bones	700	,, Birds	648
Setæ	213, 283	,, Chelonia	614
Sex, evolution of	54	,, crayfish	282
Sexual selection	812	,, Crinoids	273
,, ,, among birds	677	,, Crocodilia	636
,, ,, among spiders	371	,, frog	582
,, reproduction	52	,, haddock	552
,, ,, divergent		,, Hatteria	620
modes of	56	,, Lizards	623
Sharks	567	,, Mammals	694
Shell of—		,, Myxine	518
,, Anodonta	393	,, Petromyzon	523
,, Argonauta	429	,, pigeon	659
,, Cephalopoda	428	,, rabbit	700
,, Chiton	417	,, sea-urchin	264
,, Helix	384	,, Sepia	404
,, Nautilus	433	,, skate	533
,, Planorbis	431	,, Snakes	631
,, Scaphopoda	424	,, starfish	255
,, Spirula	429	,, Vertebrates	478
Shell gland or sac	301	Skin of—	
Shore-crab	310	,, Amphioxus	461
Shrews	780	,, Anodonta	395
Shrimp	309	,, Balanoglossus	435
Sida	301	,, Birds	657
Silicispongiæ	133	,, cockroach	328
Simia	788	,, crayfish	282
Simiidæ	788	,, Crocodilia	635
Simplicidentata	773	,, earthworm	213
Sinews	26	,, Fishes	530
Sinus venosus	505	,, frog	581
Siphon of Cephalopods	428	,, haddock	550
,, of Gasteropods	422	,, Helix	385
,, of Lamellibranchs	426	,, Insects	342
Siphonaptera	360	,, Leech	237
Siphonoglyphes	161	,, Lizards	622
Siphonophoræ	173	,, Mammals	720
Siphonops	606	,, Myxine	517
Siphonozoid	168	,, Peripatus	320
Siphuncle of Nautilus	429	,, Petromyzon	532

	PAGE		PAGE
Skin of—		Spicules (of sponge) . . .	126
„ rabbit . . .	699	Spider Monkeys . . .	788
„ Sepia . . .	403	Spiders . . .	367
„ skate . . .	532	Spinal cord . . .	489
„ Tunicate . . .	445	„ ganglia . . .	491
„ Vertebrates . . .	476	„ nerves . . .	491
Skull . . .	478	Spinning glands of Insects . . .	345
Skull of—		„ „ of Spiders . . .	371
„ Crocodilia . . .	636	Spiracles of skate . . .	532
„ frog . . .	582	Spiracular cartilage . . .	535
„ haddock . . .	552	Spiral valve . . .	543
„ lizard . . .	623	Spirochæte . . .	121
„ Mammals . . .	694	Spirula . . .	429
„ pigeon . . .	660	Splanchnopleure . . .	601, 732
„ rabbit . . .	702	Spleen . . .	31
„ skate . . .	533	„ of frog . . .	596
„ snakes . . .	632	„ of pigeon . . .	670
Sleeping-sickness parasite . . .	120	„ of rabbit . . .	712
Sloth animalcules . . .	375	„ of skate . . .	546
Sloths . . .	750	Splénial . . .	480
Slough of snake . . .	630	Sponge, development of a . . .	131
Slow-worm . . .	629	Sponges . . .	124
Slug . . .	421	Spongilla . . .	130
Snail (<i>see</i> <i>Helix</i>) . . .	382	Sporocyst . . .	186
Snakes . . .	629	Sporozoa . . .	111
Solaster . . .	255	Sporozoite . . .	105
Solen . . .	427	Spring-tails . . .	361
Solenia . . .	164	Squamosal . . .	480
Solenomya . . .	426	Squilla . . .	308
Solpuga . . .	367	Squirrels . . .	772
Solpugidæ or Solifugæ . . .	307	Stagonolepis . . .	641
Somatic cells . . .	73	Stapes of ear . . .	695
Somatopleure . . .	601, 732	Starfish . . .	255
Somites = Segments . . .	474	Stegocephali . . .	607
Song of birds . . .	677	Stelechotokeia . . .	169
Sorex . . .	780	Steller's sea-cow . . .	752
Spadella . . .	244	Stenothermal . . .	696
Spatangus . . .	267	Sterno-tracheal muscles . . .	659
Spatularia . . .	571	Sternum of Crustacean seg-	
Species . . .	14	ment . . .	286
Spermathecae . . .	219	„ of pigeon . . .	663
Spermatic cord . . .	717	Stickleback . . .	562
Spermatophores . . .	219	Stigmata . . .	345
Spermatozoa . . .	59	Sting of scorpion . . .	364
Sphæridia . . .	264	Stinging animals . . .	137
Sphærozoum . . .	110	„ cells . . .	142
Sphærulearia . . .	205	Stipes . . .	327
Sphenethmoid . . .	583	Stoat . . .	778
Sphenodon . . .	620	Stolonifera . . .	169
Sphenotic . . .	553	Stomatodæum = Stomodæum . . .	498

	PAGE		PAGE
Stomato-gastric nerves	287	Talpa	779
Stomodæum	498	Tamandua	751
Stone canal of Starfish	258	Tape-worms	190
Strepsiptera	360	Tapir	761
Streptoneura	420	Tarantula	372
Stringops	674	Tardigrada	375
Strobila	190	Tarsipes	744
Strongylocentrotus	267	Tarsius	784
Strongylus	208	Tarso-metatarsus	651
Struggle for existence	735	Tarsus	482
Struthio	686	Tasmanian wolf	746
Sturgeon	570	Tatusia	751
Stylaster	171	Tealia	159, 164
Stylifer	422	Tectibranchia	420
Suberites	134	Teeth of Crocodilia	637
Submentum	327	,, of extinct birds	686
Sub-neural gland of Ascidian	447	,, of lizards	625
Substitution of organs	38	,, of Mammals	722
Subzonal membrane 643, 685, 730	730	,, of Ornithorhynchus	743
Sudorific glands	721	,, of skate	542
Suidæ	755	,, of snakes	632
Sulcus	164	Tegenaria	372
Sun animalcules	108	Teleostei	571
Suprarenal bodies	511	Telolecithal	65
,, body of pigeon	672	Telson	286
,, of rabbit	717	Temnocephaloidea	182
Surangular	638	Temperature of Birds	651
Surinam toad	608	,, of Mammals	741
Sus	755	Temporal. <i>See</i> Squamosal	
Suspensorium	583	Tenrec	781
Swim-bladder	565	Tentaculocysts	153
Sycon type (of sponge)	127	Tentorium	775
Syllids	233	Teredo	427
Symbiosis	178	Tergum	286
Symmetry of Animals	35	Termites	361
Sympathetic nervous system	491	Terrestrial fauna	800
Symphyla	325	Testudo	613
Symplectic	554	Tetrabranchiata	432
Synangium	591	Tetranychus	356
Synapta	272	Tetrapneumones	372
Syngamus	208	Tetrarhynchus	196
Syn-sacrum	660	Tetrodon	560
Syrinx	671	Tetronerythrin	291
Systemodon	762	Thalamencephalon	485
TADPOLE of frog	602	Thalassicola	110
Tænia	191	Thaliacea	457
Tæniolæ	156	Thecophora	618
Tail of Fishes	564	Thelyphonus	366
		Theromorpha	644
		Thoracic duct	715

	PAGE		PAGE
Thread cells = Stinging cells	142	Triconodon	738
Thread-worms	202	Trigeminal	490
Thylacinus	746	Trilobites	377
Thymus	500	Triploblastic	179
" of frog	596	Tristomum	190
" of rabbit	712	Triton	606
" of skate	546	Tritubercular	724
Thyroid	499	Trivium	255
" of frog	596	Trochanter	707
" of rabbit	717	Trochlear nerve	490
" of skate	546	Trochosphere	228, 397
Thysanoptera	361	Trombidium	373
Thysanura	361	Trophoblast	729
Tibia	482	Trophospongia	732
Tibio-tarsus	663	Trophozoite	105
Ticks	373	Tropidonotus	634
Tiedemann's bodies	258	Truncus arteriosus	591
Tiger	777	Trypanosoma	120
Tillotherium	766	Trypsin	27
Tinamou	689	Tse-tse fly	120, 359
Tissues	40-44	Tube-feet of brittle-star	262
Titanotherium	763	" of sea-urchin	264
Toads	605	" of starfish	258
Tornaria	439	Tubercle of rib	701
Torpedo	567	Tubifex	230
" electric organ of	532	Tubipora	164
Tortoises	613	Tubularia	171
Toxodon	765	Tunicata	443
Trabeculæ of skull	478	" classification of	456
Tracheæ	345	Tunicin	444
" of Arachnoidea	363	Tupaia	779
" of Mites	372	Turbellaria	180
" of Peripatus	320	" classification of	182
" of spider	346	Turtles	613
Tracheal gills	370	Tylenchus	205
Tracheata	318	Tylopoda	755
Trachomedusæ	173	Tympanic bulla	702, 705
Trachydosaurus	628	Tympanum	495
Trachymedusæ	171	Typhlopidae	634
Tragulina	756	Typhlosole	215
Trematoda	183	Tyroglyphus	372
Trematoda, classification of	188	UIN TATHERIUM	765
Treptoplax	136	Ulna	482
Trichechus	779	Umbilical cord	730
Trichina	207	" vesicle	729
Trichocephalus	206	Umbilicus of embryo	685
Trichocysts	96	" of feather	655
Trichoplax	136	Umbo	393
Trichoptera	360	Uncinate processes	636, 660
Tricladida	182		

	PAGE		PAGE
Ungulata	753	Vascular system of—	
Unio	393	" sea-urchin	267
Ureter	717, 718	" Sepia	408
Urethra	719	" skate	544
Urochorda	443	" spider	369
Urodela	606	" starfish	259
Urostyle	582	" Vertebrates	504
Ursidæ	778	Velarium	152
Ursus	778	Velella	173
Uterus	719	Veliger	416
" masculinus	719	Velum	150
Utriculus of ear	493	Venous system. <i>See</i> Vascular system.	
VACUOLES	44	Ventricles of brain	487
" contractile	90	" of heart	505
" food	90	Venus	426
Vagina	719	" flower-basket	133
Vagus nerve	490	" girdle	175
Vampire bat	783	Vermiform appendix	711
Vampyrus	783	Vertebra, parts of a	482, 630, 700
Varanidæ	629	Vertebral column	481
Variation	54, 151, 808	" of birds	648
Vas deferens	513	" of crocodile	636
Vascular system of—		" of frog	582
" Amphioxus	467	" of haddock	552
" Anodonta	398	" of lizard	623
" Arenicola	227	" of pigeon	659
" Ascidian	449	" of rabbit	700
" Balanoglossus	437	" of skate	533
" bee	337	" of snakes	630
" cockroach	330	Vertebrata	473
" crayfish	290	" affinities of Annelids	
" Crinoid	274	with	476
" Crocodilia	639	" ancestry of	475
" Dipnoi	575	" development of	514
" earthworm	216	" general characters	
" frog	591	of	473
" haddock	557	" classification of	475
" Helix	387	" gill-clefts of	474
" Hirudo	240	" heart of	505
" Insects	347	" and Invertebrata	7
" Lizards	625	" nervous system of	482
" Mammalia	695	" notochord of	481
" Myxine	520	" segmental symme-	
" Nemerteans	200	try of	474
" Peripatus	320	Vesiculæ seminales. <i>See</i> Re-	
" Petromyzon	525	productive system.	
" pigeon	667	Vesiculatæ	151
" rabbit	712	Vespertilio	783
" scorpion	365		

	PAGE		PAGE
Vesperugo	783	Whelk	420
Vestibule	719	Whip scorpions	366
Vestigial structures	40	White matter of brain	489, 709
Vibrissæ	699	" " of spinal cord	489
Vicugna	756	Wing of bat	781
Villi	731	" of Birds	663
Visceral arches	478	" of insect	341
" clefts	499	" of pterodactyl	645
" nerves	492	Wolf	777
Vitelline membrane of ovum	59	Wolffian duct	511
Vitreous humour	497	Wombat	747
Viverra	777	Worms	10, 11, 179
Viviparous Fishes	592	XANTHARPYIA	783
" Insects	349	Xenarthra	750
" Lizards	628	Xiphisternum	695
" Verrtebrates	515	Xiphosura	375
Vole	772	YAPOCK	746
Volvox	98	Yellow cells	113
Vorticella	96	Yolk	59
Vulva	699	" sac	683, 685, 728
WALKING-STICK insect	357	" " placenta	643, 733
" leaf	357	ZEBRA	762
Walrus	779	Zeuglodonts	771
Warm-blooded	696	Zoæa	315
Wasps	360	Zoantharia	164
Water bears	375	Zona radiata of ovum	513
Water scorpion, vascular sys- tem of—		Zoochlorellæ	113
" " Crinoid	274	Zoo-geographical regions	805
" " Holothurian	270	Zoonerythrin	130
" " Ophiuroid	262	Zoophytes	137
" " sea-urchin	266	Zygæna	567
" " starfish	258	Zygantrum	630
Weasel	778	Zygapophyses	700
Web of Spiders	371	Zygomantic arch	702, 775
Whales	766	Zygosphene	630
Wheel animalcule	245		

Printed by
MORRISON & GIBB LIMITED
Edinburgh

