

2
SF523
R878

STARTING RIGHT
WITH BEES

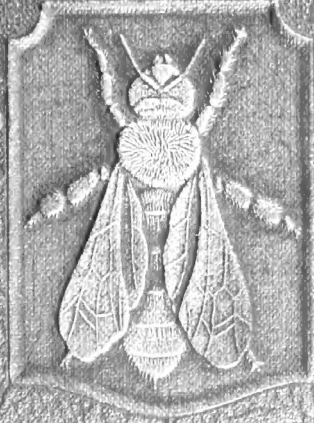

THE A. I. ROOT BEE LIBRARY

ALBERT R. MANN
LIBRARY
NEW YORK STATE COLLEGES
OF
AGRICULTURE AND HOME ECONOMICS
AT
CORNELL UNIVERSITY



EVERETT FRANKLIN PHILLIPS

BEEKEEPING LIBRARY
Gift of the
A. I. Root Company

Cornell University Library
SF 523.R878

Starting right with bees



3 1924 003 433 483

mann



Cornell University Library

The original of this book is in
the Cornell University Library.

There are no known copyright restrictions in
the United States on the use of the text.

STARTING RIGHT WITH BEES

Written by a Beginner in Beekeeping,
H. G. Rowe, Out of His Own Ex-
perience in Needing Help and Direction
During His First Two Years of Bee-
keeping. Read, Revised and Approved by
the Editors of Gleanings in Bee Culture.



First Edition
1922

Published by
THE A. I. ROOT COMPANY
MEDINA, OHIO



Age and youth alike find keen interest in bees. Here is A. I. Root, known throughout the wide world of beekeeping, in his eightieth year, examining a frame of bees, with a boy of a dozen years as helper.

THE HOW AND WHY OF THIS BOOK.

This book aims to give the beginner in beekeeping only the essentials of the business. It is an apiary primer, written out of the necessities of a humble beginner who did not find in any existing beekeeping literature the simple, direct, kindergarten sort of teaching that a beginner in beekeeping so much needs. He found books written by very able and very scholarly beekeepers who had had many years of experience with bees. But it seemed to this beginner that these beemasters were "shooting over his head," in their beginner books. They seemed to forget that he, as a beginner of the greenest type, did not know a frame from a section, nor that the drone or queen might not be the greatest honey gatherer in the hive. Knowing truly so much of bees and beekeeping themselves, these able authorities did not seem to comprehend how little he knew, and so they knew too much, in very fact, to write for the humble, bee-ignorant beginner.

So it was that this beginner, during the first season of his trialful beekeeping, set down daily in a notebook what he first wanted to know about bees and the simple directions that he needed—but could not find in the bee books. After the close of his first beekeeping season, this beginner read all the literature he could find that had been printed for the beginner, jotted down the omissions in this literature, and then wrote the first draft of "Starting Right with Bees." This was done in the fresh remembrance of many steps taken blindly, of many failures in things attempted, and in the chastened and contrite spirit of one many times needlessly stung. He completely revised this first draft of his modest essay into beekeeping literature at the close of his second beekeeping season. He had lived and learned—a little more. The manuscript was then given to the several Editors of *Gleanings in Bee Culture* to read, correct and add to as ruthlessly as they might. They were restricted only in one particular: that they humble themselves even as this little child of beekeeping and write nothing that he and the great army of beginner beekeepers everywhere could not understand. Mrs. Iona Fowls Wheeler and Mr. Geo. S. Demuth are to be credited in particular for valuable suggestions in the final revision of the manuscript.

The result is this book—for better or for worse than other books written for beginners in beekeeping.

It is hoped that these condensed lessons, if carefully studied, will start the beginner on the highway to success under normal conditions. Very many of the scientific and more intricate details of beekeeping will not be touched upon at all in these pages, as they are not necessary in the first steps and might serve only to confuse the novice.

Furthermore, this book will not as a rule attempt to give several different ways of performing a certain beekeeping operation or of meeting

a certain beekeeping problem, but will in each instance give a single simple and proved method. To give a choice of several methods serves only to confuse the beginner.

The reader will not expect to find treated herein such subjects as the anatomy and physiology of the bee, botany of honey-producing flora, queen-rearing, wax and comb production, pollination, honey chemistry, the history of the craft and its advancement, nor the commercial and food phases of honey. This booklet will confine itself to getting the beginner started in the care of bees and production of honey, and leave for his later experience and enthusiasm the scientific and technical phases of the subject.

That the path of many a beginner in beekeeping may be made smoother and shorter and straighter by this little book, and the stings and disappointments made very much fewer, is the hope of the author of this primary book.

H. G. ROWE.

SOME FIRST CONSIDERATIONS.

CHAPTER I.



Many a schoolboy is keeping bees.

its pursuit. Any person with fair health and strength by outdoor work, who is fairly studious and endowed with some patience and some love of nature, may very reasonably hope to become successful as a beekeeper. But the greater and wider the beekeeper's intelligence and powers of observation, the greater his success will be. Accordingly, he should be a reader of bee lore and natural history. Patience, persistence in fighting adverse circumstances, promptness in doing the right thing at the right time, and foresight are among the traits most necessary for successful beekeeping. It is not a business for the careless, the disorderly, nor for the lazy person. Successful beekeeping means work both for the brain and the hands. The very few persons who may despair of becoming good beekeepers are such as are hopelessly careless; those who have but little patience, and little or no love for the great outdoors; and the very few who are seriously affected by the poison of bee-stings and stand in constant dread of them. The normal person, with a little care, can avoid stings almost entirely and need have no fear of them. (See page 49.)

There are some general, practical considerations that the beginner needs to take into account before crossing the threshold of beekeeping, which may quite largely predetermine his attitude toward beekeeping, as to making it a profession or a side line or merely a pleasurable avocation.

Who Can Succeed with Bees.

Beekeeping is an occupation for old or young, rich or poor, men or women. It is for the professional man or woman, tired and worn with office work; and it is also for the vigorous man in his prime who seeks profit and pleasure alike from

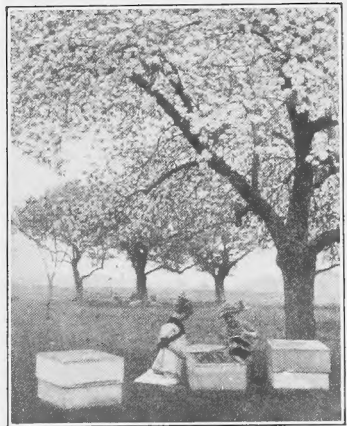

Even little kiddies can enjoy bees.

Profit from Beekeeping.

Many millions of dollars' worth of honey and beeswax are produced in the United States annually. This vast amount is distributed among many beekeepers—not equally, for there are lean years and fat years in different localities, much depending on varying conditions of weather and plant life, on the conditions of health and vigor within the hive, and on the market and selling methods—but most of all, on the skill of the beekeeper himself. There are professional beekeepers devoting themselves entirely to the business who make large incomes from their bees. They operate in favored localities, and, along with their experience, use the most up-to-date methods. Many beekeepers have secured more than 200 pounds of surplus honey in a single season from each of their colonies. (A colony of bees is merely a complete family of bees.) A normal colony will in a single season produce on an average about 50 to 100 pounds of surplus honey. Price of honey, operating expenses and the yield then determine the money profit.

To sum up conservatively the question of financial profit, it may be said that the successful beekeeper is very well paid in money alone for the time he spends in his work; and there is no other branch of agriculture which can be made to yield so great a return on so small an investment of capital as does beekeeping. In most cases, besides the money return, are to be reckoned the pleasure and fascination of beekeeping. It creates an absorbing interest in natural history and not only brings one in contact with the bees and all their wonderful habits but into the realm of plant life, a large part of which is dependent on the pollinating work of the bees, leading on to the study of floriculture and horticulture that opens up a whole new world of wonders.

Beekeeping Combined with Other Business.

Beekeeping can be combined with many other useful pursuits to advantage. For instance, the combination of beekeeping with poultry-raising and fruit-growing is an excellent, all-around means of getting a comfortable living from a comparatively small amount of land. A few acres are sufficient for these three activities.

For those who are finding themselves unable to do the hard work of earlier years the combination of bees and poultry is especially suited. Bees require least attention when poultry needs the most. When one is



Beekeeping and poultry-raising make a good combination.



Every orchard should have bees for greatest success.

busiest with fowls in winter and early spring, the bees are inactive in their hives. When swarms and the honey harvest must be looked after, work in the poultry-yard is not pressing.

In combination with fruit-growing, beekeeping is especially desirable. The bees fertilize the blossoms, and the blossoms furnish considerable nectar. In gathering the nectar of the fruit blossoms, bees unconsciously carry pollen from stamen to pistil and from one blossom to another, aiding in the setting of the fruit, thus materially increasing the size of the fruit crop. In fact, no up-to-date and successful orchardist of today thinks of trying to raise fruit without bees in or near his orchard.

Farmers, fruit-growers and poultry-raisers may keep from 10 to 50 or even 100 colonies of bees without interfering with other work; and nearly every one can keep from 2 to 10 colonies in a back yard. Moreover, 10 or 20 colonies will yield a much larger revenue per colony than will five or ten times as many located on the same site.

The busy farmer may expect success with bees, although they need much attention at the same time as do the farm crops. If the older children and the women folks of the family chance to love outdoors and take a fancy to bees, the problem of help and care of the bees in the busy farm season is at once solved. Then, too, if the farmer owns any orchards or is engaged in any small-fruit raising, he positively can not afford to be without at least a few colonies of bees on his premises. They should constitute an essential part of his business.

School-teachers who can have an apiary near at hand will find that they can use their vacation months very profitably among the bees, and this vacation time is just when the bees will need greatest attention. A Saturday given now and then in the fall and spring will afford all the time necessary for caring for the bees during these seasons.

Professional men, generally, and all classes confined to the indoors while at their regular work, may well look to beekeeping as a source of interesting recreation and profit.

When to Start.

For the beginner, inexperienced in beekeeping, the best time to start is during the fruit bloom or at the time of the first honey flow of any kind

that will give the bees a few days' food supply. This time will vary considerably because of different latitudes. In any latitude the beginner should start after possible early spring-managing problems are past. For instance, in the northern and north-central states of the United States this is during early fruit bloom. Of course, the experienced beekeeper may safely buy bees at any season of the year, and he often does so in the fall, because bees may then be bought at a much lower figure than in the early summer when there is a prospect of a honey crop near at hand.

How to Begin Beekeeping.

Before the beginner in beekeeping actually makes his start there are several things he may do to his very great advantage. If he can visit an experienced beekeeper for a day or several days and come to understand something of the appliances and methods used in beekeeping, it will be of much assistance in his future work. He will thus pick up a fund of information that might take him weeks or months to acquire from text-books or from his own experience. Almost any experienced beekeeper is ready to give an enthusiastic beginner a practical demonstration of many of the the manipulations of the hive. Again, in advance of beginning, the novice should read all the beekeeping literature that he can reasonably acquire. The more theory he gets in advance of his practice, the better off he will be. We can not too strongly urge both the visit to some experienced beekeeper and the reading of beekeeping lore when making the start.

The importance of beginning in a small way with bees and with as little expense as possible can not be emphasized too strongly. Nothing is more discouraging, after having plunged into the business too extensively, than to lose a large part of the bees either through bad wintering or from some other cause due to the lack of practical experience or to insufficient theoretical knowledge. Very many enthusiastic beginners in beekeeping have had their enthusiasm and love of bees killed by disaster due to starting too ambitiously. Sometimes a person is offered a bargain of 50 or 100 colonies of bees, including hives and implements, at a ridiculously low price. But this temptation should be put aside by the beginner, because it almost invariably leads to failure. Two or three colonies of bees are about the right number to start with. After the first year, the beginner will want at least as many as five colonies, and these will require beekeepers' supplies in such amount as to be bought in original packages, effecting a very considerable saving. The purchase at first of a large number of bee appliances and tools is as much to be avoided as is a beginning with too many bees. Get along with just as few appliances and as little expense as possible at first.

But before discussing equipment, a word ought to be said as to whether the beginner should seek to produce comb honey or extracted honey, for the work is quite different and the equipment somewhat different.

COMB HONEY OR EXTRACTED HONEY — WHICH?

CHAPTER II.

The honey which the bees produce in excess of their winter needs is called surplus honey. This may be stored in comb built in small boxes called sections, which hold about one pound of honey each and are sold with the honey; or it may be stored in combs built in "shallow" frames holding about three pounds, the honey being cut out and used or sold in the comb as chunk honey; or it may be extracted from the combs built in either "shallow" or "deep" frames and the same frames of combs used in the hive repeatedly year after year. The honey produced in the sections is called comb honey, and that extracted from the combs is called extracted honey.

Now at the very outset it will be necessary to decide whether to produce comb honey or extracted, for, as just explained, the equipment in the two cases will differ. There are several good reasons why the average beginner will find it to his advantage to produce extracted rather than comb honey, although many a beginner has first produced comb honey.

Comb and Extracted Honey Production Compared.

For the first year, the comb and the extracted honey outfits do not differ materially in price, except for the extractor; but in succeeding years the financial advantage is in favor of the extracted-honey production, for the same combs in which the bees store honey the first year may be used repeatedly year after year, while the sections and foundation in which comb honey is stored must be replaced at considerable cost every season.

Comb is made of wax, which is a secretion from certain glands of the bees; and for the production of a pound of wax it is probably necessary for the bees to consume five to fifteen pounds of honey, which might otherwise be sold as surplus. Therefore, besides the extra cost of supplies the beekeeper loses considerable from the fact that bees producing comb honey are compelled each year to build all the comb in which they store their surplus honey instead of using the same comb year after year as in the case of extracted-honey production. Such comb would quite likely contain as much as three pounds of wax and might, therefore, require fifteen or more pounds of honey for its production.

Comb-honey production requires far more skill in order to produce a good crop, and at the same time keep down swarming. The section boxes are so much smaller than the combs the bees naturally build that they do not enter them as readily as they do the large combs used in extracted-honey production. Therefore, considerable skill is sometimes necessary to induce bees to start work in section supers. Also, the extracted-honey beekeeper finds that giving an abundance of room helps greatly in the prevention of swarming, while the comb-honey man is compelled to keep his

colonies more crowded; for, otherwise, the end of the season will find him with a lot of unfinished sections, that is, sections only partly filled with honey. Extracting-combs of ripe honey two-thirds or more unsealed will, when extracted, result in first-class honey. Sections two-thirds sealed must be sold at a low price.

Furthermore, extracted honey may be produced in many localities and in many seasons when comb honey would be an absolute failure; for, in order that any quantity of comb in sections be built, it is necessary that the nights be warm, as it is during the warm nights that most of the wax is secreted and the comb built.

On the other hand, there is usually more honey left in the hive when the surplus honey is taken away at the end of the season when comb honey is produced than when extracted honey is produced. For this reason it is more often necessary to feed the bees when producing extracted honey unless combs of honey are saved out of the surplus for this purpose.

Often a beginner is able to find a larger beekeeper in his own locality who will be willing to do his extracting for a small sum. Even one cent a pound is a good bargain on both sides. If one prefers the satisfaction of doing his own extracting (and there is a real pleasure in it), he will be able to purchase a two-frame extractor at a moderate price. And this size will be quite large enough for some time for the beginner in bee-keeping. And, when he later decides to go into the business a little heavier, it will doubtless be possible to sell the small extractor and purchase a larger one, either new or second-hand.

Chunk Honey Production.

It is possible that a few may wish to produce chunk honey. If so, they should secure their surplus honey in what are called shallow extracting-supers. These contain frames shallower than the regular frames. When the frames are filled and the honey is sealed it is cut out in chunks, leaving as much as half an inch of comb next to the four sides of the frames. This fringe of comb serves the bees as a starter to begin work on for the next year's honey crop. The chunks of honey are packed in tin pails or glass jars and covered with liquid honey.

A serious objection to chunk honey put up this way is that the liquid portions will granulate in cold weather, making an unattractive package. We advise, therefore, that the beginner use extracting-combs rather than sections, and produce preferably extracted honey.

For the sake of those, however, who greatly prefer comb honey and find a keen delight in the beauty of the snow-white section just as it comes from the hive, we intend describing the outfit for comb honey as well as for extracted honey, and, in later chapters, give the management necessary for the production of both.

OUTFIT FOR EXTRACTED-HONEY PRODUCTION.

CHAPTER III.

In discussing the outfits for extracted-honey and for comb-honey production, it should be understood that the same brood-chamber and its equipment (cover, floor and frames) can be adapted to the production of either kind of honey by simply changing the supers.

The Hive to Use.

The hive is the house and home of the bee. What kind of hive to use is a question that presents itself foremost to every beginner. There are a great many kinds and sizes of hives. Beekeepers' literature for years has been filled with discussions as to which is the best kind of hive to use under various conditions. There are large hives and small hives, patented hives and hives made out of dry-goods boxes, and hives constructed of barrels or even of hollow logs. Formerly an old box or straw "skep" was used for a hive; and in those days beekeepers, when ready to harvest their honey, would place the box or skep over a pit containing burning sulphur; and when the bees had been suffocated by the brimstone fumes the hives were turned upside down and the combs of honey dug out. The honey was then strained through a cloth; and if some of the combs may have contained unemerged young bees and pollen (a bee-food material which has a strong taste), this "strained" honey of the olden days was not of the best flavor.

During the last 50 years a great change has taken place in the production of honey, and colonies of bees are no longer deprived of all their necessary food nor are the bees killed in the process of removing the surplus honey. While a colony of bees may produce honey in a hollow tree or box, yet the modern movable-frame hive (the inven-

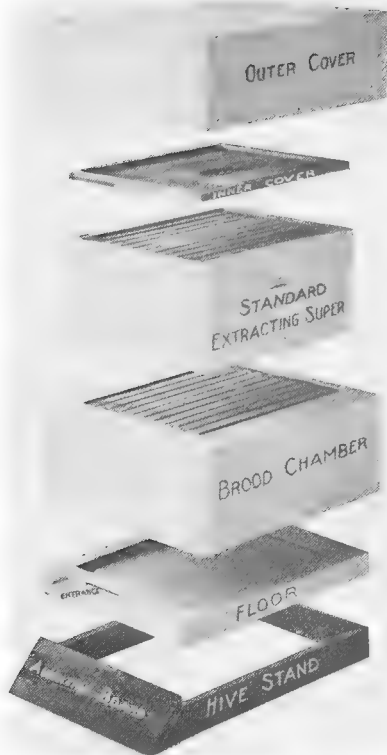

The several parts of a complete double-walled hive.

tion of Langstroth) is vastly more convenient in caring for the colony and in removing the surplus honey.

Omitting a whole volume of discussion that might be given concerning hives in general and in particular, we will say that the best hive for the beginner to start with today is the standard-sized, double-walled, movable-frame hive, consisting of a double-walled box, packed between the walls with chaff or planer shavings, this box with or without packed bottom, and large enough to hold 10 movable frames of "Langstroth" dimension, namely, $9\frac{7}{8} \times 17\frac{5}{8}$ inches, which size has come to be standard. The "Hoffman" frame, now almost universally used, is simply the Langstroth frame with a self-spacing device. (The single-walled hive, if the beginner some day becomes an experienced beekeeper, may better serve his purposes than the double-walled hive, but in beginning he will find beekeeping in double-walled hives easier and safer.) By looking at the accompanying illustrations of a hive for producing extracted honey, with its full equipment, it will be noted that the double-walled hive-body with its ten frames constitutes the hive proper or the brood-chamber. In this part of the hive the queen is ordinarily kept and the brood is reared.

Necessary Equipment for the Hive.

Beneath the brood-chamber is the floor (often called the bottom-board) with its movable entrance-contracting cleat at the front by means of which a wide or narrow entrance can be made as the season or needs of the hive demand. One side of the floor provides for a $\frac{7}{8}$ -inch entrance, and the other side a $\frac{3}{8}$ -inch entrance. The $\frac{7}{8}$ -inch entrance is preferred the year round by most beekeepers; but this large entrance is opened its full size only during warm weather, being contracted at other times according to the needs of the colony. Underneath the floor is the hive-stand with its sloping alighting-board reaching from the ground up to the entrance. (Above the brood-chamber, and between it and the super is placed the queen-excluder when in use, which is a framework with wires spaced $163/1000$ —almost $1/6$ —of an inch apart. The worker bees can pass between the wires readily; but the queen on account of her larger size, can not.) Above the brood-chamber (or above the queen-excluder if in use) is the super, or upper story. This is called a "super" because it is above the hive proper, and it serves to receive the superabundance of honey, which is the honey surplus gathered by the bees above their own needs as food. The super is not used for brood-rearing, except when temporarily used to give additional brood-rearing space in the spring and to

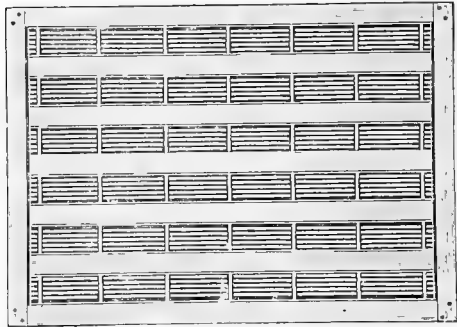

Wood-and-wire queen-excluder, which is placed between the brood-chamber and the super to keep the queen from going above.

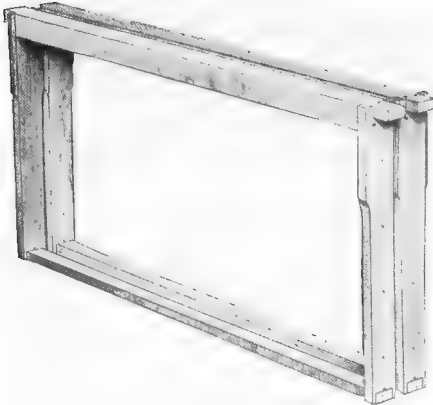

Hoffman self-spaced frames, full depth, size 9 $\frac{1}{2}$ by 17 $\frac{1}{2}$ inches, regularly used in the brood-chamber and deep super.

prevent swarming (which will be explained later). When the super is used for brood-rearing it is called a second brood-chamber. Several supers, one above the other, may be placed above one brood-chamber, as the amount of the honey being gathered may demand.

In both the extracting-supers and the brood-chamber are frames which hang closely side by side, suspended at the ends of the hive from metal supports which are fastened in rabbets cut in the upper edges of the hive ends. Inside these frames are sheets of

foundation. These are sheets of beeswax which have been embossed to imitate the septum in the middle of naturally built honeycomb. The bees build the foundation out into comb. These frames of comb may be moved about or lifted out freely, either to examine the bees or to remove the surplus honey. This movability of the combs is the main difference between the old box hive or skep and the modern hive. Extracted-honey supers are either deep or shallow. The deep extracting-supers contain extracting-frames of the same dimensions and construction as the brood-frames in the brood-chamber below. But the shallow extracting-super and its frames are shallower than the brood-chamber and the brood-frames, in some cases being the same depth as the comb-honey supers. The shallow super has the advantage of lightness in handling, which is an important consideration for women beekeepers. It also provides a way to prevent the bees from mixing different kinds of honey, as buckwheat and basswood, or orange and sage. For at the close of one honey flow a deep super might be half filled, mostly with unsealed honey, which, not being sufficiently ripened for extracting, must be left on the hive and so mixed with the honey of the next honey flow of a different kind. Whereas, if a shallow extracting-super had been used, it would have been filled and sufficiently sealed to be taken off, and the new honey flow would not be mixed with a previous honey flow. The beginner will understand that one kind of honey may be of much better quality and bring a higher price than another, and so the mixing of a high-quality honey with an inferior kind is to be avoided if possible. Although the shallow super has many advantages, it is, however, true that the majority prefer full-depth supers of the same

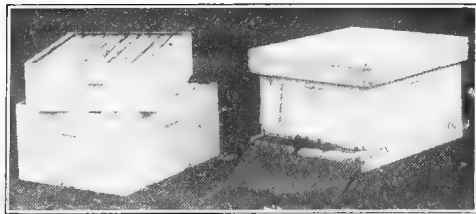

At the left are a shallow and a deep extracting-super. The deep super (the lower one) is the same size as the single-walled brood-chamber at the right.

size as the brood-chamber below so that they may easily interchange the combs of the supers and those of the brood-chamber as desired.

Above the uppermost super is a cleated board, called an inner cover; and, over all, a telescoping metal cover.

When the beekeeper desires to remove full supers of honey a board (called a bee-escape board) is slipped between the supers and the brood-chamber below. In the center of the board is a trap called a Porter bee-escape. The bees can then pass down from the supers into the chamber below, but can not get back again.

By using this bee-escape, in twelve to twenty-four hours the full supers of honey can be removed with scarcely a bee in them, and actually without the knowledge of the bees in the brood-chamber below. This escape-board, without the Porter bee-escape and with the hole closed, is generally used as an inner cover.

In addition to this equipment for the summer season, one will need a chaff tray for each hive to give extra warmth during the winter. Such a tray, filled with chaff or dry leaves, fits directly under the telescoping cover. (See "Wintering," page 103.)

The double-walled hive is recommended to the beginner because in temperate regions it is both warmer in winter and cooler in summer, and requires less trouble in preparing for winter. But single-walled hives are in very general use in both the warm South and the cold North.

These are identical and interchangeable with the full-depth supers. (In fact, the single-walled hive-body may be used either as a brood-chamber or a super.) They differ from the double-walled hives in that the hive-body has a single wall. These single-walled hives will ordinarily enable the bees to withstand the winter chill of the South if given a little top packing (some Southerners prefer side pack-



A single-walled brood-chamber on which is a shallow extracting-super, with the beekeeper about to place a deep super above the shallow super.

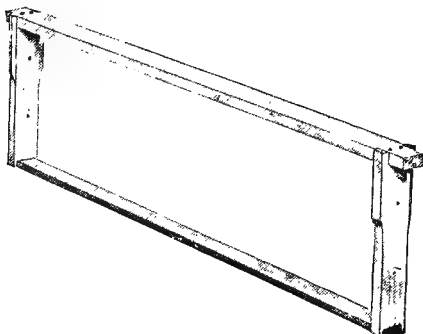

Shallow self-spaced extracting-frame for use in shallow super.

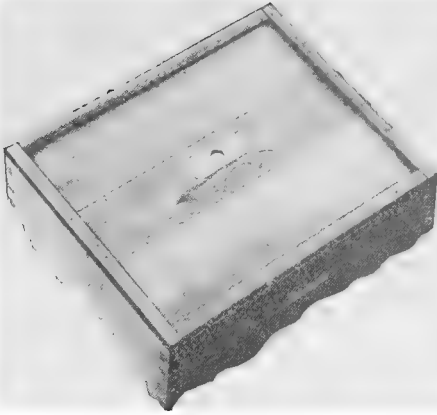

A bee-escape board, and used generally as an inner cover.

bought either already nailed and painted (NP), or in the flat "knocked down (KD)" and unpainted. Unless the beginner is handy with tools he had better go to the little additional expense of buying his first hive nailed and painted all ready for use.

A plain division-board should be purchased with each hive, for it may become necessary at any time to contract the bees' living-space in the interior of the hive. The division-board is of the same shape as the frame, but may be so made that it will shut out the bees from the unoccupied part of a hive when some of the frames have been removed on account of the smallness of a colony.

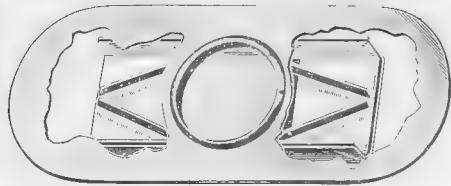

The Porter bee-escape, which is placed in the bee-escape board and traps the bees out of the supers.

Within the hive, filling the frames, are the wax combs filled with brood and food stores of the bees. Man has succeeded in controlling the manner in which the cells of the combs are erected, their size, and their arrangement. By placing in



Loose-hanging division-board. It can be made tight-fitting by tacking a piece of oilcloth around the edges.

frames thin sheets of bees-wax which are embossed with the figure of the worker-cells, the bees can be made to build comb from which workers alone can be reared. These embossed sheets are known as comb foundation, which in modern apiculture is an indispensable article. It is

OUTFIT FOR EXTRACTED-HONEY PRODUCTION.—Chapter III.

used either in narrow strips (rarely) called "foundation-starters," or (usually) in full sheets. The full sheets are preferable, because they induce the bees to build more nearly perfect combs of worker-cells, saving them labor and consumption of honey in comb-making. Comb built from starters only is liable to contain a large number of drone-cells. Practically all

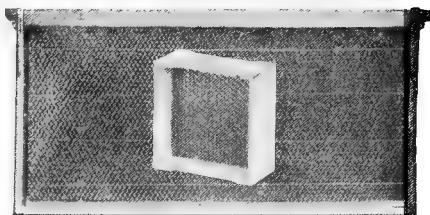

A full-depth frame with full sheet of foundation; in front of this, a comb-honey section with full sheet of foundation.

the combs today are built on comb foundation. This foundation contains more wax in the initial cells than does natural comb in its initial cells; but this surplus wax is used by the bees in drawing out the comb.

The covers of the hive consist of a thin, flat inner cover and a large metal-covered telescoping outer cover. The inner cover, as before told, is often only a bee-escape board, with a small piece of wood tacked over the opening for the bee-escape.

As a final word about hives, let us emphatically advise the beginner to have only one style and one size of hive, with all parts of as many hives as he may have interchangeable. All frames of brood or honey, all supers, covers, floors or sections should fit each and every one of his hives. With such interchangeable equipment he will save himself much time and untold annoyance.

Assuming, then, that the beginner expects to produce extracted honey, he will have as his hive equipment one double-walled ten-frame hive with its floor and stand, queen-excluder, bee-escape board, division-board, chaff tray, inside and outside covers, two or three supers, and wired frames containing sheets of comb foundation sufficient in number to fill the brood-chamber and the two or three supers.

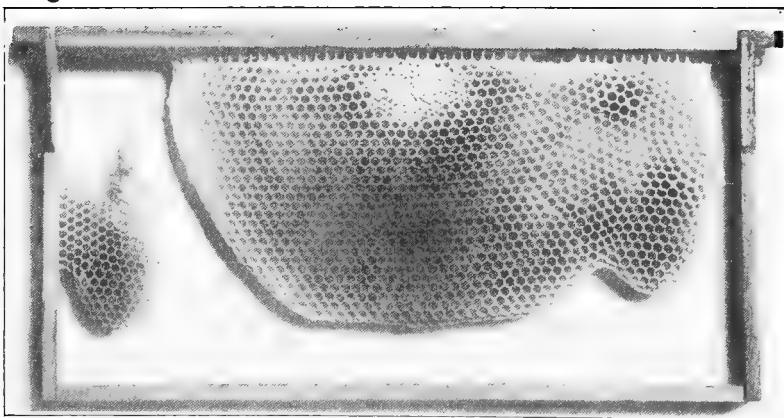

Comb built by the bees without foundation. It is irregular and contains many drone-cells.

Other First Equipment.

Among the rest of the equipment necessary, the bee-smoker, perhaps, should be mentioned first as being most indispensable. Bees can be controlled and safely handled only by the application of smoke, and it is the smoker that affords this aid and protection in bee-keeping. It consists of a metal cylinder in which greasy waste, rags, rotten wood, or planer shavings are burned. A bellows connected with this cylinder forces air up through the fuel and blows the smoke out at a nozzle in front, just where it can be directed to the best advantage.

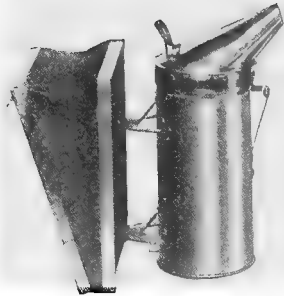

A good bee-smoker is one of the most essential parts of the equipment for handling bees.

There are a number of different makes and different sizes of smokers. The smallest, suitable for a beginner's first endeavors, has a barrel $3\frac{1}{4}$ inches in diameter. Don't get a smaller one.

A bee-veil is another essential for the beginner. The experienced beekeeper sometimes works without a veil; but there are times when every beekeeper requires one to prevent stinging about the face and neck. The wearing of a veil gives a sense of security that can not otherwise be had.



Every beginner in beekeeping needs a good bee-veil.

The beginner should have a pair of loose-fitting bee-gloves. Ordinarily, the veteran beekeeper does not use gloves at all; yet there are times when even he may find them advantageous as a protection from angry stinging bees.

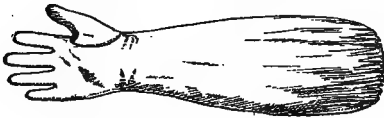

Bee-gloves give the beginner a feeling of protection against stings.

For opening hives and prying apart frames a hive-tool is to be strongly recommended to the beginner as doing better work than either a strong screwdriver or a knife. This tool is very handy in separating the frames and the parts of the hive when examining them, because the bees make use of propolis, or bee glue, in cementing the frames together.

A bee-brush is very handy in some hive operations. It is used for brushing the bees from the combs. (But a bunch of long grass or weeds will serve this purpose.)

An uncapping-knife is necessary for one who intends to extract his own honey. This knife



The useful hive-tool.

is to slice off the thin layer of wax called "cappings," which seals the cells of the comb. This uncapping of the combs is necessary before extracting can be done. The blade and the handle of this knife are both specially shaped for this purpose.



Uncapping-knife.



Bristle bee-brush.

Finally, if one has to extract his own honey, a honey-extractor is necessary. This is the machine in which the combs are placed to extract the honey from them. The wax cappings having been sliced off, the honey is whirled from the cells by centrifugal force. The accompanying cut shows what an extractor is like.

In making this list of really necessary items in first equipment we have assumed that the beginner will buy his frames with full sheets of foundation already fastened in them by the manufacturer. When having become a more extensive beekeeper, he comes to buy foundation separately, he will need a wire imbedder with which to fix the foundation firmly to the wire in the frames.

To sum up, the list of the beginner's full outfit for producing extracted honey is as follows: A double-walled 10-frame hive with its floor and stand, queen-excluder, bee-escape board, division-board, chaff tray, two or three supers, wired frames containing sheets of foundation sufficient to fill the hive and supers, inner and outer covers; and smoker, bee-veil, gloves, hive-tool, bee-brush, uncapping-knife and honey-extractor.

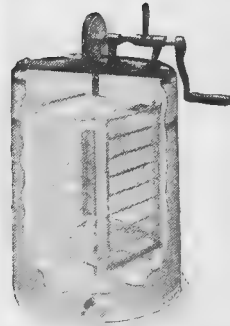

A two-frame honey-extractor.

OUTFIT FOR COMB-HONEY PRODUCTION.

CHAPTER IV.

The beginner who decides to produce comb honey will need all of the equipment previously described except uncapping-knife and extractor, the supers, however, being different. The uncapping-knife and extractor are used only in removing honey from the combs; in the case of comb honey, the honey is not removed from the comb of the small sections, but is used or sold in such sections just as the bees have stored it. Some beekeepers do not use the queen-excluder in the production of comb honey because they claim the queen is not inclined to leave the brood-chamber and go above into the small comb-honey sections where eggs and brood are not wanted. While this is true, the queen does sometimes go above and start brood in the sections when bait combs are used, if any of these contain drone comb because only foundation-starters were used. But queen-excluders are seldom needed in the production of comb honey.

For comb-honey production, instead of the large extracted-honey supers, three or four small comb-honey supers will be needed. These supers may be the same size (or about the same size) as shallow extracting-supers. These hold seven or eight section-holders, each of these section-holders in turn holding four sections. The sections are small, four-sided, light frames, usually made of a single piece of basswood cut in such a manner that it can be folded and the dove-tailed ends fastened together. Suspended from the top of each of these sections is a sheet of foundation which reaches nearly to the sides and bottom of the section. Between the rows of sections are thin wooden separators which prevent the bees from building the combs beyond the edges of the sections, so that the sections will all be built out uniformly. Between the side of the super and the last section-holder is inserted a follower, which is a thin board of the same length and height as the section-holders. Super springs are placed between the follower and

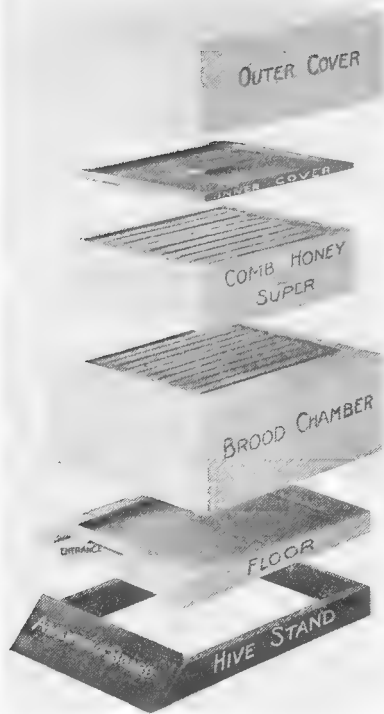

Double-walled hive complete, with a comb-honey super.

OUTFIT FOR COMB-HONEY PRODUCTION.—Chapter IV.

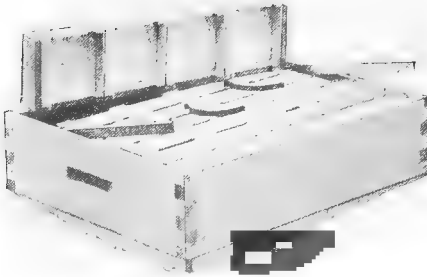

$4\frac{1}{4} \times 4\frac{1}{4} \times 1\frac{1}{2}$ beeway section super.

the side of the super to keep the sections tightly wedged in place and prevent cracks between them in which bees might deposit propolis and thus injure the appearance of the sections. The supers and sections just described are most commonly preferred, being made for sections having a beeway cut out at the top and bottom, making the top and

bottom narrower than the sides, thus affording spaces for the bees to enter the sections. Some use supers containing sections that have no beeway



Beeway section-holder.



Beeway separator.

at the top and bottom. In this case wooden fences are used between the rows of sections, these fences having cleats to hold the sections apart to admit the bees between them. Between the last fence and the side of the super are three springs. The springs are to hold the sections and fences tightly together.

To sum up, the list of the beginner's outfit for producing comb honey is as follows: A double-walled 10-frame hive with its full equipment, having the comb-honey super, the smoker, bee-veil, gloves, hive-tool and bee-brush.

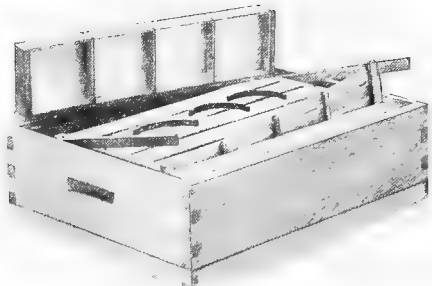

$4\frac{1}{4} \times 4\frac{1}{4} \times 1\frac{1}{2}$ plain section super.



Plain section-holder.

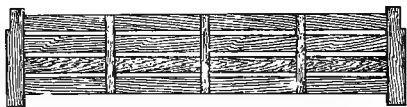

Fence used with plain section-holder.

GETTING THE BEES.

CHAPTER V.

There is no phase of beekeeping that the beginner regards with more apprehension than the difficulties and problems in securing his first bees.

What Kind to Get.

In choosing a strain of bees, select the Italians, always recognizable by at least three yellow bands on the forward segments of the abdomen. There may be five such bands on the strain known as "goldens." The other strains (not quite so handsome) are called "leather-colored." Race and heredity are all in favor of the Italians. They are the easiest of all bees to work with, being prolific, gentle, very active, very industrious, handsomest of all bees, most resistant to disease and enemies, and have the longest tongues for gathering honey. We shall not consider the German or black bees (the original stock brought to America), Carniolans, Cyprians, Caucasians, etc. However, the beginner is likely to have some experience with hybrid bees, which are usually a cross between the black and the Italian bees. A hybrid colony may, during the summer, be changed in less than three months to pure Italian by giving the half-breed colony a purely mated Italian queen. (See *Requeening*," page 96.)

The Easiest and Safest Way to Buy Bees.

In getting his first bees the beginner will find it most satisfactory and easiest to buy a good full colony in a standard movable-frame hive. Although this way of getting the first bees is the most expensive method, yet there is good authority for saying that it will prove cheapest in the end. They will cost less in the middle and late summer. A local beekeeper will perhaps sell a beginner such a colony; or the full colonies (or packages of bees) can be secured from dealers in bees and queens or from beekeepers' supply houses. They will cost most if bought from a distant dealer.

When the full colony has been received by the beginner, all he has to do is to remove from the hive any screens that may have been used in moving the bees and place the hive on its permanent location, open the entrance, and let the bees go to work. It is assumed that the colony has a good laying queen, and that in the brood-frames (the frames in the brood-chamber) are some stores of honey and some brood in all stages of development, as well as worker bees covering practically all the comb surface of the ten frames. (If honey stores are lacking, and the bees chance to be received when the weather is cold and wet, or when the bees can find no nectar in their flights, artificial feeding must be resorted to. See "*Method of Feeding*," page 100.) The bees should have sufficient food to last them until they begin gathering nectar.

How and What to Look for When Buying.

If possible, the beginner should buy full colonies from near home, because he is likely to know of the honesty and experience of the beekeeper from whom he buys and can be sure his bees are free from disease. If the beginner can have an experienced beekeeper go with him to select the colonies he is to purchase, and to assure him that they are strong, free from disease, and have a good queen, it will prove a great advantage.

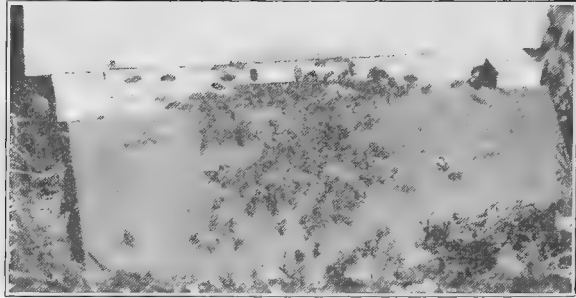

Normal scene at entrance of hive.

But if he must of necessity buy his one or two colonies for himself, let him look to these points: Examine them on a warm day when the bees are flying freely (we assume it is one of the first warm spells of full springtime—if possible, during the fruit bloom); walk past the hives and watch the flight of the bees. Note if the bees coming to any one hive are bringing in pollen (colored pellets) on their legs, for this is a strong indication of a thrifty colony. If pollen is not being brought into a hive by its bees, they lack energy and are likely to be without a queen and without brood (on which the future strength and honey-gathering power of the hive depend). Open the hive (or have the owner open it) by carefully lifting the cover from the top. (See page 49 on “How to Avoid Being Stung.”) See that the combs are straight in the frames (not bulged sidewise anywhere). See that

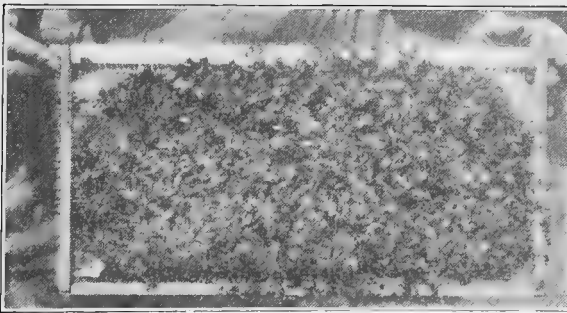

A normally full frame of bees.

bees cover pretty evenly five to seven combs in the hive (although many may be afield in midday of a warm day, and so the number may be hard to estimate). See that there is a large percentage of worker-cells in the combs,

which are the smallest cells of the comb—slightly smaller than the drone-cells (see page 45 on “Cells and Their Arrangement”); and see that these cells have brood started in many of them, and that the queen is laying a

single egg in each cell and is seldom skipping a cell. See that there is enough sealed honey in the hive to feed the bees till the opening of the main honey flow—enough to fill two full frames in all. If the beginner will be sure of these conditions and will get the guarantee of the owner that the bees are free from all disease, he will be pretty certain to get good colonies. As to the hive itself, unless of modern make and in good condition, it is worthless except as a conveyance for carrying the bees to good hives ready at his home.

Moving the Bees Home.

After buying the bees, and when ready to take them home, go early in the afternoon to the apiary while the bees are flying. Nail wire cloth to the top of a rim two inches deep, the same size as the top of the hives (instead of this rim, an empty super may be used, if desired); then, removing the hive cover, nail or staple this rim or super to the top of the hive-body

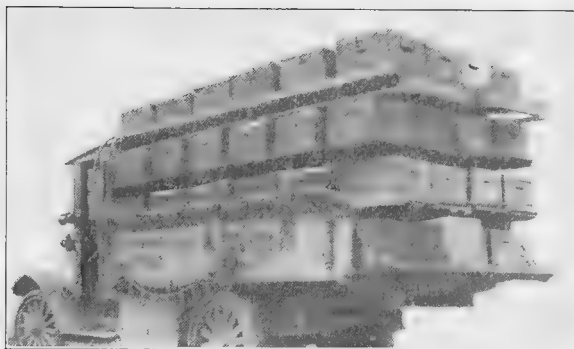

A big load of hives, full of bees, on an auto truck, ready for a long trip.

so tight that no bees can escape. If the hive has a loose floor, fasten this securely to the hive by means of a large staple at each corner. Toward night, as soon as the bees have done flying for the day and have returned to the hive, securely screen the entrance, thus closing it, and if the weather be hot, screen the entire bottom the same as the top. The bees will make an uproar and crowd the screen if they get too hot. They should then be sprinkled from the top with cold water. If it be chilly weather, the top screen may be partly covered. Load the bees on a spring wagon or one having straw in the bottom of the wagon-box on which to place the hives, as jarring should be avoided as much as possible. An automobile will serve much better. The hives should be so loaded that the length of the frames will be in the direction of the jolt. Drive home after dark. Place the hives on their permanent location, at once open the entrance, and put on the cover. The screen on the top of the hive should be removed the next day.

Upon first leaving the hive at its new location, the bees fly around and around close to the entrance for a time, gradually increasing their flight distance, till they have marked the location so certainly that they can return directly to it from any direction or distance. The actions of mature bees in marking a new location are the same as those of young bees in their marking their location upon first leaving the parent hive.

If the distance from the place where the bees are purchased to where

they are to be permanently located is less than two miles, there is danger that many of the bees, after being moved, will return to their former location. To avoid this they should be first moved to a place at least two miles distant from both their first location and permanent location, and left there for two or three weeks. At the end of this time they may be moved to their permanent location, with no danger of any bees returning to their former home. Again, if it is desired to move bees only a very short distance, from a next-door neighbor's or even within the owner's apiary, it is easiest to move them very short distances successively, say a foot every two or three days at first. If it is apparent that the increased distance does not confuse the bees, increase the moving distance to perhaps a yard till they have reached the desired location.

Buying Nuclei.

Buying a nucleus, which is merely a small colony on from one to five combs (a full colony covers from six to ten combs), is a common method of beginning, and it is not so expensive at the start as buying a full colony. A nucleus of two frames, with about a quart of bees, will soon build up into a full colony if there is plenty of nectar and pollen for the bees to begin harvesting at once, or if properly fed with sugar syrup. In buying a nucleus it is not safe to take every man's word for the condition of the bees unless the seller is known to be reliable. Be sure that he is so, for there is danger of getting poor bees, a poor queen, and disease when buying bees in this way. The beginner should keep in mind that a nucleus differs from a colony (full colony) only in the number of bees. The size of nuclei is designated as one-frame, two-frame, three-frame, four-frame or five-frame nuclei, as the amount of bees in the nucleus may be sufficient to cover one, two, three, four or five frames. The one-frame nucleus with frame and shipping

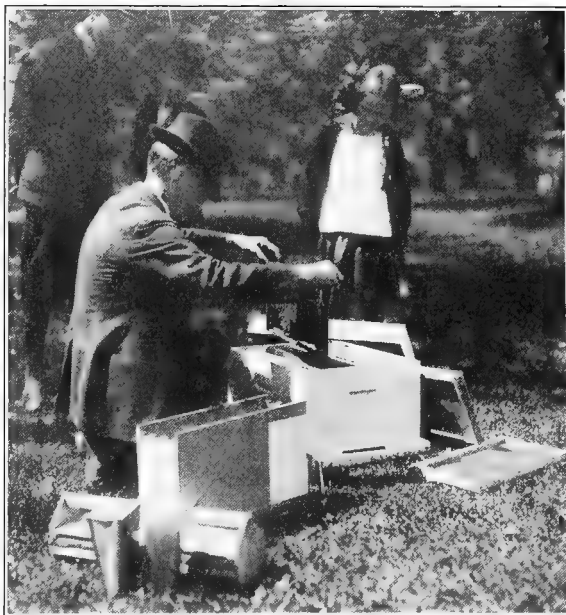

Taking bees from a nucleus shipping case and putting them in a hive.

box will weigh from four to seven pounds, and the five-frame from 20 to 28 pounds (shipping weight). These nuclei can be bought from any reliable bee-breeder (although bees are now being more and more sold in packages). They are ordinarily shipped by express in a nucleus shipping case or nucleus box, but they may be shipped in a full-sized hive. Directions for caring for the bees on arrival accompany all shipments, and these should be carefully followed. A division-board may well be used at the side of the exposed comb. After the bees have been placed in their hive, an additional frame of drawn comb or foundation should be put in as soon as the comb in the nucleus frame has become filled with brood and stores, and there are plenty of bees to cover the brood. This giving of additional frames of drawn comb or foundation should be continued until the hive is filled. If there are only one or two frames of bees the entrance should be contracted to one or two inches in width; and, if the weather is cool, the entrance should not be more than $\frac{3}{8}$ of an inch deep. If the bees of a nucleus are received in a hive instead of in a nucleus box or shipping case, at once place the hive in its permanent position, and, after smoking the bees, carefully remove the screen from over the entrance, allowing the bees a chance for flight. Also loosen and remove the screen covering the top and put on the regular cover. The floor of the hive is fastened on with brads or nails which can be taken out if desired. When the bees have become quiet the combs may be examined to see if they contain brood in all stages of development as well as eggs, thus indicating that the colony has a normal queen. (See page 57.) It is not necessary to find the queen to know that she is in the hive, since the presence of worker eggs tells us she has been there within three days. If no eggs are seen in the cells, and the bees are starting the large cells known as queen-cells (see page 37), one may be sure that the queen is missing. Sometimes the queen is not readily found. She may be only a little larger than the worker bees or she may be nervous and inclined to hide. In such cases her presence may be recognized only by her egg-laying and the absence of any queen-cells. If the queen is missing, one must at once be secured for the nucleus and introduced immediately. (See page 60). If the bees are short of stores in the combs, give them a little sugar syrup (see page 100), which will serve as stimulative feeding to encourage breeding. Do not let them starve. (See page 111.)

Buying Swarms.

Buying a good-sized swarm of bees from a neighboring beekeeper, or finding such a swarm at large which nobody claims, and capturing it, is, perhaps, in the majority of instances, the most satisfactory method of getting a start. (Don't confuse swarms with colonies. A swarm is a family of bees which has left the parent hive to seek a new home.) When buying swarms from some beekeeper, arrangement should be made for the purchase of them in advance. Empty hives may be left with the beekeeper for hiving the swarms when they issue from his colonies. The beginner can then get his bees at his own convenience. As a swarm almost invariably is accompanied by a queen, the purchase of a swarm provides for the complete stocking of a hive. If the beginner has decided on a trial of beekeeping because of the finding of some stray swarm clustering somewhere on his premises, let him shake the swarm from their clustering place into

a sack (an ordinary grain-sack or cleaned phosphate sack will do), or shake it into a box and cover the same; then take the swarm to a hive made ready and dump the bees in front of the entrance, being sure to have provided an easy way for the bees to crawl up into the entrance. The bees will quickly find their way into the hive and at once adopt it as their own home, provided, of course, that the queen enters, which she ordinary does. No bees work with so great energy as do those of a prime swarm (which is the first swarm of the season to issue from a colony); therefore the method of buying a swarm or capturing one is, perhaps, the most economical and satisfactory way of all for the novice to begin beekeeping; but, unless the swarms are secured early in the season, they are not likely to produce surplus honey the first year.

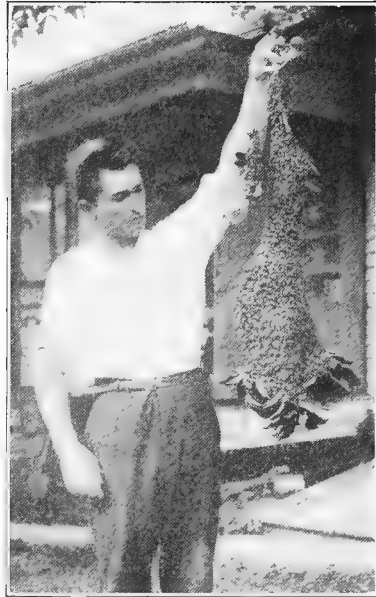

A swarm of bees cut from a branch of a tree.

Buying Bees by the Pound.

Buying bees by the pound is another way for the beginner to start. This is not an easy way, though inexpensive. Too small a package should not be purchased—never less than two pounds. Bees can be bought in this way from any regular bee-rearer. They are shipped in what is known as a combless package, which is a specially devised box with arrangement for feeding the bees while *en route* from the bee-rearer to the purchaser. An experienced beekeeper can take half a pound of bees bought thus and

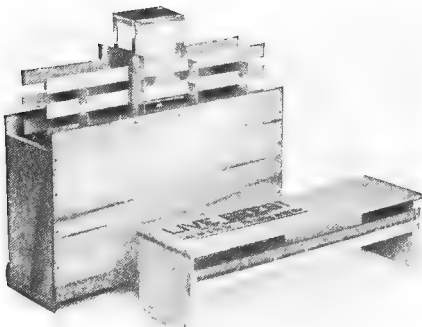

A combless bee-shipping cage in which bees bought by the pound are shipped.

build them up to a full-sized colony during the first season; but a beginner should take nothing less than a two-pound package. The hive that has been selected to receive bees purchased by package should be provided, if possible, with frames containing drawn combs (that is, combs already built and ready for the bees to work in, not merely frames of foundation), as bees shipped in a combless package increase much more rapidly on

drawn combs than on foundation alone. A queen should be purchased to come with the bees. In ordering, be sure, then, to order a queen and have her introduced to the bees before shipment. A pound of bees needs at first about three combs, more being added later as they are needed. Two pounds of bees should be hived on not less than four combs to start with. Combless packages of bees are accompanied by specific printed directions as to handling them, which directions should be carefully followed.

Buying Bees in Box Hives and Transferring.

Buying bees in an old-fashioned box hive is likely to be an inexpensive way so far as money paid for them is concerned, but likely to be quite difficult for the beginner. In the old-fashioned box hive (often called a "gum" or skep") the bees build their combs crooked and attach them solidly to the interior. There being no movable frames in this kind of "hive" or box, the only examination that can be made in advance to tell whether

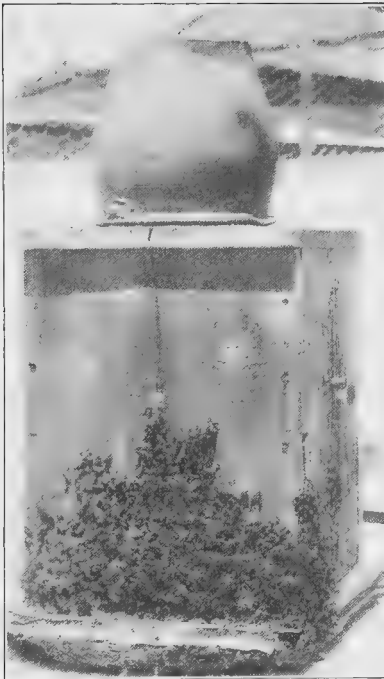

An old box hive that has no place in good beekeeping.

the bees and combs are in good condition is by tilting the hive and looking in from below. Having bought bees in box hives, log "gums," or straw "skeps" they must be transferred into movable-frame hives. This should be done during a honey flow when the bees are best-natured and least likely to rob. This transferring is not difficult to do when the old box hive permits the new hive to be fitted securely to it at the top, with no openings left between. But when the box hive is of such odd shape or so dilapidated that this cannot be done, then it may be necessary to employ the following common but difficult way of transferring, which we will explain before giving the easier method.

Before beginning this way of transferring, the beginner must provide himself with as many new hives fully equipped as he has old box hives or "gums." He will need for this work a hammer, a cold-chisel, a fine-tooth saw, some tacks, a ball of string, a long-bladed knife (a common butcher-knife will do), a box that will fit on top of the box hive without leaving too much space between them through which the bees can escape, and a large board or cover on which to place the combs when cutting them to size to fit the movable frames. He will also require a pail of water to wash his hands and tools frequently, as they will become intolerably stuck up with honey.

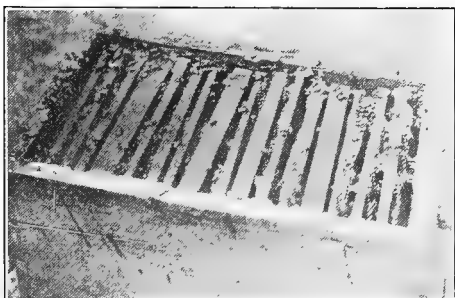

Combs in a box hive are built crooked and often in a solid mass.

outside of the box hive with sticks or clubs, keeping this up until all or nearly all the bees have crawled up into the empty box that has been placed on top. The bees that have now gathered in this box should be emptied in front of the entrance of the new hive as in hiving a swarm (see page 67). If the bees do not readily enter the new hive, it is well to gently brush or smoke them toward the entrance. To prevent robbing, the old "gum" or beehive should now be taken into a bee-tight building or a bee-tent placed over it for the rest of the work unless there are no other colonies of bees in the neighborhood, in which case the work can be done outside. One side of the old box hive or "gum" is now removed, first cutting the comb loose from the side to be removed, when the best and largest of the combs are cut out with the long-bladed knife. The next problem is to cut the best of the pieces of comb (by best are meant those which are regular and straight and contain almost entirely worker-cells or worker-brood), so they will fit tightly in the empty frames that are at hand and ready. To accomplish this, first cut several pieces of string long enough to tie around a frame and lay them across a board or hive-cover provided for this purpose; then lay a slab of comb or pieces of comb fitted together on the board or hive-cover above the strings, and lay over it the empty frame. The knife is now drawn along next to the inside of the frame, marking its exact size and shape on the comb. The frame is then lifted off and the comb trimmed to the required size and fitted into the frame. Care should be taken to cut the comb

First, a little smoke should be blown into the entrance of the box hive or "gum," after which it is lifted off its stand and a modern hive put in its place. The old hive should now be turned upside down, the bottom (if there be a bottom) removed and smoke blown down between the combs, and the extra box (above referred to) placed over it. The operator should now drum vigorously on the

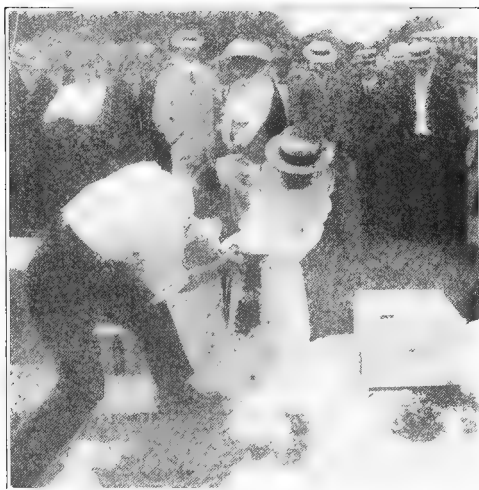

Transferring a colony of bees from a box hive to a modern movable-frame hive. Even womankind can undergo the ordeal.

large enough to make it a snug fit. Now bring the ends of the strings together and tie them around the frame and fitted comb. The several strands of string should come opposite the small pieces of comb and hold them all in place. No bulging of the comb must be allowed; for, unless sufficient space is left between the combs when placed in the hive, the bees will attach the combs to each other so that it will be impossible to remove them from the hive. All patches of drone comb should be rejected and melted into wax, along with other undesirable comb. An excess of drones is not only an added expense to the colony but also an inducement to swarm. The frames containing the pieced combs may now be put into the new hive; and in a few days, when the bees have fastened the pieces to the frame and connected them with each other, the bees will gnaw the string to pieces. If these combs are not straight and regular, they should be removed from the hive and melted the next spring and replaced with frames containing full sheets of foundation if they are empty at that time. No honey or scraps of comb should be left exposed, but all such should be dumped into a closed box to keep them away from robber bees. At the close of this work of transferring, everything should be washed up clean to prevent the starting of robbing by other bees. If all worthless comb of the old box hive is rejected, it is likely there will be unfilled space in the new hive. This should be filled either with good combs from other hives or with frames of foundation placed at the sides of the brood, and the bees will stay together on the brood and keep it warm. Usually the best time to do this work of transferring from the old box hives to new hives is in the spring during fruit bloom when the combs are light and without much honey, and when the bees will be working on the bloom and so not likely to start robbing. Transferring can be done, however, at any time when there is a honey flow and should not be undertaken at a time when honey is not coming in; and, if it has to be undertaken during or following the main honey harvest, the combs will be very heavy and disagreeable to handle.

A very easy method of transferring in warm weather (which may be used when the new hive can be made to fit on top of the old hive) is to lay the old hive on its side, if this can be done and its combs left perpendicular. Then tear off the upper side of the old hive and place the new hive without its floor on top of it. Any cracks between the two hives should be closed. The new hive should be filled with frames containing full sheets of foundation, and, if possible, one or more old brood-combs darkened with age to tempt the queen to enter the new hive. Even if the old brood-combs are not available and only the frames of foundation can be had, this method will succeed when there is a good honey flow. The bees will not enter and occupy the new hive when arranged in this way, unless the colony is strong and is able to gather sufficient honey to cause them to need more room. Accordingly, the beginner should not use this easy method of transferring on weak colonies or when the bees are not gathering more honey than they consume. The bees ordinarily will soon begin occupying the upper story. As soon as the queen is found laying above as she is expected to do, a queen-excluder is inserted between the two stories. Twenty-one days after the queen has gone into the upper story the brood below will have all emerged except the drone-brood, and the old hive may be removed. If the combs of the old hive contain honey, and no traces of disease, the honey can be fed to the bees

and the combs melted up for wax. If the transferring is done during settled warm weather, the bees should go ahead with their work with but little interruption.

No matter what method of transferring be used, if the honey flow stops before the foundation has been drawn out into combs the bees must be fed slowly till this foundation is drawn out; and at the end of twenty-one days, when the lower hive is removed, unless there are five or six pounds of honey in the upper hive, it will be necessary to feed again. There must be a constant supply of food.

Getting Bees from a Bee-tree.

Obtaining a colony from a bee-tree is still another way of beginning with bees. Many a successful beekeeper has made his start in this way. Knowing that a colony of bees in a tree is only a swarm that has selected a tree for its home, the beginner will understand that the process of securing the bees in a tree and transferring them to a hive is very much the same as that of transferring from box hives or gums, except when the tree is broken open and the combs crushed when the process is more like that of hiving a swarm. If possible, cut the tree in the spring (if it be necessary at all to cut the tree in order to reach the colony) and before the bees have had time to multiply greatly or to have much brood. As soon as the tree is down, locate the bees' entrance to the tree and smoke the bees so that they can be handled without fear of stings. Saw into the tree on each side of the entrance and split off enough to expose freely the bees and their combs. Then place the entrance of the new hive as near as possible to most of the bees. Cut out the combs and tie them into the frames as in transferring. With a tin dipper dip up as many bees as possible and empty them before the hive-entrance. The bees will at once commence running into the hive. Now smoke the few bees that are left in the tree and step back so as to be out of the way. All of the flying bees, attracted by the loud humming of the bees entering the hive, will soon enter the new home. At night, when all flying is over, they may be moved to a permanent location. Use the same precaution in moving the hive as has been described in moving a full colony in a hive.



Transferring a colony of bees from a cut-down bee-tree to a movable-frame hive. It is not difficult.

If the tree cannot be cut, a device known as the bee-escape may be fitted over or into the opening or entrance which will allow the bees to pass out, but will prevent them from returning. If a hive containing comb is arranged close to the opening on the outside, practically all the bees may be secured in this way, except the queen. If a comb of brood

GETTING THE BEES.—*Chapter V.*

from another colony can be had, it would also be an advantage to give them a little unsealed brood. These bees will probably raise themselves a queen from the brood given them, but it would be much better to introduce a laying queen. In the course of about six weeks most of the bees will be in the new hive. There will be some brood and the queen left in the tree. These may now be destroyed by use of sulphur fumes from the bee-smoker. Then the bee-escape may be removed and the bees in the hive allowed to rob out the honey within the tree. After all the bees and honey are in the new hive, the hive can be removed to the desired location. The beginner must remember that it is necessary to supply the captured bees in the hive with either a comb of brood or with a queen. When a comb of brood is given it will be safest if the beginner select a comb containing eggs.

Bees may be obtained in the same way from the walls of a building in which they have stolen their home.

WHERE TO LOCATE THE APIARY.

CHAPTER VI.

Having his outfit and bees, the beginner asks where he shall place these. It is an important consideration.

Some Shade is Desirable.

If he lives in the country or in the suburbs, the beginner can do no better than to place the hives in an orchard, right under the trees where the bees can reach the blossoms even when the weather is unfavorable. But remember that too much shade is as bad for bees as for almost all other forms of life. But a little protection from the sun in the hottest part of the day makes the bees more comfortable and less liable to swarm, although the warm sunshine of the early forenoon and the late afternoon is a distinct advantage to the bees. If shrubbery or trees can not be had to afford pro-



Here is a good apiary location in a small town.

tection from the midday sun, some cover of boards or other shade material should be provided to protect the hives from the severe heat of the summer noon. In very hot climates such as those of Arizona and New Mexico, sheds are built to shelter the hives from intense heat. It is not uncommon in hot climates for the combs to melt from excessive heat.

Protection from Cold Winds Important.

Even more important than providing shade for hives set out in the open yard or field is to provide protection against the cold prevailing winds. This must be done wherever cold winds are prevalent. A hedge, a woods, a building, or high board fence with one or two inches of space left

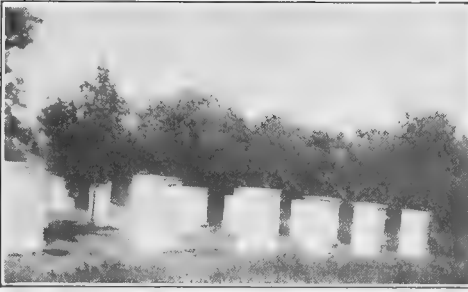

An apiary well protected by dense trees on the north.

serves to let the wind blast filter through and breaks its force. Hives should face south or east away from prevailing winds.

Location in Towns and Cities.

A beginner living in the city or in a town is naturally perplexed to know where is the best place for his bees. Back yards ("back lots") are used by large numbers of town beekeepers. In the back yard the hives are

within easy reach of the house and occupy little space. There is one drawback to the back-yard location—the bees may cause some annoyance to neighbors, especially if the neighborhood is thickly settled; for at times bees



A small apiary located in a city back yard.

will sting, and most people fear them, and would rather not have them about. To avoid any such trouble, the hives should be placed as far as possible from neighboring residences, sidewalks and ways of traffic, and so placed that a high fence, trees or buildings will necessarily cause the bees to fly high in crossing the streets or alleys close by.

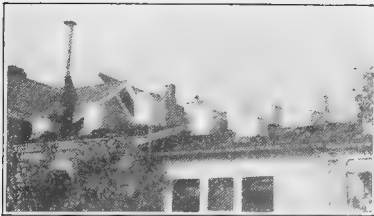

An apiary located on the roof of a city house.

If there is no high fence or hedge, nor even a shed or building, both to direct the flight of the bees and to act as a shelter from cold winds, it is frequently advisable to put the hive in an attic or on some flat roof that is easily accessible. A flat tin

roof, especially if painted dark, is apt to be a pretty hot place; and if the hives are placed there some shade will have to be provided, for there is danger of the combs melting down. There is no objection to the attic location (if not too hot) other than the inconvenience of going up and down stairs, and possible discomfort for the beekeeper in working in cramped quarters. But it is important to have the hives set close to the outside inner walls of the attic, with an entrance for each hive cut through the siding so that the bees may go in and out at any time. These entrances should be marked or diversified in different ways so that the bees may learn the location of their own hives. There should be a window near by to give plenty of light, and this window should be hung on hinges so that it may be swung entirely out of the way or else it should be so arranged that it can be taken out when the colonies are being examined. If this precaution be not taken, those bees that fly from the combs toward the light will merely buzz up and down on the window pane until they die of exhaustion. If there is no glass in the window, the bees will fly toward the light and outdoors and eventually find their way back to the regular outside entrance of the hive. In almost every large city there are bees kept in attics or on the roofs of buildings or in back yards. Colonies of bees have been kept on roofs in the heart of the city of New York, foraging in Central Park.

Many good honey-producing plants are found in vacant lots or along side streets, and sweet clover abounds in the suburbs of many of the large cities and large towns. But it should be understood that only a small number of colonies can be successfully kept in the heart of any large town or city because of the scarcity of forage there.

Locations That Protect from Stinging.

Again, remember, if the hive is to be located in the back yard, turn the entrance away from any near-by path or sidewalk or street. As before suggested, this is advised in order that bees in their most direct line of flight shall not come in contact with passers-by or horses, and possibly sting them. In this connection it may be well to observe that nothing makes bees madder than to have man or beast get right in front of their entrance or in their direct line of flight and go through some violent action, such as tennis-playing or rug-beating. Sweaty horses are especially liable to be stung.

Locations for Extensive Honey Production.

Perhaps the beginner in beekeeping will not be interested in the question of locating an apiary for the extensive production of honey. But it will be a matter of interest for him to know that, while almost any back lot anywhere in the country will support a few colonies of bees, it takes a locality favored with a plentiful growth of honey plants to make it possible to succeed in extensive production of honey. Besides the bloom of fruit trees and most flowers and plants, the following are particularly important nectar-bearers, some as regular crop-producers and some as aids to spring and fall brood-rearing: White clover, alsike clover, sweet clover, alfalfa,

sage, dandelion, orange, blackberry, raspberry, sourwood, gallberry, button-bush, horehound, sumac, cabbage palmetto, tupelo, mustard, basswood, maple, willow, tulip tree, goldenrod, milkweed, fireweed, boneset, aster, mesquite, catsclaw, buckwheat and many others. In locating an apiary to secure large crops of honey, the bee-owner should not go where there are already a large number of beekeepers, as the honey pasturage may be insufficient, and he may find his neighbors have impure drones or even diseased colonies that may carry contagion to near-by apiaries. A territory of three or four square miles of very excellent bee-pasturage will well support a hundred colonies. Ordinarily, a larger range will be required for 100 colonies.

For a large apiary a timber range is desirable, or a locality near rivers or streams where abound maple, willow, sumac, linden and other trees and shrubs, or an alfalfa belt, or mountain-sage range. The beekeeper anywhere will do well to remember that moving his apiary only a few miles will in many cases result in a decided increase in the honey crop. This is because the honey plants and kinds of crops grown often differ within a distance of a few miles.

THE INHABITANTS OF THE HIVE.

CHAPTER VII.

Having purchased his bees and having his hives located, the beginner may very naturally inquire about the wonderful inhabitants of the hive and what they do.

There are three distinctly different kinds of individuals in each colony of bees: namely, the queen, which is the only perfectly developed female; the drones, which are the males; and the worker bees, which are imperfect females. There are four like stages in the development of all three, namely: egg, larva (or grub), pupa (or chrysalis) and adult bees.

The Queen.

The one queen bee to be found in every colony is the mother of the entire colony. Her sole duty is to lay the eggs whereby the colony is continuously populated. She is in no sense the "boss or governor" of the bee family, although she is the most important member of the hive, and the various colony activities are greatly influenced by the presence and condition of the queen. Her abdomen is larger around than that of the worker bee but not so great in circumference as that of the drone, and tapers to a greater length than that of the drone or worker. The entire body of the queen is considerably longer than that of drone or worker. The wings of

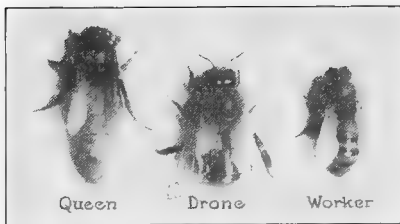

The inhabitants of the hive are the one queen, the somewhat too numerous drones, and the many workers. The pictures above are nearly natural size.

the queen in proportion to her size are much shorter and not so well developed as those of the worker or drone. She possesses a sting, which is curved, and which she very rarely uses except against a rival queen. The queen is developed from an egg which does not in any way differ from the egg from which the worker bee is produced. The worker bees themselves determine whether an ordinary egg shall develop a queen or worker.

Worker bees instinctively require a good queen. If the queen fails in fertility, is injured, lost or killed, they immediately prepare to rear another if there are any eggs or young larvae in the hive from which a queen can be reared.

When, because of a defective or missing queen or to provide a queen for a swarm soon to issue, the bees find themselves in need of a new queen, they proceed in the following manner: First, they build queen-cells, generally at the edge of a comb or in a depression in a comb, which cells are larger

than the worker or drone cells, somewhat resembling a peanut shell in size and shape. They project downward from the base, thus being vertical instead of horizontal as are worker and drone cells. In each of these specially constructed cells an ordinary worker egg is deposited. Three days later this egg hatches into a little white larva, and the worker bees begin feeding it a rich, milky, chyle food, which is supposed to be a mixture of pollen and honey partly digested, commonly called "royal jelly." If the queen is taken away or lost, the bees will build a queen-cell over a very young worker larva. The workers develop a queen rather than one of their own kind solely by constructing a special cell and by the feeding of special food. It is probable

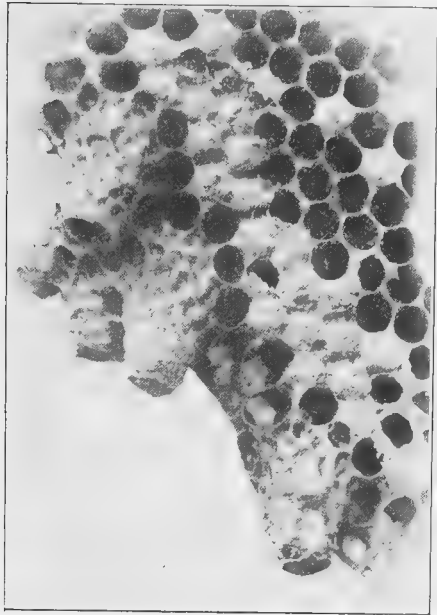

The queen-cells are peanut shape and project downward.

that, for three days after any larvae are hatched, the same food is fed to them as to the larva that is to develop into a queen. But by continuing to feed this rich "royal jelly" to the larva during the whole time of its growth, a queen is developed; whereas a worker bee is developed by a change from "royal jelly" to a coarser food, probably mostly pollen and honey, on the third or fourth day of the life of the larva. So it happens that workers can not produce a queen unless the colony either has eggs or has larvae not older than three days. The exact process by which the worker bees by means of feeding develop a queen or a worker bee at choice is not yet entirely clear or scientifically explained. After the queen larva has been fed for five days on its specially nourishing food, the workers seal up the cell, when the queen larva weaves about herself a cocoon and becomes a pupa. She remains in the pupal state for seven or eight days. At the end of this period she begins to want to get out of her cell; and when the worker bees are ready to have her come out they assist her by thinning the end of the queen-cell, and with her mandibles she completes the work of making the opening and then she comes forth a virgin queen. It ordinarily takes about sixteen days to develop a queen from the time of the laying of the egg to the adult stage. After roaming about over the combs usually for five or six days as a virgin queen, seeking during this time to find and destroy any other virgin queen or queen-cell that may be in the hive, she takes her "nuptial" flight in the open, when she meets the drone (male bee) and so becomes fertilized for the remainder of her life. She very seldom (if ever) leaves the hive again unless it be to accompany an

issuing swarm, of which she becomes the queen and mother in a new home. Within two or three days after mating she begins laying eggs, thrusting her abdomen into an empty cell and neatly gluing an egg fast to the bottom of it. During the busy season of the year, when it is necessary that the inhabitants of the hive be kept at the highest possible number in order to furnish sufficient workers to gather the pollen and honey crop necessary to the welfare of the colony, she is capable of laying daily two or three thousand eggs—nearly twice her weight. Her laying is regulated largely by the honey flow, strength and needs of the colony, this apparently being controlled by the amount and kind of food given her by the workers. Usually in the spring (at the beginning of the honey flow in the North) when many workers are needed, she lays the most; but when the honey has been harvested she lays fewer eggs. Her ordinary laying season is from February to October (in temperate regions), but early in the spring she lays but little. She does no laying ordinarily during the dormant winter period. Perhaps the most wonderful special characteristic of the queen is her ability to lay either worker or drone eggs. The male elements within her are contained in a sac known as the spermatheca, in which are myriads of these male sex cells received at a single mating with the drone, and render her fertile for life. The eggs deposited in a worker-cell are fertilized from this and produce workers; those deposited in drone-cells are not fertilized and produce drones. So it is that the drone or male bee is really a bee without a father. An infertile queen can lay eggs that will produce sons and sons only. This is a reproductive power known as parthenogenesis, and possessed by only a very few other insects. The queen mother may live for a term of three or four years and perform her duty of laying well during this time, and possibly be the single mother of a half million workers and drone bees. But, ordinarily, a queen older than two years begins to fail, and for this reason many beekeepers replace all their queens as often as every two years.

Only one queen, under normal conditions, is found in the hive at one

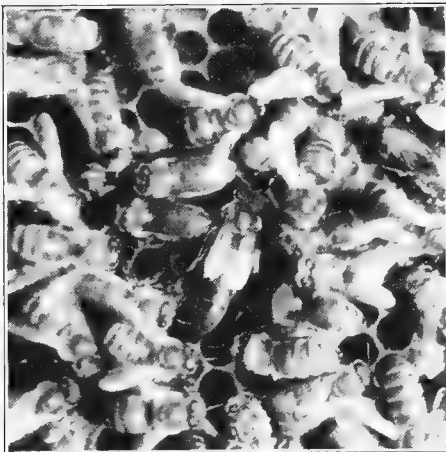

The queen is shown at the center of this picture surrounded by adoring workers.

time. The workers might tolerate more than one queen; but queens themselves are jealous of each other, and, when they meet, a mortal combat follows, during which one of them receives a fatal sting from the other and dies at once. Sometimes a queen mother and her daughter will get along together in the same hive during the summer; but ordinarily toward the fall and winter season, when the busy time is past, the mother disappears. (For discussion of management of the queen, see Chapter X.)

It is well for the beginner to remember that, as the queen is, so is the whole colony. Her blood is the blood of all the members of the hive, and the faults of her strain will be the faults of her progeny. So it is all-important that the colony have a good queen mother.

The Drone.

The drone, or male bee, has no other business within the hive or outside of it than to fertilize the queen. He is hatched from an infertile egg, as before explained. His development requires 3 days in the egg, 6½ days as a larva and 14½ days as a pupa sealed in the cocoon—24 days in all. During the first three days of the larva stage, the drone is fed rich larval food, but after that period is fed a coarser food probably composed largely of pollen and honey. He has no organs for gathering nectar or secreting wax; he has no sting, and does no work for his own support or the support of the colony, living entirely on the toil of the workers. He is shorter, thicker and heavier than the queen, and larger and clumsier than the workers. His wings extend the whole length of his body. He excels other members of the hive family only in the noise that he can make, his buzzing when on the wing being very loud and apparently very satisfactory to himself.

Drones are produced in larger numbers than is seemingly necessary, as probably only one in many hundreds of them finds a queen and mates with her; but it seems necessary for the colony to have an abnormally large number of them in order that the queen may very certainly be mated within a short time after she leaves the hive on her nuptial flight. That the drone may discover a queen in flight at long distance he has, perhaps, the finest compound eyes known to science, having more than 25,000 facets in each of these two eyes, besides having three common eyes (probably for short-range vision) that may be seen on the triangle at the top of his head. If he mates with a queen he loses his life at once in the act. If he survives the main honey flow and mating season, he is not permitted to continue a useless burden on the colony, but is refused food, and is ruthlessly but economically pushed out of the hive by his sisters, to starve to death in a friendless outside world. But in case the colony for any reason has to raise a new queen, the drones are kept till this new queen is fertilized.

The Workers.

The worker bee (an imperfect female) does the hard work of the hive. She is developed from a fertilized egg in the smallest cells of the combs. In three days' time the egg hatches into a tiny larva and for three days this is abundantly supplied with rich larval food by the young nurse bees, after which a coarser food containing pollen and honey is fed. Under this care it grows with astonishing rapidity. In about three days from the time the egg hatches, the larva is so large that it almost completely fills the bottom of the cell. In another three days it stretches out

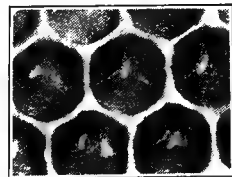

Eggs in the cells.

lengthwise in the cell, and about that time is sealed or capped over. The larva now becomes a pupa within a cocoon. In eighteen days from the time the egg hatches, or twenty-one days from the time the egg was laid, the worker bee, now perfectly developed, begins to cut through the capping, and within a short time she struggles out, rather downy and pale-looking, but fully developed, a mature bee. For

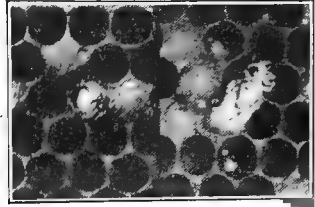

A bee a-borning—just emerging from the cell.

some time she crawls unsteadily over the combs, jostled about and apparently unnoticed by the other bees, and then she finds a cell of honey and begins to feed. From this time on she acts as a nurse bee, taking care of the larvae, secreting the chyle food, and helping to keep the brood warm. The young worker bee also helps feed the queen, cleans and ventilates the hive, and aids in ripening and moving about the honey and in secreting wax and comb-building when necessary. After two weeks she takes up the duties of a regular field bee, gathering nectar and ripening it by fanning the wings, gathering pollen and propolis (bee glue) and attending to all the duties and hardest work of the bee home. They are the only armed defenders of the colony and will die regardless of all self-preservation in their instinctive defense of the colony as a whole. They also rule the colony, directing the queen's life and work, and even drive out the

drones at their pleasure. The worker's most important business is to gather nectar from flowers and other sources, which nectar she changes into invert sugar, or honey, by a process which is started in her honey-sac or first stomach. A small cavity on each hind leg is used for storing and bringing in the small lumps of pollen gathered from the flowers. The pollen (sometimes called "beebread") is an important



The worker bees care little about being handled—they just keep on about their business.

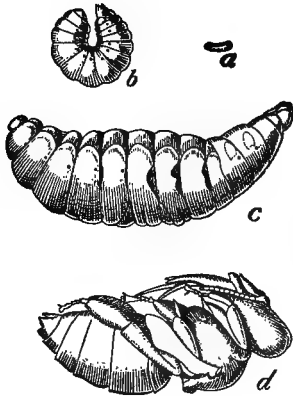

Four stages in the development of the honeybee: a, egg; b, young larva; c, old larva; d, pupa.

part in the food that is fed to the larvae, but is not much used as food for mature bees and especially during the inactive winter months (see page 47). The propolis which the workers gather is selected from resinous buds, gummy substances and the like, and is used as a varnish and glue for cementing things within the hive and filling the cracks or uneven surfaces. The life of the worker bee ordinarily is a brief one: Bees that emerge in the late summer or early fall may live for six months during the winter season when they are not fatigued by work; but the worker bees emerging in the spring and early summer, that do the hard work of the busy honey and bee-rearing season, seldom live more than fifty or sixty days.

They do not die from old age, but literally work themselves to death, often completely wearing out their wings, or are killed by accident or by enemies in the open field.

Stages in Development of the Bees.

The beginner will do well to learn accurately the following table giving the time consumed in the different stages of development of the queen, drone and worker bees:

Stage	Queen (days)	Drone (days)	Worker (days)
Egg	3	3	3
Larva	5½	6½	5½ to 6
Pupa	7½	14½	12 to 12½
Total	16	24	21

Queens fly to mate five to ten days after maturity; drones fly from one to two weeks after maturity; workers fly as field bees in about two weeks after maturity.

INSIDE THE HIVE.

CHAPTER VIII.

After the beginner has secured his bees and has learned something about the three kinds of individuals that make up the hive family, he needs to know something about the inside of the hive before he begins working with the bees.

The Brood-Chamber Defined.

The brood-chamber, which may be called the living-room of the bee family, is the most interesting part of the hive. It is ordinarily the lower part of the hive (a single hive-body) in which the bees are reared. This part belongs particularly to the bees themselves; and it is very rarely that the beekeeper takes away any of the honey which it contains. The honey there is for the bees' own use. The surplus honey is stored in the "supers" above the brood-chamber. In the interior of this brood-chamber are the combs in which the brood is reared and in which the bees store honey for their own use. We are now going to consider this comb, what it is made of and the uses to which the bees put it.

Wax and Wax Secretion.

Beeswax is a secretion that issues from the wax-glands in scales between the six segments on the under side of the abdomen after the bee has been feeding heavily. It has been estimated that bees consume from five to fifteen pounds of honey in order to produce a single pound of wax.

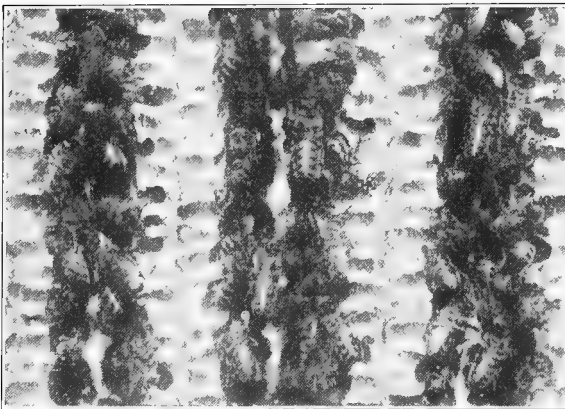

A view of bees between the combs of an observation hive. This picture is of a transverse section of four combs.

When secreting wax the bees, gorged with honey, hang in chain-like formations for hours together, suspended from the top of the hive. When the wax first issues it is a liquid which soon hardens into pearly-white scales. The bees transfer this wax in their mandibles; and

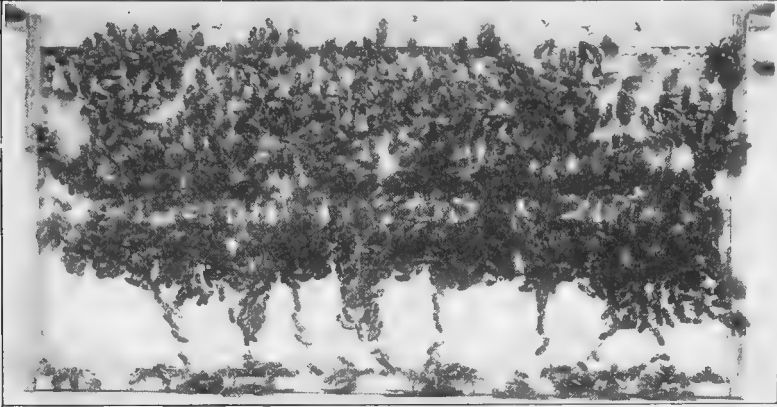

Bees secreting wax. Note how those at the bottom hang in chains.

by mixing it in the mouth or masticating it, so to speak, it becomes a pliable and ductile substance used in making the comb. There are many mineral and vegetable waxes that resemble beeswax; but for its ductility beeswax has the highest melting-point of any wax known—145 degrees Fahrenheit. So it is that if the honeycombs were to be made artificially of paraffin, for instance, they would not stand the high temperature of the hive, especially on hot days, but would sag or melt down.

Comb and Comb-Building.

Comb-building is the one object of the bees in secreting wax. Comb is made up of compact six-sided cells of wax, built out horizontally on both sides of a common base, called the midrib. The bees show the greatest economy of space in cell-building and also provide for the greatest possible strength by interlacing the ends of the cells at the midrib. But the combs that bees naturally build in hollow trees or "gums," or sometimes on the branches of trees, are often crooked and bent. Worker comb used for brood-rearing is about $\frac{7}{8}$ inch thick, and the bees require a space of from five-sixteenths to a half of an inch between combs as a passageway. Cells that are used for honey are usually elongated, leaving the minimum passageway between the surfaces of

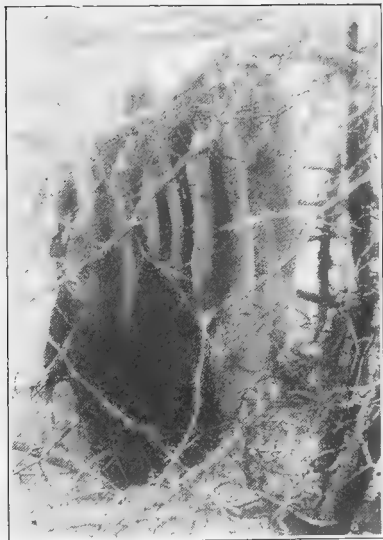

A sample of combs built by bees among the branches of a tree. They are big but shapeless.

sealed honey in two adjacent combs; but cells which contain worker brood are always slightly less than $\frac{1}{2}$ inch in depth, thus leaving a wide passageway between the cappings of sealed brood in two adjacent combs. Drone comb has deeper cells than worker comb used for brood.

When the comb is first built it is nearly white in appearance. It very soon becomes "travel-

stained," however—that is, the bees in walking constantly over it and over the fresh propolis (the sticky substance which they gather from trees) soon stain the white wax so that it has a brown color. After a few generations of brood are reared in the cells the comb becomes quite black. This is no indication that it is not perfectly good, for combs have been known to have been used continuously by the bees for thirty or forty years. In fact, old combs are better than new; for they become stronger with age and warmer for wintering, owing to the many layers of cocoons left on the inner sides of the cell walls by the many generations of bees which have emerged from these cells.

Comb Foundation.

It is in the building of comb that man has come to the assistance of the bees in a most remarkable way. This is by the invention of what is known as "comb foundation," which has been in common use now for nearly fifty years, and is used by all successful beekeepers everywhere today. It is made by running a very thin sheet of wax between two metal rollers, thereby transforming the wax so rolled into an almost exact impression or reproduction of the bases of the cells of the natural honeycomb. When the sheet of wax is run through these rolls it becomes what its name implies

—a foundation for the comb. In this foundation the bases of the cells are formed and the side walls started.

This foundation is used in both sections and frames. There are different weights of foundation. The "thin super" is best for the comb-honey sections; "medium brood" is best for the brood and

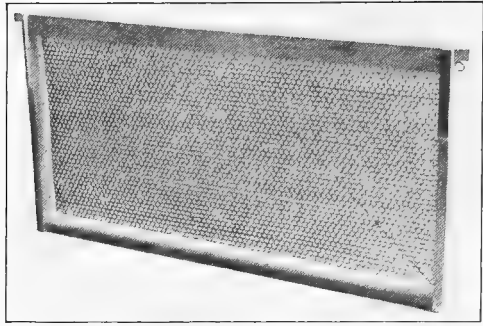

A frame of comb foundation. The bees will build this out to full-depth comb.

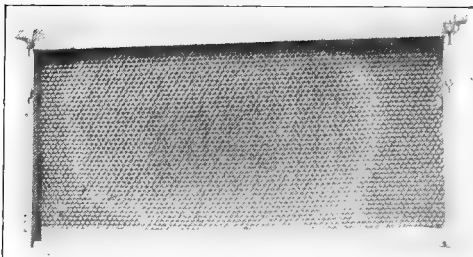

A frame of comb foundation which has been partly drawn out by the bees. The nearly completed cells are seen at the central part of the frame.

extracting-frames; "light brood" is satisfactory for shallow extracting-frames. When used in the large frames, in order to prevent the combs from sagging or breaking down when filled with honey or brood, fine wires are imbedded in the comb foundation to strengthen it. With these imbedded wires there is much less danger that the combs will be broken out of the frames when the honey is extracted from them in the rapidly revolving centrifugal honey-extractor. When either the frames or sections of foundation are given to the bees, they grasp the very shallow walls and "draw them out" and build on with new wax, the work being so perfectly done that it is impossible to tell where the old wax leaves off and the new begins.

No matter how perfectly the base of the cell is formed by the rolls used in making comb foundation, the bees alter it slightly, making it a little thinner and a little rougher in appearance.

Comb foundation serves a fourfold purpose: (1) It furnishes a very considerable part of the beeswax required for building the comb at a much smaller cost than the bees can build new comb; (2) it centers the comb in the frame or section, as the case may be, and thus the bees, when building on to it, build the comb straight, whereas bees naturally would just a little prefer to build their combs crosswise of the frames or sections and also curve them or make them crooked so as to add to their strength; (3) by the use of comb foundation made with only worker-cell bases, the natural number of drone-cells and resultant drones (often not wanted at all) can be reduced and controlled; (4) when combs are needed quickly, as during a heavy honey flow, they can be built much more rapidly because the bees can then work on the entire surface of the foundation instead of only on the lower edge of the comb as they must do if foundation is not given.

The Cells and Their Arrangement.

In the same comb, whether it be natural comb as built by the bees or whether built from man-made comb foundation, will be found worker and drone cells, and at times queen-cells. The bees will "squeeze in" a few drone-cells, around the edges of comb built from foundation having only worker-cell bases, but such cells will be far fewer than in the bees' own naturally built combs. The bees will also very often patch up holes that may be made in the worker comb with drone-cells. The cappings of the worker-cells are slightly convex and the cells are a little more than a fifth of an inch in diameter, and a little less than half an inch deep. The drone-cells are a trifle more than a fourth of an inch in diameter and a little more than half an inch deep, the cappings protruding a little above the surface of the worker-comb cappings. The manufactured comb foundation ordinarily has the worker-bee size of cell bases only. Drone-comb foundation is, however, specially manufactured for use in queen-rearing. Honey is stored in both the drone and worker cells indiscriminately. The cells usually have an upward slope that helps retain the thin honey before being capped. The beginner will understand that the bees use the cells at will for either rearing their young or storing honey. The cell walls may be thinner than one-three-thousandth of an inch; but the comb is wonderfully strong and may weigh only one-twentieth (or less) of the weight of the honey stored in it. Wax is used by the bees to cap the cells when filled

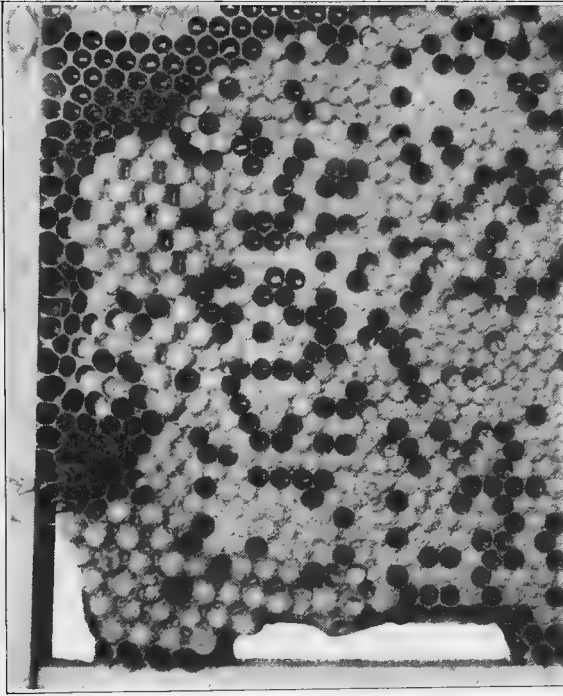

Drone and worker cells, both capped and uncapped. Larvae can be seen in some of the uncapped cells. The larger size and the protruding cappings of the drone-cells may be easily noted.

with honey; but a mixture of fibrous substances and wax is used to cap the cells which contain brood, this mixture admitting air and giving ventilation for the vital use of the pupa within.

The brood is normally started at the center of a comb (in the center of the hive), the circular patch of brood there gradually increasing as the colony builds up till the greater part of the comb may be filled with honey and pollen, convenient

for the bees to feed to the brood, the pollen usually being stored in a narrow band of cells just above the brood, the honey being stored above the pollen and in the upper corners of the comb. Sometimes the comb adjacent to the outside frame of brood is filled with pollen and honey.

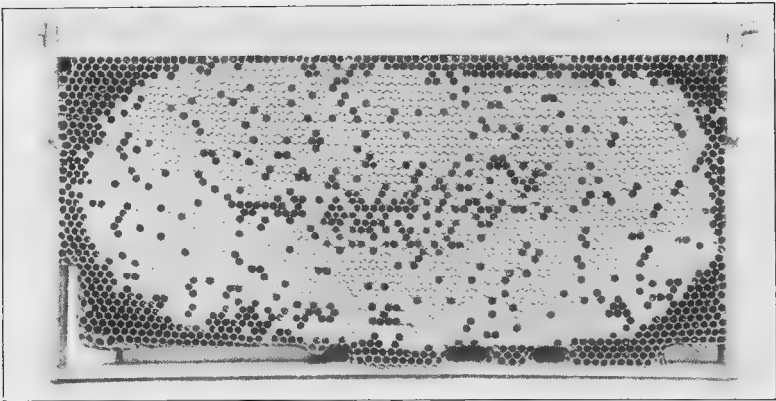

A comb of solid worker brood. The beekeeper delights in such a comb.

Queen-cells, if present at all in the hive, are usually found built about the lower edges of the comb or on possible depressions of the combs.

Pollen.

Pollen, the fertilizing dust of flowers, is harvested by the bees and is stored in the cells for food. It is the breadstuff of the bees, furnished by flowers. It is of a powdery nature, and may be red, green, brown or yellow, depending on the source. The bees carry the pollen into the hives, packed in pellets in the "pollen-baskets" provided by nature on their rear legs, depositing it generally in the worker-cells. This pollen furnishes the nitrogenous food for the bees themselves, but more especially for the larvae. Without it brood-rearing could not be carried on; and, if there is no natural pollen, substitutes sometimes are provided, although with doubtful results. The pollen, moistened with honey, is packed firmly into the cells by the bees—these cells, as before stated, ordinarily being located close to the cells of brood. This packed



Enlarged photograph of a worker bee showing the rounded pellets of pollen on her rear legs.

pollen, or beebread, is of a somewhat disagreeable taste (to man), but has great nutritive properties.

Propolis.

Another substance gathered by bees, and very necessary to them, is a substance known as propolis, or bee glue. It is ordinarily gathered from the resinous coats of the buds of trees and smaller plants. But lacking this source of supply the bees seemingly resort to various substances such as varnishes, resin, pitch and the like. Bees gather propolis and carry it to their hives precisely as they do pollen. It is never packed in the cells, but applied at once as needed for coating over the inside of their hives, filling cracks and crevices, covering cocoons of wax worms or other objectionable matter that may have got into the hive, and for making things fast and close generally within their home. Propolis is an exceedingly sticky and strong glue, yet it is hard and brittle when cold. The beginner has yet to learn how disagreeable it may be, and what a nuisance it can prove to the beekeeper when manipulating the hive; yet it is important to the bees' welfare, especially in making the hive snug and warm for the winter. Propolis may be removed from the hands or apiary tools by the use of wood alcohol or turpentine.

Honey.

Honey, the chief product of the bees and the chief object of the beekeeper, is a sweet produced from the nectar of flowers. It is gathered by

the bees and carried in the honey-sac to the comb in the hive. In the process of gathering and storing, the nectar is evaporated and chemically modified by the bee, rendering it a partly digested sweet. Honey depends for its color, odor and flavor on the flowers from which it is gathered. These vary greatly; as for instance, buckwheat, orange or clover honey have their entirely different color, flavor and aroma. Honey contains a large per cent of water, especially when first deposited in the comb and before the bees have had a chance to evaporate (ripen) it. But there is a great difference in the original density of honey, due to the difference in the nectar of various plants. For instance, white clover honey may contain as much as 75% or more of water when first gathered by the bees, and will often drip like water from the combs when handled. But the bees proceed at once to ripen it by evaporation. They accomplish this by the fanning of their wings within the hive and at the hive entrance as well as by the warmth of their bodies and, possibly, certain mouth processes. A quarter of the weight of freshly deposited honey may be evaporated within the first day after having been gathered. The bees cap the honey over when thoroughly ripened; but, whether capped over or not, honey grows thicker the longer it is left on the hive, unless the bees are compelled to leave it exposed by clustering in a smaller space on arrival of cooler weather. The amount of honey gathered by a strong colony of bees during a good honey flow and with good weather conditions may run from five or six to even twenty or more pounds a day.

Honeydew, a sweet excreted by insects on certain plants and trees, is a substance sometimes gathered by bees and stored in the combs just as honey is stored. It is ordinarily a nuisance to the beekeeper unless it is used for brood-rearing as gathered, or stored in combs to be saved for feeding the bees next spring. It is not suitable as winter food for the bees except in a warm climate where the bees can fly freely every few days during the winter, and it is not suitable for market.

EXAMINING AND HANDLING BEES.

CHAPTER IX.

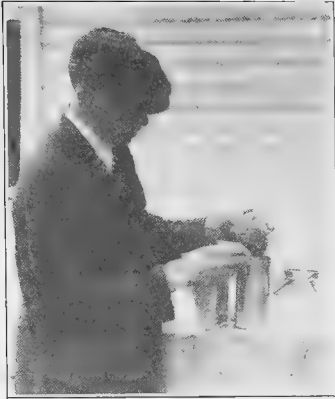

Nursing the fire in the bee-smoker. The smudge material about to be packed in.

At the very beginning of the actual work of handling the bees and manipulating the hive, the beginner should learn how to avoid being stung. This is not difficult.

How to Avoid Being Stung.

First of all, let the beginner take in hand his bee-smoker and see that it is lighted so that it will stay lighted. Do this by first placing in the bottom of the fire-chamber some easily ignitable material; apply a match to this and then pack in above the flame a material which will make plenty of smoke and burn slowly, such as rags, greasy waste, or well-dried rotten wood; next give several puffs with the bellows to

be sure that the fire is started, but do not use the bellows so much that a blaze is started in the smudge material. It is the smoke, not the flame, that is wanted. It is necessary to make very sure that there is enough smouldering fire in the smoke fuel so that it will not go out while handling the bees.

Next, protect the hands and wrists with a pair of bee-gloves, and the face with a bee-veil. Let the beginner wear loose, light-colored clothing, avoiding black or fuzzy material of any kind, if possible, with the sleeves made tight at the wrists, and the bottom of his trousers tucked in his socks or tied about his ankles. Women may well wear overalls or bloomers when working with bees. A full but short apron may be worn over the overalls and a short skirt over the bloomers. High shoes and leggings also add to a woman's protection against stings.

The veil should be so adjusted that no bee can gain entrance. See the illustration on the next page of a beekeeper with his bee-veil, bee-gloves, etc., properly fastened and adjusted.

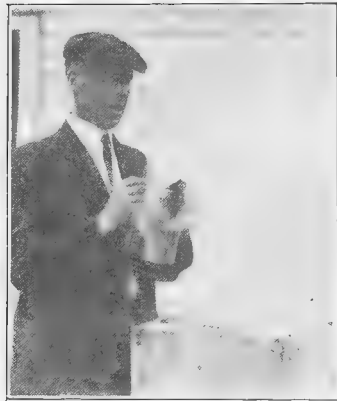

Using the bellows of the smoker to make sure that the fire is well caught in the smudge material.

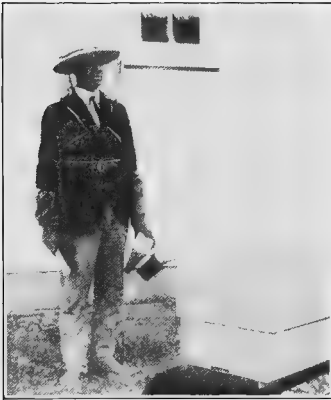

Fully equipped against stings, with bee-gloves and bee-veil securely fastened, and his smoker lighted.

Along with the smoker, have in hand a good hive-tool; or, lacking a hive-tool, take a screwdriver or heavy pocketknife, and approach the hive from the rear or side. Never stand in front of the entrance nor get in the line of flight of the bees if it can possibly be avoided.

It is taken for granted that the beginner has selected a warm day for his bee operations, and some time between the hours of ten and three o'clock. Let him be sure never to attempt to open a hive on a cool or chilly morning or late in the afternoon, never after a chilly rain, and not directly after a honey flow has been suddenly interrupted. At such times bees will sting

if they can find anybody or anything to punish.

Now, with the smoker well lighted, blow three or four puffs of smoke into the entrance of the hive to subdue the guards, but be careful not to blow in too much smoke. (Smoking at the entrance is not necessary during a good honey flow.) If the smoking is overdone, the bees in the hive will be stampeded, especially if they are black bees or hybrids, rendering subsequent handling of them exceedingly difficult.

Now, take off the outer cover. Do this as gently as possible, for the less the bees are jarred or aroused in any way the better for their tempers.

Next, take the hive-tool and gently pry the inner cover of the hive up an eighth of an inch—not wider. It may be necessary to pry from more than one corner in order that the cover may not come up with a jar. Through the gap so made between the inner cover and hive blow in a couple of puffs of smoke. Put the inner cover down for a moment. Next, gently lift up the cover again, following the movement with perhaps two or three more light puffs of smoke. There should be just enough smoke used to drive the bees that are on top of the frames down between the frames; and later in the operation, whenever many of the bees' heads are seen sticking up between the frames, ready to take wing, a little more smoke will be needed.

The beginner may next proceed to lift out frames singly. If they are stuck together with propolis, a little smoke may be required to follow each operation in separating the frames with a hive-tool, as a sudden jar may anger



Before starting to open the hive, blow one or two light puffs of smoke into the entrance.

EXAMINING AND HANDLING BEES.—Chapter IX.



As gently as possible take off the outer cover.



After the outer cover of the hive has been removed, use the hive-tool to pry up the inner cover and blow a little smoke into the top of the hive.

the bees; but usually the smoker can be set down alongside the hive, and frame after frame be lifted out without receiving a single sting. The first frame or two removed from the hive may be set down on the ground and leaned against the hive while the other frames are examined.

Especial care should be taken not to pinch any bees nor kill any. Take good care to place the fingers only where there are no bees; and, if bees are very numerous, simply push them over to one side by pushing the gloved fingers down among them, being careful not to pinch them in doing so. To pinch any of the bees or to kill any of them may result in enraging the whole colony. Always remember to make no quick movements. Be deliberate and cool in the manipulation of bees always. Nervousness or any quick movement on the part of the operator seems to anger the bees.

After the beginner has opened the hives a few times he will be able to discard the gloves, and later he can dispense with the veil at times (not



Separating the frames with a hive-tool preparatory to lifting them out.



Just enough smoke is needed to keep the bees driven down between the frames.



Lifting out a frame.



Leaning a frame against the hive.

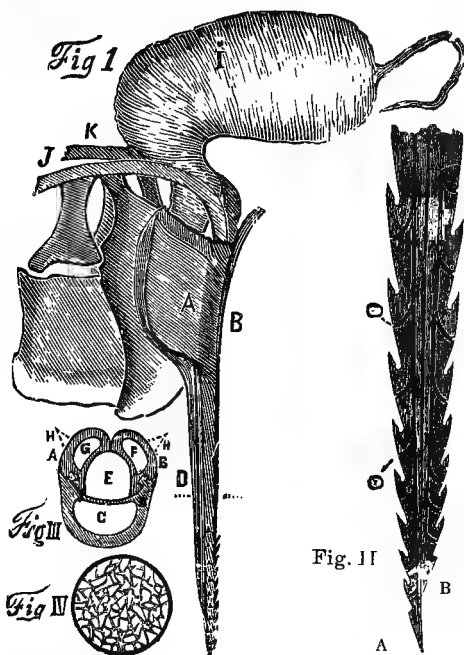

The stinger of a bee dissected. Fig. 1 shows the wonderfully constructed weapon as a whole, the lower part of which is composed of an outer shell D, and two barbed spars (Fig. 2) that slide partly inside of it. These barbs have a pumping motion that sinks them alternately deeper and deeper into whatever is stung. Fig. 3 is a transverse section of the stinger cut across at dotted line below D of Fig. 1. Fig. 4 is a crystallized drop of the bee's poison. I of Fig. 1 is the sac from which the poison is pumped into the wound by the same pump motion that sinks the barbs deeper and deeper. The bee dies as a result of leaving her stinger in the wound—a bit of poetic justice and quite generally satisfactory to the stung.

when the bees are cross or cold or suddenly deprived of nectar in the fields), because he will find that an intelligent use of the smoker will do more to eliminate stings than any other one thing. Remember, too, it is sympathy with the bees as well as expertness in handling them that finally results in handling them without harm to the operator.

If a sting be received the stinger, which will be found sticking in the flesh, should be immediately brushed or scraped off. This is because the sting has a poison sac at its base from which poison is pumped into the wound, even after the stinger is detached from the bee. The sting is also barbed and continues to work farther into the flesh as long as left in the wound. By swiftly brushing or scraping off the sting (rather than picking it off) no pressure is put on the poison sac and thus no poison is forced into the wound.

There is no known cure

for stings. To rub or touch the wound only seems to increase the swelling. Medicinal applications are useless because the puncture is too small to admit medicine, at least in any effective amount. In cases of severe stinging, hot cloths may be effectively applied to relieve the pain.

How to Handle Frames.

Hardly less important than knowing how to handle the bees without inviting stings, is a knowledge of how to handle the frame properly.

After removing the inner cover, if the frames are self-spacing, insert the hive-tool between the side of the hive and the end-bar of the first frame. Crowd the set of frames tightly together against the far side of the hive, repeating this operation for the other end of the frames. Now pry the first frame back toward the side of the hive when it is ready to lift out. If, on account of attachments of comb to the side of the hive or bulged combs, the first frame can not be readily removed, the second or even the third frame may be taken out first.

For first inspection it is better to take the first or the second frame, as the queen is less likely to be found there at the side of the hive. If she should be on the first frame removed, she might be injured by being rubbed or crushed when the first frame is drawn from between closely adjacent combs.



Position 1.—Frame is held horizontal while the first side of the comb is being examined.

Lift the frame by taking hold of both ends of the top-bar, keeping it in a horizontal position while examining the side turned toward the beekeeper.

To examine the opposite side, no frame should be turned directly over with the bottom-bar remaining horizontal, for if the comb is heavy with honey it may break from the frame, and if the queen should chance to be on the comb being examined she is quite likely to fall to the ground and be injured, since it is difficult for a laying queen to keep her footing on a comb

so turned.

Note the accompanying illustrations for exact directions for handling frames.

The frame is held by the ends of the top-bar horizontally in front of one while examining the first side of comb. (See position 1.) To turn the other side into view, begin by raising the right end above the left, to bring the top-bar into a perpendicular position (see position 2); next revolve the frame, now perpendicular, with the top-bar as an axis, until the opposite side of the comb is turned toward the beginner (see position 3); now the right hand may be lowered to a position level with the left hand, thus leaving the frame still in a vertical position, and still held by the ends of the top-bar, but with the bottom-bar now at the top (see position 4) instead of at the bottom, as in the original position, so that the beekeep-



Position 2.—Frame raised to perpendicular position ready to turn. The top-bar of the frame is the axis on which the frame is turned.



Position 3.—Comb turned to bring other side to view before being lowered to horizontal position.

er can examine the other side of the comb.

In order to get the frame in the right position for returning to the hive this operation should be just reversed. The start in reversing is shown in position 5.

This manner of handling may sound rather involved and quite unnecessary; but in reality it is very simple, and may save the beginner a broken comb or the loss of a queen. Practice it with an empty frame. Very soon the beginner will reverse the combs correctly and almost instinctively.

To make room to work place the first comb removed to one side in a box. The other combs can then be removed one after another as desired, putting them back into the hive after examination but toward the



Position 4.—After the right end has been lowered from the perpendicular position and the frame is in position to examine the other side.

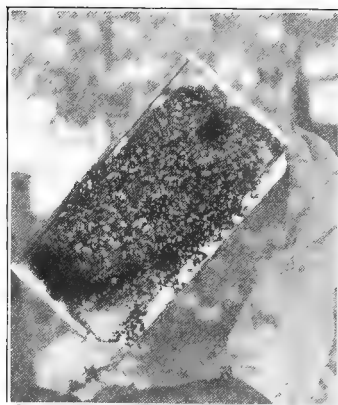

Position 5.—Starting the reverse process to bring the frame back to normal position.

EXAMINING AND HANDLING BEES.—*Chapter IX.*

near side of the hive, thus always leaving room for taking out the next comb.

When ready to close the hive the frames should again be crowded against the far side of the hive before the last comb is put in. After all the frames are in place, crowd them together tightly against one side of the hive, then move them back slightly so that the end-bars of the outside frames are about one-fourth inch from the side of the hive. This allows a clustering space for the bees between the outside combs and the side walls of the hive. Furthermore, the queen can occupy the cells of the combs adjacent to the side walls of the hive when proper space is given, and thus more cells are available for brood-rearing.

It will thus be seen that in the examining and handling of bees there is a correct method of manipulating hives, which, if followed, will mean satisfaction and pleasure instead of drudgery and stings. The beginner who is afraid of being stung and afraid of doing the wrong thing at the wrong time can very soon become proficient in handling and examining bees, if attention is given to the details we have endeavored to set forth in this chapter.

WORK WITH THE QUEEN.

CHAPTER X.

Having secured his bees and equipment, and having learned something of the individuals in the hive and its contents, as well as how to avoid being stung, and how to handle the frames, the beginner is ready for actual work with the bees. Naturally he asks himself how often and for what purpose are the hive and the bees to be examined.

Most beginners overdo the first work. Pulling the hives all to pieces and redistributing the combs promiscuously is an expensive kind of pleasure, but there are several real necessities for opening the hives. Among these are: To learn that the queen and conditions of brood-rearing are all right; to make sure that the bees have sufficient food in store; to learn if the colony as a whole is healthy and normal; occasionally to determine special exigencies arising in the hive; after the honey flow, to take off supers filled with honey; and to prepare the colony for winter. But the condition of the queen and resulting conditions in the hive may demand an examination of the colony at the very beginning of the beginner's experience with bees.

The beekeeper should know that a queen is present in the hive and conditions normal, if he is to expect success. So he should examine the hive whenever he has reason to suspect that anything may have gone wrong with the queen.

How to Find the Queen.

If the beekeeper needs to find the queen for any good reason, let him first take out one or two of the outside combs from the side of the hive next to the operator. If the queen is not on these combs, set them aside in order that the remaining combs may be more readily examined. If robbers are troublesome these combs must be put into an empty hive or a light box that will hold two or three frames, and kept covered while they are out of the hive. As each of the remaining combs is removed from the hive, glance quickly over the exposed side of the next comb in the hive to see if the queen is there. If she is not there, turn the comb just removed to examine the other side and proceed in this way until the queen is found. As the combs are examined they are placed back into the hive on the side nearest the operator in order to maintain an open space between the combs already examined and those yet to be examined. This work should be done rapidly and no more smoke should be used than is necessary for rapid work. If the bees are inclined to be nervous and run on the combs it is necessary to watch for the queen in the spaces between the lower edge of the comb and the bottom-bar of the frames, and also on the bottom and sides of the hive, for if the queen becomes frightened she may run off of the combs into these spaces. (For directions for clipping the queen, see page 114.)

If the Queen Be Lost.

If by any accident the queen should be lost, the bees soon detect her absence and at first set up a peculiar cry and buzzing of distress as they rush wildly about all over the outside of the hive and out into the grass in their effort to find her. If she is not found they immediately start queen-cells about some of the youngest larvae present, and thus begin rearing them a new queen. In such cases, the queen-cells are liable to be unusually numerous and built anywhere on the comb. If the strain is undesirable, this would be a good time to improve the stock by giving them a ripe queen-cell from a good stock in a spiral wire cell-protector or by introducing a laying queen. (See "How to Introduce," page 60.)

We have previously stated that it requires 15 or 16 days to rear a queen; but when bees start to rear a queen beginning with larvae it is evident that a queen may emerge in 11 or even 9 days after the bees determine to rear one, although nine days is quite unusual, since the bees normally choose quite young larvae from which to rear the queens.

It often happens that colonies become queenless without the owner's knowledge; and, unless he chances to notice them at the time of the loss, their behavior would hardly be striking enough to attract his attention. Still, should he happen to see bees standing idly about the entrance, and none of them industriously bringing in pollen when the bees from the other colonies are doing so, he would have cause to suspect that all was not right with the queen. If this condition is observed it is well to open the hive and look for eggs and larvae. If plenty of eggs and worker brood are found, one may be quite sure the queen is present, and it is not necessary to look for her. If queen-cells and plenty of good worker brood are found they are preparing to swarm. If a few queen-cells and a little scattering worker and drone brood are found, the bees are probably trying to supersede or replace a queen they consider defective. If only drone brood is present, the colony has either a drone-layer (see page 58) or laying worker (see page 58), which should be disposed of immediately. In such cases the drone brood will be found in worker-cells; but it can be detected by the elongated cells and more convex cappings as well as the irregularity of the sealed brood, it being somewhat scattered. If no worker brood is found, and the bees commence an unusual buzzing when the hive is opened, the colony is, without doubt, queenless. This fact can be definitely determined by introducing a comb containing eggs and young larvae, when, if queenless, queen-cells will at once be started. Of course, colonies that are without food will cease rearing brood, no matter how prolific the queen may be, and, as previously mentioned, brood-rearing is normally suspended from October to February or March, except in the extreme South.

Supersedure.

When a queen is old or otherwise defective the bees usually raise another to take her place, and do it while she is still alive. In fact, the young



Putting a queen-cell in a protector into the hive.

supersedure queen-cells are built during the swarming season the colony may swarm, even if not strong, the colony apparently being induced to swarm by the presence of queen-cells. Usually fewer queen-cells are built for supersedure than for swarming. Sometimes only one or two queen-cells are built for supersedure, and often one of these is started several days or even a week in advance of the other.

Laying Workers.

Ordinarily worker bees are females imperfectly developed as to sex. Under certain circumstances their special organs become developed to such an extent that they are able to lay eggs, in which case they become laying workers (sometimes called "fertile workers"). Such eggs, however, always develop drones, since fertilization of workers is impossible, and only fertilized eggs can produce females. If a virgin queen becomes lost in mating, a colony is without a laying queen for so long a time that there are no young larvae left, and therefore no chance to raise another queen; the colony after two or three weeks may become infested with these laying workers. To get rid of them, rather strenuous measures must be adopted, since it is very difficult to distinguish them from ordinary workers, and there may be a great number of them present in the same hive.

For the beginner having only a few colonies, let him exchange (but not before nor during the main honey flow) the location of the hive having the laying workers with that of a strong colony, at the same time introducing a queen by the cage method into the laying-worker colony.

Drone-Layers.

Finding a colony with mostly drone brood, and with eggs placed irregularly, does not necessarily prove the presence of laying workers, for the brood of drone-laying queens has much the same appearance, although there are usually fewer eggs, and they are placed deeper in the cells.

A drone-layer may be a queen that has failed to mate during the first two or three weeks after emergence, or she may be a queen that is failing on account of old age. She should be found and killed, and the colony put into a normal condition by giving it brood in different stages of development and introducing a good queen.

A Colony Hopelessly Queenless.

When a colony suddenly loses a queen, it has eggs and young larvae from which they begin at once to rear a new queen. But sometimes such a queenless colony fails to raise a new queen, or perhaps she is lost in mating, and the situation arises that there are no eggs nor young larvae present, and the bees are then unable to raise another queen. Such a colony will very soon become worthless, unless immediate steps are taken to put it in a more nearly normal condition. It should at once be given a comb containing eggs, young larvae and emerging brood to render the colony normal, and then a few days later a good laying queen should be introduced, first tearing down any queen-cells that may have been started. If a laying queen cannot be obtained and introduced, the bees may be allowed to raise one in the natural way from a queen-cell, if the colony has enough bees to warrant it; but, if this condition arises only five or six weeks before the honey flow, the colony would not thus build up in time for the honey flow, because they could not have a laying queen for 20 or 25 days. In this case, or if at any other time the queenless colony be very weak, the bees in it should be united with some other colony. (See the subject of "Uniting," page 113.)

Balling the Queen.

When a strange queen is placed in a colony of bees they usually resent her presence, seeming to consider her an intruder. No doubt this is caused partly by her individual odor or by her unusual actions due to her fear. Sometimes before she has been in the hive more than a few seconds the bees form an angry mass, clinging closely to her body, thus either smothering or stinging her to death.

If the bees attempt to ball a queen in this way she should be quickly rescued by puffing a little smoke, or, better, by dropping the ball of bees into lukewarm water, after which she may be introduced by the cage method. (See page 60.)

When to Introduce.

Since colonies that have been more than two days queenless are apt to ball the queen, no matter what method of introduction is used, queens should be introduced soon after the colony becomes queenless, within the first two days if possible; and in case one wishes to replace an old or defective queen (one that continues to lay but few eggs and places them irregularly), this queen should not be removed until the new one arrives, because of the possible delay in the arrival of the new queen. And in case

the beekeeper considers the poor queen better than no queen at all, he may, before killing the old one, wait until certain the new queen has been accepted. Then the dequeening and requeening may be accomplished at the same operation. The old queen may be kept temporarily in a cage without attendant bees, the cage being inserted between combs of brood in any strong colony. If the new queen is not accepted, the old one may then be reinstated by introducing in the regular way. Extra queens may often be kept in this way for weeks.

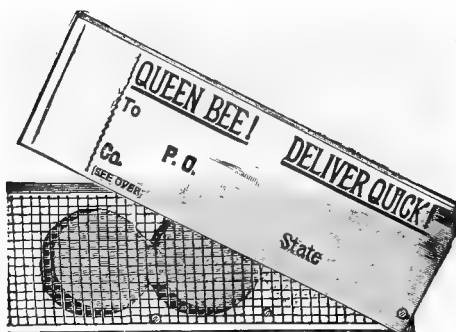

The mailing and introducing cage.

How to Introduce.

There are a number of good plans of introduction, among which we recommend introducing by means of the mailing cage (the same in principle as the Miller cage). Preparatory to introducing by the cage method, remove all the queen-cells that may be found present. See that the cardboard mail wrapping of the mailing cage is removed, but take care not to remove the pasteboard over the hole at the end. Place the cage, wire side down, above the opening between two frames so that the bees can easily get to it. In case the inside cover of the hive has no rim and so cannot be inverted to provide space for laying the queen cage on top of the frames, then the queen cage should be inserted between the tops of two frames. To do this, remove one frame containing no brood from the hive in order to give sufficient room to leave the wired side of the cage exposed so that the bees can visit it. In about 24 hours the bees have gnawed away the pasteboard nailed over the end; then they eat out the candy in the cage, and thus release the queen, which, by this time, has acquired the scent of the hive and will, therefore, be quite likely to be accepted. Examination of the hive should be made 24 hours after putting in

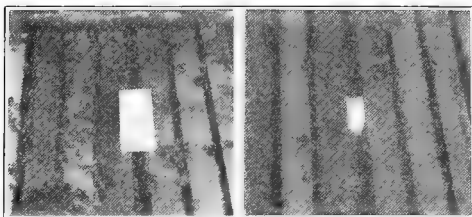

Introducing a queen in mailing cage, either by laying the cage on top of, or between, the frames of the hive.

the queen cage, and if the bees have not gnawed away the pasteboard over the end hole, it should be removed. The colony should be left undisturbed for at least five days after the queen has been accepted, for opening the hive soon after introducing may result in the loss of the queen by balling.

SWARMING.

CHAPTER XI.

It will not be long after the beginner has received his bees in the late spring till he must expect to have to meet the swarming problem and to deal with swarms. The first time he has to do this the task will likely seem both hazardous and difficult to him, and he will have to guard himself against "getting rattled." But swarming for the beginner, in its simplest treatment, need not be difficult. If he has only a few colonies, and wishes to increase the number, he will welcome a first swarm from each of his hives and handle it to his profit. Increase of colonies by natural swarming is the safest and easiest method by which the beginner can increase the size of his apiary.



A typical swarm of bees cut down with the branch of a tree on which the bees had clustered.

The swarming season may be expected everywhere in general about the time the bees are rearing the greatest amount of brood in the spring or early summer, for instance, in the northern part of the United States, in May and June, according to the earliness or lateness of the season. This is the time of most extensive brood-rearing if conditions are favorable, and swarming is the bees' natural method of increasing. It is then that, by a sort of seeding

mutual agreement, generally between 9 a. m. and 2 p. m. on a warm day, from a strong colony having plenty of brood and honey, most of the old bees with the queen (and perhaps a few of the young bees) will rush pell-mell out of the hive until the air is full of them going in every direction. This grand rush from the hive generally continues for only three or four minutes.

If the queen's wings have been clipped (see page 114), as should have been done earlier, of course she can not fly; but she will crawl out of the entrance and will be found in the grass near by, attempting to join the swarm.

In the parent hive are left the young bees that care for the brood, and capped queen-cells from which a queen will be provided for the now queenless colony.

The swarm at first, appearing like a cloud of black particles, soars about for a short time and then generally settles on some branch of a near-by tree or bush; but, if the queen is clipped, the swarm may return to its hive without clustering, as soon as the bees discover that the queen is not with them. Seldom does the swarm steal to a new home at some distance without first settling near the old home hive. If discovered while still in flight, the owner of the bees will accomplish nothing by beating tin pans, ringing bells, or making other noise to make them settle. If a fine spray of water from a fountain pump or even from a pail or dipper can be thrown on the swarm in its flight, it is likely to settle very quickly.

Causes of Swarming.

Without going into lengthy discussion and theories of why bees swarm, the beginner should know that swarming is the bees' method of reproduction of colonies; and it is, therefore, natural for them to swarm when they have become strong enough to divide, provided, of course, there is enough nectar in the flowers to make them prosperous. The desire to swarm is usually brought about by a congestion of bees in the hive, especially within the brood-chamber, and lack of sufficient ventilation—in other words, overcrowding of the hive, resulting in discomfort or



Bees sometimes cluster on the outside of the hive before taking their swarm flight. The two hives in the foreground show this condition.

at least a desire for expansion. It should also be noted that colonies with old queens are more likely to swarm than those having young queens.

Indications of Swarming.

As the swarming season comes on, the beginner should watch for signs of the forthcoming swarm. The clustering of bees on the outside of the hive is one of the general signs, although not a certain one, as bees may cluster on the outside because of hot or sultry weather, or because there is no nectar to be had from the flowers the field workers may stay at home instead of fruitlessly searching for nectar. But if a colony has been busy at work and then quits work without evident reason, while other colonies continue busy, at the same time clustering on the outside, swarming is probably near at hand. The most certain sign of swarming, if present, can be learned by an examination of the hive. If queen-cells containing eggs or queen-cells containing larvae are found in very strong colonies at the beginning of, or during, the honey flow, the bees are probably contemplating swarming. They usually issue from the hive at about the time the first queen-cells are capped, though Italians sometimes swarm before if the weather is quite warm.

Preparing to Hive the Swarm.

When a swarm issues it should be hived just as soon after the cluster forms as possible, whether the queen is clipped or not. For, if the queen is clipped, she cannot join the cluster, and it may accordingly break up and return to the old hive before the beekeeper has had time to hive it. On the other hand, if the queen is not clipped she will be with the cluster, and the swarm will therefore be likely to leave for a new home in some near-by woods or other possible retreat at any time after the cluster forms.

Therefore, whether one clips his queens or not, it will be necessary to make certain preparations for hiving the swarm before it issues. Even before the swarming season sets in, it is well for the beginner to provide one extra hive for every one of the few colonies he may have, in case he plans to allow natural swarming for increase. He should also have ready in advance frames with drawn combs, or, lacking these, frames with comb foundation (full sheets) with which to fill the new hive. In case the queen's wings are clipped (as they should be), the beginner will also need a queen cage. If he has no such cages he can easily make a little box out of wire window-screen or mosquito netting drawn tightly over a small box frame, which will serve the purpose of caging the clipped queen during the short time necessary to effect the capture of the swarm. And, in addition to these necessities, of course, the beginner will also want his veil, his gloves and his smoker in readiness.

Hiving a Swarm Having a Clipped Queen.

First, let us suppose that the swarm has issued from a colony whose queen has had her wings clipped. After the swarm has left the hive the

queen will be found, in all probability, hopping about near the entrance, sometimes attended by a little company of worker bees after she has been missed by them. Carefully put her in a queen-cage and temporarily leave her in a safe place out of the sun. Now the super or supers of the hive from which the swarm has issued (and in which supers the bees have already started to work) should be taken off the old brood-chamber and set on the ground near by. The brood-chamber itself should now be removed from its stand and its entrance turned in the opposite direction from which it formerly stood or with its entrance turned only part way around, so the returning field bees will not enter it. If any bees begin to enter the old hive, either cover it up or move it farther away. On the stand where the old hive had stood, now place the new hive containing frames of drawn comb or frames of foundation. Have the entrance face the same direction as did that of the old hive just removed. Now, on top of the frames place a queen-excluder (the rimmed side up always). Above the queen-excluder place the super or supers that have just before been taken from the old hive, and put on the cover. Next, place the queen, still retained in her cage, at the front of the entrance; or, better still, shove the caged queen just inside of the entrance out of the possible heat of the sun's rays, raising the front of the hive a little by blocking up at the front corners if necessary. The swarm, which may still be in the air or may have clustered, will soon discover that the queen is not with them and will return hastily to the old location, and, finding the queen there, will rush into the new hive. After the bees are well started going in, the queen may be released from her cage and she will hurriedly enter with them.

If there is no honey flow on at the time and no honey in the supers that are transferred from the old hive to the new, the beginner should exchange at least one or two frames of foundation of the new hive for one or two frames containing some honey taken from the old hive. The honey so given is necessary to keep the bees from starving until nectar can be gathered from the flowers.

It will surprise the beginner to note how soon this new first swarm goes to work with the greatest energy in its new home. No other bees work with quite so great vigor as do those of a newly hived, natural swarm.

The colony in the old hive is left standing at the side of the new hive for seven days when it should be moved to a new location, this being done at the time the bees are flying freely, as early in the afternoon, and the hive handled so carefully that the bees are not disturbed. When done in this way they do not seem to realize the change and go to the fields without noting their new location. When they return from the fields they go to their old location, and, not finding their own hive, they enter the new hive, thus joining the swarm. When done properly, this so depletes the parent colony of its bees just when the young queens are ready to emerge that it can not send out after-swarms, and at the same time the young bees, drawn from the parent colony, are added to the swarm where they are most useful in helping store honey in the supers. (See pages 87-88).

Soon a new queen will emerge from a queen-cell that had been started before the swarm left the parent colony. The so-called "old" or parent colony (which is in fact really the newest kind of colony because made up of all newly emerged bees) can be left to shift for itself, except, if the

nights are cool, the hive entrance should be contracted so as to prevent the escape of heat. Otherwise the brood might be chilled and killed. A little later, as the "old" hive fills with new inhabitants and the combs become filled with brood and honey, a super may be required. In a good season some surplus of honey may be expected from this rejuvenated "old" colony, unless the swarm issued late.

This method of handling a natural swarm, which has issued from a colony having a queen with clipped wings, is summed up in a few words: Find the clipped queen, cage her, remove the old hive to a new location, replace it with an empty hive containing frames of drawn comb or foundation, one of which should be replaced with a frame of honey if there is no honey flow on at the time; transfer the supers from the old to the new hive; place the caged queen at the entrance, and, as the swarming bees return to the new hive, liberate the queen, allowing her to enter with them.

This plan of managing swarms is applicable only when swarming takes place at the beginning of or during the main honey flow, as in the white clover region.

When swarming occurs some time before the main honey flow it is usually better to hive the swarm in a new location; and seven days later destroy all but one queen-cell in the parent colony, to prevent after-swarming; then, when the honey flow begins, put supers on both hives. In this case both the parent colony and the newly-hived colony would likely produce a surplus of honey.

Hiving Swarm Having Unclipped Queen.

Suppose the swarm has issued from a colony whose queen's wings are not clipped, and she accompanies the swarm in its flight and clustering. This presents quite a different problem from that of hiving the swarm whose queen has had her wings clipped and so is to be found near the entrance of the parent hive. The swarming bees with their queen accompanying them will not return to the hive of their own will, for their queen is not there. They are likely, at any time after clustering, to put off to a new home which "scout bees" have previously located, and so be lost to the beekeeper. This they may do within fifteen minutes after clustering, or they may remain clustered twenty-four hours or even longer.

The beginner should have the same equipment ready, and exactly the same new and old hive arrangements made, as in the case of the swarm that issues from a hive whose queen has clipped wings. And don't forget the smoker, as that now may become useful. One additional item of equipment is needed if the bees have clustered high up on some branch or shrub. If this bit of equipment be purchased in advance it will be a Manum swarming-device, which is a wire-cloth basket made in the shape of an inverted pyramid, and attached to a long rod or pole. It is a good thing for the beginner to have. But, not having one, let him attach an ordinary bushel or half-bushel basket to a crotch left at the top of a long pole so cut for the purpose. A loop of rope or strong cord attached to the handle of the basket can be slipped over one of the forks of the crotch at the end of the pole, thus allowing the basket to be easily detached. This contrivance is about as serviceable as any manufactured swarm-catching device. If the swarm has clustered somewhere low down,



Here is a swarm clustered on the low branches of a tree and easy to secure.

and within easy reach, a basket or a commodious box or bag will serve as a swarm-catcher.

If the bees have clustered low on the branch of some tree or bush, the capture of them is made easy. Either shake the bees into a box or basket or cut off the branch and carry it to the newly prepared hive, then shake the bees off on the alighting-board or other broad board placed temporarily in front of the entrance of the hive. Some prefer spreading a sheet in front of the hive on which to shake the bees; but while this is a little neater it is not essential.

When the swarm has been shaken down in front of the hive entrance the bees will

quickly begin crawling into the hive (or can be directed into it by brushing or gently smoking) and continue to enter the hive in the most enthusiastic way. Once in, they remain there contented, if the queen be with them. But if the bees begin running out of the hive and acting dissatisfied, apparently searching for something, the beginner may know that the queen has not entered the hive. He should then make diligent search for her, and will be likely to find her near by, perhaps under the hive, attended by a little group of bees, or he may find her at the original clustering place if all the cluster was not at first secured, and she will be found with an accompaniment of worker bees.

But suppose the swarm has clustered high in a tree or bush and the bees cannot be shaken into a box or basket nor carried on the branch when cut off, to the hive, as in the supposed case just described. Then, climbing or the use of a ladder may have to be resorted to, or the basket attached to the long pole (before described) brought into use. Having got the basket or box just beneath the cluster, with a smart shake or jar drop the cluster of bees into the basket or box. The queen is altogether likely to be in the mass of bees so shaken. Then carry them quickly to the hive entrance and proceed there as before described. If the basket attached to the end of the long pole has to be resorted to, a thrust upward with the pole, striking the branch with the crotch of the pole or the edge of the basket, will serve to jar the bees into the basket, which may then be quickly lowered and

carried to the hive entrance.

If the bees chance to cluster in a place where they can not be shaken down, as on a large branch or at the crotch of a tree or on a fence post or on any other unshakable place, it will then be found necessary to brush them off into the box or basket with a bee-brush or to dip them up with a tin dipper or even with the gloved hands. Bees that have to be captured in this way should be carried to the hive entrance just as soon after they have been got into the basket or box as possible. They may need a little smoking, too.

If a swarm of bees is to be captured at some considerable distance from the apiary of the beginner and then has to be carried there, such a swarm should be shaken into a loose-woven bag—a cleaned phosphate sack will do—and then by tying or holding tight the mouth of the bag the bees can be carried for a long distance to the hive awaiting them as their new home.



Shaking the swarm into a basket.

Mechanical Contrivances Sometimes Used.

To prevent an unclipped queen from leaving the hive with an issuing swarm, two contrivances are sometimes used. These are the queen and drone trap, and the wire entrance-guard. Either of these placed over the hive entrance allows the passage of worker bees but not of queens or drones. The queen and drone trap catches and retains the queen in an upper compartment, and when the swarm returns to the new hive which is placed on the old stand, the trap having been transferred to the new hive, the slide may be drawn releasing the queen so that she may enter the new hive with the returning swarms. Although the use of this contrivance makes it unnecessary to clip the queen's wings, it has one great objection—it is some inconvenience to the bees when entering and leaving the hive. It should be left on the hive just as little as possible. Its use is not generally recommended by experienced beekeepers, but the beginner who does not wish to clip his queen's wings will find this device a great convenience. (See illustration on page 70.)



Here is a swarm easily captured by moving a hive beneath it and shaking it on to a sheet placed about the entrance.

The wire entrance-guard does not trap the queen when a swarm issues, but simply prevents her from leaving the hive, thus compelling the bees to return exactly as they would do in case the queen's wings were clipped. The objection is the same as that to the queen trap.

Swarming Out.

After a swarm has been hived it sometimes deserts the new hive. This is called "swarming out." This may occur the day the swarm is hived, or the next day and sometimes even on the third day after hiving. It may occur either with natural swarms or with arti-

ficial swarms. Swarming out apparently is often caused by a lack of room in the new hive or by discomfort from some other cause, though occasionally a newly hived swarm may leave the hive when no cause for their dissatisfaction is apparent. This trouble may be prevented or greatly reduced by placing an empty hive-body, without frames, below the new brood-chamber for two or three days, by providing ample ventilation and shade for the new hive at the time of hiving the swarm, and by using one or more empty combs (which have been used previously for brood-rearing) in the new brood-chamber instead of frames of foundation exclusively. Combs

of unsealed brood are not recommended for this purpose. Entrance guards or queen-traps may be placed on the entrance of the new hive for a few days to prevent the queen's escaping, if newly hived swarms are inclined to swarm out, but the trouble usually can be prevented by making provision for



The beekeeper just naturally looks for the queen as the swarm runs into the hive.

the comfort of the bees, especially for the first day or two.

After-Swarms.

Among the untoward things that the beginner may have to meet in the swarming problem is that of after-swarms. If the parent colony which casts the first swarm was very strong in numbers, there may have been left in it enough bees to result in other swarms issuing after seven or eight days, called after-swarms. There may be a second or third or fourth or even more such after-swarms. This can be prevented by destroying all but one of the queen-cells after the issuing of the first swarm, for the cause of these after-swarms is a plurality of emerging young queens. When the virgin queen emerges after the preceding swarm has left the hive, she is prevented by the bees from destroying queen-cells that may be present, flies from the parent hive with another swarm, and this process may be repeated several times as other queens emerge in the parent hive. These after-swarms are undesirable, as they are generally too weak to be valuable. They also weaken the parent colony to such an extent that no surplus honey is likely to be produced. The plan outlined on pages 64 and 65, by which the parent colony is moved to a new location on the seventh or eighth day, prevents most after-swarms. This plan is also described and illustrated on pages 87 and 88.



The swarm on this post, if it is to be hived, will have to be brushed off with a bee-brush, or handled with a dipper or gloved hands.

Swarms Uniting.

Another emergency that may confront the beginner is that of two or more swarms issuing at the same time and clustering together. If the beginner has clipped his queens as he should have done, the best plan is to divide the cluster as evenly as he can and distribute about the same number of bees to each of the clipped queens now caged in the new hives on the old stands.

In case the queens are laying-queens and not clipped, he may treat the large cluster in the same way. If one of these divisions has more than one queen, all but one will probably be killed or else the bees may form as many clusters as there are queens, when each cluster may be hived. If one of the divisions has no queen the bees will appear restless, running all about the outside of the hive and in the grass looking for her.

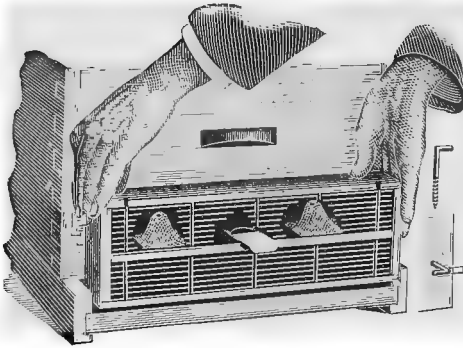

Queen and drone trap placed at the hive entrance.

Such a division may be united with one having a queen, if this can be done before the bees go back to their respective old locations.

Whenever hiving bees that may be accompanied by a virgin queen, one of the frames in the new hive may well be replaced by a frame of comb containing young larvae. This provides against failure of the virgin to mate.

Smoking the Swarm.

Common sense will dictate to the beginner that he handle swarming bees as gently as possible. They are usually gorged with honey when issuing in a swarm from the hive, and ordinarily they may be handled without fear of stings. Yet they can and do occasionally sting when swarming. This is the reason for having a smoker on hand and using it, if necessary, when first closely approaching a swarm clustered on a bush or tree. Use the smoke, too, on the clustered swarm whenever they appear to show any signs of hostility. Swarms that have been clustered for a half day or more are sometimes inclined to be very cross and extra precaution should be taken in such cases. But under ordinary circumstances the smoker will be little needed in hiving a swarm.

General Observations on Swarming.

Let it be remembered that, excepting in parts of the South, the more swarming there is in an apiary the smaller will be the surplus-honey crop. Therefore, swarming is not desirable when the owner of bees is working for a crop of honey. This fact leads the owners of many apiaries either to restrict swarming greatly or to try to prevent it altogether. (See pages 73-76 and 84-88.)

Swarm Prevention and Control.

Swarm prevention is one of the greatest problems which the beekeeper has to solve. For the particular methods of prevention or control of swarming in extracted-honey production and in comb-honey production, see the discussion of this subject in Chapters XII and XIV.

EXTRACTED HONEY—HONEY FLOW AND HARVEST.

CHAPTER XII.

The outfit for extracted-honey production, it will be remembered (page 11), is the same for comb-honey except that an extractor and an uncapping-knife will be needed, and instead of comb-honey supers extracting-supers will be needed.

Differences Between Comb and Extracted Honey Production.

As already pointed out it is much easier to produce extracted honey than to produce comb honey, for bees are less inclined to begin work in a super of small section boxes than they are in a super of large combs; also the bees are obliged to convert considerable honey into wax in order to draw the foundation of the sections into comb, whereas in extracted-honey production the same comb is used year after year and the bees are therefore able to store all their freshly gathered honey in the combs, instead of converting part of it into wax. Furthermore, the extracted-honey producer is able to give an abundance of empty combs in order to prevent swarming, but the comb-honey producer is obliged to keep his colonies more crowded for room in order that the sections shall be well filled and most of them completed. For partially sealed sections of comb honey bring a lower price than fully sealed sections, while this is not true of ripe but unsealed honey in extracted-honey supers, all of which can be extracted and sold.

These differences, as we have already noted, necessitate a difference in management, and we shall accordingly discuss the management for extracted-honey production and the management for comb-honey production separately.

Preceding the Honey Flow.

Throughout the spring each colony from which the beekeeper expects surplus should be supplied with sufficient packing to keep it warm, a good queen, and plenty of stores—at least 10 pounds or the equivalent of two combs of honey. In case one uses double-walled hives as we advised, the top packing should be left on as long as it does not interfere with handling the colonies, and the entrances should not be made large until the weather becomes so warm and the colonies so strong that more ventilation is necessary, as indicated by bees hanging out on warm days. Sometimes it may be of advantage to leave top packing and contracted entrances until a few weeks before the main honey flow.

If colonies become crowded for room before the honey flow, they should be given a hive-body containing frames of drawn comb, or foundation in case one lacks the drawn comb. This hive-body should be the same size as the brood-chamber, so that two or three frames of brood may be raised

into this story, the frames of brood in the lower story being crowded together so there will be no danger of the brood's chilling, and the vacant space at the side should be filled with frames of drawn combs. If the combs in the second story are old dark brood-combs, the queen will usually move "upstairs" promptly without combs of brood being placed above, provided the colony is strong and needs more room; but, if new white combs are given, it is better to put at least two combs above in order to induce the queen to begin work promptly in the second story. Combs of foundation should not be given during a dearth of nectar, but should be given only when the bees are gathering enough honey from early flowers to induce them to draw out the foundation and build comb. Two or three combs of brood should then be placed in the middle of the upper story, and the frames of foundation placed on each side. The foundation is drawn out more readily in those frames adjacent to the combs of brood, and if the colony is quite strong the combs of brood can be placed in the middle of both the upper and lower stories, so that four frames of foundation are adjacent to combs of brood, two above and two below; but usually it is better to have all the foundation drawn out in the upper story. As soon as the combs adjacent to the brood are built out, they can be exchanged with frames of foundation not yet drawn out, in order to hasten the drawing-out of the foundation. Giving the queen so much room makes the colony more contented and less liable to swarm.

Time of the Harvest.

The honey harvest comes with the bloom of the chief nectar-producing plant (or plants) of the beekeeper's locality. In northern regions this honey flow is brief, but the nectar production is usually heavy while it lasts. In some southern regions the honey flow lasts longer but is not so intense, while in other regions it is intermittent. The honey flow varies in different localities as do the plants of those localities. So it is necessary that the beekeeper know what the honey-producing plants are in his neighborhood; know when these bloom; and exert every effort to have his colonies of bees strongest when the big honey-producing bloom comes, in order to secure the largest quantity of nectar possible. The control of swarming, about which there is always so much discussion among beekeepers and in all beekeeping literature, is only for the purpose of bringing the bees through the honey flow in the strongest possible condition. To build the colonies up to great strength in time for the honey flow, and maintaining this condition throughout the honey flow, is a difficult problem in northern regions where the honey flow comes early and may last only a very brief time; and where the honey flow is longer and even, it is difficult to maintain the colonies at highest strength throughout the entire period.

So, let it be remembered that the successful management of the bees for greatest service during the honey harvest requires a thorough understanding of the conditions of the beekeeper's locality. For instance, part of such "locality" knowledge concerns not only the big flow of nectar at honey-harvest time, but also the earlier honey flows which provide stores for the bees and furnish a stimulus to breeding. This knowledge of the periods of blossoming is especially necessary in regions where the blossoming periods are short, as in the North. By consulting an experienced bee-

keeper of the neighborhood the beginner may learn about when to expect the different honey flows and especially the main honey flow. For instance, if he lives in the clover belt, he will probably be told that the honey flow may be expected to begin about ten days after the first few clover blossoms are discovered. Knowing the time of the opening of the honey flow, he will lay his plans accordingly.

Swarm Prevention.

Very often it helps in preventing swarming to raise the hive from the floor by means of half-inch blocks in front in order to give an extra-large entrance and a little more ventilation. Sometimes in the hottest

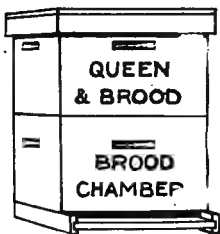

Previous to the honey flow the queen occupies both stories.

weather during the swarming season it pays to raise the covers from the supers a slight crack, blocking the covers up by pieces of broken sections or other equally thin pieces of wood that will not allow a bee-space. This should be done only in extreme cases when the bees are hanging out in front of the hive because the hive is too hot. Some shade is also a help, since colonies usually swarm more in the sun than in shade. Again, colonies with young queens do not swarm so readily as do those with old ones. Keeping queens under two years old is, therefore, a help in preventing swarming. Keeping down the number of drones is another aid in preventing swarming. This may be

done by cutting out drone comb and replacing it with worker comb. (See page 115.) It is also a good practice to cut out any queen-cells, that may be found, every seven or eight days during the swarming season, provided the queen-cells have just been recently started and contain only eggs or very small larvae; but this will not always stop the swarming fever. It will do no good to destroy the advanced queen-cells. Plenty of room in the brood-chamber for the queen to lay is of great importance in the prevention of swarming. Super room should always be given in advance of the colonies' apparent need of it.

Taking for granted that the beekeeper is working for a crop of surplus honey, he approaches the honey harvest seeking to have his colonies as strong as possible. In case of the strongest colonies he has placed another hive-body containing a little brood above the brood-chamber, to give more room and so avoid swarming. As the honey flow approaches he will find brood-rearing going on actively in both stories of the brood-chamber. After the queen has moved "upstairs" she often abandons the lower brood-chamber and confines her work to the second story. If the early flowers yield considerable nectar, it is sometimes necessary to put on a third story before the main honey flow begins, to prevent the queen from being crowded "downstairs" again, which would probably result in swarming. About a week after the main honey flow begins, or when the second story is fairly well filled with brood, honey and pollen, there now being many

vacant cells below, the queen should be hunted up. If she is not already on one of the brood-combs in the lower story, she should be placed there and a queen-excluder put on to confine her there. If the weather is warm and honey is being stored freely, a super of empty combs may now be placed above the excluder, and the former second story placed on top, making the hive three stories high. When combs of brood are left separated from the queen by an excluder, the bees frequently start queen-cells on them. These queen-cells should be torn down eight or nine days after separating the queen from the brood in the super. As the brood in these combs now above the queen-excluder emerges, the bees will store honey in the cells thus vacated, and these combs now become extracting-combs.

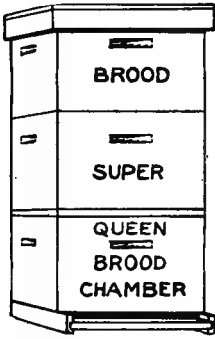

Queen is put below excluder and brood placed above the super.

When the honey flow is on and the weather is very hot, the swarming tendency will be diminished by moving the inner cover back a little, leaving a quarter-inch crack at the front of the hive, giving additional ventilation. To give still more ventilation, the supers may also be moved slightly backward or forward to give a bee-space, and the hive itself may be raised from the floor by inserting a small block at each front corner. When the hive is raised on blocks in this way, a little smoke should be blown in the opening at the side when beginning work at the hive; otherwise, the sentinel bees stationed along the crack to protect their home will be likely to dart out and sting. The beginner should be cautioned against giving such excessive ventilation except as a last resort in preventing swarming during very hot weather and when the honey flow is on, for at other times there is danger of robbing. In the northern part of the United States, sufficient ventilation may usually be provided by leaving a crack at the rear, between the brood-chamber and first super. This is done by moving the first super forward about half an inch and piling the other supers squarely above the first one.

One might suppose that, if all our directions have been carefully followed, no queen-cells would be started for swarming; but, in a few cases, queen-cells may be started in spite of all our care. For this reason colonies should be carefully examined every seven or eight days during the swarming season. If, at any time, queen-cells are found that are not far advanced, or if the swarming season is about over, the bees may be induced to give up swarming by simply destroying the queen-cells, supplying more supers, and giving the queen more room to lay by placing several combs of emerging brood in an upper story and replacing these with empty combs below. In some cases, even when this has been done, the bees persist in carrying out their own program as to swarming, and if left alone will swarm usually about the time the first of the queen-cells are sealed. If a colony is allowed to swarm in the natural way, its work is more or less interrupted just at the time the bees should be storing honey. Also, it is either necessary to drop one's other work and hive them whenever they decide to swarm; or the bees, if the queen is not with them, will return to the hive and repeat the performance shortly, and, if the queen is with

them, will abscond and be lost if not hived promptly. In some cases, moreover, even though their queen is clipped and can not accompany the swarm, the swarming bees may escape by joining some runaway swarm and leave for the woods or some other new home. When well-advanced queen-cells are found indicating that the colony is determined to swarm, the following treatment may be given.

Swarm Prevention with Increase.

Temporarily place an empty hive-body beside the brood-chamber, and, after tearing down all capped queen-cells, put into it all the combs from the brood-chamber with adhering bees, with the exception of one comb containing some larvae and the queen. Be sure that the queen with a few

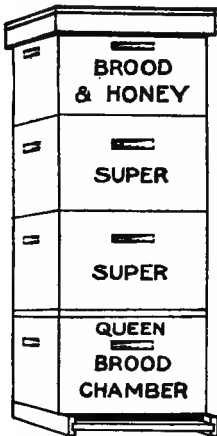

Brood placed above supers and queen confined below with but one comb of brood.

bees is on the one comb left in the brood-chamber. On either side of this comb place sufficient frames of foundation (or preferably drawn combs) to fill the brood-chamber, and put a frame of foundation (preferably a drawn comb) into the hive-body to which the brood has been removed in order to make up the 10 frames there. Above the brood-chamber put a queen-excluder, replace the supers, adding empty ones, if necessary, to have at least three shallow or two deep supers. These supers may be partly filled with honey, but the lower one should be left with plenty of room for storing. Next, on top of all should be placed the hive-body of brood just removed from the brood-chamber. Some provide a small opening in one of the upper stories to permit the escape of drones, but most of the bees continue to use the regular hive entrance below.

This upper hive is so far removed from the lower that the bees in it, to all intents and purposes, are now a queenless colony, and thus the bees seem to regard it, for they straightway proceed to finish the splendid-looking queen-cells just as they ordinarily do under the swarming impulse, and yet in the hive below no queen-cells appear. At the end of seven or eight days nearly all the brood in this upper hive will be sealed and some of the queens just about ready to emerge. The uppermost hive may then be moved to a new location for increase, and left with the entrance contracted. All but the best queen-cell should be destroyed. Of course, a floor and a cover should be given to this new colony. The queen-cell left in the hive should be the best one, long and plump, with well-defined pits on the sides. To avoid injuring the unemerged queen, the frames should be carefully handled without jarring and held in the same position in which they were hanging in the hive.

During the whole operation of making increase under the swarming impulse (as just described) the hive is opened but twice, and it is opened the second time only to set the uppermost story on a new stand. The work of the colony has not been interrupted in the slightest; the brood, until sealed, has been left in the warmest part of the hive, and the whole colony left for a week to increase the new one. But, above all else, the success of the plan is doubtless due to the fact that the method so closely follows nature's

plan of swarming. Most of the old field bees are in the new hive below, storing honey and starting housekeeping anew, while the young bees and cell-builders are in the upper or old hive where they are busily engaged in rearing a new queen.

Swarm Prevention Without Increase.

The above plan may be altered if no increase be desired. In that case, instead of moving the old hive to a new stand at the end of seven or eight days, the queen-cells of the upper story may be destroyed and the brood distributed to other colonies or left in its position at the top of the hive to increase the original colony. As the brood emerges the cells will be filled with honey, if the bees are gathering freely.

Supering.

When the queen is confined to the first story by means of the queen-excluder, about a week after the opening of the honey flow as already advised, one comb, or better, two, should be removed from the super, preferably one at each outside, and the remaining combs spaced an equal distance. These combs will, later on, be bulged with honey beyond the edges of the frames. The super will thus hold a little more honey than if the full number of combs had been used with close spacing; but, what is more important, the fat bulged combs may be uncapped in much less time than is required for uncapping thin combs, and fewer combs are handled in extracting a given amount of honey.

The fact that brood has been reared in these extracting-combs makes them stronger, easier to uncap and less likely to break in the extractor. Such combs may be used year after year, and they will grow tougher and better all the time.

The beginner should never wait until the first super is entirely filled before putting on the second one; otherwise, this crowded condition may cause swarming. When the first super—that is, the second story which had been used for a time for brood-rearing—is a little over half full of honey, it should be set to one side temporarily, a second super put in its place, and then the first partly filled super placed on top. This can be done when the queen is put below the excluder. The second super should contain in the center the two combs taken out of the first super to permit the wider spacing, the rest of the room being taken up by wired frames containing full sheets of foundation, provided no other extra combs are available. Until the foundation is drawn out into combs the frames should be closely spaced in order that the foundation may be drawn out evenly. Here it should be said that combs are greatly to be preferred to foundation in extracted-honey production; and the more combs the extracted-honey producer has, the better.

It does no harm to leave the extracting-supers full of honey on the hive till after the honey flow before extracting, stacking them up three, four or even six high if necessary. The nearly full supers should always be put on top, the additional ones underneath next to the brood-chamber,

EXTRACTED HONEY - HONEY FLOW AND HARVEST.-Chap. XII.

except near the close of the honey flow, when the last super to be needed should be placed on top, as the bees will then fill the lower supers full before beginning work in the added super at the top, which result is very desirable. The longer the honey is left on the hive, the thicker and riper it becomes if the weather is hot and dry.

EXTRACTING.

CHAPTER XIII.

In general, we may say that honey should never be extracted until it is thick and well ripened. As soon as the bees consider it properly ripened they begin capping it over. Those combs, therefore, that are at least three-fourths capped over would probably be sealed in a few hours if left on the hive, and may, therefore, be safely extracted. But if honey is extracted before the bees have ripened it, it will be thin and of unpleasant flavor, and, after being kept for a time, will doubtless ferment.

There is nothing gained by extracting before the honey flow is over except in localities where another source of nectar begins to yield before a preceding one is over, and where it is desirable to remove the earlier and choicer crop before it can be mixed in the combs with a less desirable crop. Sometimes, also, the beginner may be caught with too few supers and extracting-combs to permit tiering up throughout the honey flow. Then it becomes necessary to extract in order to provide empty supers. If one is willing, however, to go to the extra expense of keeping himself supplied with sufficient supers and frames so that no extracting need be done until after the honey flow, he will find that this requires less labor and gives much thicker and finer-flavored honey except in arid regions of the West where the honey is ripened quickly. The employment of this plan may result in a somewhat smaller crop the first year because of the necessity of the bees drawing out so much foundation; but it should be remembered that these same combs may be used year after year, probably for the remainder of one's lifetime. Therefore, it would be poor economy to attempt a small saving the first year that would result in a loss during each succeeding year; and unless one lives in a locality where one source begins before another ceases, and there is consequent danger of undesirable mixing of the two flows, we really see no excuse for extracting before the end of the honey flow.

Taking Off the Honey.



Inserting the bee-escape.

When it is time to begin extracting, the bees may be trapped out of the super by means of the bee-escape. The bee-escape board is a board exactly like an inner cover (and may serve as an inner cover when not being used for removing honey), having in the center a device called a bee-escape. Through this the bees can pass down from the supers into the brood-chamber below, but cannot return. If placed under the super in the forenoon, the bee-escape almost completely frees the upper supers from bees by the next day. The beginner must observe



Shaking bees off a comb.

the greatest care not to leave any opening into the supers above the escape-board large enough to admit a single bee. For, if he commits this carelessness, robber bees will find the opening, carry away all the honey and make trouble generally. But by the proper use of the bee-escape, the honey may be removed without the bees knowing anything about it—no hard work, no stings, no danger of robbing; in fact, if the supers of honey are not removed from the hives until after the honey flow has ceased, a beginner should not ordinarily attempt to get the bees off the combs by any other plan: for, after a few days of idleness following a good honey flow, the bees are prowling around, apparently just looking for trouble; and a little exposed honey is like easy money, and the bees are quick to start robbing. During a dearth following a honey flow, therefore, a beginner cannot be too careful, for it is easier to prevent robbing than to stop it when once it gets started.

Cold honey is much harder to uncap and extract than warm honey. For this reason some who extract honey directly from the apiary use a screened or ventilated pattern of escape-board instead of the ordinary one. This ventilated escape permits the warmth from the brood-chamber to rise and keep the supers warm even after the bees have left through the escape. Those who prefer to use the common escape-board often pile their supers of honey in a warm room in order that the honey may be extracted more easily.

When the bees fail to leave the supers by way of the escape-board, as may happen when the escape becomes clogged by dead bees, when the queen may accidentally be shut above the excluder, or when the combs in the super contain some brood, it may be necessary to shake or brush the bees from the combs. In case there is a light honey flow and no danger of robbing at the time, this may be easily done. A little smoke should be blown in at the entrance of the hive, the cover taken off the super and several vigorous blasts of smoke blown down between the combs, thus driving the bees out of the way. The combs should be withdrawn from the super and given a sharp shake or two downward while held over the alighting-board of the hive. Not all of the bees can be dislodged by shaking, and, therefore, the few remaining should be brushed off, the comb being held as shown in the illustration, and the brush quickly and lightly swept over the sides alternately. With the comb held in this position, it is not necessary to reverse it when brushing the other side. If the bee-



Brushing bees off a comb.

keeper has a helper it saves considerable time to let the helper do the brushing with a brush in each hand.

As soon as the supers of honey are freed from bees, they should be removed to the room where the extracting is done. It is hard to find anything more convenient than a wheelbarrow for carrying heavy combs, except where the ground is rough and uneven. Even though bees may be bringing in honey, it is well to keep the supers containing honey covered to prevent robbing; and, of course, if there is a honey-dearth, the honey should not be left uncovered a second longer than is absolutely necessary.

Necessary Extracting Equipment.

Before going to the expense of securing an extracting outfit, the beginner will do well to learn if he can locate a near-by beekeeper already having an extractor, who will be willing to do his extracting for from one to two cents per pound. By so doing he may save considerable initial expense.

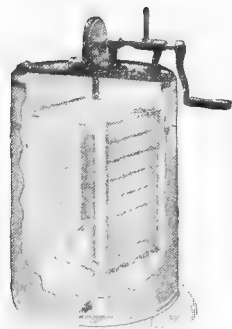

The simplest and least expensive extractor. Holds two frames and is not reversible.

For the beekeeper with but few colonies, a simple practical outfit may be provided at very small cost, and this outfit will be sufficient until his apiary has increased to 25 or 30 colonies. He will want a small extractor, which should be securely attached to a solid box firmly bolted to the floor, the box being of the right height for drawing off the honey. The best location for the extractor is near the wall where there is less vibration when in operation, for continued vibration is apt to pull the can or box loose, especially if care is not taken to place combs of equal weight in the two sides of the extractor.

Near this extractor should be the uncapping-can. This may be made of a barrel with one end bored full of holes, and a coarse screen nailed over these holes. Across the top, about one-third of the distance from one side, a two-inch strip should be nailed, at the middle of which a sharp-pointed nail projects upwards about an inch to hold the frame while uncapping. The barrel itself may be supported in a tub to catch the honey which drains from the cappings. The screen at the bottom catches and retains the wax of the cut-off cappings.

If one cares to take the extra trouble, a cheap yet handier receptacle could be made similar to that in the figure. This box may be made of any desired length and about 19 inches wide, so that the uncapped combs can be suspended cornerwise in one end of the box until they are extracted. Near one end is a cross-piece, with the upward-projecting nail-point for holding the frame while uncapping. The bottom of the box is covered with heavy, coarse screen, which is held above a shallow galvanized-iron tray by half-inch



An inexpensive uncapping receptacle can be made from a barrel with a wire-cloth screen over the bottom and a tub to catch the dripping honey.

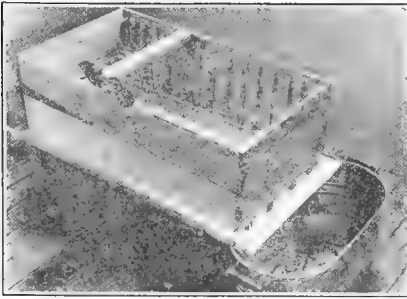

A plain box with a screen on the bottom, the box resting on a metal tray, makes a good capping receptacle.

cleats nailed on lengthwise of the box. The box and tray are placed at the right height for easy uncapping, the outlet end of the tray being somewhat lower than the opposite end, and just above the receptacle into which the honey from the cappings is to drain.

Not far from the extractor should also be a straining-can in which is suspended a large cheesecloth bag attached to a hoop supported by the top of the can. Too much honey should not be drawn from this can. *There should always be enough left to cover the bottom*

of the strainer at least; for, if the honey gets low, the cappings that would otherwise float on the surface of the liquid will collect on the strainer and soon clog it.

Actual Process of Extracting.

The supers of combs to be extracted should be placed within easy reach of the uncapping receptacle that is to catch the cappings as they are cut off from the combs. Then one at a time the combs are removed and held with the top-bar away from the operator, and the end-bar resting on the nail-point of the cross-bar. Holding the upper end of the frame with the left hand, and tilting the upper end slightly to the right so that the cappings may fall freely, begin at the lower end of the comb with an ordinary uncapping-knife heated by dipping in hot water (if no steam-heated knife is to be had), cut the cappings from the entire right side of the comb, performing the operation with a kind of sawing motion. If the comb contains any depressions, the heel of the knife should be used to remove the cappings in such depressions. Then reverse the comb, still keeping the top-bar away from the operator, using the cross-piece to scrape off any cappings that may adhere to the knife.

The uncapped combs may next be placed one in each basket of the extractor, with the top-bar



Uncapping combs with a steam-heated uncapping-knife.

next to the hinge in the basket if a reversing extractor is used, in order to save strain on the frames. It is quite worth while to use two combs of about the same weight; for, if not well balanced, the extractor will run unsteadily, and may become loosened from its support. In case of old dark combs whose cell walls are strengthened by many layers of cocoons, there will be but little danger of the combs breaking. When new combs are extracted—those in which brood has never been raised—greater care will be necessary to prevent the combs from breaking badly. Such combs should be extracted until about half of the honey is out of the cells of one side; next, the combs should be reversed and the other side entirely extracted, and then the rest of the honey extracted from the first side. The rapidity with which the extractor may be run will depend upon how fast the combs may be whirled without breaking. As just said, old combs are much stronger than newly drawn combs.

When the extracted honey fills the extractor almost to the reel a part of it may be drawn off at the faucet and allowed to run into a pail, which may then be emptied into the straining-tank, from which it may be run into cans or other receptacles in which it is to be stored.

Care of Sticky Combs.

As fast as the combs are extracted they may be again placed in the supers and stacked up in the honey-house. Along toward night these combs still wet with honey may be placed in supers and the supers placed on the hives for the bees to clean out the little honey still adhering. The bees will clean this out more readily if an empty super, or an escape-board with escape removed, intervenes between them and the brood-chamber. Some stack up the combs anywhere outdoors over a floor, giving a small entrance at both the bottom and top, and allowing the bees to clean the honey out by slow robbing—that is, by going in and out through a small entrance at the bottom of the stack. There are objections to this plan, however; for, if one is not careful, the robbing will be fast instead of slow. Furthermore, if there is danger of disease, such as American foul brood, it might by this procedure be scattered all through the apiary.

How and Where to Store Honey.

The best place for keeping honey is in a dry room where the temperature remains from 70 to 90 degrees Fahrenheit. But honey may be kept satisfactorily in almost any dry place, although low temperature and sudden changes cause most honey to granulate more quickly. Almost all honey will granulate in course of time; some kinds very soon, other kinds not for months, or even years. This is true of either comb or extracted honey. Heating of extracted honey greatly retards granulation, and for this reason most bottled honey is heated when being bottled.

Honey should be stored in tin cans or crocks that can be easily heated, and never left in large tanks where it may candy and be difficult to get out.

Preparing Honey for Market.

If the beginner has been fortunate enough to secure a surplus of honey beyond his own needs, he may want to consider the matter of marketing.

If stored in 60-pound cans, when one wishes to bottle, such a can may be placed in a larger vessel of hot water over the fire. In the bottom of the larger vessel should be placed blocks (pieces of brick will do), so that the can of honey will be completely surrounded by a jacket of hot water. After the temperature has for a time been held between 130 and 150 degrees Fahrenheit, the honey will all be in liquid form, clear of all granules, and is then ready for bottling. The temperature of honey should never be allowed to go above 160 degrees Fahrenheit, lest its flavor be injured. The jars should be filled and sealed while the honey is still hot. When preparing honey for market one cannot be too painstaking in making the appearance of the honey attractive in every way. He may put it up in pint or quart jars (containers), and should have these neatly labeled—and all scrupulously clean. A supply of fine-quality containers and labels can be secured of any beekeepers' supply house, or, possibly, in one's home town. "Mason jars" are often used for a trade that does not extend beyond neighbors and acquaintances.

Finally, the beginner generally accepts too low a price for his honey. Let him study the honey market (quoted in many large city dailies and in all bee journals) before he sets a price on his delicious food product.

COMB HONEY—HONEY FLOW AND HARVEST.

CHAPTER XIV.

The successful production of comb honey, as we have clearly shown (page 9) requires greater skill and more experience than does extracted-honey production; and yet, there is no denying that fancy comb honey is indeed beautiful in appearance, and those who prefer it to the extracted will perhaps be willing to go to extra trouble in order to produce it.

Before the Honey Flow.

The necessity for maximum strength of the colony at the opening of the honey flow is even greater in comb honey than in extracted-honey production; for a weak colony, that might harvest some surplus honey in extracting-supers having drawn combs, is not at all likely to harvest any surplus in the small comb-honey sections wherein combs have first to be built by the bees. In order that the colonies may build up to maximum strength in time for the harvest it is especially important that the colonies be kept warm during the spring and that they have good queens and plenty of stores at all times clear up to the honey flow. Also, as soon as the colonies are strong enough to occupy two stories, a second story of combs should be given as suggested in the production of extracted honey. If the weather is still cool the extra hive-body may be placed below instead of above the old brood-chamber. This will leave the most of the brood in the warmest part of the hive where there will certainly be no danger of its chilling. If the queen is thus given access to two stories as soon as the colony can occupy them, she will have plenty of room to lay and the colony will build up rapidly, with little danger of swarming before the honey

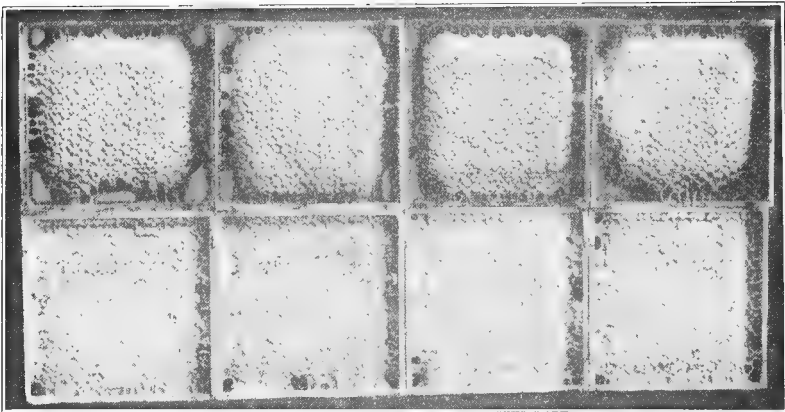

Comb honey in the section boxes. Those in the lower row were filled during a good honey flow, hence are better filled than those in upper row.

flow begins. Also, the bees will get into the habit of storing above, and so at the opening of the honey flow will more readily begin work in sections when the comb-honey supers are put on.

Beginning of the Honey Flow.

When comb honey is being produced it will not do to put the super of sections on top of the second story, if a second story was given previous to the honey flow to supply more room for the queen. Neither will it do to put it between the two brood-chambers, for the bees in building comb in the sections would darken it with bits of wax from the brood-combs above: so it is necessary to reduce the colony to one story during the honey flow for comb honey. In doing this most of the brood should be put into the brood-chamber that is left, choosing as far as possible the oldest brood, which can be distinguished by its emerging bees or by picking off a few cappings to note the age of the pupae. This older brood will soon emerge, giving the queen more room for eggs. The hive is then ready to receive the comb-honey super. Colonies that are quite strong may need two supers at this time.

If there are three or four colonies to work with, the extra combs just removed, containing some honey and brood, after the bees have been shaken off, can be put back into the hive-bodies, which are then tiered up on top of one hive, choosing for this the weakest colony. If the season is favorable this colony should fill these combs with honey after the brood has emerged, thus furnishing a large reserve of stores to be distributed to the other colonies after the comb-honey supers are taken off at the close of the season, thus again making them two stories high.

Those who have but one colony will have to work out some other plan for disposing of the extra combs of brood and honey, if the colony is occupying two stories at the beginning of the honey flow. One way to do this is to form a small colony from the extra combs of brood. This should not be attempted unless there are more combs of brood than will go into one brood-chamber. If the colony is quite strong there may be from two to five extra combs of brood. In such cases, these extra combs of brood, together with the adhering bees, should be put into another hive together with the combs which contain no brood, being sure that the queen is left in the main colony on the old stand. When making increase in this way, combs of emerging brood should be taken instead of combs of unsealed brood, in order to enable the little colony to build up without losing any undeveloped brood by chilling. The entrance should be closed with grass to confine the bees in this little colony the first day, so that too many of them will not go back to their old home.

While this little colony can raise a queen, if some of the brood-combs contain recently hatched larvae or eggs from which to raise her, queens reared in small colonies usually are not so good as those reared in larger colonies; so it may be better to purchase a queen for this little colony.

Use of Bait Sections.

As already explained, it is more difficult in comb-honey production to get the bees to work in the supers than is the case when producing extracted honey. In order to get the bees started to work in the sections, the best

plan for the beginner, provided he is able to obtain a few sections of drawn comb from a neighboring beekeeper, is to place such sections of drawn combs (bait sections) in the center or at the sides of the supers. If he cannot get sections of drawn comb to use for bait, he may, perhaps, be able to get shallow frames of comb to use in this way. Most comb-honey producers do not use a queen-excluder, since the queen does not often lay eggs in the sections; but, if any of these bait sections contain drone comb instead of worker comb, the queen often lays in these drone-cells. This can be avoided by using full sheets of foundation in the sections (as always should be done, anyway) or placing a queen-excluder between the brood-chamber and the supers.

Supering.

Just when to give the second comb-honey super depends upon the strength of the colony and the rapidity of the honey flow. If the bees enter the first super promptly and begin working in most of the sections at about the same time, the second super should be given within a week if the bees continue working well, even though the first super is less than half full. If things look favorable for a continuation of the honey flow this second super should be placed below the first super adjacent to the brood-chamber. If the honey flow is slow or the colony is not strong, so that the bees begin work in only a part of the sections in the middle of the super

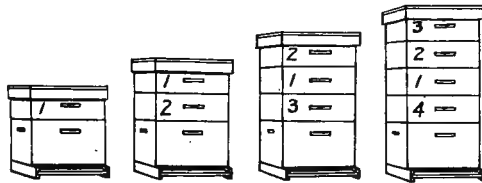

How supers should be given to a comb-honey hive. The latest super to be given is placed just above the brood-chamber.

and work outward, it is better to put the new super on top until the bees begin to work in it there, when it can be placed below and another empty one placed on top, if needed. No comb-honey super should be raised up and an empty one placed under it until the bees have drawn out the foundation and started to build out the cells in every section. Placing the empty super under the partly filled one causes the bees to expand their super work more rapidly than when it is placed above. This is highly desirable when the honey flow is heavy and the colonies are strong; but if the work in the supers is expanded too fast, the sections will not be so well filled and at the close of the season there will be too many unfinished sections.

In order to encourage the bees to finish the first super promptly, some beekeepers prefer keeping it in position as second super until it is finally finished. When more than two supers are given, those which are partly filled are each in turn transferred to a new position above the one nearest completion, as shown in the accompanying illustrations, thus keeping the first super near enough to the brood-chamber to cause the bees to finish it promptly if the colony is strong and the honey flow is good.

Swarming When Producing Comb Honey.

If the colonies be given a second hive-body as soon as strong enough to occupy two stories, and then are given two comb-honey supers at the

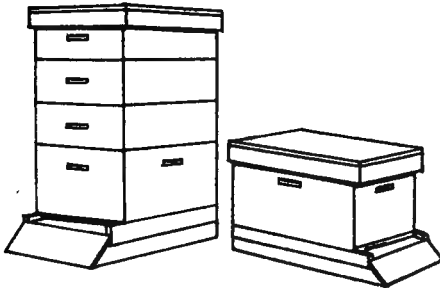

When a swarm issues it is hived in a new hive placed on the old stand, the old hive being placed at one side with its entrance turned away. The supers are placed on the new hive on the old stand.

the little boxes for the storing of the honey, are not so attractive to the bees as larger combs such as are placed in the supers for extracted-honey production. Therefore, unless the supers are "baited" by placing in them some sections containing drawn comb, saved over from the previous year, the tendency is to crowd the honey into the combs of the brood-chamber, thus diminishing the space for the queen to lay and bringing on the crowded condition so conducive to swarming.

An expert beekeeper can do much toward overcoming this state of affairs, especially by skill in supering (see page 86), and keeping the bees comfortable. It is well for the beginner to keep in mind that if the bees are always comfortable and have plenty of room there is much less tendency to swarm than when conditions are less favorable. The hives should be shaded by means of shade-boards which project beyond the edges of the hives if single-walled hives are used, and the entrance should be opened to full size, giving an entrance $\frac{7}{8}$ inch deep by the full width.

While there is plenty of nectar to be had the bees should not be permitted to cluster on the outside of the hive. This indicates that the colony needs more room or more ventilation. Of course, after the honey flow has passed it is entirely normal for the bees to cluster on the outside of the hive during hot weather, but during the honey flow they should all be at work.

Some of the methods of swarm prevention when producing comb honey are hardly practical for the beginner. Therefore, if providing ample room, ventilation, shade and perhaps destroying queen-cells when first started do not prove effective, it may be found a help to remove a few frames of brood, either giving them to weak colonies or making of them nuclei that later may

opening of the honey flow when the extra hive-body is removed and the queen and brood placed in the lower story as previously mentioned, it is possible that the colonies may show no desire to swarm. But it may be that a colony will show a settled determination to swarm in spite of the best of care on the part of the beginner; for in comb-honey production the shallow supers with their sections, which are

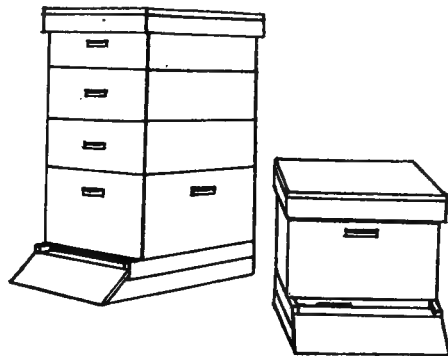

After the swarm has entered the new hive the entrance of the old hive is turned toward that of the new one.

be built up into full colonies. But in those few cases in which a colony still persists in building queen-cells it would perhaps be just as well to let them swarm and then hive them as described on pages 63-70.

When swarming occurs in the midst of the honey flow, the swarm should not be given a new location, for this divides the working force of the colony so that neither the swarm nor the parent colony is able to do much work in the supers. But when the swarm is hived in a new hive, placed on the



A day or two later the old hive is moved close to the new one, ready to be moved to a new location for increase on the seventh or eighth day after the swarm issued.

old stand as described on page 63, and the supers are transferred from the old hive to the new one, the newly hived swarm will have all of the field bees, so that work in the supers should continue without interruption. The parent colony being moved to one side loses its field bees because they enter the new hive on the old stand as they return from the fields. A week after the prime swarm issued, the parent colony is again moved to a new location, this time some distance away to prevent after-swarming, which again strengthens the new colony.

To Anticipate Swarming.

The beginner who must be away during the middle of the day, when the bees are most likely to swarm, should examine his colonies once a week to look for queen-cells. When queen-cells are found just recently started, containing only eggs or very small larvae, they should be destroyed and the colony left for another week. It is usually necessary to shake the bees from the combs when destroying such cells, in order to be sure none are missed. If cells containing larger larvae are found, it usually does no good to destroy them, for the colony would no doubt then go ahead with their preparations for swarming after having gone so far as to have queen-cells well advanced. In such cases, swarming can be anticipated by the following method:

Find the queen and put the comb on which she is found to one side, then shake the bees from most of the other combs into or in front of their hive. As the combs of brood are removed put frames containing either narrow strips of foundation, full sheets of foundation, or combs into the hive and replace the supers. If narrow strips of foundation are used it is necessary to place a queen-excluder between the brood-chamber and supers until the brood-nest is well established. When most of the shaken bees are in the hive, place the queen among them. Put all the combs of brood and the few bees remaining thereon into another hive placed close

beside the shaken colony. Enough bees should be left on the combs to care for the brood; usually two combs are not shaken at all, but placed in the other hive with all the adhering bees. This makes an artificial swarm, and the parent colony is handled exactly as in natural swarming as described on pages 63, 64, and illustrated on pages 87 and 88.

Taking Off the Honey.

In comb-honey production the beekeeper should not wait until the end of the honey flow before removing the completed sections, for, if the sections are left on very long after being completed, the surface of the cappings becomes soiled by reason of the bees passing over it so much. Although this does not affect the quality of the honey, it injures its appearance and so lessens its market value. In extracted-honey production, this condition makes no difference, since the cappings are removed and only the liquid honey sold. When a super is ready to be taken off, it should be placed above the other supers with a bee-escape board just under it. If an escape-board is put on when the bees are flying freely, they will probably leave the super in a few hours—at least by the next day. Usually it is not best to wait until every section is finished before taking off supers of comb honey. If a few are not yet finished, the super should be taken off and the unfinished sections sorted out, these being assembled in another super to be put back on the hive to be finished.

Where to Store Comb Honey.

Comb honey should be stored in a dry place; for, if water condenses on the comb and dilutes the honey, it is certain to sour. When extracted honey granulates no great harm is done, since it can easily be liquefied and is then practically as good as ever; but when comb honey granulates, it must be sold at a low price, and, therefore, it is important that comb honey be kept at an even temperature since sudden changes cause granulation. A warm dry room of even temperature between 70 and 90 degrees Fahrenheit is the best place for keeping comb honey.

Preparing for Market.

The exposed parts of the sections will have bits of wax and propolis adhering. These should be carefully scraped off with a sharp knife, taking extreme care that the comb be not accidentally gouged with the knife.

Those sections that are entirely sealed, nice and white and perfect in their appearance, should be sorted out and placed with the best grade. The unfinished sections may be used at home or disposed of at a lower price to near neighbors. If there are some sections with very little honey, and the beekeeper knows there is no foul brood among the bees of the neighborhood, he may stack them in supers a few rods from the apiary, leaving at the top and bottom of the pile a small entrance only large enough for one or two bees to pass at a time. In a short time the bees will rob out this honey, and the dry combs may then be stored to use as baits the next season.

INCREASE.

CHAPTER XV.

When swarming is kept down as much as possible, as advised in preceding chapters, usually there will not be much natural increase of colonies, especially when producing extracted honey. For this reason it is often desirable to make increase artificially instead of by the uncertain method of natural swarming. Beginners should be warned against making too much increase, for, except in the hands of an expert, if the number of colonies is more than doubled in one season, there is danger of losing many of the colonies later.

Our advice to beginners is, not to attempt an increase of their number of colonies before the main honey flow, as it usually results in a decided cutting down of the surplus-honey crop, unless in a locality where the main honey flow comes late in the season as in some parts of the buckwheat region and some portions of the South. This is because a colony of bees cannot give up a large part of its number to increase and remain strong enough to do the maximum of honey-gathering. Still, for those who wish to make increase regardless of the honey crop, we will mention briefly a safe and easy method that may be used before the cells are started and can be applied before, during or after the honey flow.

How to Divide Colonies.

As soon as settled warm weather comes, such that there can be no danger of chilling the brood, a strong colony, having not less than six or seven frames of brood, may be divided into two, giving five frames to each. When making this division two-thirds of the bees and all of the sealed and emerging brood may be placed in the hive on the new stand, the entrance best being closed with grass, and a ripe queen-cell or good laying queen introduced. The vacant space of each hive should be filled with foundation, or, better still, with drawn combs. On account of danger of chilling the brood, it is advisable not to give the five extra frames at one time, but only as fast as the bees can cover them. Any time there is thus left a space not filled with frames in the hive, this space should be separated from the frames covered by the bees by a division-board to conserve the heat. Both of the colonies may then be built up by slow stimulative feeding.

The reason that no sealed brood and so few bees are left at the old stand is because, when the bees from the new stand take their first flight, many will not realize that their hive has been moved, and will, therefore, return to the old location, so that the two colonies will soon be about evenly divided. Had much unsealed brood been moved to the new stand, there would have been danger that so many old bees would leave that the brood would become chilled; but, having only sealed brood, this danger is avoided, for young bees are constantly emerging to take the place of the old ones,

and these young bees will remain with the brood, it being the only home they have ever known.

The two colonies may, under favorable conditions and by careful management, be built up into good strong ones ready for the main honey crop, if in a location where it can be put into operation six or eight weeks before the opening of the honey flow. This can be done in some parts of the South and in the buckwheat region of New York and Pennsylvania, but not in those localities in northeastern United States where most of the honey crop is gathered from white and alsike clover.

Increase When Producing Extracted Honey.

One of the easiest and best ways of making increase when producing extracted honey is to use the plan given on page 75, that is, to leave in the brood-chamber the queen with only frames of drawn comb and one frame with young larvae; above this the queen-excluder, the supers and then at the top, a hive-body containing the frames of brood removed from the brood-chamber, tearing down all the capped queen-cells, and then at the end of eight days tearing down all but the one best queen-cell in this upper story and moving this upper story to a new location, placing it on a floor and covering with an inner and an outer cover. Now, if one cares more for the production of honey than for increase, he perhaps better not apply this plan until he finds capped queen-cells and the bees bent on swarming; but, if he wants increase, he may apply the plan as soon as queen-cells are started.

Increase When Producing Comb Honey.

When producing comb honey the greater tendency of the bees to swarm, usually results in about as much increase as it is safe for the beginner to make. When swarms, either natural or artificial, are handled as described on pages 87 and 88 there will be an increase of one colony for each colony that swarms naturally, or is swarmed artificially as described on page 88. When swarming occurs in the midst of a short honey flow, increase made in this way does not interfere with the production of honey, for the increase is made by moving away the hive containing the emerging brood, most of which would develop too late for the young bees to take part in gathering the honey crop.

ROBBING.

CHAPTER XVI.

Robbing is the act of the bees in stealing honey or other sweets not gathered by themselves, and is much easier to prevent than to stop after it gets started.

The beginner will do well to understand that robbing may be a serious matter in beekeeping, and while it may occur at any time during the beekeeping season, yet it is just before or just after the time of honey harvest that the beginner is most apt to bring it on by some oversight or carelessness of his own. The bees themselves will often start robbing by attacking a weak colony to secure its too feebly guarded stores—especially early in the season. A strong colony keeps an efficient guard of defenders at the entrance at all times, which guard is particularly alert at times when no honey is coming in.



Robbers do not attack a strong colony that keeps such an efficient guard as this at the hive entrance.

rush out to get some of the stolen sweets. In a short time, some weak colony is likely to be attacked, the bees fighting furiously until they reach such a condition that they will sting everything and everybody in sight, and perhaps keep at it for days. It is this sort of fracas that will cure any beginner of being so careless as to allow robbing to get started.

When Bees Are Most Likely to Rob.

When bees are very busily engaged in gathering nectar from the flowers, any quantity of honey might be left scattered all about the apiary,

and they would pay little or no attention to it. But it is this fact alone that so often gets the beginner into trouble, for he becomes careless during the honey flow, and then some day, when the honey is not coming in, a repetition of the former carelessness brings on double trouble. During a honey flow, when necessary to remove supers of honey, bees may even be shaken or brushed from the combs without attracting robbers in the least; but during a dearth of honey such work must be done very rapidly, the apiarist moving so quickly from hive to hive that the robbers can get no chance to pounce on any exposed honey. Robber bees will even attempt to steal honey from a comb being momentarily examined by the beekeeper, or even dodge into an open hive from the top.

During a honey dearth it is much pleasanter, for the beginner at least, to free the combs from bees by means of the bee-escape. But here again caution is necessary; for, if the cover does not fit bee-tight, robbing will be started in the shortest possible time, as the robber bees from other hives very quickly find the unguarded opening and have the honey all to themselves, since the bees of the hive being robbed are shut out from the super by the bee-escape board and so are unable to defend their stores. One should always be careful, therefore, in adjusting the bee-escape below the supers, to see that the cover above is not warped; it would be well not to remove the inner cover when slipping the escape-board under the supers, since the bees will have this cover tightly propolized to the top of the upper super.

It is the height of foolishness to suppose that bees will not find any opening, however small, if there is one. They will not notice it when they are getting plenty of honey in the fields, but will quickly find such an opening at other times.

Robbing When Extracting.

When extracting during a honey-dearth it is important to see that all windows are screened. The door of the room where the extracting is done should not be a screened door; otherwise, there will always be a cloud of bees flying about it, and some of them will get in every time it is opened. The window must be screened (better double-screened), but the door should be solid. It always makes trouble to spill honey on the floor, especially if the building stands on piers or stakes so that the bees can get underneath. The honey leaks through the floor, of course, and the bees find it shortly. This is why a room having a tight foundation is better to use when extracting.

Another possible cause of robbing after the extracting has been done is the nearly dry cappings. When these have drained so long that no more honey will run out they may be put in a solar wax-extractor (a shallow box having a glass lid, and lined with black sheet iron). The heat of the sun melts the cappings, and the liquid wax collects at the lower end in a suitable receptacle. Unless this box is tight the bees can get started on the honey that separates from the wax. Of course, it is necessary to protect all unmelted cappings from the bees. It is hardly safe to assume that no more honey will drain out, for slow dripping keeps up a long time.

The only use which the beekeeper can make of the robbing tendency of bees is in cleaning up his sticky combs after extracting. (See page 82.)

Even this should not be resorted to unless the beekeeper is certain there is no foul brood in any neighboring apiary.

Robbing Weak Colonies.

Weak colonies often invite robbing, especially if they are well provided with honey and if their entrances are large. This is particularly true of the spring season and of the colonies left weak by winter losses. Prevention in that case is also better than the cure. Weak colonies should have entrances no larger than are absolutely necessary, perhaps 1 or 2 inches long by $\frac{3}{8}$ inch in depth. Sometimes, however, if bees get to robbing a weak colony, that colony is placed temporarily in a dark cellar, and a hive having a small entrance and containing one comb with a little honey in it is put in its place in the apiary. When the bees have robbed out all of the honey in this one comb, thus making a thorough job of it, they will quietly disperse. On the other hand, if nothing were furnished for them to work on, they might, when thwarted in their desire to get the honey, go to other hives standing near, and the trouble be extended. If robbing has but just started, it can usually be controlled by contracting the entrance, and throwing a bunch of damp hay or grass over the front of the hive that is being robbed. Robber bees do not like to dodge through such an obstruction, for they can not make their "quick get-away." If the entrance is contracted in this way on a hot day, extra shade should be provided for the hive. If only one colony is doing the robbing, it sometimes pays to change places—putting the robbed colony in place of the one being robbed. The mental confusion that this remedy apparently creates in the robber bees is indeed amusing as well as effective in correcting their temporary lapse from moral conduct.

Where there is a general uproar in the apiary caused by robbing, contract the entrances to all weak colonies; see that there is no possible opening to exposed honey anywhere, then clear out, and let the bees alone.

Robbing Distinguished from Playfights.

Beginners often mistake young bees at play for robbers. Sometimes a large number will be seen flying busily around the front of the hive, usually early in the afternoon, so that there is a scene of great activity there, while other colonies are quiet. Closer investigation, however, shows the young bees merely at play. Under such circumstances there is an entire absence of any fighting. There is no sneaking nor darting around of the old, sleek, greasy-looking robber bees, nor is there heard the high, alarming keynote of excited bees peculiar to a robbing foray. There is only a happy circling about the front of the hive as the young bees first joyfully try their wings and mark the location of the hive.

AFTER HARVEST WORK.

CHAPTER XVII.

There is no certain limit to the period of the honey-harvest season anywhere, and in many places one honey flow succeeds another throughout a very long season. Much depends on locality, weather and seasonal changes, and some kinds of honey flows are always uncertain. Yet everywhere in the United States, before the regular cold or cool season of the year, there comes an end to the bees' activities and there follows a winter's rest—shorter or longer. This is when honey from all sources has ceased to yield, and the surplus has been removed from the hive.

It will be a wise beginner, who, from his own observations of the plants of his locality, early learns what honey flows may be regularly expected, and what irregular and late honey flows may occur, and learns, too, the certain signs that tell when these honey flows are probable and about to begin. Lacking personal experience and observations of these matters, he will do well to seek this information from those who do know—if possible, from some neighboring beekeeper. Having this important knowledge, he will be prepared to plan best not only for the honey harvest but also for its close and the after-harvest work.

The beginner should understand that all like honey flows require similar manipulation of the bees and hives, but that all honey is not equally desirable, and so it is often best to take off one honey crop before it can be mixed with another. (See page 78.) Also, some honeys are not fit for winter stores, if bees are confined to their hives without flight for a month or more at a time. (See page 99.) This is often true of late honey flows in the northern part of the country—for instance, aster honey.

A Time of Light Work.

The days or weeks between the close of the bees' active work and the time for putting them in their winter quarters may be considered the vacation season of the beekeeper. There is little more to do than to observe the condition of the colonies and be sure that they are normal and all right.

If there are weak colonies that are not likely to build up and be strong enough to winter well, these weak colonies should now be united. (See page 114, "Newspaper Uniting Plan.") A colony that is certainly too weak to winter well is one that has bees covering less than three or four frames and whose brood-rearing is at a standstill. The beginner better not attempt to winter any colony that has less than six combs of bees.

Introducing Queens in Early Fall.

While the beginner takes greater risk of losing queens when introducing them after the harvest than when doing so during the honey flow, yet

it may be desirable to introduce a new queen in the fall. The value of a young, vigorous queen in a colony to build it up strong for winter and to begin brood-rearing promptly the next spring can hardly be overestimated. It is best, however, to introduce the young queen in time for her to have about six weeks to lay eggs for winter bees. This means that the young queen should begin to lay not later than the middle of August in the North and the first of September in the South.

Queens that are not laying well or that are not giving satisfaction for any reason, whose bees may be poor honey-gatherers or show other undesirable traits, should be replaced by queens purchased from some reliable breeder, the old queen not being removed until the arrival of the new one. (See page 59.)

Finding no queen, eggs, nor young larvae, and still enough room for the queen to lay, is not certain proof that the queen is missing. (See page 57.) It may be that the old queen has stopped laying for a time or has been lost, and the young one not yet mated. A frame of eggs and young larvae should, therefore, be given to such a colony. If the colony be queenless, queen-cells will soon be started. (See page 57.) If a young queen that has not begun laying is present, the giving of larvae keeps the bees contented and may perhaps cause the queen to start laying, since the workers begin to feed her a greater quantity of food, just as they ordinarily do a laying queen.

If one finds a colony with mostly drone brood or with the eggs placed irregularly, he may conclude that such colony has either a drone-layer or laying workers. (For directions in such cases, see page 58.)

Requeening.

Until the beginner is experienced enough to rear his own queens, he should purchase them from some reliable breeder. The queens he purchases should always be mated and laying, and may be "untested" or "tested." An "untested" queen is one which is known to the breeder to be laying well and sold without any other guarantee. A "tested" queen is one that the breeder has kept long enough to determine from her progeny that she has been purely mated.

Care of Combs.

After the honey harvest, the beginner needs to be emphatically cautioned as to the care of his empty combs. If he does not take the best of care to store these carefully, they are almost sure to be attacked by mice or by wax moths or by both, and so ruined. The best way to take care of these combs during the summer is to leave them on the hives where the bees can care for them. One strong colony can take care of four or five or even more supers of extracting-combs until the arrival of cold weather, after which the moth can do no damage. The empty drawn combs and the frames of full sheets of foundation, that the beginner may have at the close of the season, should be placed in good supers, and these supers stacked up in a dry, rain-proof place so that there is no crack nor crevice through which a wax moth or mouse can enter. Careful piling of all the supers, the bottom one being placed on a perfectly flat surface and the

AFTER HARVEST WORK.—Chapter XVII.

top one carefully covered, will insure safety against the entrance of mice and moths; but, if there are already eggs of the moth miller in the combs, they will hatch and the combs become infested with wax worms in spite of covering carefully. So there should be an inspection of the combs at least once after they have been piled, for, despite the best of care, some moth larvae may get in. If at any time it is found that moths are ruining the combs, see page 121 of the Appendix for treatment, and apply this treatment at once.

WINTERING.

CHAPTER XVIII.

Wintering is one of the most serious problems of the beekeeper. Due to poor wintering methods or lack of any wintering methods, the great winter losses of bees the country over are at least ten times greater than necessary, running into millions of dollars of loss annually.

Good Wintering Requirements.

To insure good wintering, no matter how or where the bees are wintered, there should be large colonies with plenty of young bees and a good queen, and there should also be an abundance of good, wholesome stores. In those localities where there is a continuous honey flow until fall there will be plenty of young bees reared for winter; but wherever there is a dearth of nectar just before fall, it is quite important that the colonies be provided with young, prolific queens in order that breeding may be continued in the fall and thus provide a large number of young bees for winter. These young bees may be considered a good insurance against spring dwindling, which takes place when worn-out bees of the previous fall die in the early spring before the young ones emerge to take their places. Besides these general requirements, other special ones will be mentioned in connection with different ways of wintering.

Time of Fall Feeding.

Those colonies which do not have enough stores (see the following paragraph) will need a feeding of good sugar syrup. This should not be given until brood-rearing has nearly ceased and most of the brood emerged so there will be plenty of room for storing, and, yet, it is always an advantage to give the stores as early as the condition of brood-rearing will permit in order that the cells may be well sealed. When first placed in the cells the stores (either honey or syrup) are too thin for good wintering; but, if there is time before wintering, the bees evaporate, or "ripen" the stores until of the right consistency, when they are sealed. Stores too thin, or in any way poor, often cause dysentery and death of the colony before spring. (See "Dysentery," page 118 in Appendix.) For, when bees use poor honey, it results in more waste matter accumulating in the intestines, which during very cold weather is retained, since bees normally void their feces only in flight. Therefore, if unable to fly for some time, death may result.

Needed Amount of Stores.

The amount of stores needed will, of course, depend upon the size of the colony; but, in general, those colonies wintered in the North will need

about 20 to 30 pounds of stores if wintered in the cellar and 30 to 40 pounds if wintered outdoors, while those in the South, because of their greater activity during the winter, should have 40 or 50 pounds or even more.

When examined to determine the amount of stores it is probable that quite a little honey will be found in the brood-chamber. Each full standard-sized Hoffman comb contains about five pounds of honey, so that by handling each comb and noting the sealed honey it will be easy to arrive at a general estimate of the amount of honey in each hive, and therefore the amount that will need to be fed. The unsealed honey should not be estimated, since it is generally used before winter. A better way is to weigh the hive; then deduct the weight of an empty hive and combs, allowing five or six pounds in addition for the bees and pollen. Each hive should be marked with the amount to be given. If one intends wintering in a double-walled hive, the 30 to 40 pounds of stores should be contained in seven or eight frames so that, if desired, the brood-chamber may be contracted as described later.

Poor Stores—What to Do.

There is considerable difference in the wintering value of honeys, some of them having too large a per cent of resins and gums to be a good winter food, and others being unsuitable because insufficiently ripened. As already stated, if bees have frequent flights, such food is safe; but during the dead of winter it is apt to result disastrously; so that, to be on the safe side, each colony having honey of poor quality should be given as much as ten pounds of sugar syrup to store below their honey. The colonies will probably not use more than ten pounds during the most severe weather, and so the syrup being fed last will be used first, and the bees will not get to the undesirable honey until spring, when they will be able to have frequent cleansing flights, and thus avoid dysentery.

A thick syrup made from either cane sugar or beet sugar makes very good winter stores. It should be made of not less than two parts of sugar to one part of water. In fact, some prefer such syrup to the best honey stores. But the beginner will do well to use the bees' natural food, which is ripe honey of good quality. White clover, alsike clover and alfalfa honey are among the best for winter. Aster, goldenrod and swamp-flower honey are not so safe as clover honey or sugar syrup for winter; but, if thoroughly ripened, they do very well if the winter is not severe. If unripe, as fall honeys often are, they are likely to cause dysentery before spring. Glucose, if taken by the bees, would be almost certain to kill them before spring, and it is not suitable for feeding the bees at any time. In fact, it is almost impossible to induce bees to take raw glucose. Such poor stores as honeydew, grape sugar, brown sugar and molasses should not be used for winter, but should be saved for spring feeding, for these sweets will be perfectly safe for feeding as soon as the bees are able to have frequent cleansing flights.

Just Before Feeding.

While making the estimate on the needed amount of stores, there will probably be no honey coming in, and therefore care should be taken not to

start robbing. If any colonies are weak, their entrances should be contracted; and, if the hives are open for any length of time, it may be necessary to use a robber tent, for it would certainly be very bad for the colonies to become unduly stirred up at this time of the year when they should be quiet.

In case one intends to winter in double-walled hives, he should at this time do the work of contracting the brood-chamber by removing two or three frames (see page 102 on "Wintering in Double-Walled Hives"). If weak or queenless colonies are found they should be united with others; or the queenless one, if strong, may be given a good queen by the cage method. (See page 60.) Crooked combs or those having too large a per cent of drone comb or too much beebread should be removed; or, if there chance to be some brood in them, they may be placed at the side of the hive, to be removed later at the time of packing when the brood will have emerged.

Whenever there is a chance for a choice in the matter, old dark combs should be left at the center of the hive for the bees to cluster on, since the cocoons in the cells make such comb much warmer than new light combs. During cold weather the bees are in a compact spherical mass, at the center of the hive, the combs dividing the mass. This part of the combs which they occupy is called the winter nest. When examining the colonies in the fall the winter nest should not be disarranged, since the bees have arranged their winter stores around the winter nest as needed for winter.

Method of Feeding.

The friction-top pail offers a very easy method of feeding. The lid is pierced full of holes made with three-penny nails or in some cases by machinery. In case one lacks a friction-top pail, a Mason fruit jar with pierced lid or with cheese-cloth tied over the top will do very nicely, although it will need repeated filling until the required amount is given. These feeders are filled with syrup made of two parts of sugar to one of water, heated or boiled till all grain has disappeared. The syrup may be used even thicker than this, late in the season; for late in the fall the bees become rather sluggish and if given syrup too thin may not evaporate it sufficiently. In cold weather the syrup should be thick and warm when fed.

When the syrup is ready to be fed, an empty deep super should be placed over the brood-chamber, the pail of warm syrup inverted directly over the tops of the frames, and the pail and the top of the brood-chamber warmly covered with a piece of canvas or burlap to retain the heat so that the syrup will be taken readily by the bees. The inside and the outside

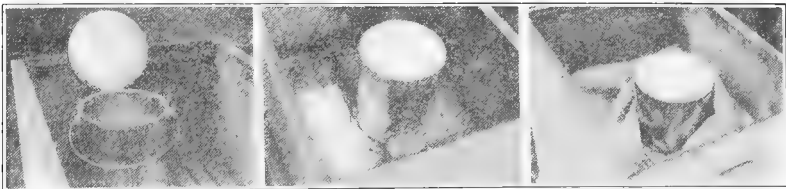

At the left, a friction-top pail with its cover pierced with holes; at the center, pail filled with syrup and inverted over tops of frames; at right, pail and top of brood-chamber warmly covered both to keep the syrup warm and to conserve colony's warmth.

covers should, of course, be placed over the super. Strong colonies will sometimes take the contents of one of these ten-pound pails in a day. If a colony is unusually slow in taking the syrup, the process may be hurried by rewarming the syrup.

Various Ways of Wintering.

In the North bees may be wintered in the cellar or outdoors. In localities where the average winter temperature is below 25 degrees F., and where snow continuously covers the ground for several months, beekeepers who have good stores and dry, well-ventilated cellars that may be made dark and left at an even temperature somewhere between 45 and 50 degrees F., may winter inside to advantage. Those wintering outdoors in the North will need either double-walled hives or else suitable packing-cases for their single-walled hives. And even in the southern states some packing is a decided advantage, leaving the colonies in a much stronger condition in the spring. This lighter protection may be in the form of light packing-cases, but even wrappings of paper will be quite worth while. Any protection against wind is a help.

Wintering Outdoors.

In cold climates it is necessary that colonies wintered outdoors have plenty of packing in order to retain the heat; for, when the temperature inside the hive falls below 57 degrees F., the bees are obliged to generate heat by their own activity, which activity compels the use of a greater amount of stores and also an accumulation of feces within the bees. This often brings about dysentery and death, especially when the stores are not of the best quality. Even in those cases in which dysentery does not result, the individual bees of the colony are so worn out by their efforts



This apiary is well protected on the north and west by a natural windbreak of trees.

to keep up the temperature of the hive that in the spring these old bees die more rapidly than they can be replaced by the young emerging bees, and thus the condition called "spring dwindling" gradually diminishes the colony, often rendering it worthless.

Necessity of Windbreaks.

When preparing for winter a good natural windbreak 10 to 15 feet high should without fail be on the most exposed sides of the apiary



This apiary is protected on the north and west by a high fence built for this purpose, having spaces left between the boards.

ward, striking the hives a short distance from the fence, but when there are large cracks in the fence the wind sifts through and its force is sufficiently broken.

(usually north and west), which may be either shrubbery, trees or a hill. In the absence of these a 6 to 8 foot fence would be satisfactory if the boards are spaced an inch or two apart. An ordinary tight board fence causes the wind to glance upward and then swoop down-

Wintering in Double-Walled Hives.

Among the different ways of wintering outdoors, the beginner will find the double-walled hive the easiest and most satisfactory if he takes the precaution to contract his brood-chamber by removing two or three frames (the number depending upon the size of the colony), crowding over the combs to the side of the hive least exposed to the prevailing winter wind, and at the side of the frames placing a tight-fitting division-board and then filling the space left vacant, by the removal of the frames, with chaff or tightly packed dry forest leaves or soft planer shavings. If the colony has not enough stores for winter it should next be fed enough to make up the required amount. (See page 98 on "Needed Amount of Stores.")

It will be noticed that at the center of the two or three middle combs there is a little circle of empty cells which constitutes the winter nest, or place where the bees cluster. When the bees are clustering in and over these empty cells the colony has more or less the form of a sphere or a ball, but divided by the several combs extending through the ball. This ball is much warmer and more compact



Double-walled hive, with brood-chamber contracted and vacated space packed with leaves, to give added protection to the bees.

than could possibly be the case if cold slabs of honey intervened between the parts of the cluster, instead of the thin cell walls and midrib of the comb. The ball-like cluster of bees gradually eats its way upward and backward as the winter advances. When making the contraction this winter nest should not be disturbed nor the relative position of these central combs changed.

Although this is a very safe way of wintering, it necessitates opening the hives in the spring to give more room and possibly more stores before the honey flow. Therefore, if there is any chance that the colonies may be neglected during the spring, it would be better not to contract the brood-chamber, but to leave it with its ten frames.

The tops of the frames may well be covered with a mat of very heavy cloth or carpet (especially in the North), cut to the size of the inner cover or slightly larger. Be sure to have this mat of material as heavy as the heaviest canvas, and it may be well to cover it with newspaper to prevent an upward draft. The object of this porous top covering is to permit slow absorption of moisture without creating an upward draft that would carry away the heat. This mat should be held up from the frames by a few small sticks placed crosswise of the frames in order to provide the bees with passageways from one frame to another. (If the hive were sufficiently packed and protected to prevent all condensation within, upward ventilation would not be necessary, and a sealed cover could be used.)



Placing the tray of well-packed forest leaves on top of the inner covering of the hive.



Placing the outside telescoping cover over the protecting tray of the double-walled hive.

A tray four or five inches deep, slightly smaller than the telescope cover and filled with well-packed forest leaves or planer shavings, should be placed above the mat at the top of the hive to retain the heat of the colony. The burlap attached to the bottom of the tray should be left baggy, and secured to the sides of the tray by wooden strips nailed on the lower inside edges. This allows the tray to fit tight to the top of the hive, and prevents the wind from blowing under the tray.

The outside telescoping cover is placed directly over the tray.

The hive should be left facing away from the prevailing winds,



A shipping crate or box can be made into a serviceable winter packing-case for a single hive.

winter, and until May in the northern states, the best care one can give his bees is to leave them quite undisturbed, only taking heed that the entrances do not get clogged tight-shut with ice during winter sleet storms. A covering of snow over the hive entrance, however, does no harm.

Wintering in Packing-Cases.

Those who may have their colonies in single-walled hives and wish to winter outdoors will need to provide good packing-cases.

The single-walled hive entire is placed in its packing-case, which may be a common shipping crate or box of dimensions such that about six inches of packing of leaves or shavings may be placed around the tops, sides and bottoms of the hives. A passageway the width of the hive and two inches deep is provided from the hive entrance through the packing to the entrance of the packing-case, this outer entrance being contracted to an opening $\frac{3}{8}$ by two or three inches. This passageway through the packing is provided both for ventilation and also to give the bees a chance to leave the hive and take a cleansing flight on warm days that may occasionally occur. For a cover to such a packing-case, tin, tarred paper, a tight wood-

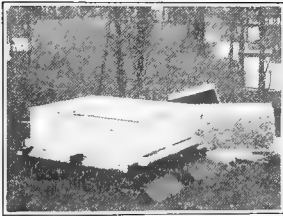

Hives in place on floor of quadruple packing-case.

en cover, or other waterproof cover should be used in order that the packing may keep perfectly dry.

These cases are usually made of such a size as to accommodate from one to four colonies.

The quadruple packing-case is strongly advocated by bee authorities of the United States Department of Agriculture. Farmers' Bulletin No. 1012

with an entrance $\frac{3}{8}$ inch by two or three inches. No matter how cold, the entrance should never be closed, as ventilation is needed as well as occasional cleansing flights when the weather will permit.

The hive-stands for these double-walled hives should have a firm foundation closed up all around to prevent wind from blowing beneath them, and given a slightly forward tilt so that the inside of the hives may keep dry. During



Floor plan of quadruple wintering case.



Putting on the sides of the quadruple packing-case.

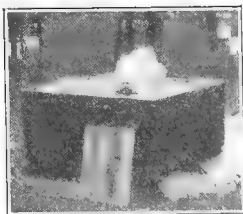

The four hives securely packed in the quadruple case with planer shavings.

gives details of how to build and use it.

When several colonies are to occupy the same case they should be moved gradually each day until the spot where the packing-case is to be located is reach-

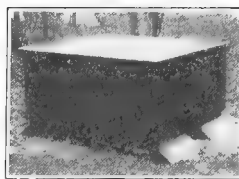

The quadruple case with cover on ready for winter.

ed. Otherwise, many bees will go back to their old locations and be lost. Many avoid all danger of such loss by keeping the colonies during the summer on the same stands and in the same relative positions they will occupy during the winter. The packing-cases should be put on early in the fall and left until late in spring or until warm weather, so that all chilling of brood may be avoided.

Wintering with Tarred Paper Tied On.

The first cost of winter cases need not stand in the way of good wintering, for bees can be well protected for only a few cents per colony for cost of material, by using a cheap grade of tarred paper to hold the packing in place and keep it dry.

To pack a single colony in a regular 10-frame hive, cut two pieces $\frac{7}{8} \times 2 \times 20\frac{1}{4}$ inches, two pieces $\frac{7}{8} \times 2 \times 24$ inches, two pieces lath 20 inches long and two pieces 24 inches long. From a roll of 36-inch single ply slaters' felt, cut one piece 8 feet long and another $3\frac{1}{2}$ feet long.

Make a rim of the 2-inch pieces which fits around the lower part of the hive, by lapping over the corners and fastening with a single nail. The piece in front should rest on the side rails of the floor, leaving the entrance open. The two side pieces should come below the end piece in front, and above the end piece at the back, thus dropping the rim $\frac{7}{8}$ inch lower on the sides than in front, and $\frac{7}{8}$ inch lower at the back than on the sides. A small nail driven part way into the back end of the floor supports the rim at the back.

Stand the 8-foot strip of paper on edge around the hive and tack on the lath to fasten the paper to the rim, using two nails in each lath driven only part way home. The paper should touch the ground all around the hive, the entrance now being covered with the paper. Cut a hole $\frac{3}{8} \times 2$ inches through the paper for an entrance. This hole can easily be enlarged next spring when a larger entrance will be needed. Where the ends

overlap, pin the paper together with two or three wire nails.

The packing material should be packed down in the corners to make them stand out square, after which the packing is simply poured in at the sides and ends without pressing down. This

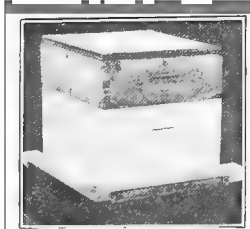

Two-inch rim in place about bottom of hive.

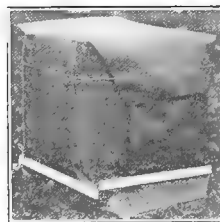

Cords are used to hold the cover in place.

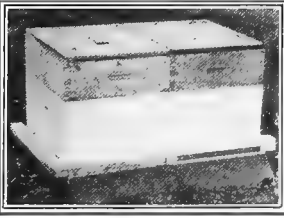

Rim in place for packing hives in pairs.

is to prevent bulging out the sides. From three to six inches of packing can be put in at the sides and ends by permitting a slight bulging of the paper beyond the rim at the bottom, or a greater amount can be put in if some slack is left in the paper at the lower corners when the lath are nailed on. Fill in with 8 to 10 inches on top, then fold down the upper edges of the paper as in wrapping a package.

Crease the 4-foot piece of paper, which is to be used for the cover, by folding over the edges before putting it in place. After it is in place fold the corners neatly, as in wrapping a package; then tie a cord around the folded-down edges to hold them snug against the sides. Tie a cord to one of the projecting nails in one of the side lath, pass it across the top of the hive under both nails on the opposite side, then back to the other nail on the first side, where it is fastened.

Hives can be packed in pairs with but little more material and labor for the two than for a single hive. For two colonies the 2-inch pieces for the front and back of the rim should be $36\frac{1}{2}$ inches long, and the lath for the front and back should be 36 inches long. The paper to form the sides should be cut about $10\frac{1}{2}$ feet long, and for the cover about $4\frac{1}{2}$ feet long.

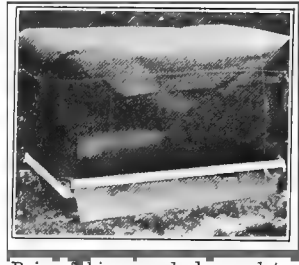

Pair of hives packed complete.

Wintering in Cellar.

If one lives where the average winter temperature is below 25 degrees F. and if he has good stores and a good, well-ventilated cellar that can be kept quiet and completely dark and at an even temperature between 45 and 50 degrees, he can probably winter safely in the cellar, and



Wintering bees in a cellar.

this is what he should do in case he has single-walled hives. Cellars suitable for keeping vegetables are usually quite satisfactory for wintering bees. A cellar whose temperature varies markedly with outside temperatures is unfit for cellar wintering. Oftentimes colonies short of stores or too weak to winter outdoors will winter safely in a good cellar.

Ten cubic feet of space is sufficient for each colony. The entrance blocks should be removed, and, if any mice are in the cellar, the entrances should be covered with a coarse $\frac{1}{4}$ -inch mesh screen. This will allow the bees to pass through, but will shut out the mice. In cellars where the temperature remains as low as 45 degrees, the entrances may be reduced to openings $\frac{3}{8}$ by two inches, stronger colonies being given larger entrances. If the bees become uneasy during the winter, it is likely that the temperature or ventilation of the cellar needs regulation. Bees should be put in the cellar immediately after (what is probably) the last good flight—usually in November in the northern part of the United States—and taken out the latter part of March or the first of April, at a time when the first natural pollen may be gathered, when it is warm enough so that they may have frequent flights. If put out when the weather is still rather cool, some protection, such as tarred paper wrapping, should be given the colonies. See pages 105 and 106.

SPRING MANAGEMENT.

CHAPTER XIX.

The beginner may wonder why the chapter on spring management is to be found at the end of this beginner's book. Spring seems the natural time to begin things in general, including beekeeping. But if the beginner will recall our advice to him as to when to begin he will remember that this time was set at fruit-bloom time, if possible—"after the early spring managing problems are past," and that we also advised him to buy full colonies with sufficient stores to last the bees until the main honey flow. So it was for a later time in the season that these beginner's instructions were begun, and there remains the important work of early spring management to complete the cycle of the year.

It is to be constantly kept in mind that both winter and spring management aim at the all-important object of having the colonies very strong in bees at the beginning of the honey flow—the secret of success in securing a honey crop.

The spring management of bees is often more difficult than the wintering of them. This is largely because of the sudden weather changes of the spring season. A sudden change from warm to cold, or, rather, a week of warm weather followed by severe cold, is very hard on both bees and brood, and not seldom, in the north temperate zone, the spring losses exceed those of the winter, though such losses are usually the result of poor wintering.

Before discussing the actual work of spring management, it is well to caution the beginner against needless "tinkering" with the bees, as more harm than good is often done by too much "attention" being paid them. They should receive necessary care—but no more, and some seasons they will need much more attention and manipulation in the springtime than in other seasons.

Taking from the Bees Their Winter Protection.

The manner in which the bees have been wintered and given protection against the winter's cold will determine one of the first spring problems of the beginner, namely, when is the safe time and what is the safe way to lay aside this protection?

If the bees are in double-walled hives, as this book has advised for beginners, they are at all times out in the open on their permanent locations, having only a mat, chaff-tray and deep telescoping cover above the brood-chamber to serve in addition to the double walls of the hive for winter protection. In case the brood-chamber was contracted the fall before by removing several frames and this space filled with dry leaves or shavings, these should be removed as soon as the colony needs more stores or the queen needs more laying room. The special top protection should

be left on the hives till settled warm weather has arrived. There is more danger of removing it too early than too late, for in most parts of the country (excepting the far South) "cold spells" and chilly nights are experienced even after the season of fruit bloom, and this temporary cold, if the winter protection has been removed, may chill and kill some brood, thus weakening the colony. If there comes an unseasonably warm "spell" in the spring—really hot—the entrance of *strong* colonies may be opened to summer size. This should not be done, however, if the nights are cool enough to chill the brood. The winter protection and the contracted entrances are not to be dispensed with until the time of settled warm weather. Many beekeepers make it a practice to leave the chaff tray on the double-walled hive all summer to protect the supers from undue heat or chill.

If, perchance, the beginner has secured his first bees in single-walled hives and so has had to put them in some sort of winter cases, with a packing of leaves or shavings or chaff about the hives inside these cases, he should not set the bees out of these winter cases till just before the honey flow or until it is necessary to give more room. If the colonies went into winter quarters strong and with plenty of good stores, he need not even examine them until he unpacks them. But if the colonies were of doubtful strength in the fall or had a doubtful amount or doubtful quality of food stores when going into winter quarters in the fall, the beginner will need to examine them during the first warm weather of the spring. In doing this, he should remove the packing only temporarily and replace it when he has given the bees what attention is needed—generally a feeding of sugar candy or sealed combs of honey.

If the bees be wintered in the cellar, the rule is to wait until the first natural pollen is abundant before setting them out from their winter quarters. If the bees become quite uneasy in the cellar it will be necessary to set them out early; but, as a general thing, there is more danger of setting them out too early than too late—both because of the cold and the lack of pollen and nectar supplies. Usually the best time for putting the bees out is the latter part of March or the first of April in the North where cellar wintering is practiced. But when a pollen supply seems assured and the season of prolonged cool spells is past, wait for a warm, sunshiny day, and then, within this one day, remove all the bees from the cellar and place them on their permanent summer stands. When the bees are first removed there will be little or no brood in the hive and therefore the cold will do no injury to the colony; but, after they have been out long enough to have considerable brood, a cold spell may prove very serious and much of the brood be chilled. This trouble may be avoided by paper-packing the hive, as described on page 105. This packing costs but little and can easily be adjusted in a few minutes. When one considers the saving in bees and brood, he will realize that he cannot afford to dispense with this protection when setting his bees out of the cellar.

Regulation of the Entrances.

A first inspection of the colonies in the spring will serve to discover any colonies that may be dead and those that are weak.

If any are found that are dead, at once close tight the entrances.



This is a weak colony as shown by the few bees on the frame that the beekeeper is examining.

Otherwise, on the first warm day that the bees of the live colonies may be flying and seeking nectar, they will enter the hives of the dead colonies and begin robbing out any honey that may be found in the combs there. An uproar in the whole apiary will result; and not only will the hives of the dead colonies be robbed, but quite likely the weaker colonies of the apiary will also be set upon by the robbery-mad bees of the strong colonies, and, unless prevented, will entirely destroy them. Such robbing, if permitted, is one of the surest ways of spreading any foul brood that may be lurking in one's own apiary or in that of a neighboring apiary.

Besides closing the entrances of the hives of the dead colonies, if there be such, contract the entrances of the weak colonies. This is done to protect them against possible robbing of their stores by the bees of stronger colonies. How much shall the entrances be contracted? If the colony has been reduced in strength to two or three frames of bees, contract to $\frac{3}{4} \times \frac{3}{8}$ of an inch, so long as danger of robbing continues. But just as soon as the bees begin gathering pollen or nectar, and warm weather prevails, the danger of robbing will pass, and the entrance may be enlarged to suit the needs of the bees.

When the Hive May Be Safely Opened.

The hives should not be opened except during a warm day (not less than 60 degrees Fahrenheit) when the bees can fly. If opened on a chilly day, not only will the bees be found to be cross, but there will be danger of chilling the brood and perhaps getting the queen balled. The middle of the day (when warmest) should be selected as the time for looking into the hive.

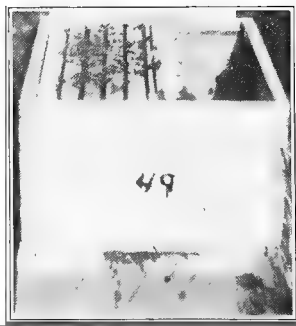

Here is another weak colony. The entrance of whose hive should be contracted in the early spring.

Cleaning the Hives.

The entrances of all live colonies should be cleared of dead bees (if, unfortunately, there be such) by means of a wire hook. This wire should be long enough to reach clear under the frames, so that all the dead bees on the floor of the hive may be raked out. Later, when settled warm weather prevails, and the bees are flying freely, it may be well to open the hives of any weak colonies, take out all the frames and thoroughly clean the hive of dead bees, taking care to do this on a warm day when the brood will not be chilled. This will not be necessary in the case of strong colonies, because the bees themselves of such strong colonies carry out all the dead. In case an excess of propolis be found on the frames, it should be scraped off. In warm regions this cleaning of the hive needs to be repeated frequently. This cleaning, or so-called "overhauling the hive," makes it easier to handle the frames and to control the wax moth.

If Dysentery Be Present.

The earliest examination of the colonies may reveal the presence of dysentery. The signs are numerous dark-brown or black spots spattered about the entrance. The cause of dysentery is generally a poor food supply, such as honeydew, combined with long, unbroken confinement to the hive by severe cold weather. About the only remedy is settled warm weather, permitting the bees to fly freely; but it is well to contract the brood-nest to as few frames as will accommodate the cluster.

Stores Necessary in Spring.

One of the most important objects in opening the hive in the spring is to ascertain whether there are sufficient stores to carry the bees through to the time when they can gather their own food (pollen and nectar) in the fields. The bees should always have an abundance of food of good quality. By an abundance is meant at least two or three frames of good sealed honey in the hive all the time. Enough of good honey, of course, should have been left in the hive the fall before to carry the bees through the spring. But, for one reason or another, colonies often go into winter quarters short of stores, and the result is danger of starving if not given food in the spring before the bees can begin gathering nectar.

An abundance of stores for the excessive brood-rearing of spring is one of the most important factors in securing a honey crop; for, if the stores fall short, the bees will at once reduce brood-rearing, thus preventing the colony from developing to full strength by the time of the main honey flow.

Giving Sealed Stores.

Suppose, upon opening the hive in the spring, the colony is found to be short of stores. Then sugar syrup or bee candy must be supplied the bees, if there are no frames of sealed honey that can be given. Many good

beekeepers lay aside plenty of nice combs of honey for just this purpose of spring feeding. Lacking such stores, there may possibly be a colony that has been winter-killed, from which one or more combs of stores can be taken. But if no honey in the comb is available, sugar feed has to be resorted to. The colony should be kept supplied with plenty of stores up to the time the honey flow starts. During spring-breeding great quantities of stores are needed. Full colonies sometimes use more than ten pounds of stores a week. It is the stores in excess of their actual needs that stimulate the bees to increased brood-rearing.

Feeding Candy, Not Syrup, in Early Spring.

Feeding of sugar syrup in the spring, before the bees begin to fly freely at least every few days, is always attended with more or less danger, for syrup feeding at any time starts the bees to flying out at the entrance. Then, if the weather chances to be cold (or chilly), many bees are lost by becoming chilled in their flight and never return to their hive. Hard candy made of pure granulated sugar is the proper makeshift food to supply the shortage of natural honey stores, during cold weather of early spring. When the weather turns warmer, syrup feeding is preferable. (See page 100.) This hard candy can be purchased (ordinarily) of beekeeper-supply houses; or, if one prefers, he can make it himself by using considerable care. The recipe for making it is as follows:

Into a dish of hot water on a stove put one-third of a teaspoonful of tartaric acid for every $2\frac{1}{2}$ pounds of water and then into the mixture slowly pour granulated sugar to the amount of four times the weight of the water, stirring constantly. Make sure that the sugar is all dissolved before boiling commences. If this precaution is not observed, some of the undissolved sugar is likely to burn, injuring the flavor of the candy and almost surely causing trouble with the bees later. If one has a candy thermometer, he should watch the temperature and not let it go above 275 to 280 degrees. Test frequently by dropping a very little of the syrup into cold water (about 50 to 55 degrees F.). The drop of candy when taken out of the water should be hard and brittle, but when placed in the mouth should soften slightly so that it is tough. Then the syrup should be poured into paper pie-plates, or upon paraffined or wax paper on a perfectly level table. In the latter case, around the outside of the paper should be placed wooden sticks $\frac{1}{4}$ inch high to prevent the syrup from running off. The color of the candy when cold should be about that of light basswood honey. If it is darkened very much, it is scorched and unfit for the bees. To prevent the scorching, reduce the fire toward the last so that the syrup will boil slowly.

This hard candy (in paper pie-plates) should be placed over the cluster of bees, with a few small sticks between it and the tops of the frames to give bee-space. If the colony is small the brood-chamber should first be contracted, by the use of a division-board, to as few frames as the bees will cover at one side of the hive. In doing this the contraction is accomplished by removing frames that have no brood and little or no honey. Place the candy above the cluster—the pie-plates upside down. In case the beginner has wintered in a double-walled hive with a mat just above the frames, as



Hard candy fed to the bees in a paper pie-plate inverted above the cluster.

we recommended, he may feed the candy immediately under the mat; but if he has wintered in some other way and has no room for the candy between the tops of the frames and the cover, it will be necessary to put on a two-inch rim or an empty shallow super (or a full-depth super if he hasn't a rim or shallow super) to provide room for the candy on top of the frames. If it is a time when cool weather may yet occur (any time before the main honey flow in the northern regions of the United States), cover the candy and fill the space of the added rim or super with mats, cloths or other packing, to conserve the warmth of the hive. When in exceptional cases it is necessary to feed candy after the supers are on, just preceding the honey flow, the feed may be placed on the floor at the back of the hive. To do this, raise the front of the hive and shove the candy to the back of the floor beneath the frames.

The one only best way of feeding, however, is to provide sufficient stores in the fall, thus making early spring feeding at least unnecessary.

In some locations where there is no early pollen available, as in some parts of the arid region, beekeepers purchase or save combs of pollen for use the following spring. The use of pollen substitutes is of questionable value.

Need of Water.

Whenever brood is being reared it is necessary for the bees to have water. This they can sometimes secure from thin nectar that is being gathered at the time. But lacking a natural water source, it should be supplied at some warm, sheltered spot in or close to the apiary. In providing such water supply care must be taken that the bees do not drown in getting the water. Any open dish or pail may be used to hold the water, provided that plenty of floating material, such as bits of board or sticks or straw on which the bees may alight, be placed on the surface.

Uniting.

The putting together of two or three colonies or nuclei of bees to make a single colony is called "uniting." The beginner must understand that, except during a good honey flow in spring, sum-

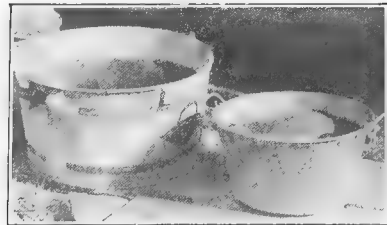

Vessels of water for the bees, with floating material on which the bees may alight while drinking.

mer or fall, if two colonies, each having its own queen, are united without any measures taken to make the uniting gradual and peaceable, the bees of the two colonies are likely to fight each other desperately.

The Newspaper Uniting Plan.

It may be that a colony is found in the spring without a queen, when no new queen can be secured to introduce to it. In such a case, the newspaper uniting plan (as first practiced by that famous bee master, Dr. C. C. Miller) is to be strongly recommended. It is very simple and certain. Place over the top-bars of a hive that has a queen a single sheet of ordinary newspaper, and the queenless hive is then placed on top. The floor will be under the lower hive, and the only cover will be placed over the upper hive. No sort of entrance nor opening is left in the upper hive, so that the only way the bees can get out of it is to gnaw a hole through the newspaper. Within a day or two this will be done. The hole at first will be big enough for only a single bee to pass through, and the intermingling of the bees of the two colonies will be so gradual and quiet that there will be no fighting. Eventually the whole paper will be gnawed away and the two colonies become one, and in a few days or a week all the frames of brood with all the bees can be confined to one hive.

If both of the colonies to be united have queens, it is better for the poorer queen to be put out of the way by the beekeeper before the work of uniting by the newspaper plan is begun; but, if one of the queens is not destroyed by the beekeeper in advance, the bees themselves will do the job. The uniting is likely to be more peaceful if one of the colonies has been made queenless two or three days before beginning to unite. The lower hive, standing on its original location, should be left as the permanent home of the united colonies.

Clipping of the Queen.

Unless the laying queens have already been clipped, the clipping should be done during fruit bloom, while the weather is warm and some honey is coming in. At this time the bees will be good-natured and not inclined to rob. Also, during the middle hours of the day many bees will be out gathering nectar; so the hives will not be crowded with the bees, and the queen

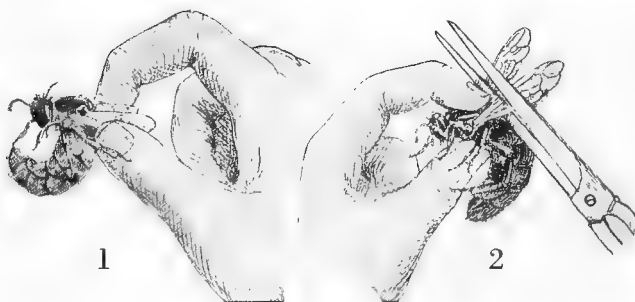

How the queen's wings should be clipped.

will be more easily found. (As to finding the queen see page 56.) She should be carefully picked up by the shoulders, and both her wings on one side cut off nearly $\frac{2}{3}$ of their length.



Pointing out the queen to Miss Goodlooker. One of the pleasantest occupations of apiary work.

Enlarging the Brood-Chamber.

Those brood-nests that were contracted the previous fall should be expanded as soon as the colonies become strong enough to cover more frames. When expanding, it will be necessary to remove the side packing which fills the space made by removal of the combs the previous fall when contracting the double-walled hive. As the combs are added to fill up this space they should be placed at the sides, in order not to divide the brood-nest. It does not pay to be in too big a hurry about removing the top packing. (See page 108.)

Cutting Out Drone Comb.

During the fruit bloom, after the bees are in the best possible condition, queens clipped, colonies strong, plenty of stores and brood-chamber expanded, there is still a very profitable piece of work that one can hardly afford to omit, provided he has an excessive amount of drone comb in his hives, because rearing a large number of drones not only necessitates the consumption of a large amount of honey but also tends toward swarming. In the lower corners of the brood-frames, along the bottom-bar and at various parts of the combs, may be found patches of this drone comb. An excess of drones should on no account be tolerated, and in the warm spring days of fruit bloom is the ideal time for cutting drone comb out and replacing it with worker comb.

After cutting out the undesirable comb, that from which portions have been cut should be used as a pattern and placed over the worker comb which is to be used for patches. With a knife, the shape of the holes may be marked on the worker comb. Then removing the upper pattern the pieces may be cut out of the worker comb, after which they are inserted in the comb to be patched. If they are small and fit in tightly, it may not be necessary to fasten them. Otherwise, they can be held securely by means of wires wrapped around the frames; or, if honey is coming in, the patches may be tied in with strings, which will be removed by the bees as soon as they have attached the patches to the rest of the comb.

Giving Room Below and Above.

To move brood from the hive-body proper to a super above too early in the season would be attended with danger of chilling the brood, since so much of the heat of the lower story would rise to the upper one. But, as stated under the subhead, "Preceding the Honey Flow," page 71, two or three weeks before the opening of the main honey flow, if the strongest colonies become crowded with brood and bees, a super should be given immediately above the lower story; and, if the crowded condition seems to warrant it, it may be advisable to place one or two frames of brood in the upper story, replacing these in the brood-chamber with frames of foundation or, preferably, combs, at the sides of the lower story. When some brood is thus kept in the second story, the bees become so accustomed to occupying the second story that, when the honey flow comes, they start to work in the super with energy.

Increase—Prevented or Made.

By tearing down queen-cells as fast as they appear, placing a few frames of brood, or all but one, above, and filling the remainder of the lower brood-chamber with drawn combs, it will doubtless be possible to prevent all increase during the early summer period. Or, if increase is desired, the above plan may be used, only inserting a queen-excluder between the two stories and tearing down all capped cells. About eight days later the upper story may be moved to a new location and its entrance contracted, to prevent the brood from chilling. (See Chapter XV on "Increase.")

When Spring Management Might Not be Necessary.

As a final word about spring management, let it be said that there are high beekeeping authorities who say that there should be no necessity for any spring management; that if the colony goes into winter quarters strong, with many young bees, has good stores and plenty of protection, such a colony needs no attention in the spring. But this is an ideal condition—not the ordinary situation.

A Final Word.

The beginner, who has read this little book from cover to cover, has now completed the cycle of the beekeeping year, and has been told briefly

of its work and problems, what to do, how and when to do it. The purpose of the book has been to give one tried and proven way of performing every important operation connected with the right keeping of bees. There are different ways of performing many of these operations, as the beginner will shortly learn—and there are many ardent advocates of each different way. It has been the author's very great and conscientious care to try to give only the simplest and surest way. So it is that some things that might have been said have been left unsaid, because of fear of confusing the beginner with too much detail or theory in his first steps. So we leave him to begin another year's cycle, to repeat the work done in the first year, in the same way—except that experience will have taught him lessons in beekeeping that no book can teach him.

There only remains to add an appendix, devoted mainly to the explicit explanation of some of the unexpected or even unpleasant problems that may possibly present themselves to the beginner in his early experiences, and which must be met promptly and effectively when they do occur.

APPENDIX

DISEASES OF BEES.

NOSEMA APIS.—This is a disease of adult bees, and is not considered a very serious one; for, although slightly infectious and although many colonies die from this cause, the percentage is small. Usually the colony is but slightly affected and recovers of its own accord. An apparently normal colony that is weak, especially in the spring, and yet had had good packing, plenty of stores and a good queen, is quite likely to be affected with the nosema disease. An examination of the stomach of a field worker, however, gives still more reliable evidence. If affected, the stomach will appear swollen and lighter in color than a healthy one, or in more advanced cases it will be chalk-white and easily torn. In badly infected bees the stomach when crushed is milky in appearance.

BEE PARALYSIS.—Paralysis is a disease common in the warm South where it appears to be contagious and sometimes affects whole apiaries. Now and then the trouble appears in most apiaries even in the North, but seldom spreads or makes much trouble.

The first symptom the beekeeper is likely to note is healthy bees tugging at the affected ones, pulling them from the entrance. The bees often show a trembling motion and sometimes scratch at their bodies with their legs as if there were violent itching. In some cases, some of the bees have swollen abdomens and a black, greasy appearance. Some of the sick bees are very active, running this way and that, attempting to crawl up spears of grass only to fall back unable to fly; others appear listless and cluster in bunches around the entrance of the hive.

Many different treatments have been advocated, but none are universally successful. One treatment is simply to interchange the places of a diseased colony and a strong healthy one. Another method calls for nuclei and, as soon as they have laying queens, the giving to each nucleus two frames of the oldest capped brood from the paralytic colony. After the brood is disposed of in this way the bees and queen of the affected colony are destroyed with sulphur fumes.

DYSENTERY.—Poor stores, such as honeydew or unripened honey, confinement and insufficient protection often cause what is known as dysentery. If the hive is too cold, in order to keep up the temperature the bees are compelled to eat large quantities of honey. The poorer the honey, the more fecal matter accumulates in the intestines of the bees. This waste matter is normally voided only in flight; therefore, if cold weather prevents flight, the long-retained fecal matter causes purging or dysentery.

An amount of yellow or brownish disagreeable excrement all about the entrance of a hive indicates dysentery. If warm weather permits flight and the brood-nest is contracted to only as many combs as the bees can

APPENDIX.

occupy, the colony will soon recover; but, if no flight is possible, the combs and inside of the hive will become foul with excrement and the colony perish outright.

Colonies cannot contract dysentery from the stained combs. Therefore such combs may be saved until summer and then given to strong colonies to be cleaned, no more than two or three such combs being given a colony at a time. Too many such combs would be a discouragement to any colony and might cause them to abscond.

DISEASES OF BROOD.

AMERICAN FOUL BROOD and European foul brood are two entirely different diseases, requiring quite different treatments. American foul brood attacks sealed brood mostly. The cappings are discolored and sunken in appearance and often have irregular perforations. The diseased larvae are yellowish brown to blackish brown, and, as they decay, have a very offensive odor, become ropy or stringy, and may be stretched out several inches in a delicate thread. The dead larvae are almost always found lying on the lower cell walls. In the last stage the larvae become dried into hard scales which adhere tightly to the cells.

A common treatment for American foul brood is to shake the bees of the diseased colony in front of a clean hive, placed on the old stand and filled with frames of foundation. The bees will soon run into the hive. Any diseased honey they may have in their sacs will be used in comb-building. If no honey is coming in at the time, it will be necessary to feed them. The old hive should be scorched out before using again and the combs rendered into wax. This method is quite satisfactory, if, during the treatment, care is taken that no diseased honey is left exposed on the ground or clothing where robber bees may find it, and if no bees with diseased honey become confused and enter healthy colonies at the time of shaking. The old combs should be destroyed or melted up as soon as taken from the hives.

EUROPEAN FOUL BROOD attacks unsealed brood mostly. The diseased larvae are usually a light yellow. This decayed matter may also have an unpleasant odor but not usually so offensive as in the case of American foul brood. The diseased larvae reach a ropy stage, but instead of roping as a fine thread stretch out as a coarse granular thread. The dead larvae may be found in almost any position on the base or any of the walls of the cells. When scales are formed they do not adhere tightly to the cells as in the case of American foul brood, but may be removed.

A good treatment for European foul brood is to dequeen for a period of from 10 to 20 days, and then to introduce a queen of a vigorous strain of Italians. Or, if the colony affected is Italian, a queen-cell from a good Italian colony can be given immediately after dequeening, as it will be about 10 days before the queen will begin to lay. Before dequeening it is very important to make the colonies strong by uniting or giving emerging brood. Except in extreme cases, it is not necessary to melt up the combs

APPENDIX.

or disinfect the hives, as in the case of American foul brood.

European foul brood can be prevented to a great extent by keeping only a good strain of Italian bees and keeping the colonies always strong.

A good discussion of the distinguishing characteristics and best methods of treatment of the two diseases is given in the A B C and X Y Z of Bee Culture. If one has trouble in determining with which disease his colonies are affected, he should send a sample of the comb for diagnosis to the Bureau of Entomology, Washington, D. C. For this purpose a piece of comb about five inches square and containing a number of dead or discolored larvae should be sent in a wooden box.

SACBROOD.—Although sacbrood is mildly infectious it is not a very serious disease, and does not require treatment. In fact, it usually comes and goes of its own accord without the beekeeper's even suspecting its presence. The dead larvae or pupae vary in color from yellow, gray and light brown to a dark brown resembling foul brood. However, they are never ropy like foul brood, nor have they any odor. They are generally in capped cells, the diseased cells being irregularly interspersed among the healthy ones. When scales are present, they are quite black and roughened and easily separated from the cell wall.

The consistency of the affected larvae assists one in distinguishing sacbrood from foul brood. An affected larva has the appearance of a small closed sac with watery contents. This larva can often be removed from the cell intact.

Starved or neglected brood or dead brood from laying workers or drone layers is sometimes confused with sacbrood because of its unpleasant odor and dark color. If starved or neglected the trouble will disappear as soon as the bees are able to gather pollen; if the brood is from laying workers or drone layers, only drone brood will be affected.

ENEMIES OF BEES.

ANTS.—Ants seldom trouble good colonies of bees in the North, but in the South radical measures must sometimes be taken.

In order to get rid of them, they should be cleaned out of the hives and the hives placed on stands or benches, the legs of which rest in cans filled with some liquid, such as coal tar or crude petroleum, that will prevent the ants from crawling up into the hives.

All ant hills or nests in the apiary should also be destroyed. To do this make several holes, an inch or so in diameter, about a foot deep through the nest. Then pour a tablespoonful of carbon bisulphide in each hole, and stop up the holes with earth so that the fumes may permeate every part of the nests. Great care should be taken since the carbon bisulphide is very explosive when mixed with air. If the nests are not large, kerosene may be used instead of carbon bisulphide, about three times as much of the kerosene being required.

APPENDIX.

MICE.—All honey-houses should be made mouse-proof, and, whenever surplus combs are stored away, care should be taken to exclude mice, for the combs will be completely ruined if mice gain entrance.

When bees are wintered in the cellar, the entrance of the hive should be covered with a strip of coarse-mesh cloth, just coarse enough to let bees through and yet exclude mice; or else the entrance should be contracted to a $\frac{3}{8}$ -inch slot through which the mice cannot enter.

SKUNKS.—Skunks are a great nuisance to the beekeeper, since they eat so many bees as to weaken the colonies seriously. At night the skunks scratch in front of the hives and disturb the bees so that they rush out of the hive to repel the invader. They are then rapidly eaten by the skunks who particularly relish them.

Skunks may be poisoned by putting strychnine inside of small chunks of beef and leaving the beef at the entrance of the hive where the skunks have been working. Because of the danger of poisoning the neighbors' cats and dogs, however, we do not advise relying on poison. It is safer to protect the colonies by fencing them in with four-foot poultry netting, one foot of which is folded at right angles so as to be flat on the ground on the outside of the fence, the outer edge being staked down to the ground. The skunks do not understand how to get under the foot of netting lying on the ground.

WAX MOTHS.—Wax moths do not trouble strong colonies of Italians, but in the South where black bees are kept in box hives they are very destructive. There are two species of wax moths—the larger and the lesser. The larger is more common and more destructive than the lesser. The work of the two moths is similar except that the webs of the smaller one are finer and nearer the surface of the comb.

The larger adult moth is $\frac{5}{8}$ of an inch in length, with a wing expanse of $1\frac{1}{4}$ inches. It is ashy gray in appearance with the back third of each front wing bronze in color.

Weak colonies of bees do not defend themselves so well as strong ones, and therefore moths readily enter and deposit their eggs on the combs. When the eggs hatch the larvae gradually eat their way through the midrib of the comb, leaving the comb all undermined with passageways of web work spotted with excreta. In a short time such combs will be completely ruined. By keeping strong, healthy colonies of Italians, such trouble may be avoided.

When storing away surplus combs, however, it should be remembered that moths, if permitted, will destroy them even more readily than the combs in the hives of bees, for in the case of stored combs there are no bees to repel the moths. For this reason all supers of combs stored in the honey-house should be carefully piled and covered so that no moth may enter. If, however, the combs contain eggs from the wax moth when taken from the hive, the wax worms will develop later on. If moths should appear in stored material, and yet the combs are not badly affected, they may be given to strong Italian colonies to clean up. If the condition is more serious, the combs will need to be fumigated. In this case scrape all propolis from the top and bottom edges of the supers so the bodies will fit tight

and retain the gas. On top of each set of combs, place a cloth about ten inches square (doubled), and pour a tablespoonful of carbon bisulphide on the cloth and cover with two thicknesses of newspaper to insure a tight joint. Then place another body on top and treat the same way, and continue as high as you wish to go.

OTHER ENEMIES.—Insectivorous birds, such as kingbirds, bee martins and a few others sometimes prey on bees. They do no great damage when they capture workers; but when they capture queens in queen-rearing yards the case is more serious, and the owner would probably be justified in waging war on such birds.

Mosquito hawks or "devil's darning-needles" are often very destructive to bees in some of the southern states, but do no damage in the North. In the South lizards also frequently prey on bees. Spiders are sometimes mistakenly considered enemies of bees; but, from the way they make war on the moth miller, we think the spider should be called the beekeepers' friend.

Wasps, hornets and yellow jackets sometimes capture bees, but there are very few places where they are really troublesome.



INDEX

- A**
- After-Swarms, Defined..... 69
 After-Swarms, Preventing..... 69
 Alighting-Board, Described 12
 American Foul Brood.....119
 Ants, Getting Rid of.....120
APIARY
 Location in City..... 33
 Shade Desirable 32
 Where to Locate..... 32
 Appendix118-122
- B**
- Bait Sections, Use of..... 85
 Balling the Queen..... 59
BEE
 Brush Handy 17
 Enemies120-122
 Escape, Porter..... 14
 Escape Board14, 78
 Gloves Needed 17
 Martin, Bee Enemy.....122
 Paralysis118
 Smoker Described.....17, 49, 50
 Tree, Getting Bees from 30
 Veil Essential 17
 Beebread or Pollen..... 40
 Beekeepers, Clothing of..... 49
 Beekeepers, Successful5, 7
BEEKEEPING
 Combined with Other Business..6, 7
 Fascinating 6
 How to Begin..... 8
 Profit from 6
 Success in 5
 When to Start.....7, 108
BEES
 Brushing from Combs..... 79
 Buying21, 22, 26
 Diseases of118-120
 Examining and Handling..... 49
 Getting Them from Trees or Walls. 30
 Kinds of 21
 Length of Life of..... 41
 Located in City 33
 Marking New Location..... 23
 Moving 23
 Need Water113
 Pound Packages of..... 26
 Shade Desirable for..... 32
 Stages in Development of..... 41
 Transferring from Box Hives..27, 28
 What Kind to Get..... 21
 When Likely to Rob..... 92
 Beeswax, Description of..... 42
 Beginning Beekeeping..... 8
 Bottling Honey..... 83
 Bottom-board, or floor..... 12
 Box Hives, Described..... 11
 Box Hives, Transferring Bees from .. 27
 Brood, Diseases of.....119, 120
 Brood, When Kept in Upper Story...116
BROOD-CHAMBER
 Contracting for Winter....., 100, 102
 Defined 42
 Enlarging115
 Brood-Rearing, When Suspended.... 57
 Brush, Handy17
BUYING
 Bees by the Pound..... 26
 Bees, What to Look for..... 22
 Nuclei 24
 Swarms 25
- C**
- Can, Uncapping 80
 Candy, Feeding112
 Candy, Recipe for112
 Capping of Cells.....45, 46
 Capping Receptacle 80
 Carbon Bisulphide, Remedy for Ants.120
 Carbon Bisulphide, Remedy for Moths.121
 Cellar, When Bees Taken from.....109
 Cellar Wintering.....101, 106
CELLS
 Arrangement of45, 46
 Cappings of45, 46
 Description of43, 44, 45
 Chaff Tray 14, 103
 Chunk Honey Production..... 10
 Cleaning Hive111
 Clipping, When and How Done...114, 115
 Clothing for Beekeepers..... 49
COLONIES
 Distinguished from Swarms..... 25
 Divided for Increase..... 90
 Increase of 91
 Strong for Honey Flow.....108
 Uniting113
 Weak Ones Robbed..... 94
 When Taken from Cellar.....109
COLONY
 Distinguished from Nucleus..... 24
 Full 24
 Hopelessly Queenless..... 59
 Proof of Drone-layer 96
 Proof of Laying Workers in..... 96
 Proof of Queenlessness 96
 Queenless, How Managed..... 57
 Yield of 6
COMB
 and Extracted Honey Production
 Compared69, 71
 Building 43
 Description of15, 43
 Drone, Rejected.....29, 115
 for Brood 44
 Foundation, Described15, 44
 Foundation, Purposes of..... 45
COMBS
 Care of82, 96
 Freeing from Bees..... 79
 Old for Winter Nest.....100
 Stained, How Cleaned.....119
 Stronger with Age..... 44
 Travel-stained 44
COMB HONEY
 Outfit to Produce.....19, 20

INDEX.

Preparing for Market.....	89	Food, Larval	37
Storing	89	FOUL BROOD	
Supers	19	American	119
Taking Off	89	European	119
COMB-HONEY PRODUCTION		Sending Samples of.....	120
Before Honey Flow.....	84	FOUNDATION	
Beginning of Honey Flow.....	85	Comb	44
Compared with Extracted-Honey		Sheets of	13, 16
Production	9, 71	Uses of	44, 45
Outfit for	19, 20	FRAMES	
Skill Required in.....	84	Hoffman	12
COVER		How Handled	53-55
Inner	14, 16	Movable	13
Outer	14, 16	Fruit-growing and Beekeeping.....	7
Tarred Paper	105	G	
Telescoping	14	Gloves, Essential	17
D		Gums, Log	27
Differences Between Comb and Ex-		H	
tracted Honey Production.....	71	Handling Frames, Method of.....	53-55
Diseases, Brood	119, 120	Harvest Work, After.....	95-97
Diseases of Bees	118-120	HIVE	
Division-board, Use of.....	15	Arranged for Winter.....	103
Double-walled Hive	14	Best	11, 12
DRONE		Cleaning	111
Comb, Cutting Out.....	115	Covers	16
Description of	39	Double-walled	14
Development of	39	Entrance to	12
Eyes of	39	Equipment for.....	12, 16, 17
Fate of	39	Equipment for Opening.....	49, 50
Layers Described	58	Examining	56
No Father of	38	Floor of	12
Drones, Number of.....	39	Inhabitants of	36
Dysentery, Described	118	Opening	50, 51
Dysentery, Indications of.....	111	Parts of	12, 16
E		Single-walled	14
Eggs, Laying of.....	38	Stand Arranged for Winter.....	103
Enemies of Bees.....	120-122	Tool, Use of	17, 50
ENTRANCE		Use Only One Kind of.....	16
Contracted in Weak Colonies.....	110	When to Open in Spring.....	110
Contracting Cleat	12	HIVES	
Regulation of	12, 109	Kinds of	11, 12
Size of	104	Location in City	33
EQUIPMENT		Paper-packed	105, 109
for Comb-honey Production	19, 20	Shade Desirable for.....	32
for Extracted-honey Production....	80	Standard	12
of Hive	12	HONEY	
Escape Board, as Inner Cover.....	14, 16	Bottling	83
European Foul Brood.....	119	Chunk, Production of.....	10
Excluder Described	12	Comb or Extracted?.....	9
Extracted Honey, Outfit to Produce,		Containers	83
.....	11, 16-18	Description of	47, 48
EXTRACTED-HONEY PRODUCTION		Extracting	78-82
Preceding Honey Flow.....	71	Extractor, Described.....	18, 80
Preventing Swarming in.....	73-77	Flow, Seasons of.....	95
Time of Harvest.....	72	Flow, Work After.....	95-97
EXTRACTING		Harder to Extract if Cold.....	79
Equipment for	80	Kinds for Winter Stores.....	99
Process of	81	Nectar Changed into	40
Robbing During	79	Preparing for Market.....	82
When to Do	78	Sac, Use of	40
Extractor, Described	18, 80	Selling Too Low.....	83
Extractor, Location of.....	80	Some Unfit for Stores.....	95
F		Storing	82
Feeders, Kinds of.....	100	Strained Formerly	11
Feeding, Method of.....	100	Taking Off	78, 89
Feeding Syrup in Fall.....	98	Honeydew, Description of.....	48
Fences, Use of.....	20	I	
Final Word	116	INCREASE	
Finding the Queen.....	56	by Dividing Colonies.....	90
Floor, also Called Bottom-board....	12	Making	90, 116
Follower, Construction of.....	19		

INDEX.

Prevented or Made.....116
 Inside the Hive.....42-48
 Introduce, How to.....60
 Introducing, When Done.....59, 95

K

KD Explained15
 Kingbird, Bee Enemy.....122

L

Labels for Honey Containers.....83
 Laying Workers, Described.....58
 Lizards, Bee Enemy in South.....122

LOCATION

in City33
 of Apiary32-34
 That Protects from Stinging.....34

M

MANAGEMENT

in Producing Comb Honey.....84-89
 in Producing Extracted Honey.....71-77
 in Spring108-116
 of Queenless Colony.....57, 59
 Marketing Comb Honey.....89
 Marketing Extracted Honey.....82, 83
 Martin, Bee Enemy.....122
 Mats, Covering Tops of Frames.....103
 Mice, Precautions Against.....121
 Moths, Precautions Against.....121
 Moths, How to Destroy.....121
 Mosquito Hawk, Bee Enemy.....122
 Moving Bees Home.....23

N

Nectar Changed to Honey.....40
 Newspaper Uniting Plan.....95, 114
 Nosema Apis118
 NP Explained15

NUCLEI

Buying24
 Directions on Receiving.....25
 Sizes of24
 Nucleus, Distinguished from Colony..24

O

Outdoor Wintering101
 Outfit to Produce Comb Honey...19, 20
 Outfit to Produce Extracted Honey.11, 12

P

Packing, When Needed.....101
 Packing, When to Remove...108, 109, 115
 Packing-case, Quadruple.....104
 Packing-case, Wintering in.....101, 104
 Pail, Friction-top for Feeding.....100
 Paper-packed Hives.....105, 109
 Paralysis, Symptoms of.....118
 Paralysis, Treatment of.....118
 Parthenogenesis, Defined.....38
 Playfights, Mistaken for Robbing....94

POLLEN

Also Called Beebread.....40
 Description of.....41, 47
 How Carried22
 Substitutes for47
 Poultry-raising and Beekeeping.....7
 Pound Packages, Buying.....26
 Preventing Swarming in Comb-honey
 Production86-88
 Preventing Swarming in Extracted-
 honey Production73-77
 Profit from Beekeeping.....6
 Propolis, Description of.....41, 47

Q

QUEEN

and Drone Trap.....67
 Balling of59
 Clipping of114
 Defective36, 57, 59, 96
 Description of36-39
 Drone-laying58, 59
 Egg-laying of38
 Excluder Described12
 Finding the56
 Importance of a Good.....39
 Introduction of.....59, 60, 95
 Laying Season of.....38
 Length of Life of.....38
 Lost57
 Missing36, 57, 96
 Mother of Colony.....39
 New One Provided.....36, 87
 Normally One in Hive.....38
 Number of Eggs Laid by.....38
 Nuptial Flight of.....37
 Rearing a56
 Replacing of57, 95, 96
 Supersedure of57, 95, 96
 Tested96
 Unsatisfactory, Replaced...57, 95, 96
 Untested96
 Work with56-60

QUEEN-CELLS

Description of36, 37
 How Given in Requeening.....58
 Where Built36, 47
 Queenless Colony, How to Detect...57
 Queenless Colony, How Managed...57
 Queenlessness, Proof of.....96

R

Races of Bees.....21
 Replacing of Queen.....57-59
 Requeening, Process of.....36, 37, 96

ROBBING

Dead Colonies.....110
 Distinguished from Playfights...94
 May be Serious.....92
 Precautions Against.....79, 93, 94
 Weak Colonies94
 When Extracting93
 When Likely to Occur.....92
 Royal Jelly, Food of Queen Larva...37

S

Sacbrood Described120
 Section, Described19
 Section-holder, Described19
 Selling Honey.....82, 83, 89
 Separator, Use of.....19, 20
 Shade, Desirable for Bees.....32
 Single-walled Hive.....14
 Skep, Straw11
 Skep, Transferring from.....27
 Skunks, Bee Enemies.....121
 Smoker, Described17
 Smoking the Swarm70
 Spiders, Bee Friends.....122

SPRING

Dwinding101
 Management108-116
 Stores Necessary111
 Springs, Use of.....20
 Stages in Bee Development.....41
 Stings, How to Avoid.....49-52

INDEX.

Stings, How Treated	52	Preventing in Producing Comb Hon-	
STORES		ey	86-88
Amount of	98, 99	Preventing in Producing Extracted	
Candy, in Early Spring.....	112	Honey	73-76
Kinds Bad for Winter.....	99	Season of	61
Necessary in Spring.....	111	SYRUP	
Plenty for Wintering.....	98	Fed in Fall	98, 99
Poor	99	for Feeding	100
Sealed, Giving	111	How Made	99
Syrup	99		
Storing Honey, How and Where.....	82	T	
Straining-can in Extracting.....	81	Tarred Paper Cover.....	105
Super, Described	12, 13, 19	TRANSFERRING	
Super Springs	19	Bees from Box Hive.....	27
Supering, in Comb-honey Production.	86	Method of	27-29
Supering, in Extracted-honey Produc-		Time to Do.....	29
tion	76	Trap, Queen and Drone.....	67
Supersedure of Queen.....	36, 57, 95, 96	Travel-stained Comb	44
SWARM		Tray, Chaff	14, 103
Buying	25	Tray of Leaves or Shavings.....	103
Catcher, Manum	65		
Clustered High	66	U	
Clustered Low	66	Uncapping-can, Construction of.....	80
Clustered on Unshakable Place....	67	Uncapping-knife, Described	17
Directions for Hiving.....	25, 26	UNITING	
Distinguished from Colony.....	25	Defined	113
Hiving, with Clipped Queen.....	63-66	Newspaper Plan of	114
Hiving, with Unclipped Queen.....	65-68	Weak Colonies	95
Preparing to Hive a.....	63		
Smoking the.....	70	V	
With Virgin Queen.....	70	Veil, Essential	17
SWARM PREVENTION			
a Great Problem.....	70	W	
in Extracted-honey Production.....	73-77	Water, Bees' Need of.....	113
with Increase, in Producing Extract-		Wax, Description of.....	42, 43
ed Honey	75	Wax Moths, Description of.....	121
Without Increase in Producing Ex-		Windbreaks, Important	32, 101
tracted Honey	76	WINTERING	
When Producing Comb Honey.....	86-88	Brood-chamber Contracted in.....	100, 102
Swarms, After		in Cellar	101, 106
Swarms Uniting, Treatment of	69	in Double-walled Hives.....	102
		in Packing-cases	104
		Outdoors	101-105
		Requirements for Good.....	98
		Ways of	101
		When Packing Needed in.....	101
		with Tarred Paper Tied on.....	105
		Winter Nest, Described	100, 102
		Winter Protection, Taking Away.....	108
		Wire-entrance Guard.....	68
		Worker, Described.....	39, 40
		Worker, Laying	58

ILLUSTRATIONS

APIARY		Inserting the	78
in City Back Yard.....	33	Porter	15
in Town	32	Beekeeping and Fruits Combined....	7
Protected by High Fence.....	102	Beekeeping Combined with Poultry-	
Protected by Trees	33, 101	Raising	6
B		BEE	
BEE		Between Combs of Hive.....	42
Brush	18	Brushed Off a Comb.....	79
Just Emerging.....	40	Enjoyed by Kiddies.....	5
Larva of	41	Examining	50-55
Pupa of	41	Full Frame of.....	22
Smoker	17	Guarding Entrance.....	92
Stages in Development of.....	41	Handling Frame of.....	40
Stinger Dissected	52	Kept by Schoolboys.....	5
Veil	17	Queen, Drone, Worker.....	36
BEE-ESCAPE		Secreting Wax	43
Board	15	Shaking, Off a Comb.....	79

INDEX.

Taken from Shipping Case..... 24	Tool 17
BOX HIVE	Tool, Prying Up Cover with..... 51
Combs in 28	Hives, Big Load of..... 23
Transferring from 28	Hives, Paper-wrapped..... 105, 106
Undesirable 27	Honey-extractor..... 18, 80
Brood-chamber, Single-walled 14	Honey in Section Boxes..... 84
Brood, Worker 46	I
Brush, Bristle 18	Introducing Queen in Mailing Cage... 60
Brushing Bees Off Comb..... 79	K
C	Kiddies Enjoying Bees..... 5
Cage, Combless Bee-shipment..... 26	L
Cage, Mailing and Introducing..... 60	Larva of Bee..... 41
Candy, Fed to Bees..... 113	LOCATION
Capping Receptacle..... 80, 81	Apiary in City..... 33
Cellar, Wintering in..... 106	Apiary on Roof..... 33
CELLS	Good, in Town..... 32
Drone and Worker..... 46	M
Eggs in 39	Mailing Cage, Introducing Queen in.. 60
Queen 37	P
Clipping, Method of..... 114	Packing-case Made of a Shipping Crate. 104
Colony, Weak 110	Packing-case, Quadruple..... 104, 105
COMB	Porter Bee-escape..... 15
Built Without Foundation..... 16	Pupa of Bee..... 41
Foundation, Frame of..... 44	Q
Honey in Section Boxes..... 84	Quadruple Packing-case 104, 105
in Tree, Sample of..... 43	QUEEN
of Drone and Worker Cells..... 46	and Drone Trap..... 70
of Worker Brood..... 46	and Workers..... 38
Combs, Bees Between..... 42	Bee 36
Combs in Box Hive..... 28	Cell, Putting into Hive..... 58
Cover, Taking Off Outer..... 51	Cells 37
D	Clipping of 114
Development of Bee, Stages in..... 41	Excluder 12
Division-Board, Loose-hanging 15	Looking for 68, 115
Drone Bee 36	R
E	Root, A. I., Examining Bees..... 2
Eggs in Cells..... 39	S
ENTRANCE	Schoolboys Handling Bees..... 5
Bees Guarding 92	SECTION
Blowing Smoke into..... 50	Boxes Containing Honey..... 84
Normal Scene at..... 22	Comb-honey, with Foundation..... 16
Examining Frames of Bees..... 51-55	Holder, Beeway 20
Extracting Equipment..... 80, 81	Holder, Plain 20
Extractor, Two-frame..... 18, 80	Shade, Good for Bees..... 32
F	Shaking Bees Off Comb..... 79
Feeding Hard Candy..... 113	Shipping Cage, Combless..... 26
Feeding Syrup in Pails..... 100	Shipping Case, Taking Bees from... 24
Fence 20	SMOKER
FRAME	Essential 17
for Shallow Super..... 14	Nursing Fire in..... 49
Handling 52-55	Operating 49-51
Hoffman Self-spaced 13	Using Bellows of..... 49
Leaning against Hive..... 52	Stages in Development of Bee..... 41
Normally Full of Bees..... 22	Stinger Dissected 52
of Comb Foundation..... 44	SUPER
Lifting Out..... 52	A Shallow and a Deep..... 13, 14
with Foundation..... 16	Beeway Section 20
Fruit-growing and Beekeeping..... 7	Plain Section 20
G	Supers, Positions of..... 73, 75, 86-88
Gloves 17	SWARM
H	Clustered on Low Branch..... 66
Handling Frame of Bees..... 52-55	Cut from Branch..... 26
HIVE	Looking for Queen..... 68
Box 27	on Branch 61
Opening 50, 51	on Outside of Hive..... 62
Packed with Leaves..... 102	on Post 69
Parts of, with Comb-honey Super.. 19	Shaken upon Sheet..... 68
Parts of, with Extracting-super... 11	Shaking, into Basket..... 67
The Several Parts of..... 11, 19	

INDEX.

Syrup, Feeding, in Pails.....100	V
T	Veil 17
Tarred Paper Wrapping.....105, 106	W
Transferring from Box Hive..... 28	Water for Bees.....118
Transferring from Tree..... 30	Wax, Secreted by Bees..... 43
Trap, Queen and Drone..... 70	Windbreak, High Fence.....102
Tray of Leaves.....103	Windbreak of Trees.....33, 101
Tray, Placing Cover Over.....103	Wintering in Cellar.....106
U	Wintering with Tarred Paper Tied
Uncapping Honey 81	on105, 106
Uncapping Knife18, 81	Worker Bee36, 47

