

SF  
523  
S193  
1921

LOCKWOOD'S GARDEN MANUALS

# B E E S

FOR PLEASURE AND PROFIT

---

G. GORDON SAMSON

ALBERT R. MANN  
LIBRARY

NEW YORK STATE COLLEGES  
OF  
AGRICULTURE AND HOME ECONOMICS

AT  
CORNELL UNIVERSITY



EVERETT FRANKLIN PHILLIPS

BEEKEEPING LIBRARY

John Anderson

Presented by Gilbert Barratt.  
June 1933

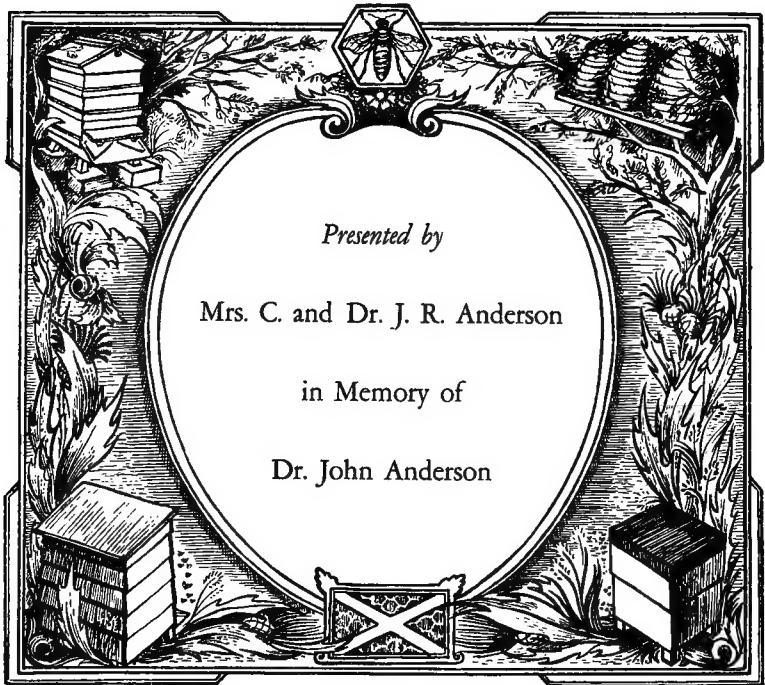

Cornell University Library  
SF 523.S193 1921

Bees for pleasure and profit; a guide to



3 1924 003 514 027

mann

# BEES

FOR PLEASURE AND PROFIT

# BEES FOR PLEASURE AND PROFIT.

BY G. GORDON SAMSON.

---

## *Opinions of the Press on the First Edition.*

"This is a capital work on the subject of bees. The whole of the details of management are clearly given, without undue elaboration, and there are many indications that the chapters are the outcome of actual experience."—*Mark Lane Express*.

"A practical treatise on manipulation and management. . . . Portable in form and cheap of cost, it should form part of every bee-keeper's equipment."—*Nature*.

"The book is the result of exhaustive experiments which the author has carried out. . . . Written in plain, simple language, the aim of the writer has been to explain as tersely and as briefly as possible the mysteries of the beehive, the various manipulations connected with the apiary, and other matters of importance to bee-keepers. The book is one that should commend itself."—*Irish Farming World*.

"A simple and reliable work, which we have great pleasure in recommending as the most pithy and valuable book we have seen."—*Horticultural Times*.

"The book will be found valuable as a guide to the manipulation of bees, the production of honey, and the general management of the apiary. The author has been careful in his calculations, and his conclusions will be sure to win the consent of readers."—*Bristol Observer*.

"This is certainly one of the best handbooks on the subject we have seen."—*Banbury Guardian*.

"A useful and thoroughly practical *vade mecum* to the arts of the apiary. . . . The book is illustrated throughout, and every possible matter relative to the hive and its interesting inhabitants is discussed."—*Norwich Argus*.

"The intending bee-keeper will find exactly the kind of information required to enable him to make a successful start with his hives. . . . Mr. Samson is a thoroughly competent teacher."—*Morning Post*.

"We believe that if the author's suggestions are intelligently followed, the results obtained will be as satisfactory as those yielded by other methods. There is a good chapter on the diseases of bees, and the remedies that should be applied."—*Westminster Review*.

"An able and interesting exposition of the whole art and mystery of bee-keeping, calculated to teach the beginner the wisest methods of securing the best developments. The author speaks from the fulness of a wide practical knowledge of his subject."—*Colonies and India*.

---

LONDON :

CROSBY LOCKWOOD & SON, 7, STATIONERS' HALL COURT, E.C.

# B E E S

## FOR PLEASURE AND PROFIT

*A A GUIDE TO THE MANIPULATION OF BEES, THE  
PRODUCTION OF HONEY, AND THE GENERAL  
MANAGEMENT OF THE APIARY*

BY

G. GORDON SAMSON

AUTHOR OF "CAUSES AND CONSEQUENCES," "EVERY MAN HIS OWN  
BUILDER," ETC., ETC.

*FIFTH EDITION, AGAIN REVISED AND ENLARGED*



LONDON  
CROSBY LOCKWOOD AND SON  
7, STATIONERS' HALL COURT, LUDGATE HILL

1921

[All rights reserved]

*alw*

SF  
523  
S193  
1921

**E 533**



## PREFACE TO THE FIRST EDITION.



IN the following pages it has been my endeavour to treat the subject of Bee-keeping in detail as fully as the size of the work permits. Where there are several ways of performing the same operation or arriving at the same end, I have thought it best not to confuse the beginner with a multiplicity of methods, and have therefore detailed only that one which my experience has proved the best.

With regard to the practical side of the subject, these pages embody the results of exhaustive experiments which I have carried out on several points ; and in those cases in which my own experience does not lead me to speak with confidence and certainty, I have been careful to compare the highest authorities, and to obtain the information on which I base my conclusions from the most reliable sources and the best-known authors.

I have striven to avoid over-burdening the work with unnecessary verbosity, my aim having been to explain, as tersely and with as much brevity as possible, the mysteries of the beehive, the various manipulations con-

nected with the apiary, and other matters important to be known and understood by the Bee-keeper.

I have also briefly touched upon the relation of apiculture to horticulture and agriculture, in the hope that, should this little work fall into the hands of those who are engaged in the latter pursuits, more especially into the hands of fruit-growers, the remarks which it contains on this subject may be of some substantial and practical utility. In very fine seasons, when the springs are bright, fine, and mild, fruit will doubtless set very well without the intervention of bees—the wind, assisted by the sunshine, being a sufficient agent for the distribution of the pollen; but in cold, wet seasons the aid of bees is unquestionably essential to the fertilisation of the bloom by carrying the pollen, not anywhere at haphazard as the wind does, but from blossom to blossom, and nowhere else. In wet and cold weather the pollen is more inclined to adhere to the blossoms than in fine, warm weather; and thus it is that the wind fails in unfavourable seasons to secure that which can then be obtained only by the help of bees—viz., the proper fertilisation of the fruit blossom, with the result of a proportionately abundant crop of fruit.

I would invite any persons who may be incredulous on this point to visit, in a confessedly bad fruit year—say during August or the early part of September—the localities in which some of our large apiaries are situated. Let them carefully view the country lying in a radius of, say, two miles from the apiary itself; and they will find

that in almost every case the fruit trees are laden with heavy crops, while they will observe as they get farther from the vicinity of the apiary (supposing that not very many bees are kept in the country around) that the fruit crops steadily deteriorate. The proof, to me at any rate, has been indisputable, and I hope that it may be so to many others; for I am convinced that, so soon as bee-keepers and fruit-farmers begin to recognise the importance of the one industry in relation to the other, more prosperous times will be in store for each, and we shall not only hear of better fruit-harvests, but of larger returns of honey also.

Thus, by making bee-keeping and fruit-growing really profitable industries, may we hope to successfully vie with foreign competition, and produce in larger quantities in our own country two commodities—fruit and honey—which at present we largely import from abroad.

G. GORDON SAMSON.

OLDFIELD,  
BOURNEMOUTH, 1892.

NOTE.—The AUTHOR has to acknowledge his indebtedness to Mr. T. W. COWAN, F.L.S., Author of *The British Bee-Keepers' Guide Book*, for allowing the use in this volume of five of the illustrations—namely, Figs. 27, 29, 31B, 32, and 37B, also 23A.

## PREFACE TO THE THIRD EDITION.

---

THE demand for this little work having necessitated the publication of a third edition, the present issue has been thoroughly revised and brought up to date, and a new chapter on Bee-keeping in our Colonies and in hot climates has been added, by which I trust that the usefulness of the book may be enhanced.

G. GORDON SAMSON.

CHURCH SQUARE,  
CAPETOWN, 1904.

## PREFACE TO THE FIFTH EDITION.

---

THE first edition of this little book was published in 1892, and the demand for it continuing still undiminished, the present edition has been again revised and brought absolutely up to date, while the section on Bee-keeping in the Colonies and in hot climates, as well as the chapter on the Diseases of Bees, has been enlarged.

G. GORDON SAMSON.

CANNES, *June* 1921.

# CONTENTS.



## CHAPTER I.

### NATURAL HISTORY OF THE HONEY BEE.

The Internal Economy of the Beehive—The Workers—The Drones  
—The Queen—Fertile Workers . . . . . pp. 1—8

## CHAPTER II.

### SWARMS AND SWARMING.

When Breeding Begins—Swarming—Appearance of a Hive before  
Swarming—Second Swarms and Casts . . . . . pp. 9—11

## CHAPTER III.

### THE VARIOUS RACES OF BEES.

The English Bee—The Italian or Ligurian Bee—The Carniolan  
Bee—The Syrian Bee—The Cyprian Bee—The South African  
Bee—Crossbred Bees, Italian Hybrids, Carniolan Hybrids—  
The Syrio-Carniolan Bee, a Model Bee—The "Golden Italian"  
Bee . . . . . pp. 12—15

## CHAPTER IV.

### HIVES.

The Straw Skep—The Bar-frame Hive—Bar Frames—Metal Ends  
—The Floor Board—The Body Hive—The Entrance, and  
Entrance Contractors—The Porch—Dummy or Division  
Boards—The Roof—Position of Frames—The Size of the  
Hive—Doubling Boxes—Removable Walls—Quilts . . . . . pp. 16—23

## CHAPTER V.

## HOW TO MAKE A START IN BEE-KEEPING

What to Buy—How to Hive a Swarm—Comb-Foundation—Why Foundation is Used—How to fix Foundation in Frames—Wiring Foundation into Frames . . . pp. 24—29

## CHAPTER VI.

## MANIPULATING BEES.

What to do when Stung—Bee Veils—Gloves—Gorging the Bees—Smoking—How to Manipulate—Manipulating a Full Hive—Quieting Bees with Carbolic Acid . . . pp. 30—34

## CHAPTER VII.

## THE PRODUCTION OF COMB HONEY.

Sections—Section Crates—Frames of Sections—Dividers—When to Super—Raising the Super—Taking off the Super—Packing Sections—Strong Stocks Indispensable—How to Unite—How to find the Queen—Swarming . . . pp. 35—44

## CHAPTER VIII.

## THE PRODUCTION OF EXTRACTED HONEY.

How to Produce Combs—Doubling—Extracting—The Extractor—Storing Combs in Winter—Ripening and Bottling—Shallow Frames—Heather Honey . . . pp. 45—50

## CHAPTER IX.

## THE PROFITABLE PRODUCTION OF BEES.

Natural Methods of Increase—Stimulative Feeding—Spreading the Brood—Truant Swarms—Building up the Stocks—Profit and Loss—Begin with One Stock—Artificial Methods of Increase—Give the Bees Plenty of Room—Queen-raising—Forming Nuclei—Fixing the Queen Cells—Breed Queens from the Best Stock in the Apiary—Building up the Nuclei—Profit and Loss—Economy . . . pp. 51—66

## CHAPTER X.

SPRING, SUMMER, AUTUMN, AND WINTER  
MANAGEMENT.

Spring Management—Candy—Robbing—Hive Roofs Blowing off— Planting for Bees—Summer Management—Introducing Queens —Shading Hives—Autumn Management—Condemned Bees— Driving—Robbing—Packing up Bees for Winter—Winter Management . . . . .	pp. 67—76
--	-----------

## CHAPTER XI.

THE WELLS' SYSTEM OF KEEPING TWO QUEENS IN  
ONE HIVE, THE DISEASES OF BEES.

How to Keep Two Queens in One Hive—Mr. Wells' Discovery— Autumn the Best Time to Start—The Wells' Hive—The Wells' Dummy Board and How to Make It—Section Racks for Wells' Hive—Metal to be Avoided as a Material for Wells' Dummies —What to do when the Bees Swarm—The System only Suit- able for Experienced Bee-keepers . . . . .	pp. 77—79
---	-----------

## CHAPTER XII.

## THE DISEASES OF BEES.

Dysentery—Foul Brood—Symptoms of Foul Brood—Remedies— Salicylic Acid—Phenol—Formic Acid—Naphthol Beta—Treat- ment of Foul Brood in its More Advanced Stages—The “Starvation” or “Fasting” Method of Treating Foul Brood —Destruction of Badly Diseased Stocks—Necessity for Disinfection—Isle of Wight Bee Disease—Its Symptoms— Cures and Prevention—Prevention Better than Cure— Naphthaline . . . . .	pp. 80—93
---	-----------

## CHAPTER XIII.

## FINAL HINTS.

Keep all Stocks Strong—Use Cane Sugar—Manipulating—Extract- ing Wax . . . . .	pp. 94—97
--	-----------

## CHAPTER XIV.

## BEE-KEEPING IN HOT CLIMATES.

Thick Wood should be Used for the Construction of Bee-hives in Hot Climates—Great Necessity for Shading Hives—The Best Method of Artificially Increasing the Number of Stocks of Bees in Hot Climates—Baby Nuclei—The Use of Sections as Miniature Frames—South African Standard Size Frames—Fitting the Sections into Frames—No-bee-way Sections—Hatching Bee Brood in Chicken Incubators—Its Advantages—Bees thus Hatched will not Desert Nuclei—How to Convert Sections into Miniature Frames—Removing the Bees from the Incubator to the Baby Nucleus Hives—The Newly Formed Nuclei should be Stood in a Warm Room for a Few Days before being put out in the Apiary—The Danger of Robbing—Baby Nuclei must Always be Fed—Baby Nucleus Hive—Rapid Method of Building up Baby Nuclei into Strong Stocks—Hatching Queens in Incubators—How to Make a Natural Incubator—Bee-keeping in Canada, Australia, and South Africa—Ants must be Guarded against—Conclusion pp. 101—115



# BEEES

## FOR PLEASURE AND PROFIT.

---

### CHAPTER I.

#### *NATURAL HISTORY OF THE HONEY BEE.*

THE Honey Bee belongs to the great family of Hymenoptera, which includes Bumble Bees, Wasps and Ants.

The common bee (*Apis mellifica*), indigenous to this country, is known variously as the German Bee, the Black Bee and the Brown Bee. Of these names the second is, to my mind, wholly inapplicable, as the colour of the bee is distinctly brownish; and I am glad to notice that the third and more correct term is now obtaining pretty general usage.

I conclude that most of my readers will have seen the old-fashioned skep or straw hive, with its picturesque hackle, so often to be met with among the gay old flowers of the cottage gardens in our rural districts. Most of us have repeated in our childhood the well-known verses of Dr. Watts, beginning—

“ How doth the little busy bee  
Improve each shining hour ! ”

and perhaps some of us have proceeded as we grew older to put the lines in the form of a question rather than an exclamation: whether we have succeeded in answering that question to our satisfaction is another matter; and in the following pages I shall assume that my readers have not as yet acquired much knowledge of the natural history of the honey bee.

#### **The Internal Economy of the Beehive.**

A hive of bees in its normal state consists of a queen, workers, and—in the swarming season—drones also.

The queen is the mother bee, and lays all the eggs from which the inhabitants of the hive are produced; the workers are imperfect and unfertile females; while the drones are the male bees. The queen, as will be seen from fig. 1, is much

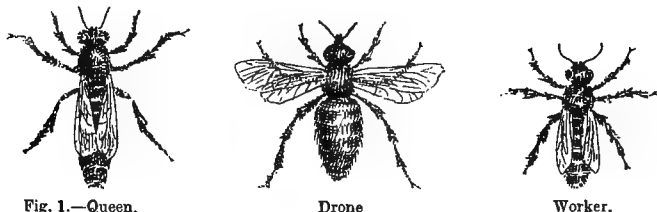

larger than either the workers or drones. She does no work, her sole duty being to lay eggs; and in the summer she will lay as many as three thousand of them a day. She lives four or five years.

The drones are produced at swarming time, their sole use being to mate with the young queens, as they do no work at all. They, however, consume a great deal of honey, and for this reason the bee-keeper should limit the number of drones in his apiary by allowing the bees to build but little drone-comb. In flying the drones make a very loud buzzing, and the novice will at once learn to distinguish them from the workers when on the wing by the great amount of noise which they make. They are considerably larger and stouter in appearance than the workers.

The workers, or "neutrals" as they are sometimes called, attend to all the business of the hive, as it is they who rear

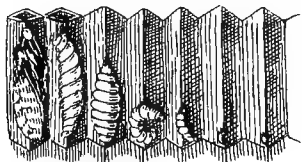

fig. 2.—Development of the Bee. Brood in various Stages, from the Egg to the Imago.

the brood (fig. 2), feed the queen and drones, gather the honey and pollen, build the combs, and defend the hive from robber bees and other hostile insects. On their hind legs are what are known as "pollen baskets."

These consist of long hairs, in which the bees carry the pollen which they collect from the flowers. A bee never gathers pollen from more than one kind of flower in a single journey, and it is owing to this wonderful provision of nature that we do not have the pollen of one species of flower wasted by being carried to another species which it could not fertilize.

Honey comb, as most people know, is composed of small hexagonal or six-sided cells. In these the honey is stored and the brood reared. The queen deposits one egg in the bottom of each empty cell. She lays two kinds of eggs: one kind, which she lays in the small-sized cells, produces the worker bees; and the other kind, which she deposits in the larger cells, produces the drone bees. The queens, as we shall presently see, are also produced from worker eggs placed in acorn-shaped cells, and supplied with different food—the same eggs precisely as, under different conditions, would produce worker bees.

If we examine the combs in a hive, we shall find that they are chiefly composed of the small cells, five of which measure an inch across: these worker combs are about  $\frac{7}{8}$  inch in thickness. In the drone comb—*i.e.*, that composed of the larger cells—only four cells go to the inch. This drone comb is found principally at the sides of the hives, and is usually built when honey is coming in in large quantities, as it requires less beeswax for its construction. It measures about  $1\frac{1}{8}$  inch in thickness. A swarm of bees when left to itself usually clusters in the highest part of the hive, and there builds about four or five worker combs. When these are

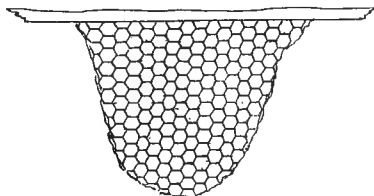

Fig. 3.—Newly Built Comb.

nearing completion, which will probably be in ten days or a fortnight, the bees commence to build other combs at the sides of them, and these are generally composed of drone cells. Honey is stored in both worker and drone combs.

Let us carefully watch a swarm of bees, and we shall learn

a great deal concerning the economy of the beehive. In fine weather, in about twenty-four hours from the time they are hived, a swarm of bees will have constructed three or four combs measuring some three inches along the top and tapering towards the base (fig. 3).

The cells nearest the hive's roof will be filled by the bees with honey and pollen—though the bulk of the pollen is placed in the lower parts of the combs when they are com-

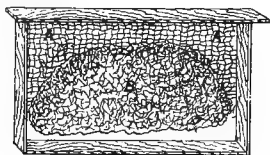

Fig. 4.—Comb stored with Honey and Brood. A, Honey; B, Brood.

pleted. It is also in the centre of the combs that the queen lays her eggs, the bees storing the honey above and at the sides of the brood (fig. 4).

One egg only is placed in the bottom of each cell, though it occasionally happens that a young and prolific queen, if confined to a small hive, will deposit two or three in a cell. This, however, rarely happens; and when it does, the bees eat the superfluous eggs, only allowing one in each cell. The eggs, though so minute, are composed of shell, "white" or albumen, and yolk.

### Development of the Bee.

From the egg, kept warm by the bees which cluster on the combs, a small white grub or "larva" hatches out in three days. The bees feed it sparingly for five days on a food composed of half-digested honey and pollen, and during this time it grows with such rapidity that by the fifth day it nearly fills the cell: the bees then cap over the cell with a porous covering made of beeswax and pollen. Capped or "sealed" brood is easily distinguished from sealed honey, as the cappings of the former are more convex than those of the latter, and, being partly composed of pollen, they are also of a darker colour. When the larva is capped over, it spins its cocoon, and three days later—*i.e.*, when it is eight days old—it assumes the "pupa" or "nymph" state. Ten days later, or twenty-one days from the time that the queen deposited the egg, the

pupa emerges from its cell a perfect worker. It gnaws through the capping of its cell, never receiving the slightest assistance from the other bees in the hive. So infinitesimally thin is the cocoon left behind in the cell, that it takes many dozens of them to make any appreciable difference in the size of the cell; and therefore we may allow the same combs to be used for brood for a dozen years, without fear that the bees produced in such combs will be smaller than those reared in new ones.

The work of the young bees is to feed the brood, while the old bees are thus enabled to use all their energies in gathering honey. This is a very important point to remember, and we should always give a swarm of bees one or two combs of brood, in all stages of development, from the parent hive or some other, as but for this no young bees would be hatched out till twenty-one days after the swarm was hived, thus obliging some of the old bees to be always at home, while they might otherwise be gathering honey.

The young bees do not go out to gather honey till they are some ten days old or more. A young bee is easily distinguished from an old one by the merest tyro, as it is much lighter in colour and of a soft and downy appearance.

When a worker bee is hatched in the height of the honey harvest, it rarely lives more than six or seven weeks; it literally dies of overwork. Those hatched later—towards the close of the honey-flow—mostly survive the winter, and live till the beginning of the summer. In queenless hives the bees often live for twelve months, as they do but little work.

### Drones.

Drones pass through the same changes as workers, but they do not hatch out till twenty-four or twenty-five days after the laying of the egg. As I have previously mentioned, the drones are reared in larger cells than the workers; but if the bee-keeper prevents the bees from building any drone comb, the queen will deposit drone eggs in worker cells, and the drones reared in such cells will be much smaller than those reared in full-sized cells. Should a queen mate with one of these small-sized drones, the progeny must necessarily be very small and inferior; and therefore the bee-keeper should make it a rule to have a piece of drone comb at least six inches square in *every* one of his hives. The cappings on drone brood are

extremely convex, and very easy to distinguish from those of worker brood.

Towards the close of the summer, when honey is becoming less plentiful, the workers turn the drones out of the hive, refuse to feed them, and leave them to perish of cold or starvation—the drones being unable to defend themselves, as they possess no sting. A stock of bees which has collected a very large amount of honey will, however, often retain its drones till quite late in the autumn, and I have had large numbers of drones in my hives as late as October.

The drones come out only on fine, warm days, and then generally between the hours of eleven and three.

### The Queen.

The queen bee, as already mentioned, is reared from a worker-egg, placed in a large acorn-shaped cell (fig. 36), and liberally supplied with a very rich food known as “royal jelly.”

It is indeed wonderful that the size and shape of the cell, and the plentiful supply of a rich kind of food should work such a remarkable transformation. True, in the worker bee can be found, by the aid of an extremely powerful microscope, the small abortive ovaries, which in the queen bee are so large and fully developed. But the legs of the queen are quite different from those of the worker, as they are provided with no pollen baskets. Again, in the sting of the queen we see another marvellous modification; for while the sting of the worker has seven distinct barbs, that of the queen has but three, and these barbs are shorter than those on the worker's sting. It is *very* rarely, if ever, that the queen will use her sting, except upon a rival queen: though we may handle her and tease her as much as we like she will not sting. It is said that on the rare occasions when she does sting, it causes but slight pain to the person, compared with that experienced after a sting from a worker.

Should the bees be deprived of their queen by some accident, they can raise another from any worker egg or larva — provided that the latter is not more than three days old. It is, however, much better to obtain a queen raised from the egg on the royal pabulum; and, to ensure this, if we intend to remove a queen from a hive, and let the bees raise another, we should insert a clean, new worker-comb in the hive forty-eight hours

before we remove the queen. We should then examine this comb, and it will probably be found to contain a number of eggs: this being the case, all we have to do is to cut holes in the comb about one inch square amongst the patches of eggs. The bees will then choose the eggs from which they intend to rear queens; and, removing the walls of the adjacent cells, will build queen cells (fig. 36) around the selected eggs. Seven days after the queen was taken away, we must examine the hive, and cut out all queen cells which have been formed in any of the combs, except in the one containing the eggs from which we decided that the bees should rear the queen.

When the larvæ hatch out of these eggs, the bees feed them liberally with the "royal jelly," as previously mentioned, for five days, after which they seal over the cells. Eight days later—*i.e.*, sixteen days after the egg was laid—the queen hatches out. And here, indeed, is a wonderful provision of nature, that the queen—the most important bee in the whole hive—should come to maturity in a considerably shorter time than either the workers or drones.

The queen which hatches out first will fight with the next one which hatches; and the former, being older and stronger, will kill the latter. Some say that the workers destroy all the superfluous queens after the first is hatched out; while others affirm that the queens themselves fight until all are killed but one.

When the queen is about six days old, she will leave the hive to take her marriage trip, queens always mating on the wing. This is another provision of nature to prevent in-and-in breeding; for if she mated in the hive, she must always mate with one of her own brother-drones; and we know that where in-and-in breeding is carried on for any considerable length of time the breed must surely deteriorate, until at last it dies out altogether.

Should the queen fail to meet an admirer on the first day, she will fly on the succeeding days again and again until she does. Bevan says that if not mated till between the fifteenth and twenty-first day, she will be largely a drone-breeder: this, however, is erroneous; as, in the cold, wet summer of 1888, I had a second swarm come off on July 17th, and I saw the queen returning from her marital excursion on August 1st: thus she must have been at least fifteen days old, and probably more, as queens seldom go off with a swarm

till they are two or three days old. Yet this queen did not turn out to be a drone breeder; but, on the contrary, was a very fine and prolific one.\*

It is Huber's opinion that, should the queen not mate by the twenty-first day, the case is hopeless. I should hardly like to fix the limit at twenty-one days, however. The matter undoubtedly requires very careful observation.

About two days after mating, the queen will commence to lay: but should she fail to mate altogether, she will, after a time, begin laying; but although these eggs hatch out, they never produce anything but drones.

Sometimes the young queen may be eaten by a bird while on the wing. The bees will then be deprived of all hope of having eggs laid by a queen bee. In this predicament the great longing for eggs and brood will usually produce in time what are known as "Fertile Workers." These are workers which lay eggs; their eggs—like those of unfertile queens—producing only drones, whether deposited in queen or worker cells. It is usually a considerable time—a month or two—before a hive, deprived of its queen and of all hope of getting one, will develop fertile workers. Their presence may be easily ascertained, for they lay in a most unsystematic manner, often placing two or three eggs in one cell, and missing many empty cells altogether.

A stock with fertile workers will rarely accept a fertile or virgin queen when introduced by either of the caging methods soon to be detailed: they seem quite content with their quasi-queens; but they will generally accept a virgin queen if given by the method of "direct introduction" (soon to be explained), even though they may possess fertile workers. The safest and best plan, however, to get rid of these pests is to unite the bees to another stock which has a queen, and then, should the stock be strong enough, divide it again in two weeks' time, giving the bees either a queen or queen-cell, or else a comb containing eggs from which they will rear one.

Those who wish to make themselves thoroughly acquainted with the natural history of the bee from a very exhaustive and scientific point of view should read "The Honey Bee, its Natural History, Anatomy, and Physiology," by T. W. Cowan, price 2s. 6d.

\* I have had similar cases since then. Some virgin queens were sent to me to South Africa from England in 1907. They were nearly three weeks in the post. Most of them arrived in poor condition or dead, but some others mated and did not in any way prove to be drone breeders.



## CHAPTER II.

### *SWARMS AND SWARMING.*

#### **When Breeding Begins.**

EARLY in January the queen begins to deposit a few eggs in the middle of the combs in the centre of the hive. Very small indeed will be these patches of brood at first, and during January they will not often be appreciably enlarged; but as the spring advances, and the weather becomes warmer, the queen will lay an ever-increasing number of eggs. In March she usually deposits a few drone eggs in the large cells; while, in the early part of April, she will lay a large number of them. Towards the latter part of this month the fruit blossoms commence to open, and from these, in fine weather, the bees gather a large amount of honey.

#### **Swarming.**

About the beginning of May, supposing the spring to have been fine and mild, the hive will become so crowded with brood and honey that only very few cells will be empty. In this state of things the bees will consider the advisability of reducing the population of the hive by swarming. Through their great foresight they have already bred drones, in case they should be required; and so now all that remains to be done is to provide for the production of a new queen for the old hive. They therefore build queen cells on the edges of the combs, and in each of these cells the queen lays an egg. When the queen cells are sealed over is the time when the first swarm usually issues; but, should the weather be unfavourable, it may be delayed for a few days.

#### **Appearance of a Hive before Swarming.**

If the stock be in a straw skep, the bees will most likely hang out in clusters from the alighting-board, and cluster on

the sides of the hive before they swarm ; but in a bar-frame hive they seldom do this, the only sign of the approaching swarm being that a number of bees—probably about a score—will be observed standing about on the alighting-board, for several days before the swarm issues, doing no work whatever. It would appear that a kind of listlessness is prevalent at swarming time amongst the bees, which at other times do not waste a moment.

The day being bright and warm, the bees gorge themselves with honey, and suddenly pour out of the hive in one great stream, and circle round about the hive for a minute or two, the joyful humming of the thousands of bees producing a great noise. In a few minutes they will probably begin to cluster in some bush or tree. The time that they remain after they have settled varies greatly : sometimes they only stay for a few minutes ; sometimes—very seldom—for a day or two. It is not at all certain whether the bees always choose a new home before they swarm, or whether they sometimes do not send out scouts to find one till after the swarm has left the hive. It occasionally happens that the bees make straight for their new home without waiting to cluster ; but it is quite easy to make a swarm settle by directing a shower of water from a common garden syringe so that it will fall on them just like rain ; by this method they can be made to cluster in a few minutes, and thus we never need lose any swarms.

A first swarm usually issues between ten and one o'clock, seldom earlier or later.

Eight or nine days after the first swarm leaves the hive, the first young queen will hatch out. Should the bees determine to send off a second swarm, they will guard the queen cells from her, as her natural instinct would be to kill all her rivals ; and when a day or two old this young queen will lead off a second swarm. A second swarm often contains several young queens hatched out about the same time. When the swarm is hived, the bees will soon kill all but one.

The day following that on which the second swarm issued from the hive, a third swarm or "cast" will sometimes issue ; and this is occasionally followed by a fourth swarm, though this occurs but very seldom.

All these after-swarms are much less particular than first swarms as to the time of day or kind of weather when they issue, as they often come off in the afternoon, and in weather

which would certainly suffice to prevent the issue of a first swarm.

Second swarms and casts contain far fewer bees than first swarms; often they do not gather sufficient honey to last them through the winter, and require to be fed in the autumn.

### Hunger Swarms.

It occasionally happens in the very early spring that bees that are quite destitute of provisions will swarm out of and entirely desert their hives. Such swarms, it is needless to say, unless promptly hived on combs containing stores and carefully fed, will very soon perish. They are known as "hunger swarms."

## CHAPTER III.

### *THE VARIOUS RACES OF BEES.*

#### **The English Bee.**

THIS bee is still considered by many as the most suitable variety for this climate. Owing, however, to the extensive introduction of foreign bees into all parts of the country, it is by no means easy to find this bee in absolute purity, untainted by any admixture of foreign blood, as queens and drones fly over a large area—probably often five or six miles from the hives—in search of a mate.

The English bee is considered more willing than the foreign races to enter supers, and this is indeed a great matter in its favour. It also seals its honey with nice, thick, white cappings—another great advantage. English bees, when compared with some of the foreign bees and hybrids, are by no means difficult to handle; but then, again, they are not nearly so gentle as the Carniolan bees. Altogether, the amateur might do worse than start bee-keeping with English bees.

#### **The Ligurian or Italian Alp Bee.**

THIS bee has been imported into this country in greater numbers, perhaps, than any other foreign race. It is easily distinguished from the English bee, as the workers possess three beautiful, golden-coloured bands on the abdomen. The tongue of the Ligurian bee is longer than that of the brown bee, and consequently it can gather honey—or rather nectar—from flowers on which the latter is unable to work.

Almost all who have kept these bees agree that they are much more gentle and better honey-gatherers than English bees, that the queens are considerably more prolific, and that the bees—at any rate in this country—are proof against the ravages of the wax moth.

Ligurians seal their honey with thinner cappings than do our native bees, and their comb honey is therefore not quite so

white, in consequence of which some consider them unsuitable for the production of comb honey. Syrians and Cyprians also seal their honey with thin cappings.

### The Carniolan Bee.

This beautiful and gentle race has, of late years, been largely imported into this country. At first everybody was delighted with them; but after a time complaints began to be made that they were excessive swarmers. Doubtless much of the blame is to be attached to bad management.

Amongst the many good points possessed by Carniolans may be mentioned,—

1. That they are early swarmers.
2. That their comb honey is of spotless purity and whiteness, even excelling that of our native brown bees.
3. That they are exceedingly gentle, and in most cases can be handled without any intimidation—treatment which English bees would undoubtedly resent.
4. That the queens are very prolific.
5. That they are very industrious and hardy bees.
6. That they are, perhaps, the best winterers of any race whatever.

I admit that the bees are inclined to swarm, but I have failed entirely to notice that excessive swarming of which so many complain. With me a stock of Carniolans generally sends out two swarms.

In the production of comb honey it is, perhaps, the best policy to give them twelve or fourteen frames, and when they swarm to hive them on six frames—three of brood from the old stock, and three of empty, drawn-out comb—placing the new hive where the old stock stood, the latter being removed some distance. A super should be placed on the swarm; and in a few days, when the bees are well at work in it, two or three more frames may be given in the brood chamber: a week later one or two more should be given, according to the strength of the colony.

To the amateur just starting bee-keeping I would not, however, recommend Carniolans. Any one wishing to try the foreign races should commence with only one or two stocks at most; and when he finds them superior to his other bees will be time to obtain more.

### The Syrian Bee.

Concerning these bees there is great divergence of opinion, some affirming that they are so vicious as to be quite unmanageable, while others say that they can be handled like flies. The same things are also stated concerning Cyprians and Palestines. Now, what is the meaning of this incongruity? The reason, I think, is not far to seek. Amongst a dozen stocks of English bees we shall find some which are so vicious as, at times, to be almost unmanageable, while others are so gentle that we can handle them with but very little intimidation. The same thing may undoubtedly be said of the foreign races; and a person obtaining one—or perhaps two—Syrian, Cyprian or Palestine queens, which happen to produce vicious bees, immediately condemns the whole race as bad-tempered and unmanageable; while another man, getting his queens from a different source, obtains workers which are gentle and easily handled. Hence the folly of forming a judgment concerning a race from one or two solitary instances.

The Syrian queens are more prolific than any other variety, and the number of eggs which one of these queens lays will fairly astonish any one who has only been accustomed to English bees.

The workers are very much like Italians, but the undersides of their abdomens are yellower.

### The Cyprian Bee.

These bees closely resemble Ligurians and Syrians in colour.

The queens are more prolific than those of any other race, Syrians alone excepted.

These bees are said to be better honey-gatherers than any others; but, never having kept them, I am unable to speak from experience.

### The South African Bee.

In South Africa the two varieties of honey bee generally met with are a small, darkish bee in the Karoo and higher parts of the inland districts, which, although an excellent honey gatherer, is very fierce.

Along the coast-line another variety is met with. This bee, although smaller than a Ligurian or Carniolan, is yet a good deal larger than the Karoo bee. The abdomens of the workers are covered with light grey hairs, and in most cases have one

dark orange band. These bees are good honey gatherers, and the queens are exceedingly prolific. They are the gentlest bees to handle I have ever met with. The workers, like the worker bees found in Dalmatia, have a habit of sometimes playing around the entrances of the hives like a swarm of flies in the late afternoons. On being deprived of their queens they often produce fertile workers within a few days, which is a troublesome habit. Also they seal their comb honey with as thin cappings as do the Italians. On the whole, therefore, I find them best crossed with Carniolans.

### **Crossbred Bees. Italian Hybrids.**

These bees—the progeny of an Italian queen crossed with an English drone—are very bad-tempered as a rule, and so are not to be recommended to the novice, although they are good honey-gatherers. The same may be said of Carniolan hybrids. But an English queen crossed with a Ligurian or Carniolan drone will produce gentle workers, which may be easily handled, and are also good honey-gatherers.

### **The Syrio-Carniolan Bee.**

This cross—a Syrian queen with a Carniolan drone—is a very desirable one, for by it we secure the marvellous fecundity of the Syrian queen, together with the docility and splendid wintering qualities of the Carniolans.

Syrio-Carniolans are grand honey-gatherers and splendid winterers, and seal their honey with beautifully white cappings. They are, in fact, to my mind, model bees.

### **The “Golden Italian” Bee.**

These bees, which are not pure Italians, but are slightly hybridised with the English bee, are now very commonly offered for sale both in England and America. In appearance they are very handsome, the abdomens being much yellower than in the ordinary Italians. They are the result of careful selection and of breeding for many generations past from the most brightly coloured colonies, and from those in which the workers have the largest number of yellow bands on the abdomen; but apart from their very handsome appearance, they do not seem to be in any way superior to ordinary Italians.

## CHAPTER IV.

### HIVES.

#### The Straw Skep.

THE straw skep (fig. 4a) is a bell-shaped hive made of straw, in which the bees can build their combs in any way they like, fastening them to the roof and sides. Thus the combs cannot be taken from a skep for examination, and it is consequently called a "fixed-comb" hive. In this particular it differs greatly from the "movable-comb" or "bar-frame" hive, for in the latter every comb can be removed for examination and returned to



Fig. 4a.—Straw Skep.

the hive with little disturbance to the bees.

#### The Bar-frame Hive.

In the bar-frame hive each separate comb is built in a frame (fig. 5) like a box without top or bottom.

The British Bee-keepers' Association has fixed the size of the "standard" frame at 14 inches long by  $8\frac{1}{2}$  inches deep, the top bar 17 inches long by  $\frac{3}{8}$  inch thick, the side bars  $\frac{1}{4}$  inch thick, the bottom bar  $\frac{1}{8}$  inch thick, the top and side bars  $\frac{7}{8}$  inch wide, the bottom bar  $\frac{7}{8}$  inch wide. This is the frame now in general use.

The frames hang in the body hive, the ends of the top bars resting on the inner walls, a space of  $\frac{1}{4}$  inch being left between the side bars of the frames and the hive's walls. Each frame should also hang  $\frac{3}{8}$  inch or  $\frac{1}{2}$  inch clear of the floor-board (fig. 6).

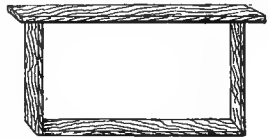

Fig. 5.—Bar-frame.



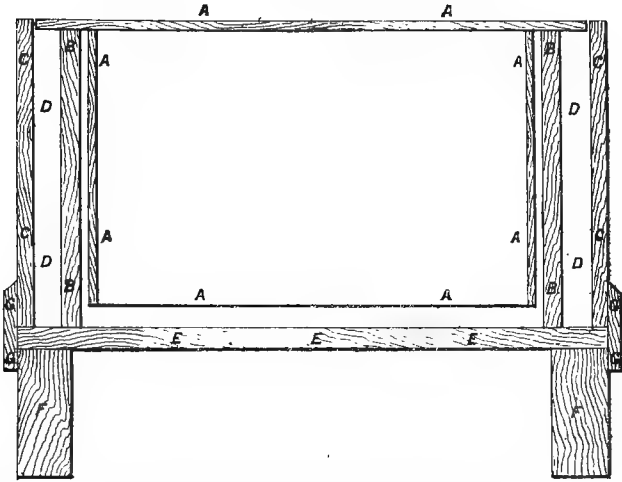

Fig. 6.—(a) Section of Frame Hive, seen from front or entrance (frames running parallel to entrance). A, Bars of frame; B, Inner walls of hive; C, Outer walls of hive; D, Space between inner and outer walls; E, Floor-board; F, Stand; G, Plinths.

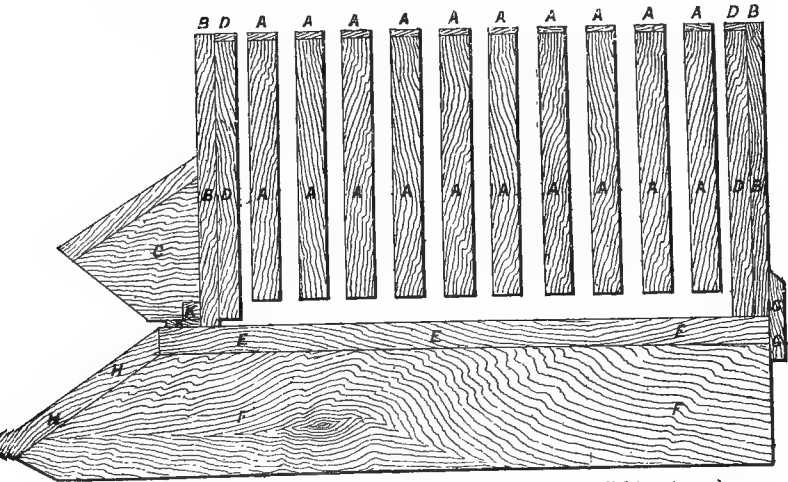

Fig. 6.—(b) Section of Frame Hive, seen from side (frames running parallel to entrance). A, Bars of frame; B, Front and back walls of hive; C, Porch; D, Dummy-boards; E, Floor-board; F, Stand; G, Plinth; H, Alighting-board; K, Entrance-contractor.

The frames should be spaced  $1\frac{1}{2}$  inch from the centre of one frame to the centre of the other. This may be done by means of "metal ends"  $1\frac{1}{2}$  inch broad (fig. 7), which are placed on the ends of the top bars, the knife-edge A holding

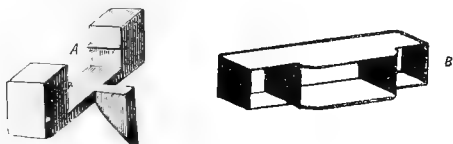

Fig. 7.—Metal Ends. A, The Old-fashioned Metal End. B, The "W. B. Carr" Metal End now more generally used.

the end firmly on to the bar; but the eye of the bee-keeper soon gets accustomed to the distance which the frames should be spaced apart, and he will not need to use metal ends. There are many other ways of spacing the frames: some use staples



Fig. 8.—Broad-shouldered Top Bar with Saw-cut for Foundation.

driven into the top bar; others use frames with "broad-shouldered" top bars (fig. 8); but I myself prefer a plain frame to any.

### The Floor-board.

The floor-board (fig. 9) should be made of wood not less than  $\frac{3}{4}$  inch in thickness—1 inch is better: it should project

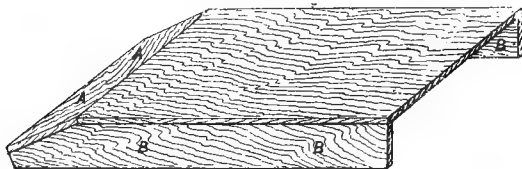

Fig. 9 — Floor-board and Alighting-board.

$1\frac{1}{2}$  inch beyond the entrance, and a sloping alighting-board, A, 7 inches or 9 inches broad, should be fixed at the end of it. The floor and alighting-boards should be nailed on to the stand B B, which should be 4 inches or 6 inches wide and made of 1-inch or  $1\frac{1}{2}$ -inch wood, the latter thickness being best.

### The Body Hive.

The body hive (fig. 10) should be 9 inches deep. The frames may run either at right angles to the entrance (as in the figure) or parallel to it. The inner walls, on which the

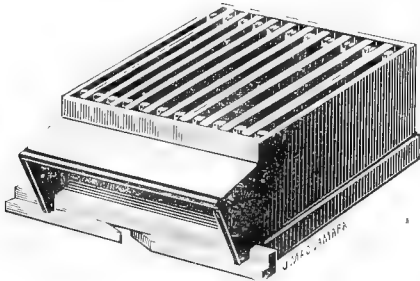

Fig. 10.—Body-box of Beehive.

ends of the frames rest, should be  $8\frac{1}{2}$  inches deep; for a ten-frame hive they should be 15 inches long; for a twelve-frame hive 18 inches: they must be placed  $14\frac{1}{2}$  inches apart, so that there may be  $\frac{1}{4}$  inch between the sides of the frames and the hive's walls.

### The Entrance.

The entrance (fig. 11, c) should be 8 inches or 9 inches long, and  $\frac{1}{2}$  inch deep. A hive should be provided with some

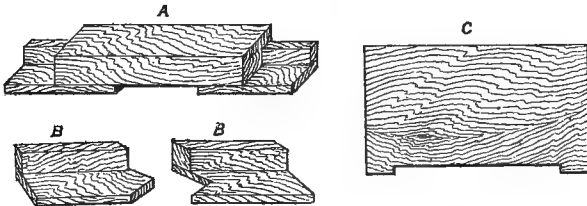

Fig. 11.—A, Grooved piece of wood, in which Entrance-contractors (B B) run. c, Front of Hive, showing Entrance.

means of contracting the entrance. Fig. 11 shows a very good kind of entrance-contractor, B B, which fits into a piece of wood, A, provided with a groove and fixed to the front of the hive.

### The Porch.

A hive must be provided with a porch [fig. 6 ( $\beta$ ), C] to keep off the drip which falls from the roof upon the entrance when it rains.

### The Dummy or Division-board.

Every hive should be fitted with a dummy-board, or, better still, two (fig. 12): they are used to partition off a portion of

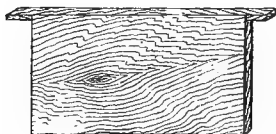

Fig. 12 --Dummy or Division-board.

the hive when the bees do not occupy the whole of it. They should be made of  $\frac{1}{2}$ -inch or  $\frac{3}{4}$  inch wood,  $14\frac{1}{2}$  inches by 9 inches, with ears  $\frac{1}{2}$  inch broad and  $1\frac{1}{4}$  inch long at the top.

### The Roof.

I prefer a roof sufficiently deep to cover a crate of sections—*i.e.*, 5 inches high to the eaves, as in fig. 13. It should be 9 inches or 10 inches high to the ridge, and the board along the ridge **A** should be about  $4\frac{1}{2}$  inches wide. Such a board is

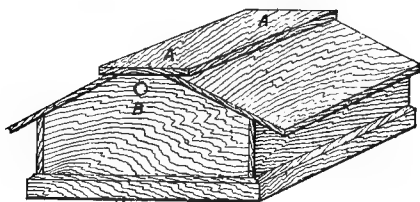

Fig. 13.—Hive Roof

exceedingly convenient, as, when the hives are placed in a row it serves as a stand for the smoker, uncapping-knife, or other implement required while we are manipulating the adjacent hive.

A round hole, **B**, 1 inch in diameter, should be bored at

each end of the roof for ventilation, and covered with a square of perforated zinc on the inside, to prevent the bees escaping from the hive, or robber bees entering it. A better plan, however, is to cover this hole *on the outside* with a cone-shaped bee escape (fig. 14*b*), which allows any bees accidentally imprisoned during a manipulation to escape.

The roof and body hive must both be provided with plinths—the former all round, the latter on all sides except that in which is the entrance.

### Position of Frames.

We now come to the question, Shall the frames run parallel to the entrance, or at right angles to it? There are many advocates of both systems, each claiming great advantages for the one he prefers; but, after all, there is little to choose between them, and one is about as good as the other. A hive in which the frames run parallel to the entrance is known as a “Combination Hive”; and this kind is, perhaps, rather warmer than one having the frames running at right angles to the entrance. In a hive of more than ten or twelve-frame capacity—*i.e.*, one more than 18 inches long—the frames should always run parallel to the entrance, as otherwise they would be awkward to manipulate, and the hive would present an exceedingly clumsy appearance to the eye.

### The Size of the Hive.

The size of the hive, or how many frames it shall hold, is a very important point. For general use, a hive made to take ten frames and two  $\frac{3}{4}$ -inch dummies—*i.e.*, a hive  $16\frac{1}{2}$  inches long inside—will be found the most serviceable, as, when the dummy-boards are removed, and the frames spaced close together— $1\frac{1}{4}$  inch from centre to centre—the hive will take thirteen frames if need be, or twelve quite easily. If we keep Carniolan or Syrian bees, a hive to take fifteen or eighteen frames—*i.e.*, one  $22\frac{1}{2}$  inches or 27 inches long—may possess some advantages over a hive only  $16\frac{1}{2}$  inches in length; but the fifteen or eighteen-frame hives are very bulky and unwieldy things, and most bee-keepers will prefer a ten-frame hive.

### Doubling-boxes.

Each hive must be provided with a doubling-box, whether we wish to produce comb or extracted honey. A doubling-box is very much like the body-box of a hive, only it has no porch or entrance. The inner walls, on which the ends of the frames rest, should be made as shown in fig. 14, A, so as to slide into grooved pieces of wood (fig. 14, B), which are nailed on the inside of the doubling-box. By this means we may remove the inner walls when we wish to tier up crates of sections on the hives. The doubling-box being 9 inches deep will accommodate two crates of sections one on the top of the other; and if the roof be made 5 inches deep to the eaves, as previously advised, we can have three crates of sections on the hive at the same time—as many as are needed when working for comb honey.

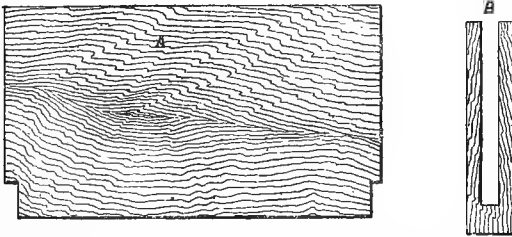

Fig. 14.—A, Inner walls of Doubling-box, showing slot which slides in the grooved pieces of wood (B), nailed to outer walls.

If we intend to work for “run” or “extracted” honey, we shall require two doubling-boxes to each ten-frame hive.

Almost every manufacturer has his own particular kind of hive, for which he claims special advantages; but the tyro should always buy a hive from one of the best firms, who have had much experience, and he will then obtain a well-finished article of accurate workmanship, instead of a cheap and, unfortunately, often badly finished hive, made of unseasoned wood, which will soon crack and warp, and cause endless annoyance through the different parts not fitting well. The amateur would soon repent his purchase of such an article, and wish that he had paid a little more for his hives until he gained experience in selecting the kind most adapted to his particular requirements.

### The Quilt.

In order to prevent the bees from getting into the roof and there building comb, which they would otherwise do, a quilt is placed over the frames. This quilt should be the exact size of the inside of the hive, and may be made of carpet, felt, American cloth, etc.

In summer three such quilts will be sufficient to maintain the necessary warmth; but in winter there should be at least four thicknesses of carpet or else plenty of newspapers placed on the top of the quilt to maintain the heat.

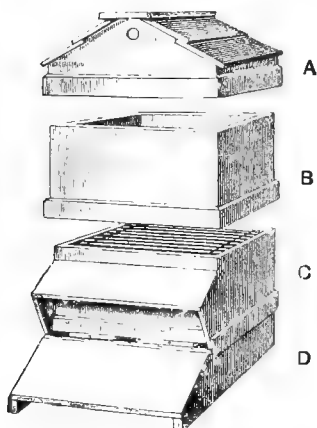

Fig. 14a.—The Bar Frame Hive complete.  
A, Roof; B, Doubling Box; C, Body Box; D, Floor Board, Alighting Board, and Stand.



Fig. 14b.  
Cone-shaped  
Escape.

### Home-Made Hives.

Any handy man, having in the first instance bought a good bar-frame hive as a pattern, will be able to make excellent hives in his spare time out of packing cases, which he can buy at very little cost, and in these days of high prices the saving thus effected is considerable.

## CHAPTER V.

### *HOW TO MAKE A START IN BEE-KEEPING.*

How often are failure and disappointment in bee-keeping brought about by a bad start!

If the would-be apiarist has a friend who keeps bees, he should obtain his advice as to purchasing a stock. A very good start can be made with one or two strong stocks of bees in skeps, which can easily be obtained from some cottage bee-keeper in the neighbourhood. The beginning of April is the best time to purchase them. The tyro should get his friend to inspect the bees and to tell him if the stocks are strong and in good condition before he purchases. Preference should be given to stocks which have swarmed the previous summer, as they would be sure to have young queens.

But should the novice have no friend who keeps bees, he had better not buy stocks in skeps, as they may turn out to be weak, and do but little work all the summer. It would be better to buy a first swarm in May from a straw skep, the price usually asked being about ten shillings.\*

In moving an old stock in April it should be borne in mind that, if moved less than a mile and a half or two miles, many of the old bees will go back to the place where they used to be. But the bees of a swarm, whether hived only a few feet or several miles from the parent hive, mark the position of their new home, and do not return to their old hive.

Supposing that the amateur has obtained a stock of bees in a straw skep, he will need a bar-frame hive to put the expected swarm in; or, if he has bought a swarm, one will be required for it; and, if half-a-dozen frames of empty comb are available, there is a very fair chance of obtaining some honey from a strong, early swarm. In this case a division-board should be placed on each side of the frames, to keep the bees out of the rest of the hive, and a crate of sections should be placed on the top of the frames; in a week or ten days a fresh

\* Since the war the average price for first swarms has increased to about forty shillings.



crate may be placed under the first one ; and should both these be filled with honey, the tyro may think himself fortunate. For this purpose a divisional super (fig. 15), with the rows of sections in separate racks, is very convenient, as two rows fit over six frames.

Empty combs may be fitted into the frames, and a couple of pieces of tape tied round each frame will make all secure : in a few days, when the bees have fastened up the combs, the tapes may be cut and removed.

If no empty combs are to be had, it will be best to hive the

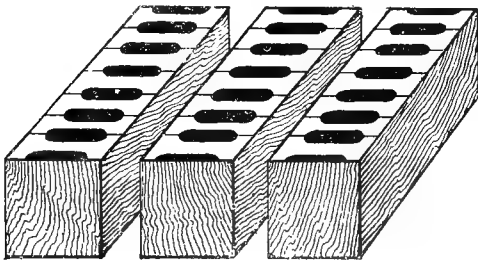

Fig. 15.—Divisional Super.

swarm on ten frames, fitted with full sheets of foundation, which should be “wired” by the process soon to be explained. At the close of the season we may obtain some extracted honey from such a swarm, but to obtain comb honey in quantity would require a very good season and an exceptionally strong swarm.

A second swarm hived on six or seven frames fitted with empty comb will usually gather sufficient honey to last it for the winter ; but if hived on frames only fitted with foundation, a little feeding may be necessary in the autumn to supplement its natural stores.

### How to Hive a Swarm.

How to hive a swarm when we have got one is the next question which naturally presents itself to the reader’s mind.

The swarm, after issuing from the hive and circling about in the air for a few minutes, will begin to settle in some neighbouring tree or bush. While the bees are clustering, see that the

hive intended for their reception is got ready. Between the alighting-board and the ground place a large board or a cloth, and wedge up the front of the hive with a stone, so as to form an entrance the whole width of the hive and at least  $\frac{1}{2}$  inch deep. As soon as the bees are fairly settled (which they may be made to do more quickly by directing a shower of water from a garden syringe so as to fall like a shower of rain on those in the air), take a straw skep and hold it inverted just under the swarm. Now grasp the branch or limb of the tree on which the bees have settled, and give it a sudden, sharp jerk, which will throw them all off the tree and into the skep. Next carry the inverted skep to the new hive, and gently turn it over, holding it firmly with both hands; slowly lower it till it almost touches the board or cloth which has been placed between the ground and the alighting-board of the hive; then suddenly lift it about 18 inches, and lower it again with a sharp jerk, which will have the effect of throwing almost all the bees out on the board or cloth: a few of them will rise in the air, but before many minutes they will all enter their new home. Should we only have hived a portion of the swarm, and the queen be amongst the remainder, the bees will not stay in their new home more than a few minutes: as soon, therefore, as we have thrown the first lot of bees out of the skep on to the board, we must go back and secure the remainder of the swarm, which will most probably have clustered again by this time. As soon as all the bees are in, the stone which wedges up the front of the hive should be removed. Sometimes bees settle in very awkward positions, such as a fence or a thick, low bush. In such cases we may hold the skep above them, and drive them up into it with smoke; or spread a sheet on the ground, and shake them on to it.

Bees when swarming, being gorged with honey, will not sting unless absolutely crushed or hurt; so we may easily hive a swarm without fear of being stung.

### Foundation.

It may here be as well to inform the reader what foundation is, and how it is used.

Foundation (fig. 16) is beeswax made into thin sheets, on which the bases of the cells of honeycomb and the basement of the side walls are imprinted by metal rollers: the bees rapidly

draw out these side walls when the foundation is given them. In some foundation the bases of the cells are made flat; hence it is known as "flat-bottomed foundation": it is used principally in supers, but the bees do not seem to take to it so readily as to the natural-based sort, and so, though it can be rolled somewhat thinner, it is not to be recommended to the tyro.

Foundation for the stock hive is now usually made in two thicknesses, the first being that most generally used, of which about six sheets cut for use in the standard frame weigh

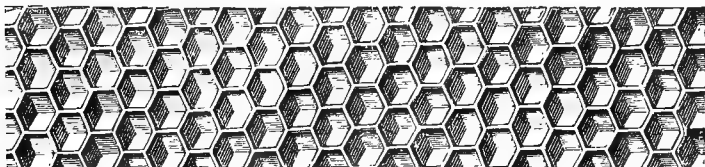

Fig. 16.—Comb Foundation.

one pound, and the second and thinner foundation intended for wiring into frames, about nine sheets of which go to the pound. The advantages of wiring foundation into the frames are very great, as we thereby obtain perfectly straight combs, and can use a thinner make of foundation, which, though a little dearer by the pound, is much cheaper in use when we consider the extra number of sheets in the pound. For extracting, too, wired frames are invaluable, owing to the extra strength given to the combs by the wires which run through them. I have had beautifully straight combs built in the brood nests of hives in wired frames filled with foundation so thin that sixteen sheets went to the pound.

### Why Foundation is used.

Why we should use foundation instead of letting bees build comb for themselves unaided is the question which will probably occur to the reader's mind.

The two principal reasons are that bees take a long time to build comb and use a good deal of honey in doing it—though they do not use nearly so much as was thought at one time, as Simmins and others have clearly demonstrated. Simmins states that  $6\frac{2}{5}$  lbs. of honey are consumed in producing

1 lb. of wax. The most important consideration, however, is the loss of time. On the under-side of the abdomen of the worker bee are eight wax pockets in which the wax is secreted; and as, to secrete wax rapidly and in quantity, bees apparently need perfect rest, when building comb they hang in clusters or festoons within the hive: in this way much valuable time is often lost just at the very height of the honey flow.

It must be understood that, were we to hive a swarm in a bar-frame hive, and leave the bees entirely to their own devices, the result would be that they would build their combs across the hive in all directions, joining one comb to two or three frames, and making it quite impossible for the frames to be separately removed. It is therefore absolutely imperative that a strip of foundation, at least  $\frac{1}{2}$  inch deep, should be fitted along the centre of the top bar of every frame: this will act as a guide from which the bees will draw out their combs.

### How to fix Foundation in Frames.

Frames are almost always now made with a saw-cut down the middle of the top bar, and this saw-cut is intended for fixing the foundation in. If a screwdriver is inserted in it, and the handle turned round slightly so as to hold the cut open, the foundation may be slipped into the cut, and, the screwdriver being withdrawn, it will be held firmly in its place: a little melted wax run along the bar just at its junction with the foundation will make all secure.

In heating beeswax great care must be taken that it does not burn, to avoid which it should be placed in a vessel, and this vessel placed in another of boiling water. An ordinary glue-pot is a very good article to heat beeswax in.

### Wiring Foundation into Frames.

A thin description of tinned wire is the best for wiring foundation with: it may be obtained from most of the dealers in bee appliances. Along the centre of each side bar of a frame bore two small holes with a bradawl, about two inches from the top and bottom bars, and draw the wire through these holes as shown in fig. 17. Now get a board  $\frac{3}{8}$  inch thick and the same size as the inside of your frame; keep this board damp, so that the foundation may not stick to it, and lay it flat on

the table, fitting the frame over it; insert the sheet of foundation in the saw-cut, and then over the foundation draw two more wires crosswise, as in fig. 18. To imbed the wires in the foundation I have found nothing better than a large bradawl or

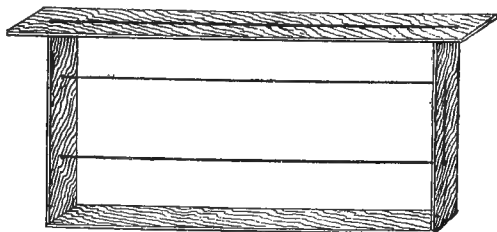

Fig. 17.—Frame wired and prepared for fixing Foundation in.

small screwdriver, out of the edge of which a large  $\Lambda$ -shaped piece has been filed. It must be heated in the fire or in a jug of boiling water, and when many frames are being wired it will be found best to have two at hand, so that one may be heating while the other is in use. Place the edge of the

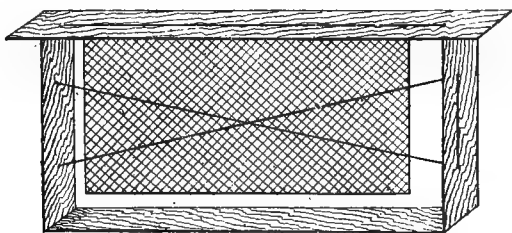

Fig. 18.—Frame fitted with sheet of Foundation, wired in.

instrument so that the  $\Lambda$ -shaped part fits over the wire; then run it rapidly along the whole length of the wire; if it be done too slowly, it will burn holes in the foundation; if too rapidly, it will not melt the wax sufficiently to make it hold firmly to the wire.

Metal foundation and metal honeycomb, made of aluminium, have recently been introduced, but although, on account of their strength, they offer some advantages to the bee-keeper who works his hives for extracted honey, the beginner will find it best to use, at first, the ordinary old-fashioned foundation made of beeswax.

## CHAPTER VI.

### *MANIPULATING BEES.*

How many are deterred from keeping bees simply by the fear of being stung! And though I do not pretend that the amateur will never get a sting, I must say that this bugbear of stings is greatly overrated by those who are not accustomed to manage bees. In handling bees quietness and confidence are quite indispensable—never be in a hurry when you are manipulating, for the old proverb, “More haste, worse speed,” is very true with regard to bees, as any sceptical person may soon demonstrate to his own satisfaction (?). It may be some consolation to the intending bee-keeper to know, that the oftener he is stung the less annoyance will each subsequent sting occasion him. At first they swell a great deal and cause much pain and irritation; but after a time the swelling becomes less and less, until a sting only causes a little temporary pain, and no swelling whatever takes place. It would appear that the person becomes inoculated with the poison (formic acid).

#### **What to Do when Stung during a Manipulation.**

When stung during a manipulation, the operator should retire a few yards from the hive (as the smell of the poison irritates the bees extremely), and should at once pull out the sting—taking care not to press the poison-bag, thereby emptying its contents into the part stung. The back of the nail or a knife is a good thing with which to extract a sting. A little smoke blown on to the place will help to hide the smell from the bees. Much relief will often be experienced by bathing the sting in a mixture composed of one teaspoonful of ammonia to a pint of water; and if the hands are dipped in this just before a manipulation, care being taken to apply it to the wrists also, it will act as a very good sting preventive, the hands being again dipped in it if they get dry during a long manipulation.

Another good sting preventive is Grimshaw's "Apifuge," a few drops of which should be rubbed over the hands and wrists. The peculiar smell of "Apifuge," which some find disagreeable, is a disadvantage in its use. The smell of ammonia, however, very quickly passes off.

The sting having been extracted, and a little smoke blown upon the place—or a drop of "Apifuge" will do—the operator may go back to the hive, and proceed with his manipulation.

### Bee-veils.

To protect the face a bee-veil (fig. 19) should always be worn. It may be made of black net or leno, like **A** in fig. 19 ;

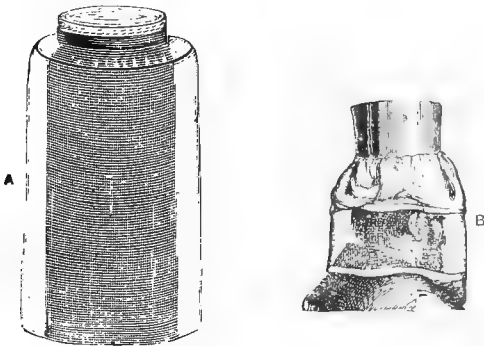

Fig. 19.—Bee veils. **A**, Net Veil. **B**, Wire and Net Veil.

but perhaps the best veil of all is that represented in fig. 19, **B**, consisting of a band of leno or black net at the top, with an elastic to make it fit close round the hat over which it is to be worn, the next band being made of fine wire net, ten or twelve meshes to the inch, and the third band, which should be tucked underneath the coat, of leno or black net. The great advantage possessed by this description of veil is that the wire stands clear of the face and head, gives perfect ventilation, and is very easy to see through.

### Gloves.

Gloves seem to be particularly obnoxious to bees, which sting them on all occasions ; and unless they are made so thick and

clumsy as to make it next to impossible to perform a delicate manipulation while wearing them, bees *will* sting through them. The bee-keeper will receive far fewer stings, and be able to manipulate with much greater comfort, if he will make up his mind to discard gloves as useless bee-gear.

### Gorging the Bees.

We have already seen that bees when swarming are not at all inclined to sting, because they are gorged with honey. If, therefore, we can make the bees in a hive gorge themselves, they will be as harmless as those in a swarm. We can accomplish this in several ways; for, taking advantage of the fact that bees, when frightened, immediately go to the unsealed cells of honey and gorge themselves, we have only to rap on the outside of a hive (having closed the entrance with perforated zinc), introduce the fumes of carbolic acid, or blow smoke into a hive, and the bees will be so much frightened that they will at once fill themselves with honey, and in a minute or two we can remove the quilts and perform the desired manipulation.

### Smoking.

Of the three methods just mentioned, that of blowing smoke into the hive finds the most general acceptance, and it is indeed by far the most convenient.

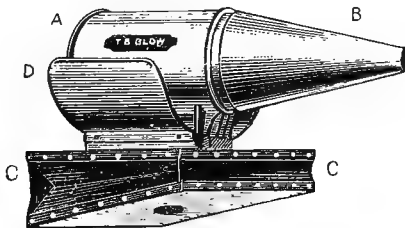

Fig. 20.—Smoker: A, Cylinder for fuel; B, Removable Nozzle; c, Bellows; D, Hand guard.

For this purpose a smoker (fig. 20) is used. It consists of a tin cylinder, A, in which the fuel is placed, a cone-shaped funnel, B, which is removable to allow of the fuel being put in, and a pair of bellows, c, to create the draught by which the



fuel in **A** is kept alight. Most smokers are provided with a hand-guard, **D**, to prevent the operator from burning his hands. Brown paper is a very good description of fuel to use ; it should be rolled up loosely, lighted, and placed in the cylinder, **A**—lighted side downwards. Sacking, old corduroy, hemp-carpet, etc., may also be used as fuel for a smoker.

When not being used during a manipulation, the smoker should be stood upright, so that the contents may stay alight.

### How to Manipulate.

The operator, having put on his bee-veil, and got his smoker well alight, proceeds to the hive and takes off the roof. A corner of the quilt is then raised, and the nozzle of the smoker placed underneath, and slowly drawn along the ends of the frames underneath the quilt, the bellows being kept working, so as to blow the smoke into the hive. Next, a corner of the quilt at the other side of the hive is raised, and smoke introduced at the other ends of the frames ; thus every seam of bees is smoked. A little smoke may also be blown in at the hive's entrance.

Having given the bees a minute or so to gorge, the quilt is slowly rolled back, smoke being very gently blown along the top bars to keep the bees down. The quilt is only moved off two or three frames at first. The operator then moves the division-board two or three inches back, and gently takes out the frame next to it, taking care not to jar it by any sudden jerk, which would anger the bees. The frame, having been examined, is replaced in the hive close against the division-board ; and the next frame is taken out, examined, and replaced close against the first one. The remaining frames are similarly treated. The great advantage of moving back the dummy-board is, that when a frame is returned to the hive, it has not got to be wedged in between the two other frames standing close together, which invariably irritates the bees, owing to the brushing of the bees and combs against each other. The manipulation being completed, the frames are moved forward again, as is also the dummy-board.

### Manipulating a Full Hive.

When a hive is quite full of combs, it would be impossible to move the dummy back. In this case the frame next to one side

of the hive should be removed and examined, but not returned. The next frame should then be examined and replaced next the side of the hive whence the first comb was taken. The third frame, after being examined, should be returned to where the second frame had been; and similarly with the remaining frames. By this plan, when all the frames have been examined and replaced, there will be just room for one more between the last frame and the side of the hive; and here the comb which was taken out first, but not replaced, should be put.

### Quieting Bees with Carbolic Acid.

As carbolic acid is a strong poison, it must be used with care. In a quart of warm water mix one ounce of Calvert's No. 5 carbolic acid and one ounce of glycerine. A piece of calico should be steeped in this, and then wrung out dry. The operator then goes to the hive, and, as he rolls back the quilt, places the calico over the frames. Under this treatment the bees rapidly descend from the top portion of the combs, which enables one to manipulate the frames with greater comfort. Care must be taken that the solution is well mixed before using it.

The very strong and disagreeable smell possessed by carbolic acid is an objection to its use; and, although it is a powerful disinfectant, most bee-keepers will prefer to use smoke when manipulating.

## CHAPTER VII.

### *THE PRODUCTION OF COMB HONEY.*

THE apiarist, taking advantage of the fact that bees store honey above their brood, places chambers above the stock hive for the bees to store their honey in, which are hence called supers.

#### Sections.

Comb honey is now almost entirely produced in American one-piece sections (fig. 21) which have quite superseded the



Fig. 21.—American one-piece Section (two Bee-way).

large old-fashioned supers. Amongst other advantages which they possess over large supers, the following may be mentioned:

1. They are easier to produce.
2. They are more saleable.
3. They are very neat and attractive in appearance.
4. Being smaller, they are consequently stronger, and therefore may be sent safely long distances by rail if properly packed.

Sections are always sold in the flat; they are dovetailed at the ends, and the joints are grooved in the shape of a V. Before folding, these joints should be damped to toughen them, as otherwise they are very apt to break: the damping can easily be done with a small, wet sponge, or where a large number are being folded they may be stood upright, and a gentle stream of warm water poured between the joints from a can. To fold a section, the sides should be gently drawn at

right angles to each other, and then the dovetailed ends may be closed down with a knock from a mallet.

Each section must be fitted with a guide of foundation, which should be cut in the form of an equilateral triangle, with the sides about  $1\frac{1}{2}$  inch to 2 inches long. To fix this into the section a block is cut (the size of the inside of the section and  $\frac{1}{16}$  less than half its width), over which the section is placed, and the foundation laid on the block close against the side of the section; a little melted beeswax is run along the junction of the foundation with the side of the section; the section is then turned over and the process repeated, the foundation being by this means fixed very firmly.

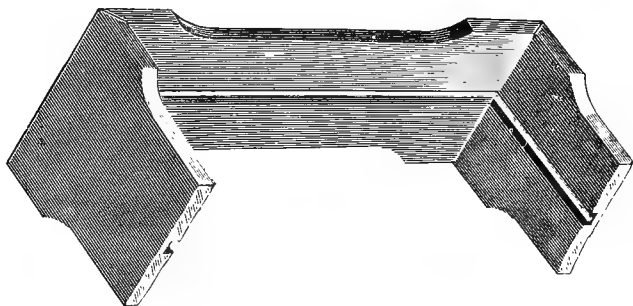

Fig. 22 — Taylor's Patent Grooved Section

By using full sheets of foundation in sections "pop-holes" are avoided; and the combs being built close up to the sides, much finer and better-finished sections are secured. A section made expressly to take full sheets of foundation is made by Messrs. Lee & Sons, of Uxbridge, Middlesex: it has the top bar split through, and a groove running all round the three other sides. The section is folded, all except one division of the top bar, which is left open; a sheet of foundation is cut with a die to the exact size, and then slipped into the groove, and the other division of the top bar is closed down. A little melted beeswax run along the top bar will make all secure.

Messrs. Taylor, of Welwyn, make a section (fig. 22) very similar to that just described. This section is grooved on all sides, and is neater than Messrs. Lee's, as the top bar is not

split through. It is folded in a section block (fig. 23, A); but before the top bar is fixed down, the sheet of foundation is slipped into a groove. The foundation should be secured to the top bar with melted beeswax.

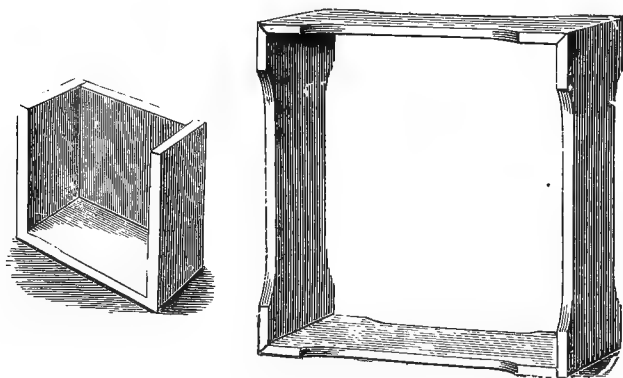

Fig. 23.—A, Section Block; B, Four Bee-way Section.

### The Size of the Sections.

The one-pound sections now in general use are  $4\frac{1}{4}$  inches square outside, and are made of bass wood  $\frac{1}{8}$  inch thick; they are made in two widths—viz.,  $1\frac{1}{2}$  inch and 2 inches—of which the  $1\frac{1}{2}$  inch are perhaps the best for commercial purposes, though the 2-inch sections present a more solid and substantial appearance to the eye.

The two-pound sections most used are  $6\frac{1}{4}$  inches by  $5\frac{1}{4}$  inches outside.

Some sections have “bee-ways” cut on two sides, as in fig. 21, and some on four, as in fig. 23, B: they are hence known as “two-way” and “four-way” sections respectively.

### Section Crates.

Sections are worked in crates (fig. 24, A) placed above the frames of a hive, and also occasionally in frames (fig. 24, B) which are placed at the sides of the hive and divided from the brood nest by a dummy of “queen-excluding” zinc (fig. 24, C) the holes in which are of such a size as to prevent the queens and drones from passing through them, while workers go

through without difficulty. Sections worked in frames are seldom so well finished or so white as those produced in crates; and so it is only in districts where little honey is to be got, or in bad seasons when it is difficult to get the bees to enter supers, that it is advisable to use them. Some bee-keepers give the bees a

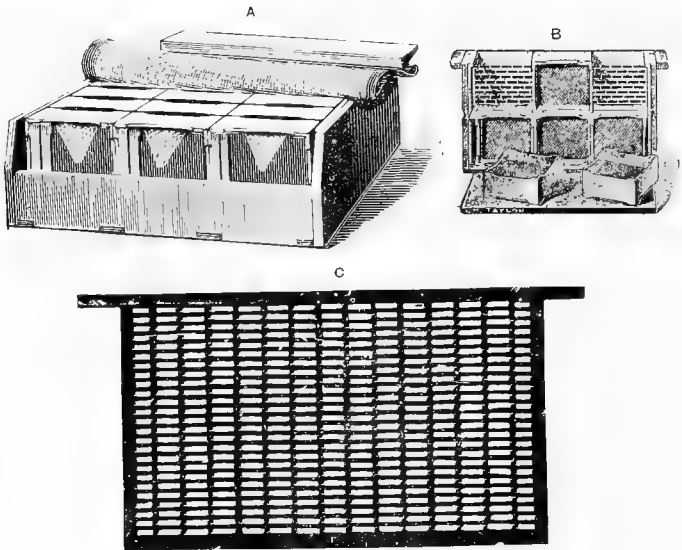

Fig. 24.—A, Section Crate ; B, Frame of Sections ; c, Queen-excluding Dummy.

frame of sections just before the commencement of the honey flow, and, so soon as they are being well worked out and filled with honey, they place them in a crate to entice the bees up. This is certainly a good plan, as the bees will enter a super containing these sections which they have commenced to fill much more readily than one fitted entirely with empty sections.

There is no need to place queen-excluding zinc under section crates, as it is found that queens *very* rarely enter or lay eggs in them.

The most popular style of crate or "rack" is that which will hold twenty-one sections 2 inches wide—seven sections in

each row. The corners of the sections rest on strips of wood (fig. 25, A)  $\frac{1}{4}$  inch thick, and about  $\frac{1}{2}$  inch or  $\frac{3}{4}$  inch broad:

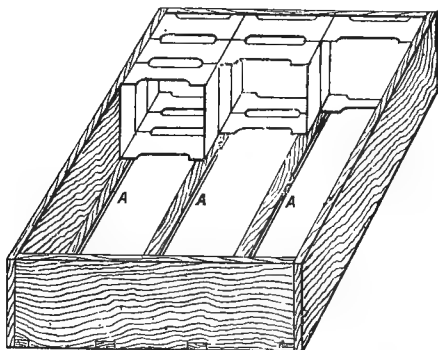

Fig. 25.—Rack or crate of sections, showing interior working arrangements. A, Pieces of wood on which the sections stand.

they are thus slightly raised above the tops of the frames, which allows the bees to pass freely underneath them.

### Dividers.

Between each row of sections a “divider” or separator (fig. 26) is placed, which ensures the faces of the combs being

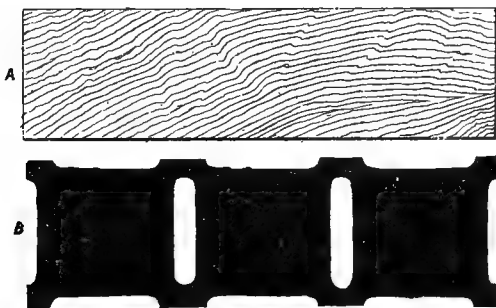

Fig. 26.—Dividers: A, Plain; B, Slotted.

sealed over perfectly flat by the bees. Dividers may be obtained made of either wood, tin or zinc. The “slotted” divider

(fig. 26, B), which allows the bees to pass very readily from one section to another, has now become very popular, as indeed it deserves to be. Some apiarists, who use sections  $1\frac{1}{2}$  inch wide, and fit them with full sheets of foundation, claim that dividers are unnecessary under such circumstances.

The "W. B. Carr" crate (fig. 28a), first fully described in the *British Bee Journal* for June 18th, 1891—has the sections placed in frames, thus preventing the bees from soiling the wood with propolis or "bee glue," a substance with which they fill up cracks and crevices in their hive, often smearing it on the quilts, etc. This crate, which seems to possess many great advantages over all those previously invented, is probably destined to supersede those now in general use. It is manufactured and sold by nearly all the dealers in bee appliances.

### When to Super.

A very important point—perhaps the most important—in the production of comb honey is, when to put the super on the hive: if it is put on too early, the bees will not enter it; if too late, much valuable time is lost. It is impossible to fix any date for supering, as everything depends on the locality and the weather. In places where fruit bloom is abundant the bees will sometimes require supers in April. As soon as the bees begin to elongate the cells near the top of the frames and fill them with honey is the time to put on the super; so we only have to turn back the quilt of the hive, and if we see that the bees have elongated the cells at the top of the frames with beautiful white wax—forming a strong contrast to the rest of the old discoloured combs—we may take out one of the frames, and, if the new cells are being filled with honey, the hive is ready to be supered.

In placing the crates on the hives it is immaterial whether the sections run parallel or at right angles to the frames. The spaces between the sides of the crate and the ends of the frames must be covered with several thicknesses of quilting, so as not to let the heat escape. This is a most important matter in inducing the bees to enter the super, as, if the heat escape, they will all be required below to keep the brood warm; for this reason the top of the crate must also be covered with plenty of quilts.



### Raising the Super.

When the bees have about half completed the sections in the first crate, a second one should be placed underneath the first. When honey is coming in freely, it may even be necessary to place a third super under the second, a few days later.

When the sections in the first crate are completed, they should not be left on the hive for the bees to soil their cappings by constantly walking over them.

### Taking off the Super.

As the bees usually glue the supers to each other or to the frames below with propolis, it requires some care to remove them without jarring the hive at all. The best way is to gently ease up one side of the crate with a screwdriver, and then do the same to the other side, when the super may be lifted off without difficulty. It should then be placed in a dark room or cellar having one window, which must be left open, and in an hour or so the bees will all have escaped: it is, however, necessary to watch that robber bees do not enter the room, attracted by the smell of the honey (as they often are in autumn), and, returning from their hives, bring with them scores of other bees, which quickly clean out the combs. The objection to brushing the bees off the sections is that they often become so frightened that they tear open the cappings of the cells in order to fill themselves with honey. Another way of clearing a super of bees is to spread a cloth over it, soaked in carbolic acid solution and wrung out very dry: the bees then quickly run down to escape the fumes of carbolic acid, and the super may be removed.

The sections should then be sorted into finest and second quality, while all the badly finished ones should be given back to the bees to complete, or, if it is quite at the end of the season and no more honey is being gathered, they may be passed through the extractor and then placed behind the dummy-board in some hive for the bees to clean out—the dummy-board being, of course, raised almost half an inch to allow free passage underneath; after which they should be done up in brown paper, twelve in a packet, with some pieces of camphor or naphthaline to keep away the wax-moth.

### Packing Sections.

Sections to be sent by rail require careful packing to prevent their getting broken. The best kind of crate to send them in is the one shown in fig. 27, which has glass at the back and front; the honey is thus plainly visible, and is likely to receive careful handling. All sections should have the propolis scraped off the wood before being packed for the market.

Many ornamental cases are now made to hold single sections, some of cardboard and others of enamelled tin with glass in front, while a very simple one is constructed much on the



Fig. 27. —Travelling Crate for Sections.

same plan as the American sections, being V-grooved and folding close round the section, with a groove running all round each side, in which the glass is slipped. These cases greatly add to the attractiveness of the sections, while they also exclude dust and insects.

### Strong Stocks Indispensable.

To produce comb honey it is quite indispensable to have strong stocks—stocks which are literally boiling over with bees at the commencement of the honey flow.

If, as is sometimes the case, the tyro has a number of weak stocks after the winter, and wishes to obtain comb honey, it will be necessary to unite two or three of them together. This is best done towards the end of March on some nice warm day when the bees are flying. The hives to be united should first of all be placed side by side; so if they are some distance apart, they must be moved a foot or two—not more—nearer together on each day that the bees are flying freely: they must on no account be moved on days when the bees are not flying, as, in that case, the bees would be out of reckoning as to the position

of their hive, and, next time they were flying, would return to the old spot, fly round and round it, and fall at last from exhaustion, never to rise again. The bees in each hive should have been reduced to only just as many frames as they can well cover, which in the spring will probably not be more than two or three for a very weak stock.

### How to Unite.

When the hives are standing close together, smoke each of them thoroughly; and when the bees have had time to gorge themselves, examine one of the hives and remove the queen (the youngest and most prolific queen will of course be the one to be *retained*); then sprinkle some thin syrup over the bees in both hives, and place the frames of the one hive alternately between those of the other. In place of thin syrup, the bees may be sprinkled with flour from an ordinary flour dredger, which method generally proves entirely successful. The empty hive must now be taken away, and the other placed midway between the places where the two hives have just stood.

If the bees are at all inclined to rob, uniting must be performed towards the evening of some fine, warm day.

It is well, as a matter of precaution, to cage the queen in a "pipe cover cage" (fig. 28), pressed down on some cells of un-



Fig. 28.—Pipe Cover Queen Cage.

capped honey in the hive, for twenty-four or forty-eight hours, lest the strange bees should kill her. During the honey flow, however, it will be found quite needless to remove either of the queens or to cage them, as the bees at such a time unite very amicably if simply gorged with honey, and soon settle for themselves which queen they will keep; but should one queen be older than the other, it would of course be well to remove her.

### How to Find the Queen.

To find the queen it is necessary to remove the frames one by one and examine them, beginning at one side of the hive and gradually working to the other. When we take a frame from

a hive, if the bees all begin running towards one spot, the queen will most likely be found there; but if they run about in wild excitement all in different directions, we may know that the queen is not on that frame.

### Swarming.

If a hive which is being worked for comb honey, should throw a swarm, the best way is to remove half the frames, being sure to get a queen cell with them, and place them with the adherent bees in a new hive at some distance from the old one; then fill up the old hive with frames fitted with half-sheets of foundation, cut out *all* the queen cells from the combs left in the hive, raise the section crates by placing an empty one underneath those already on the hive, and return the swarm to the old hive: the probability is that the bees will not swarm again the same season, or at any rate not for a considerable time; and, moreover, the bees which we removed will build up, with a little careful feeding, into a fine stock before the winter. It is, however, always best to try and prevent swarming when working for comb honey, as the bees do but little work for several days before the swarm comes off.

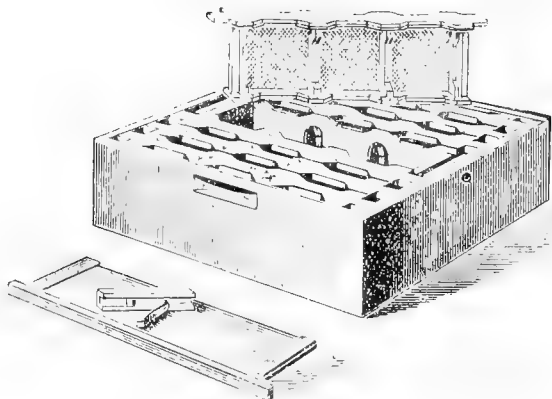

Fig. 25a.—The "W. B. Carr" section rack

## CHAPTER VIII.

### *THE PRODUCTION OF EXTRACTED HONEY.*

EXTRACTED or run honey possesses many advantages over comb honey. In the first place, it is much easier to produce, and a good stock will make much more of it than it will of section honey: the reason of this is not far to seek, as the bees do not have to build so much comb, because when they have filled the combs with honey we extract it and return them to the hive. Extracted honey is also much easier to send long distances, whether in large or small quantities. The apiarist will therefore do well to produce extracted honey, although it does not command so high a price as the beautiful sections. If we have plenty of frames of empty comb, so much the better; but if not, we must make the bees build them early in the season before the honey flow commences.

#### **How to Produce Combs.**

As soon as the bees are strong enough with brood hatching out freely, a frame with a full sheet of foundation should be placed in the centre of the brood nest, and others added every few days till the hive is full; and the bees must be gently fed with syrup meanwhile: any combs which contain no brood should be taken away and the honey extracted (see page 46); they will then be ready for placing in doubling-boxes to give to the bees so soon as the honey flow commences.

When there is no room to place any more frames in the body hive, and when the bees are strong enough, four or five frames should be lifted out and placed in a doubling-box, their place being taken by frames fitted with foundation; all must be kept covered up very warm, and at first the bees should be confined to half the doubling-box, the rest being divided off with a dummy. As fast as the foundation is drawn out the frames can be removed, and the syrup which the bees have

stored in them extracted; but those which contain brood must be left in the hive till the brood is hatched out. In this way two or three strong stocks will build sufficient combs for several hives before the honey flow commences. The foundation should be wired into all frames intended for extracting. In order that a stock may draw out combs as rapidly as possible, it is necessary to feed it with about a pint of syrup daily, beginning with half a pint early in the spring, and gradually increasing it to a pint: if stocks are drawing out combs in a very large number of frames at once, they may sometimes even be fed with more than a pint a day with advantage. The syrup is made by adding a quart of water to four pounds of refined cane (not beet) sugar, and heating it over the fire till all the sugar is melted. It is most important to stir it constantly to prevent the sugar being burnt. Half a teaspoonful of salt and one tablespoonful of vinegar should be added to every quart of water used.

### Doubling.

As soon as the honey flow commences, two frames of brood must be taken from each hive and placed in a doubling-box filled with frames of empty comb, spaced  $1\frac{1}{2}$  inch from centre to centre; the empty space below formed by removing the two frames can be filled up with a couple of frames of comb. The object of placing two frames of brood in the doubling-box is to induce the bees to ascend at once; care must be taken that the queen is left below, and in order to keep her there a sheet of queen-excluding zinc must be placed on the top of the frames in the body hive, cut to the exact size of the top of the hive. As soon as the doubling-box is getting full of honey another must be placed between it and the body hive. During a very heavy honey flow it may even be necessary to place on a third doubling-box, as the bees often gather honey much faster than they can ripen it during a heavy honey glut.

### Extracting.

As soon as the bees begin to seal the honey in the top doubling-box is the time to extract it. It will then be sufficiently ripe, and there will not be so much uncapping to do. The best way is to shake the bees off the combs and brush off any that remain with a goose wing, or a yucca brush, sold by the dealers in bee appliances specially for the purpose. The

frames should then be placed in a comb-box (fig. 29), and carried to some outhouse, there to have the honey extracted from them. First of all the uncapping knife (fig. 30)—previously heated in a jug of very hot water—(or an ordinary table knife will do) must be passed across the combs to remove

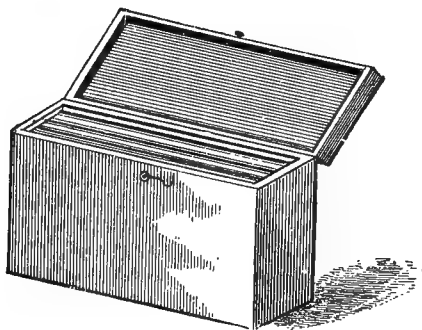

Fig. 29.—Comb-Box.

the cappings on both sides, and they must then be placed in the cages of the extractor (fig. 31, B), and the wheel moved rapidly round for a minute or two; the honey on the sides of the combs next the sides of the extractor will by that time have been all thrown out, and the combs must then be taken out and turned round, when by turning the wheel again all the honey



Fig. 30.—Uncapping Knife.

will be extracted from the other sides of the combs. Most cylinder extractors are made to take two combs at a time; but a few take four. Every extractor should be fitted with a lid to keep the bees out, as they are often very troublesome when one is extracting, getting into the extractor in great numbers, where they fall into the honey and are drowned. .

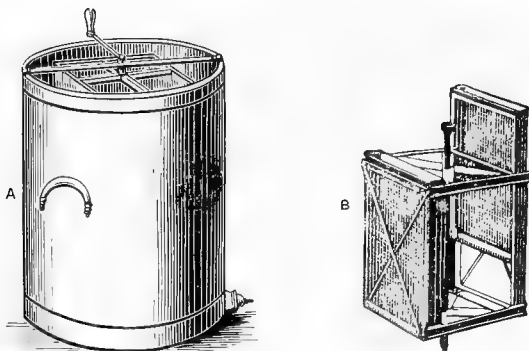

Fig. 31.—A, Extractor; B, Cages of Extractor.

As soon as all the combs from the first hive have been extracted, they should be returned, and those from the next hive extracted. The cappings may be collected and melted down for beeswax in a "wax extractor" (fig. 32),

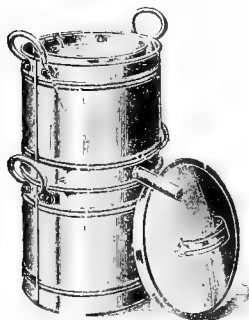

Fig. 32.—Wax Extractor.

which may be obtained from any of the dealers. The lower part of the wax extractor must be filled with hot water and put on the kitchen stove to boil. The cappings or old honeycombs that we wish to melt down should be placed in the perforated metal basket in the top part of the wax extractor, and when the water in the lower part boils, the wax melts and drips slowly out of the spout at the side. A pie-dish, half full of water, must be stood below this spout to catch the clear beeswax as it runs off.

### Storing Combs in Winter.

In the autumn, when all the honey gathering is over for the season, and when all the combs have been extracted, they should be placed behind the dummy-board of some weak stock (the dummy having been previously raised slightly to enable the bees to pass under it), for them to clear out, after which they should be done up in brown paper, half a dozen in a parcel, with a few small pieces of camphor to keep away the wax moth.



They should be placed in a fairly warm, dry room, from which the frost must be excluded if possible, and they will then be found in splendid condition the next spring when they are again wanted for use. In place of camphor naphthaline may be used.

### Ripening and Bottling.

When the honey has been extracted, it must be placed in a honey ripener (fig. 33) in a warm, dry room, having, if

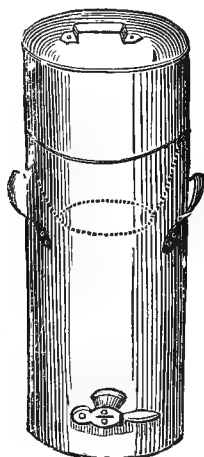

Fig. 33.—Honey Ripener.

possible, a temperature of 80° Fahr. The honey ripener, as will be seen from the figure, is a tall narrow vessel, in which the thin honey rises to the top after a short time, when the ripe honey may be drawn off from the tap below and bottled. Honey requires to remain for three or four days, at least, in the ripener after being extracted before it is bottled. The most favourite way of doing up honey for sale is in one pound glass jars, those having metal screw tops being of a particularly attractive appearance. Many elegantly designed labels are sold by the dealers for attaching to the jars of honey, which considerably enhance their appearance. Honey sold in large quantities may be packed in barrels or tins, the latter being perhaps the best.

### Shallow Frames.

Some persons prefer to use frames the same length as the standard size, but not so deep, for the production of extracted honey. The objections to the use of two different-sized frames in the same hive, such as the impossibility of interchanging frames between the stock-hive and doubling-boxes, and many similar disadvantages, are obvious; but for those who would like to give shallow frames a trial, certain manufacturers make a very convenient hive, in which the doubling-box is made in two rings, the lower one being deep enough to accommodate shallow frames, or when used both together they accommodate standard frames. It is claimed for shallow frames that the combs, being smaller, are less liable to break; but little trouble need be feared on this score even when standard frames are used, provided that the foundation is wired.

### Heather Honey.

Heather honey is so thick that it is impossible to extract it. Therefore in districts where heather is plentiful the apiarist should always run his bees for comb, and not extracted honey. In some places, of course, there is a crop of white clover first, and the heather does not come into bloom till that is over.

### Metal Honeycomb.

Metal honeycomb, made of aluminium, has recently been introduced both in America and England, especially with a view to the production of extracted honey, its strength giving it some advantages for that purpose. Bees will also rear brood in it; but the tyro will do well to use the natural beeswax honeycombs to commence with.

## CHAPTER IX.

### *INCREASE AND THE PROFITABLE PRODUCTION OF BEES.*

IN bad seasons or in districts where but little honey is to be obtained, the bee-keeper may find it profitable to turn his attention to the rearing of bees for sale, a by no means unimportant branch of practical apiculture, and one on which I have bestowed considerable attention.

The prices which strong stocks of bees on bar frames now command in spring vary from about £3 10s. to £4 (prior to the war they were only worth from 15s. to 25s. per stock), and at these prices they pay the bee-keeper well to produce.

There are various methods of increasing the number of stocks, some natural and some wholly artificial. We may term it a natural method to allow the bees to swarm, but even in this case they will need some artificial assistance to work them to the best advantage.

#### **Natural Methods of Increase.**

A very good method of increase is to obtain two natural swarms from a stock and then to divide it into two, thus making four stocks from the original one: but in order that all four may be strong before the winter sets in some care and attention are necessary. Firstly, in order that the stock may swarm as early as possible, it is necessary to induce the bees to rear brood freely in the spring; this is done by what is known as "stimulative feeding," which should be commenced about the middle of March; in a mild spring it may even be begun as early as the first of the month, but in no case earlier than this.

For stimulative feeding a bottle feeder (fig. 34) is used, the neck of this bottle fitting into the round hole in the block, which is covered with perforated zinc. Six or seven holes should be bored in the cap of the bottle, and a square hole should be cut in the quilt about an inch smaller than the block, to which it should be nailed. About a quarter of a pint of syrup should be placed in the feeder every night, but as the spring advances the quantity may be increased to half a pint.

Great care must be taken to cover up the feeder very warmly, so that no heat may escape from the hive. The progress that a stock thus stimulated will make in five or six weeks is amazing. The syrup used for stimulation should be thin, made with 3 lbs. of sugar to a quart of water, one tablespoonful

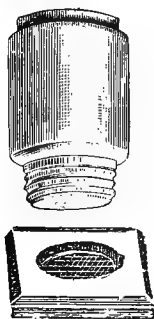

Fig. 34.—Stimulative Feeder.

of vinegar and half a teaspoonful of salt being added to every quart of water.

A superior form of stimulative feeder, in which the amount of syrup taken by the bees may be regulated is shown in fig. 49, page 105.

Supposing that at the beginning of March a hive still has abundance of stores left over from the winter, instead of feeding such a hive, we may with a sharp knife uncap some of the honey on the outer combs with great advantage; the bees will then carry the honey to the brood nest and the effect will be to stimulate brood rearing: a good patch of honey should be unsealed on a warm day about once a week, but care must be taken to commence feeding with syrup before the bees run at all short of stores, otherwise a serious check will be given to the production of brood, as the far-sighted bees, foreseeing a scarcity of food, will refuse to add to the number of their population when the means of supporting them runs low.

### Spreading the Brood.

When the bees appear daily getting stronger from the increasing quantities of brood hatching out, we may "spread

the brood " by inserting a frame of empty comb in the centre of the brood nest, or, failing this, a frame fitted with a full sheet of foundation.

The 1st of April will be quite early enough for the tyro to commence spreading brood, because there is danger with an inexperienced person of spreading the brood too early, when the bees are unable to keep up the warmth of the hive, and " chilled brood " is the result, which means that a large quantity of the brood dies ; instead, therefore, of the hive being strengthened it is greatly weakened, so as often to be rendered quite useless for that season by the untimely spreading of the brood. Supposing, however, that we begin spreading brood about the 1st of April, if all goes on well, the stock should be ready for another frame of comb or foundation in a week or ten days, and another a week after that, and so on until it occupies eight or at most nine frames : the reason for restricting the bees to eight or nine frames is that they swarm much earlier than they do when given more room. Unless the season is very bad or the district an extremely poor one, the bees will be able to gather enough for themselves after the beginning—or at latest the middle—of May, without any further feeding. Of course in districts where there is fruit blossom the bees will be independent of artificial food somewhat earlier in the season. Each hive should be allowed to have about half a frame of drone comb.

In the latter half of May or early in June the stock will probably throw a strong swarm, which should be hived on six or seven frames of comb or foundation. If the weather is bad they will be greatly assisted by a little feeding at first. As they draw out the foundation or store the combs with honey more frames may be added in the centre of the brood nest until the desired number has been attained. It should be mentioned that a strong *early* swarm, hived on six frames of drawn-out comb, and restricted to this number, often throws another swarm later in the season, such a swarm being known as a " maiden swarm " ; these swarms usually require feeding up before the winter, because they seldom gather enough for themselves.

Eight or nine days after the first swarm came off a second is almost sure to issue from the old stock. As soon as we have hived it we can go to the old stock and remove three frames of brood and bees, taking care that one of the frames contains a

queen cell : this frame should be placed in the centre of an empty hive and the other two on each side of it. It is needless to say that at least one queen cell must be left in the old hive. The bees from two more frames from the old hive must be shaken into the hive containing the newly formed division or "nucleus." The next day this nucleus should be examined, and if too many bees have gone back to the old hive, we must shake in the bees off one or two more combs out of the parent colony. When all the brood in the nucleus has hatched, there will probably be enough bees to cover two or three more frames. It often happens that two or three virgin queens, having hatched out at the same time, go off together with a second swarm, so when hiving it we should look out for them, and if it is found that there are two queens, one may be taken away and given to the nucleus ; in this case there is little fear of too many bees leaving it. Where it is found that three queens have gone off with the second swarm, we shall of course give one to the nucleus and another to the old stock. If the swarm is hived with all the virgin queens, the bees will select one and kill the rest before the next day.

### Truant Swarms.

It sometimes happens that after a swarm has been hived it refuses to stay and comes out again, occasionally flying off without alighting ; in such cases it is probable that the bees have already selected some home, which they consider more suitable than the one with which they have been provided, and in order to make them stay in their new hive it is necessary to give them a frame of unsealed brood from the parent or some other hive (taking care, if it is taken from the parent hive or from any that has lately swarmed, to cut out any queen cells which there may be in it). It has been found that the bees thus provided with young brood will not desert it, and so a frame containing some may always be placed in a hive before putting the swarm in, so as to prevent it from leaving the hive.

### Building up the Stocks before Winter.

About ten days or a fortnight after the second swarm came off, the queen in the old stock and also the one in the nucleus

should have mated and be commencing to lay; it is just at this time that a little judicious assistance is needed to build the stocks up into strong colonies. The nucleus (especially, being weaker than the old stock, will be benefited by a little feeding. Not more than a quarter of a pint of syrup every evening will be required, but it is wonderful how this will stimulate the bees to breed if given regularly. In a good season, when honey is abundant, the bees in the old hive and also those in the second swarm will gather sufficient honey to stimulate them to rear plenty of brood, but in a poor season or in a locality where honey is scarce they should be fed with a quarter of a pint of syrup, regularly every day, in the bottle feeder used for spring stimulation. When the frames in the centre of the hive are filled with brood, those at the sides which contain none may be placed in the centre, while those which contain brood are removed to the sides of the hive; the queen will then lay in the empty combs which have been placed in the centre of the hive. The frames must only be moved about in this way if the bees are strong enough to cover all the combs, otherwise there is fear of the brood being chilled.

Six frames will have been quite sufficient to hive the second swarm upon, and this number should not be increased till five weeks after the swarm came off, by which time sufficient brood should have hatched out to justify the apiarist in placing another frame in the centre of the brood nest; more frames may be added every six or seven days until there are from ten to twelve in the hive, and if the swarm is worked up by stimulation to cover all these frames well by September 15th, it will make a very fair stock next spring.

With regard to the old stock and the nucleus, it will often be six weeks from the time when the second swarm issued before they are strong enough to have another frame put in the centre of the hive, because the queens frequently do not hatch out till some days after the second swarm went off, consequently they are later in mating and in commencing to lay than the queen which accompanied the second swarm, and so these hives do not get strengthened from brood hatching out as soon as the second swarm does.

The parent colony and the nucleus should, like the second swarm, be worked up to cover ten or twelve frames by the middle of September; and if any one of these three hives

appear much weaker than the other two, it may soon be strengthened by giving it a frame full of brood which is just about to hatch out from one of the other hives; such combs of brood are technically termed "hatching brood."

Before the winter all the four stocks (viz., the parent hive, the nucleus, and the first and second swarms) must be crowded on to not more than seven frames each (six being the best number usually) and fed rapidly, so that they have 20 lbs. of stores each; this will last them till towards the end of March at least. In feeding up for the winter the bees should take the food rapidly—not less than two pints a day—or much of it will be employed in raising brood. The syrup used for feeding up bees in autumn should be made with 5 lbs. of refined cane sugar to every quart of water; it is made in the same way as the thin syrup used for stimulation in spring. If a stock has seven frames (spaced not less than  $1\frac{1}{2}$  inch from centre to centre) full of sealed stores to within  $3\frac{1}{2}$  inches of the bottom of the frame, it may be considered safe to stand the winter. Stocks should be fed up for the winter not later than October 1st, whenever possible, as this gives them time to seal over their stores before the cold weather comes. In no case can they be fed up after the end of October, and during the latter half of this month even it is often difficult to get them to take down the syrup, owing to the cold weather. When a stock is fed up early, if it is weak it may be stimulated to continue breeding up to the middle of October, after which all feeding should cease, as if bees breed late into the winter dysentery is usually the result. Syrian, Cyprian or Palestine bees should not be stimulated after October 1st, as they are inclined to continue raising brood for some time after the feeding has been stopped; probably this tendency on their part to breed in winter is to be accounted for by the fact that in their native lands they have been accustomed to breed all through the winter months for many hundreds of years past, as Mr. Blow, in his interesting little work "A Bee-keeper's Experience in the East," p. 14, mentions the fact that he found large patches of brood at mid-winter in the native hives in Cyprus.

There are many kinds of feeders designed for rapid autumn feeding, of which the best are perhaps those of the "Canadian Bee-feeder" type (fig. 35), which fit on the top of the hive like a crate of sections. The bees walk up from the frames and get into the feeder by A; they pass down to the syrup by the



upright pieces of wood BB, which are placed near together so that the bees cannot get drowned. The top of the feeder is covered with glass to prevent the bees from escaping. With a feeder like this a stock will take down sufficient food for the winter in two or three days at the outside. In cold weather, if the syrup is given to the bees at a temperature of 90° or 95°

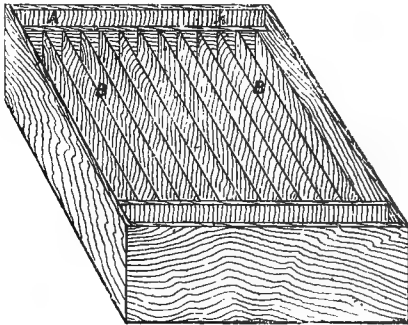

Fig. 35.—Canadian Bee feeder.

Fahr.—not more—they will take it down much more rapidly than if given cold. The feeder should be kept well covered with quilts to prevent the heat of the hive escaping.

**Profit and Loss.**

By the foregoing method we obtain an increase of three stocks from one, leaving the original one for the repetition of the same process or for the production of honey the following year. The feeding of the four stocks will not take more than 1 cwt. of sugar—probably a good deal less. The estimated cost of producing the three stocks, which I give below, has been made out on a liberal scale, and in many cases it would be considerably less.

	£	s.	d.
1 cwt. cane sugar . . . . .	4	4	0
3½ lbs. thin foundation at 3s. 6d. per lb. . . . .	0	12	3
3 doz. frames at 3s. 9d. per doz. . . . .	0	11	3
Advertising the bees for sale, say . . . . .	0	5	0
Total	£5	12	6

It will be seen above that I have not taken into account the cost of the three hives, the feeders, and travelling boxes (one of which between every three stocks will be enough); but as all

these should last for ten years at least, we need only take a tenth part of their value, as below, which amounts to 12s

	£	s	d.
3 hives at 31s. each . . . . .	4	13	0
1 rapid feeder . . . . .	0	6	6
3 slow bottle feeders . . . . .	0	10	6
1 travelling box . . . . .	0	10	0
	Total <u>£6 0 0</u>		

Therefore the total expense will be the tenth part of £6 (viz., 12s.) added to £5 12s. 6d., which amounts to £6 4s. 6d.

Of course where the apiarist makes his own hives this amount will be considerably reduced, but for this method of increase the very utmost economy is necessary to make it a financial success. The three stocks of bees sold in the spring for £3 10s. apiece would amount to £10 10s. for the lot, or a profit of £4 5s. 6d.

Although it is not to be supposed that the high prices that bees have commanded since the war will be maintained, it must at the same time be borne in mind that the price of sugar, etc., is also likely to drop; nor, in good honey seasons, will the bee-keeper require to use nearly so much sugar as I have here allowed for.

### Begin with one Stock.

Of course more than £3 10s. a stock can often be obtained at the present time; but as experience and economy are indispensable, I advise every one to begin with one hive, and if this one, worked for increase by the method just detailed, should prove profitable, then to work more on the same lines the following year.

### Artificial Methods of Increase.

Although the foregoing method of increase is probably the best in every way for the novice, when the bee-keeper has gained experience he may find a wholly artificial method the most desirable, yielding the largest profit at the smallest cost; but let it be clearly understood that experience is quite a desideratum, and that a novice is almost certain to make a hopeless failure by attempting too much before he has acquired the experience requisite to make the method of artificial increase, now to be detailed, a success; for by it the stock is divided into very small parts, and in making up these nuclei the tyro, who has had no experience, is likely to put in

so few bees that, when a good many of them have left, there will not be sufficient remaining to hatch out the brood; or else he will go to the other extreme and so depopulate the old hive that there will not be enough bees in it to hatch out the brood; for these and many other reasons I therefore again say experience is a *sine qua non*.

### Give the Bees Plenty of Room.

Instead of confining the bees to eight or nine frames, as I have advised for natural increase, they should be gradually worked up till they occupy the whole hive, which they should certainly do by the end of May or even before; a doubling-box full of frames of empty comb or foundation must then be placed on the hive, and a couple of frames of brood should be placed in it from the lower hive. If necessary the bees may be gently fed to make them draw out the foundation more rapidly; the queen will quickly fill the combs in the doubling-box with eggs, and as soon as the brood from these is hatching out freely and the hive crammed full with bees is the time to think of dividing it. We will suppose that the hive contains twenty-four frames, twelve in the stock hive and twelve in the doubling-box.

### Queen-raising.

As soon as all is ready, and drones are becoming plentiful in the apiary, a frame of new clean comb (or if this cannot be had a frame of foundation will do) should be inserted in the centre of the hive: after forty-eight hours examine it; if it contains no eggs, then return it to the hive for another forty-eight hours; but if it is full of them, remove the queen with from six to twelve (say twelve) of the frames which contain young unsealed brood or eggs, with the adherent bees, and place them in an empty hive in a new position, taking care to leave in the old hive the frame of comb which was inserted forty-eight hours previously and which is now full of eggs, for it is from these eggs that we intend the bees to rear queens. Circular holes should be cut in the comb about  $1\frac{1}{2}$  inch in diameter, and round these the bees will form the queen cells. In seven days' time the hive should be again examined, and any queen cells which the bees may have made in any other frame but the one selected must be cut out.

When holes are cut in the comb, as just described, the bees usually build two or three queen cells in a cluster in each hole, placing them so close together that it is impossible to divide them without injuring them in some way; therefore many advanced apiarists practise a more scientific mode of raising queens. The comb containing the eggs is cut into narrow strips, and the eggs in every other one of the cells in the bottom row on both sides of the comb are removed with the point of a sharp penknife. This should be done in a warm room; the strip of comb is next fastened to the top bar of a frame with a mixture of melted beeswax and resin, and is then returned to the hive: the bees will then build a queen cell round each egg in the bottom row of cells, and these will be at such a distance apart that they may easily be cut out separately with a sharp knife without fear of injury.

### Forming Nuclei.

Twelve days after the queen was removed with the twelve frames of young brood, we may go to the hive in which we placed her (which, for convenience, we will call No. 2), and, having prepared two empty hives, we may remove four frames of brood from this hive—No. 2—and place two in each hive, shaking the bees off two more frames from No. 2 into each of the two nuclei just formed: all should then be made snug with dummies and quilts. This should be done at about ten o'clock in the morning, and care must be taken that the queen is left in the hive and is not in either of the nuclei. In about two hours' time—that is, at midday—the bees in the nuclei will have found out that they are queenless, and they may then each be given a queen cell from the old stock; if given sooner there is danger of the bees destroying them.

It is just at this time—midday—when the bees are flying freely that the old original stock should be divided up into nuclei. The bees, having been queenless for some time, are not likely to leave the nuclei in nearly such great numbers as they would supposing that the nuclei had been made up from a stock which possessed a queen. The stock may be divided into six two-frame nuclei (the novice may perhaps prefer to divide it into four three-frame nuclei at first), each of which should be placed in an empty hive and made snug with a division-board on each side of it. We next go to No. 2—the

hive which contains the queen—and having shaken the bees off three or four frames of brood, we place these in the hive occupied by the old original stock (which is now empty, all the frames having been removed to form nuclei). The bees which were flying at the time will return here, and hatch out the brood with which we have supplied them.

### Fixing the Queen Cells.

Into each of the divisions which we have thus formed we must fix a queen cell. This requires considerable care and is done in the following manner:—

Having taken the frame which contains them into a warm room, the cells are cut out separately with a very sharp pen-knife, the utmost care being taken not to press the walls or



Fig. 36.—Queen Cell with Pins, ready for fixing in Nucleus.

bases of the cells, lest the embryo queens inside should be injured. Two pins are next passed through the comb to which the cell is attached, well up above the cell itself, at A and B. We then take the cell to the nucleus, and drawing the frames a little way apart, pin it on to the side of one of the combs. As considerable heat is lost by this method of keeping the frames a greater distance apart than would otherwise be necessary, a better plan is to cut a hole in the middle of one of the combs and pin the queen cell into this: whichever method is adopted great care must be taken not to press the cell at all, or the queen may not hatch; and even if she docs, she may be injured or deformed in some way. A sharp look-out must be kept that too many bees do not leave the nuclei; and if there should appear to be any fear of this happening, a piece of perforated zinc may be placed over the entrance for a day or two

until the queen has hatched out, to prevent the bees leaving the hive. It is necessary to watch that none of the nuclei run at all short of stores, and they must be gently fed whenever this is the case. Indeed it is almost always well to do this until the young queens are mated and have commenced laying.

Hive No. 2, which contains the old queen, may be provided with two or three more frames of empty comb or foundation if it is strong enough. It is likely to require feeding like all the other nuclei.

### Do not Shake a Queen Cell.

Never shake a comb or frame containing queen cells if you can possibly avoid doing so. It is apt to injure or destroy the embryo queens inside the cells. If you wish to remove the bees it is best to drive them off with smoke, and afterwards brush off any that remain with a goose wing or soft brush, taking great care not to touch the cells themselves with the brush.

### The "Edwards" Divisible Frames and Nucleus Hive.

Mr. Edwards has invented a very ingenious divisible frame (fig. 36*b*) and nucleus hive (fig. 36*a*) which those who are in

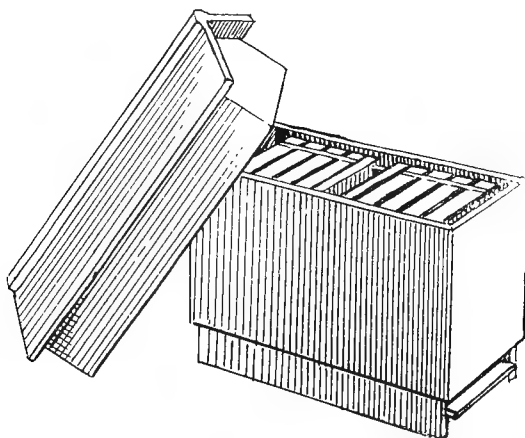

Fig. 36*a*.—The Edwards Nucleus Hive.

the habit of forming nuclei constantly on a large scale will find very convenient.

Two of the frames, joined together, form one frame of standard size, for use in the ordinary way in standard frame hives. When, however, it is desired to form nuclei, each frame can be divided into two, as shown in the illustration.

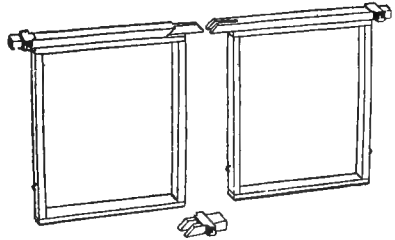

Fig. 36b.—The Edwards Divisional Frame.

The hive is arranged to accommodate two half-frame nuclei, one at either end, the frames hanging across the hive (as in the illustration), or one half-frame nucleus up to a nine half-frame capacity, whilst when the frames are again joined together the hive provides hanging capacity, lengthwise, for five frames of standard size. Being double-walled, a small colony, provided with sufficient food, will winter safely in this hive in any ordinary English winter.

The hive is manufactured by Mr. Edward J. Burt, of Stroud Road, Gloucester.

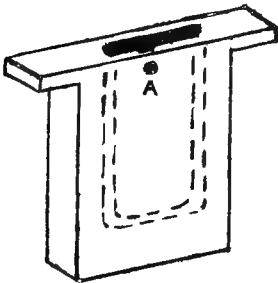

Fig. 36c.—Division Board Feeder for Small Nuclei.

### Division Board Feeder for Small Nuclei.

It is quite impossible to exaggerate the importance of regular gentle feeding in the case of nuclei, more especially in the case of small nuclei. The amount given may be quite small—from 2 to 8 or 10 tablespoonfuls per day, according to

the size of the nucleus—but it must be given regularly. Without it a nucleus often loses heart and the queen either fails to mate, or if mated she may fail to commence laying.

The most convenient method of feeding nuclei in small nucleus hives similar to that just described, is to use a solid division board feeder (fig. 36c) made of wood  $1\frac{1}{4}$  inches thick,

in which a deep hollow (as indicated by the dotted lines) has been scooped. It is easy to form this hollow by boring a number of holes side by side in the top of the division board with a brace and bit, using a  $\frac{3}{4}$ -inch bit for the purpose, and smoothing the inside off roughly with a sharp chisel. The hollow serves to contain the syrup (which may be poured into it at feeding time through an ordinary tin funnel so as to avoid spilling any syrup) and the bees obtain access to the syrup by means of the little round hole A, bored in one side of the feeder.

### **Breed Queens from the Best Stock in the Apiary.**

All queens should be bred from the eggs laid by the very best queen in the apiary; so if the stock which we intend to divide has not got such a good queen as another stock in the apiary, we can put a frame of comb into the stock with the best queen, and forty-eight hours afterwards, when it has been filled with eggs, we can remove it, and place it in the other hive for the bees to rear queens from. During the time that the young queens are flying to mate, a piece of queen and drone-excluding zinc may be placed over the entrances of any inferior stocks which contain drones which we do not desire to mate with the young queens, as the choice of drones in breeding fine prolific stock is almost as important as the choice of the queens themselves. Neither queens nor drones should be bred from a queen whose progeny of worker bees is vicious and ill-tempered; but a queen heading a stock remarkable for strength, docility, and good honey gathering qualities should be selected as the mother from which to breed queens or drones. Never breed the drones with which the young queens are to mate from the same mother as the queens themselves, as such in and-in breeding is sure in time to weaken the breed and cause deterioration.

### **Building up the Nuclei.**

The nuclei should be built up in the same way as advised in "Natural Increase" on page 55; and if any appear weaker than the others, they may be strengthened with a frame of hatching brood from No. 2 hive—the stock containing the old queen.

By this method of forming six nuclei from the original stock and two more from No. 2 hive it will be seen that we



have an increase of ten from the original one hive. Allowing two out of this for failures of the young queens to mate, or loss from a severe winter, we have eight stocks left—that is, seven stocks to sell, and the original stock left for the repetition of the same process the following year; and so we come to the profit and loss side of the question.

### Profit and Loss.

DISBURSEMENTS.		£	s.	d.
2 cwt. cane sugar at £4 4s. per cwt.	.	8	8	0
10½ lbs. thin foundation at 3s. 6d. per lb.	.	1	16	9
7 doz. frames at 3s. 9d. per doz.	.	1	6	3
Advertising bees for sale, say .		0	6	6
Total		11	17	6

This amount, £11 17s. 6d., must be added to the tenth part of what I will call the bee-keeper's stock in trade, which amounts to £1 14s. 6d. as below.

9 hives at 31s. . . . .	.	13	19	0
2 rapid feeders at 6s. 6d. . . . .	.	0	13	0
9 slow stimulating feeders . . . . .	.	1	12	6
2 travelling boxes . . . . .	.	1	0	6
Total		17	5	0
£17 5s. ÷ 10 =		1	14	6
Add		11	17	6
Total		13	12	0

In spring the seven stocks will be sold on six frames each, not twelve, and so there will be at least three dozen frames of comb which the stocks built during the previous summer. These may either be kept for future use, or (as calculated below) they may be sold at 24s. per dozen.

RECEIPTS.		£	s.	d.
7 stocks sold at £3 10s. each . . . . .	.	24	10	0
3 doz. frames of comb at 24s. per doz.	.	3	12	0
Total		28	2	0
Deduct		13	12	0
Net Profit		14	10	0

### Economy.

In concluding this chapter I can only repeat to the reader how essential the strictest economy is when the apiarist desires to make money by breeding bees for sale. Unforeseen misfortunes occur, which reduce the profits and increase the expenses, so that I advise every one to try working only one stock for increase at first, till he gains experience.

### Books on Queen-Rearing.

The method of queen-rearing detailed in this chapter is undoubtedly the best for the tyro. When he has become an adept at it by repeated experience, he should, if he desires to raise queens on a very large scale—let us say by the hundred—study such works as “Queen Rearing in England,” by F. W. L. Sladen (price 1s. 6d.; published by Madgwick, Houlston, & Co.); and Doolittle’s “Scientific Queen Rearing” (price 3s. 6d. post free)—the latter book being published in America, and obtainable from Messrs. Steele & Brodie, Wormit, Fife, Scotland, and also, at present, from the *British Bee Journal* Office.

The experienced bee-master will find Mr. Doolittle’s book of great value. Amongst other things it explains a method—highly convenient for those who possess only a few hives—by which two young queens may be raised and mated in a colony, *during a heavy honey flow*, without either removing the old queen or splitting up the colony into nuclei.

I cannot, however, too strongly point out that beginners who embark on such methods before they have had considerable practical experience of bees, and have thoroughly mastered the far simpler methods of queen raising already detailed in this chapter, are almost sure to meet with disappointment and failure.

The beginner will do well to bear in mind Henry Geary’s useful adage that “There is no royal road to success in bee-craft. What is required is perseverance and a commencement at the bottom of the ladder—not an initial fall from the top rung.”

## CHAPTER X.

### *SPRING, SUMMER, AUTUMN AND WINTER MANAGEMENT.*

#### SPRING MANAGEMENT.

THERE is not much remaining to be said on this point, as a good deal of advice has already been given about stimulating, uniting, and spreading the brood in spring in previous chapters.

#### **Candy.**

When the bees are short of food in spring, they may be given a cake of candy in the beginning of February. This candy is made as follows:—Add half a pint of water to 4 lbs. of cane sugar, and heat over the fire till melted, stirring constantly to prevent the sugar from being burnt. Now take a drop from the saucepan, and place it on a cold plate: if it quickly hardens, it is sufficiently thick; but supposing that it remains soft and sticky when it has cooled, the boiling must be continued to drive off more moisture, or else more sugar must be added. As soon as the syrup is of the right consistency, it should be poured into saucers or soup plates, or some other kind of shallow, flat dishes, the bottoms of which have been previously lined with paper to prevent the candy from sticking to them.

Before the candy is poured into the vessels prepared for it it must be constantly stirred, and not poured out until it begins to cool and thicken: when perfectly cold it ought to be neither very hard nor yet very soft. It can then be given to the bees by placing it (paper side up) on the top of the frames under the quilts—the paper preventing it from sticking to the latter.

If the bees should be short of pollen (which but very rarely happens), its place may be taken by an artificial substitute, in the shape of wheat or pea flour—the latter being the best. This can easily be given to the bees by mixing it with the

candy—it should be stirred into the syrup while it is still quite hot in the saucepan, and the stirring must be continued briskly till the flour-cake candy begins to cool, otherwise it will be lumpy. When flour is mixed with it, the candy does not require to be so thick—it can be made with a little more water and a little less sugar.

In the middle of February the entrances of all hives must be narrowed to 1 inch wide in order to conserve the heat: weak stocks may have their entrances reduced to  $\frac{1}{2}$  inch. There is no need to make the entrances wider again before the beginning of April.

### Robbing.

Beware of robbing; and remember that prevention is better than cure. When syrup is spilt about the hives or on the ground near to them in spring or autumn, it is very likely to induce robbing. It is quite easy to tell when one hive is robbing another; in fact, there cannot possibly be any mistaking the signs of it. The weakest hive is the one generally attacked; and if the bees from two or three other hives attack it all at once, it will have a hard time of it unless the apiarist comes to its aid.

When the bees are seen around the entrance of a hive in large numbers, and when they are constantly engaging in fights with other bees, robbing is either being attempted or is actually taking place. The hive which is attacked should have its entrance narrowed so that not more than two bees can pass at a time (in very bad cases of robbing it should be made so narrow that only one bee can pass through it at a time). Towards the evening, when all is quiet, the entrance should be widened again to enable the bees to carry out their dead, otherwise it may get blocked up.

### Hive Roofs Blowing Off.

A heavy stone or a couple of bricks should be placed on the roofs of the hives in spring, to prevent them from blowing off in the gales which so often occur at this time of year. When the roof gets blown off, very serious consequences often follow; the quilts are often disarranged, and if it happens to be raining, the hive will get a thorough soaking. Any hives and appliances needed for the summer should be ordered in spring,

as, if left till just before they are wanted for use, the dealers are often so busy that considerable delay is caused in executing the orders, which frequently occasions much loss and inconvenience to the bee-keeper.

### Planting for Bees.

Many persons have an idea that by sowing in their garden a few seeds of flowers much frequented by bees they will considerably increase their harvest of honey: this, let it be understood, is a mistake. To make any appreciable difference, plants for bee pasturage must be grown, not in small patches, but by the acre. Bees get the majority of their honey from large fields of flowers, the most important sources from which they obtain it being:—

1. The fruit blossom in orchards.
2. Fields of white or Dutch clover.
3. Fields of sainfoin.
4. Fields of beans.
5. Moors and commons where heather abounds.
6. Plantations of lime trees.

Bees also get a considerable quantity of honey from mustard, trefoil, etc.

The honey gathered from white clover is of very fine flavour, and light in colour: that from sainfoin, somewhat darker; bean honey is darker still, and of a most delicious, though somewhat strong, flavour. Lime honey is very light-coloured, and much esteemed. Heather honey is very dark and thick, having a very pungent and peculiar aroma, highly appreciated by some, while others consider it objectionable.

Bees are very important agents in the fertilisation of flowers, carrying the pollen from plant to plant. If fruit-growers would only realise how dependent they are upon bees for the proper fertilisation of the fruit blossom, they would not only secure much larger crops of fruit, but also a considerable amount of honey, in return for the trouble of keeping a few hives of bees—say two or three hives to each acre of orchard.

### SUMMER MANAGEMENT.

At the commencement of the honey flow, all stocks that are intended to produce comb honey must be supered, and those for extracted honey doubled. Entrances should be kept at full

width, to allow good ventilation and free passage-way for the bees. During the summer nuclei can be formed and young queens reared, to supersede old ones at the end of the season, if necessary.

### Introducing Queens.

There are many different ways of introducing a new queen to a stock, but they may all be classed under two heads—viz., “Caging” and “Direct Introduction.” Whichever method we adopt, one thing is necessary: we must remove the old queen before we attempt to introduce the new one. The two most popular cages in this country are probably the “Pipe cover cage” and the “Raynor cage.” The pipe cover cage (fig. 37, A)

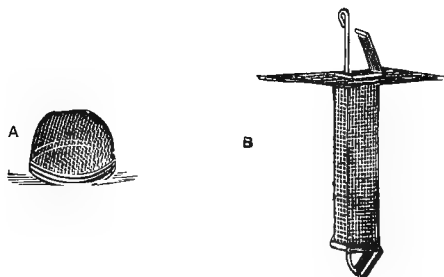

Fig. 37.—A, American Pipe Cover Cage; B, Raynor Queen Cage.

is used in the following way:—Having placed the queen in it, we put a piece of cardboard underneath, and carry it to the hive, from the centre of which we take a frame, and placing the cage over some cells containing unsealed honey, we withdraw the card, and press the cage firmly down into the comb as far as the mid-rib. A few newly hatched workers from the hive may be put in the cage with the queen.

After forty-eight hours we may again go to the hive, and if the bees show no hostility to the queen, we may release her; but if they are thickly clustered round the cage, bending up their bodies in their attempts to sting her through the wires, she must remain caged for twenty-four hours more, or until the bees become reconciled to her. If, just after the queen is released, the bees should “ball” her—*i.e.*, form in a thick cluster, about the size of a walnut, around her—doing their utmost to get at and sting her, they must immediately be

dispersed with copious puffs of smoke, and the queen must be caged again.

The "Raynor" cage (fig. 37, B) is a very good one; the queen is placed in it, and it is inserted between two combs, down through the feed hole, the flange at the top of the cage resting on the top bar of the frame on each side. Care should be taken that the sides of the cage press close against some honey which has just been uncapped, so that the queen may be able to feed through the perforations in the cage; otherwise she may get starved to death. About forty-eight hours afterwards—in the evening—the wire may be pressed down, and the queen released, if the hive is quiet and the bees seemingly well-disposed towards her. It should be noted that when a queen is introduced by any method of caging, any queen cells which the bees may have formed must be cut out, otherwise the bees are almost sure to kill the new queen. When we give a queen to a hive by the method of direct introduction, it is unnecessary to cut out the queen cells previously.

### Direct Introduction.

Of the various methods of direct introduction practised in this country, the "Simmins" method is undoubtedly the most popular; and as it is not my intention, in this little work, to confuse the amateur by detailing a number of ways of accomplishing the same object, I shall only explain the "Simmins" method of direct introduction, which possesses several advantages over the other methods at present introduced. Mr. Simmins' directions are as follows:—

1. Keep the queen quite alone for not less than thirty minutes.
2. She is to be without food meanwhile.
3. And to be allowed to run down, from the top of the frames, after darkness has set in, by lamplight."

The queen may be kept in a "safety" match-box for the thirty minutes during which she is kept alone and without food, but the same match-box must not be used twice. She should be kept in a warm room, so as not to get chilled meanwhile. When ready the operator should go to the hive, give a puff of smoke to drive back the bees, then turn up the corner of the quilt, and let the queen run down among the bees in the centre of the hive. No further examination of the hive must be made

till at least forty-eight hours afterwards. A queen must not be introduced by this method to a stock from which a nucleus has been formed less than three clear days previously; otherwise the old bees, returning to the hive, will ball and kill the new queen.\*

### Shading Hives in Summer.

Often in very hot weather many of the bees hang out of the front of the hive in clusters, idly doing nothing, when, if the hive were rendered cooler by being shaded, these bees would be working busily in the fields. A very good way to shade a hive is to place a piece of sacking over it, and weight it down with stones, so that the wind may not blow it off.

### AUTUMN MANAGEMENT.

In the autumn there is a good deal to be done in the apiary. Empty combs must be done up in parcels, with camphor to keep away the wax moth, and put aside in some warm, dry room for the winter. Stocks must be fed up and packed before cold weather sets in; weak ones united, and the apiary generally set in order.

### Condemned Bees.

Cottagers who keep bees in straw skeps, and kill them with sulphur when they take their honey in the autumn, can often be induced to sell the bees out of the hives for sixpence a stock, if the apiarist will come and drive them out of the skeps. Two or three such lots joined together and placed in a hive containing empty combs, and then fed up for the winter, will make a very good stock; and this is a very good and cheap way for the apiarist to procure bees, provided that he has previously had some experience in handling them. The tyro—unaccustomed to the management of bees—would be almost sure to meet with failure.

### Driving.

The operation of driving a stock of bees out of a straw skep is performed as follows:—Procure a large earthenware pan or an ordinary pail, a little smaller than the skep, so that the latter, when turned upside-down and placed in it, will fit down in the pail to about half its own depth, and be kept steady in

\* Another method of introducing queens is described on page 105.



its place. Having procured the pail, it should be stood on a table or the seat of a chair, to raise it a convenient height from the ground. Now go to the hive, and smoke it well through the entrance. Wait fully a minute or two for the bees to gorge themselves, and then take the skep up gently, and place it upside-down in the pail; get an empty skep, into which the

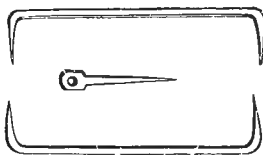

Fig. 38.—Driving Irons.

bees are to be driven, and with the driving irons (fig. 38) fix it to the skep containing the bees, the skewer being put through the two skeps at *r* (fig. 39), to form a hinge, while the other two serve to keep the top skep up (one of them is seen in fig. 39, *D*). Be careful that *r*, the point where the two skeps join, is higher than *r*, as the bees will run to the highest part of the

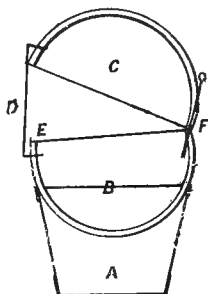
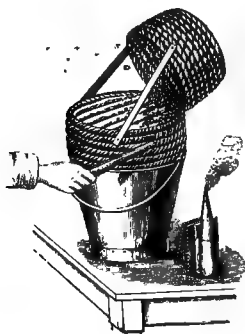

Fig. 39.—Straw Skep, etc., in process of Driving, and section of same.

hive; also see that the combs run from *E* to *F*, and not cross-wise in the skep. When all is fixed, the apiarist must keep up a drumming on the sides of the skep, either with the hands or with two sticks; the bees are so frightened by this that they at once begin to run up to the skep above, and cluster in the top of it. The queen may, if necessary, be caught as she runs up; but as driven bees are so subdued that, when several lots

are united together, without any of the queens being previously removed, they show no disposition to fight, it is only necessary to catch a queen if she is known to be old or enfeebled and inferior to the queens of the other lots with which we intend to unite the one we are driving. The rapping on the sides of the hive must not be so hard as to break the combs, yet it must be sufficiently hard to jar them; it must also be kept up continuously, until all the bees have ascended, for if we stop the bees will cease running up. "Close driving" is another method of getting bees out of a hive; by this method the two skeps are fitted close down, one to the other, mouth to mouth, and a cloth is tied round the juncture, so that no bees may escape. The objection to this plan is that we are unable to catch the queen as she runs up, nor can we be quite sure that she has gone up. It is also difficult to know when all the bees have run up. For nervous persons, or when handling very vicious bees, this plan has much to recommend it.

### Robbing.

Beware of robbing in autumn; it is even more dangerous then than in the spring. Do not spill syrup about the hives, or leave pieces of comb containing honey lying about near them. Contract the entrances of all hives—an entrance  $1\frac{1}{2}$  inch wide will be quite sufficient for the strongest stock, while weak ones do not need one so wide. All stocks which have not sufficient stores must be fed up rapidly, till they have 20 lbs. of sealed stores at the very least; with this amount they may be considered safe to stand the winter without any further assistance till the middle or end of March. For further directions concerning feeding up stocks for winter see page 56.

### Packing up Hives for Winter.

Although it is not absolutely necessary in every case, stocks are very much benefited by having the spaces between the division-boards and the sides of the hive filled with some such warm packing as corkdust, sawdust, chaff, or shavings. With weak stocks this is almost indispensable; while strong ones, thus treated, come through the winter in much better condition. In spring the hive can be lifted from the floor-board, and the packing will then drop out. Plenty of quilts must be placed over the bees before the winter sets in, and care should be taken

to see that they fit close to the sides of the hive, so that no heat escapes at the ends of the frames. Some persons prefer porous quilts, whilst others advocate impervious ones, made of such materials as American cloth. Many are the articles which the advocates of each have written on the various advantages and disadvantages, the merits and demerits of the two systems. One thing is certain, and that is, that when impervious quilting is used, a wide entrance—say 6 inches—is absolutely necessary to let off the moisture which is formed in the hive, and which, having condensed, falls to the floor. Where porous quilts are used, such as sacking, carpet, etc., the entrance need not be more than 4 inches wide.

There is really very little to choose between porous and impervious quilts after all; personally, I prefer the porous ones, but I have used impervious ones with perfect success. Where there are not many quilts on hand, newspapers may be made to supply their place, and they can be spread over the one or two thicknesses of quilting with which the hive is provided. They are excellent in every way, keep in the heat well, and have the advantage of being cheap. A good many thicknesses placed over the frames, carefully fitted up close against the sides of the hive, will ensure the bees being warm and comfortable.

See that all hive roofs are thoroughly water-tight before winter sets in. Any hives requiring a fresh coat of paint should have it, and all chinks and cracks must be filled up with putty.

#### WINTER MANAGEMENT.

In winter bees must be left alone entirely. Not even on fine, warm days, when they are flying, should any manipulation be performed, unless under the direst necessity—as, for instance, when they are attacked by dysentery. If it is feared that they are running short of stores, a corner of the quilt might be turned up, which would enable the bee-keeper to see whether or not they were in need of food, without disturbing the frames in the least. Should a stock need any feeding in winter, syrup must on no account be given, as it would be sure to give the bees dysentery. Candy is the only safe food at this time; it may be made either in the way described on page 67, or else in the following manner:—Take 12 ozs. of lump (cane) sugar, and pound it fine; mix with 4 ozs. of brown or moist sugar two tablespoonfuls of flour, and two of honey;

when all the ingredients have been thoroughly well worked together, the whole may be moistened with a little water; it is then boiled up for a minute, and when cool is ready for use. This candy is known as Viallon candy.

When snow is lying on the ground and the sun is shining brightly it is often necessary to shade the entrances of the hives with a branch of evergreen or some other suitable material, lest the bright reflection of the sunlight from the snow tempt the bees out, only to perish from the cold.

The winter is the time for the apiarist to make the hives and appliances he will need in the following season.

### The Bee-keeper's Library.

The winter is also the time for him to read and study the subject, and to form his plans for the future. The following are the best books for the beginner to read:—

“Bee-keeper's Guide Book,” by T. W. Cowan. 2s. 6d. Published by S. G. Madgwick, Ivy Lane, London, E.C.

“A Modern Bee Farm,” by S. Simmins. 7s. 6d. Published by S. Simmins, Heathfield, Sussex, and obtainable from the *British Bee Journal* Office.

Every bee-keeper should read either the *British Bee Journal* (a weekly periodical, devoted to the interests of apiculture, and published at the small price of twopence only), or else the *Bee-keeper's Record* (published monthly, price 2d., or 2s. 6d. per year post free). The offices of both these papers are at 23 Bedford Street, Strand, London, W.C. Both these journals were established many years ago, and not only the matter but also the advertisements are helpful to bee-keepers. Recently (1919) two other bee papers, known as the *Bee Craft* and the *Bee World*, were also established.

In Ireland a paper is published, known as the *Irish Bee Journal*, which may be obtained for 2s. 6d. per year post free from “Bee Publications,” Lough Rynn, R.S.O., Co. Leitrim, Ireland.

Not only every fruit grower and orchardist, but also every one who may intend to grow fruit in the future should read “The Fertilisation of Fruit Blossom by Bees,” a pamphlet by T. W. Cowan, obtainable from the *British Bee Journal* Office, price 4d. post free. It is not too much to say that many fruit growers will at least double their income by reading this invaluable little work, more especially if they read it before they plant their orchards.

## CHAPTER XI.

### *THE "WELLS" SYSTEM OF KEEPING TWO QUEENS IN ONE HIVE.*

#### HOW TO KEEP TWO QUEENS IN ONE HIVE.

IN the year 1891 Mr. G. Wells, a Kentish bee-keeper, discovered a plan, that has since become very popular with some bee-keepers, by which two queens may be kept in one hive.\* Mr. Wells' system is this. In the autumn he gets a hive large enough to take 18 or 20 frames in the body-box, and having two entrances, either both at the same side of the hive (as in the illustration, Fig. 40), or, preferably, one at each end, like an ordinary twin hive. In this he places two strong nuclei, each headed by a fertile queen, or two stocks, divided from each other by a dummy board of thin yellow pine-wood, placed in the middle of the hive, the two stocks of bees being crowded up against each side of this dummy. The dummy board itself must be pierced with fine holes, bored with a bradawl, and afterwards burnt out with a piece of red-hot iron wire of  $\frac{1}{8}$  inch diameter, passed through them. The dummy board should be about  $\frac{3}{8}$  inch thick, and Mr. Wells recommends that the edges should be bound with tin, to prevent it from warping. It must, of course, fit closely and accurately against the sides and floor of the hive, so that the bees from one side cannot pass to the other. In the following spring, when the hive is boiling over with bees and ready for supering, a sheet of queen-excluder zinc is placed over the top of the body-box. A doubling-box is then added, and one large crate of sections is placed over the whole hive, if we are working for comb-honey, while if we are working

\* Mr. Wells has published a little pamphlet on this subject, entitled "A Guide Pamphlet on the Two Queen System of Bee-keeping," which may be had from the Author, Mr. G. WELLS, Eccles, Aylesford, Kent, price 6 $\frac{1}{2}$ d., post free.

for extracted the doubling-box is filled with frames, and the bees from each of the two stocks are then allowed to go up, whereupon they will mingle and work quite amicably together. Some bee-keepers prefer to use section racks made in two divisions, but if this is done great care must be taken to see that the bees are able to pass freely from one division of the section rack to the other.

The dummy board must in all cases be made of pierced wood; not of perforated zinc or wire netting, since it has been found that when either of the latter materials are used the bees of each of the two stocks will cluster as far as possible

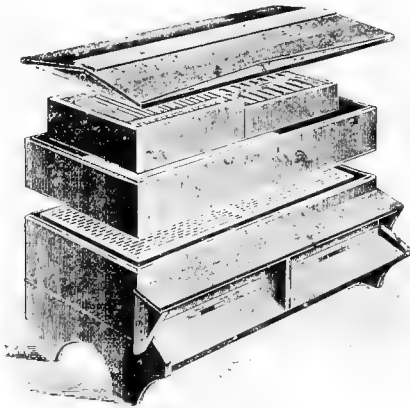

Fig. 40.—A "Wells" Hive.

away from the dividing dummy, only approaching it when absolutely crowded beyond possibility of staying in any other portion of the hive. This is fatal to the success of the system.

When the bees in one side of a "Wells" hive prepare to swarm, the bees in the other side do the same, and, the two young queens coming off together, unless some one is at hand to catch one of them, one is sure to be destroyed.

Mr. Wells recommends that when one of these hives swarms, all the brood combs containing queen cells should be removed and formed into nuclei, their place in the old hive being filled up with frames of empty comb or of full sheets of foundation, and the swarm then be returned to the old hive,

being sure, of course, to put one of the old queens in each side.

By the "Wells" system experienced bee-keepers often obtain very large yields of honey, but it is not to be recommended to tyros. In the latter's hands it too often ends in the queen disappearing from one side of the hive, and practically all the bees being found in the other.

A few years ago the "Wells" system was very popular, and practically every manufacturer of bee appliances made his own particular variety of "Wells" hive (that shown in our illustration was made by Mr. W. P. Meadows, of Syston, Leicester), but at the present moment this hive is only listed by Mr. S. J. Baldwin, of Bromley, Kent, and Mr. George Rose, of 22 Bolton Street, Liverpool.

I would strongly advise anyone who seriously intends to try the "Wells" system to first get Mr. Wells' pamphlet and study it carefully, for it not only tells what to do and what not to do, but it also shows *why* attention to certain details secures success and why failure to attend to other apparently unimportant details leads to complete failure.

## CHAPTER XII.

### *THE DISEASES OF BEES.*

#### Dysentery.

DYSENTERY is caused by one of two things—either the bees have been fed too late in the autumn, or else they have been confined to their hives for a very long time in the winter, owing to the cold; thus they are prevented from taking a clearing flight, and are obliged to void their excrement within their hives: a strong stock, though confined to its hive for a very prolonged period by the cold, is hardly ever attacked by this malady, while weak colonies are very liable to it; therefore, before winter sets in, be sure that all the stocks in the apiary are strong, and unite any weak ones.

The signs of dysentery are quite unmistakable—the hive and combs are much messed by the brown excrement of the bees, the bars of the frames, the inside walls and the alighting-board, etc., being similarly soiled: the excrement emits a strong, peculiar and disagreeable odour. Whatever the cause of the disease, the cure is the same; on the first fine, warm day, when the bees are flying in good numbers, they must be transferred to a new, clean hive, provided with fresh frames of sealed stores. It is very important to supply the bees with new combs, and this should always be done if it is in any way possible; but if not, the bars of the old frames must be scraped clean, and those combs which are the least soiled chosen for placing in the new hive.

When dysentery attacks a stock in winter, there is not so much chance for it as there is when the disease does not make its appearance till spring; in the latter case the new combs on to which the bees are to be transferred need contain but very little honey, as the bees can be fed at once with warm



syrup : by *warm* syrup I do not at all mean so hot as to scald the bees, 98° or 100° Fahr. being quite sufficiently warm ; it should, in fact, not be so hot that the finger will be at all scalded or burnt when dipped in it.

### Foul Brood.

Foul brood, or *Bacillus alvei*, as it is generally known in England, is one of the most dreaded diseases to which bees are subject, and, as it is highly infectious, unless measures are taken to stamp it out immediately whenever and wherever it makes its appearance, there is great danger of the bee-keeper losing all his hives.

As its name implies, it is principally a disease of the brood, though adult bees are occasionally attacked by it.

The signs of foul brood are these : In the first place the young grubs or larvæ die and lie stretched out along the sides of the cells. They turn firstly yellowish and afterwards brown (healthy brood is always pearly white in colour), and then become a putrescent, sticky, coffee-coloured, pappy, ropy mass in the cells. Unless checked in the first stages by the remedies shortly to be described, foul brood is so infectious that it rapidly attacks all the rest of the brood in the hive, and gives off a strong and most nauseous smell, something like bad glue. There is another variety of foul brood (generally known as *Bacillus burri*) which gives off a much less offensive smell, and attacks the larvæ when they are a little older—either just before or just after the brood is sealed.\*

When a colony of bees becomes badly affected with foul brood the cappings of the brood become concave instead of convex.

There is a third variety of foul brood (*Streptococcus apis*), but as it is seldom met with except in conjunction with *Bacillus alvei*, and as the treatment of all three forms of foul brood is the same, we need not more specifically deal with it.

In the earlier stages of foul brood the disease consists of a *bacillus* which can be destroyed in ways hereafter described, but when the disease has killed the brood and the latter has become a coffee-coloured mass (which later on dries up, forming thin brownish flakes on the sides and bottoms of the cells), the bacilli turn into *spores*. These spores, unlike the bacilli, cannot be destroyed by disinfectants unless the disinfectants

\* There is a certain school of bee-keepers in America who hold that the two best known forms of foul brood are caused by *Bacillus larvæ* and *Bacillus pluton* respectively.

are so strong that they would also kill all the bees. The treatment, therefore, which will cure a hive in the early stages of the disease is absolutely useless in the advanced stages, and this fact the bee-keeper must never forget.

*Do not mistake chilled brood for foul brood. If brood becomes too cold it dies, but thereafter, in time, it turns black, never brown, as in foul brood. Later on it dries up and becomes hard; it never forms a sticky, putrescent mass of coffee-coloured, "ropy," or pappy matter, such as is to be found in cases of foul brood.*

### The Treatment of Foul Brood in its First Stages.

We will now deal with the remedies which will cure the disease in its *first* stages, of which the best known are the following:—

#### Salicylic Acid.

This remedy was discovered many years ago, and some bee-keepers still use it with good results. It is used in two



Fig. 41.—Spray Diffuser.

ways—namely, to spray the combs with, and to mix with the food. The solution for spraying the combs is made as follows:—8 grains of salicylic acid, 8 grains of soda-borax, and 1 oz. of water (it is necessary to add the soda-borax, as salicylic acid, by itself, is practically insoluble in water): all the honey in the hive must be uncapped, and the solution projected on to the combs in a fine spray from a spray diffuser (fig. 41).

The syrup with which the bees are fed can be medicated with salicylic acid in the following way:—Take 1 oz. of salicylic acid, and 1 oz. of soda-borax, and mix them in a pint of water; and to every 10 lbs. of sugar made into syrup, add 1 oz. of this solution. (*N.B.*—Two tablespoonfuls equal 1 oz.)

### Phenol.

Phenol is a remedy for which we are indebted to Mr. Cheshire; it is used in the syrup which is given to the bees. The formula is as follows:—

#### SOLUTION No. 1.

Pure phenol in crystals	.	.	.	12	ozs.
Water	.	.	.	3	„
Shake till dissolved.					

#### SOLUTION No. 2.

Solution No. 1	.	.	.	.	1	oz.
Water	.	.	.	.	16	ozs.
Shake till oily appearance is quite gone.						

#### SOLUTION No. 3.

Solution No. 2	.	.	.	.	1	oz.
Sugar syrup	.	.	.	.	16	ozs. or 1 lb.

This is a well-known and much-used remedy; it is found to be good and efficient, although the strong smell which it possesses is rather an objection to its use.

### Formic Acid.

Formic acid was introduced as a cure for foul brood many years ago by Mr. Sproule, since which time it has been largely used with great success; considering its simplicity of application and the rapid cures it effects, it would appear to be a very valuable addition to the list of remedies for foul brood. The form of formic acid used for foul brood is known chemically as a 10 per cent. solution of anhydrous formic acid having a specific gravity of 1.06. Be sure to get this kind of formic acid, as absolute formic acid, or in fact any solution of it stronger than that named, is quite unfit for use with bees, and moreover is very dangerous to handle, causing very painful, ulcerous sores when even the smallest drop is spilt on the

hand. We now come to the way in which formic acid is used: the best method is to pour it into one side of a clean, empty comb, which should be placed at the back of the hive, as far away from the entrance as possible; the acid then by evaporation diffuses itself throughout the hive, destroying the germs of disease. The above is abridged from Mr. Sproule's directions in the *British Bee Journal* for October 2nd, 1890 (which also appeared in *Gleanings*).

Mr. Cowan's method of using formic acid in cases of foul brood, in its early stages, is as follows:—A piece of flannel or sponge should be tacked on to the back of the division board and kept saturated with a solution of formalin composed of 1 oz. of commercial 40 per cent. formalin to each 3 ozs. of water.

### Naphthol Beta.

Naphthol beta has now been used for foul brood a considerable time; and during this period it has proved highly satisfactory, and very excellent results have been obtained by its use. It is a white crystalline powder, possesses very little smell, and, though insoluble in cold water, it dissolves readily in alcohol; when dissolved in this, it should be added to the syrup while the latter is still *hot*, and it will then remain in solution. But it must not be put into the syrup while the latter is *boiling*.

To medicate 18 lbs. of sugar, made into syrup,  $\frac{1}{8}$  oz. naphthol beta is required, while  $\frac{1}{4}$  oz. (avoirdupois) will medicate 36 lbs., and  $\frac{1}{2}$  oz. is required for 72 lbs. Just enough alcohol (rectified spirits of wine) should be added to dissolve the naphthol beta, and the two must be shaken up together; when all the naphthol is dissolved, no more alcohol should be put with it. Candy may be treated in a similar manner, the same amount of naphthol being added to the same quantity of sugar used in making the candy.

### Medicated Syrup for Diseased Bees.

In feeding bees with syrup medicated by one or other of the foregoing methods, except when feeding in late autumn, the syrup should be thin—*i.e.*, it should be made with 3 lbs. of sugar to each quart of water, because the nurse bees will then be more inclined to feed the young brood (larvæ) with

it than to store it (which they would do if the syrup were thick), and thus the disease will be more rapidly cured.

The best feeder to use for diseased bees is Taylor's "Physic" Feeder, which is manufactured by Messrs E. H.

Taylor Ltd., of Welwyn, Herts. This feeder consists of framed tiers of metal troughs, between the uppermost of which and the top bar of the frame a bee space is provided. It should be placed in the centre of the brood nest by removing one of the

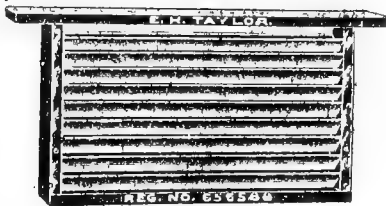

Fig. 41a.—Taylor's "Physic" Feeder.

frames, the object being to get the bees to take the syrup down immediately the first sign of the disease is noticed, and also to bring the syrup up to the same degree of heat as the centre of the brood nest, so that volatile disinfecting vapour may be given off and the syrup consumed rapidly even in the middle of summer when it is often difficult to get bees to accept syrup if honey is coming in very freely from the fields.

### Treatment of Foul Brood in its more Advanced Stages.

Hitherto we have only treated of those remedies which will cure foul brood in its *first* stages: when, however, a great part of the brood has become coffee-coloured, and when the combs contain irregular patches of brood with sunken and perforated cappings to many of those brood cells that are sealed, the disease has reached so advanced a stage that we may be sure spores are present, and when this is the case the remedies (all disinfectants) that have already been detailed would be unable to cure the disease.

If, therefore, the diseased stock is a weak one, the best and safest thing to do will be to destroy the bees, combs, and quilts, and *thoroughly* disinfect the hive, before our other (or our neighbours') bees are contaminated by this plague. The destruction should be effected in the following manner: a hole about one foot deep, and a little smaller than the hive, should be dug in the ground. In the evening, when the bees

have ceased flying, some sulphur should be lighted in the bottom of this hole, and the hive, removed from its floor-board, should be placed over it, care being taken that the quilts are tucked in all around at the top of the frames, so as to prevent any bees from escaping. The fumes from the burning sulphur will suffocate the bees, and when they are dead the combs, frames, dead bees, and the quilts must *all* be burnt, as they harbour the spores, which are capable of lying dormant for astonishingly long periods, and afterwards, when the bee-keeper might suppose all danger past, these spores, under favourable circumstances, suddenly develop and restart the disease afresh in the apiary. The hive and its stand must be *thoroughly* scrubbed, inside and out, with boiling water and strong soap, and then painted all over (again inside and out) with a solution of one part of Calvert's No. 5 carbolic acid to each two parts of water. Take care that the carbolic solution is *thoroughly* worked into every joint and crevice. The site where the diseased stock stood must be dug up and the earth turned over for a radius of at least 6 feet around the old stand. When—but only when—by exposure to sun and air the smell of carbolic has passed away (and this will take some time) the hive may be used again.

#### “Starvation” or “Fasting” Cure for Foul Brood.

If, however, the diseased stock is still strong in bees, it may be cured by what is known as the “starvation” or “fasting” method. This consists in shaking all the bees off the combs into an empty box or straw skep—an operation which should be performed towards evening when the bees have ceased to fly, lest some may enter other hives and carry the disease with them. The bottom of the box or skep should then be covered with cheese cloth (a very coarse sort of muslin which admits the air freely), and placed in a cool, *dark* cellar, the box or skep being stood on two small strips of wood about 1 or 1½ inches thick (sticks will do) so as to raise it from the floor and thus secure a thorough current of air underneath; this is most important, as otherwise the bees would be smothered. The reason for placing the bees in the dark is that, if left in the light, they would make such frantic efforts to get out that many would become worn out and die.

While the bees are in the cellar all the combs, frames, and

quilts must be burnt, the hive thoroughly disinfected as just explained, the site dug over, and a fresh, clean hive prepared in its place, the frames in which must be fitted with starters of foundation only. These starters should be only  $\frac{1}{2}$  inch deep.

After being kept in the cellar for forty-eight hours, *without any food whatever*, the bees should be put into the fresh hive, like an ordinary swarm, and fed on medicated syrup. Syrup medicated with naphthol beta (see page 84) is in my opinion best for the purpose.

As the box or skep in which the bees were confined *must be destroyed*; it is best to use a box, since skeps are more expensive.

Bee-keepers must remember that *honey* is one of the most frequent and one of the most dangerous sources of infection, as it harbours the spores. It is, then, needless to say that healthy colonies of bees must never be fed with honey from diseased or suspected colonies. Indeed, in my opinion, it is *always* best to feed bees with syrup and not with honey, and in localities where it is suspected that foul brood may possibly exist it will always be best, whenever feeding is necessary, to feed the bees with syrup medicated with naphthol beta. Candy, when it is used, may be medicated in just the same way as syrup.

As the stocks which are most liable to be attacked by foul brood are those whose vitality is weakest, it is often found very helpful in curing foul brood, if the stock happens to be headed by an unsatisfactory queen, to destroy her and to introduce another in her place.

**The Bee-keeper must always Disinfect Himself most Thoroughly after Handling any Diseased or Suspected Stock before he Attempts to Open or Handle a Healthy One.**

Wherever possible, a bee-keeper should bare his arms to the elbow before handling a diseased or even a suspected hive, *and afterwards he must be most careful to disinfect himself thoroughly before he opens a healthy hive* by thoroughly washing his hands and arms with strong carbolic soap and thoroughly spraying his clothes and washing any appliances that have been used with a solution of 1 oz. of Calvert's No. 5 carbolic acid to 12 ozs. of water.

Robbing must be carefully guarded against when disease is present or suspected, as it is a most fruitful source of spreading the contagion.

### Prevention Better than Cure.

Naphthol beta and formalin are the two remedies now most generally used for the cure of foul brood, but the bee-keeper should remember the old adage that "Prevention is better than cure"; and if he knows that foul brood exists in the neighbourhood or in the apiary, he must *immediately* take steps to prevent the other hives from catching it. A very good preventive is naphthaline (do not confound this with naphthol beta, which is used in the bees' food; naphthaline is quite a different thing, and must *never* be used in this way); it possesses a strong smell, and can be obtained in white crystalline flakes and in sticks; whichever form is used, care must be taken to have it quite pure. Of flake naphthaline, as much as can be heaped on a sixpence should be placed on the floor-board, at the back of the hive, as far from the entrance as possible. If we are using the stick naphthaline, one or two pieces as large as a small nut will be found sufficient. Naphthaline evaporates, especially the flake naphthaline, and the supply of it must therefore be renewed in the hive every ten or twelve days—in winter it does not evaporate so quickly, and so will not need to be supplied to the bees so often.

### Cleanliness.

Both in the prevention and in the cure of any bee disease, whether it be simple dysentery, foul brood, or Isle of Wight disease, cleanliness is of the greatest importance. Floor-boards should be kept clean and well scraped, and no *débris* of any kind should be allowed to accumulate about the apiary.

### Isle of Wight Bee Disease.

Isle of Wight bee disease, or *Microsporidiosis*, as it is sometimes called, is the most terrible scourge to which bees are subject. It appeared first in the Isle of Wight in 1904, and, spreading to the mainland, it gradually worked its way up northwards to Scotland and Ireland, carrying devastation



wherever it appeared. So terrible is this scourge that an authority as painstaking and eminent as Mr. T. W. Cowan tells us in the *British Bee Journal* for March 4th, 1920, that, from carefully compiled statistics, it has been proved that about 90 per cent. of the colonies of bees that existed in Somersetshire had been destroyed by this disease; and much the same has happened in every other county.

The origin of this disease is still very obscure. For long it was thought that it was caused by the existence in large numbers in the bee's chyle, stomach, or intestine of tiny microscopic animal parasites or protozoans known as *Nosema apis*; but, as this protozoan is also found to be present in other diseases of bees, which have nothing to do with Isle of Wight disease, it became doubtful whether it was really the *root* cause of this disease. A great deal of careful research work has since been carried out both by independent men of science and by the Government. Drs. Rennie and Wood state\* that it is caused by a parasitic organism of the *Acharea* family (which they have named *Tarsonemus Woodi*) invading the respiratory organs.

### Symptoms of Isle of Wight Disease.

In the early stages of the disease the bee-keeper will notice that many of the bees, as they issue from the hive entrance, are unable to fly. They wander listlessly about the alighting-board, falling off it after a time, and then crawl about the ground and on blades of grass, etc. As evening approaches, they generally collect in clusters for warmth, but soon become chilled through in the night and die. These bees are known as "crawlers."

On the other hand, other of the bees that are affected by this disease dart quickly from the entrance and succeed in flying a considerable distance from the hive.

*With reference to "crawlers," afflicted with Isle of Wight disease, the bee-keeper must be particularly careful not to confuse bees which, in perfectly healthy hives, returning heavily laden from the fields, sometimes miss the alighting-board (especially in windy weather), and falling to the ground, crawl about for a while, being too tired to rise again at the moment.*

\* "Isle of Wight Disease in Hive Bees," by John Rennie, D.Sc., P. B. White, B.Sc., and Elsie J. Harvey, published by R. Grant & Son, Edinburgh, price 9s.

*These bees often get chilled through, if the weather is cool, and eventually die.*

Sometimes the diseased bees lose the use of their legs, or of one pair of them.

As the disease advances, the abdomens of the affected bees become swollen, and assume a dull black appearance, and very often the wings stand out in an abnormal manner, and become what is commonly called "dislocated." Often the diseased bees lose the hairs on their abdomens; but the bee-keeper must be careful not to confuse such diseased bees with perfectly healthy *lean* old bees (to be found in most healthy hives) whose abdomens have become black, shiny, and hairless with hard work.

In Isle of Wight disease, the bees sometimes soil their hives and combs with their excrement (for which reason certain people have styled it *Malignant Dysentery*), but in other cases they do not.

It must be clearly understood that the symptoms vary greatly, and also that the progress of the disease is sometimes very slow, and at others exceedingly rapid.

The disease, though occasionally met with in other parts of the world, does not appear at the present day to have the same virulence on the Continent that it displays in England. Whether, like the African cattle plague *Rinderpest*, which every now and then sweeps as a terrible scourge through the continent of Africa, Isle of Wight disease has ever attacked bees in Europe in epidemic form before 1904, it is difficult to say; but for myself I am inclined to think that it has, for in old works on bees we read, for example, that in 1790 "Bees of late years have been troubled with a nasty dysentery which doth destroy a full stock in a very short time,"\* while thirty to forty years later we read, "Dysentery in our bees doth greatly trouble us, and a traveller from Holland reports that many thousands of stocks have died in that country."

### Cures and Prevention.

Although no certain cause and no certain cure, which will work infallibly in all cases, have as yet been found for Isle of Wight disease, experience and experiment have proved certain broad principles quite conclusively. For example,

\* Ordinary dysentery is not so rapid as this.

Italian and certain hybrid races of bees, though not in every case immune, are found to be far less liable to the disease than the ordinary native English brown or "black" bee. It is for this reason that the Board of Agriculture has latterly imported many thousands of Italian queens and made them available for British bee-keepers at very low prices, and they have further encouraged the importation of Dutch bees on a large scale for the restocking of apiaries which have been depleted (and in some cases entirely destroyed) by the Isle of Wight disease. Dutch bees, and the hybrids bred from them, are found, like Italians, to resist the disease better than English bees, but many people find they swarm excessively.

I have just pointed out that certain hybrids resist the disease better than our pure-bred native bees, but the bee-keeper who contemplates breeding queens for the purpose of restocking his apiary with hybrids will do well to bear in mind what I have already drawn particular attention to, with regard to hybrids, in Chapter III.—namely, that an Italian or Carniolan queen crossed with an English drone generally produces workers which, although they are good honey gatherers, are usually very vicious and difficult to handle; while, on the other hand, an English queen, mated with an Italian or Carniolan drone, generally produces workers which are both good honey producers and gentle when handled. But it must be borne in mind that these English queens, generally speaking, are not so prolific as either Italians or Carniolans. Since, however, in the second generation, such lack of prolificness tends to disappear, probably the best results of all would be obtained by breeding our queens from English mothers which had been crossed with Italian drones, and mating the virgin queens thus bred with Carniolan drones; or, if the English mother had been mated with a Carniolan instead of an Italian drone, we should endeavour to have the virgin queens bred from her mated with Italian drones.

Although it occasionally happens that the strongest stocks in the apiary are the first to be attacked by Isle of Wight disease, yet it is *generally* the stocks whose vitality is lowest—that is to say, the stocks which are headed by weak or inferior queens—that are most subject to be attacked. The

importance, therefore, of keeping all stocks headed by *vigorous* Italian or hybrid queens (whether the bee-keeper imports them or breeds them himself) must be manifest to all.\*

Certain disinfectants, such as Bacterol, Izal, and Flavine, are recommended for the cure of Isle of Wight bee disease. They should be used both as sprays, and also to medicate the syrup fed to the bees, in the proportions indicated on the bottles sold by the dealers in bee goods. "Apicure," advertised by the proprietor of the *British Bee Journal*, is also recommended for curing this disease.

When medicated food is fed to the bees for this purpose it is best fed to them in Taylor's "Physic" feeder (fig. 41a) as in the case of foul brood; and the syrup used for such feeding should (except in late autumn) be thin—made with 3 lbs. of sugar to each quart of water.

Whether Isle of Wight disease is infectious or not is a moot point, but as it is certainly highly contagious, it will be best, if the stock attacked be a weak one, to smother the bees with sulphur in the manner described in the case of foul brood, and to burn *all* the quilts, combs, and frames, as well as the dead bees, while the hives must be *most* thoroughly disinfected

\* In this connection the experience of an American bee-keeper, Mr. Wm. Belshaw, Everett, published in the *British Bee Journal* of 3rd February 1921, is of great interest:—

"To give you some idea how I would treat Isle of Wight disease," says Mr. Belshaw, "I will first give as near as I can Nature's way as I saw it, and which seemed to be good. Six hives were badly affected in the spring; my hives were on a bench 3 feet from the ground, the cripples coming out and falling to the ground. Honey was coming in from spring flowers, brood rearing going on in all the hives, sick and healthy alike, bees were increasing in numbers notwithstanding the heavy loss of sick and dying, and they eventually swarmed.

"I was on hand in each case, and while watching them I noticed they had lost their queen, and saw several bees go back to the hive to hunt for her. I then began to look for her myself, and found her 4 feet from the hive, crawling on the grass unable to fly. I picked her up, put her on a stake thinking the bees would cluster around her, but they did not, and paid no attention to her whatever. The bees returned to the hive and raised another queen.

"My experience with the other hives was similar to this, only most of the queens got lost in the weeds, and neither me nor the bees were able to find them. In every case where the queen was lost in the swarming process, and another one raised to take her place, these colonies quickly recovered from the disease; in fact, as soon as the young queen got to laying, there was no disease to be seen.

"I studied the matter over for some time, and came to these conclusions: That the queen was able to go on with her egg laying although her wings might be useless, but when she was required to go with the swarm she fell to the ground like a crippled worker bee. The reason why the bees could not find her after she went out was, they would hunt for her by scent, and she being diseased, her odour would be repulsive instead of attractive to them.

"The diseased queen being lost in the swarming process eliminated the chief centre of infection in each hive. The raising of a new queen out of the bunch of cells gave Nature an opportunity to develop and select, by the survival of the fittest among them, a queen with greater resistance to the disease."

by first scrubbing them inside and out with boiling water and strong soap, and afterwards painting them over very liberally with a solution of one part of Calvert's No. 5 carbolic acid to each two parts of water, taking care that this solution soaks *thoroughly* into every joint and cranny, just as in the case of foul brood. After exposure to sun and air, until the smell of carbolic has passed off, the hives may be used again.

Stray swarms that have taken possession of old hives and combs in which the former bees had died of Isle of Wight disease have occasionally failed to contract the disease themselves. But this is no more proof that the disease is not infectious than the well-known fact that many nurses in infectious fever hospitals never contract fever themselves is proof that many virulent fevers are not both infectious and contagious.

#### Need for Adequate Ventilation.

Bee-keepers ought always to bear in mind that lack of proper ventilation is a contributory cause of Isle of Wight disease.

#### Disinfection.

The bee-keeper, after handling any hive infected, or suspected of being infected, with Isle of Wight disease, must take the same precautions to disinfect himself and any appliances he may have used very thoroughly before he manipulates another hive, as are necessary (and have been described) in the case of foul brood. Needless to say, he must never put a comb, quilt, or anything else from a diseased hive into a healthy one.

## CHAPTER XIII.

### *FINAL HINTS.*

#### **Keep all Stocks Strong.**

IN working for honey remember that the most important point of all to bear in mind is the bee-keeper's motto, "Keep all stocks strong."

#### **Manipulating.**

When handling bees, be cool and confident, do not make any sudden movements, and be careful not to jar the hive in any way. If a person is afraid of bees they soon find it out, while if he is quiet and firm he but seldom receives any stings.

#### **Use Cane Sugar.**

IN feeding bees, be careful never to use beet sugar, but always refined cane. Beet sugar, if stored by the bees so that it is consumed in winter when they cannot get out for cleansing flights, will soon cause dysentery.

#### **Easy Method of Extracting Wax from Combs.**

For extracting the wax from old combs in small quantities, the following method answers very well. Get a biscuit tin and punch a number of small holes in the bottom of it; then fill it up with the odds and ends of wax, broken pieces of comb, etc.; place the tin over a vessel containing water, so that the bottom of the tin is at least  $\frac{1}{2}$  inch above the water in the vessel below. Place the whole in the oven, and the wax will be melted and drain through the holes in the bottom of the tin, leaving the residue behind. The oven needs to be very hot to melt out *all* the wax: care must be taken to keep the vessel below full of water, otherwise the wax will stick to its sides, and may burn, if the oven is very hot indeed. This method of rendering wax is thoroughly practical, and will

be found useful by those who do not possess the Swiss Wax Extractor, which is decidedly expensive. Nevertheless, it is seldom possible to extract *quite* all of the wax from the combs without a Swiss Extractor, and if many old combs are melted down this failure to extract the last particle of wax from each comb will entail a loss in the long run.

### Do not Hive Swarms on Full Sheets of Foundation Only.

Do not hive a swarm—particularly a large one—on full sheets of foundation alone, for its weight, especially in hot weather, is liable to break them down unless at least three frames containing already drawn-out comb are interspersed between the full sheets of foundation. If no frames of drawn-out comb at all are available it will be better to hive a swarm on frames containing “starters” of foundation 1 inch deep only.

### Do not Extract from Combs containing Brood.

Do not, where possible, extract from combs containing brood, more especially unsealed brood. Not only is it likely to throw a large quantity of unsealed brood out into the extractor, but it is very liable to chill and kill the brood, particularly in cool weather. So experienced an authority as Simmins claims that large quantities of brood chilled thus will cause foul brood. Be this as it may, no much better “culture” for the germination of any germs of foul brood that may exist could possibly be found than brood “chilled” and killed in this way.

### Plinths and Hive Legs.

If the absolutely straight plinths shown in *a*, fig. 6 (page 17), are used in the construction of a beehive, the upper storeys and the roof, unless made a little larger than the body box, will constantly stick tight when we try to handle them. To avoid this inconvenience manufacturers of beehives generally use the style of plinth shown in fig. 42. Many amateurs who make their own hives would find some difficulty in making plinths of this kind, and such people can



Fig. 42.—The best sort of Plinth for Beehives.

now buy these plinths separately from Mr. Edward J. Burt, of Stroud Road, Gloucester.

Legs (fig. 43) which can be screwed to any beehive may similarly be bought separately.



Fig. 43.—Screw-on Leg for Beehive.

### Packing Bees for Travelling by Road or Rail.

In packing bees to travel by road or rail, it is necessary to take care that the combs are not too heavily stored with honey, particularly in hot weather, as otherwise only a horrible mixture of dead bees, broken combs, and oozing honey, all lying in a mass at the bottom of the travelling crate or hive, is likely to arrive at the journey's end.

In packing straw skeps for a journey, several thin pointed sticks (such as gardeners use for staking carnations and other tall growing flowers to) should be stuck right through the skeps in various directions three or four days before the bees are to be dispatched. The bees will then fasten the combs securely to these sticks which have been thrust through them, and the combs will be better held in place. The straw skep should then be turned bottom upwards, and two thicknesses of strong gauze or muslin tied over its bottom (now uppermost), and in this position (bottom uppermost) it should travel.

Bees, when forcibly confined to their hives in this way, are thrown into such a state of excitement that the temperature of the hive is raised immediately, and unless abundance of air were admitted the bees would be suffocated.

When stocks of bees on bar-frames are to be sent by road or rail a wooden frame covered with perforated zinc or fine mesh wire gauze must be screwed over the top of the hive as shown in fig. 44, and a piece of perforated zinc or wire gauze must also

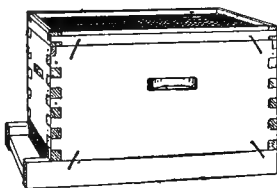

Fig. 44.—Hive of Bees prepared for Travelling.



be nailed over the entrance of the hive, whilst the lower parts of the frames must be kept from jolting one against the other by means of a wooden distance rack (fig. 45), which is nailed to the floor of the hive or travelling



Fig. 45.—Wooden Distance Racks for keeping Bar-Frames in Place.

crate, and into the slots of which the bottom bars of the frames fit. Where metal ends (fig. 7) are used, these will keep the tops of the frames in place, otherwise another similar distance rack must be furnished at each end of the tops of the frames also, to keep them in their place.

### The Final and most Important Hint of all—The Golden Rule of Bee-Keeping—“Keep all Colonies Strong.”

The bar-frame or movable comb hive, without which bee-keeping, as we understand it to-day, could never have existed, was invented by the Rev. L. L. Langstroth in October 1853. His book, “The Hive and Honey Bee,”\* is still, and is always likely to remain, the classic work on apiculture. The parting words of advice, with which he closes his classic, are as true and important to-day as when he wrote them seven and fifty years ago. “The essence of all profitable bee-keeping,” he says, “is contained in the Golden Rule, ‘KEEP YOUR STOCKS STRONG.’ If you cannot succeed in doing this, the more money you invest in bees, the heavier will be your losses; while, if your stocks are strong, you will show you are a *bee-master*, as well as a bee-keeper, and may safely calculate on generous returns from your industrious subjects.”

\* “The Hive and Honey Bee,” by L. L. Langstroth, revised by Dadant, is published by Dadant & Sons, Hamilton, Illinois, U.S.A., price \$1.50. A reprint of the first edition, exactly as it was originally written, and which is of much greater interest to many lovers of bee-keeping, is also obtainable from the A. I. Root Co., of Medina, Ohio, U.S.A., price \$1.00.



## PART II.

BEE-KEEPING IN HOT CLIMATES.



## CHAPTER XIV.

### *BEE-KEEPING IN HOT CLIMATES.*

#### **Thick Wood should be used for the construction of Bee-hives in Hot Climates.**

THE first thing to note in keeping bees in hot climates is that the wood of which the bee-hives are made should be thick—at least  $\frac{7}{8}$  inch or 1 inch thick—firstly as being less liable to warp under the fierce rays of the sun, and secondly as affording more protection to the bees from the heat.

More attention also is necessary in shading hives that are very much exposed to the sun, and it is desirable whenever possible in arranging an apiary to keep the hives under the sheltering shade of trees and shrubs.

#### **Frequent Removal of Surplus Honey is advisable.**

In many parts of Australia and Africa, where the honey flow lasts practically throughout the year, it is found very necessary to remove the honey at frequent intervals, or the bees apparently become accustomed to the unfailing supply of their wants from field or veldt at every period of the year, and often show a tendency to gather but little surplus beyond their everyday requirements.

#### **The Best Method of artificially increasing the Number of Stocks of Bees in Hot Climates.**

In warm climates, where the honey flow lasts for many months out of each year, the number of our colonies of bees can be increased with much greater ease than in the cold climate of Great Britain, with its comparatively short honey flow. In these warm parts only a few hundred bees are required in each nucleus to insure the mating of the queens, provided that robbing is carefully guarded against; and the nuclei can subsequently be built up into strong

colonies with the greatest ease by giving combs of hatching brood at intervals of a few days, the chances of such brood being chilled by the paucity in number of bees to cover it being infinitely less than in England,

### Sections should be used as Miniature Frames in Baby Nucleus Hives.

In forming very small or "Baby" nuclei, as they are called, the use of  $4\frac{1}{4}$ -inch by  $4\frac{1}{4}$ -inch sections in place of frames, or of tiny frames  $4\frac{1}{4}$  inches by  $4\frac{1}{4}$  inches inside measure (just large enough to hold one section), will be found very advantageous.

### South African Standard Size Frames.

In South Africa I long ago introduced a frame, similar to the British Standard size except that it is  $\frac{5}{8}$  inch deeper (*i.e.*,  $9\frac{1}{8}$  inches instead of  $8\frac{1}{2}$  inches deep) and the side bars are  $\frac{5}{8}$  inch thick instead of  $\frac{1}{4}$  inch, while the bottom bars are  $\frac{1}{4}$  inch thick instead of  $\frac{1}{8}$  inch. This leaves a space inside the bars of  $12\frac{3}{4}$  inches by  $8\frac{1}{2}$  inches, or exactly sufficient to hold six sections  $4\frac{1}{4}$  inches by  $4\frac{1}{4}$  inches.

### Preparing Sections to put into Frames.

To cut the sections down to the necessary width (*i.e.*, not less than  $\frac{3}{4}$  inch or more than 1 inch) to fit into one of these frames, the ordinary  $1\frac{1}{2}$  inch or 2 inches wide sections are sawn down the middle, each original section thus making two narrow ones. These sections are then fitted with full sheets of brood foundation, and placed in the frames. If they fit loosely they must be jammed into the frames with tiny wedges of wood, so as to hold them firmly in their place; and the frame will then be ready to insert in the brood nest of a strong hive, as described later on. In fitting up sections in frames, the two-bee-way sections should be chosen in preference to the four-way, while the best sections of all for this work are those which are perfectly plain and without any bee-ways at all (fig. 46). When these latter sections are used, anyone accustomed to do carpentering or joinery work will find it very much easier and quicker to cut them down the middle,

with what carpenters call a "cutting gauge," instead of using a saw.

### No-Bee-Way Sections.

These plain sections, called "No-bee-way" sections, were introduced a few years ago in America; but they have found little favour in England, and have never gained a foothold



Fig. 46.—Plain or "No-Bee-Way" Sections in the Flat and made up.

there. They are, however, very extensively used, not only in America, but throughout most of our colonies.

When using No-bee-way sections in section racks it is necessary, in place of the ordinary dividers illustrated on page 39 (fig. 26), to use a special wood divider or "fence," as it is called, illustrated in fig. 47, which provides the necessary space between the sections for the passage of the bees by means of the small battens or uprights which fit against the

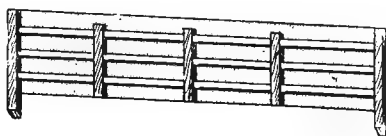

Fig. 47.—Fence Divider for use with No-Bee-Way Sections.

edges of the sections. These dividers are objectionable, being so flimsy that they are liable to warp, and are very easily damaged and broken. The sections also, for ordinary work, are objectionable, since whenever the honey comb extends even an eighth part of an inch beyond the woodwork—as it sometimes does—it is liable to get crushed and damaged in packing; but for the purpose of splitting in half to put into frames for forming baby nuclei no section is so suitable.

### Hatching Brood in Chicken Incubators.

Having selected a good strong colony from which to form our nuclei, we should go to it and remove all frames that do not contain brood; thus crowding the bees somewhat. In the very centre of the brood nest we then insert a frame of sections fitted with full sheets of foundation. Forty-eight hours afterwards we must examine the hive, and if the foundation in the frame of sections has been drawn out and is full of eggs—as it should be—we write on it the date on which it was inserted (so that we may know on what date the brood is due to hatch) and return it to the hive, adding another frame of sections as well, also near the centre of the brood nest, and repeating this operation every two or three days until such time as we find that the frame last inserted is not full of eggs, when we must wait until it is full before inserting another frame.

So soon as the brood in the sections in the first frame we inserted is capped over, we withdraw the frame, and taking the sections out of it, place them in an ordinary chicken incubator, which should be kept up to a temperature of from 85° to 95° Fahrenheit. This is done, not only to relieve the bees in the hive of all further trouble in connection with this brood, and thus enable them to draw out the comb and bring up brood in the six other sections which we shall give them in place of the frame of sealed brood we have withdrawn, but it is for another purpose as well.

The experience of the merest tyro who has attempted but a few times to artificially increase the number of his hives will have impressed upon him very strongly the fact that the greatest difficulty he has to contend with, in the formation even of large nuclei, is the number of bees which leave the nuclei and return to the old stock or its stand, thereby so depleting the new nuclei of their population as to bring about failures innumerable. This being so with strong nuclei, how much more is it the case with baby nuclei!

It is, therefore, to entirely do away with this difficulty that I find it best to resort to an incubator. The nuclei are then entirely made up of young bees from it, which, no matter how small the lots into which we divide them, will not



desert their baby hives, never having known any other home to which they could return. Moreover, up to the age of two days or so they will accept any queen—whether virgin or fertile—we may wish to give them, without any formalities of introduction.

For hatching small lots of bees I have found the "Texas" incubators quite satisfactory. They are made by the New Poultry Syndicate, of Clonbrock Road, Stoke Newington, London, and are quite the cheapest obtainable, the 15 egg size (which will hold six sections) costing only 16s. complete, while the 30 egg size (which will hold a dozen or more sections) costs 21s. Before the war these incubators cost 2s. 6d. and 5s. each respectively. As it is not necessary to maintain such high temperature for hatching bees as chickens, the tin lid of this incubator may be dispensed with, while the felt cover provided with the machine should be supplemented with some more felt or flannel to keep out the cold that may enter at spots where the felt cover does not quite cover up the sections, which in most cases stand a little higher than the edge of the incubator's outer case. Care must, however, be taken to leave little holes or spaces for ventilation. In all other respects the printed directions for hatching hens' eggs, sent with each of these incubators, should be followed, excepting that the sand in the tin should not be wetted, and the heat we should aim at maintaining should be from 85° to 95°.

When nuclei are to be formed on a large scale these little incubators are, of course, quite inadequate. A very large chicken incubator should then be employed, although with care I have used an ordinary plant propagator (which is much cheaper) with great success.

### Converting Sections into Miniature Frames.

Before placing the sections of sealed brood in the incubator, a thin strip of wood,  $4\frac{3}{4}$  inches long by  $\frac{7}{8}$  inch broad and  $\frac{1}{4}$  inch thick, should be screwed to the top of each section with little screws  $\frac{1}{2}$  inch long. These strips or bars will thus extend  $\frac{1}{2}$  inch beyond the sides of the sections, and, becoming thin top bars, will convert each section into a little frame, which, when the bees are hatched out, we may hang in a little nucleus

hive (fig. 48). But where more than two or three nuclei are to be made each season it will be found much quicker and easier (instead of screwing little bars to the top of each section) to make small frames (fig. 48, c), each exactly  $4\frac{1}{4}$  inches by  $4\frac{1}{4}$  inches *inside measurement*, into which a section can be slipped in a moment. These frames should be made of wood  $\frac{1}{4}$  inch thick, and where they are used, the nucleus hives should be made  $\frac{1}{2}$  inch wider than shown in the illus-

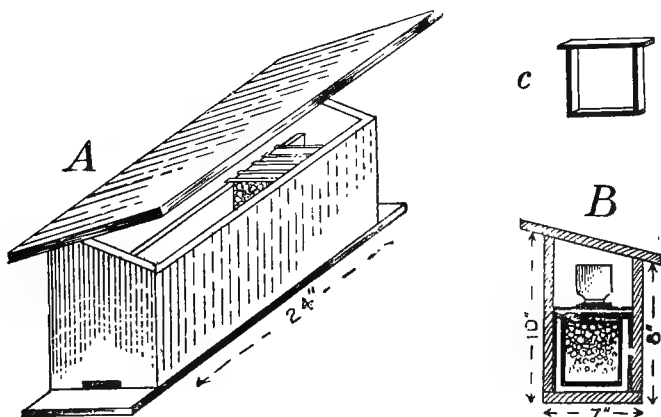

Fig. 48.—A, Baby Nucleus Hive, made of wood  $\frac{3}{4}$  inch thick; B, Section of same hive, showing feeder and quilt; C, Miniature frame,  $4\frac{1}{4}$  inches by  $4\frac{1}{4}$  inches inside measurement, to hold one section.

tration (*i.e.*,  $7\frac{1}{2}$  inches instead of 7 inches, as there shown), to allow for the additional thickness of the side bars of the frames. The side walls of the nucleus hives should be made of wood  $\frac{3}{4}$  inch thick, and along the lower portions of these sides, on the inside of the hive, strips of wood 5 inches wide and a *full*  $\frac{1}{4}$  inch thick (shown in black in the illustration, fig. 48, B) should be nailed for the top bars of the little frames to rest on.

Where practicable, I prefer not to move the bees from the incubator to the nucleus hives until twenty-four hours after they are hatched.

In a warm climate the bees hatched from three sections will be quite enough to form a baby nucleus. They should be given one frame (section) of stores—*i.e.* honey or syrup, both sealed and unsealed—and two frames (sections) of the combs from which they have hatched, or some others containing sealed brood which is due to hatch within a few days; and last, but not least, a newly hatched virgin queen or a ripe queen cell. These nuclei, when made up, should be placed in a warm room for from two to four days (two days if we have given them a queen, four days if we have given them a queen cell), the entrances kept closed meanwhile with perforated zinc.

After this time has elapsed the workers will be old enough to defend their little hives, which must then be put out in a shady place in the apiary, allowing, where room permits, a space of about 5 feet between each nucleus, in order to avoid the chance of mishaps through the queens, when returning from their mating trips, entering the wrong hives by mistake and thus getting killed.

### **Beware of Robbing.**

A sharp look-out must be kept for robbing, and on the first appearance of it the entrance of the hive attacked must be reduced to such a size as will allow only one bee to pass at a time. If this does not check it, the entrance of the hive attacked must be closed altogether with perforated zinc for a day or two.

### **Baby Nuclei must always be fed, no matter what the Time of Year.**

As soon as the nucleus hives have been placed in position, they should be gently and regularly fed with a stimulative feeder, similar to that shown in fig. 34, p. 52, except that in this case a bottle holding a quarter of a pound of syrup will be amply big enough, and that need only be half filled and given twice or three times a week, according to the size of the nucleus. When using the stimulative feeders, care should be taken to see that a thin cork wad is placed between the top of the bottle's neck and the metal cap that screws on to the bottle, a piece about the size of a shilling being cut out of the centre of the wad over the place where the holes have

been pierced in the cap. Without the cork wad the syrup will leak out when the bottle is inverted.

Another excellent stimulative feeder is that known as the "Perfection" (fig. 49), in which the supply of food may be regulated from one to nine holes by moving the index round; but I think that far the best feeder of all for these baby nucleus hives is a little dummy board feeder of the kind shown in fig. 36c, page 63.

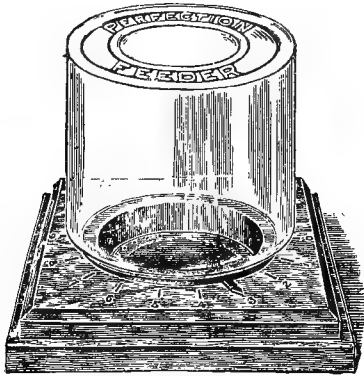

Fig. 49. — "Perfection" Feeder.

### Baby Nucleus Hive.

The nucleus hive, shown in fig. 48, being 24 inches long inside, and having a flight hole and alighting-board at each end, may be used as a twin hive when so desired, the two nuclei being divided from each other by a dummy in the centre of the hive. This dummy may be either of plain wood, or perforated after the manner of the Wells dummy (see page 77); but whichever form of dummy is used, the quilt should be firmly nailed all along its top edge to prevent any chance of the bees from one nucleus finding their way into the other.

### Rapid Method of Building up Baby Nuclei into Strong Stocks.

Such nuclei may be very rapidly built up, as soon as we have ascertained that the queens are mated and laying, or even before that if we choose, by the addition of sections of newly hatched bees from the incubator or of sealed brood

from the hives. As soon as there are enough bees in these nuclei—say, for example, as soon as they contain the bees hatched out of six to nine sections—we should unscrew the top bars from the sections, pack these sections into full-sized frames again, and transfer them, bees and all, from the nucleus hives into ordinary sized hives, which we must place on the stands or sites occupied by the nuclei, adding to each nucleus a large frame of sealed brood from some other hive. At intervals of a few days, as the brood hatches, other frames of sealed brood may be added, and in this way a baby nucleus may be built up into a strong stock in three weeks.

### **Take a Little Brood from Each Stock in the Apiary.**

The brood may be taken from various stocks in the apiary, and in such small quantities from each that no one hive is appreciably weakened by the loss.

In practice the advantage of using frames filled with sections will soon become apparent where small nuclei are to be formed and incubators employed in the way just explained. Where incubators are used they are indeed an absolute necessity; for, while it very seldom happens that we can find a whole frame filled with sealed brood without any unsealed brood in any part of it (which, of course, would unfit it for insertion in an incubator), it is no difficult matter to pick out plenty of these little  $4\frac{1}{4}$  inch by  $4\frac{1}{4}$  inch sections filled with nothing but sealed brood on both sides, returning the other sections to the hive for a few days until the unsealed larvæ in them shall have been sealed over, when they also may be removed to the incubator.

### **Hatching Queens in Incubators.**

We can also get our queen cells built in sections if we wish and remove them, when sealed, to the incubator. In this case care must be taken to separate the queen cells a day or two before the queens are due to hatch, placing each cell in a little cage or box formed of perforated zinc or wire gauze, in which there must be some unsealed honey for the young queen, when hatched, to feed on. I like also, when possible, to put four or five newly hatched workers in each of these cages to attend to the queen when hatched; they may be

left thus for several days, although it is best to place the young queen in her nucleus as soon after she is hatched as possible.

### How to make and use a Natural Incubator.

In very favourable climates, when artificial incubators are not obtainable, a natural incubator, depending for its temperature on the heat from a strong hive of bees, may often be used successfully. This is simply made of a shallow doubling box, 6 inches deep, with a sheet of fine wire gauze or perforated zinc nailed over the bottom. This is placed over the body box of a very strong hive, from which the quilts, all except one very thin one of wool or calico, have been removed. The sections of sealed brood and a thermometer are then put in it, and covered up very warmly with many thicknesses of flannel. If the doubling box has double walls on all sides, with an intervening space of  $1\frac{1}{2}$  to 2 inches between the inner and outer walls filled with cork dust or sawdust, the plan is all the more likely to succeed.

### The late C. L. Pratt's Methods of Managing Baby Nuclei.

The most useful books on the formation and management of baby nuclei (as well, incidentally, as the safe introduction of queens) are those by the late Mr. Pratt, who wrote under the *nom de plume* of "Swarthmore." They were published in America, and were formerly obtainable at the offices of the *British Bee Journal*, but they are now out of print and very difficult to obtain.

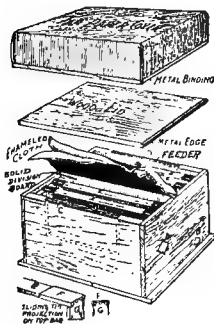

Fig. 50.—The Baby Nucleus Hive recommended by the late Mr. Pratt.

To those who keep bees in hot climates the fact that these pamphlets are now out of print is a great loss: nothing else quite so lucid, clear, and helpful has ever been written on the subject.

The particular form of baby nucleus hive invented and recommended by

the late Mr. Pratt is shown in fig. 50. The little frames used in this hive are of such a size that three of them exactly fit into an ordinary Langstroth frame. Feeders are hollowed in the solid walls of the hive in the same manner as they are hollowed into the dummy board feeders shown in fig. 36c.

### American Hives and Bar-Frames.

In nearly all our colonies great numbers of American beehives, bar-frames, and other bee-goods are to be met with, this being largely due to the enterprising way in which American manufacturers have always laid themselves out for the export trade by manufacturing hives, etc., which, being dovetailed at the ends, can be sent out in the flat and unpacked and nailed together by the purchaser in a few minutes. Some of our English manufacturers, foremost amongst whom might be mentioned Messrs E. H. Taylor, of Welwyn, Herts., are now following the American example, but the American goods, having been first in the field in our colonies, are likely to remain there for some time to come.

Fig. 51 shows two typical American dovetailed hives, manufactured respectively by the W. T. Falconer Manufacturing Co., of Falconer, New York State, U.S.A., and by the G. B. Lewis Co., of Watertown, Wisconsin, U.S.A., while fig. 52 shows two other typical American dovetailed hives, manufactured respectively by the A. I. Root Co. and the Leahy Manufacturing Co.

Fig. 53 shows a Canadian hive, called the "Buckeye," manufactured by the Canadian Supply and Honey Co. Ltd., of Toronto, Ontario, Canada.

Very many different sizes of bar-frames are used in America, one of the largest being the "Modified Quinby," and one of the smallest, the "Gallup"; but the standard frame of America remains the "Langstroth," which is  $17\frac{3}{8}$  inches long by  $9\frac{3}{8}$  inches deep, with a top bar  $19\frac{1}{8}$  inches long. When this frame is made with a thin top bar it will hold eight  $4\frac{1}{4}$ -inch by  $4\frac{1}{4}$ -inch sections. It is now, however, very often manufactured with a thick top bar, and sides which are wide at their top part for spacing the frames equally, and with a groove on the under side of the top bar to receive the

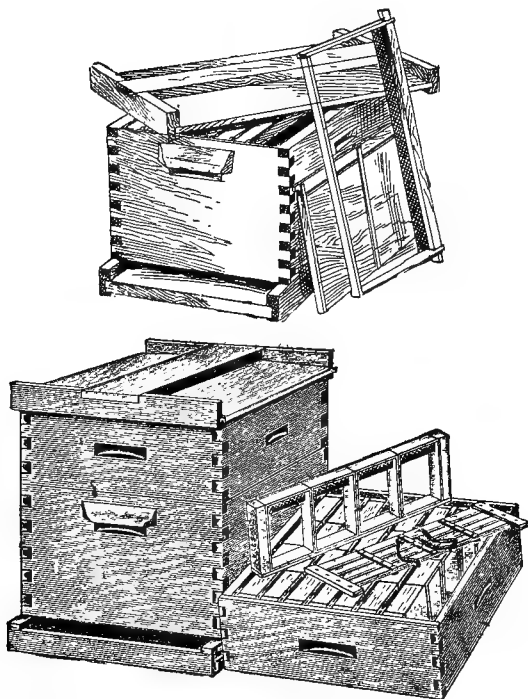

Fig. 51.—Two Typical American Hives, manufactured respectively by the Falconer Co. and the G. B. Lewis Co.

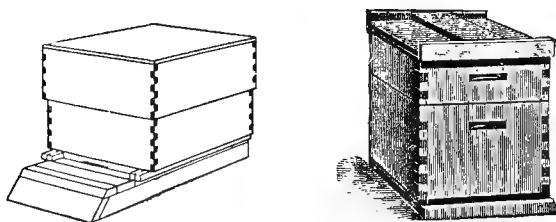

Fig. 52.—Two other Typical Hives, manufactured respectively by the A. I. Root Co., of Medina, Ohio, U.S.A., and the Leahy Manufacturing Co., of Higginsville, Mo., U.S.A.



foundation, and a wedge to keep it in place. In this form it is known as the "Hoffman" frame (fig. 54).

### American, Australian, and Canadian Bee Journals.

In Australia, the *Australian Bee-Keeper*, edited by Mr. W. S. Pender, is published at West Maitland, New South Wales; in Canada the *Canadian Bee-Keeper* is published monthly by the Horticultural Publishing Co., of Peterborough, Ontario; while in the United States, the two principal bee papers are the *American Bee Journal*, published monthly by Messrs. Dadant, of Hamilton, Illinois, U.S.A., and

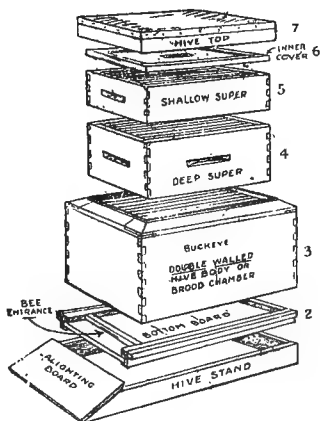

Fig. 53.—A Canadian Hive, known as the "Buckeye."

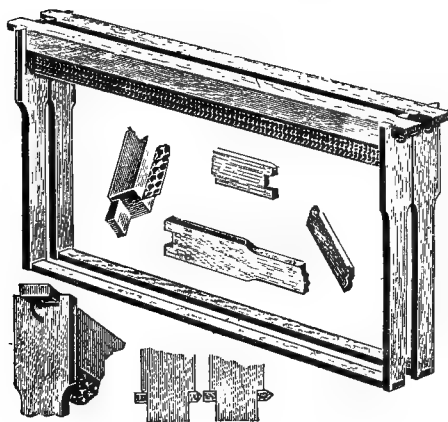

Fig. 54.—"Hoffman" Bar-Frames

*Gleanings in Bee Culture*, also a monthly periodical, which is published by the A. I. Root Co., of Medina, Ohio, U.S.A. These periodicals are extremely useful and interesting to colonial beekeepers, and in most cases a specimen copy is sent by the publishers to those who apply for it.

### Bee-keeping in Canada, Australasia, and South Africa.

In Canada and Australasia bees are generally kept on very up-to-date systems, but in almost every part of South Africa the most primitive and destructive systems of bee-keeping obtain. This is the more regrettable when it is considered that of all our colonies South Africa is the richest naturally from a honey-producing point of view, in this respect, indeed, probably rivalling California. Apart altogether from the wretched methods of keeping the bees, the way in which the honey is marketed is wretched beyond words, it being no uncommon thing to see honey that is staged for competition at up-country agricultural shows merely dumped into old disused paraffin tins, and in this state considered not only by the producer good enough for exhibition, but by the judges for prize-taking.

In a country where the Government is ready to give such generous assistance to co-operation in agriculture as it is in Cape Colony, it seems every pity that the farmers in the various districts do not unite for this purpose, and, by learning and practising up-to-date methods of bee-keeping, not only materially increase their respective incomes, but also help to develop what should be a great export industry. Foul brood—as great a scourge to bee-keepers as phylloxera is to wine-farmers—is at present unknown in South Africa, and it would doubtless need but little pressure from the farmers to induce the Government to prohibit by legislation the importation of queens and bees from other countries except under the most drastic quarantine regulations, and thus insure the country against the introduction of this devastating plague.\*

### Ants must be Guarded Against.

In nearly all hot climates ants are a great source of annoyance to the bee-keeper. They will often attack strong stocks in great force, while it is no uncommon thing to see

\* Legislation to this effect was passed soon after the first publication of the above appeal.

them entirely destroy a weak nucleus in a couple of hours. Fortunately they will not swim.

In localities where they are troublesome all hives should, therefore, be stood on legs, about 10 inches or a foot long, and  $1\frac{3}{4}$  inches square, nailed to the floor-boards and stands. When attacked by ants, each leg must be stood in a round tin filled with water or paraffin oil, or better still a mixture of both. Iron shoes (fig. 55), intended to be screwed to the

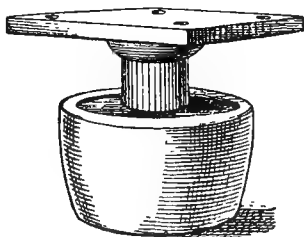

Fig. 55.—Iron Shoes for screwing to the base of Hive Legs.

feet of the hive legs, and the cups to be filled with water or paraffin oil, may be had from Messrs. Lee & Sons, of Uxbridge, Middlesex; Mr. George Rose, of 22 Bolton Street, Liverpool; or from Messrs. E. H. Taylor, Ltd., of Welwyn, Herts. These are very useful when waging war against ants in England, but for hot countries the cups are generally too small, the great heat evaporating the contents so very quickly.

Other remedies recommended for getting rid of ants in hot countries are "Ostico," manufactured by Messrs. M'Dougall, of 66 Port Street, Manchester, which should be painted round the legs of the hives. Where this is not obtainable a mixture of tar, pitch, and lard, mixed in proportions to be determined by experiment (according to the heat of the climate), may be painted from time to time round the legs of the hives. Paraffin oil, mixed with six times its bulk of water, sprinkled over ants' nests every few days, is said to drive them away.

THE END.

BY THE SAME AUTHOR

Just Published. Demy 8vo, cloth

Third Edition, Revised. 362 pages, 292 Illus. and Working Drawings

Price 15s. net, postage 1s. extra

## EVERY MAN HIS OWN BUILDER

### OPINIONS OF THE PRESS ON PREVIOUS EDITIONS

**The Spectator says:** "An extremely interesting and stimulating book . . . thoroughly practical. . . . Mr. Gordon Samson, it may be well to point out for those who are unacquainted with his record, has built or arranged for the building of hundreds of houses."

**The Morning Post says:** "Mr. Gordon Samson's book is sure . . . to remain with us. . . . We welcome Mr. Gordon Samson's thoroughly sensible book with gratitude. . . . Mr. Samson explains with meticulous exactitude how each tool should be used, each rafter, lath, brick, or stone be applied. . . . Nothing is beneath his notice or too small for careful consideration."

**The Daily Mirror says:** "An instructive book . . . remarkably lucid and practical."

**The Manchester Courier says:** "From the drawing of the plans, the sinking of the foundations and the making of the bricks to the painting, glazing and paper hanging, everything is included."

**The Westminster Gazette says:** "A useful handbook."

**The Glasgow Herald says:** "Excellent."

**The Smallholder says:** "The author, who is a well-known architect, has a solution for the housing problem which is after my own heart. . . . It is a book which should be found in every smallholder's club library, if not on every smallholder's bookshelf."

**The English Mechanic and World of Science says:** "This is a book that hundreds of our readers will like. It is a book thousands more of us ought to like, because there would be less incompetence and idleness and poverty in England. . . . We could hardly name a more useful book."

**The Carpenter and Builder says:** "The valuable hints are numerous and suggestive."

**The British Medical Journal says:** "A most practical book."

**The Sanitary Record and Municipal Engineer says:** "We can heartily commend this well-written volume, not only to those who own a piece of land and propose to build thereon, but to intending Building and Sanitary Inspectors."

**The Indian Eastern Engineer says:** "Many Anglo-Indians, such as planters and pioneers of all kinds, will find the work very useful."

**The Englishman says:** "The book deals with every aspect of house building."

**The New York Herald says:** "The book, which may spur many a man . . . may incidentally lead him to greater individual independence."

**The Transvaal Leader says:** "The general information given is such as to make it of very great value to any man who needs to master the use of tools and the principles of sound building."

**The Field says:** "A very practical treatise."

**The County Gentleman says:** "An informing book . . . everyone setting out for Canada, Australia, or other sparsely settled portions of the Empire should take the book along, as it will be invaluable."

**Farm and Home says:** "It is a fascinating book."

**The Livestock Journal says:** "Mr. Samson must be given credit for having succeeded to an extent which will astonish those even who are well versed in the technicalities of the building trade."

**The Irish Field says:** "A really practical book . . . should appeal particularly to the Irish farmer."

**The Yorkshire Post says:** "To any small farmer or cottager who has faith in himself this book should be extremely helpful."

**Literature says:** "An interesting work . . . should be in every people's library, rural or urban."

**The Newcastle Daily Chronicle says:** "Giving innumerable 'wrinkles' of the sort that the ordinary artisan only learns by a tedious apprenticeship."

**The Western Morning News says:** "The book leaves nothing to be desired."

Published by Crosby Lockwood & Son

7 Stationers' Hall Court, Ludgate Hill, London, E.C.

# INDEX.

- Acarine disease, *see* Isle of Wight  
Bee-Disease
- Africa, bee-keeping in, 114
- Agriculture, the importance of  
bee-keeping to agriculture, vi,  
69-76
- Alighting-boards of hives, 18  
— — — illustrations of, 18, 23,  
78
- American Bee Journals, 113
- Ants, how to guard against, 114,  
115
- Apis mellifica*, 1
- April, a good month to start  
bee-keeping, 24
- Artificial methods of increasing  
the number of stocks of bees,  
58-66, 101-111  
— pollen, 67, 68
- Australasia, bee-keeping in, 114  
*Australasian Bee-Keeper, The*,  
113
- Autumn management of bees,  
72-75
- Baby nuclei, 101-111  
— — must always be fed, 107  
— nucleus hive, illustration of,  
106
- Bacillus alvei* 81  
— *burri*, 81  
— *larve*, 81  
— *pluton*, 81
- Bar-frames, *see* Frames  
— frame hives, 16, 111  
— — — illustrations of, 17-20,  
23, 62, 110, 112, 113
- Bean honey, 69
- Bee gloves, *see* Gloves
- Beehives, *see* Skeps, Bar-frame  
hives, and Baby nucleus hives  
*Bee-Keepers' Record, The*, 76
- Bee stings, *see* Stings
- Bee-veils, 31  
— — illustration of, 31
- Bees leaving nuclei in too great  
numbers, how to prevent, 61,  
104
- Beeswax, amount of honey  
consumed in secreting 1 lb., 27,  
how it is secreted by the bees  
27, 28  
— how to heat it, 28  
— loss of time in secreting it,  
27, 28
- Beet sugar unsuitable for bees, 94
- Body box of beehive, 19  
— — — illustrations of, 19, 23
- Books on bees, 8, 56, 76, 77, 97
- Bottling honey, 49
- Breeding, time of year when it  
begins, 9  
— bees for profit, 51-66, 101-111  
*British Bee Journal, The*, 76
- Broad shouldered frames, 18
- Brood, chilled, 53, 55, 82  
— foul, *see* Foul brood
- Building up stocks and nuclei,  
54, 55, 64, 108, 109
- Cages, for queens, *see* Queen  
cages
- Camphor will keep away the  
wax moth, 41
- Canadian bee feeder, illustration  
of, 57

- Candy, how to make it, 67, 68  
 — medicated, 84  
 Cane sugar alone is suitable for bees, 94  
 Carbolic acid, how to quiet bees with it, 32, 34  
 Carniolan bees, 13, 21  
   hybrids, 15, 91  
 Carr section crate, its advantages, 40  
 — — — illustration of, 44  
 Chilled brood, 53, 55, 82  
 Close driving, 74  
 Clover honey, 69  
 Cocoons spun by bees in larval state, 4, 5  
 Comb box, illustration of, 47  
 — foundation, 26, 27  
 — — for the stock hive, "brood foundation," 27  
 — — how to fix into frames, 28  
   — illustration of, 27  
   — metal, 29  
 — — wired, its advantages, 27-29  
 — — — illustration of, 29  
 Combination hives, 21  
 Combs, *see* Honey combs  
 Composition of a hive or colony of bees, 1  
 Condemned bees, 72  
 Co-operation desirable in bee-keeping, 114  
 Cowan, T. W., his writings, 8, 76, 89  
 — his method of using formic acid, 84  
 Crates of sections, *see* Section crates  
 Crossbred bees, 15  
 Cyprian bees, 14, 56  
 Dalmatian bees, 15  
 Development of the bee from the egg, various stages of, 4-7  
 — — — illustration of, 2  
 Direct introduction of queen bees to alien stocks and nuclei, 8, 71, 72, 105  
 Diseases of bees, 80-93  
 Disinfecting hives, 86, 92, 93  
 Disinfection of bee-keeper after handling diseased bees or hives, 86, 93  
 Distance racks for bar-frames, 97  
 Dividers for sections, 39, 103  
 — — illustrations of, 39, 103  
 Division boards, *see* Dummy boards  
 Divisional section crates, 25  
 — — — illustration of, 25  
 Doubling, 45, 46  
 — boxes for bar-frame hives, 22  
 — — — — illustration of, 23  
 — — — — sliding inner walls for, 22  
 — — — — illustration of, 22  
 Driving bees out of straw skeps, method of, 72-74  
 — irons, illustration of, 73  
 Drone comb, 3  
 — eggs, time of year when first are laid, 9  
 Drones, illustration of, 2  
 — longevity of, 6  
 — should be bred from the best stocks only, 64  
 — their natural history, 2, 5, 6  
 Dummy boards, 20  
 — — illustration of, 20  
 — — excluding queen, 37  
 — — — illustration of, 38  
 — — feeder, 63  
 — — — illustration of, 63  
 — — — "Wells," 77  
 Dysentery, 80, 81, 90  
 Economy essential when breeding bees for sale, 66  
 Eggs, laid by the queen, 2  
 — — — are of two kinds, 3  
 — — — fertile workers produce only drones, 8  
 Empty honey combs for hiving swarms upon, 24, 95  
 — — — how to fix them into frames, 25  
 — — — how to preserve them from the wax moth, 41, 48, 49  
 English bee, the, 12  
 Entrance contractor, 19  
 — — illustration of, 19

- Entrances to bar-frame hives, 19  
 — should be narrowed in spring, 68  
 — width in autumn, 74  
 — — in winter, 75
- Extracted honey, advantages of, 45
- Extracting honey, 46, 47  
 — beeswax from honey combs, 48, 94
- Extractors, honey, illustrations of, 48  
 — wax, 48, 94  
 — — illustration of, 48
- “Fasting” cure for foul brood, 86
- Feeders, illustrations of, 52, 57, 63, 85, 106, 108, 110
- Feeding, rapid, 56, 57, 74  
 — stimulative, 51, 52, 55, 63, 107, 108  
 — with candy, 67, 68  
 — — hot syrup, 57
- Fertile workers, 8  
 — — the best plan to get rid of, 8  
 — — introducing queens to colonies, with, 8
- Fertilisation of fruit blossoms by bees, vi, vii, 76
- Fixed comb hives, 16
- Fixing queen cells into nuclei, 61
- Floor-boards of hives, 18  
 — — — illustrations of, 18
- Flour, pea, used as artificial pollen, 67  
 — sprinkling bees with, when uniting, 43
- Formic acid, the poison in bee stings, 30  
 — — as a cure for foul brood, 83, 84
- Foul brood, remedies for, 82-88  
 — — symptoms of, 81, 82
- Foundation, *see* Comb foundation
- Frames, 16, 63, 106, 111  
 — American, 111, 113  
 — — illustration of, 113  
 — British standard size, 16
- Frames filled with sections, 37, 38, 102-104  
 — — — illustrations of, 38, 106  
 — illustrations of, 16, 38, 106, 113  
 — sections converted into miniature frames, 105, 106  
 — shallow, 50  
 — South African standard size, 102  
 — wired, *see* Wired frames
- Frequent removal of surplus honey desirable in hot climates, 101
- Fruit blossom, its honey-yielding value, 9  
 — farming, the importance of bees to fruit farmers, vi, vii, 69, 76
- Gloves, 31, 32
- Golden Italian bees, 15
- “Golden” Rule for bee-keepers, 97
- Goose wings, useful for removing bees from honey combs, 46
- Gorging the bees before manipulating, 32
- Heather honey, 50, 67
- Hives, *see* Skeps, Bar-frame hives, Nucleus hives, and Baby nucleus hives
- Honey comb, how to preserve empty honey combs from the wax moth, 41, 48  
 — — illustrations of, 3, 4  
 — — metal, 29, 50  
 — — method of fixing empty honey combs into frames, 25  
 — — production of, 45, 46
- Honey, differences in honey gathered from various plants, 69  
 — where stored by the bees, 4
- Honey extractors, illustrations of, 48
- Honey ripener, illustration of, 49
- Hunger swarms, 11
- Hybrids, 15, 91
- Hymenoptera, 1

- Increasing the number of stocks of bees, 51-66, 101-111
- Incubating brood artificially, 104, 105, 109, 110
- Infectious nature of foul brood, 81, 87  
— — of Isle of Wight bee disease, 92, 93
- Inner walls for doubling boxes and hives, sliding, 22  
— — — — illustration of, 22
- Intimidating bees by rapping on the sides of the hive, 32  
— — with smoke, 32, 33  
— — with carbolic acid, 32, 34
- Introducing queens to alien stocks and nuclei, 8, 43, 70, 71, 105
- Irish Bee Journal, The*, 76
- Isle of Wight bee disease, 88-93
- Italian or Ligurian bees, 12  
— hybrids, 15, 90, 91
- Karoo bee, 14
- Larva of bees, 4
- Legs for beehives, 96, 113
- Ligurian bees, *see* Italian bees
- Lime honey, 69
- Maiden swarms, 53
- Male bees, *see* Drones
- Manipulating bees, 30, 34, 94
- Medicated syrup, 83, 84, 87, 92  
— — should generally be thin, 92
- Metal ends, 18  
— — illustrations of, 18
- Moths, Wax, *see* Wax moth
- Movable comb or bar-frame hives, 16  
— — illustrations of, 17-20, 23, 62, 106, 110, 112, 113
- Moving bees, 24, 42, 96, 98
- Naphthaline, as a preventive of foul brood, 88  
— will keep away the wax moth, 41, 49
- Naphthol beta, for medicating syrup, 84
- Narrowing entrances in spring, 68
- Natural history of the bee, 1-11  
— — — books on, 8
- Natural methods of increasing the number of stocks of bees, 51-58
- Neutrals, worker bees sometimes called "neutrals," 2
- Newspapers used as quilts, 75
- No-bee-way sections, 102, 103  
— illustrations of, 103
- Nucleus, baby, *see* Baby nucleus  
— hive, 62, *see also* Baby nucleus hive  
— how to form, 54, 60, 61, 101-10  
— how to prevent bees deserting, 61, 104, 105
- Packing bees for travelling by road or rail, 96  
— sections to go by rail, 42
- Palestine bees, 56
- Pasturage for bees, 69
- Phenol for medicating bee syrup, 83
- Pipe cover queen cage, 43, 70
- Planting flowers for bees, 69
- Plinths to beehives, 21, 95
- Pollen, artificial, 67, 68  
— where stored, 4  
— baskets, 2, 3
- Porches to bar-frame hives, 20  
— — — illustrations of, 19, 23, 78
- Prevention of bee diseases better than cure, 88, 90-92, 114
- Profitable production of bees, 51-66, 101-111
- Queen bee, the mother bee, 2  
— — drone-breeding queens, 7, 8  
— — hatching queens in incubators, 109, 110  
— — her marriage trip, 7  
— — how to find the queen, 43, 44  
— — how to introduce to alien stocks and nuclei, 8, 43, 70-72, 105  
— — how to rear, 6, 7, 59-62, 64, 66



- Queen bees, longevity of, 2  
 — — natural history of, 6-8  
 — — number of eggs laid by, 2  
 — — their stings, 6  
 — cages, 43, 70  
 — — illustrations of, 43, 70  
 — — "pipe cover," 43, 70  
 — — "Raynor," 70  
 — cells, built before swarming, 9  
 — — illustration of, 61  
 — — method of fixing in nuclei, 61  
 — — excluding dummy, 37  
 — — — illustration of, 38  
 — — — zinc, 37, 46  
 — introduction to alien stocks and nuclei, 8, 43, 70-72, 105  
 — raising, artificial method of, 59, 60, 66, 109  
 — — natural method of, 53, 54  
 Quieting bees with carbolic acid, 32, 34  
 — — — rapping on the sides of hive, 32  
 — — — smoke, 32, 33  
 Quilts for beehives, 23, 75
- Racks for sections, *see* Section crates  
 Rapid feeder, illustration of, 57  
 — feeding, 56, 57, 74  
 "Raynor" queen cage, 70, 71  
 Rennie, Dr., his book on "Isle of Wight Bee Disease," 89  
 Ripening honey, 49  
 Robber bees, *see* Robbing  
 Robbing, 41, 68, 74, 101, 107  
 Roofs for beehives, 20  
 — — — how to prevent them from blowing off, 68  
 — — — illustrations of, 20, 23, 62, 112
- Salicylic acid, 82, 83  
 Sanfoin honey, 69  
 Saw cut in top bar of bar-frames, 28  
 Second swarms generally require feeding, 25  
 — — time of day when they issue from hives, 10
- Section block, 37  
 — — illustration of, 37  
 — crates, 37-39  
 — — capacity of a hive with doubling box for, 22  
 — — divisional, 25  
 — — illustrations of, 25, 38, 39, 112  
 Sections, 35, 102, 103  
 — grooved, 36  
 — — illustration of, 36  
 — how to fold, 35, 36  
 — illustrations of, 35-38, 103  
 — in frames, 37, 38, 102-106  
 — — illustration of, 38  
 — no-bee-way, 102, 103  
 — sizes of, 37  
 — used as miniature frames, 102, 105  
 Separators for section racks, *see* Dividers  
 Shading hives, 72, 101  
 Shallow frames, 50  
 Size of beehives, the best, 21  
 Skeps, straw, 1, 16  
 — — illustration of, 16  
 Sliding inner walls for doubling boxes and hives, 22  
 — — — — — illustration of, 22  
 Smokers, their use, 33  
 — illustration of, 32  
 — material to burn in, 33  
 South African bees, 14, 15  
 Space between honey combs, 18, 21  
 Spray diffuser, illustration of, 82  
 Spreading the brood, 52, 53  
 Spring management of bees, 67-69  
 Stands for beehives, 18  
 — — illustration of, 18  
 Starting bee-keeping, advice to persons, 24  
 Stimulative feeders, illustrations of, 52, 108  
 — feeding, 51, 52, 55, 63, 107, 108  
 — — syrup for, 52  
 Stings of bees, remedy for, 30  
 — — what to do when stung while manipulating, 30, 31  
 — — preventives, 30, 31

- Stores, amount a colony of bees requires for winter, 56, 74
- Storing honey combs, 41, 48, 49
- Straw skeps, *see* Skeps
- Streptococcus apis*, 81
- Strong stocks indispensable when comb honey is desired, 42
- Summer management of bees, 69-72
- Supers, how to clear the bees out of them, 41
- must be kept very warmly covered, 40
- when and how to take them off hives, 41
- when to put them on hives, 40
- Swarming, appearance of a hive before swarming, 9, 10
- bees when swarming will not sting unless hurt, 26
- time of day when bees swarm, 10
- time of year when it usually takes place, 9
- Swarms of bees, how to make them settle, 10, 26
- how to hive them, 25, 26, 54
- how to return them to the parent hive, 44, 78, 79
- — “hunger swarms,” 11
- — second swarms and casts, 10, 11, 53, 54
- — treatment when hived, 53
- — truant swarms, 54
- — usually cluster in highest part of hives, 3
- — “Wells” hives, how to treat swarms from, 78, 79
- Symptoms of foul brood, 81, 82
- Syrian bees, 14, 21, 56
- Syrio-Carniolan bees, 15
- Syrup for feeding bees, how to make, 46
- for rapid feeding, 56
- — stimulative feeding, 52
- — wax production, 46
- medicated, 83, 84, 87, 92
- Tarsonemus Woodi*, 89
- Texas incubators, 105
- Travelling, preparing bees for, 96, 97
- boxes for bees, illustration of, 96
- crate for sections, 42
- — — illustration of, 42
- Truant swarms, 54
- Uncapping honey, 47
- — to stimulate brood rearing, 52
- knife, illustration of, 47
- Uniting stocks of bees, how to do it, 42, 43, 73, 74
- Unsealed brood, bees will not desert it, 54
- Veils, *see* Bee-veils
- Ventilation of beehives, 21, 93
- Wax, bees, *see* Beeswax
- foundation, *see* Comb foundation
- how to extract from honey combs, 48, 94
- moth, how to preserve honey combs from, 41, 48, 49
- Wells’ system of keeping two queens in one hive, 76-79
- dummy board, 76, 77
- Winter management of bees, 75, 76
- Wired frames, 27-29
- — illustrations of, 29
- — invaluable for extracting, 27
- — their great advantages, 27
- Worker bees, age at which they first leave the hive, 5
- — illustration of, 2
- — longevity of, 5
- — their natural history, 2-6
- Yucca brush, for removing bees from honey combs, 46
- Zinc, queen-excluding, 37, 46
- — illustrations of, 38

BY THE SAME AUTHOR

*Just Published. Second Edition. Profusely Illustrated*  
*Demy 8vo, cloth, 147 pages*

Price 7s. 6d. net, postage 6d. extra

## HOUSES, VILLAS, COTTAGES, AND BUNGALOWS

For Britishers and Americans Abroad

### OPINIONS OF THE PRESS ON PREVIOUS EDITIONS

**The Scotsman says:** "Treats its own special subject with lucidity and freshness. At once artistic and practical, and illustrated by many helpful plans and diagrams, it cannot but prove serviceable to architects, and to people who contemplate putting up the kind of houses it describes so well."

**The Glasgow Herald says:** "A very practical and lucid guide."

**The Manchester Courier says:** "Above all, the work is eminently practical. Sound advice is given."

**The Surveyor says:** "This little work by the author of *How to Plan a House* contains descriptions, plans, and elevations of many very delightful and inexpensive villas and bungalows which are suited to the requirements of the Briton who may be seeking refuge under the Southern sun from his native climate. The letterpress is written in a breezy, somewhat unconventional, and distinctly interesting style, and the drawings, which are numerous, are well produced. The book is one which will prove of interest and assistance, not only to architects who may be called upon to design houses to suit conditions with which they are not familiar, but also to the client who is instructing him, and who will not be averse to receiving some timely hints as to the best way in which his money may be laid out."

**The Builder says:** "Many hints may be taken from the plans and other illustrations of buildings, many of which have stood the test of production and occupation."

**The British Trade Journal says:** "All who for business, pleasure, or health have to reside abroad, especially in warm climates, will find this volume an extremely interesting and useful guide."

**The Estate Gazette says:** "Preaches the art of comfort, planning houses at the same time with a special eye for those to whom cost is a consideration."

**The Ceylon Observer says:** "Should prove very useful . . . The book deals in general with the requirements of dwellers in warm climates and the South, and the whole subject is thoroughly discussed."

**The Cape Argus says:** "Mr. Samson gives a great deal of information as to the style of house it is desirable to build in such a climate as our own. . . . Interesting sections are given on the influence of Dutch and French ideas on the old domestic architecture of South Africa. . . . Mr. Samson has done his work well."

**The Lancet says:** "Many of its suggestions are particularly suitable for those who desire a *pied-à-terre* in the Riviera, Algeria, and other health resorts. . . . Its subject matter will interest medical practitioners and others."

**The British Medical Journal says:** "It should prove a most useful book to anyone who has in view the building either of a mansion or a cottage."

**The Mentone and Monte Carlo News says:** "This is a book which . . . should take its own place in architectural literature. . . . Mr. Samson expounds very ably and successfully."

**The Riviera News says:** "Mr. Samson shows himself particularly well informed on the question of what constitutes a well planned and comfortable house for a Britisher on the French or Italian Riviera. . . . Contains thoroughly sound advice."

**The Birmingham Post says:** "Mr. Samson is an architect who has a great deal of information to impart."

Published by Crosby Lockwood & Son  
7 Stationers' Hall Court, Ludgate Hill, London, E.C.

## LOCKWOOD'S MANUALS

### Trade

CLOCK REPAIRING ...	...	Garrard ...	Net 6/-
WATCH REPAIRING ...	...	Garrard ...	.. 6/-
MECHANICAL DENTISTRY ...	...	Hunter ...	.. 6/-
ELECTRO PLATING ...	...	Watt ...	.. 5/-
HOUSE PAINTING ...	...	Davidson ...	.. 7/6
CARPENTRY AND JOINERY ...	...	Tredgold ...	.. 6/-
GAS FITTING ...	...	Briggs ...	.. 6/-
BRICKS AND TILES ...	...	Dobson ...	.. 7/6
METAL PLATE WORK ...	...	Barrett ...	.. 3/6
BUILDERS' ACCOUNTS ...	...	Keen	<i>nearly ready</i>

### Technical

ENGINEERS' SCREW CUTTING ...	Pull	Net 2 6
ENGINEERING MEASURING TOOLS	Pull	.. 4/6
SLIDE RULE ...	Hoare	.. 4/-
ENGINEERING DRAWING	Maldon	<i>nearly ready</i>

### Craft-Work

MODERN FRETCUTTING...	...	Makinson ...	Net 2/6
-----------------------	-----	--------------	---------

### Art-Work

ILLUMINATING ...	...	Whithard ...	Net 6/-
------------------	-----	--------------	---------

### Educational

PORTUGUESE DICTIONARY	...	Elwes	... Net 8/6
-----------------------	-----	-------	-------------

### Business

FOREIGN COMMERCIAL CORRESPONDENT	Baker	Net 7/6
----------------------------------	-------	---------

*Complete List on Application*

LONDON:  
CROSBY LOCKWOOD & SON







