

MONOGRAPHS ON EXPERIMENTAL BIOLOGY

CORNELL  
UNIVERSITY  
LIBRARY



GIFT OF

Estate Of  
Dr. Elsie Murray

DATE DUE

<del>DEC 22 1971</del>			
<del>DEC 22 1971</del>			
<del>APR 17 1974</del>			
<del>JAN 25 1974</del>			6
CAYLORD			PRINTED IN U.S.A.

Cornell University Library  
 QH 431 .M84P5

Physical basis of heredity /



3 1924 024 541 892

olin

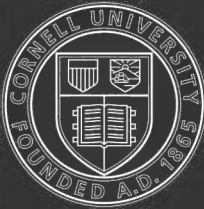

Cornell University  
Library

The original of this book is in  
the Cornell University Library.

There are no known copyright restrictions in  
the United States on the use of the text.

<http://www.archive.org/details/cu31924024541892>

MONOGRAPHS ON EXPERIMENTAL BIOLOGY

EDITED BY

JACQUES LOEB, Rockefeller Institute  
T. H. MORGAN, Columbia University  
W. J. V. OSTERHOUT, Harvard University

---

THE PHYSICAL BASIS OF HEREDITY

BY

THOMAS HUNT MORGAN

**MONOGRAPHS ON EXPERIMENTAL  
BIOLOGY**

**PUBLISHED**

**VOLUME I**

**FORCED MOVEMENTS, TROPISMS, AND  
ANIMAL CONDUCT**

By JACQUES LOEB, Rockefeller Institute

**IN PREPARATION**

**THE CHROMOSOME THEORY OF  
HEREDITY**

By T. H. MORGAN, Columbia University

**INBREEDING AND OUTBREEDING: THEIR  
GENETIC AND SOCIOLOGICAL  
SIGNIFICANCE**

By E. M. EAST and D. F. JONES, Bussey Institution,  
Harvard University

**PURE LINE INHERITANCE**

By H. S. JENNINGS, Johns Hopkins University

**THE EXPERIMENTAL MODIFICATION OF  
THE PROCESS OF INHERITANCE**

By R. PEARL, Johns Hopkins University

**LOCALIZATION OF MORPHOGENETIC  
SUBSTANCES IN THE EGG**

By E. G. CONKLIN, Princeton University

**TISSUE CULTURE**

By R. G. HARRISON, Yale University

**PERMEABILITY AND ELECTRICAL  
CONDUCTIVITY OF LIVING TISSUE**

By W. J. V. OSTERHOUT, Harvard University

**THE EQUILIBRIUM BETWEEN ACIDS AND  
BASES IN ORGANISM AND  
ENVIRONMENT**

By L. J. HENDERSON, Harvard University

**CHEMICAL BASIS OF GROWTH**

By T. B. ROBERTSON, University of Toronto

**PRIMITIVE NERVOUS SYSTEM**

By G. H. PARKER, Harvard University

**COÖRDINATION IN LOCOMOTION**

By A. R. MOORE, Rutgers College

**OTHERS WILL FOLLOW**

MONOGRAPHS ON EXPERIMENTAL BIOLOGY

---

# THE PHYSICAL BASIS OF HEREDITY

BY

THOMAS HUNT MORGAN

PROFESSOR OF EXPERIMENTAL ZOOLOGY IN COLUMBIA UNIVERSITY

*117 ILLUSTRATIONS*



PHILADELPHIA AND LONDON  
J. B. LIPPINCOTT COMPANY

COPYRIGHT, 1919, BY J. B. LIPPINCOTT COMPANY

*Electrotyped and Printed by J. B. Lippincott Company  
The Washington Square Press, Philadelphia, U. S. A.*



## EDITORS' ANNOUNCEMENT

THE rapid increase of specialization makes it impossible for one author to cover satisfactorily the whole field of modern Biology. This situation, which exists in all the sciences, has induced English authors to issue series of monographs in Biochemistry, Physiology and Physics. A number of American biologists have decided to provide the same opportunity for the study of Experimental Biology.

Biology, which not long ago was purely descriptive and speculative, has begun to adopt the methods of the exact sciences recognizing that for permanent progress not only experiments are required but quantitative experiments. It will be the purpose of this series of monographs to emphasize and further as much as possible this development of Biology.

Experimental Biology and General Physiology are one and the same science, in method as well as content, since both aim at explaining life from the physico-chemical constitution of living matter. The series of monographs on Experimental Biology will therefore include the field of traditional General Physiology.

JACQUES LOEB,  
T. H. MORGAN,  
W. J. V. OSTERHOUT.



# CONTENTS

CHAPTER	PAGE
I. INTRODUCTION .....	15
II. MENDEL'S FIRST LAW—SEGREGATION OF THE GENES.....	19
III. THE MECHANISM OF SEGREGATION.....	39
IV. MENDEL'S SECOND LAW—THE INDEPENDENT ASSORTMENT OF THE GENES.....	59
V. THE MECHANISM OF ASSORTMENT.....	73
VI. LINKAGE .....	80
VII. CROSSING OVER .....	87
VIII. CROSSING OVER AND CHROMOSOMES.....	96
IX. THE ORDER OF THE GENES.....	118
X. INTERFERENCE .....	126
XI. LIMITATION OF THE LINKAGE GROUPS.....	133
XII. VARIATION IN LINKAGE.....	139
XIII. VARIATION IN THE NUMBER OF THE CHROMOSOMES AND ITS RE- LATION TO THE TOTALITY OF THE GENES.....	147
XIV. SEX-CHROMOSOMES AND SEX-LINKED INHERITANCE.....	165
XV. PARTHENOGENESIS AND PURE LINES.....	204
XVI. THE EMBRYOLOGICAL AND CYTOLOGICAL EVIDENCE THAT THE CHROMOSOMES ARE THE BEARERS OF THE HEREDITARY UNITS..	212
XVII. CYTOPLASMIC INHERITANCE.....	219
XVIII. MATERNAL INHERITANCE.....	227
XIX. THE PARTICULATE THEORY OF HEREDITY AND THE NATURE OF THE GENE.....	234
XX. MUTATION.....	247



# ILLUSTRATIONS

FIG.	PAGE
1. Cross Between a Tall and a Short Race of Garden Peas . . . . .	20
2. Cross Between White and Red Flowered Four-o'clocks . . . . .	24
3. Cross Between Splashed-White and Black, in Andalusian . . . . .	26
4. Male and Female Vinegar Fly . . . . .	28
5. Normal and Abnormal Abdomen of <i>D. melanogaster</i> . . . . .	29
6. Relation of Black Body Color to Wild Type as Shown by Classes of Flies . . . . .	30
7. Normal, Heterozygous, and Bar Eye of the Vinegar Fly . . . . .	31
8. Relation of Bar Eye to Normal Eye . . . . .	31
9. Relation of Andalusian to Splashed White and to Black as Shown by Classes of Birds . . . . .	32
10. Relation of Tall to Short Peas . . . . .	32
11. Relation of Normal to Abnormal Abdomen as Shown by Classes of Flies . . . . .	32
12. Relation of Normal to Duplicate Legs of Flies . . . . .	33
13. Notch Wings in the Vinegar Fly . . . . .	35
14. Oöcyte of <i>Ancyracanthus</i> ; Growth Period; Nucleus with Tetrads . . . . .	40
15. Egg of <i>Ancyracanthus</i> . . . . .	40
16. Eggs of <i>Ancyracanthus</i> within Membrane . . . . .	41
17. Spermatogenesis of <i>Ancyracanthus</i> . . . . .	42
18. Last Spermatogonial Division of <i>Tomopteris</i> and Stages Before and During Synapsis . . . . .	45
19. Thin-Thread Stage of <i>Tomopteris</i> Spermatocyte; Tetrads, and First and Second Spermatocyte Divisions . . . . .	47
20. Synaptic Stages and Those Immediately Following in <i>Batracoseps</i> . . . . .	48
21. Synaptic Stages and Those Immediately Following in the Egg of <i>Pristiurus</i> . . . . .	50
22. Sister Blastomeres of <i>Ascaris</i> Preparatory to Another Division . . . . .	52
23. Normal and Reduced Chromosomes of <i>Biston</i> . . . . .	53
24. Division Figures in Egg of <i>Ctenolabrus</i> Fertilized by <i>Fundulus</i> . . . . .	54
25. Female and Male Chromosome Groups of <i>Protenor</i> . . . . .	55
26. Reduced Chromosome Group; and Extrusion of Polar Bodies in <i>Protenor</i> . . . . .	56

27. Reduced Chromosome Group of Male; and Spermatogenesis in <i>Protenor</i> .....	56
28. Diploid and Haploid Chromosome Groups of <i>Drosophila busckii</i> and <i>D. melanica (neglecta)</i> .....	57
29. Cross Between Wingless and Ebony Vinegar Fly.....	65
30. Miniature Wing, Dumpy, and Miniature Dumpy.....	66
31. Combs of Fowls.....	69
32. Eight Chromosome Groups of Twelve Chromosomes Each of <i>Trimerotropis</i> .....	77
33. Back-cross of Male (Out of Black Vestigial by Wild) to Black Vestigial.....	81
34. Back-cross of Male (Out of Gray Vestigial by Black) to Black Vestigial.....	83
35. Scheme Showing the Inheritance of the X-Chromosome in <i>Drosophila</i> .....	84
36. Back-cross of Female (Out of Black Vestigial by Wild) to Black Vestigial Male.....	89
37. Back-cross of Female (Out of Gray Vestigial by Black) to Black Vestigial Male.....	90
38. Scheme to Illustrate Double Crossing Over Between White and Forked.....	93
39. Curve Showing the Influence of Temperature on Crossing Over Control.....	98
40. Curve Showing the Influence of Temperature on Crossing Over....	98
41. Diagram Showing Crossing Over of Two Chromosomes at Four-strand Stage and the Subsequent Opening Out of the Tetrad.....	101
42. Scheme Showing the Opening Out of the Strands of the Tetrad....	102
43. Scheme Showing Crossing Over Involving Both Strands of Each Chromosome.....	103
44. Spermatogonial Cells in the Last Phase of Division and the Following Resting Stages.....	105
45. Cells Emerging From the Resting Stages Preparatory for the Next Spermatogonial Division.....	106
46. Cells Emerging From Their Last Spermatogonial Division.....	106
47. Formation of a Thick Thread after Synapsis and the Following Condensation of a Tetrad.....	107
48. A Pair of Chromosomes in Conjugation.....	109

49. The Same Chromosome Pair in Conjugation from Thirteen Different Cells.....	110
50. Conjugation of an Unequal Pair of Chromosomes and Their Subsequent Separation.....	111
51. Two Schemes Illustrating the Idea of Reduplication by Bateson and Punnett.....	116
52. Scheme Illustrating How Double Crossing Over Between Two Distinct Genes takes Place.....	121
53. Chromosome Groups of Pea, Wheat, and Primula.....	135
54. Types of Chromosome Groups Found in <i>Drosophila</i> .....	136
55. Haploid Group of Chromosomes of the Silkworm Moth.....	137
56. Curve Showing Influence of Crossing Over at Different Temperatures	142
57. Diagram Illustrating the Effect on Crossing Over Due to the Presence of Crossover Genes.....	143
58. Chromosome Group of <i>Œnothera Lamarckiana</i> and <i>O. gigas</i> , and Triploid Group.....	149
59. Life Cycle of Moss.....	152
60. Diagram Illustrating the Formation of Individuals from the Regeneration of the Sporophyte in a Dicæcious Species.....	153
61. Diagram Illustrating the Formation of Individuals from the Regeneration of the Sporophyte in a Hermaphroditic Species.....	153
62. Somatic Chromosomes Groups of <i>Œnothera scintillans</i> .....	156
63. Scheme Showing the Probable Relation Between the Extra Chromosome Pieces of Fig. 62, and the Normal Fifteen Chromosomes of This Mutant.....	158
64. An Egg of <i>Ascaris bivalens</i> Fertilized by Sperm of <i>A. univalens</i> ....	160
65. Diploid and Haploid Groups of the Sundew <i>Drosera</i> .....	160
66. A Scheme Illustrating the Fertilization of the Egg of One Species of Moth by the Sperm of Another.....	161
67. Scheme Illustrating the History of the Chromosomes, and the Backcross Between a Hybrid Male and One or the Other Parent....	162
68. Scheme Showing the Relation of the Sex-Chromosome to Sex-Determination.....	166
69. Cross Between White-Eyed Male and a Red-Eyed Female of the Vinegar Fly.....	168

70. Cross Between White-Eyed Female and a Red-Eyed Male of the Vinegar Fly.....	169
71. Cross Between a Yellow White-Eyed Female and a Wild-Type ("Gray"), Red-Eyed Male.....	171
72. The Results from the Reciprocal Cross of That Shown in Fig. 71...	173
73. Scheme Showing the Relation of the Sex-Chromosomes of the Moth in Sex Determination.....	174
74. Cross Between <i>Abraxas laticolor</i> Female, and <i>Grossulariata</i> Male....	175
75. Cross Between <i>Abraxas grossulariata</i> Female and <i>Laticolor</i> Male...	176
76. Cross Between Barred Plymouth Rock Male and Black Langshan Female.....	178
77. Scheme Showing the Transmission of the Sex-Linked Characters....	178
78. Cross Between Black Langshan Male and Barred Plymouth Rock Female.....	178
79. Scheme Showing the Transmission of the Sex-Linked Characters Shown in Fig. 78.....	179
80. First and Second Spermatocyte Divisions in the Bee.....	181
81. First and Second Spermatocyte Divisions in the Hornet.....	182
82. Life Cycle of <i>Phylloxera caryæcaulis</i> .....	182
83. Extrusion of the Polar Body from a Male-Producing Egg.....	183
84. First and Second Spermatocyte Divisions in the Bearberry Aphid....	184
85. <i>Hydatina senta</i> : Adult Female, Young Female Soon After Hatching, Adult Male, Parthenogenetic Egg, Male-Producing Egg, Resting Egg.....	186
86. Diagram Showing How a Continuous Diet of <i>Polytoma</i> Through Twenty-Two Months Yielded Only Female-Producing Females...	187
87. A, Gynandromorph of <i>Drosophila melanogaster</i> , that was Female on Right Side and Male on the Left; B, Female on the Left Side and Male on the Right.....	190
88. Diagram Showing Elimination of X' at an Early Cell Division....	191
89. Caterpillars of the Silkworm Moth.....	192
90. Diagram Illustrating How a Heterozygous Egg With Two Nuclei Fertilized by Two Sperms Might Produce a Gynandromorph like that Shown in Fig. 89.....	193
91. Scheme Showing the Transmission of a Lethal Sex-Linked Factor in an X-Chromosome.....	199
92. Normal Female and Male Groups of Chromosome of the Vinegar Fly.....	200



93. Non-Disjunction. Egg Fertilized by X-Sperm.....	201
94. Non-Disjunction. Egg Fertilized by Y-Sperm.....	202
95. A Wingless Aphid and a Winged One.....	207
96. Curve Showing the Non-effect of Selection for the First Twelve Generations for Increase in Body Length.....	208
97. Curve Showing the Effect of Selection for the Second Score of Generations.....	209
98. Scheme Showing Dispermic Fertilization of the Egg of the Sea Urchin.....	214
99. First Division of a Hybrid Egg.....	215
100. Fertilization of an Egg Starting to Develop Parthenogenetically...	216
101. Larval Sea Urchin Seen in Side View.....	217
102. Green Leaf and Checkered Leaf of Four-o'clock.....	220
103. Pelargonium that Gave Rise to a White Branch.....	221
104. Diagram to Show How a Sectorial Chimera May be Produced.....	221
105. Diagram to Illustrate Maternal Inheritance.....	228
106. Diagram to Show the Inheritance of Two Pairs of Mendelian Characters.....	238
107. A, Hen-Feathered Campine Male; B, Adult Castrated Campine Male; C, Sebright Hen-Feathered Male, D, Adult Castrated Sebright Male	246
108. Diagram Illustrating Mutation in a Nest of Genes.....	252
109. Two Flies ( <i>Drosophila</i> ) with Beaded Wings.....	258
110. Diagram Showing the Relation of the Chromosomes.....	258
111. Diagram to Show how the Appearance of a Lethal Near Beaded Causes the Stock to Produce only Beaded.....	259
112. Diagram Showing the Results of Crossing Over in a Stock Contain- ing Both Beaded and Lethal.....	260
113. Diagram Illustrating How in the Presence of a Dominant Factor, Dichete, and a Lethal in Its Homologous Chromosome at About the Same Level, Together with Another Factor, Peach-Colored Eyes, Gives the Result Shown in the Squares.....	261
114. Diagram Illustrating Crossing Over of Factors in Fig. 113.....	262
115. Rosettes of the Twin Hybrids of the Evening Primrose.....	263
116. Diagram Illustrating Balanced Lethals and Twin Hybrids.....	264
117. Diagram Illustrating Lethals and Four Types.....	265



# THE PHYSICAL BASIS OF HEREDITY

## CHAPTER I

### INTRODUCTION

THAT the fundamental aspects of heredity should have turned out to be so extraordinarily simple supports us in the hope that nature may, after all, be entirely approachable. Her much-advertised inscrutability has once more been found to be an illusion due to our ignorance. This is encouraging, for, if the world in which we live were as complicated as some of our friends would have us believe we might well despair that biology could ever become an exact science. Personally I have no sympathy with the statement that "the problem of the method of evolution is one which the biologist finds it impossible to leave alone, although the longer he works at it, the farther its solution fades into the distance." On the contrary, the evidence of recent years and the methods by means of which this evidence is obtained have already in a reasonably short time brought us nearer to a solution of some of the important problems of evolution than seemed possible only a few years ago. That new problems and developments have arisen in the course of the work—as they are bound to do in any progressive science, as they do in chemistry and in physics for example—goes without saying, but only a spirit of obscurantism could pretend that progress of this kind means that we see the solution of our problem fading away into the distance.

Mendel left his conclusions in the form of two general laws that may be called the law of segregation and the

law of independent assortment of the genes. They rest on numerical data, and are therefore quantitative and can be turned into mathematical form wherever it seems desirable. But though the statements were exact, they were left without any suggestion as to how the processes involved take place in the living organism. Even a purely mathematical formulation of the principles of segregation and of free assortment would hardly satisfy the botanist and zoölogist for long. Inevitably search would be made for the place, the time, and the means by which segregation and assortment take place, and attempts would sooner or later be made to correlate these processes with the remarkable and unique changes that take place in the germ-cells. Sutton, in 1902, was the first to point out clearly how the chromosomal mechanism, then known, supplied the necessary mechanism to account for Mendel's two laws.

The knowledge to which Sutton appealed, had been accumulating between the years 1865, when Mendel's work was published, and 1900, when its importance became generally known. An account of the chromosomal mechanism may be deferred, but I have spoken of it here in order to call attention to a point rarely appreciated, namely, that the acceptance of this mechanism at once leads to the logical conclusion that Mendel's discovery of segregation applies not only to hybrids, but also to normal processes that are taking place at all times in all animals and plants, whether hybrids or not. In consequence we find that we are dealing with a principle that concerns the actual composition of the material that carries one generation over to the next.

Segregation and independent assortment were the two fundamental principles of heredity discovered by Mendel. Since 1900, four other principles have been added. These are known as linkage, the linear order of the genes, interference, and the limitation of the linkage groups. In the same sense in which in the physical sciences it is custo-

mary to call the fundamental generalizations of the science the "laws" of that science, so we may call the foregoing generalizations, the six laws of heredity known to us at present. Despite the fact that the use of this word "law" has been much abused in popular biological writing we need not apologize for using it here, because the postulates in question have been established by the same scientific procedure that chemists and physicists make use of, viz., by deductions from quantitative data. Excepting for the sixth law they can be stated independently of the chromosomal mechanism, but on the other hand they are also the necessary outcome of that mechanism.

The theory of the constitution of the germ-plasm, to which Mendel's discoveries led him, not only failed to receive any recognition for fifty years, but the principle of particulate inheritance to which it appeals has met with a curious reception even in our own time, leading a recent writer to state that particulate theories in general "do not help us in any way to solve any of the fundamental problems of biology," and another writer to affirm that if the chromatin of the sperm is "pictured" as composed of individual units that represent "some specific unit-characters of the adult," then we should expect it to be extremely complex, "more complex indeed than any chromatin in the body, since it is supposed to represent them all," but "as a matter of fact chemical examination shows the chromatin in the fish sperm to be the simplest found anywhere." Were our knowledge of the chemistry of the "chromatin" as advanced as these very positive statements might lead one to suppose, the objection raised might appear to be serious, but there is no evidence in favor of the statement that the sperm-chromatin should be expected to be more complex than the same chromatin in the cells of the embryo or adult. And even were it different in the germ-tract and soma the criticism would miss its mark, because heredity deals with the constitution of the chromatin of the germ-tract and not with that of

the soma. Until physiological chemists are in position to furnish more complete information concerning the composition of the chromosomes, or more illuminating criticism of the situation as it exists, we need not, I think, be over-much troubled by such views so long as we handle our own data in a manner consonant with the recognized methods of scientific procedure.

Other critics object for one reason or another to all attempts to treat the problem of heredity from the standpoint of the factorial hypothesis. It has been said, for instance, that since the postulated genetic factors are not known chemical substances the assumption that they are such bodies is presumptuous, and gives a false analogy with chemical processes. Such critics claim that the procedure is at best only a kind of symbolism. Again, it has been said, that the factorial hypothesis is not a real scientific hypothesis, for it merely restates its facts in terms of factors, and then by juggling with numbers pretends that something is being explained. It has been argued that Mendelian phenomena relate to unnatural conditions and that they have nothing to do with the normal process of heredity in evolution that takes place in "nature." It has been objected that such a hypothesis assumes that genetic factors are fixed and stable in the same sense that molecules are stable, and that no such hard lines are to be found in the organic world. And finally it has been urged that the hypothesis rests on discontinuous variation which, it is said, does not exist.

If the implications in any or in all of these objections were true, the attempt to explain the traditional problem of heredity by the factorial hypothesis would appear fantastic in the extreme. An attempt will be made in the following chapters to present the evidence on which our present views concerning heredity rest, in the hope that an understanding of this evidence will go far towards removing these *a priori* objections, and will show that they have no real foundation in fact.

## CHAPTER II

### MENDEL'S FIRST LAW—SEGREGATION OF THE GENES

MENDEL succeeded in discovering the principle of segregation because he simplified the conditions of his experiments so that he had to deal with one process at a time. Others before him had failed because they worked with too complex a situation. In each case Mendel picked out for study a pair of contrasted characters of a kind that were sharply distinguishable from each other whenever they appeared. He chose plants that normally self-fertilize and are little liable to accidental cross-fertilization, which made it possible easily to obtain in the second generation numbers large enough to give significant results. To Mendel's foresight in arranging the conditions of his work, as much as to his astuteness in interpreting the data, is due his remarkable success.

Mendel used varieties of the common edible garden pea (*Pisum sativum*). Many of these varieties (races) differ from each other in a particular character. Some races are tall, others short; some have green peas (seeds in the pods), others have yellow peas; some of these seeds have a smooth surface, others are wrinkled; some of the pods are hard, others are soft. One of the crosses made by Mendel will serve as an illustration of his work (Fig. 1).

Pollen from a race of tall peas was put artificially on the stigma of a plant of a short race, whose own stamens, and therewith the pollen, had been previously removed. The hybrid plants that came from the seed were tall. These hybrids were allowed to self-fertilize and their seeds collected. Some of the seeds produced tall plants,

PHYSICAL BASIS OF HEREDITY

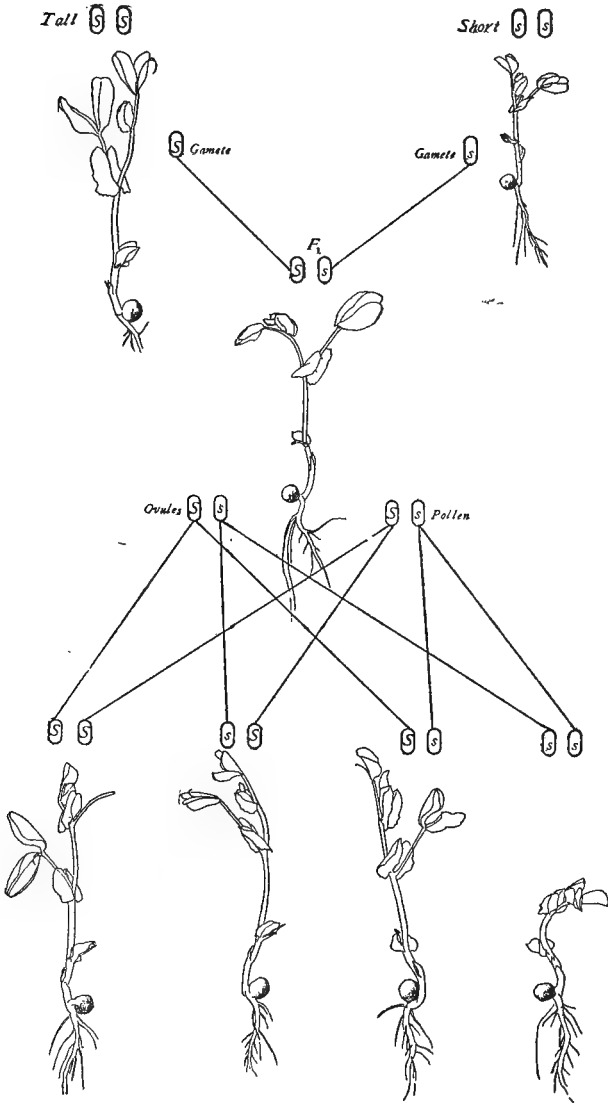

FIG. 1.—Cross between a tall and a short race of garden peas. The *F*<sub>1</sub> generation is tall. In the second generation, *F*<sub>2</sub>, there are three tall to one short. (*P*<sub>1</sub>, *F*<sub>1</sub> and *F*<sub>2</sub> were reared from peas supplied by Dr. O. E. White.)



others produced short plants; in the ratio of 3 tall to 1 short. In other words, the contrasted characters of the grandparents reappeared in the grandchildren in the ratio of 3 to 1. The experiment was carried through one more generation, which was necessary in order to get data for finding out what had been taking place. The short peas were allowed to fertilize themselves. They produced only short peas. The tall peas were also allowed to fertilize themselves. One-third of the tall peas produced only tall offspring; two-thirds produced both tall and short offspring in the ratio of 3:1, as had the first generation hybrids. Evidently then the grandchildren had been of three kinds, one kind was pure for shortness, others were hybrids, and the remaining kind was pure for tallness. These kinds appeared in the proportion of 1:2:1.

Some factor or factors in the original tall peas must cause the peas of that race to be always tall, and some factor in the original short peas must cause them to be short. The short factor may be represented by  $s$ , and the long factor by  $S$ . When crossed, the fertilized egg should contain both factors ( $sS$ ), and since the hybrids coming from this egg were tall, it is evident that tall must *dominate* over short. Now if the two factors ( $sS$ ) present in the hybrid should separate (*i.e.*, "segregate") when its ovules and its pollen-grains are formed, half of the eggs would contain the factor that represents the short peas ( $s$ ), and half of the eggs the factor that represents tall peas ( $S$ ); also half of the pollen grains would contain the factor that represents the short peas ( $s$ ), and half of them would contain the factor that represents the tall peas ( $S$ ). Chance meeting between egg-cells and pollen-cells (one ovule being always fertilized by one pollen grain), would, on the average, give one fertilized egg containing two factors for short ( $ss$ ); to two fertilized eggs that contain one of each kind of factor ( $sS$ ); to one that contains two

factors for tall ( $SS$ ). The chance combination just given may be represented graphically as follows:

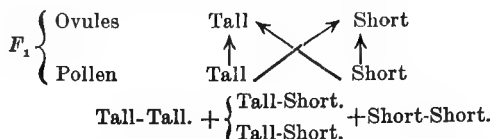

In the actual experiment that Mendel carried out, plants of the tall race measured from 6 to 7 feet, and those of the short plants three-quarters to one foot and a half. The  $F_1$  plants were as tall as, or even taller than the tall parent. When these  $F_1$ 's were self-fertilized, the seeds (either from the same plant or from a random collection of seeds from different  $F_1$  plants) produced 787 long plants and 277 short plants—a ratio of 2.84 to 1.

As a fair sample of each plant, ten seeds were taken from each of 100 tall plants of this second (or  $F_2$ ) generation. Out of the 100 plants so tested, 28 plants produced only tall plants, while 72 of them produced some tall and some short offspring. This means that 28 plants were pure (homozygous) tall, whilst 72 were hybrid like the  $F_1$  plants. Taking, then, all  $F_2$  plants together, the results show  $\frac{1}{4}$  were short,  $\frac{2}{4}$  were hybrid, and  $\frac{1}{4}$  were tall, *i.e.*, they stand in a ratio of 1:2:1.

This relation is illustrated in the scheme below, based on what 16  $F_2$  plants might give. Twelve would be tall to 4 short. If the tall plants are tested, they are found to consist of 4 pure tall ( $SS$ ) and 8 hybrid tall ( $sS$ ). Altogether, then, there are 4 tall to 8 hybrid tall to 4 short, *i.e.*, there are three kinds of  $F_2$  peas in the ratio of 1:2:1.

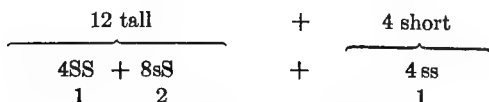

The process of disjunction, or separation of the members of a pair of factors, is known technically as *segregation*. While we sometimes also speak of the segrega-

tion of the characters themselves, it seems better, I think, to avoid as far as possible this application of the word. The factor for tall and the factor for short are said to be allelomorphic to each other. The parents are generally designated by  $P_1$ ; the first hybrid generation is known as the first filial generation, or briefly  $F_1$ . The next generation, derived from  $F_1$  is called  $F_2$ , etc. When one member of the pair of contrasted characters appears in  $F_1$  to the exclusion of the other it is said to be dominant, the eclipsed character is said to be recessive. The hybrid itself is said to be heterozygous, meaning that it contains one factor or gene of each kind, while an individual containing both genes of the same sort is said to be homozygous for the genes involved. Mendel did not emphasize the idea that even in pure races each character is also represented, as a rule, by a pair of factors or genes that segregate in the formation of the germ-cells in the same way as do the pair of contrasted genes in the heterozygotes, but at the present time this idea is accepted by all geneticists. It was at least implied on Mendel's view that the two pure classes in  $F_2$  ( $SS$  and  $ss$ ), formed by the recombination of two like genes, are identical with the two grandparental races ( $P_1$ ).

A crucial test of the correctness of the assumption that segregation of the members of a pair of elements takes place in the germ-cells of the hybrid, consists in back-crossing the hybrid ( $F_1$ ) to one of the parent stock, viz., to the not dominant stock, here the short pea. Since short is recessive to tall, it will not influence the height of the offspring when a tall and a short factor are brought together. Such a cross should show whether the germ-cells of the hybrid are, as postulated, of two sorts, and whether equal numbers of each sort are produced. Mendel made such tests, and obtained equal numbers of two kinds of offspring.

Mendel obtained results like these with tall *versus* short peas for other pairs of characters, such as fasciated *versus* normal stems, hard *versus* soft pod, yellow *versus*

green pods, gray *versus* white-skinned peas, yellow *versus* green cotyledons (seen through the skin of the seed), and round *versus* wrinkled seeds (determined by the nature of the cotyledons within the seed coat).

The 3:1,  $F_2$ , ratio characteristic for a single pair of characters is the expectation based on the chance meeting of either one of two kinds of eggs with either one of two kinds of pollen grains. In actual numbers this ratio is, of course, not always exactly realized, but only approximately. For the seven pairs of characters that Mendel examined, the  $F_2$  ratios were as follows:

		Dominants	Recessives	No's. per 4
Form of seed.....	7,324	5,474	1,850	2.99 : 1.01
Color of cotyledons.....	8,023	6,022	2,001	3.00 : 1.00
Color of seed coats.....	929	705	224	3.04 : 0.96
Form of pod.....	1,181	882	299	2.99 : 1.01
Color of pod.....	580	428	152	2.95 : 1.05
Position of flowers.....	858	651	207	3.03 : 0.97
Length of stem.....	1,064	787	277	2.92 : 1.08
Totals.....	19,959	14,949	5,010	2.996 : 1.004

The following collective data for the inheritance of color of the cotyledons of garden peas show that the approximation to a 3 to 1 for the recessive character is very close:

	Yellow	Green	Total	No's. per 4	Probable errors
Mendel.....	6,022	2,001	8,023	3.002 : 0.998	±0.0130
Correns.....	1,394	453	1,847	3.019 : 0.981	±0.0272
Tschermak.....	3,580	1,190	4,770	3.002 : 0.998	±0.0169
Hurst.....	1,310	445	1,755	2.986 : 1.014	±0.0279
Bateson.....	11,903	3,903	15,806	3.012 : 0.988	±0.0093
Lock.....	1,438	514	1,952	2.947 : 1.053	±0.0264
Darbishire.....	109,060	36,186	145,246	3.004 : 0.996	±0.0030
Darbyshire.....	1,089	354	1,443	3.019 : 0.981	±0.0308
White.....	1,647	543	2,190	3.008 : 0.992	±0.0250
Correns.....	1,012	344	1,356	2.985 : 1.015	±0.0319
Tschermak.....	3,000	959	3,959	3.031 : 0.969	±0.0186
Lock.....	3,082	1,008	4,090	3.014 : 0.986	±0.0183
Darbishire.....	222	1,856	7,518	3.013 : 0.987	±0.0135
Correns.....	2,405	70	295	3.051 : 0.949	±0.2151
Lock.....	50	850	3,250	2.954 : 1.046	±0.0205
Totals.....	218,425	50,676	203,500	3.004 : 0.996	±0.0026

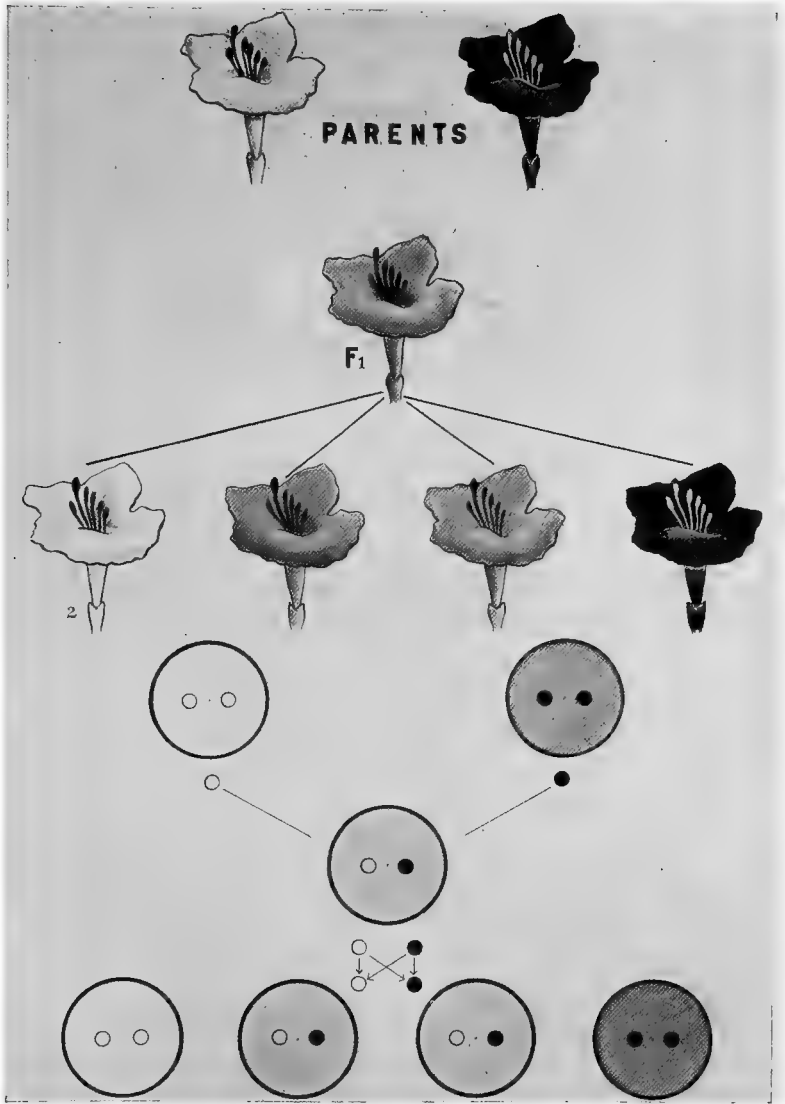

FIG. 2.—Cross between white and red flowered four-o'clocks (*Mirabilis jalapa*). In the lower part of the diagram the large circles represent somatic conditions, the included small circles the genes that are involved.



That Mendel's principles apply to animals was first made out by Bateson and by Cuénot in 1902. Since then many characters both in domesticated and in wild animals and plants have been studied, and there can be no question of the wide application of Mendel's discovery.

During the years immediately following the re-discovery of Mendel's principles (1900) much attention was paid to the phenomena of dominance and recessiveness. This was due, no doubt, to the striking fact that the hybrid sometimes resembles only one parent in some particular trait, whereas the older observations, where many characters were generally involved in the cross, seemed to have shown that hybrids are intermediate in regard to their parents. We now know, however, that although there are cases in which the dominance is as complete as in those described by Mendel, yet in a very large number of forms the hybrid is intermediate between the parents, even when only a single pair of characters is involved. A few examples will serve to illustrate these relations.

The common garden four o'clock, *Mirabilis jalapa*, has a white-flowered and a red-flowered variety (Fig. 2). When crossed, the hybrid has a pink flower, which may be said to be intermediate in color between white and red. Here neither color can strictly be said to dominate. When the hybrid ( $F_1$ ) is self-fertilized the offspring ( $F_2$ ) are in the proportion of one white, to two pink, to one red-flowered plant. The  $F_2$  reds and the  $F_2$  whites breed true; the pinks when self-fertilized give white, pink and red in the proportion of 1:2:1. In a case of this kind the color of the  $F_2$  plants reveals the nature of the three classes present, so that it is not necessary to test them out, as was the case in the  $F_2$  generations of Mendel's peas, where the  $F_2$  tall were found in this way to be of two sorts. The  $F_2$  results with the four o'clock also show that the segregation of the genes is clean, for the  $F_2$  whites never produce in subsequent generations anything

but white descendants, and the  $F_2$  reds never anything but red descendants.

In this case the color of the  $F_1$  flowers is obviously somewhere between red and white. In so far as the  $F_1$  flower is colored, it may be said that red is dominant; in which case the red and the pink  $F_2$  classes ( $1 + 2 = 3$ ) are to be counted together as contrasted with the white, giving a 3:1 ratio. On the other hand, if one chose to emphasize the fact that the  $F_1$  pink flower is not red, but affected by the white-producing element in its make-up, then not red, but white, might be said to be the dominating character; in which case the white and the pink  $F_2$  classes ( $1 + 2 = 3$ ) would be counted together as contrasted with the red giving an inverse 3:1 ratio. It appears then largely a matter of choice as to what is to be called dominance (see below). The essential fact of segregation is not affected by the decision, and it is this that is fundamentally important.

Another example of failure of complete dominance is shown in the race of Andalusian fowls. In this race there are blue, splashed-white, and black birds; the blue birds going under the name of Andalusians. When splashed-white is mated to black, all the offspring ( $F_1$ ) are blue (Fig. 3); when these blues are bred together they give 1 splashed-white : 2 blues : 1 black. Evidently the blue birds are the heterozygous type. Their feathers show under the microscope less black pigment, somewhat differently distributed from that in the black birds. The intermediate blue color is due in this case to the less dense distribution of the pigment in the heterozygote. Lippincott, who has recently examined this cross in greater detail than heretofore, states that the colored areas or splashes in the white males are either blue or blackish according to the part of the body on which they occur, and that this corresponds with the distribution of the color on the Andalusian, for while the latter is said to be blue, this applies



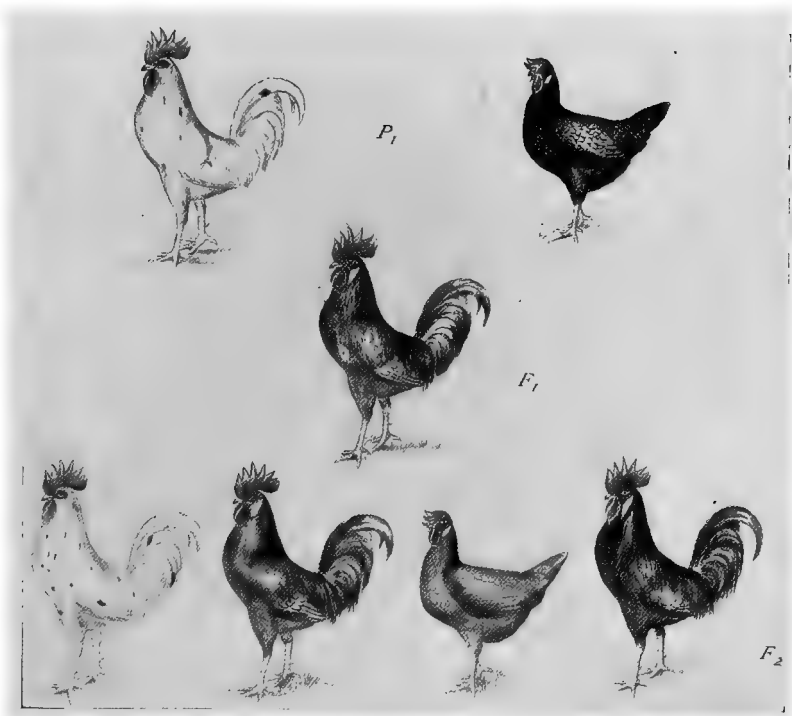

FIG. 3.—Cross between splashed-white and black, giving in  $F_1$  Andalusian, and in  $F_2$  one splashed-white, two Andalusian, and one black.



strictly only to the hen and to the lower parts of the body in the cock whose upper surface is very dark blue or even black.

In this case neither black nor white can be said to be dominant. The blue brought in as splashes by the splashed-white might indeed be regarded as dominant over the black of the other (black) parent, but if so, then the uniform distribution of the blue must be determined by dominance of the allelomorphic gene brought in by the black parent. Each parent then would contribute at the same time a dominant and a recessive effect, each the product of one member of the same pair of allelomorphs.

There are other cases in which the hybrid is intermediate in color, and, in addition, its range of variation is so large that the extremes overlap one or even both of the two parental types. For example: In the vinegar fly, *Drosophila melanogaster*, there is a race with ebony wings and another race with sooty wings. When such flies are crossed to each other, the wings of the  $F_1$  fly are intermediate in color, ranging from wings like those of sooty to wings as black as ebony. When the  $F_1$  flies are inbred they give rise to a series that at one extreme has gray wings and at the other black wings. Separation into three classes is difficult or impossible. Here it may appear that the two original characters have completely blended in  $F_1$  and in  $F_2$ , but that there are in reality three classes of flies in  $F_2$  can be demonstrated by suitable tests. If, for instance, we pick out a sufficient number of  $F_2$  males to give a fair sample of the population, and mate each male first to an ebony female of pure stock, and then to a female of sooty stock, we shall find that one-quarter of the males mated to ebony give only ebony, one-quarter mated to sooty give only sooty, while the remaining two-quarters give, both in the back-cross to sooty, and in that to ebony, a wider ranging group, which is darker on the whole when mated to ebony, and lighter when mated to

sooty. These and other tests show that in the  $F_1$  hybrid segregation of the same kind as in the preceding cases has taken place, but the results are obscured by the wide variability of the hybrid flies. In other words, evidence can be obtained that the segregation of the genes has been clean cut, even although this is obscured by the character of the heterozygous flies.

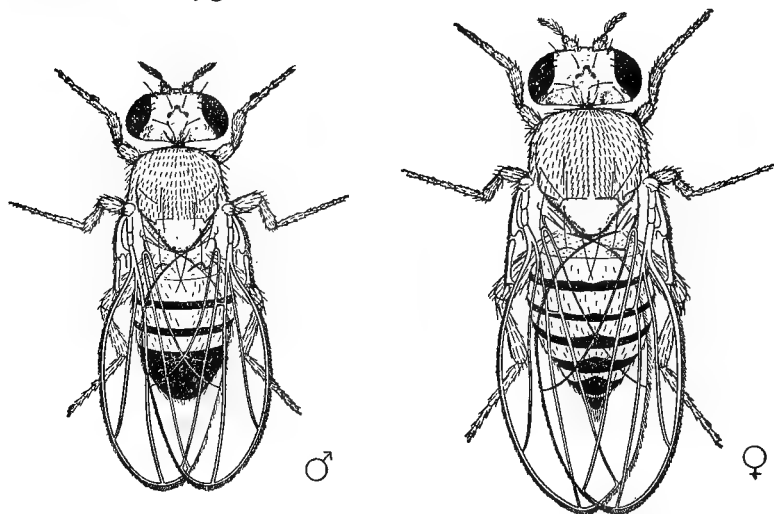

FIG. 4.—Male and female vinegar fly (*Drosophila melanogaster*).

In the preceding illustrations the character difference between the two races is supposed to show itself in the same environment. It has been found in a few other cases that the dominance of one character over the other may depend on the environment. For example, in the normal vinegar fly the black bands of the abdomen show great regularity (Fig. 4), but in a mutant race called "abnormal abdomen" (Fig. 5) the bands may be irregularly broken up, or even absent. In cultures with abundance of fresh food and moisture, all the individuals have very irregular bands, but as the culture gets old, and the

food and moisture become less and less, the bands become more and more regular until at last the flies are indistinguishable from normal flies. If a cross is made between a female with abnormal bands and a wild male, the offspring that first hatch under favorable conditions are all very abnormal. Here abnormal completely dominates normal bands. But as the culture dries up, the hybrid offspring become more and more normal, until finally they are all normal. At this time it might be said that normal dominates abnormal. Both statements are correct, if we add that in one environment abnormal banding dominates,

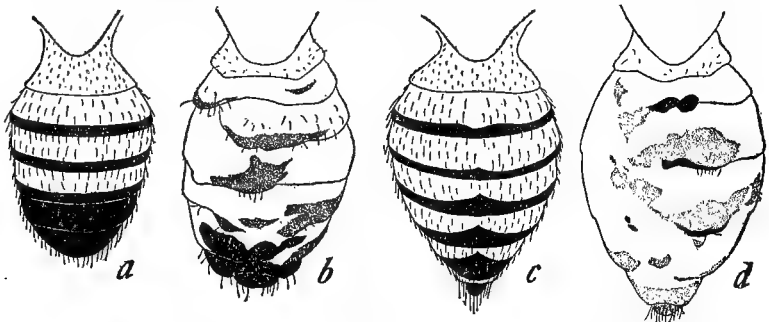

FIG. 5.—Normal and abnormal abdomen of *D. melanogaster*.

in another environment normal banding dominates. The genetic behavior of the pairs of genes is the same here as in all other cases of Mendelian behavior, but this is revealed only when the environment is one in which the abnormal gene produces one effect, the normal a different one. That the gene is not itself affected by the environment can be shown very simply. If a female from the abnormal stock be picked out, at a time when the stock has only normal bands, and crossed to a wild male, the offspring will all be as "abnormal" as when the mother herself is abnormal, provided the food and moisture conditions are of the right kind. The late hatched normal flies of abnormal stock may be bred from for several

generations, but as soon as a generation hatches under favorable conditions they are as abnormal as though all their ancestors had been of this sort. Thus it is evident that no fundamental importance is to be attached to dominance of characters. On the other hand, it is equally obvious that it would be entirely unwarranted to suppose that incompleteness of dominance is due to failure of segregation of the genes that stand for the characters.

While the problem of segregation can be studied to greatest advantage where the characters of a pair are sharply separated, yet even where the pair does not possess this advantage, the cleanness of the segregation process can be just as definitely, though more laboriously, demonstrated.

In cases where there is an overlap between the heterozygous type and one of the parental types it may, simply as a matter of convenience, be advantageous to call that character that gives the more continuous  $F_2$  group the dominant, thus leaving the smaller more sharply defined group as the recessive. For example, the  $F_2$  group from black by wild-type *Drosophila* may be represented by such a scheme (Fig. 6) as the following:



FIG. 6.—Relation of black body color to wild type as shown by the classes of  $F_2$  flies. The heavy outline includes the mutant class, the lighter line the wild type, and the dotted line the heterozygous class.

Here the heterozygous flies are typically intermediates, but their variability overlaps that of the wild type to such an extent that separation of the intermediate from the wild type is practically impossible. On the other hand, there is no difficulty in making a complete separation between the heterozygous class and the homozygous black.

Black is accordingly treated as a recessive in nearly all experiments.

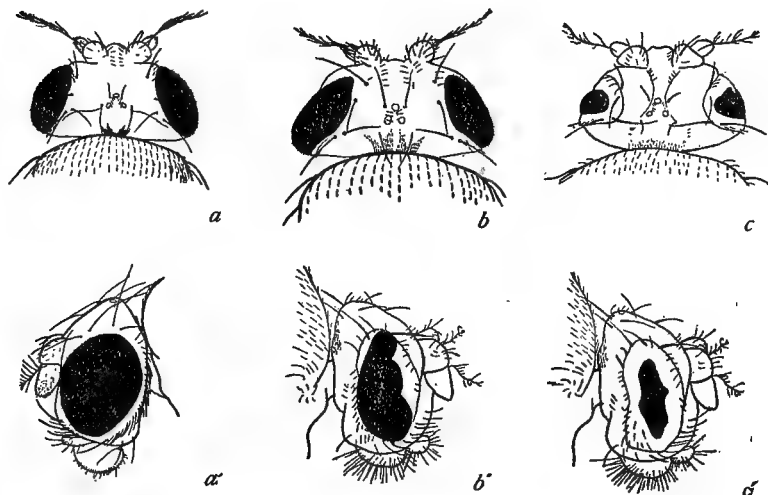

FIG. 7.—Normal eye, *a*, *a'*, heterozygous eye *b*, *b'*, and bar eye *c*, *c'*, of the vinegar fly.

A mutant eye shape of *Drosophila*, called "bar" (Fig. 7, *a*), has an intermediate hybrid type (Fig. 7, *b*). The  $F_2$  group may be represented (Fig. 8) in the following scheme:

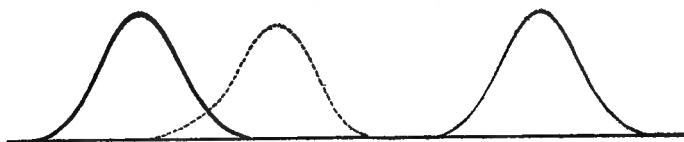

FIG. 8.—Relation of bar eye to normal eye, as shown by the  $F_2$  classes.

In this case the hybrid, intermediate type, overlaps the bar type, so that in  $F_2$  these two latter types give a nearly continuous class. At the other end of the  $F_2$  series, the round eyed normal (or wild) type can be distinguished without difficulty from either of the other classes. Bar is therefore normally treated as a dominant.

The case of *Mirabilis*, or of the Andalusian fowl, might be represented (Fig. 9) in the following scheme:

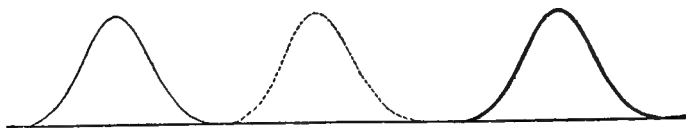

FIG. 9.—Relation of Andalusian to splashed white and to black as shown by classes of  $F_2$  birds.

Here all three types are fully separable, in which case either homozygote might be considered the dominant.

Finally, to return to the case of the tall and short peas, the following scheme (Fig. 10) represents the  $F_2$



FIG. 10.—Relation of tall to short peas as shown by  $F_2$  classes.

group: Here the tall and the heterozygous group are alike, and inseparable by ordinary inspection, even at the extreme end of their variation curves, and short is "completely" recessive.

In cases in which the environment enters more obviously into the result (as in "abnormal abdomen," Fig. 5), the following scheme (Fig. 11) represents the relation:

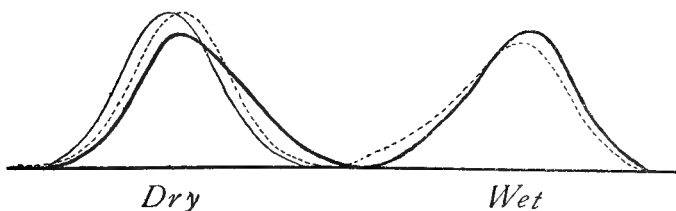

FIG. 11.—Relation of normal to abnormal abdomen as shown by classes of  $F_2$  flies. "Dry" signifies conditions that make for normal; wet for abnormal.

In this case both the heterozygous and the parental "abnormal" type may show "normal" abdomen like the



wild type. The abnormal type is treated as the dominant although only when the conditions are favorable to its appearance is the hereditary phenomenon seen. In another case (duplicate legs) only the homozygous form may show the duplications (in a special environment). The following scheme (Fig. 12) represents this relation, reduplication of legs being treated as a recessive:



FIG. 12.—Relation of normal to duplicate legs.

There are still other relations that affect the dominance of characters. For example, there may be internal factors, which when present, determine that a character shall be dominant over its allelomorph, or recessive to it. In this connection might be mentioned what has been called "reversal of dominance." An example from Davenport will illustrate what is meant. In a certain strain of fowls there is a tendency for the toes to be united by a web at the base. Crossed to birds with normal feet, no birds with united toes (syndactyls) appeared in  $F_1$ . The  $F_1$  birds inbred gave in  $F_2$  only about 10 per cent. of syndactyl birds. It would appear that the latter character is recessive, and that the recessive type overlaps largely the dominant heterozygous type.

Davenport interpreted, however, the syndactyl as the dominant type, because "two syndactyls may give normals, but no true normals give syndactyls." In other words, he defines the dominant type as the one that can carry the other type, because he says dominance is due to presence of factors, recessiveness to absence. "Now dominance may fail to develop but recessiveness never can do so." For this reason two syndactyls may give

normals, because a dominant character may fail to develop, even though its factors be present. Since normal feet never give syndactyls, the normal type must be recessive. But Davenport's definition of a recessive type as one that never shows in the heterozygous condition is in my opinion based on an arbitrary distinction of what is the *cause* of dominance and recessiveness. The evidence may, I think, be better interpreted as indicated in the same diagram as that for abnormal abdomen (Fig. 11) in that part marked "dry," in which the syndactyl condition would be represented as recessive (heavy line). In the hybrid the character is usually seen only in a few individuals, *i.e.*, it is intermediate, overlapping both parent types. While this case shows that it is often only a convention as to which type is called the dominant and which the recessive, I can see no special reason why in these cases of syndactylism the usual convention may not be followed which recognizes the small  $F_2$  class as the recessive.

Mendelism rests on the theory of a clean separation of the members of each pair of factors (genes). In every heterozygote the factor for the dominant and that for the recessive are supposed to come into relation to each other and then to separate at the ripening of the germ-cells. If we think of the two genes coming together and afterwards separating, it would seem that a favorable situation might exist for the two to become mixed, and one "contaminate" the other. If any extensive process of this kind occurred the Mendelian phenomena would be so irregular and erratic that they would have little interest. But even those who are inclined to appeal to contamination as an exceptional phenomenon, grant that clean separation of the genes is the rule. The best critical evidence against contamination is in cases in which for many successive generations breeding has taken place from heterozygous forms only (which creates a favorable situation for contamination to take place were it possible). No influence of contamination has been found in such cases.

Marshall and Muller kept flies heterozygous for three recessive mutant factor for about seventy-five generations, and at the end of that time found that these factors had not been weakened in any way as a result of juxtaposition

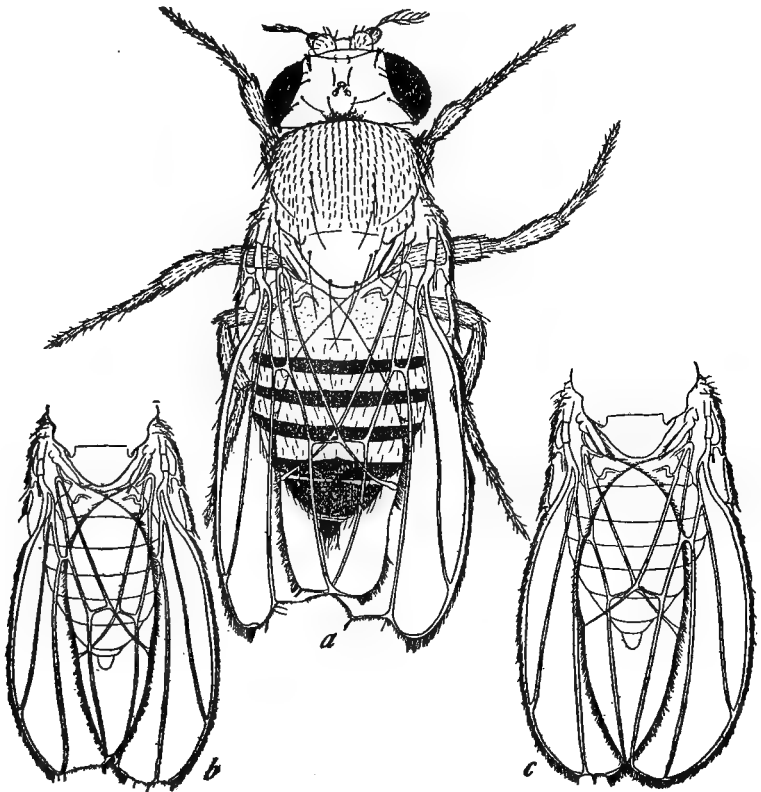

FIG. 13.—Notch wings in the vinegar fly, extreme condition, *a*; average condition, *b*; nearly normal condition, *c*.

with their normal dominant allelomorphs. I have kept a stock of notch-winged flies under selection for twenty-five generations. Notch (Fig. 13) is a character varying in the direction of normal wings (Fig. 13, *c*); in every generation of notch, many notch flies have normal wings. The character is dominant, and exists only in heterozy-

gous condition, since a fly homozygous for notch dies. The race is therefore necessarily maintained in a heterozygous state. In each generation females that were genetically notch, but had normal wings, were selected and bred to normal males. The selection was away from notch (*i.e.*, toward normal). After a time more than half of the notch flies had normal wings. The effect produced proved to be due not to a change in the notch gene through contamination, but to modifying genes; for at the end of the selection the original notch could be recovered at any time by removing the influence of the modifying factor.

It has been sometimes stated, usually by the opponents of Mendel's theory, or by advocates of doctrines of evolution that appeared to be compromised by the Mendelian conception of "unit factors," that Mendelism deals only with such superficial characters as the color of flowers or the hair color of mammals. This statement contains an element of truth in so far as it covers most of the kinds of characters that students of heredity find most convenient to study; but it contains an entirely false inference as to the limitations of Mendelism. The issue involved is this: changes in superficial characters are not so likely to affect the ability of the organism to survive as are changes in essential organs; hence they are the best kind of hereditary characters for study. But there is no evidence that such superficial characters are inherited in a different way from "fundamental" characters, and there is evidence to the contrary. A common class of characters showing perfect Mendelian behavior are so-called lethals that destroy the individual when in homozygous condition. There can be no question as to the fundamental importance of such factors. Between these extreme cases and the superficial shades of eye color, for example, all possible gradations of structure, physiological and pathological, are known. The only possible question that might be seriously raised is whether these characters are all losses or deficiencies, while progres-

sive advances may belong to a different category. This may be a serious question for the evolutionist, but has nothing to do with the problem that concerns us here.

In recent years an entirely unexpected and important discovery in regard to segregating pairs of genes (allelomorphs) has been made. In an ever-increasing number of cases it has been found that there may be more than two distinct characters that act as allelomorphs to each other. For example, in mice, yellow, sable, black, white-bellied gray, and gray-bellied gray (wild type) are allelomorphs, *i.e.*, any two may be present (as a pair) in an individual, but never more than two. In *Drosophila* the eye colors white, eosin, cherry, blood, tinged, buff, milk, ivory, coral and the normal allelomorph form a series of multiple allelomorphs. In the grouse locust, *Paratettix*, there are nine types that may be allelomorphic, all of which exist in the wild state (Nabours). In *Drosophila*, again, there are as many as twelve other series of allelomorphs known at present; in rats there is a small allelomorphic series, also two in guinea pigs and two in rabbits. In plants there are a few cases known, especially in corn. In all these series it is the same organ that is mainly affected by the different allelomorphs, which seems "natural," but was not necessarily to have been expected. The chief interest of these series is that they appear to demonstrate that the normal (wild type) allelomorph, and its mutant mates need not be due to presence and absence, but rather represent modifications of the same unit in the hereditary material; for, taken literally, only one absence is thinkable, and yet in *Drosophila* there are eight such "absences" in one series.

As has been stated, Mendel did not make it clear that there exists in the normal animal or plant the same duality that comes to light when a hybrid is produced; nevertheless this condition is implied, at least, in his paper, and has been taken for granted in practically all of the modern work on heredity. The demonstration that such

is the case is, however, not a simple matter. It could not have been made by Mendel or in the earlier days after the rediscovery of Mendelism (1900). An attempt to furnish this demonstration is given in Chapter XX. Assuming the demonstration to be satisfactory, we reach the highly important conclusion that segregation is not something peculiar to hybrids, but something most readily demonstrated by means of hybrids, and that in all probability the germ-plasm is at first made up of pairs of elements, but at the ripening of the germ-cells these elements (genes) separate, one member of each pair going to one daughter cell, the other member to the other cell. The mechanism by means of which such a process might take place had been known for several years before its relation to Mendel's principles of segregation was realized. This mechanism is to be found in the conjugation and reduction processes that take place in the maturation of egg- and sperm-cell. An account of this process is given in the next chapter.

## CHAPTER III

### THE MECHANISM OF SEGREGATION

ONE of the most secure generalizations of modern work on the cell is that every cell of the individual contains a *constant number* of self-perpetuating bodies (called chromosomes), half of which are traceable to the father and half to the mother of the individual. No matter how specialized cells may be, they contain the same number of chromosomes. Equally important is the fact that after the eggs of the female and the sperm-cells of the male have passed through the ripening or maturation divisions the number of chromosomes is reduced to half.<sup>1</sup> Lastly, there is convincing evidence that the reduced number of chromosomes is brought about as the result of a separation of such a kind that each mature germ-cell gets only a paternal or a maternal member of each chromosome pair.

The reduction takes place in the female at the time when the polar bodies are given off from the egg; and in the male just prior to the formation of the spermatozoa. A characteristic process is seen in the oögenesis and spermatogenesis of the nematode worm *Ancyracanthus cystidicola* (a parasite in the swim-bladder of fresh-water fishes) described by Mulsow. The young eggs contain twelve chromosomes (Fig. 14, *a*). As the result of the later union of these twelve in pairs, six short threads appear in the nucleus of the egg just before it extrudes its polar bodies. The threads contract to six short rods (split in two planes at right angles to each other), the tetrads (Fig. 14, *c*). With the dissolution of the nuclear wall these tetrads are set free in the protoplasm, and a spindle develops about them (Fig. 15, *a*). They pass to the equator of the spindle, and there dividing lengthwise,

---

<sup>1</sup> Exceptions occur in certain cases of parthenogenesis.

half of each goes to one pole, and half to the other pole of the spindle (Fig. 15, *b*). One end of the spindle protrudes from the egg, and around it the protoplasm con-

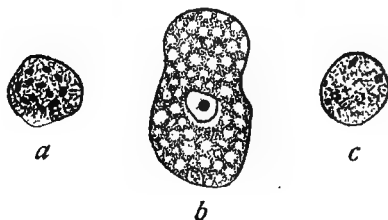

FIG. 14.—Oöcyte of *Ancyracanthus*, *a*; growth period, *b*; nucleus with tetrads, *c*. (After Mulsow.)

stricts off (Fig. 15, *c*) to form the first polar body. About the six ovoidal chromosomes left in the egg a new spindle develops; and these chromosomes become drawn into its equator, where they divide again, half of each going

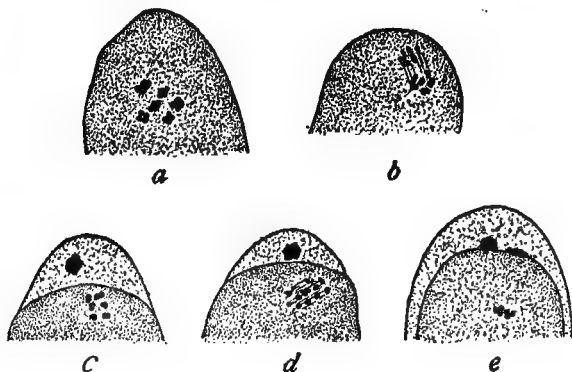

FIG. 15.—Egg of *Ancyracanthus* with six tetrads, *a*; egg with first polar spindle, *b*; egg after extrusion of first polar body, *c*; egg with second polar spindle, *d*; egg after the extrusion of both polar bodies, *e*.

to one pole and half to the other (Fig. 15, *d*). A second protrusion takes place from the surface of the egg which pinches off to form the second polar body (Fig. 15, *e*). Thus, after two mitotic divisions, the egg has lost three-quarters of its chromatin, but retains half the full



number of chromosomes, and as a result, the original twelve chromosomes have been reduced to six.

Around the six chromosomes left in the egg, a nuclear wall forms, and the chromosomes become spun out into delicate fibres. Meanwhile a spermatozoön has entered the egg, and out of its head another nucleus develops. The two nuclei, the egg nucleus and the sperm nucleus, move toward the center of the egg (Fig. 16, *a*), where they come into contact with each other. After a time, the chromatin threads begin to condense again into rods.

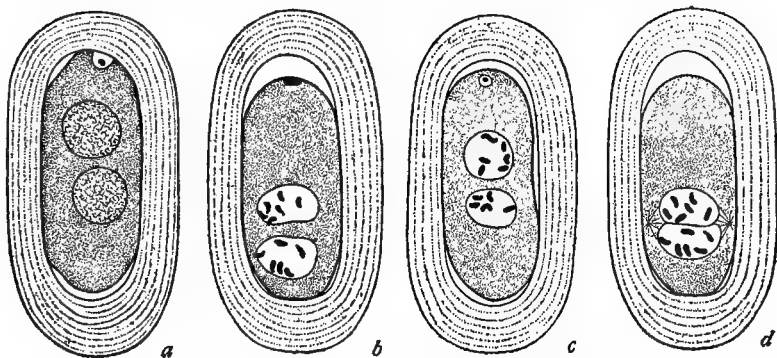

FIG 16.—Eggs of *Ancyracanthus* within membrane. Egg with two pronuclei, *a*; egg pronucleus with six chromosomes and sperm nucleus with six chromosomes, *b*; egg pronucleus with six chromosomes and sperm nucleus with five chromosomes, *c*; union of male and female pronuclei, *d*. (After Mulsow.)

Six appear in the egg nucleus, and six in the male nucleus (Fig. 16, *b*)<sup>2</sup>. A spindle develops in the protoplasm of the egg around the twelve chromosomes of which six have come from the father (the paternal chromosomes) and six from the mother (the maternal chromosomes) (Fig. 16, *d*). Each chromosome now splits lengthwise into equivalent halves, and a half moves to each pole of the mitotic spindle. The spindle rotates in the cytoplasm of this egg until its long axis corresponds with that of the egg. As the daughter chromosomes move towards the poles of the mitotic spindle the egg protoplasm constricts

<sup>2</sup> Assuming a female producing sperm to have entered.

between them so that two cells are formed, each cell containing twelve chromosomes, six paternal and six maternal. Thus, through fertilization, the whole number of chromosomes is restored to the egg. This number remains through all subsequent divisions of the cells of the embryo.

The male of *Ancyracanthus* has only eleven (Fig. 17, *a*) chromosomes; because the male has only one sex-chromo-

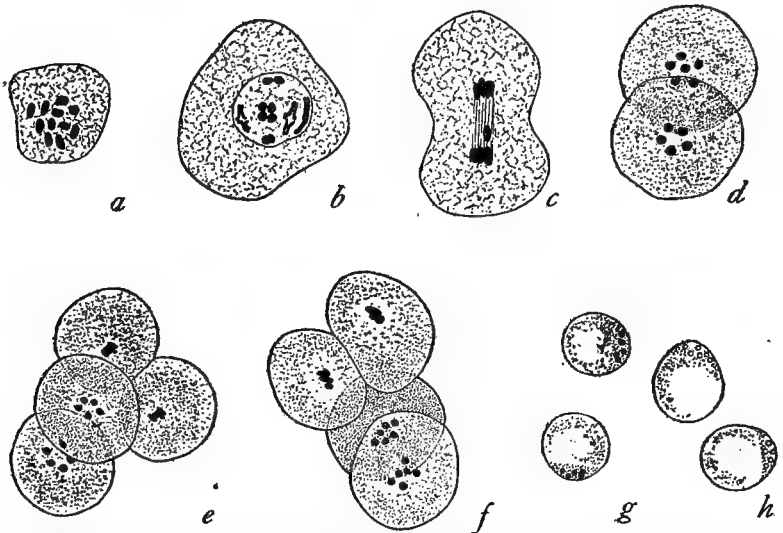

FIG. 17.—Spermatogenesis of *Ancyracanthus*. Spermatogonial cell, *a*; cell after growth period with tetrads, *b*; first spermatocyte division, *c*; two cells resulting from first division with six and with five chromosomes, respectively, *d*; four cells resulting from the next division, *e*; ditto, *f*; mature spermatozoa, one with six, the other with five, chromosomes, *g*; ditto, living spermatozoa, *h*. (After Mulsow.)

some, while the female has two sex-chromosomes. Both sexes have ten other chromosomes, sometimes called autosomes. Just before the maturation divisions take place, there are six rods in each sperm-cell, five of which (the autosomes) condense into tetrads, the sixth (the sex-chromosome) into only a double body (Fig. 17, *b*). A spindle develops about these and each of the five autosomes divides. The sex-chromosome does not divide, but passes to one pole of the spindle (Fig. 17, *c*). The result

is that two cells are produced, one with six, the other with five chromosomes (Fig. 17, *d*).

Without a resting stage a new spindle develops in each cell, and a new division takes place—each dumb-bell-shaped body dividing, as well as the sex chromosome in the cell that contains it. In all, four cells result (Fig. 17, *e* and *f*)—two with five chromosomes each, two with six each. Each becomes a spermatozoön, which in this worm is a round cell with the chromosomes at one pole (Fig. 17, *g*). Half of the spermatozoa contain six, half five chromosomes. They can be distinguished even in the living sperms (Fig. 17, *h*). If a six-chromosome sperm fertilizes an egg (Fig. 16, *b*), a female (with 12 chromosomes) is produced—if a five-chromosome sperm fertilizes an egg (Fig. 16, *c*), a male (with 11 chromosomes) is produced.

The two chromosome divisions (or separations) that take place when the polar bodies are extruded from the egg are, for a number of reasons that need not be entered into here, generally regarded as equivalent to the two final divisions in the ripening of the sperm-cells. One of the two divisions is interpreted as an ordinary cell-division in which the chromosomes split lengthwise into equivalent halves—half going to each pole. The other division is interpreted as a separation of whole chromosomes that have come together side by side at an earlier stage. The tetrad is, then, looked upon as a pair of chromosomes that have conjugated in the sense that they have come to lie side by side (with interchange of materials at times in a way to be described later). One split is supposed to correspond to the line between the conjugated pairs; the other split represents a division in each chromosome of the pair. As a consequence when the chromosomes move apart (at the maturation division) one of the two divisions is said to be a “reducing division” because whole chromosomes are supposed to separate; the other division is said to be an “equation division,” each

chromosome splitting lengthwise into equivalent halves as in ordinary cell-division.

The interpretation of these two divisions that occur in the egg and in the sperm-cell has been the subject of much speculation. It is apparent that the process reduces the number of chromosomes by half, and that the whole number is regained by fertilization. It is sometimes said that the "purpose" of this division is to keep the number of chromosomes constant, for, if not reduced, they would increase in number with each fertilization.

The "reason" for the other, the second, division is acknowledged to be obscure. For present purposes it is futile to speculate concerning these two divisions, but it should be pointed out here that the genetic evidence is in full accord with the interpretation of these two divisions that is generally accepted to-day by cytologists, *i.e.*, that one of the divisions separates the conjugating pair, and that the other represents a longitudinal division within a paternal and within a maternal chromosome of each pair.

If we follow the history of the germ-cells further back before the maturation divisions, we find that between the stage when the half number of chromosomes reappears (tetrads) and the stage at which the full number was present, there is a very obscure period in the history of the germ-cells. This period has been studied chiefly in the male. Only a few types have been found favorable for the study of this period. One of the most favorable ones is a marine annelid, *Tomopteris*, studied by the Schreiners. The early division of the germ-cells (the spermatogonia) of *Tomopteris*, when the full number of chromosomes is present, is shown in Fig. 18, *a-g*. The division is like that of all the other cells of the body. The chromosomes appear as thick bent threads that split lengthwise (Fig. 18, *a, b*). The nuclear wall disappears and a spindle appears near the group of split chromosomes (Fig. 18, *c*). As the poles of the spindle move apart the chromosomes become arranged at the equator of the spin-

dle, each half of each chromosome becoming attached by a spindle fibre to one pole (Fig. 18, *d*). The halves move

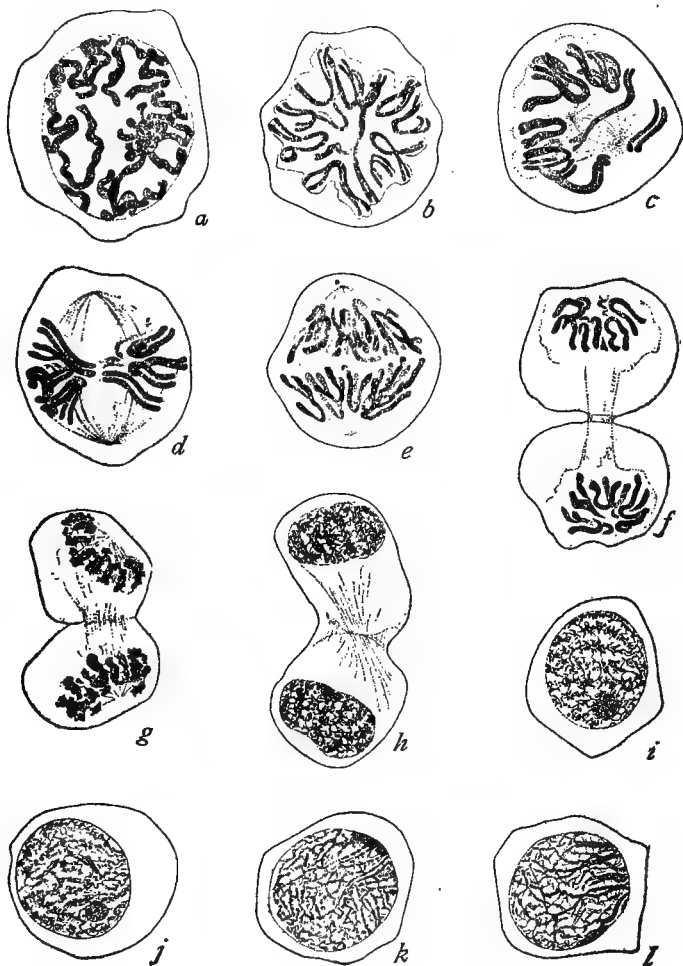

FIG. 18. Last spermatogonial division of *Tomopteris*, *a-h*; stages before and during synapsis, *i-l*. (After Schreiner.)

apart towards their respective poles (Fig. 18, *e*) and as they become separated into two groups the cell protoplasm

constricts between them to produce new cells (Fig. 18, *f*). When the chromosomes have reached the pole they shorten (Fig. 18, *g*) and appear to send out anastomosing threads. Around this group of threads a new nuclear wall is formed (Fig. 18, *h*). All trace of the separate chromosomes is now lost, but between the last stage just described and the stage now to be described it is supposed that important changes in the chromosomes take place. This new phase is spoken of as the synapsis stage. At the beginning of this stage (Fig. 18, *i* and *j*) faint indications of the chromosome appear, and soon they can be seen again (Fig. 18, *k*) as long thin threads whose free ends place themselves in parallel pairs. The pairing of the threads continues to extend inwards from the ends (Fig. 18, *l*) until they have united throughout the length of the loops (Fig. 19, *a*). There are exactly half as many of these loops as there were original chromosomes, which is expected if they have united in pairs. The conjugation has been accomplished.

During the stages that follow, the double chromosomes shorten and become thicker (Fig. 19, *b, c, d*), and condense into the form of tetrads (Fig. 19, *e*). They begin to separate into halves, each half is also split lengthwise. A spindle appears, and the cells divide (Fig. 19, *f, g, h*). In each cell the chromosomes show indications of passing into a resting stage, as happens after all ordinary cell divisions, but before this change has gone very far a new spindle appears (Fig. 19, *i*), and preparations for another division are rapidly made. The new division completes the maturation of the sperm-cells (Fig. 19, *j, k, l*). Each of the four cells resulting from the original sperm-mother-cell differentiates into a spermatozoön.

In one of the salamanders, *Batrocoseps*, the maturation stages of the male are particularly well shown. The essential stages in synapsis are shown in Fig. 20, *a-d* as worked out by Janssens. These stages are essentially the same as those of *Tomopteris*. During the early multiplication stages the cells of the future testes divide by

the ordinary mitotic process. The cells then pass into the synaptic stage (Fig. 20, *a-d*). As the chromosomes begin

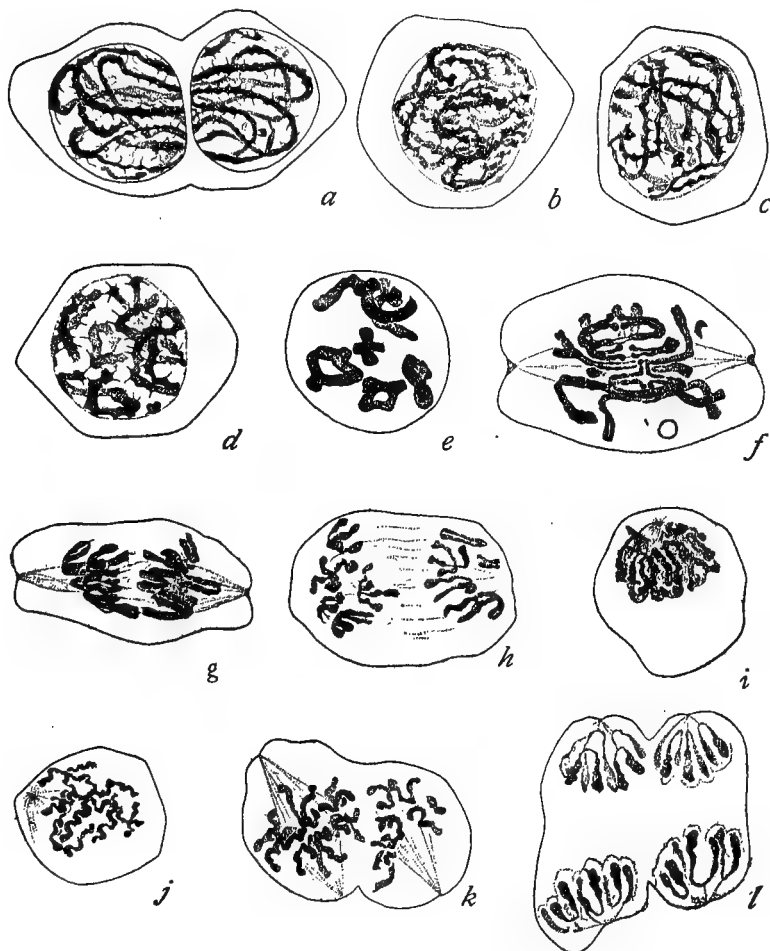

FIG. 19.—Thin-thread stage of *Tomopterus* spermatocyte, *a-d*; tetrads, *e*; first spermatocyte division, *f-i*; second spermatocyte division, *j-l*. (After Schreiner).

to emerge as thin threads, it is found in *Batrachoseps* that their ends are all pointed towards one pole (Fig. 20, *d*). This is the same pole as that towards which the two ends

of each V-shaped chromosome pointed as the cell went into the resting stage. It appears then that the chromosomes not only retain their original orientation, but that the ends of homologous chromosomes have already come

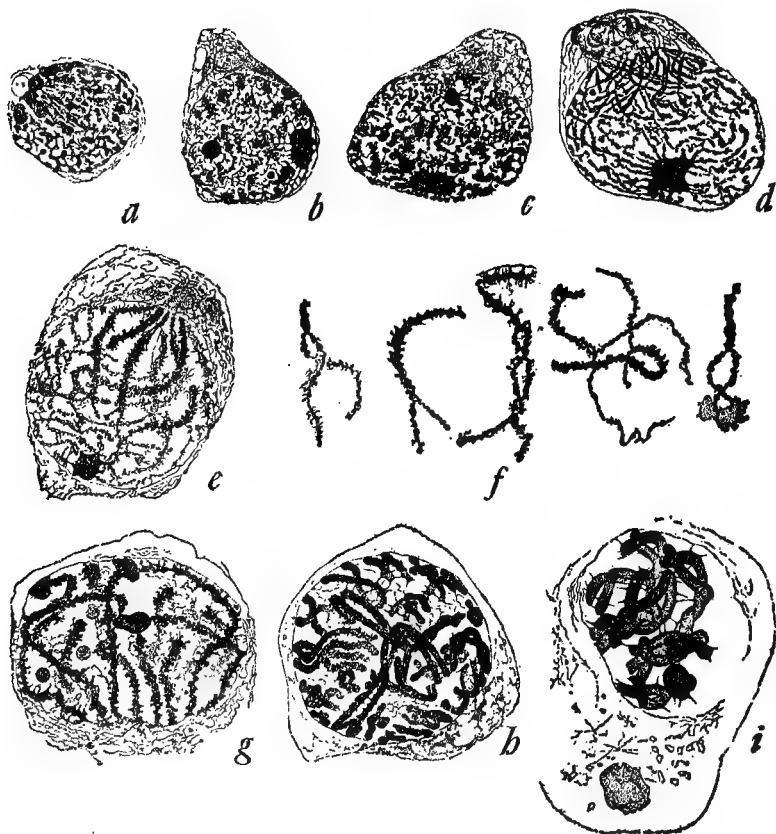

FIG. 20.—Synaptic stages and those immediately following in *Batracoseps*. (After Janssens.)

together, or are coming together, as the following stages show clearly.

The union that begins at the ends (Fig. 20, e) gradually extends along the length of the chromosomes, which



are now in the form of thin threads. At the point where the two threads come together (Fig. 20, *f*) they can often be seen to be shaped like a Y and, at the point of meeting, the uniting threads are often twisted about each other.

The fused part of the united threads steadily grows shorter and thicker. They become the condensed pachytene threads, and appear as represented in Fig. 20, *g*. The thick threads shorten further, and the line of fusion between them (or a new line of cleavage) appears, as seen in Fig. 20, *h*. It will be noticed also that the ragged outline that the chromosomes had during the preceding stages is gradually lost, so that they now appear as solid rods or cords, which finally when they have reached the last stage in their condensation (Fig. 20, *i*) appear (in *Batrachoseps*) as rods *twisted about each other*. Whether this twisting represents the original wrapping around each other of the leptotene threads as they conjugate, or whether it is a new arrangement resulting from the condensation of the chromosomes that are not free to move at all points, hence twist about each other as they condense, is a question that calls for further and careful consideration. For the present—since segregation alone is here involved—this matter may be laid aside. In this condensed condition the chromosomes pass into the first maturation division.

As already stated, the union of the chromosomes in the eggs of the female has been less often studied, but that the process is essentially the same is sufficiently evident. In one of the sharks, *Pristiurus melanostomus*, the following stages described by Maréchal show how similar are the maturation stages in the female to those in the male. When the germ-cells have reached the end of the multiplication period they pass into the synaptic condition, as shown in Fig. 21, *a* to *d*. Then threads appear in the nucleus; and soon it becomes evident that most of them are in the form of loops, whose ends are uniting in pairs (Fig. 21, *e*, *f*). When conjugation is finished thick loops

are present that shorten further into thick rods (Fig. 21, *g*) that often show a single longitudinal split. The egg now begins to accumulate the enormous amount of yolk characteristic of selachian eggs; and during this time the chromosomes become more and more indistinct. As shown in the figure (Fig. 21, *h-k*) they appear to send out loops laterally, which loops may be only the bendings of a long thread. When the yolk formation is finished the chromosomes condense into shorter threads, with lateral branches (Fig. 21, *l*). When the egg is ripe, the nuclear wall is absorbed, the chromosomes appear as short rods (arranged in twos), which place themselves in the polar spindle. Two polar bodies are given off, leaving the reduced number of chromosomes in the egg.

It is obvious from the preceding account that the sperm and the egg pass through essentially the same stages during maturation, the essential feature of which is the conjugation of homologous chromosomes followed by their subsequent segregation. Each sperm and each egg is left with half the original number of chromosomes—one of each kind.

#### LATERAL VERSUS END-TO-END FUSION OF THE CHROMOSOMES

In the preceding account of the union of the chromosomes only one method of union is described, viz., side-to-side conjugation. The tetrad as represented is due to one division plane between the conjugating pairs, and the other due to a longitudinal split of each conjugating member. But according to some observers, more especially botanists, another method of union also occurs, in which the split chromosomes unite end to end. If the division planes in such a tetrad represent respectively the plane of union at the ends, and the longitudinal split through the united rods, the final result of this separation would be exactly the same so far as the four elements of the tetrad are concerned, but the process would have serious conse-

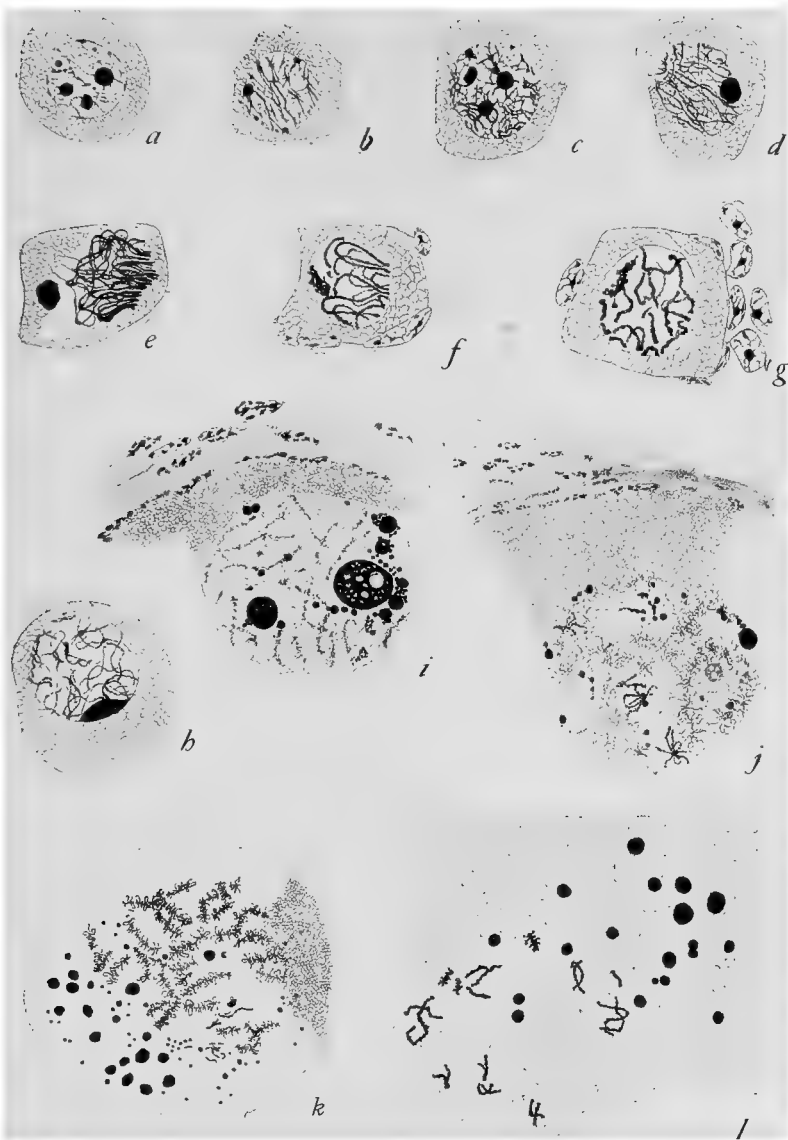

FIG. 21.—Synaptic stages, and those immediately following, in the egg of *Pristiurus*.  
(After Maréchal.)



quence for genetics in so far as the chromosomes represent the bearers of genes, for while side-to-side union offers an opportunity for interchange between the paternal and maternal members of a pair, no such interchange could be postulated if end-to-end conjugation took place. So far as segregation is concerned either method supplies all that is called for.<sup>3</sup> A discussion of other matters will be left until later.

#### INDIVIDUALITY OF THE CHROMOSOMES

During the period of cell-division there can scarcely be any question concerning the persistence of the individual chromosomes, because they remain visibly distinct elements in the cell; but when the nucleus re-forms after each division the chromosomes spin out threads laterally, and these appear to fuse, making a continuous network throughout the nucleus. Whether there is actual fusion between these threads or whether they occupy delimited contact areas, and whether the branches represent the essential part of the chromosome concerned in heredity, are questions impossible to answer at present. The genetic evidence at least consistently shows that no real fusion of the hereditary material occurs even in cells that have passed through many such resting periods.

From several other sources there are strong indications that the chromosomes retain their individuality during the resting stage. In *Ascaris*, where the chromosomes are few and long, they are often drawn out in an irregular way in the cleavage cells as they pass to the poles of the spindle of the dividing cells. Daughter halves of the same chromosomes show the same identical irregularity. Boveri has shown by an examination of a large number of daughter cells (pairs) that are getting ready for the next division, that when the chromosomes of sister cells reap-

---

<sup>3</sup> If the pairs fused end to end and the tetrad arose by two longitudinal divisions, the outcome would not be in harmony with the theory of segregation based on separation of maternal and paternal chromosomes at reduction.

pear they show the identical irregularities (Fig. 22, *a* to *d*). It is probable, therefore, that each chromosome has retained the particular form that it had when it passed into the resting stage; or at least that the axial thread from which the network was spun out has remained in place.

In a few cases the chromosomes appear more or less visible during the resting stages. This, however, is such a rare event that it is doubtful whether it can be appealed to in support of the view that in other cases the chromosomes remain intact.

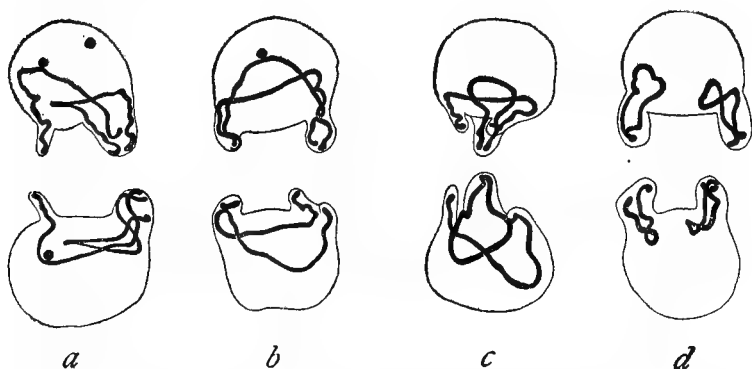

FIG. 22.—Sister blastomeres of *Ascaris* preparatory to another division, showing similar arrangements of chromosomes. (After Boveri.)

The most convincing evidence comes from exceptional cases of accidental or irregular distribution of one or more chromosomes, so that an egg, or a cell comes to have one more chromosome than is usually present. In the thread-worm *Ascaris* there are two varieties—one that has four chromosomes in the embryonic cells (with two as the reduced number) and another variety with two chromosomes (with one as the reduced number). A few females have been found in which the unfertilized eggs contain one of these numbers, and all of the spermatozoa that have been received from another individual the other number. In such cases the fertilized eggs, and

all embryonic cells, have three chromosomes each (Fig. 64), showing that when an egg starts with three chromosomes, this number is retained through all subsequent divisions, despite the fact that after each division a resting stage intervenes.

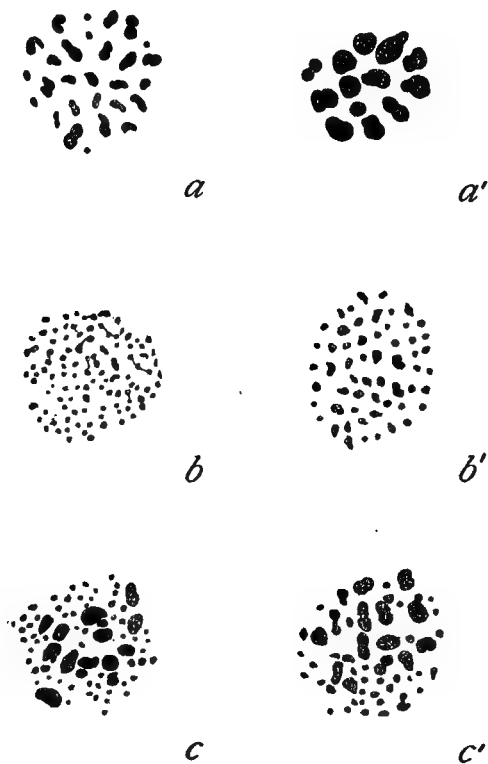

FIG. 23.—Normal *a*, *b*, and reduced *a'*, *b'*, chromosomes of two species of *Biston*; and of hybrid *c*, *c'*.

The evening primrose, *Oenothera Lamarckiana*, has 14 chromosomes (reduced number 7). Individuals are known in which there are 15 chromosomes. As a result of accidental displacement at a division in a germ-cell, possibly one cell came to contain an additional chromosome. Such a cell combining with a normal one, at fertil-

ization, would produce a plant of the 15-chromosome type. Here again, the additional chromosome persists as an individual element of the cell throughout subsequent cell-generations.

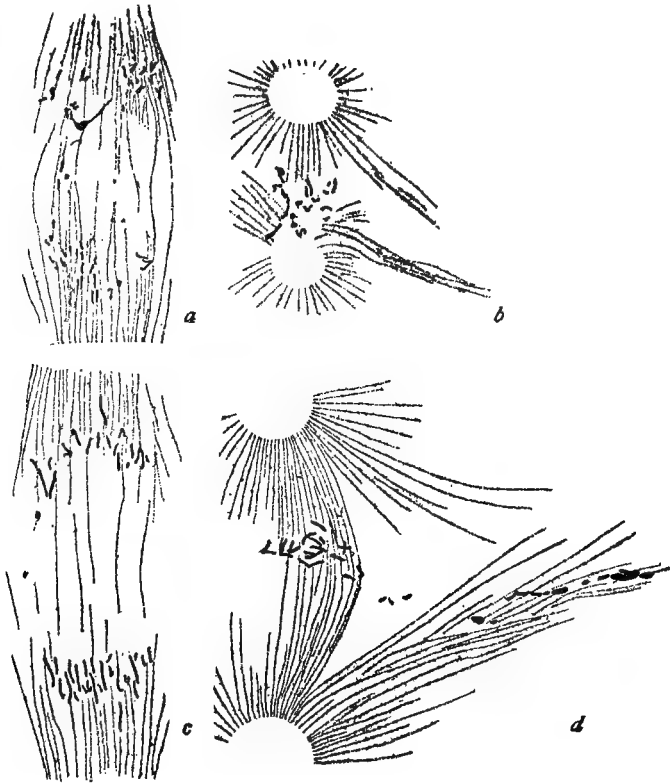

FIG. 24.—Lagging and elimination of chromosomes in hybrid fish embryos. (After Pinney).

In *Drosophila* a female occasionally appears with two X's and a Y-chromosome. There are several ways in which this may arise, but the most common way apparently is for an egg to retain both of its X elements. Such an egg fertilized by a Y-bearing sperm produces an XXY embryo. Such an embryo retains throughout the entire



development (cell-divisions) its two X's and its Y. There is evidence for this, obtained by Bridges, both from observation of the cells themselves and from the genetic behavior of such an individual.

In certain crosses between moths with different numbers and sizes of chromosomes, Federley, and Harrison, and Doncaster have shown that the cell of the hybrid contains half the number of each species, even with their characteristic size differences (Fig. 23). In crosses between different species of fish, where the size differences are quite conspicuous, it has been shown by Moenkhaus, Morris and Pinney (Fig. 24) that the embryonic cells may continue through their divisions to retain the characteristic chromosomes of both species. These hybrid cases are particularly significant; for the chromosomes derived from the father are in the foreign medium of the protoplasm of the other species. Nevertheless, in some cases they retain their own peculiarities, through successive cell generations.

#### EVIDENCE THAT HOMOLOGOUS CHROMOSOMES MATE WITH EACH OTHER

That the mating of the chromosomes in pairs is not a haphazard process, but that each paternal chromosome

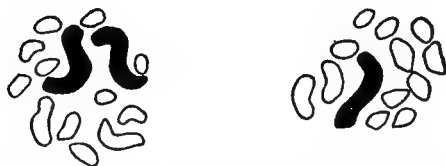

FIG. 25.—Female and male chromosome groups of *Protenor*. (After Wilson.)

mates with a definite maternal chromosome, has been established by evidence from several sources. In many species the chromosomes are of different sizes, and sometimes certain ones are markedly different in size from the others. In the bug *Protenor* the two sex-chromosomes

of the female are conspicuously larger than the others (Fig. 25, a). When reduction takes place the sizes of

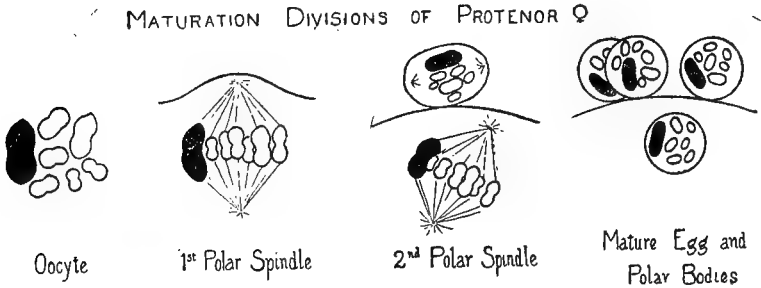

FIG. 26.—Reduced chromosome group; and extrusion of polar bodies in *Protenor*.

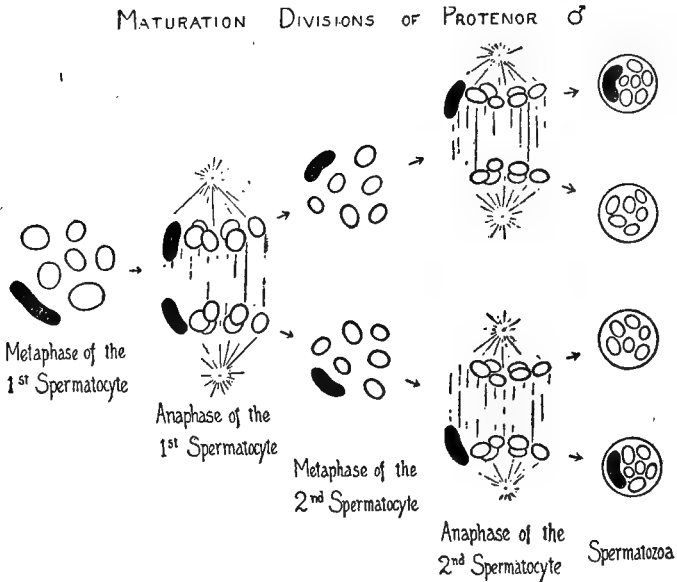

FIG. 27.—Reduced chromosome group of male; and spermatogenesis in *Protenor*.

the fused pairs show that these two large chromosomes must always unite with each other (Fig. 26). In the male of certain species, as in *Protenor* (Fig. 27), the

sex chromosome has no mate, and therefore nothing to fuse with. Its size, after the others have conjugated (Fig. 27) shows that it remains single; while its failure to divide twice, as do the other chromosomes, corroborates the view that having no mate of its own it never combines with any other. At the other extreme, the two very minute chromosomes in several of the *Drosophila* species must have united to form the smallest chromosome of the reduced series (Fig. 28, *a-a'*, *b-b'*). In a few cases the X and the Y are different in size. When they fuse (in the male) the size of the fused mass is what



FIG. 28.—Diploid and haploid chromosome groups of *Drosophila lusckii*, *a*, *a'*, and *D. melanica*, (*neglecta*) *b*, *b'*. (After Metz.)

is expected, viz., the sum of the masses of X and Y, and their subsequent separation into parts corresponding in size to the fused bodies supports the view that conjugation amongst the chromosomes is a very definite process. In the very exceptional case of a bug, *Metapodius*, there is a pair of small chromosomes called *m*'s. When the other pairs enter the spindle the two *m*'s come together, touch, and then separate, to pass to opposite poles.

#### RÉSUMÉ

The evidence from studies of the maturation of eggs and sperm shows that the paternal and maternal chromo-

somes come together at this time in pairs, and subsequently separate, so that each egg comes to contain one or the other member of a pair. The same process takes place in the formation of the sperm-cells. It is obvious that if one member of any pair contains material that produces an effect on some character as one of the end results of its activity, and the other member of the pair contains a different material, the behavior of the chromosomes at the time of maturation supplies exactly the mechanism that Mendel's law of segregation calls for.

## CHAPTER IV

### MENDEL'S SECOND LAW—THE INDEPENDENT ASSORTMENT OF THE GENES

MENDEL proved that when races differ from each other in two pairs of characters, each pair considered by itself alone gives the 3:1 ratio, and the inheritance of one pair is independent of that of the other. If a tall race of peas with colored flowers is crossed to a short race with white flowers the offspring show the two dominant characters, *i.e.*, they are tall and have colored flowers. If these are inbred they produce tall and short offspring ( $F_2$ ) in a ratio of 3:1, and these same individuals, if reclassified for pigment, are colored or white in the ratio of 3:1. For example, the ideal for 12 tall peas would be 9 colored and 3 white; and for 4 short peas there would be 3 colored and 1 white. Expressed in a diagram we have:

12 tall	4 short
9 colored : 3 white	3 colored : 1 white

The preceding way of stating the results deals directly with the facts. The explanation of these results, based on the segregation of the members of the two independent pairs of factors, is as follows: If we call the gene for tallness by the same name as the character itself, *viz.*, tall, and the gene for shortness by the name of this character, *viz.*, short, and similarly for the other pair of characters, *viz.*, color *versus* white, then when crossed the hybrid has two pairs of allelomorphs,

tall	color
short	white

If at the maturation (whether of egg or sperm) tall and color go to one cell, then short and white go to the other cell; but if one of the pairs is turned, so to speak, the other way, thus

$$\begin{array}{cc} \text{short} & \text{color} \\ \hline \text{tall} & \text{white} \end{array}$$

so that short and color go to one cell, then tall and white go to the other. Four classes of germ-cells are expected in  $F_1$ , namely,

tall color, tall white, short color, short white.

Chance meeting of any one of these four kinds of pollen grains with any one of the same four kinds of eggs will give the sixteen recombination classes shown in the following table:

Eggs	tall color	tall white	short color	short white
Sperm tall color	tall color tall color	tall white tall color	short color tall color	short white tall color
tall white	tall color tall white	tall white tall white	short color tall white	short white tall white
short color	tall color short color	tall white short color	short color short color	short white short color
short white	tall color short white	tall white short white	short color short white	short white short white

The four kinds of eggs are written above and the four kinds of sperm are written to the left. There are 16 possible combinations. Since tall and color are dominant the recombinations give: 9 tall color, 3 tall white, 3 short color, 1 short white. In this table the genes have the same name as the character for which they stand, and these names are written out in full, but it is generally more convenient to use symbols for the genes in order

to save space and time. It is customary to represent the members of a pair by the same letter, as Mendel himself did, and to represent the dominant member by the capital letter, the recessive member by a small letter. Thus if  $A$  = tall and  $a$  = short; and  $B$  = color and  $b$  = white, the recombination square becomes:

Eggs	$AB$	$Ab$	$aB$	$ab$
Sperm $AB$	$AB$ $AB$	$Ab$ $AB$	$aB$ $AB$	$ab$ $AB$
$Ab$	$AB$ $Ab$	$Ab$ $Ab$	$aB$ $Ab$	$ab$ $Ab$
$aB$	$AB$ $aB$	$Ab$ $aB$	$aB$ $aB$	$ab$ $aB$
$ab$	$AB$ $ab$	$Ab$ $ab$	$aB$ $ab$	$ab$ $ab$

Instead of using arbitrary letters for the characters as above, it has been found more convenient to use a mnemonic system in which the first letter of one of the members of each pair becomes the symbol. The two members of such a pair are then distinguished from each other by using a capital letter for one and a corresponding small letter for the other. For example, we might let  $t$  = short,  $T$  = tall,  $c$  = white,  $C$  = color. In this case the capital letter represents the dominant character, and the small letter represents the *loss* of that character, as seen in the recessive type. But besides prejudging the question as to what kind of a change took place in the germ-plasm to change a dominant to a recessive by assuming that it is due to a loss, this system is unsatisfactory in cases where many modifications of the same organ exist (such as the 40 eye colors of the vinegar fly),

and where new ones are being found. For example, if the symbol *R* (red) is used for the dominant wild eye color, small *r* would stand for any one of 40 mutant eye colors, and when several of these occur in the same experiment there would be no way of telling for which one the small letter stood. Some other system becomes imperative in such cases,<sup>1</sup> and the most consistent seems to be to use a small letter for the mutant gene in question (or when unknown for the recessive gene), and the corresponding capital letter for its allelomorph (usually the wild type). Thus, *s* = short, *S* = tall, *w* = white, *W* = color. The recombination square for the same characters treated above is then:

Eggs	<i>SW</i>	<i>Sw</i>	<i>sW</i>	<i>sw</i>
Sperm <i>SW</i>	<i>SW</i> <i>SW</i>	<i>Sw</i> <i>SW</i>	<i>sW</i> <i>SW</i>	<i>sw</i> <i>SW</i>
<i>Sw</i>	<i>SW</i> <i>Sw</i>	<i>Sw</i> <i>Sw</i>	<i>sW</i> <i>Sw</i>	<i>sw</i> <i>Sw</i>
<i>sW</i>	<i>SW</i> <i>sW</i>	<i>Sw</i> <i>sW</i>	<i>sW</i> <i>sW</i>	<i>sw</i> <i>sW</i>
<i>sw</i>	<i>SW</i> <i>sw</i>	<i>Sw</i> <i>sw</i>	<i>sW</i> <i>sw</i>	<i>sw</i> <i>sw</i>

Since the large letters simply represent the wild type of each particular character it may sometimes simplify the formulæ to omit them, or since this may lead to confusion in making up pairs of genes, some convention for wild type, such as *N* (normal), *T* (type), or the + sign, or a dash, or a dot may be used. Such short-hand methods are followed by many workers, but it is not necessary to advance the claims of any one of them here. If, for

<sup>1</sup> An even more serious objection to the system is explained in "The Mechanism of Mendelian Heredity," pages 233-235.



example, the normal, meaning the wild type in each factor pair, is represented by *N*, the foregoing table becomes :

Eggs	<i>NN</i>	<i>Nw</i>	<i>sN</i>	<i>sw</i>
Sperm <i>NN</i>	<i>NN</i> <i>NN</i>	<i>Nw</i> <i>NN</i>	<i>sN</i> <i>NN</i>	<i>sw</i> <i>NN</i>
<i>Nw</i>	<i>NN</i> <i>Nw</i>	<i>Nw</i> <i>Nw</i>	<i>sN</i> <i>Nw</i>	<i>sw</i> <i>Nw</i>
<i>sN</i>	<i>NN</i> <i>sN</i>	<i>Nw</i> <i>sN</i>	<i>sN</i> <i>sN</i>	<i>sw</i> <i>sN</i>
<i>sw</i>	<i>NN</i> <i>sw</i>	<i>Nw</i> <i>sw</i>	<i>sN</i> <i>sw</i>	<i>sw</i> <i>sw</i>

In the preceding illustration one grand-parent ( $P_1$ ) was assumed to have had both dominant characters (tall and colored), while the other grand-parent had both recessives (short and white). Obviously the grand-parents might have happened to be made up differently—one might have been tall and white, the other short and colored. The  $F_1$  plants ( $Ss, Ww$ ) would have been the same in either case, and so would the  $F_2$  results. In other words, for the principle of assortment it should make no difference from which parent the characters have come. This is illustrated in the following cross (Fig. 29), in which a wingless vestigial (recessive) *Drosophila* male having the wild-type color (dominant) is bred to long-winged (dominant) female with ebony (recessive) body color. The  $F_1$  flies have long wings and wild type body color. Inbred, they give 9 long wild type color, 3 long ebony, 3 vestigial wild type color, and 1 vestigial ebony. In the diagram the gene for vestigial is represented by *v*, and its allelomorph for long wings by *V*; the gene for ebony by *e*, its allelomorph for wild type color by *E*. The germ-cells of the two  $P_1$  flies are therefore *vE* and *Ve*. Each contains the wild-type allelomorph of the recessive mutant gene in the other parent. The

$F_1$  fly has the formula  $vVeE$ . Independent assortment of the two pairs of factors

$$\frac{v}{V} \frac{E}{e}$$

gives four kinds of germ-cells both in males and females, thus:

$$vE \quad Ve \quad VE \quad ve$$

Any one of the four kinds of egg may be fertilized by any one of the same four kinds of sperm giving the same result as in the case of the peas, viz., four kinds of  $F_2$  individuals in the ratios of 9:3:3:1. In practical tests the occurrence of or the possession of a race with both recessives in it is highly desirable for use in making a back-cross to  $P_1$  (instead of inbreeding  $F_1$ 's), because the numerical results obtained by back-crossing furnish, for a smaller number of individuals, more significant data. For example, if a tall pea with colored flowers is crossed to a short pea with white flowers, and the  $F_1$  individuals ( $SsWw$ ) are back-crossed to short white peas ( $sw$ ), the expected ratio will be 1:1:1:1, because the four kinds of gametes in  $F_1$  ( $SW, Sw, sW, sw$ ) will then reveal themselves in the offspring, since the double recessive individual ( $sw$ ) used for back-crossing (having only recessive gametes) will not "cover up" any of the factors coming from the  $F_1$  hybrid. For instance, as shown in our type example, the  $F_1$  gametes are  $SW, Sw, sW, sw$ . The only kind of gamete produced by the double recessive, short white, is  $sw$ . When this meets each of the above gametes only four kinds of combinations are possible, viz.,  $SWsw, SwsW, sWsw, swsw$ ; and these zygotes, containing only the same dominants as the  $F_1$  gametes, will reveal what the kinds of gametes were. In practice an approximation to a 1:1:1:1 ratio is much more likely to be evident than an approximation to a 9:3:3:1 in which only one double recessive individual out

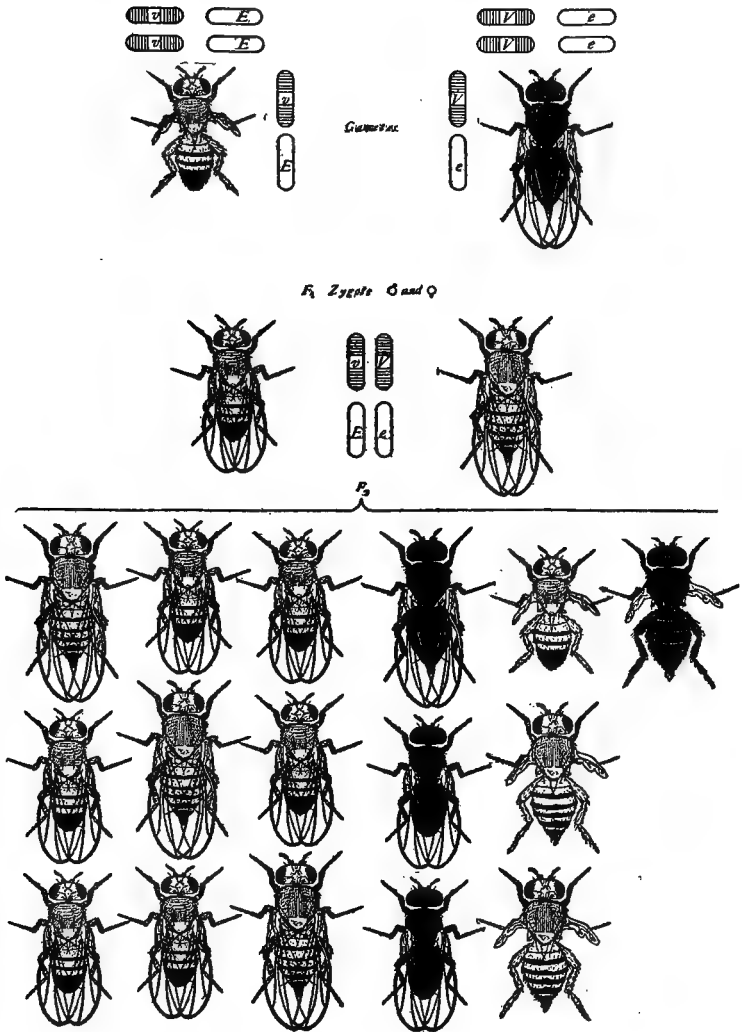

FIG. 29.—Cross between wingless and ebony vinegar fly.

of 16 individuals is expected. Whenever possible, therefore, the back-cross experiment is preferable to the inbred  $F_1$  cross.

In animals and in plants with separate sexes it has been found that both  $F_1$  males and  $F_1$  females give when back-crossed, identically the same results, showing that free assortment takes place in both sexes.

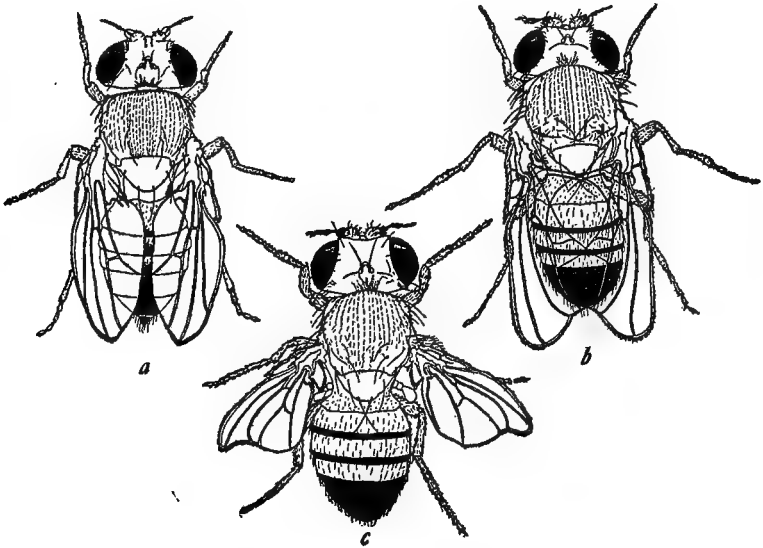

FIG. 30.—Miniature wing, *a*; and dumpy, *b*; and miniature dumpy, *c*.

There is a corollary to the cross involving two pairs of factors that is interesting, because it gives an explanation of the phenomena of atavism. The wild vinegar fly, *Drosophila melanogaster* (Fig. 4), has long wings. It gave rise, through mutation, to a race with miniature (*mm*) wings (Fig. 30, *a*), and also to another race with short wings (Fig. 30, *b*) called “dumpy” (*dd*). If a female miniature (*mmDD*) is crossed to a dumpy male (*MMdd*), all the offspring (*MmDd*) have long wings like

those of the wild fly. The miniature fly carries the dominant ( $DD$ ) wild-type allelomorph of the dumpy gene, and the dumpy carries the dominant ( $MM$ ) wild-type allelomorph of the miniature gene. Since the hybrid contains the two wild-type genes ( $DM$ ) it "reverts" to the long-winged fly. The proof that two pairs of factors are involved is found by inbreeding an  $F_1$  male and female, which give 9 long, 3 miniature, 3 dumpy, and 1 miniature dumpy (Fig. 30, *c*) fly.

There are certain modifications of the two-pair ratio that arise sometimes when different factors produce a like effect on the same organ. Such cases have sometimes been treated as special cases, and rather peculiar interpretations given to them on the basis that the situation is unusual. In reality they are only interesting cases of Mendelian behavior, the results obscured to some degree by superficial character relations. The absence of color, albinism, is, perhaps, the most familiar example of this sort. There are certain recessive factors that when homozygous interfere in some unknown way with the development of color. Albinos of the ordinary house mouse are white because they are homozygous for the albino factor, although they may be pure for all other factors that are essential for color. If a certain kind of albino mouse is crossed to a pure black mouse the offspring will be gray because black ( $bb$ ), being recessive to its wild-type allelomorph ( $BB$ ), brought in by the albino, disappears; and white ( $ww$ ) being recessive to its wild type allelomorph for color ( $WW$ ), brought in by the black, also disappears, so that the color of the resulting animal, gray, is due to the hybrid having recovered all the factors that give this color. The two factor-pairs involved are black ( $b$ ) and its normal allelomorph ( $B$  = gray), and white ( $w$ ) and its normal allelomorph ( $W$  = color). The  $F_2$  results, put into the recombination square, are as follows:

		Eggs			
		<i>BW</i>	<i>Bw</i>	<i>bW</i>	<i>bw</i>
Sperm	<i>BW</i>	<i>BW</i> <i>BW</i> gray	<i>Bw</i> <i>BW</i> gray	<i>bW</i> <i>BW</i> gray	<i>bw</i> <i>BW</i> gray
	<i>Bw</i>	<i>BW</i> <i>Bw</i> gray	<i>Bw</i> <i>Bw</i> white	<i>bW</i> <i>Bw</i> gray	<i>bw</i> <i>Bw</i> white
	<i>bW</i>	<i>BW</i> <i>bW</i> gray	<i>Bw</i> <i>bW</i> gray	<i>bW</i> <i>bW</i> black	<i>bw</i> <i>bW</i> black
	<i>bw</i>	<i>BW</i> <i>bw</i> gray	<i>Bw</i> <i>bw</i> white	<i>bW</i> <i>bw</i> black	<i>bw</i> <i>bw</i> white

The resulting ratio is 9 grays, 3 blacks, and 4 whites. The last two terms of the 9 : 3 : 3 : 1 ratio are here united in one class (4 whites) because when homozygous for absence of color the individual is white, regardless as to whether the other color-producing factors make for the wild type of coloration or for some mutant color.

Another interesting two-pair case involves varieties of the combs of domesticated breeds of fowls. There is a dominant type called "Rose" (Fig. 31, *c*), which, bred to single (wild type, Fig. 31, *a*), gives Rose in  $F_1$ , and 3 Rose to 1 Single in  $F_2$ . Another dominant type called "Pea" (Fig. 31, *b*) likewise gives Pea in  $F_1$  and 3 Peas to 1 Single Comb in  $F_2$ . But when Rose is bred to Pea there is not produced the wild type, as one might have anticipated, but a comb called "Walnut" (Fig. 31, *d*), that differs from both parental types. The character is due to the combined action of both dominants. If two  $F_1$  birds with Walnut combs are bred to each other they give 9 Walnut, 3 Pea, 3 Rose, 1 Single comb. This ratio shows that two factors are involved, and that the Walnut comb appears in all birds carrying both the Rose and the Pea genes. The Single comb is the double recessive form.

If the single comb be supposed to be the wild type, then Pea and Rose represent dominant mutant types.

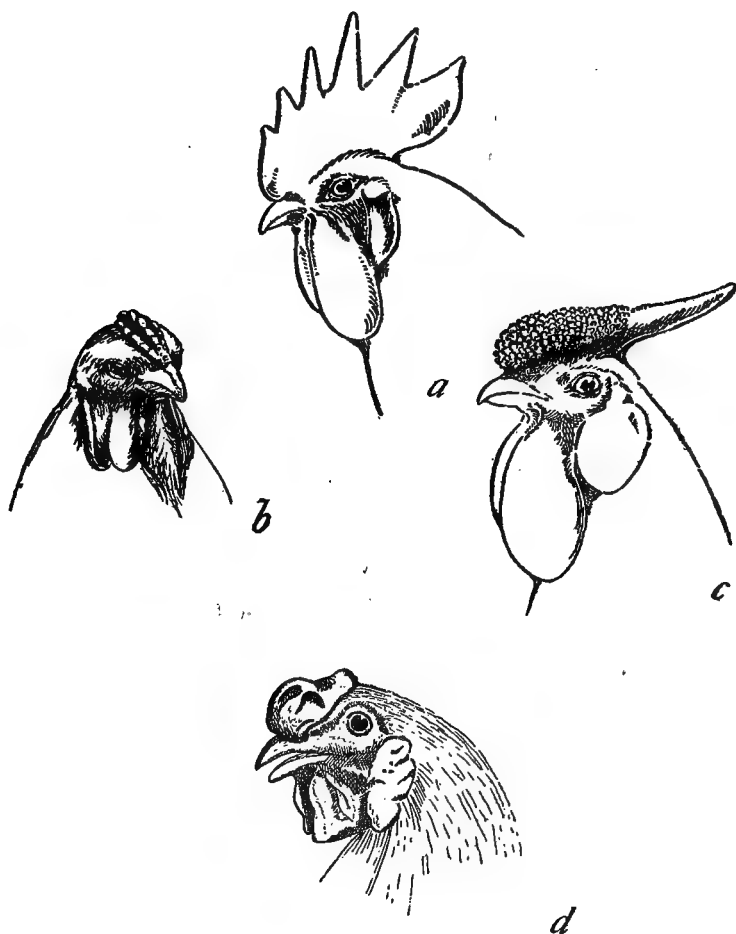

FIG. 31.—Combs of fowls, single, *a*; rose, *b*; pea, *c*; and walnut, *d*.

Neither produces any single comb, if the races are homozygous for Pea or for Rose respectively, but when crossed, the Pea comb brings in the normal recessive allelomorph

of Rose, and the Rose comb the normal recessive allelomorph of Pea: but the result is not an atavistic normal comb, but a Walnut produced by the action of both dominants that are here the mutant characters.

An important class of factors that are known as diluters or intensifiers are often met with in genetic work. For instance, a black mouse pure for a certain "diluting" factor has a "blue" color (just as a black mouse pure for albino factors is white). Such a blue mouse crossed to black gives  $F_1$  black mice, and in  $F_2$  three blacks to one blue. A two-factor cross results when a blue mouse is bred to a "chocolate" (=black cinnamon) mouse. The  $F_1$  will be black, the  $F_2$  will be 9 black, 3 blue, 3 chocolate, 1 "silver-fawn" (dilute black cinnamon). In this case, the same factor that changes black to blue also changes chocolate to silver-fawn. If the diluter had been a specific one affecting black only, then  $F_2$  from the above cross would have been 9 black, 3 blue, 4 chocolate. Such a case is found in the vinegar fly, in which the diluter affects only a recessive factor—eosin. This specific diluter for eosin is called "whiting." It gives the following results: A red-eyed female homozygous for whiting is indistinguishable from the ordinary wild type. If a female of this kind is crossed to an eosin male the offspring ( $F_1$ ) are red eyed. If they are inbred they give 12 red-eyed flies, 3 eosin, 1 eosin-whiting which is colorless.

Another modification of the 9:3:3:1 ratio appears when the last three classes are superficially alike. For example, Bateson and Punnett crossed two white flowering varieties of sweet peas. The  $F_1$  had purple flowers, which, inbred, gave 9 purple and 7 whites. Here there are two different recessive factors which in homozygous condition give white,  $ww$  and  $aa$ ; each has a normal dominant allelomorph in the other white,  $AA$  and  $WW$ . The two white parents are then  $wwAA$  and  $aaWW$ . The  $F_1$  individuals



are  $WwAa$ , and the four gametes are  $WA$ ,  $Wa$ ,  $wA$ ,  $wa$ . The table below gives the sixteen recombinations of these gametes:

Eggs	$WA$	$Wa$	$wA$	$wa$
Sperm $WA$	$WA$ $WA$ purple	$Wa$ $WA$ purple	$wA$ $WA$ purple	$wa$ $WA$ purple
$Wa$	$WA$ $Wa$ purple	$Wa$ $Wa$ white	$wA$ $Wa$ purple	$wa$ $Wa$ white
$wA$	$WA$ $wA$ purple	$Wa$ $wA$ purple	$wA$ $wA$ white	$wa$ $wA$ white
$wa$	$WA$ $wa$ purple	$Wa$ $wa$ white	$wA$ $wa$ white	$wa$ $wa$ white

Any individual that has both recessives  $ww$  or  $aa$  is white. There are 7 such classes to 9 that carry both  $A$  and  $W$ . Lastly, a 15:1 modification of the 9:3:3:1 ratio is obtained when an individual homozygous for both pairs of recessive genes gives a different result from any other combination. Thus, Shull found when *Bursa pastoris*, with triangular capsules, is crossed to one with round capsules, the latter appears in  $F_2$  only once in 16 times.

ASSORTMENT OF THREE FACTORS

When three independent factor-pairs are present the numerical expectation can be directly derived from the 9:3:3:1 ratio in the same way that the latter was derived from the 3:1 ratio. Thus:

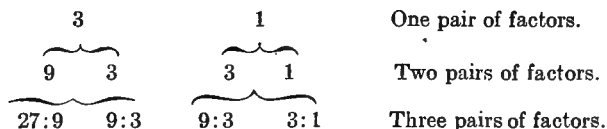

Each  $F_2$  class of the two-factor case (9:3:3:1) will contain a three-to-one ratio for the third factor-pair. Thus, in the 9 class there will be 3 dominants of the third factor to one recessive (27:9). So for each 3 class: each contains the third factor in the ratio of 3:1. So also for the 1 class. The total result therefore is:

$$27:9:9:9:3:3:3:1$$

In actual practice the three-factor cases are almost never used. Other methods are employed to detect the factors present, so that these three-factor ratios have a theoretical rather than a practical value. In cases where multiple factors are suspected, some of them may be only modifiers of some one of the other more conspicuous characters and in such cases special methods of procedure will recommend themselves.

## CHAPTER V

### THE MECHANISM OF ASSORTMENT

EACH pair of chromosomes, just before the reduction division, consists of a maternal and a paternal member. As the members of each pair are in nearly all cases identical in appearance, it is not possible to tell how they place themselves on the mitotic spindle with respect to their parental origin; that is, it is not possible to tell by inspection whether at the maturation division all those of maternal origin pass to one pole of the spindle, and all those of paternal origin to the other, or whether the pairs come to lie haphazard on the spindle, so that it is merely a matter of chance whether a maternal or a paternal member passes to a particular pole. For the utilization of the chromosomal mechanism for the theory of assortment, it is a matter of great importance which of the preceding alternatives is followed, for if all of the maternal chromosomes should go to one pole, and all the paternal to the other, there would be no free assortment of the chromosomes, and no free assortment of the genes if these are carried by the chromosomes. Without random assortment there could only be two kinds of gametes produced by the hybrid, hence only three types possible in  $F_2$ , viz., the two grandparental types and the hybrid type.

On the other hand, if the assortment of chromosomes is a random one, then the reduction division furnishes the mechanism that Mendel's law calls for in so far as the character-pairs lie in different chromosome pairs.

There is not a single cytological fact opposed to the view of free assortment of maternal and paternal chromosomes; on the contrary, there is a general expectation that the chromosomes should assort freely; and what is more to the point, there are a few crucial cases that show that free assortment takes place. Let us turn to these

cases. The most convincing evidence is that furnished by Miss Carothers (1913) from some grasshoppers of the genus *Brachystola*. Here, in addition to the single sex-chromosome (in the male), that goes to one pole of the first maturation spindle, there is also present another pair of chromosomes that are unequal. In some cells the smaller member of the pair goes to the same pole as the sex-chromosome, in other cells it goes to the opposite pole. The assortment of the unequal pair as regards the sex-chromosome is therefore a random one. Thus, in three hundred first spermatocytes, the smaller partner went to the same pole as the sex-chromosome in 48.7 per cent. of cases, and into the cell without the sex-chromosome in 51.3 per cent. Voinov ('14), Wenrich ('14) and Robertson ('15) have reported similar cases.

Other evidence of a different kind has more recently ('17) been described by Miss Carothers. The evidence rests on the constancy of attachment of the fibres of the mitotic figure to a definite point of the chromosome, as seen when the chromosomes are moving towards the poles of the spindle. In one of the cases she describes there are two kinds of attachments, *viz.*, *terminal*, when the fibre is attached at the end of the rod-shaped chromosome, and *subterminal* when the fibre is attached some distance from the end. In the latter case the end bends over, making the chromosome J-shaped. There are certain individuals in which one member of a pair of chromosomes may have a terminally attached fibre, and its mate have a subterminally attached fibre. Throughout all the cell-divisions of such an individual these two chromosomes show this difference. During maturation, *i.e.*, after conjugation of the chromosomes, one member of this pair passes to the pole of the spindle with a terminal attachment, and its mate with a subterminal to the other pole. In the male, the single sex-chromosome passes to one or to the other pole at one spermatocyte division. Its relation to the two members of the pair of chromosomes in question will show

whether random assortment or correlated movement takes place. Observation shows that sometimes one, sometimes the other, member of the pair goes to the same pole as the sex-chromosomes.

It happens that in a species studied by Miss Carothers (*Trimerotropis suffusa*) there are several chromosomes that may show constantly terminal or subterminal attachment of the fibres; as many as seven out of the twelve chromosomes of the first spermatocyte division may consistently show this difference. In other words, any one of these seven chromosomes may have one or the other kind of attachment. Each grasshopper may have any one of ten of its pairs showing combinations of these kinds of attachment, but of course in any one individual only two possible arrangements exist for a given pair of chromosomes. It is to be remembered that for a given combination all the cells of an individual are exactly alike, which incidentally is a strong argument in favor of the individuality of the chromosomes. An example will give further details. In Fig. 32 are shown eight groups of chromosomes (*b, c, d, e, f, g, h, j*) from the same individual. Each group of 12 chromosomes comes from a single cell about to divide. Each series of 12 is here arranged in a single horizontal line. The dividing chromosome is a tetrad, one of whose halves is about to separate. It is significant to note that in this case the separating halves represent the two conjugating members of each pair; in other words, the *reduction* division is taking place. In this individual, four of the tetrads (9-12) has subterminal attachment only, *i.e.*, for both members of the dividing pair (dyad); four of the tetrads (Nos. 2, 3, 5 and 6) have terminal attachments only, while the remaining three tetrads (Nos. 1, 7 and 8) have one end with a terminal attachment, and the other subterminal. In addition there is the sex-chromosome (No. 4) that is here going upwards toward the top of the figure, and will pass with the upper half of each tetrad into an imaginary cell above (the female-

producing sperm). The first double chromosome (No. 1) has a different mode of fibre attachment to each half, but the halves are here not different in size. In five cases the chromosome with terminal attachment is going to the cell that will get the sex-chromosome (the upper one here), while in three cases it goes to the pole that will not get the sex-chromosome. Chromosomes 7 and 8 are slightly different in size, but this is not distinguishable in these figures. In the first four cells (*viz.*, *b, c, d, e*) the halves of 7 and 8 with subterminal attachments are going to opposite poles; in the remaining four cells (*f, g, h, i*) they are going to the same pole. Again, if we compare Nos. 7 and 8 with No. 1 it is found that in four cells (*f, g, h, i*) the half with terminal attachment passes into the cell with the same attachment (*f* and *i*) (for 7 and 8), and the other half into the cell with the other attachment (*g* and *h*). In other words, the distribution for four chromosomes pairs (1, 4, 7, 8) is here a random assortment. Let *A, B, C* represent the chromosomes with one kind of attachment, and *a, b, c* their mates with the other kind of attachment. *D* is the sex-chromosome and *d* its absence. There will then be sixteen possible assortments of these four, all equally probable. Thus:

<i>ABCD</i>	<i>aBCD</i>	<i>abCD</i>	<i>abcd</i>	<i>abcd</i>
	<i>AbCD</i>	<i>AbcD</i>	<i>abCd</i>	
	<i>ABcD</i>	<i>ABcd</i>	<i>aBcd</i>	
	<i>ABCd</i>	<i>aBcD</i>	<i>Abcd</i>	
		<i>aBCd</i>		
		<i>AbCd</i>		

There were 100 spermatocytes recorded by Miss Carothers as to the distribution of their chromosomes to the two poles, giving data for 200 cells. Their distribution as well as the expectation for free assortment is as follows:

	Expected	Realized
Only one chromosome with sub-terminal attachment. $\frac{1}{4} \times 200 = 50$	50	48
Any two chromosomes with sub-terminal attachment. $\frac{3}{8} \times 200 = 75$	75	84
Any three chromosomes with sub-terminal attachment. $\frac{1}{4} \times 200 = 50$	50	48
Any four chromosomes with sub-terminal attachment. $\frac{1}{16} \times 200 = 12\frac{1}{2}$	$12\frac{1}{2}$	8

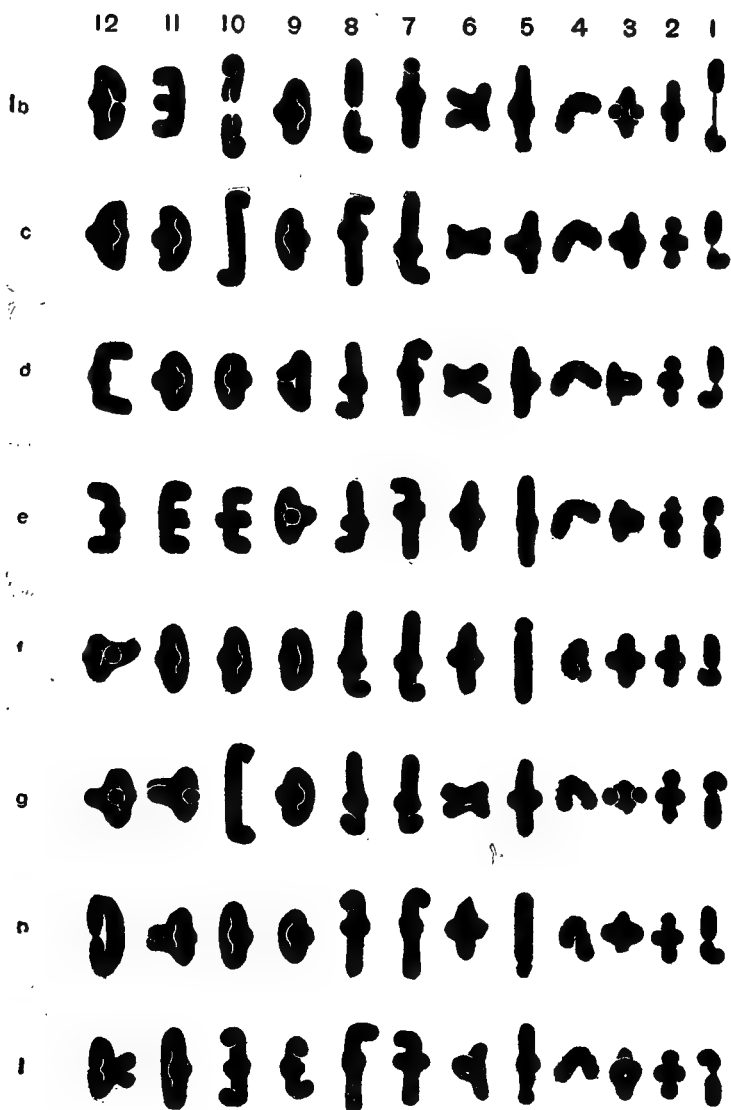

FIG. 32.—Eight chromosome groups of twelve chromosomes each of *Trimerotropis*. (After Carothers.)

For a count of only 100 cells the agreement with expectation is sufficiently close to show that independent assortment takes place.

In addition to the differences of attachment just examined there are other differences that Miss Carothers has studied. A constriction is found in certain chromosomes in some individuals (Fig. 32, No. 5) that is absent in other individuals. In some individuals the tetrad is separating so that the group looks like four beads in a line. In other cases one member of the pair is not constricted, while its mate is constricted. Similarly for another chromosome. In one individual both halves of the dyad show a constriction, while another individual has one smooth and one constricted half. These same two kinds of chromosomes also have in some cases terminal attachment, and in other cases subterminal, making possible further combinations that can be identified.

Finally, there are two types of subterminal attachment in two chromosomes of the series. In one type the chromosome is bent further from the end than in the other. Either of these two types may have a mate of the other type with terminal attachment, thus giving several further identifiable combinations. "All possible combinations of the dyads in these two types of heteromorphic tetrads occur and segregate [assort] freely in relation to sex." Miss Carothers points out that when three types of the same chromosome exist "we have a visible mechanism whose behavior in the maturation divisions corresponds to the segregation of triple allelomorphs."

In addition to the 12 ordinary chromosomes certain individuals may have a small thirteenth or even a fourteenth chromosome. These are called supernumeraries. In *Circotettix* they were found present in two of eleven individuals examined. If present, it, or they, are constant for all cells except that at the reduction division there may be a new distribution. If one is present it may go to either pole with reference to the sex-chromosome, and at



the second spermatocyte division it divides as do the others at this time in the cell that contains it. If two are present they do not behave as mates, but at the first spermatocyte division may both go to the same pole (which may be either pole in reference to the sex-chromosome), or they may go to opposite poles. At the second spermatocyte division each divides independently, and halves go to opposite poles. These bodies then also move to either pole without respect to other chromosomes—or at least without respect to the sex-chromosomes; but this behavior can scarcely be used to advantage for the question of assortment because these chromosomes have no mates (in the cases so far described) and are so inconstant in their occurrence that an appeal to their behavior as bearing on the other chromosomes might not be conceded. If they are pieces of other chromosomes (the bent ends, for example) that have been broken off, we might expect them to show some relation during synapsis to the original chromosome from which they came, but as yet nothing of the sort has been described. If they carry factors that influence the characters of the individual, their presence, especially when two occur, would give rise to unexpected genetic results.

The evidence furnished by cytology that has just been given makes clear that whenever an opportunity has been found to study the mode of assortment of the chromosomes the result shows random distribution. If then the chromosomes carry the genes for the hereditary characters, we should expect that the genes in different chromosome pairs will "assort" independently, and this, in fact, is what Mendel's second law postulates.

## CHAPTER VI

### LINKAGE

MENDEL'S results involving two or more pairs of characters led to the conclusion that distribution of the members of one pair of genes is independent of the distribution of the members of other pairs. This process may be called free or independent assortment, and is what is expected if each pair of genes is carried by a different pair of chromosomes. If this rule held for all pairs of characters then there could be no more pairs that assorted independently than there were pairs of homologous chromosomes. On the other hand, if the chromosomes carry the genes we should anticipate from what we have found out concerning the individuality of the chromosome, and from what we know concerning the large number of inherited characters, that many of these factors must be carried in the same chromosome. If this is true, then Mendel's second law can have only a very limited application.

As our information about the mode of inheritance of characters has widened, the number of cases in which free assortment does not occur has steadily increased. Many characters have been found to keep together in successive generations. This tendency to keep together rather than to assort freely is called linkage. The most extreme cases are those where characters hold together completely; at the other extreme are those that show only a slightly greater probability of holding together than of assorting freely. Between these extremes all intermediate degrees of linkage are found. For the sake of simplicity, cases of complete linkage will be dealt with in this chapter; the others will be taken up in the next chapter.

If a fly (*Drosophila*) with two recessive mutant charac-

ters, black body color and vestigial wings (Fig. 33), is mated to a fly with wild-type body color and long wings, the offspring ( $F_1$ ) are wild type. If one of the  $F_1$  sons is back-crossed to a black vestigial female from stock,

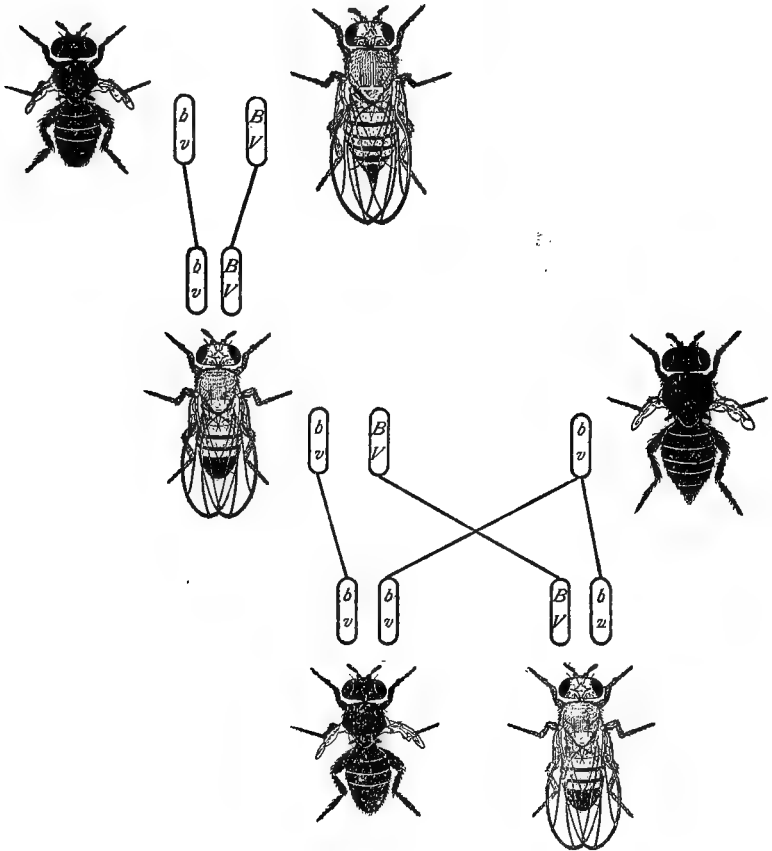

FIG. 33.—Back-cross of  $F_1$  male (out of black vestigial by wild), to black vestigial.

the offspring ( $F_2$ ) are of two kinds only, half are black vestigial, and the other half are wild type. In other words, the two mutant characters that went in together, black and vestigial, have come out together; and their two

normal allelomorph characters, wild-type body color and long wings, have also come out together. There are no  $F_2$  flies that are black and long, and none that are vestigial and gray, as would be the case if independent assortment took place.

In the diagram (Fig. 33) the results are worked out on the chromosome theory. The genes for black ( $b$ ) and for vestigial ( $v$ ) are represented as carried by the same chromosome ( $bv$ ); the homologous chromosome of the wild-type fly carries the normal allelomorph genes ( $BV$ ). In  $F_1$ , one of each of these two chromosomes is present, and the fly is normal because the two normal allelomorphs are dominant. In the  $F_1$  male these two chromosomes ( $bv$  and  $BV$ ) separate at the reduction division of the germ-cells, one going to each gamete. If this  $F_1$  male is mated to a black vestigial female, all of whose eggs carry genes for black and for vestigial, the offspring should reveal the composition of the gametes of the  $F_1$  male, since the eggs of the black vestigial fly, containing only two recessive factors, will not cover up the effects of the factors contained in the gametes of the  $F_1$  male.

Unless we knew that the two characters black and vestigial are distinct mutant characters, the preceding experiment would not necessarily show that the characters are linked, because the same result would have followed if black and vestigial were both due to the effect of a single gene. Other experiments, however, show that they are independent characters.

It is interesting to compare the preceding cross with another in which black comes in from one parent, and vestigial from the other. For instance, if a black fly with long wings is crossed to a wild-type fly with vestigial wings (Fig. 34), the  $F_1$  offspring will be wild type both in their color and in their wings, because the black fly brings in the normal allelomorph of vestigial, and the vestigial fly brings in the normal allelomorph of black. If the  $F_1$  sons are back-crossed to black vestigial females, the off-

spring are of two kinds only, namely, black long, and wild-type color vestigial. The combinations that went into the cross together have come out together. The diagram,

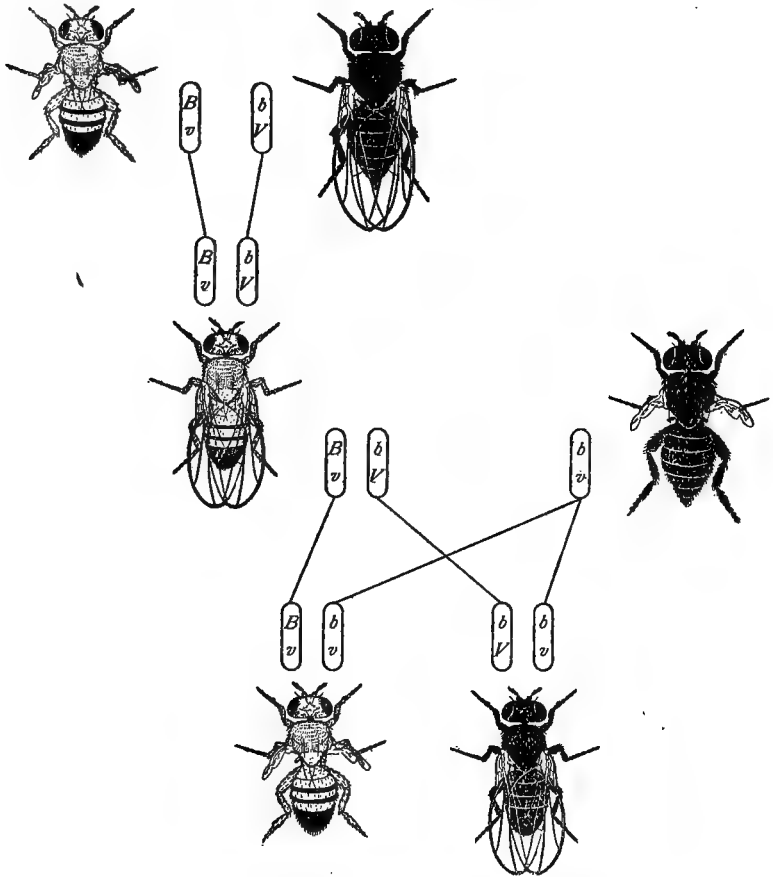

FIG. 34.—Back-cross of  $F_1$  male (out of gray vestigial by black) to black vestigial.

based on the chromosomes, shows that the genetic results, as before, follow the chromosome behavior, provided there has been no interchange of genes in the male.

For the sake of simplicity only two linked factors were

utilized in the preceding cases. Three, four, five, or, theoretically, any number of characters may show this relation to each other. Thus there is a stock of *Drosophila* with five linked mutant characters, namely, black, purple, curved, plexus, speck. In a back-cross, like the one above, all the mutant characters, if they went in together, will come out together in half of the second generation (back-cross) flies, and their wild type allelomorphic characters in the other half.

There is another way in which linkage may be very simply illustrated. There are certain characters, called

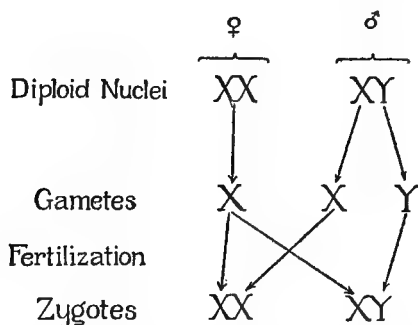

FIG. 35.—Scheme showing the inheritance of the sex-chromosome in *Drosophila*.

sex-linked characters, because their factors follow the sex-chromosomes, or may be said to be carried by them or to be in them. Now in *Drosophila*, the female has two X-chromosomes (Fig. 35), the male one X (and a Y). After reduction the eggs have each one X chromosome. Any such egg fertilized by a Y-bearing sperm will produce a male (XY), as shown in the scheme below. The single X-chromosome that this male gets is therefore from his mother. If her X-chromosome carried sex-linked factors, these should be present in the son. Such, in fact, is the case. For example, a female *Drosophila* with yellow wings and white eyes mated to a wild-type male will produce wild-type females, and yellow white-eyed sons (like the

mother). Here the son gets his sex-linked characters from his mother, since his only  $X$  is derived from her. Experiments have shown that this holds for any number of sex-linked characters that are present in the mother.\*

Linkage has been demonstrated in a number of animals and plants. The first case discovered was in sweet peas. Bateson and Punnett (1905) found that when purple flowers and long pollen grains went in from one parent, and red flowers and round pollen went in from the other parent, they tended to come out together more frequently than would be expected on the two-factor ratio, 9:3:3:1. In the case of these sweet peas the linkage is not complete, apparently not in either sex. At present two different linkage groups are known in sweet peas, one made up of three linked characters, and the other of three, possibly four. In the edible or garden pea there are two linked characters, and two that are doubtful (Bateson and Vilmorin, White). Mendel did not happen to make any combinations of linked characters in this form, hence he got free assortment. In the primrose (*P. sinensis*) there is a group of five linked characters (Gregory, Altenburg); in the snapdragon a group of five (Baur); in stocks a group of three or four (Saunders). In the groundsel (*Senecio vulgaris*) there are two linked characters known; other cases occur in corn (Lindstrom), tomatoes (Jones), wheat (Engledow), oats (Surface), *oenothera* (DeVries, Muller). In animals the largest number of linked characters is found in the vinegar fly, *Drosophila melanogaster*, in which there are four groups—a sex-linked group containing about 100 characters, a second group containing 75 characters, and a third group containing about 60 characters, and a fourth group of two characters. In other species of *Drosophila*, linked characters (other than sex-linked) are beginning to be reported as more characters are studied (Metz in *D. virilis*, Warren

---

\* A reservation for crossing over in a heterozygous mother must be added to this statement.

in *D. busckii*, Sturtevant in *D. repleta*). Nabours has found a case in one of the grouse locusts, and Castle and Wright in rats. In the silk-worm moth, Tanaka has found one group of linked characters. In poultry Goodale has found one case. In the moths and poultry it appears that linkage is complete in the female, incomplete in the male. In this respect the situation is the reverse of that in *Drosophila*. There are some other cases where linkage is suspected but uncertain.

The fact that relatively so few cases of linkage have been as yet reported is due in part to the fact that in most species the heredity of only a very few characters is generally known. Where more are known each has as a rule not been examined in relation to all the others, so that even if some of the factors were linked it would not have been found out. Furthermore, in Mendelian crosses, the practice of mating  $F_1$ 's instead of back-crossing, tends to conceal the linkage phenomena if present. The fact of greatest significance, however, is that the number of cases of linkage is steadily increasing as the inheritance of more characters in each species is becoming known.



## CHAPTER VII

### CROSSING OVER

THE correlative aspect of linkage is crossing over, and inasmuch as it involves a change in the mechanism that gives linkage, it is entitled to rank as one of the fundamental principles of heredity.

In the illustration of complete linkage given in the preceding chapter, the cases chosen were ones in which entire chains of genes remained intact during the reduction divisions. The male of *Drosophila* exhibits this phenomenon, as does also the female of the silk-worm moth. On the other hand, there is an interchange of blocks of genes between homologous pairs of chromosomes in other cases, as in the females of *Drosophila*, in the males of moths and fowls, and in both egg-cells and sperm-cells of the plant *Primula*.<sup>1</sup> This interchange is called crossing over, and the evidence shows that it is not haphazard, but gives numerical results of extraordinary constancy. A few examples will suffice to illustrate crossing over.

When a black fly with vestigial wings is crossed to a wild-type ("gray") fly with long wings (Fig. 33) the offspring are, as we have already seen, "gray," long. If one of the  $F_1$  females is back-crossed to a black vestigial male there are four kinds of offspring produced, *viz.*, the two original combinations, black vestigial, and gray long; and in addition two recombinations of these, *viz.*, black long, and gray vestigial. The two latter classes are called the crossover classes, or more briefly, crossovers. The percentage of crossovers is definite for a given stock,

---

<sup>1</sup> Crossing over in both sexes in the rat has been reported by Castle and Wright, and in the male and female grasshopper by Nabours.

of a given age and under given environmental conditions. In this case the percentages are as follows:

Non-crossovers		Crossovers	
Black vestigial 41.5 per cent	Gray long 41.5 per cent	Black long 8.5 per cent	Gray vestigial 8.5 per cent
83 per cent		17 per cent	

If a pair of chromosomes in the  $F_1$  fly is represented as carrying the genes of the characters here involved, one member of such a pair carries both a gene for black and a gene for vestigial (Fig. 36); the homologous member of the pair of chromosomes carries both of the normal allelomorphs, *viz.*, a gene for gray and a gene for long wings. When crossing over takes place so that a gene for black goes over into the other chromosome, the converse phenomenon takes place, a gene for gray goes over into the chromosome that gave up its black gene. It is the constancy of this interchange that makes the phenomenon reducible to exact mechanical treatment.

The interchange is independent of the way in which the genes enter the cross. For example, if a black long-winged fly is crossed to a gray vestigial fly (Fig. 37), the  $F_1$  offspring will be, as before, gray long. If an  $F_1$  female (gray long) is back-crossed to a black vestigial male, there will be four kinds of offspring, namely, the two original combinations black long, and gray vestigial; and the two crossover combinations, black vestigial, and gray long, in the following proportions:

Non-crossovers		Crossovers	
Black long 41.5 per cent	Gray vestigial 41.5 per cent.	Black vestigial 8.5 per cent	Gray long 8.5 per cent
83 per cent		17 per cent	

The interchange in the last cases is in the reverse order of that in the first case, but it is numerically identical. In other words, it makes no difference whether the gene for black and for vestigial enter the cross together, *i.e.*,

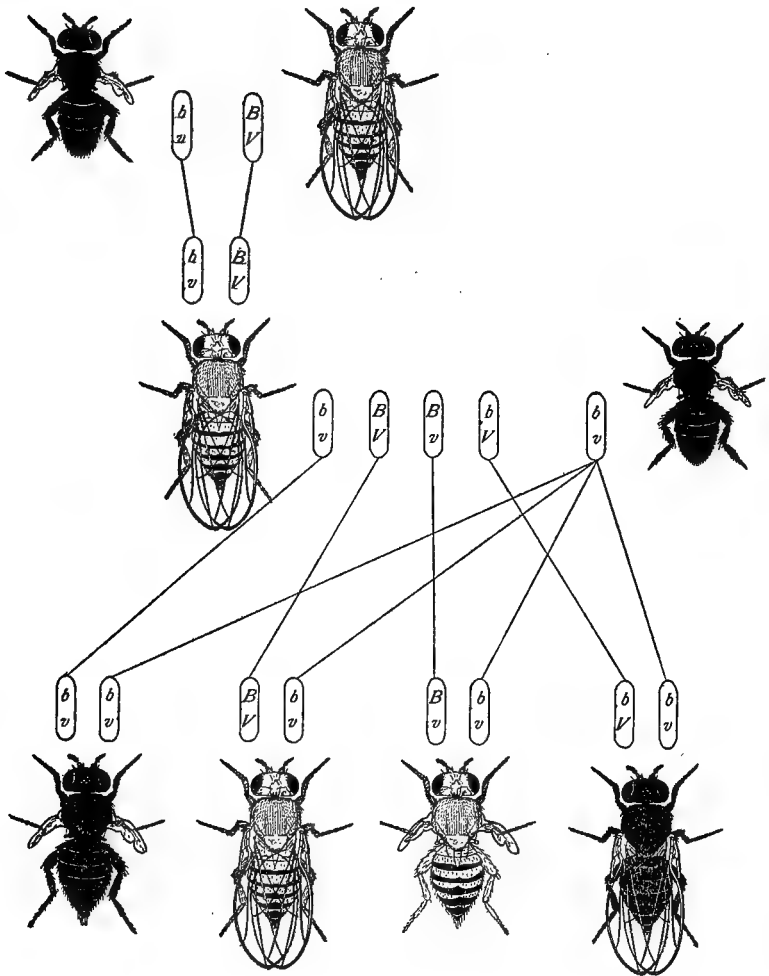

FIG. 36.—Back-cross of  $F_1$  female (out of black vestigial by wild) to black vestigial male.

in the same chromosome, or whether they enter the cross in opposite chromosomes—their likelihood of interchange is exactly the same. If the  $F_1$  male had been back-crossed (Fig. 34) only two kinds of offspring would have been

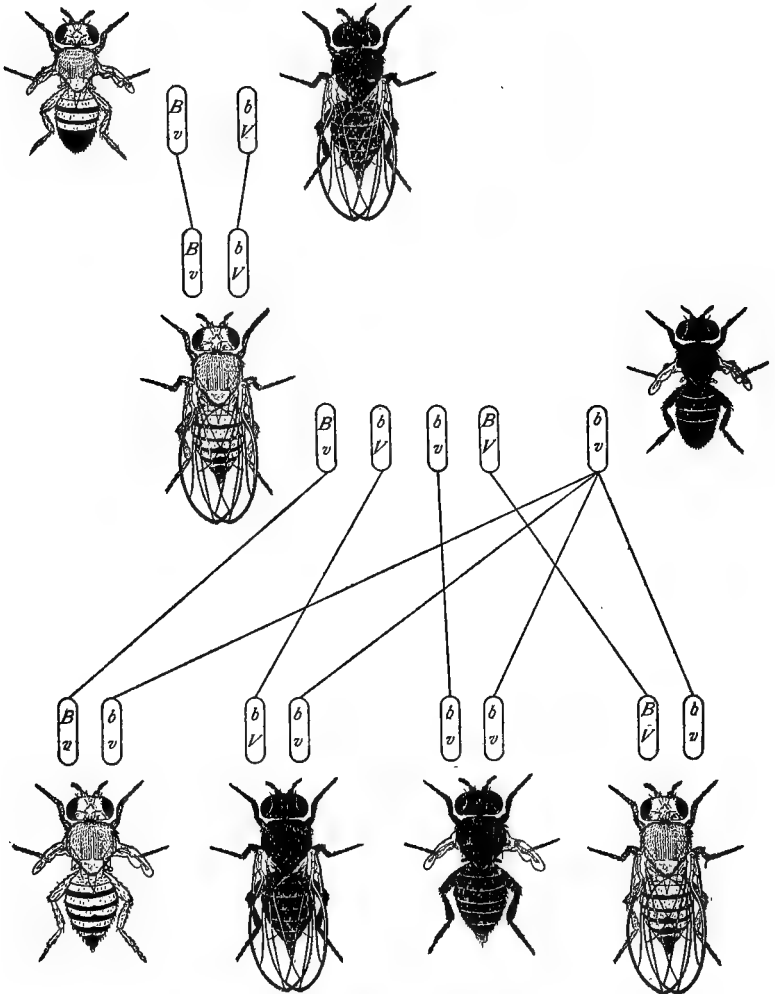

FIG. 37.—Back-cross of  $F_2$  female (out of gray vestigial by black) to black vestigial male.

produced because, as was shown, there is no crossing over in the male.

It should be pointed out here, that the interchange (or crossing over) can of course only be recorded when two

or more pairs are involved, for, obviously, unless a character that enters the cross comes in with some other known one that is recognizable as such, there is no way of determining whether interchange between the homologous chromosomes has taken place. As will be pointed out later, there is every reason to suppose, and practically a demonstration of the fact, that the interchange goes on irrespective of the presence of other genes by which it can be observed.

Experiments with different pairs of characters show that for each two pairs there is a definite numerical ratio. For instance, if a female fly with yellow wings and white eyes is crossed to a fly with gray wings and red eyes (wild type) the daughters will have gray wings and red eyes (wild type). If the  $F_1$  female is back-crossed to a male with yellow wings and white eyes, four classes of offspring will be produced in the following proportions:

Non-crossovers		Crossovers	
Yellow white	Gray red	Yellow red	Gray white
49.5 per cent	49.5 per cent	0.5 per cent	0.5 per cent
99 per cent		1 per cent	

Here, crossing over takes place in only one case out of a hundred. If the characters enter in a different combination, *viz.*, yellow red and gray white, the crossover percentage is the same as before, *viz.*,

Non-crossovers		Crossovers	
Yellow red	Gray white	Yellow white	Gray red
49.5 per cent	49.5 per cent	0.5 per cent	0.5 per cent
99 per cent		1 per cent	

Another combination of white eyes with a different character shows a different linkage. If a female fly with white eyes and miniature wings is crossed to a male with red eyes and long wings (wild type), the  $F_1$  daughters will have red eyes and long wings. If one of these  $F_1$  females

is back-crossed to a white miniature male the four classes of offspring appear in the following proportions:

Non-crossovers		Crossovers	
White miniature 33.5 per cent	Red long 33.5 per cent	White long 16.5 per cent	Red miniature 16.5 per cent
67 per cent		33 per cent	

Here crossing over takes place in 33 out of 100 flies, whereas in the former crosses between white eyes and another mutant character (yellow) crossing over took place only once in a hundred times. Based on these numerically different ratios of crossing over, and on other related phenomena, a theory of crossing over has been formulated that will be discussed later. For the present we are concerned only with the data.

When more than two pairs of characters are involved new phenomena of crossing over make themselves evident. Some of these are more related to principles that are discussed in later chapters, but a few results may be pointed out here. When, for example, three pairs are involved, two may cross over, while the third does not. A female with white eye color, miniature wings, and forked bristles crossed to a wild-type male gives wild type in  $F_1$ . An  $F_1$  daughter back-crossed to a white miniature forked male will give, in the next generation, not only the two original combinations but recombinations also. As we have seen, 33 per cent. of all the offspring will be crossovers between white and miniature; there will also be 20 per cent. of crossing over between miniature and forked. In other words, there will be both red miniature and white long flies, and there will also be crossovers between white and miniature, *i.e.*, miniature wings straight spines, and long wings forked spines. It follows that there may also be cases in which crossing over has taken place between both of the above combinations at the same time (Fig. 38), that is, there will be some flies that are white long-winged and forked and others that are red miniature and straight

spines. A list of these classes with the expectation based on the results from a single experiment is given below.

Non-crossover	Single crossover	Double crossover
$\left\{ \begin{array}{l} w\ m\ f\ 23.2 \\ W\ M\ F\ 23.2 \end{array} \right.$	in 1st region $\left\{ \begin{array}{l} w\ M\ F\ 13.2 \\ W\ m\ f\ 13.2 \end{array} \right.$	in both regions $\left\{ \begin{array}{l} w\ M\ f\ 3.3 \\ W\ m\ F\ 3.3 \end{array} \right.$
	in 2nd region $\left\{ \begin{array}{l} w\ m\ F\ 6.7 \\ W\ M\ f\ 6.7 \end{array} \right.$	

Inasmuch as this subject and certain peculiarities in the results can be better understood after the evidence for

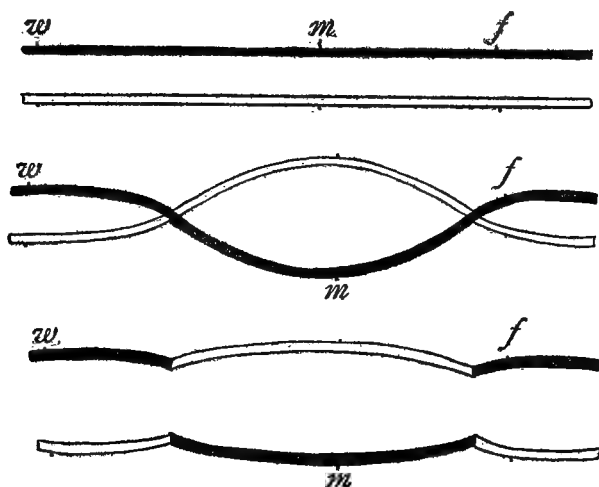

FIG. 38.—Scheme to illustrate double crossing over between white and forked. The gene for miniature standing between furnishes the evidence.

the linear order of the genes has been discussed, I shall not press further the discussion here. It should be pointed out, however, that the question of crossing over involves more than the independent action of the pairs in the cases so far considered; for, as will be shown later, when crossing over takes place not single genes but great groups of genes are involved. This block effect, as it may be called,

is not in evidence unless a larger number of genes than two is studied in the same experiment. These questions will be discussed in Chapter IX.

For the purpose of clearer exposition I spoke of linkage, in the preceding chapter, as though the term should be limited to cases where all the genes of a group hold together, and have used the term crossing over to mean the breaking of the group in one or more pairs. As a matter of fact, it is not desirable to emphasize this sharp distinction. There is, however, a real distinction that lies behind the phenomena. In the male of *Drosophila* there is no crossing over at all between homologous chromosome groups, while in the female there is crossing over between the pairs of chromosomes. The cases of the male and female are, therefore, on a different footing here.

We speak of pairs of characters as being loosely linked, meaning that crossing over of genes frequently takes place, and as strongly linked when crossing over is very infrequent. We have seen that yellow and white break apart only once in 100 times. If characters (or the genes) were still more closely linked, they might break only once in a thousand times, and if closer still once in many thousand times, in which case they would appear to be completely linked for all practical purposes. Such a gradation, however, does not appear to be the case, but the lower limit of crossing over seems to be well within the range of human capacity to detect. This means probably that there is a limiting value for crossing over, and if this can be established it may give us the lower limit of size of the gene (in terms of chromosome length), or at least it may allow us to form some idea as to how many genes are present in the hereditary material.

In this same connection it has been suggested that when more than two allelomorphs occur, we may be dealing only with close or even absolute linkage. For instance, suppose in a white-eyed race of flies a mutation should take place in a gene so closely tied up in some way to the



gene for white that the two never separated, and suppose the new mutation affected the eye so that its effect could be observed (for if not the change would not concern us). The new mutation would behave towards white in the same way as do all pairs of allelomorphs and yet in a strict sense is not allelomorphic. It is not necessary to elaborate here this idea, because fortunately in the case of *Drosophila* there is strong evidence to show that multiple allelomorphs do not arise in this way. The evidence for this statement will be given in Chapter XVII.

## CHAPTER VIII

### CROSSING OVER AND CHROMOSOMES

THERE are several occasions in the maturation period of the germ-cells when it would seem that there might be an opportunity for an interchange between like chromosomes. Such an occasion might be found at the time when the thin threads twist around each other; or it might be found after fusion of the threads, or possibly after a general breaking up of the chromosomes and reunion of the pieces. Unfortunately the cytological evidence does not furnish explicit information as to the stage at which interchange takes place.

It has also been suggested that crossing over may take place at a still earlier stage in the germ-tract, *i.e.*, long before the time of maturation, even in the early embryo. Fortunately, it has been possible to obtain critical genetic evidence showing approximately the time when crossing over takes place. This evidence was obtained by Plough in his work on the influence of temperature on crossing over in *Drosophila melanogaster*.

The way in which Plough's experiment was carried out was as follows: Females homozygous for three mutant factors in the second chromosome, *viz.*, black, purple, curved, were mated to wild-type flies. Some of these females were kept in an incubator, some in an ice-box, and some were kept at room temperature; under one or the other of these conditions they laid their eggs which hatched and produced larvæ and pupæ and flies. The daughters were then mated to black, purple, curved males, and remained under the same temperature conditions until their offspring hatched. It was found that there was more crossing over in the offspring of the pairs kept at a high and at a low temperature than in those kept at room

temperature. Later the crossing over values for intermediate points was also obtained, and from these data the curve shown in Fig. 56 was made.

At a low temperature (about  $10^{\circ}$  C.) crossing over is increased as compared with a somewhat higher temperature ( $18$ – $27^{\circ}$  C.). Room temperature ( $22^{\circ}$  C.) lies in that part of the curve where there is the least amount of crossing over. The amount then rises suddenly until about  $29^{\circ}$  and remains high till  $31^{\circ}$  C. is reached. The apparent fall after this temperature, as shown by the curve, may not be significant. The flies fail to lay eggs or may die at about this point.

In the foregoing experiment the eggs, larvæ and adult flies had been kept continuously at the same temperatures. If, however, the heterozygous virgin females reared at high temperature are back-crossed to the triple recessive males, and kept afterwards at normal temperature ( $22^{\circ}$  C.) it is found that only the first ten-day output of such females shows the high crossing over values. The value drops during the following ten days. If a correction is made for a change in the crossing-over value due to age—since age, as Bridges has shown, causes a lowering in the value—still the effect of the early period is found to have begun to disappear after ten days, and soon completely disappears.

In still another way the influence of temperature may be shown. Heterozygous females that had lived at normal temperatures are mated to triple recessive males, and then exposed for the first seven days to  $31.5^{\circ}$  C. At first the normal crossover values are found, as seen on comparing Fig. 40 with Fig. 39 which is the control. The latter drops slightly from the second to the eleventh day. About the eighth day the heat effects begin to show (Fig. 40), and there is a sudden and considerable rise in the curve, that lasts for ten days, when it drops back to normal, corresponding with the removal of the flies from the high to normal temperature, *i.e.*, after the seven-day exposure.

From data of this kind it is possible to locate the stage in the development of the egg when the heat is affecting it. If, for instance, we know how long after subjecting a

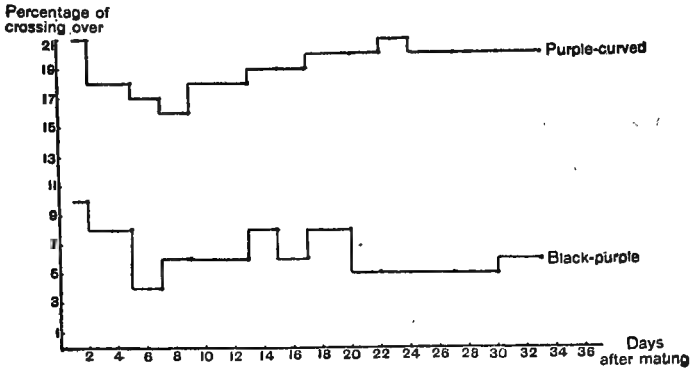

FIG. 39.—Curve showing the influence of temperature on crossing over; control. (After Plough.)

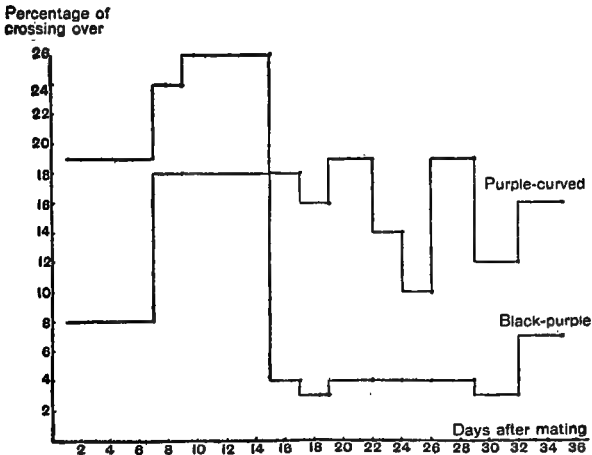

FIG. 40.—Curve showing the influence of temperature on crossing over. (After Plough.)

female to a high temperature, the effect of heat on crossing over begins to be observed in her offspring, and also how many eggs are laid by the female before this influence is manifest, we can tell approximately in what stages heat

affects crossing over. Furthermore, if we keep eggs, larvæ and pupæ in a high temperature, and then find out how many eggs have been affected by the high temperature, we can find out to what stage the eggs must have developed in order that crossing over may be influenced. Plough has made this calculation, and finds that only the eggs that have reached the stage where conjugation of the chromosomes takes place are affected—all the earlier stages are not influenced. It follows that the initial effect appears at about the time of conjugation of the chromosomes, but whether the crossing over occurs at this critical stage or some effect only is then produced that later affects the crossing over is not specifically shown. Nevertheless, I am inclined to think it more probable that the crossing over is actually changed at the time the heat acts (rather than afterwards), because in general most reactions of living things to environmental influence take place immediately rather than after a long interval. However this may be, the fact of prime importance in this work is that earlier than the period of conjugation of the chromosomes crossing over does not take place.

Expressed in numbers of eggs, the results show that in a just-hatched virgin female there are from 125 to 175 eggs that will be laid before the effects of heat are shown. In the females that have just hatched about 150 eggs are present that have passed beyond the conjugation period. This number (150) agrees with the estimated number of eggs (125–175) first laid that are not affected, and establishes the conclusion that after conjugation of the chromosomes crossing over cannot be influenced any more than it could before that period. The results clearly establish, then, that crossing over cannot be affected earlier than the conjugation, but can be affected at the time when the conjugation is known to occur.

As already pointed out, the chromosomes become drawn out into long threads at the synaptic period, and in many animals and plants these threads have been shown

to place themselves at this time in pairs. The double threads shorten later to take on the form of the ordinary chromosome. How the earlier, long thin thread (leptotene thread) is changed into a thick thread when the chromosomes condense is not known. According to several accounts the thread coils spirally within the wall of the "chromosome," at first in a loose coil, then in a tightly twisted coil. This idea of a coiled thread, or core, in a condensed chromosome is one that fits in very well with the idea that the thin thread represents the essential element in the chromosome that retains its original continuity even when the chromosome is condensed into a short rod or even into a ball. Unfortunately the evidence in favor of this view is by no means well established.

At the time when the threads conjugate, the evidence in several forms, such as *Batracoceps*, *Tomopteris*, etc., shows that when the conjugating pairs are U-shaped, the union begins apparently at both ends of the U at the same time. When the chromosomes are rod-shaped (in the last telophase) the evidence fails to show whether the union begins at both ends simultaneously or at one end only.

As the union between the threads progresses the parts not yet united can often be seen to be twisted about each other. They not only overlap, but they seem to be wrapped around each other.

Whether the threads are split lengthwise before their union can not be stated for all cases. It is certain that no splitting has been seen in several animals, but in one case (*Ascaris*) the threads have been found to be split lengthwise before they conjugate.

For a short time following the union of the threads they come in close contact with each other, and give the impression of having fused into a single thread. Usually before the nuclear wall breaks down to release the thick threads, a split can be seen again extending throughout the length of the threads. Not infrequently another longitudinal split appears in each half resulting from the

first split, so that four parallel strands appear. It is customary to call the split, that is supposed to correspond to the line of union of the maternal and paternal chromosome, the primary split or reductional split, and the split that corresponds to the longitudinal division within the

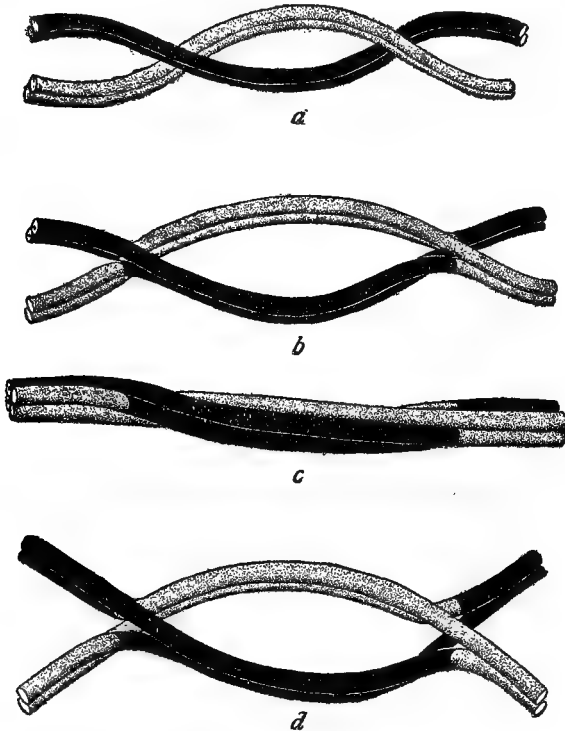

FIG. 41.—Diagram showing crossing over of two chromosomes at the four-strand stage, *a*, *b*, and the subsequent opening out of the tetrad, *d*.

maternal or the paternal chromosomes, the secondary or equational split. Only in very special cases is it possible to be able to say which is the primary and which is the secondary split. In fact, whenever crossing over takes place in the four-strand stage this distinction fails to have much meaning.

There are certain questions connected with crossing over that are illustrated by the following models (Figs. 41, 42, 43). In these models of tetrads the dotted rod, split lengthwise, stands for a maternal chromosome, and each of its halves may be called a strand. The split in the rod is the secondary (or equational) split. The black rod, also split lengthwise, stands for the paternal chromosome.

In Fig. 41, *a*, the two split rods are represented as twisted about each other. If the two inner strands break and the cords interchange at the levels, where they first come into contact with each other (Fig. 41, *b*), and then

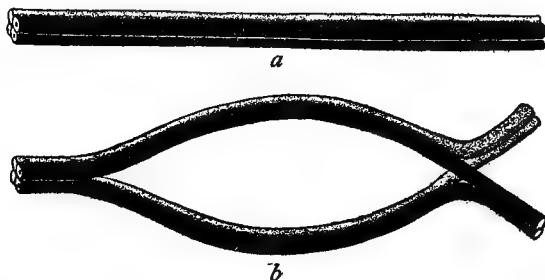

FIG. 42.—Scheme showing the opening out of the strands of the tetrad, *a*, in two planes, *b*, according to Robertson and Wenrich.

later the four strands come to lie side by side, *i.e.*, “fuse,” the result will be that shown in Fig. 41, *c*. Two of the strands represent crossovers in the sense that an interchange has taken place between a maternal and a paternal strand; and if at the first spermatocyte division, when the threads begin to pull apart, the maternal separate from the paternal threads, two threads may be seen actually crossing each other (Fig. 41, *d*). They are here the two non-crossover strands, but if the two strands thrown to the left had been thrown to the right the two crossover strands would cross over. The scheme is essentially the same as the chiasma of Janssens, but the strands that cross may or may not (as here) represent the crossover strands.



The next two figures (Fig. 42, *a*, *b*) show how Robertson and Wenrich interpret the crossed threads, that they have observed in the spermatogenesis of some of the grasshoppers. The four strands are represented as conjugating side by side in Fig. 42, *a*. When the strands begin to open out preparatory to the first spermatocyte division the two maternal separate from the paternal at the ends of the tetrad, while in the middle of the tetrad the opening up involves the separation of a maternal and a paternal strand from a maternal and a paternal. In other words, the tetrad opens up in two planes at right angles to each other. This scheme also gives an appa-

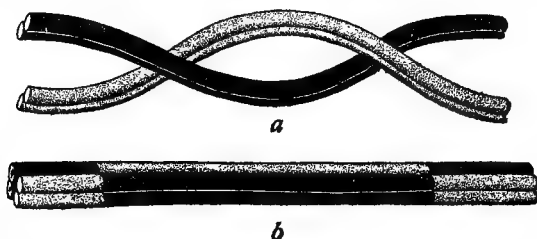

FIG. 43.—Scheme showing crossing over involving both strands of each chromosome.

rent crossing of the strands at the level where the opening out in one plane passes over into the opening out in the other plane, but there has been no real crossing over of the strands in the sense of interchange between them. Theoretically this explanation is sound, and moreover seems to be supported by observations in cases where the maternal and the paternal strands can be identified. The results undoubtedly show that the occurrence of crossed threads in cases where the split occurs in two planes does not necessarily imply that crossing over has taken place; but, on the other hand, as has been shown (in Fig. 41) a similar figure may also necessarily result after crossing over of the threads. In a word, the crossed-strand stage is not *ipso facto* evidence that it must have come about according to Robertson's

scheme. It should also be observed that the scheme rests on the assumption that no twisting has preceded the stage of the crossed threads, or, if such has taken place it has no relation to the resulting chiasma. Yet crossing of the threads is an observed fact.

A third scheme (Fig. 43, *a*, *b*) makes both maternal strands interchange with both the paternal ones. This scheme has at least one formal advantage over the other two in that it represents the four strands, after crossing over, as in position to lie side by side in the tetrad, so that the two longitudinal splits that reappear later lie in the same plane throughout their length. This seems more in accord with many of the observations that are recorded. If, during the following stages, the tetrads open out by the separation of the maternal from the paternal strands the crossed threads that result correspond to those in the first scheme (Fig. 41). At present it is not possible to decide between these different modes of representing crossing over. They may all occur. Their discussion shows little more than certain possibilities involved in the situation.

#### DETAILS OF SPERMATOGENESIS

Some of the stages in the spermatogenesis of a grasshopper, *Phrynotettix*, as described by Wenrich, are shown in the following figures. The material furnishes certain details concerning the "resting stages" of the nuclei preceding synapsis more completely than any other, and it serves also to illustrate clearly the relationship of the chromosomes to the vesicles into which they pass (or which they form) during the resting stages. The figures also show how the threads emerge from the vesicles in which they appear to have been contained during the resting stages, and how the opening out of the tetrads in two planes gives the appearance of chiasma according to Wenrich.

During the time when the germ-cells are increasing in number by division there is a resting stage after each

division during which the chromosomes expand into a sort of vesicle, as seen by comparing Figs. 44, *a* and 44, *b*. An optical cross section of the stages shown in the last figure is represented in Fig. 44, *c*. An older stage is seen in Fig. 44, *d*. The stage of greatest diffusion of the chromatin material within its vesicle is seen in this figure, where the outlines of each vesicle are still visible. As the nucleus gets ready for another divi-

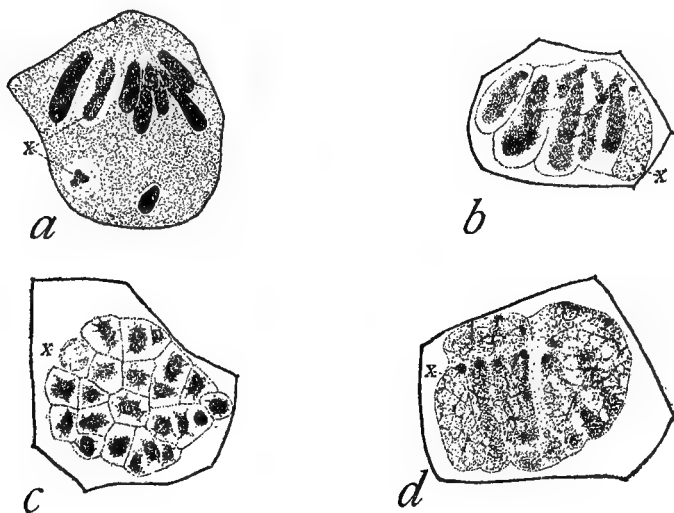

FIG. 44.—Spermatogonial cells in the last phase of division, *a*, and the following resting stages, *b*, *d*. (After Wenrich.)

sion the vesicles become more distinct (Fig. 45, *a*, *b*), and soon a coiled thread can be seen to be present in each vesicle (Fig. 45, *c*). As the thread thickens (Fig. 45, *d*), a longitudinal split appears in it, which indicates the plane of division of each chromosome at the next division.

At the last spermatogonial division, the chromosomes of the two daughter nuclei form vesicles, as they have done in earlier divisions (Fig. 46, *a* and *b*). But changes begin to take place that carry the chromosomes through a very different series of stages from those seen in preparations

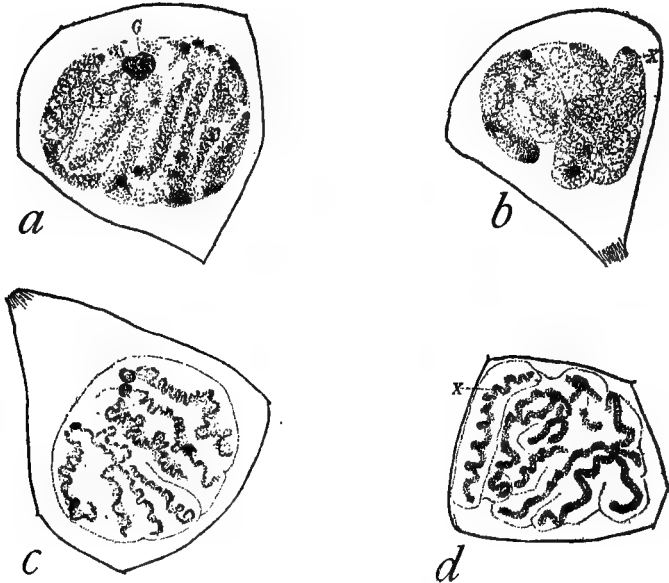

FIG. 45.—Cells emerging from the resting stages preparatory for the next spermatogonial division. (After Wenrich.)

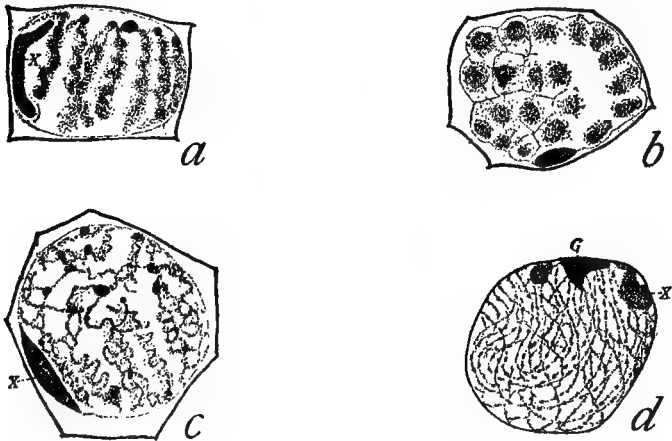

FIG. 46.—Cells emerging from their last spermatogonial division, *a, b*; passing into the synapsis stage, *c, d*: (After Wenrich.)

for the ordinary spermatogonial (or somatic) cell-divisions. Each chromosome vesicle begins to show a coiled thread (Fig. 46, *c*). Each thread next becomes longer and longer (Fig. 46, *d*) until the whole nucleus is filled with them. One or both ends can often be seen at the "distal pole" of the cell, where deep-staining nucleoli are present. The cells are now in the so-called thin thread, or leptotene stages.

The threads next come together in pairs beginning at the distal end of the chromosomes (the zygotene stage,



FIG. 47.—Formation of a thick thread after synapsis, *a*, *b*; and the following condensation of a tetrad, *c*. (After Wenrich.)

Fig. 47, *a*). When the fusion is complete and all the threads are double (Fig. 47, *b*), the stage is called the thick thread or pachytene stage. There are half as many threads now present as at the beginning. A longitudinal split is present in the chromosome throughout these stages along the line of fusion of the two thin threads. Wenrich identifies the split as the "primary split."

Another longitudinal split at right angles to the other one soon appears (Fig. 47, *c*), thus forming tetrads, each composed of four chromosomes. The tetrads next shorten,

opening out in various ways to produce figures like those shown in Fig. 47, *c*.

The sex-chromosome (*X*) that has no mate in the *Phrynotettix* male, and hence has not conjugated, has only one longitudinal split (a dyad). The cell, the primary spermatocyte, with its nucleus next divides. Eleven autosomes go to each pole, and the sex-chromosome failing to divide at this time goes to one daughter cell only. The secondary spermatocytes are produced—half with 12, half with 11 double chromosomes. A short resting stage follows—the chromosomes again becoming diffuse, *i.e.*, forming vesicles. They soon reappear and a second division takes place, producing the spermatids—the daughter cells of the secondary spermatocytes. Half of these have 12, half 11 chromosomes—the *X*-chromosome having divided at the second division.

Wenrich found it possible to identify certain of the chromosomes and was thus enabled to follow a few of them through several successive stages. Eight consecutive stages in the history of chromosome “*B*” of *Phrynotettix* are shown in Fig. 48. Indications of the primary split are present in *a*, *b*, *c*, the secondary split appears first in *d*. The evolution of the thread continues as the tetrad becomes placed in the spindle in such a way that the first separation of the chromosomes takes place along the secondary split, *i.e.*, the first division is equational. Wenrich found in several other individuals of this species that this same chromosome pair “*B*” consist of unequal members as shown in Figures 48, 2 *a-h* and 3 *a-d*. In 48, 2 *c* a distinct crossing of the threads is present. The shape of the contracted chromosome (*f g h*) and its position on the spindle show that one of the longer, and one of the shorter strands passes to one pole, and similarly a longer and shorter to the other pole. The division here is in the plane of the secondary split, *i.e.*, equational. The inequality in length of the conjugating pair makes this conclusion certain in this case.

In the second division of this chromosome the longer thread separates from the shorter one—the second is therefore reductional. It is evident, especially from this

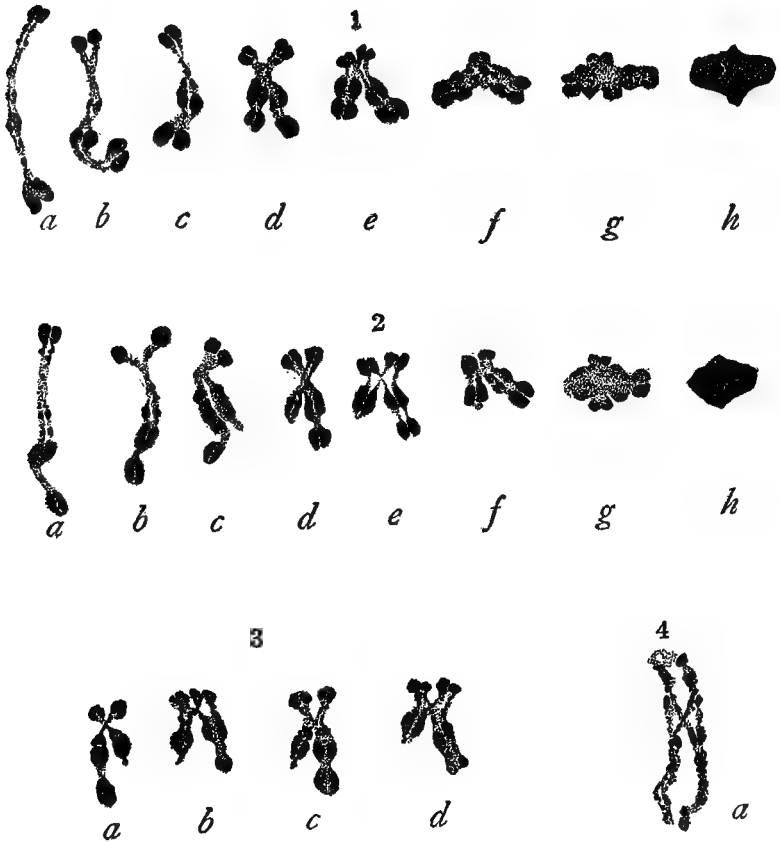

FIG. 48.—A pair of chromosomes "B" in conjugation, 1; the same pair in conjugation in another individual in which one chromosome is shorter than the other, 2; same in a third individual, 3; later stage showing chiasma of threads, 4. (After Wenrich.)

last example, that the crossing of the threads is not an indication that the division of the chromosome is necessarily different from what it is when there is no such crossing. What is more important is that the crossed

threads furnish no proof that an interchange must have taken place earlier, but neither does it furnish any evidence that interchange had not taken place. For example, the most obvious interpretation of Fig. 48, 2 *d* is that the upper end of the tetrad has separated in the plane of the secondary split (in anticipation, as it were, of the separation about to take place in this plane), and has separated in the lower part of the same tetrad in the plane of the primary split. This interpretation does not involve any real crossing over in the sense that the two crossed threads had previously broken and interchanged, as Jans-

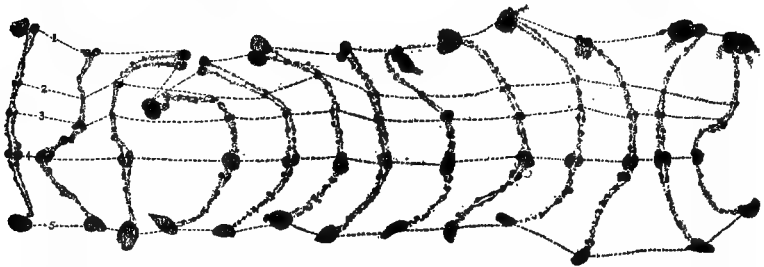

FIG. 49.—The same chromosome pair in conjugation from thirteen different cells. (After Wenrich.)

sens' chiasmatype assumes on the ground that the two granules (threads) in contact at the upper end of the tetrad must be related to each other in the same way as are those further back in the tetrad.

This last assumption is the foundation of Janssens' view, but has no longer sufficient evidence to support it, even though none opposes it. Nevertheless, it should be clearly understood that evidence such as this, derived from Wenrich's results, can not possibly be held to show that an earlier interchange or crossing over has not occurred. If it had, such a figure as this (*c*) would, as explained above, be a consequence to be expected.

The constancy of the beading of the chromosomes in each individual is most remarkable. Its significance for



the linear order of the material of the chromosomes cannot be overestimated. As a further example Wenrich gives identical stages of the same chromosomes (Fig. 49), each of the figures is from a different individual. The identity in size and in location of the principal beads in the series is obvious.

Robertson has also brought forward a case of an unequal pair of chromosomes and interpreted the facts as opposed to the crossing-over hypothesis. He found two cases in a grasshopper of the genus *Tettigidea* in which there was a very unequal pair of chromosomes. The shorter piece conjugated consistently with only one part of the longer chromosome, as shown in the next figure

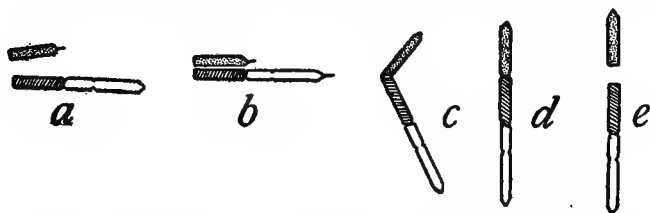

FIG. 50—Conjugation of an unequal pair of chromosomes and their subsequent separation. (After Robertson.)

(Fig. 50, *a, b*). At the first maturation division the two chromosomes separated, as shown in (*c, d, e*). It would be difficult to find a more excellent illustration of the persistence of the individuality of the chromosomes after conjugation, and the case falls equally in line with the view that conjugation takes place only between those parts of the chromosome that are alike, *i.e.*, composed of the same series of genes. How, then, could this case, so admirably suited to support the chromosome theory be turned against the chiasma theory? Only, I think, through a misconception of the essence of the theory. Robertson says: "In both types of unequal tetrads we have very strong evidence that the homologous chromosomes, on entering the side-to-side pairing process of synapsis, remain as distinct individuals, retain their identity throughout the period, and come

out of it with at least the same size they had on entering it. Each pairing chromosome maintains its distinct individuality during this period. This is opposed to the idea of Janssens ('09) and Morgan ('11), as expressed in the theory of chiasmatype. In their theory they assume that homologous chromosomes in parasynapsis twist about each other and fuse. On splitting, a plane passes down the fused body, regardless of the previous spiral fusion plane, resulting in two daughter chromosomes which may not be identical with the two chromosomes which entered the process. Each new one may contain parts of both original chromosomes. If such had been the case, the separation or formation of a short and a long chromosome out of the first chromosome with such regularity of size, etc., as we have shown, could not have occurred." On the contrary, even if crossing over had occurred within the region where the short and the long pieces came together, the separation would be expected still to be exactly that described by Robertson; for the genetic evidence points very clearly to the conclusion that the interchange involves exactly equal and opposite parts. There is no reason to suppose that regions outside the conjugating region would be affected; on the contrary, all the genetic evidence would lead us to expect no such effects.

#### SUMMARY OF EVIDENCE

If we have found Janssens' evidence inadequate as a demonstration of crossing over, what other evidence is there in the history of the chromosome to which an appeal can be made? First, there is the undisputed fact that at the time when the chromosomes come together they spin out into long, thin threads which, as they meet, lie over and under each other, so that the line of fusion is in a spiral plan. Later, when the fusion is complete, it is no longer possible to follow the plane of union, but unless the chromosomes slip around each other after crossing

over—for which there is no evidence—one member of the pair must lie on one side of its mate in one region, and on the other side in other regions. Second, when the thick thread splits anew just before condensing into the tetrad it is so difficult to follow the course of the split in all cases that it cannot be affirmed that it always lies in one plane throughout the length of the chromosome, but if such should turn out to be the case, as so often figured, it would appear to mean that the crossing over had taken place and been obliterated by the time the condensation began. Third, evidence such as that described by Wenrich—of which sort there are other cases but none quite so clear—indicates that the chromosomes are enclosed in vesicles until they begin to spin out each into a long thread. Interchange of the sort called for by the genetic evidence could scarcely take place until the walls of the sacs had disappeared. The thin thread stage that follows would seem best to fulfill the conditions called for by the genetic evidence. The moment the primary split appears after the two threads have fused there would seem to be precluded any further chance for crossing over, as the genetic evidence suggests. This analysis leads, then, to the thin-thread stage as the most favorable stage for the requirements of the genetic evidence.

It is well known that most of our information about the maturation stages is derived from the male, because of the greater ease of obtaining the critical stages, and in preparing material. We are handicapped in discussing crossing over to a large extent by the fact that we must appeal largely to the evidence of spermatogenesis. In *Drosophila* at least there is no crossing over in the male. On the other hand, Nabours has recently found evidence in one of the grasshoppers that crossing over occurs both in the male and female. In this case evidence from the male would be more to the point. Whether genetic crossing over occurs in the male of *Batrachoseps* and *Tomopterus*, we do not know.

In the female of some insects, amphibians, selachians and annelids, the thin-thread stages in the form of U-shaped loops have been described—stages that are so much like those of the male that the argument for one would seem to extend to the other. But again this proves too much, and we have yet to learn what cytological differences exist in cases where crossing over occurs in one sex and not in the other. On the whole, then, while the genetic evidence is favorable in all essentials to the theory of interchange between homologous chromosomes, it must be confessed that the cytological evidence is so far behind the genetic evidence that it is not yet possible to make a direct appeal to the specific mechanism of crossing over on the basis of our cytological knowledge of the maturation stages. The idea that the chromosomes disappear as such and go into some sort of suspension during the resting stage is an old idea. O. Hertwig thought that the chromosomes did actually “dissolve” at this time and “recrystallize” at each division stage. Goldschmidt elaborated a view of crossing over that rests on the assumption that the homologous genes are set free in the resting nucleus and may become interchanged during reconstruction. Aside from certain inherent contradictions in Goldschmidt’s scheme (the most obvious ones have been pointed out by Sturtevant and by Bridges), it stands in contradiction to the one most certain fact that we know about crossing over, *viz.*, that not single genes but whole blocks of genes are involved—in fact, the most common sort of interchange involves the two entire pieces of each chromosome.

The general idea that the genes become dissociated during the resting phases is disproven by the way in which they come together. The genetic evidence from *Drosophila* shows that when crossing over occurs, let us say at the middle of the chromosome, all of the genes of each half of each pair hold together—and exchange as large pieces. Now if the genes are dissolved at each rest-

ing stage, there can be given no explanation as to why homologous genes should not recombine in all possible combinations with other genes. But this is exactly what does not happen. If it be supposed that the chromosomes dissolve only partly into chains of genes, it is still not obvious why the chains of one chromosome should be identical with those of the other (its homologue) as they must be to recombine properly; for, in neighboring nuclei other chains are forming—as the crossing-over results indicate—involving breaking at all possible levels.

Bateson and Punnett have proposed a theory of crossing over that is called reduplication. It is fundamentally different from the one here adopted. Although I think this theory outlawed by the evidence that Plough has obtained, and made impossible by certain other considerations that will be given later, the theory is so interesting that it may be briefly stated. Bateson suggests that at some time early in the embryo segregation may take place involving heterozygous pairs of factors. In the actual case presented only two such pairs are involved. As a "symbolic presentation" of the situation Bateson gives the diagram drawn in Fig. 51.

Although the dichotomous method of separation is utilized in the second line of figures to show reduction of the two pairs at once, such figures could obviously bear no relation to the ordinary process of cell division—nor do they, I understand, pretend to be. After separation (segregation) the cells that get  $AB$  and  $ab$  are represented as dividing faster than the cells  $Ab$  and  $Ba$ , hence there will be more of them in proportion as the two rates of division differ.

Bateson's view is open to the following criticisms:

1. The evidence from *Drosophila*, where many linkage ratios are known, gives no support to the view that these ratios fall into relatively few dichotomous schemes, such as Bateson's hypothesis calls for. Other forms also fail to fit such a view. On the contrary, the ratios fall into no

such groups as those given by Bateson. Even were it possible to suppose that in each case a different reduplication occurred (*i.e.*, a different number of generations was passed through), still, as said above, it is not obvious that the linkage series stands in any such numerical (*i.e.*, dichotomous) relation as the view demands.

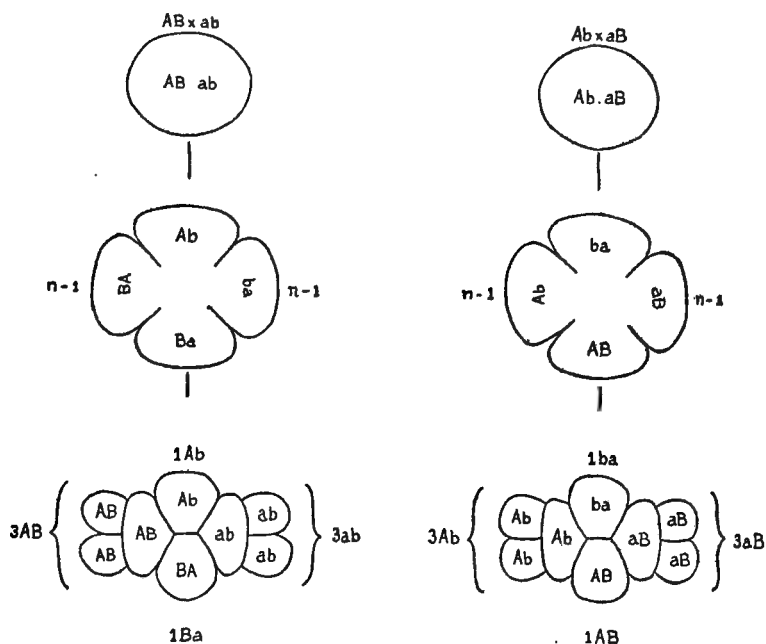

FIG. 51.—Two schemes illustrating the idea of reduplication by Bateson and Punnett; the three figures to the left illustrating "coupling," and the three to the right "repulsion."

2. If reduplication occurred at an early stage in the germ tract, we should expect to find in any organ of limited size, as a stamen, that there would be a likelihood that it would contain for the most part a particular kind of cell. Altenburg tested out this view with pollen of the primrose and found no evidence in favor of a limited distribution—on the contrary, he found that all the linkage combinations

were present in each stamen in the expected proportions. These and other difficulties make it improbable that linkage can be the result of this kind of reduplication.

Bateson and Punnett formulated their hypothesis at first for only two pairs of linked factors. When it was shown that three pairs of factors could show linkage, Bateson and Punnett assumed that all three pairs of factors might segregate at the same time\* (or in three successive divisions), the observed ratios being due, as before, to unequal division rates later. Trow has suggested that in such cases the segregation and reduplication for the third pair of factors might not occur until that for the first two pairs was completed. This view seemed to meet certain inadequacies of the former hypothesis, but meets with certain difficulties on its own account. One of the most obvious of these objections is, as Sturtevant has pointed out, that the number of cell divisions, necessary to produce some of the higher ratios that are known, would produce a mass of cells thousands of times larger than the animal itself.

## CHAPTER IX

### THE ORDER OF THE GENES

THE proof of the linear order of the genes is derived directly from the linkage data. It is not dependent on the chromosome theory of heredity. Fortunately, as was pointed out in the last chapter, there are many facts about the maturation stages of the eggs and sperm that fit in extraordinarily well with the theory of the linear order of the genes, but let me repeat, the proof of the order is not dependent on the chromosomal situation. The evidence for the linear order is furnished by linkage and its correlative phenomenon, crossing over. By linkage is meant that certain factors that enter the cross from each parent remain together in subsequent generations, more often than they separate. For example, if in *Drosophila* yellow wings and white eyes have entered from one parent and gray wings and red eyes from the other, the new (crossover) combinations, yellow and red, gray and white, are less numerous than are the original linked combinations, yellow and white, gray and red. The number of individuals (crossovers) that result from this interchange, expressed as percentage of the whole number of individuals, is called the crossover value. Such a percentage indicates how often the linkage is broken. Thus, if crossing over between yellow and white is shown in 1 per cent. of the gametes, then 1 stands for the crossover value of yellow and white. Conversely, yellow and white have remained together (linked) in 99 per cent. of the gametes. We speak of the linkage relations in such cases in terms of the crossover values, here 1 per cent.

For the proof of the linear order of the genes, it is only



necessary to represent one set of linked genes ( $a, b, c$ , etc), ignoring the normal allelomorphic series, for these follow the same (reciprocal) changes.

If  $a, b$ , and  $c$  stand for three genes, and if the linkage relations of  $a$  to  $b$  and of  $b$  to  $c$  are known, the relation of  $a$  to  $c$  is a function of the sum of  $ab$  and  $bc$  or of the difference of  $ab$  and  $bc$ . For example, if the crossover value  $ab$  is expressed as 5, and that of  $bc$  as 10, then  $ac$  is a function of the sum (15), or the difference (5) of  $ab$  and  $bc$ . It cannot be said that  $ac$  must be 5 or 15 because another possible process may intervene to affect the sum or the difference, *viz.*, double crossing over in the region involved. By making the distance so small that double crossing over is practically excluded the sum or the difference is actually the realized result, as the following example illustrates:

When three mutant characters yellow, white and bifid were all used together in a single experiment, it was found that there were 1160 non-crossovers, 15 flies representing single crossovers between yellow and white, and 43 flies representing single crossovers between white and bifid. There were no flies representing crossing over in both regions at the same time, *i.e.*, there were no double crossovers. Thus the crossover value yellow white is 1.2, and the crossover value white bifid is 3.5. The same data give the yellow bifid crossover value of 4.7, which is precisely the sum of the two component values:

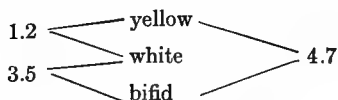

The simplest way in which such a relation can be thought of is that the three genes stand in a line. Suppose a fourth linked gene,  $d$ , is added to the series. It is then found that  $bd$ , is a function of the sum or of the differ-

ence of *b* to *c* and *c* to *d*. Four points arranged in a straight line still fulfill the relations here found. I know of no other geometric configuration that covers all these results—perhaps there is none. When we add more and more linked genes to the series, and find the same predictable relations continue to hold, the theory of the linear arrangement becomes firmly established. Perhaps the best proof of the linear order is found in the opportunity it gives for prediction; for, when the relation of *d* to *b* and to *c* is known its relation to *a* can be foretold accurately.

It has been found when there is a large amount of crossing over between two factors used in an experiment, that the crossover value is not the same as the value determined by adding together the crossover values of intermediate points between the two factors in question. What appears here to be a contradiction proves, when understood, to be one of the best pieces of evidence in support of the theory of the linear order.

A few examples will serve to illustrate the point at issue. When a fly with yellow wings and bar eyes is mated to a wild-type fly, the amount of crossing over in the  $F_1$  female between yellow and bar (as determined by backcrossing) is 43.6 per cent., but if the crossing over between yellow and bar is calculated by adding up the crossover values obtained by using intermediate points ( $ab + bc$ , etc.) the value is about 57 per cent. The apparent inconsistency is at once cleared up by arranging the experiment so that, while obtaining the data for yellow and bar, there are also obtained data showing what is happening in the region between them. It is found that a large amount of double crossing over occurs, and, when the correction for this is made, the "discrepancy" disappears. If crossing over may take place at any level, it is obvious that it might occur at two points at the same time, and experience

shows that such is the case, for such double crossing over can be detected if enough points in the series are "involved" to catch all single crossovers. Now, as shown in Fig. 52, whenever double crossing over takes place between  $y$  and  $B$ , the two series that result, as marked by their ends alone ( $y$  and  $B$ ), are still  $y$  and  $B$ . The flies will therefore be placed in such classes, which are the non-crossover classes. A numerical increase in this class will decrease the calculated percentage of crossovers. Thus double crossing over by increasing the number of

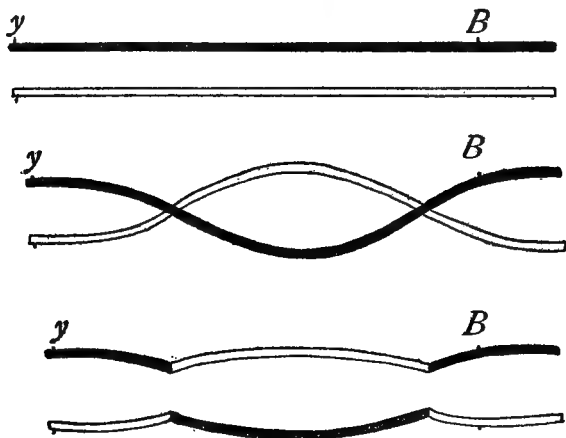

FIG. 52.—Scheme illustrating how double crossing over between two distinct genes,  $y$  and  $B$ , is not recorded, when only  $y$  and  $B$  are involved.

apparent non-crossovers, decreases the observed percentage of crossovers. When enough points are marked along the series to pick up all double crossovers, and these are then referred to the proper single crossover classes, the "piece-by-piece" per cent. estimate, and the percentage obtained from the cross, are found in complete agreement.

The amount of double crossing over in *Drosophila* is so large that the percentage of "crossing over" is rarely or

never more than 50 per cent., although the actual numbers given for "distances" between two genes may be as much as 107 based on summation of short distances. The latter method of calculation is the accurate way of stating the result, and whenever possible it is adhered to, *i.e.*, the percentage numbers for crossing over are sum totals based on results obtained with genes so near together that double crossing over is practically excluded.

Another illustration where the difference between the direct calculation between two factors (scute and forked) and the "piece-by-piece" estimate is greater than 50, is as follows: At one end of the series of sex-linked genes is a factor scute (zero) and near the other end forked. The direct data for crossing over between them gave a cross-over value of 48.2. Between them three other loci were present in the same experiment, and crossing over between them could also be detected. As shown in the table below, the sum of these crossover values gave 61.1 units between scute and forked.

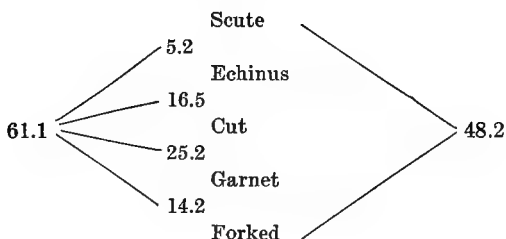

The presence of the intermediate factors makes it possible to pick up most of the double crossing over that occurred between scute and forked. When a correction is made for these the difference between 48.2 and 61.1 entirely disappears. Another and still more extreme example will help to make this more evident. Near one end of the second chromosome is the gene for star (eyes),

near the other end is the gene for speck. Bridges furnishes the following data in regard to crossing over between these loci. When only these distant loci are used the crossover value is 48.7. When the sum of the crossover values between the following seven genes is taken as the value for star and speck it amounts to 104.4.

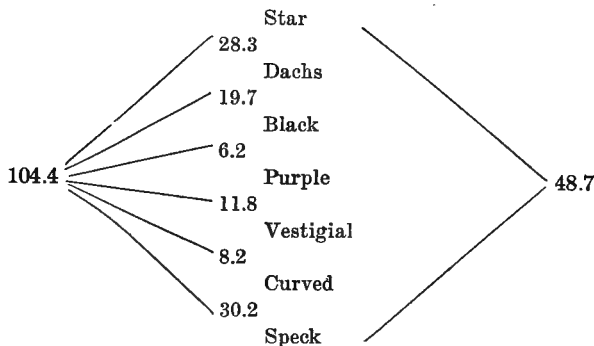

In this case (as other experiments show) there are still two units missing in the map distance given above (104.4), because of one per cent. of double crossovers in the region between curved and speck, that are not here recorded, since there are here no loci within this distance of 30.2.

Whenever cases in which double crossing over has taken place are checked up as in the foregoing cases, it is found that the discrepancies in the two methods are accounted for.

It is instructive to compare the preceding case with another one including several of the same genes, but in addition something else (deficiency), that cuts down the amount of crossing over in certain regions. The crossover value between star and speck was found to be 47.7 in this experiment. The sum of the crossover values of the six loci involved gave 79.3 units. The difference

between 47.7 and 79.3 is due to double crossovers as the data for the intermediate regions show:

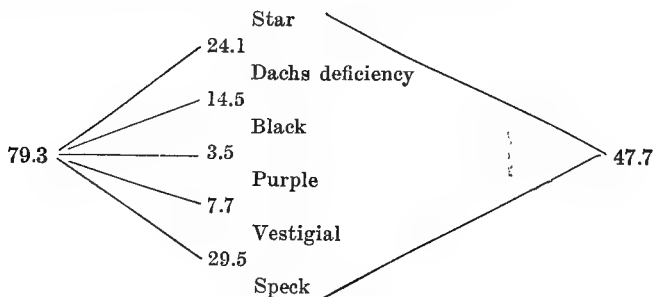

There was known to be present in this case a factor called "deficiency" in one of the two second chromosomes involved. It is near "dachs" and cuts down the crossing over between star and speck by about 25.8 units. It will be noticed that while the second summation value for star speck, *viz.*, 79.3, and the first value, *viz.*, 104.4, are very different, the crossover value between star and speck is in one case 47.7 and in the other 48.7. The meaning of this, as shown by data for intermediate loci, is that by the addition of 25.1 units (104.4 minus 79.3 equals 25.1) the number of double crossovers has so greatly increased that a difference of only about 1 per cent. of apparent crossing over is recorded in the star speck value.

#### "DISTANCE" AND LINEAR ORDER

The linear order of the genes implies distance between them, for which the crossover values stand as indices. It is obvious that if the order of the genes remained the same but something doubled the number of crossovers between two loci, their "distance" apart would at the same time appear to have been doubled. Again, if crossing over is thought of as due to twisting of the chromosomes of a pair about each other, then if the twisting is more likely to occur at the ends of the chromosomes, or if the twists themselves

are shorter there, "distance" in these regions is on a different scale from distance in the middle of the same chromosome. Factors for crossing over have been found, by Sturtevant, that change the values in certain parts of the series and leave other parts unaffected. When the influence of these special genes, that can be treated in the same way as are all Mendelian genes, is removed, the region that was affected gives its original crossover values again.

It is to be understood, then, that when we substitute the idea of distance for crossing over values the term is not used in an absolute sense, but in a relative sense, and that it depends always on the conditions of the experiment. That the genes do stand at definite levels in the chromosomes, and that in this sense they are definitely spaced, seems reasonable in the light of all the evidence bearing on this point; but even if they are so spaced that crossing over is a function of their distance from each other in the series, any influence that determines how often interchange between homologous pairs will take place would give the appearance that the actual distances themselves have changed.

## CHAPTER X

### INTERFERENCE

ONE of the most significant results that a study of crossing over has brought to light is that whole blocks of genes go over together. Thus, if one series be *A B C D E F G H I J K L M N* and its allelomorphic series be *a b c d e f g h i j k l m n* crossing over may give two blocks of genes.

$$\begin{array}{cccccccccccccccc} A & B & C & D & E & f & g & h & i & j & k & l & m & n \\ a & b & c & d & e & F & G & H & I & J & K & L & M & N \end{array}$$

This result can best be demonstrated in cases where a number of loci are followed at once.

The fact that crossing over takes place in blocks is highly significant for the phenomenon of distribution, since it means that pairs of linked genes do not act independently of their neighbors. This fundamental relation was not suspected until quite recently.

The size of the blocks, when only one crossing over occurs between the chromosome pairs, depends on the location in the series of the breaking point. If the crossing over occurs near the middle, the four pieces will be of the same length as shown below:

$$\begin{array}{cccccccccccccccc} a & b & c & d & e & f & g & H & I & J & K & L & M & N \\ A & B & C & D & E & F & G & h & i & j & k & l & m & n \end{array}$$

If it is near the end of the series, two of the resulting pieces will be small, the other two large. Thus:

$$\begin{array}{cccccccccccccccc} a & b & c & D & E & F & G & H & I & J & K & L & M & N \\ A & B & C & d & e & f & g & h & i & j & k & l & m & n \end{array}$$

The two "like" pieces in all cases contain identical series of loci.



The data also show that the series may break at two points, and that when this happens the three blocks of one set always correspond to the three blocks of the other series of genes. Thus interchange at two levels gives:

$$\begin{array}{cccccccccccc} a & b & c & d & E & F & G & H & i & j & k & l \\ A & B & C & D & e & f & g & h & I & J & K & L \end{array}$$

The same relation holds in principle for three or more breaks in the series.

If in such a system the blocks have no commonest length, the break in the series at one level should not bear any relation to the place at which another break takes place. For example, if it is true that when a break occurred between *D* and *E* it had no influence on a break at any other point of the series, the blocks resulting from two breaks would not tend to be more of one length than of any other length. But if the evidence shows that when a break occurs between *D* and *E* the chance of another break occurring in that vicinity is decreased, or increased, the results would be expected to follow some definite law or principle, rather than be simply the result of chance. This is in fact the case. An illustration may make this clear.

Suppose when crossing over takes place within the blocks *A B C D*, and *E F G H*, and *I J K L* it can be recorded. If we know how often, when the break occurs only once in the series, it takes place in the first, in the second, or in the third block, we can then determine in those cases where breaking occurs in the first block, whether it is as likely to take place in the second block as when no break occurs in the first, etc. Such tests have been made (Muller, Sturtevant, Bridges, Weinstein, Gowen) with *Drosophila*, and the same kind of results consistently obtained. It has been found, for example, that when a crossing over takes place between *G* and *H*, a second one is less likely to take place on either side, *i.e.*, between *F* and *G* or between *H* and *I* than when no cross-

ing over takes place between  $G$  and  $H$ . Stated in another way, crossing over in one region protects neighboring regions from crossing over. Moreover, this relation follows a perfectly definite law according to the "distances," as determined by linkage relations of genes outside of the region of crossing over. If we take two pairs of factors  $\frac{G}{g} \frac{H}{h}$  closely linked together we find that the genes lying immediately to the right and left of  $\frac{G}{g} \frac{H}{h}$  never cross over independently of  $\frac{G}{g}$  and  $\frac{H}{h}$  at the time that a crossover separates  $\frac{G}{g}$  and  $\frac{H}{h}$ . In other words, the genes immediately to the right of  $H$  always go over with  $H$ , and those to the left of  $G$  always go over with  $G$ , when  $G$  separates from  $H$ .

If we consider genes that are less closely linked with  $G$  and with  $H$ , we find that while their crossing over is interfered with by the crossing over between  $G-H$ , it is affected to a limited extent. Genes still less linked with  $G$  or with  $H$  are still less interfered with; until finally there is no relation at all between crossing over between  $G-H$ , and other more loosely linked genes, *i.e.*, crossing over between  $G-H$  is found to have no relation to crossing over between  $L$  and  $M$ . Put in another way, one may say that crossing over at  $L$  and  $M$  is no more likely to take place when none occurs between  $G-H$ , than when it does.

For different pairs of chromosomes the regions that bear this relation to each other have been found to be different. Even within the same chromosome this relation may be different at the ends and in the middle. There are also special factors that affect special chromosomes and special regions of chromosomes. An example will illustrate this relation that is called interference. If in a group of genes  $A B C D E F$  a break occurs somewhere between  $A$  and  $D$  in 6 per cent. of cases, and if between  $M$  and  $T$  in the same series ( $M N O P Q R S T$ ), in 10 per cent. of cases, a double break involving both regions simultaneously should, if the breaks occurred independently of

each other, take place in 0.6 per cent. of the cases. But if the regions in question are close together, that is, if the intervening block (*i.e.*,  $G F H J K L$ ) of genes is short, it is found that there are fewer double crossovers than the 0.6 per cent. expected on a purely random basis. This was shown by Sturtevant in his paper on chromosome maps. It means that a break in one region interferes with a break in the other region when the intervening block is short.

The ratio of the number of actual double breaks obtained to the number of double breaks that would occur if one of them did not interfere with the other is termed coincidence. If in the above example only 0.3 per cent. of the cases were double crossovers involving the regions  $A B C D E F$  and  $M N O P Q R S T$  the coincidence would be 0.3 per cent. divided by 0.6 per cent., or 0.5.

It has been found that as the distance between two regions increases, crossing over in one of them interferes less and less with crossing over in the other; that is, the number of double crossovers obtained approaches the number expected on a random basis, and coincidence rises gradually to the value of 1. This phenomenon is shown in all the cases where more than one block of genes has been followed. It is especially clear in the work of Muller, who studied a large number of factors in the sex-chromosome of *Drosophila* simultaneously.

When the intervening block becomes sufficiently long so that the coincidence attains the value of 1, interference has entirely disappeared. When, however, the distance is increased still further interference reappears, *i.e.*, coincidence decreases again. There was a suggestion of this in Muller's work; and the work of Weinstein undertaken to get critical evidence on this point indicates clearly that such a decrease exists. For the second chromosome a similar rise and fall with increase of distance is indicated by Bridges' data.

The fact that interference reappears, *i.e.*, that coincidence decreases after reaching a maximum, indicates that the segment of a chromosome between the breaking points tends to be of a particular (modal) length; and that breaks which are closer together or farther apart than this modal length are less frequent. That is, genes not only stick together in blocks, but the blocks tend to be of a definite size, and longer and shorter blocks are less frequent. In the sex-chromosome of *Drosophila*, which is 65 units long, Weinstein's data indicate that the most frequent length of block is about 46. In the second chromosome (which is 107 units long), Bridges' data indicate a modal length of about 15 in the centre of the chromosome and of about 30 on either side of the middle point.

The work on coincidence throws light on the behavior of the chromosomes during crossing over. The cytological evidence has not determined whether when crossing over takes place the chromosomes are twisted loosely or tightly. But Muller has shown that this question may be attacked by certain calculations based on the data of interference. If, as a rule, chromosomes twist in long loops, crossing over at two points close together would be rare, for it would require a shorter twist than usually occurs. The occurrence of long loops would explain the interference of neighboring regions. Moreover the decrease of interference as distance increases would be accounted for, because short loops would be less frequent than longer ones. The reappearance of interference for widely separated regions is explained by supposing that extremely long loops are infrequent as are very short ones. That is, on the supposition of long twists there would be a modal length of loop, and loops of greater or lesser length would be less frequent.

If, however, the chromosomes are tightly twisted into short loops, the interference of neighboring regions might be explained on the supposition that a break at one point allows the chromosomes partly to unravel in the neighbor-

hood of the break, and that this loosens the twisting and prevents another break near by. In regions farther away from the break, the threads would not be so much unravelled, so that the greater the distance from the first point of breaking the more would a second break be likely to occur. That is, interference should grow less at greater distances. But the reappearance of interference at still greater distances seems incompatible with this scheme; thus the actual data favor the first view of crossing over, in which the break occurs during a stage of loose twisting. At any rate, as Weinstein has pointed out, the variation of coincidence with distance must be dependent on other conditions than the mere tension due to the twisting of the chromosomes, and any view which refers the breakage of the threads to the tension of tight twisting must be rejected or supplemented.

Castle has recently suggested that the difference between the values for a long "distance" and summation of short "distances" is due to the loci not lying in a straight line but "out of line." He suggested that when short steps are taken as the basis for map distance they represent the "long way round," as, for instance, in passing from one end of a  $V$  to the other end, keeping on the line; while when a direct cross is made, giving a shorter "distance," this is a measure of the direct or air-line between the two ends of the  $V$ . Such a theory is not in harmony with the following facts. The best data (*i.e.*, data sufficient in amount and free from crossover variations) show that Castle's three dimensional figures reduce to a curved line in a plane. In such a curved line the most distant points are nearer to each other in an "air-line" than along the line. Such a graphic representation of the data is possible, but leads to certain inconsistencies.

If Castle's procedure is followed it leads to the placing of the same locus in two or more different places on the basis of adequate and comparable data for both positions. The two cases that Castle says furnish the crucial evi-

dence for his view demonstrate just the opposite, when complications due to crossover variations are excluded, by using only data in which three or more loci are recorded simultaneously. In his attempt to explain the all-important fact of rarity of double crossovers, Castle is obliged to assume that there is a difference in frequency of crossing over in different planes (directions). This assumption can be shown to be inconsistent with the primary assumption that he accepts, *viz.*, that crossing over is proportional to the distance between genes.

## CHAPTER XI

### LIMITATION OF THE LINKAGE GROUPS

It may be questioned whether we are at present justified in speaking of the limitation of the linkage groups to the number of chromosome pairs as one of the fundamental principles of heredity, since the only species in which a correspondence that is numerically significant between the two has been proved is *Drosophila melanogaster*. But despite the absence of other positive evidence, the fact that in no other animal or plant does the number of linkage groups exceed the number of the chromosome pairs, may be, I think, legitimately interpreted in favor of the view.

It may also be argued, that if the phenomena of linkage are assumed to be due to the genes being carried by the chromosomes, it follows that there could be no more groups of linked genes than there are chromosome pairs; hence one relation is the direct outcome of the other. But the proof of the linear order that has been developed here rests directly on the linkage data, and is independent of any assumption concerning the chromosomes. It has been shown, secondarily so to speak, that the chromosomes fulfill all the requirements of the abstract reasoning from the data, and therefore give a mechanism capable of performing all that the theory demands. The demonstration, then, that in *Drosophila* the linkage groups correspond in number to the chromosome pairs may be taken as a conclusion or a discovery independent of the other relations furnished by linkage. If then, as I anticipate will be the case, further work in other groups should show that the same relation holds everywhere, we should be fully warranted in stating the result as one of the general principles of heredity.

In *Drosophila melanogaster* the evidence is now very strong in favor of the identity in number of linkage groups and chromosome-pairs. As the new characters coming up, one after the other, have continued to fall into the four known groups, and as something like 200 characters have been so placed, and as none of them has failed to show linkage with one of the four established series, the probability is enormously in favor of a causal relation between the two events, especially in the light of the evidence from other sources that the chromosomes are the bearers of the hereditary factors—evidence from the sex-chromosomes, for example.

The only other species in which the heredity of known mutant characters approaches that of the chromosome group is the garden pea in which about 35 mutant factors have been studied. From the summary of what has been so far recorded, as well as from the results of his own work, White has recently given an account of what is fairly well established. Of the 35 mutant factors in this pea, seven independently inherited groups have been recorded, *i.e.*, each one of seven factors has been tested out and found to assort independently of the other six. There are seven pairs of chromosomes in the edible pea (Fig. 53, *a*). The agreement between the two is to date perfect. It is, of course, possible that the linkage between some of the factors tested was so loose that they appeared to give free assortment, and that until more factors have been studied the evidence is not above suspicion. Nevertheless, it is important to find that the number of independent mutant factors in *Pisum sativum* does not exceed the number of chromosome pairs.

White's study of the linkage of factors in the edible peas shows further that there are four linkage groups—three of them include factors that are also included in those that freely assort. It is fair, perhaps, to conclude that four of the possible seven-linked groups have been found. There are no other forms known in which the



number of linkage groups approaches so near the number of the chromosome pairs. In the snapdragon, Baur has described two linked groups. He states that there are 16 pairs of chromosomes. In wheat one linked group has been described. There are 8 pairs of chromosomes (Fig. 53, *b*). In Indian corn there appear to be a few linkage groups, and probably 10 pairs of chromosomes. In oats, Surface finds two linked genes. In *Primula* there is one group composed of several linked genes, and 12 pairs of chromosomes (Fig. 53, *c*).

In the silkworm moth one linked group of genes has been found by Tanaka, and Yatsu records (Fig. 55) 20 pairs of chromosomes. In *Drosophila virilis* three linked groups of genes have been found by Metz, who has also



FIG. 53.—Chromosome group of pea, *a*, wheat, *b*, and primula, *c*.

described six pairs of chromosomes for this fly. In *Drosophila busckii* there is one group of linked genes and four pairs of chromosomes. In *D. repleta* one group, and six pairs of chromosomes. The groups of chromosomes in some of the different species of *Drosophila*, as described by Metz, are shown in Fig. 54. As indicated by the arrangement of the figures (that correspond fairly closely with the actual arrangement of the chromosome in the cells themselves) it appears that one pair of chromosomes in one species is at times represented by two pairs in related species, and this view is borne out by the attachment of the spindle fibre to the middle of the chromosomes in the bent pairs, but to the inner ends of the two that supposedly correspond to its halves in other species.

In the mouse one group of linked genes has been reported. There are 20 pairs of chromosomes (Fig. 55, *b*). In man no linked genes are known, if we do not count sex-

lined genes, which must, however, if carried by the sex-chromosomes, be linked to each other. The number of chromosome pairs in man is, according to Guyer, 12 (Fig. 55, *c*), but Winewarter describes 24 pairs (Fig. 55, *d*). The difference would seem to be due to technic, rather than to differences in different races of men.

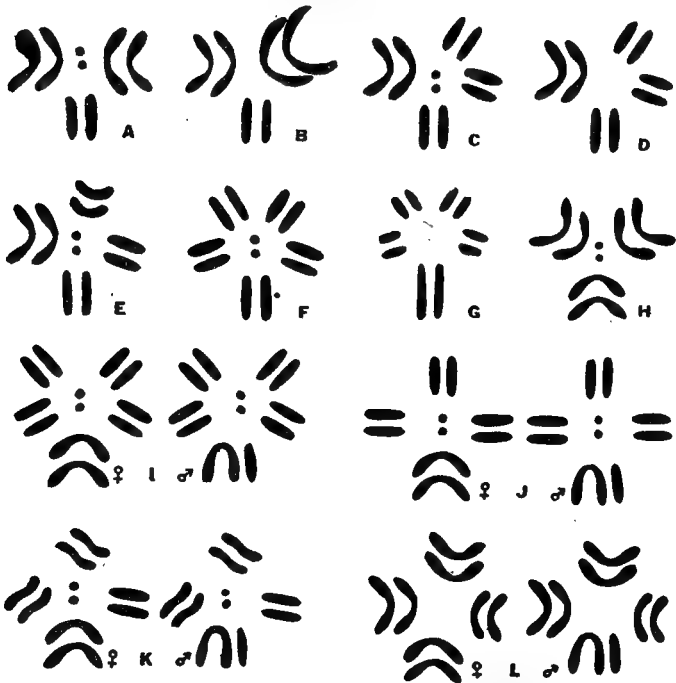

FIG. 54.—Types of chromosome groups found in *Drosophila*. A-H female groups; I-L female and male groups. In A, C, F, I, J, K, and L, the X-chromosome can be identified, because, in the male (Alex. Metz), the Y-chromosome has a different shape from the X.

It should be emphasized that it is to be expected for new types that the number of characters that may seem to give independent assortment will be found at first greater than the number of chromosomes, because wherever two genes in the same chromosome are far apart they will appear to assort independently until the discovery

of intermediate genes shows their true relation. This will be especially the case when crossing over occurs in both sexes; when it occurs only in one sex, the linkage relations are more quickly determined. Moreover, in some cases where several genes are known the mutant characters have not yet been tested out against each other but against different ones. Such information does not furnish the data that are needed.

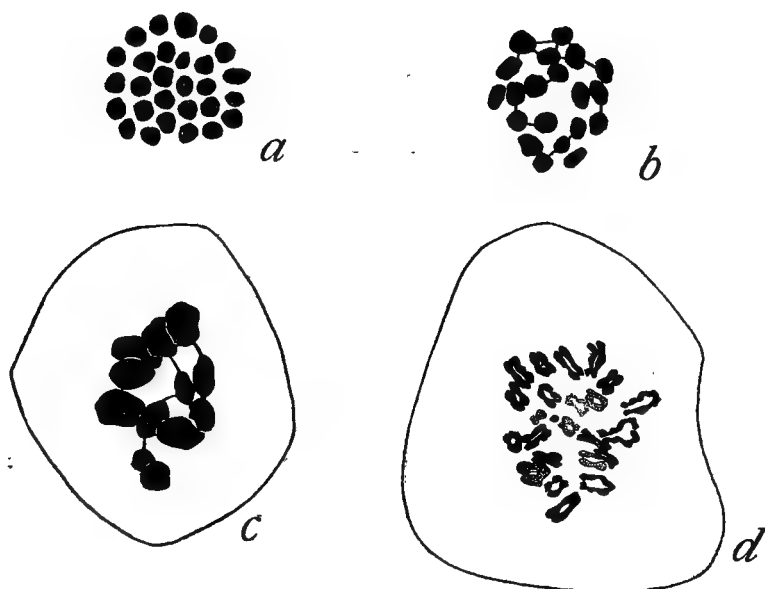

FIG. 55.—Haploid group of chromosomes of the silkworm moth (Yatsu) *a*. Haploid group of chromosomes of mouse (Yocom) *b*. Haploid group of chromosomes of man (Guyer), *c* and (von Winnewarter) *d*.

There are several forms in which there are two or more chromosomes that come together in a group at the time of segregation and move collectively to one pole. Such groups should be expected to count as a single chromosome so far as segregation is concerned, although the crossing over relations may turn out to be something different from anything as yet known.

An extension of the principle of agreement of linkage groups and chromosomes (if they are thought of only as a linear order of genes) is found in the case of "duplication" described by Bridges, where a short series of linked genes appears to lie at one end of the regular series, duplicating their number for this region of the chromosome. Obviously this is not to be looked upon so much as an exception to the principle but rather as a special case due to an accidental change in the mechanism. The number of linkage groups is not changed, but one of them has its genes duplicated for a short part of its length.

## CHAPTER XII

### VARIATION IN LINKAGE

CROSSING over is not absolutely fixed in amount, but is variable. This statement does not refer to variability in the number of crossovers due to random sampling, but to variability due to fluctuation in environmental conditions, or due to internal changes in the mechanism of crossing over itself. For example, it has been shown that the amount of crossing over in *Drosophila* is different at different temperatures, and it has also been shown that there are factors (genes) carried by the chromosomes themselves that affect the amount of crossing over. These questions, that have already been touched upon in other connections, may be taken up here in more detail.

The work of Plough on the influence of temperature on crossing over in *Drosophila*, that has already been utilized, was concerned with the influence of different temperatures on the number of crossovers obtained. It may be recalled that he found that when the eggs were subjected to a given temperature during a certain stage in their maturation the amount of crossing over that took place, as shown in the kinds of flies produced, was definite in the sense that the average results were predictable for each specific temperature, and that there are values for different temperatures which, when plotted, give the curve drawn in Fig. 56.

Further details of one of the experiments may serve to make its significance clearer. Three points (or loci) were made use of that involved three mutant genes (and their diagnostic characters, of course). Males, pure for the three mutant characters, black body color, purple eyes,

and curved wings were crossed to wild-type females. The  $F_1$  female produced in this way would be heterozygous for the three mutant factors involved in the cross. Such an  $F_1$  female was then bred to a male pure for the three recessive genes, black, purple, curved; and her offspring were kept at a given temperature until they emerged as flies, and then if necessary for some days longer in order that as many eggs as possible might have matured under the specified temperature. Controls of sisters and brothers were made in each case and kept at average "normal" temperature. In the table that follows crossing over between black and purple is indicated as "1st crossover," and between purple and curved as "2nd crossover," and between both as double crossover.

Ten different temperatures were tested. At 5° C. the eggs did not hatch, and at 35° C. the females were sterile. In the seven intermediate temperatures the results were those recorded in the next table.

b - pr - c<sup>1</sup>

Number	Temp.	Total	Female parents hatched at temperature indicated below						Weighted Value for b-pr Region
			Non-crossover	1st crossover	2nd crossover	Double crossover	1st crossover	2nd crossover	
							<i>per cent</i>	<i>per cent</i>	<i>per cent</i>
2	9°	995	643	95	218	39	13.5	25.8	13.6
3	13°	2,972	1,854	310	716	92	13.5	27.2	17.5
4	17.5°	2,870	2,021	189	610	50	8.3	23.0	8.2
5	22°	15,000	11,318	735	2,775	172	6.0	19.6	6.0
7	29°	4,269	2,993	315	898	63	8.8	22.5	8.7
8	31°	3,547	2,265	333	785	164	14.0	26.7	18.2
9	32°	4,376	2,701	513	984	178	15.7	26.5	15.4

At the two lower temperatures the crossover value is high, *i.e.*, little crossing over occurs. At the next three temperatures (17.5°, 22°, 29° C.) the crossing over value is much less, while at the last two temperatures 29° and

31° C., it is high again. The control values for sister flies, at normal temperature (22° C.), are given in the next table.

Controls—female parents hatched at 22° C.

1st cross-over	2nd cross-over	Total	Non-cross-over	1st cross-over	2nd cross-over	Double cross-over
<i>per cent</i>	<i>per cent</i>					
6.1	19.2	904	683	47	166	8
7.8	20.1	3,622	2,655	231	685	51
5.9	19.5	2,219	1,678	108	409	24
5.9	20.3	4,822	3,608	231	927	56
.....	.....	.....	.....	.....	.....	.....
.....	.....	.....	.....	.....	.....	.....

The figures given in this table were obtained as a control for the last results, and from these data the results of crossing over are reduced to the same scale. These weighted crossing-over values for the first regions give the curve drawn in Fig. 56. The curve begins at a high level and drops rapidly. The first maximum is reached at about 13° C., and then falls to 17.5° C., where the level remains nearly constant for ten degrees more (27° C.). It rises rapidly at about 28° and reaches a second maximum at 31° to 32° C. Afterwards it is seen to fall until sterility occurs at 35° C.

The temperature curve of crossing over seems to show that the phenomenon is not a simple chemical reaction, for if it were we should expect for every rise in 10° C. the amount of change in crossing over to be approximately tripled. It would appear, therefore, that the phenomena might be due to the physical state of the materials involved in crossing over. Plough calls attention to the similarity of this curve to that shown by the amount of contraction of a frog's muscle. Here there is an increase from zero to 9° C., when a maximum is reached. After this, the amount of contraction decreases, reaching a low point

between 10° C. and 20° C. It then rises rapidly, reaching a higher maximum than the first at about 28° C., after which it decreases until rigor sets in at 38° C.

The results of crossing over between purple and curved gave similar results, but the "distance" here is so great that double crossing over complicates the results; therefore they need not, for the present, be analyzed further. Attempts to change the crossing over value by starvation, moisture, increase in fermentation of the food, iron salts, etc., gave no results that seemed significant. On the other

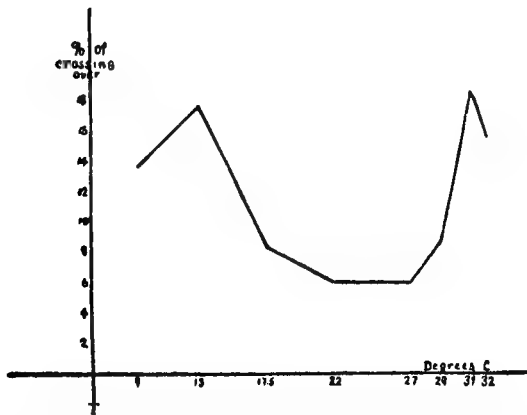

FIG. 56.—Curve showing influence of crossing over at different temperatures. (After Plough.)

hand, Bridges had already noted that a decrease in the amount of crossing over is found in second broods as compared with first broods—ten-day periods. What change in the environment is behind this "age" difference is not clear, but since most of the eggs pass through this early prematuration stage in the larvæ and some of them may reach the maturation stage in the pupa, it is possible that prevailing conditions in one or the other of these physiological states may be responsible for the difference between these states and those that prevail after the fly has hatched.



Not only external factors but internal factors, and these genetic ones, may influence the amount of crossing over that takes place. Sturtevant has discovered two such genes in the second chromosome of a certain stock of *Drosophila*. A female from a wild stock from Nova Scotia was crossed to a male showing the characters vestigial and speck. One of the daughters was tested and gave no crossovers in 99 offspring, though the vestigial, speck hybrid usually gives about 37 per cent. of crossing over. All of the descendants of this female that were

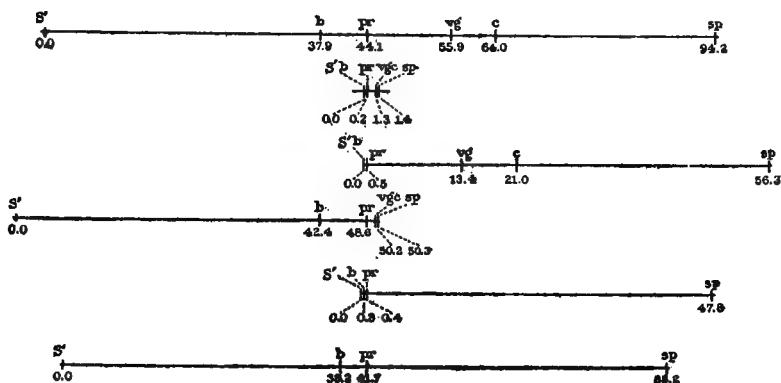

FIG. 57.—Diagram illustrating the effect on crossing over due to the presence of crossover genes. (After Sturtevant.)

known, through linkage relations, to have the Nova Scotia second chromosome, gave the same result, while those of her descendants that did not have the particular chromosome did not show such a change in linkage. These relations held regardless of whether the chromosome involved had come from the father or the mother.

A number of experiments were made with females having a Nova Scotia second chromosome, while the other second chromosome bore the mutant genes for black, purple, curved, and in other experiments other mutant genes were present. In Fig. 57 (upper line) all the genes studied, viz., star (*S*), black (*b*), purple (*pr*), vestigial (*vg*),

curved (*c*), and speck (*sp*) are indicated in their relative locations, *i.e.*, spaced in proportion to the usual amount of crossing over between them. Correspondingly, the short second line is based on the crossover relations of these factors when the female is heterozygous for the two Nova Scotia genes.

Further experiments were made with females (obtained by crossing over) in which only the "left half" of a Nova Scotia chromosome was present (third line), the other half being derived from an ordinary chromosome. The offspring of such a female showed that crossing over was decreased only in the left half.

When the right half of the Nova Scotia chromosome was present (fourth line) that half was "shortened." It follows that there are two (or possibly more) factors present, one in each half of the second chromosome of the Nova Scotia stock, each inhibiting almost completely crossing over in its own region, but not in the other region.

An equally surprising result was obtained from a female so constituted that the right halves of both members of this pair of second chromosomes were present, *i.e.*, when she was homozygous for the "right hand" pair of factors for little crossing over. Under these circumstances, the crossing over was normal for this end (last two lines). How such results are produced (quite aside from the nature of the factor producing them) is unknown. Almost inevitably, however, we think of the cause as a difference in the length or shape of the chromosome containing these factors, so that corresponding levels do not come together, hence failure of interchange. When, however, both chromosomes are affected in the same way their corresponding regions might be expected to come together and cross over.

The preceding results of Sturtevant's suggest the possibility that all genes may have an effect on crossing over—possibly one might think that in some mysterious way the crossing-over values shown by the genes are a

function of their nature. It may be well to point out that in the only cases where the evidence suffices to give an answer to such a question, that answer is very clearly against such a view. For instance, if we determine the linkage between two factors  $A$ - $M$  and then exchange one of the intermediate genes for its allelomorph, we find that in general the change has no effect on crossing over between  $A$  and  $M$ . If we exchange factors outside of  $A$  and  $M$ —either near them or far away—still no effect on crossing over between  $A$  and  $M$  is observed. If we substitute one allelomorph for another, in cases where more than two are known, we find no change in the crossing over for that level. This and other evidence shows that crossing over is quite independent of such genes, nevertheless there are other specific genes, as shown above, whose sole effect, or main effect at least, is to change the crossing-over values.

One highly important and significant result of Sturtevant's work on crossing-over factors should be noticed. The order of the factors is not in any way changed by the "shortening" process, as shown by the experiments in which three or more loci are followed at the same time.

The most remarkable fact connected with crossing over is that no crossing over at all takes place in the male of *Drosophila*, and this applies not only to sex-chromosomes ( $XY$ ) but also to the other pairs or autosomes. When the absence of crossing over was discovered for sex-linked genes, it seemed probable that this was due to the presence of only one  $X$ -chromosome in the male, for at this time Steven's work had led us to conclude that the male *Drosophila*, like some other insects, is  $XO$ . Later, when failure to cross over in the male was found in other chromosomes as well, it was evident that some more general relation was behind the phenomenon in these chromosomes at least. It is true that other genetic evidence has shown that the  $Y$ -chromosome is "empty" (*i.e.*, contains no genes dominant to any of the mutant genes as yet

discovered) and on this account one might still ascribe failure to cross over in this pair to its peculiar condition.

The interest in the situation became even greater when it was found that in the silkworm moth (in which the sex formula is reversed, so to speak) crossing over is again absent in the sex that is heterozygous for the sex factors—here the female. The female moth is apparently *ZW*, at least in two cases.

In one of the flowering plants, *Primula sinensis*, crossing over occurs in both sexes (Gregory, Altenburg), but the amount of crossing over in the pollen is somewhat different from that in the ovules. Gowen has examined Altenburg's data statistically and finds that the difference is probably significant.

That crossing over should take place in the sex that is homozygous for the sex-chromosomes (the female in *Drosophila*, the male in the silkworms) but in both sexual elements in the hermaphrodite plant (*Primula*) may appear to have a deeper significance, but more recent discoveries seem to deprive the results of any such meaning. Castle, for instance, gives data that show crossing over in the male rat (the male is probably heterozygous for the sex-chromosome), and Nabours gives data for crossing over in the male and female grouse locust, *Apotettix* (in which the male is presumably heterozygous). Until more cases are forthcoming it must seem doubtful, therefore, if any such relation as that mentioned above is a general one.

## CHAPTER XIII

### VARIATION IN THE NUMBER OF THE CHROMOSOMES AND ITS RELATION TO THE TOTALITY OF THE GENES

THE theory that the chromosomes are made up of independent self-perpetuating elements or genes that compose the entire hereditary complex of the race, and the implication contained in the theory that similar species have an immense number of genes in common, makes the numerical relation of the chromosomes in such species of unusual interest. This subject is one that could best be studied by intercrossing similar species with different numbers of chromosomes, but since this would yield significant results only in groups where the contents of the chromosomes involved were sufficiently known to follow their histories, and since as yet no such hybridizations have been made, we can only fall back on the cytological possibilities involved, and on the suggestive results that cytologists have already obtained along these lines.

A good deal of attention has been paid in recent years to the not uncommon fact that one species may have twice as many chromosomes as a closely related one. So frequent is this occurrence that it seems scarcely possible that it is due to chance. The implication is that the number of the original chromosomes has either become doubled, or else halved. If the number is simply doubled there would be at first four of each kind of chromosome from the point of view of genetic contents. This is what I understand by tetraploidy. There is some direct evidence that doubling may occur. If a new race or species is ever established in this way, we should anticipate that in the course of time changes might occur in the four identical chromosome groups so that they would come to differ

and form two different sets.<sup>1</sup> Theoretically, the number of different genes in a species might in this way be increased. If changes in the same gene in the same direction sometimes occur, as the evidence indicates that they do, then identical new mutant genes, derived from the same kind of original ones, might later arise in different pairs.

There is, however, another way in which the number of chromosomes may be doubled without doubling the number of genes. If the chromosomes break in two, double the number will be produced. It is not easy to explain how this could occur in all of the chromosomes at the same time if the process is supposed to be accidental. If it be supposed that the break first occurred accidentally in one member of the pair, it is not clear why such a broken chromosome could establish itself on the theory of chance, for the intermediate condition of one broken and one intact chromosome would seem of no apparent advantage. The same reasoning applies to the converse process, *viz.*, the coming together of chromosomes end to end which would reduce the number by half. Such a process would not increase the number of genes in the total complex. Until we know more about the physical or chemical forces that hold the genes in chains, and more about the way new genes arise, it is not worth while to speculate about the causes or probabilities of such occurrences.

What has just been said in regard to doubling and halving of the whole set of chromosomes applies also to doubling in one pair of chromosomes. If doubling occurred in one pair of a ten-chromosome type, a twelve-chromosome type would result; if in two pairs, a fourteen-chromosome type, etc. Unless tetraploidy is the simpler procedure we should *a priori* suppose that increasing (or decreasing) in pairs would, on the theory of chance alone,

---

<sup>1</sup> The question as to whether the four chromosomes involved would or would not mate at random introduces a difficulty (as shown in the *primula* case).

be the more common procedure. A few examples will illustrate what has been found out so far concerning some of these possibilities.

The evening primrose, *Oenothera lamarckiana*, has 14 chromosomes as its full or somatic number, and 7 as its reduced number (Fig. 58, *a*), and these numbers characterize most of the mutant types that De Vries found. But there is one mutant known as *gigas*, that has 28 chromosomes as its full number, and 14 as its reduced number (Fig. 58, *b*). Stomps estimates that *gigas* appears about 9 times in a million cases, *i.e.*, in 0.0009 per cent. *Gigas* is distinguished from *Lamarckiana* in many details of structure, but chiefly in its thick stem, etc., which is associated with larger cells.



FIG. 53.—Chromosome group of *Oenothera lamarckiana*, *a*; chromosome of group of *O. gigas*, *b*; triploid group, *c*.

The type breeds true, *i.e.*, it does not revert to *Lamarckiana*; thus De Vries grew a family of 450 individuals from his original *gigas*, only one being a dwarf *gigas*, *viz.*, *nanella*. The way in which *gigas* originates has been much discussed, but no conclusion reached. De Vries suggested that it is produced by an egg with 14 chromosomes (diploid), being fertilized by a sperm with 14 chromosomes, both of these diploid cells originating by the suppression of a cytoplasmic division in the development of the gametes. It has also been suggested that a tetraploid condition might arise in a spore mother cell that developed without fertilization (by apospory). Gates pointed out that by suppression of the first division of the egg, *after fertilization*, the tetraploid condition would arise. The only objection to this last view, that seems

the simplest one since such suppressed division has been seen and can be induced in animal eggs, is that the following division might be expected to be into four parts owing to the doubling of the centres.

Gregory has described two tetraploid races of *Primula sinensis*,<sup>2</sup> one of which arose from ordinary plants in the course of his experiments. Since known genetic factors were present an opportunity was given to examine into the relation between the members of the four chromosomes of a set. The possibilities involved are these: Assuming the parents to be  $AA'$ , and  $aa'$ , and that conjugation of chromosomes takes place in twos only, then if any one of the four ( $AA' aa'$ ) chromosomes of a set may mate with any other member, there will be six possible unions, *viz.*,  $AA'$ ,  $Aa$ ,  $Aa'$ ,  $A'a$ ,  $A'a'$ ,  $aa'$ . If the two derived from the same parents were the only ones that can mate, only two combinations are possible,  $AA'$ ,  $aa'$ , and if the two derived from the opposite parents were the only ones that mate only two (but different ones) could form, *viz.*,  $Aa$ ,  $A'a'$ . The genetic expectation is somewhat different for each of the three cases, since the number of different kinds of gametes produced is different in each. The data obtained by Gregory are not sufficient to give convincing evidence in favor of any one of these possibilities, although as Muller has shown by an analysis of the evidence, they are more in favor of the first possibility, *viz.*, that of random assortment. Gregory, without committing himself to the chromosome view, follows the second possibility in his analysis of the case. There is, however, nothing in the chromosome theory that would support the view that restricts the conjugation of homologous chromosomes according to their parental origins.

There are two other species of primose, *Primula floribunda* and *P. verticillata*, each with 18 chromosomes that have, after crossing, produced tetraploid types. In a

---

<sup>2</sup>Other giant races of *P. sinensis* examined by Keeble and by Gregory are diploid.



cross between these two, a hybrid called *P. kewensis* was produced, which Digby has shown has also 18 chromosomes. It produced only thrum flowers, and was therefore sterile. Five years later, after this plant had been multiplied by cuttings, one pin flower appeared which was pollinated by a thrum flower. It gave rise to the fertile race of *P. kewensis*, that had 36 chromosomes. What connection there may have been between the hybridization and the subsequent doubling, if there is any connection, is by no means clear. It may be noted that in the reciprocal cross between *P. verticillata* and *P. floribunda*, a hybrid, *P. kewensis*, with 36 chromosomes also appeared.

The most interesting results on tetraploidy are those of Elie and Emile Marchal on certain mosses, for they have been able to produce tetraploid types experimentally. It may be recalled that in mosses there is an alternation of generations. The diploid ( $2N$ ) generation is known as the sporophyte (Fig. 59) that develops out of and remains attached to the other haploid generation, the gametophyte or moss plant ( $1N$ ). The sporophyte produces a large number of spores, each containing the half number of chromosomes ( $1N$ ) as a result of reduction that has taken place in their formation, and from each spore a young moss plant develops, beginning as a protonema of loose threads. When the moss plant produces its heads or flowers the sexual organs appear—archegonia ( $\text{♀}$ ) and antheridia ( $\text{♂}$ ). Thus the “sexes” are here represented by the haploid generation.

The egg-cell, contained in the archegonium, is fertilized by a sperm-cell, the antherozoid. The fertilized egg-cell ( $2N$ ) develops *in situ* into the straight stalk imbedded at its lower end in the tissue of the moss plant, expanding at its upper end into the cup containing the spores. The mother-cells of the spores—like the tissue of the sporophyte itself—contain the  $2N$  number of chromosomes, which, by two divisions (similar to these already described for the animal cells during reduction), reduces

the number to  $1N$ . It is at this time, too, in mosses with separate sexes, that sex differentiation takes place, for as the Marchals have shown, each spore gives rise to a male

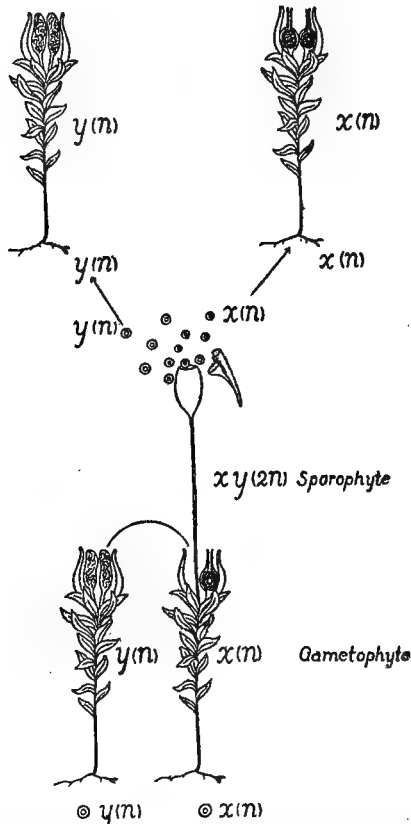

FIG. 59.—Life cycle of moss. The mycelial thread and the moss plant constitute the  $1n$ , or gametophyte generation; and the stalk and capsule (with its contained spores), arising after fertilization out of the moss plant, constitutes the  $2n$  or sporophyte generation.

or to a female thread that produces archegonia or else antheridia regardless of the condition under which the young plants are reared. Allen has recently shown in related plants—the liverworts—that during the reduction division (that gives rise to the spores) an unpaired sex-

chromosome is present that goes to half only of the spores. Presumably then in liverworts, and mosses, also, there is an internal mechanism for producing the two "sexes."

The Marchals have worked both with species having separate sexes and with hermaphrodites. We may con-

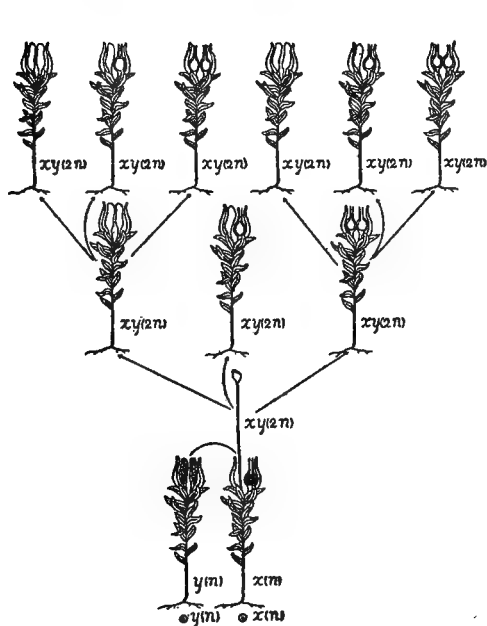

FIG. 60.

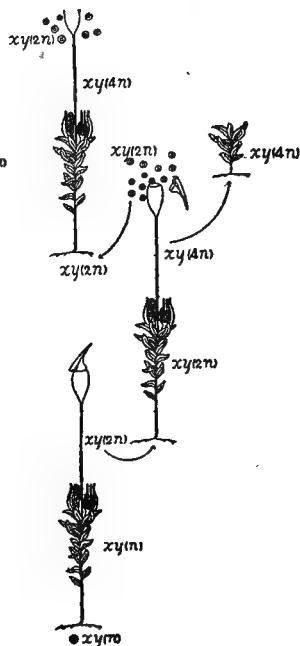

FIG. 61.

FIG. 60.—Diagram illustrating the formation of  $2n$  individuals from the regeneration of the sporophyte in a dioecious species. (According to Marchal.)

FIG. 61.—Diagram illustrating the formation of  $2n$  individuals from the regeneration of the sporophyte in a hermaphroditic species. (According to Marchal.)

sider the former first. If the sporophyte is removed and cut across, its cells regenerate a tangle of threads (protonema), which is the beginning of a new moss plant (Fig. 60). Since the sporophyte had the double number ( $2N$ ) of chromosomes, it is to be expected that the young moss plant that regenerates from its tissue (sporophyte) will also have the double number, and such proves to be the

case. The new moss-plant is therefore  $2N$  (or diploid) instead of being  $1N$ , as in the normal mode of propagation. Since no reduction has taken place into male- and female-producing individuals, it would seem possible that such a plant might produce either or both sexes. Such is the case, for when the  $2N$  moss plant produces its "flowers" some contain archegonia, others spermatogonia (with their contained germ-cells) and other flowers contain both. The hermaphroditism here produced would seem to be the sum of both the contrasted elements. The expectation from such a  $2N$  plant would be that its germ-cells ( $2N$ ) would produce a  $4N$  sporophyte—unfortunately the plants proved sterile. Imperfect germ-cells were present incapable of fertilizing or of being fertilized, so that it was not possible to perpetuate the  $2N$  plant by sexual reproduction.

The results with the  $2N$  plants derived from the regenerating sporophyte of the hermaphroditic species (Fig. 61) is different in one important respect. When, as before, a diploid ( $2N$ ) plant is obtained by regeneration from the sporophyte it produces hermaphroditic flowers, *i.e.*, flowers containing both oögonia and spermatogonia, and these are fertile. The sporophyte that they produce is tetraploid ( $4N$ ), due to the union of a diploid antherozoid with diploid egg. Regeneration from the tetraploid sporophyte ( $4N$ ) should produce fertile gametes, which might give rise by their union to an octoploid sporophyte ( $8N$ ). So far the Maréchals have not been able to produce such plants, for although in a few cases the  $4N$  sporophyte regenerated it failed to produce flowers.

The difference then between the results from mosses with separate sexes and mosses that are hermaphrodite is that the  $2N$  plant of a race with separate sexes does not form normal gametes, while a  $2N$  plant of hermaphroditic races forms fertile gametes. It may appear more or less plausible that the failure of the former is due to failure in the reduction of the spores into two alternative types,

while in the latter case, since there are presumably no such types found, there is no conflict. Some other difference would have to be appealed to to explain why the octoploid forms fail to develop.

A triploid condition ( $3N$ ) has been found to occur in certain types of the evening primrose (Stomps, Lutz, Gates). De Vries has found in crosses in which *Lamarckiana* was the mother and some other species (*muricata*, *cruciata*, etc.), the father, that triploid types appear three times in 1000 cases. He interprets the results to mean that three in 1000 times the egg-cell of *Lamarckiana* has the double number of chromosomes (14), which being fertilized by a normal pollen grain with seven chromosomes, gives the triploid number, *viz.*, twenty-one chromosomes. The same result would be reached if a diploid pollen grain fertilized a normal egg. That such pollen grains appear is as probable *a priori* as that diploid eggs occur. It may be recalled that one explanation of the tetraploid evening primrose (*gigas*) is that it arises from a  $2N$  pollen grain meeting a  $2N$  egg-cell. How reduction takes place in the triploid *œnotheras* is uncertain, since the accounts of the process are different. Geerts states that, as a rule, only seven chromosomes conjugate ( $7 + 7$ ), while the remaining seven chromosomes are irregularly distributed in the dividing germ-cells. On the other hand, Gates finds in a 21-chromosome type that the chromosomes separate into groups of 10 and 11, or occasionally into 9 and 12. The former account fits in better with results of the same kind obtained by others, and is more easily understood from a general point of view, because seven homologous pairs would correspond to the normal conjugation, while the seven chromosomes left over would have no mates and fail to divide at the reduction division, hence their erratic distribution.

It has also been shown in *œnothera* that there are three 15-chromosome types. If the 15th chromosome is

sometimes one, sometimes another chromosome, there may be genetically several types, but as yet evidence on this point is lacking.

Irregularities in the germ-cells of *Enothera* have been observed by Gates of such a kind that one cell gets 6, the

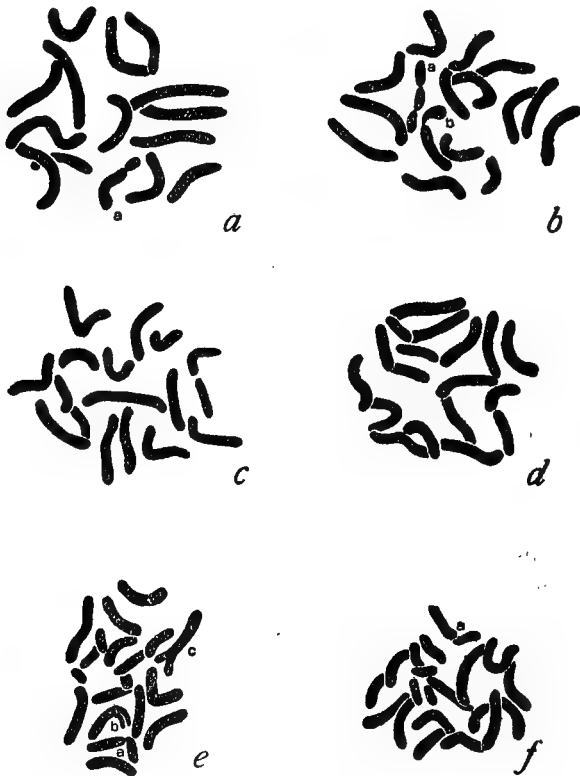

FIG. 62.—Somatic chromosomes groups of *Enothera scintillans*, showing variable numbers of chromosomes. (After Hance.)

other 8 chromosomes. A pollen grain with 8 chromosomes fertilizing an egg with 7 would give a 15-chromosome type. When such a 15-chromosome plant forms its egg-cells the supernumerary chromosome having no mate may go to either pole of the spindle, hence eggs of two

sorts would result, *viz.*, 7- and 8-chromosome cells.<sup>6</sup> Such a plant if crossed to a normal plant should give half normal (14), half 15-chromosome types. Such plants have been shown, in fact, to be produced (Lutz). Other combinations that would give 22, 23, 27, 29 chromosomes have been reported.

A variation in the number of the chromosomes of a somewhat different kind has been described by Hance for *Oenothera scintillans*, one of the 15-chromosome types of *O. Lamarckiana*. No variation in number was found in the germ-tract of the same individuals that consistently gave two types of pollen grains, one with 7 and the other with 8 chromosomes. The number of chromosomes in the somatic cells was found to vary from 15 to 21. Some of the groups are shown in Fig. 62. When the 15 chromosomes of the type-group are measured, it is found that they can be arranged in respect to length in 7 pairs, with one odd one (marked *a* in the figures). There is also found a constant length difference between the pairs. In those cases where there are more than 15 chromosomes in a cell, measurements show that the pieces can be assigned to particular chromosomes. When this is done, Fig. 63, the lengths of the chromosomes come out as in the typical cells. There can be no doubt that the extra chromosomes in these cases represent pieces that have broken off from typical chromosomes. This process of fragmentation does not destroy the "individuality of the chromosomes" since the increase in this way of the number of chromosomes would not lead to any immediate change in the number of the genes. The peculiarity of the mutant *O. scintillans* is not connected with the increase in the number of its chromosome bodies, but rather to the presence of a 15th chromosome.

Bridges has called attention to a peculiar case in *Drosophila* (1917) in which an individual behaves as

---

<sup>6</sup> No pollen is produced by most of the lata plants.

though a piece of the X-chromosome (recognizable from its genes that normally lie in the middle of the chromosome) had become attached to one end of the other X-chromosome. Owing to this piece (including the region that contains the normal allelomorphs of vermilion and sable) the individuals give unexpected results in relation to dominance or recessiveness of certain factors. For example,

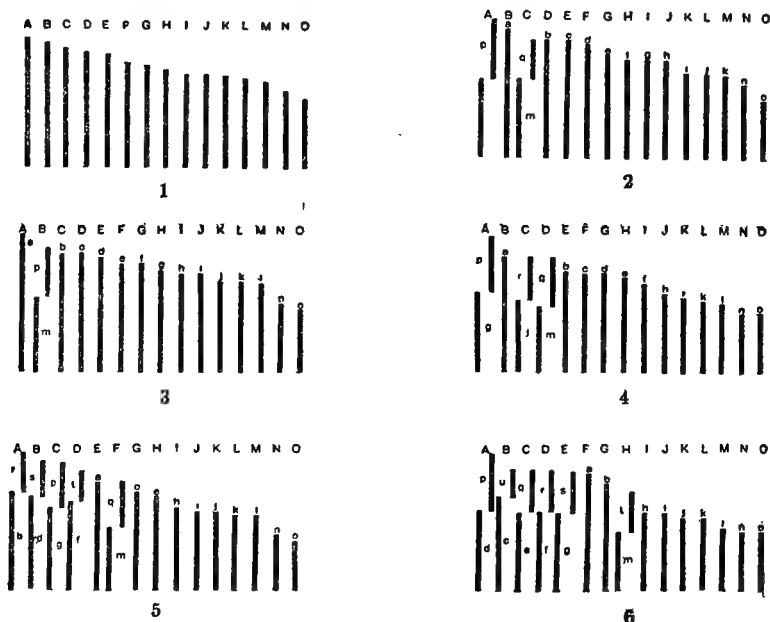

FIG. 63.—Scheme showing the probable relation between the extra chromosome pieces of Fig. 62, and the normal 15 chromosomes of this mutant. (After Hanse.)

a male that contains the recessive genes for vermilion and for sable, normally located, and having attached to this chromosome the duplicated piece (containing the normal allelomorphs of vermilion and sable) is in appearance a wild-type fly, instead of being vermilion sable as it would otherwise be without the piece. On the other hand, a female having one such chromosome and a normal vermilion sable chromosome is in appearance not wild type



(as might have been expected), but shows vermilion and sable, because in this case the two recessive genes for vermilion and for sable dominate the single normal allelomorphs. But a female having two such duplicated chromosomes (*i.e.*, tetraploid for the genes of certain regions of the sex-chromosome) is now wild type in appearance, because the two dominants dominate the two recessives. Such a female crossed to a vermilion sable male gives wild-type sons and vermilion sable daughters, which is criss-cross inheritance in an opposite sense from that ordinarily met with in *Drosophila*.

A second instance discovered by Bridges, but not yet reported, seems best explained on the assumption that a piece taken from the second chromosome has become attached to the middle of the third chromosome. This condition makes possible the linkage of mutant characters to genes in both the second and the third chromosome at the same time. The second chromosome that lost a piece, and the third chromosome that gained the piece (both were of course in the same cell), have been easily kept together in the same stock ever since, because in those cases where they become separated through assortment every zygote that receives the deficient (2nd) chromosome dies unless the same zygote has received the third chromosome with the duplicate piece.

The preceding results show that chromosomes may not only gain genes by the attachment of pieces (duplication), but also that chromosomes may lose pieces (deficiency).

Other instances of deficiency have been reported by Bridges which can be explained either as total losses of certain regions, or due to their inactivation. Unless the lost pieces happen to have been retained as in the last case, the distinction between these possibilities is difficult. A study of one case has shown that no crossing over takes place in the region of deficiency, although the rest of the chromosome was little or not at all affected. As a result

the chromosome is "shortened" by an amount corresponding to the "length" of the deficient region.

It is not without interest to notice that in the first case the duplicating piece is attached to that end of the first chromosome where the spindle fibre is attached. In the other case the duplicating piece is attached to the

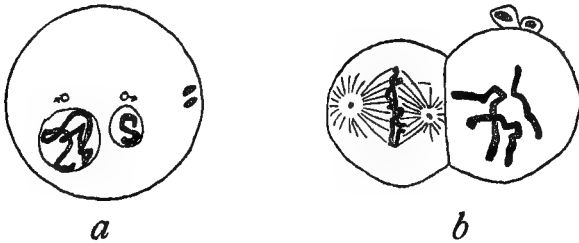

FIG. 64.—An egg of *Ascaris bivalens* fertilized by sperm of *A. univalens*, a; later stage of same, b.

middle of the third chromosome, and in this chromosome the spindle fibre is attached to the middle.

An interesting case of triploidy has been reported in the threadworm *Ascaris* (Boveri). Two varieties occur, one with four chromosomes (haploid two), and one with two (haploid one). Rarely a female of one variety is



FIG. 65.—Diploid and haploid groups of the sundew *Drosera*. (After Rosenberg.)

found that has mated with a male of the other variety. The fertilized eggs have each three chromosomes (Fig. 64). As yet no triploid adults have been met with, so that the method of conjugation of the chromosomes in the triploid types is not known.

Rosenberg crossed two species of sundew, *Drosera longifolia*, with 40 chromosomes (haploid 20), and *D. rotundifolia*, with 20 chromosomes (haploid 10), Fig. 65.

The hybrid had 30 chromosomes (20+10). He found that when this hybrid produces its germ-cells they show, after reduction, 20 chromosomes, which he interprets as due to 10 of the rotundifolia conjugating with 10 of the longifolia. This leaves 10 without mates. At the following maturation division Rosenberg describes the 10 paired chromosomes as reducing, sending one member of each dyad to one pole, the other member to the other; but the

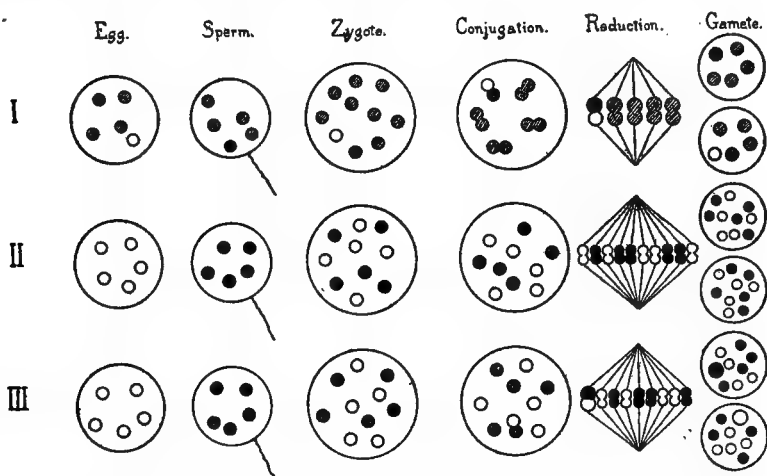

FIG. 66.—A scheme illustrating the fertilization of the egg of one species of moth by the sperm of another, with reduction in I, with no reduction in II, and with partial reduction in III.

10 unpaired chromosomes are irregularly distributed at this division. If the account is confirmed, the situation is peculiar, for if the 20 (haploid) chromosomes of longifolia correspond to the 10 (haploid) of rotundifolia it is not obvious why all 20 might not find a place alongside of the 10, unless chance or some difference of length, etc., makes this impossible. This assumes, however, that longifolia is not tetraploid—if it is, then a further question arises as to which chromosomes of each set of three would be the ones most likely to conjugate, etc.

Crosses between three species of the moth *Pygæra*,

having different chromosomes, were made by Federley. The hybrids showed intermixed characters of both parents, and their chromosome number was the sum of the haploid numbers of their parents (Fig. 66).

No reduction in number of the chromosomes takes place in the hybrid at the synaptic stage (except perhaps for one or two small ones), so that the 1st spermatocytes contain nearly the sum of the haploid number of the

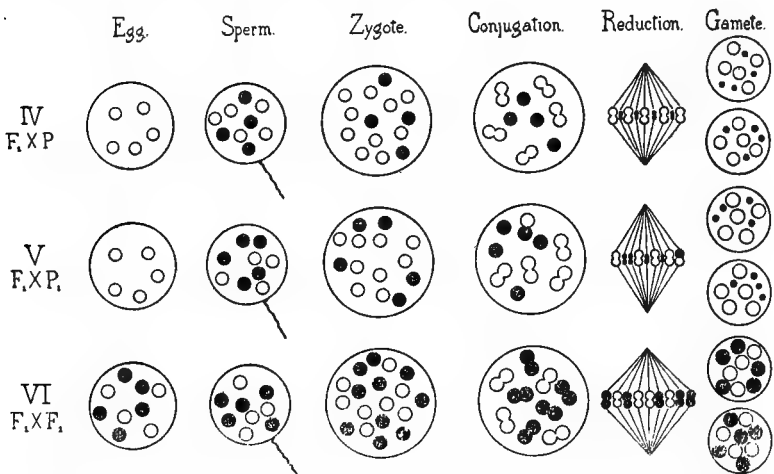

FIG. 67.—Scheme illustrating the history of the chromosomes, and the back-cross between a hybrid male and one or the other parent; also between two such hybrid F<sub>1</sub> individuals.

parents (*A* and *B*) after division of each chromosome (Fig. 67). A second maturation division follows in which each chromosome again divides. As a result each sperm contains the full number of chromosomes, half paternal, half maternal (*A* and *B*). The hybrid female is sterile, but the male is fertile. If he is back-crossed to a female of the *A* race his sperm, carrying both sets of chromosomes, will produce a  $3N$  individual,  $A + B + A$ . It will have two sets of the *A* genes to one set of *B*. In appearance the moth is practically the same as the F<sub>1</sub> hybrid, because both contain both sets of chromosomes—the

double set  $AA$  with  $B$  not producing any striking difference from the single set  $A+B$ . When this second hybrid ( $3N$ ) matures its germ-cells, the two homologous series ( $A + A$ ) mate with each other, and then segregate at the first division, while the unmated  $B$ -series simply divides. At the second division both the  $A$ - and the  $B$ -series divide, thus giving to each sperm a haploid set of chromosomes ( $A + B$ ). The sperm then is the same as the sperm of the first hybrid. So long as the back-crossing continues the outcome is expected to be the same.

If, instead of back-crossing the first hybrid to parent  $A$ , it is back-crossed to parent  $B$ , the same result as before takes place, except that the second hybrid is now  $A+B+B$ . When it matures its germ-cells, the  $B$ 's unite and then separate, giving  $AB$  sperm as before.

Here then we find a kind of inheritance that superficially appears to contradict the generality of Mendel's law of segregation. On the contrary, a knowledge of the chromosomal behavior shows that the results are different because the mechanism of conjugation of the chromosomes is changed, and changed moreover in such a way that on the chromosome theory itself the results are what are to be expected.

These crosses are so important that some further details may be added. The whole ( $2N$ ) and half ( $1N$ ) number of chromosomes of the three species studied by Federley are as follows:

	Whole	Half
Pygaera anachoreta.....	60	30
Pygaera curtula.....	58	29
Pygaera pigra.....	46	23

In the hybrid between the first two species the number of spermatocyte chromosomes was found to be 59 ( $30 + 29$ ). No union between any of the maternal and paternal chromosomes could have taken place. But in the hybrid formed by the union of the two more nearly related species, *curtula* and *pigra*, the number of spermatocyte chro-

mosomes was found to be as a rule somewhat smaller than the sum of the parental haploid numbers, indicating that one or more had conjugated. To the extent to which such union, and the consequent reduction, takes place, the characters of the second hybrid generation may differ from those of the first—at least if the conjugating pairs have different factors in them.

A similar behavior of the chromosomes has been described by Doncaster and Harrison for two species of moth of the genus *Biston* (Fig. 24). The hybrids were sterile, and no further generations were raised.

Federley later made similar crosses with three other moths. A cross between *Smerinthus ocellata* (with 27 chromosomes as the haploid number) and *Dilina tilia* (with 29) he regards as a cross between genera. A cross between *S. ocellata* and *S. populi* (with 28) he regards as a species cross. A cross between *S. ocellata* and *S. ocellata* var. *planus* he regards as a racial, or varietal, cross. As before the spermatocytes of the hybrid have the sum of the two parental numbers of chromosomes (or a few less at most). In other words, conjugation of the chromosomes does not take place. The most unexpected result in these combinations is that the types that are so alike as to be classified as varieties behave as regards conjugation like the other two combinations. The results suggest that ordinary conjugation may not be due to the similarity of the sets of genes carried by the chromosomes so much as to other peculiarities of the combination.

## CHAPTER XIV

### SEX-CHROMOSOMES AND SEX-LINKED INHERITANCE

THE discovery that the female in certain species of animals has two  $X$ -chromosomes and the male has only one  $X$ -chromosome, either with a  $Y$ -chromosome in addition (Stevens) or without the  $Y$  (Wilson), established a view first suggested by McClung that the difference between the sexes is connected with the distribution of particular chromosomes. Two interpretations of the facts have been proposed: The first, and most obvious one, was that the presence of two sex-chromosomes ( $XX$ ), in connection with the rest of the cell complex, causes a female to develop; while only one sex-chromosome ( $X$ ) in connection with the rest of the cell causes a male to develop; the second interpretation was that of  $XX$  and  $X$  are merely indices of sex, *i.e.*, that the sex-chromosomes follow sex and do not determine sex.

It is now possible to show that sex follows the chromosomes and not the reverse, because if a "female producing" sperm ( $X$ ) fertilizes an egg without an  $X$  (as exceptionally occurs) an  $XO$  individual is produced that is a male, whereas if this same sperm had fertilized an egg with an  $X$ , giving an  $XX$  individual, a female would be the result. Conversely when a "male producing"  $Y$ -sperm fertilizes an egg with two  $X$ 's (as exceptionally occurs) an individual is produced that is a female, despite the presence in her of a  $Y$ -chromosome.

#### THE SEX-CHROMOSOME

It will be convenient to treat the  $XX$ - $XY$  type of combination first. I shall follow the usual custom of calling both  $X$  and  $Y$  sex-chromosomes.

At the time when the polar bodies are extruded from the egg, the two X's separate, one passing out, the other remaining in the egg. Every egg is left with one X (Fig. 68).

In the male, the X and Y conjugate and separate at one of the maturation divisions, so that each sperm contains either an X- or a Y-chromosome (Fig. 68). Fertilization of any egg (X) by an X-bearing sperm produces a female

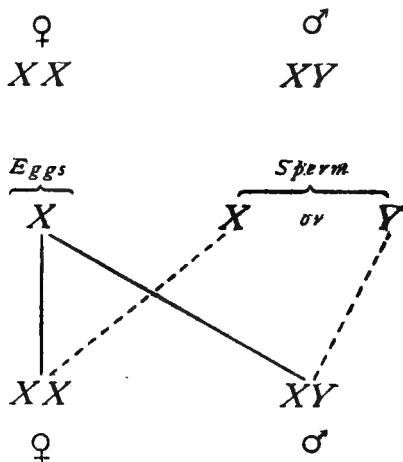

FIG. 68.—Scheme showing the relation of the sex-chromosome to sex-determination. XX-XY type.

(XX). Fertilization of any egg (X) by a Y-bearing sperm produces a male (XY).

Since the two kinds of spermatozoa are produced in equal numbers, females and males will be equal in number. The mechanism is self-perpetuating.

#### THE INHERITANCE OF FACTORS CARRIED BY THE SEX-CHROMOSOMES IN THE DROSOPHILA TYPE

Since the son gets his one X-chromosome from his mother, and the Y from his father, he inherits factors carried by the sex-chromosomes in a different way from



the way in which he inherits the factors carried by the other chromosomes (autosomes), because  $X$  and  $Y$  differ from each other in a way in which no other chromosomes differ.

The recessive gene for white eyes ( $w$ ) in *Drosophila* is carried by the  $X$ -chromosome. It is inherited in the following way (Fig. 69): When a male with white eyes ( $w$ ) is mated to a red-eyed female ( $WW$ ), the  $F_1$  sons and daughters have red eyes. When these are bred to each other, all the daughters have red eyes (50 per cent.), half the sons have red eyes (25 per cent.) and half the sons have white eyes (25 per cent.). The ratio, irrespective of sex, is three red to one white, but the white-eyed flies are found only amongst the males. In the diagram (Fig. 69), the relation of these results to the sex-chromosomes is shown. The  $X$ -chromosome that carries the normal gene (wild type) which gives red eyes is indicated by  $W$ . The  $X$ -chromosome that carries the gene for white eyes is indicated by  $w$ . The rod with a bent end stands for the  $Y$ -chromosome.

The  $F_1$  daughters contain one of each kind of  $X$ -chromosome. The  $F_1$  sons only one kind. The recombinations that give the  $F_2$  results are shown in the middle of the lower part of the diagram. Half of the females are seen to be homozygous for the wild-type gene ( $W$ ). They should never transmit white eyes, and they do not. The other half of the females are heterozygous ( $Ww$ ), and if mated to a white-eyed male should give 50 per cent. red-eyed males and females, and 50 per cent. white-eyed males and females. This they do. The red  $F_2$  sons ( $W$ ) should never transmit white eyes, nor the white-eyed sons ( $w$ ) transmit red eyes. These relations are also known to hold.

The reciprocal cross (Fig. 70), *viz.*, a white-eyed female ( $ww$ ) to a red-eyed male ( $W$ ) gives red-eyed daughters ( $wW$ ) and white-eyed sons ( $w$ ). If these  $F_1$ 's

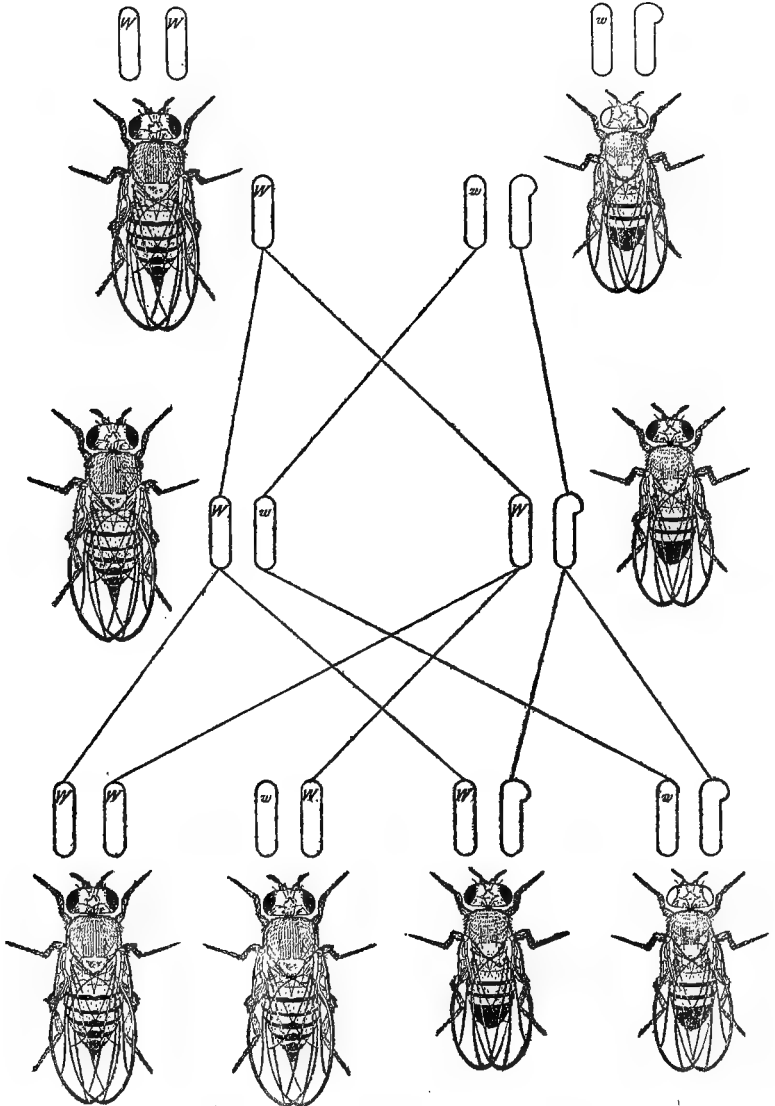

FIG. 89.—Cross between white-eyed male and a red-eyed female of the vinegar fly.

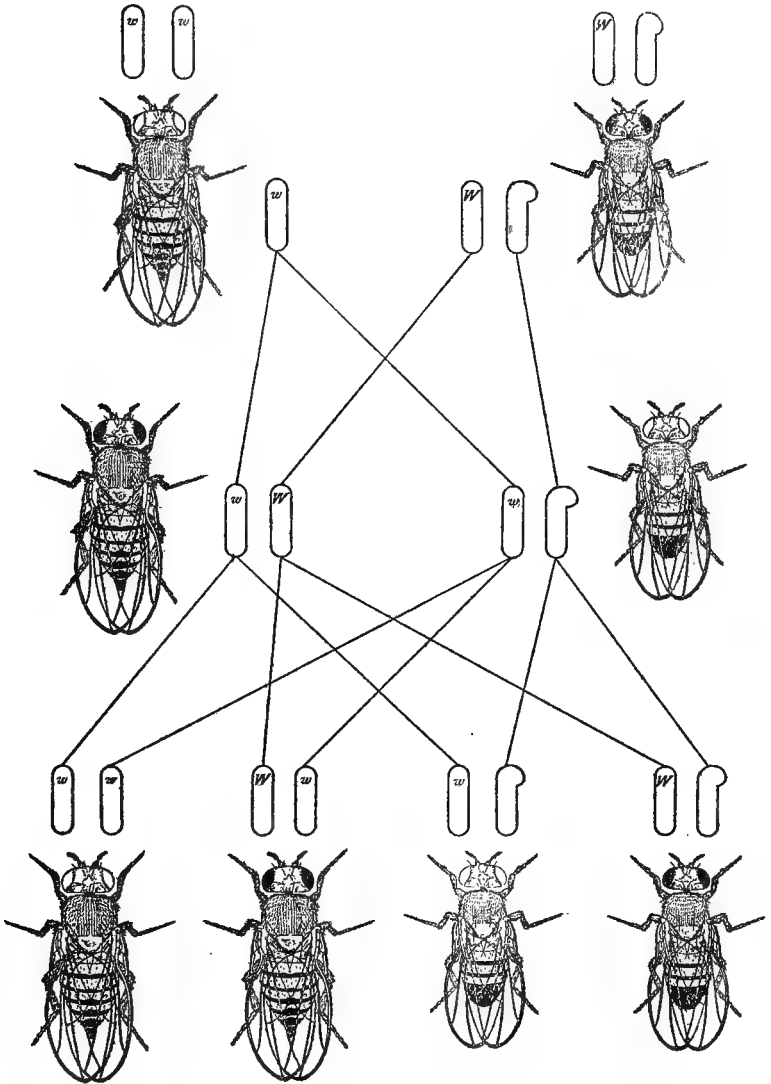

FIG. 70.—Cross between white-eyed female and a red-eyed male of the vinegar fly.

are bred together, the results are as follows: Half the daughters have white eyes ( $w w$ ), half red eyes ( $w W$ ); half the sons have white eyes ( $w$ ), half red eyes ( $W$ ). It will be seen that the red-eyed  $F_2$  daughters are all heterozygous, and should give 50 per cent. white and 50 per cent. red offspring if mated to white-eyed males. This occurs.

Similar illustrations might be given for any of the 50 sex-linked characters of *Drosophila*. Of these the sex-linked lethals form the most interesting cases and will be spoken of in another connection.

Despite the fact that the results in one of the two foregoing crosses gave a 3:1 ratio, and in its reciprocal a 1:1 ratio, the results in both cases conform to Mendel's first law of segregation. The peculiarity of the 1:1 ratio is due to the fact that the  $P_1$  red-eyed male is in a sense heterozygous for the wild-type eye color (since he has but one X-chromosome that carries the factor for red eyes). Since in the second cross the  $F_1$  male gets no red-producing X from either parent, he is pure for white eyes in the sense that he has an X bearing the factor for white eyes and a Y that bears no factor making red. Hence this  $F_1$  cross is exactly like a back-cross of a heterozygous female to a recessive male, and gives the same numerical result, *viz.*, 1:1.

Cases of sex-linked inheritance of this kind are also known in man. Color blindness in man appears to follow exactly the same procedure as sex-linked inheritance in the vinegar fly—at least certain kinds of color blindness have been shown to do so. Hæmophilia also is sex-linked, and there are four or five other defects in man that appear to come under this head. According to several accounts there is an unpaired sex-chromosome (or two of them) in man, which is also called for by the genetic evidence relating to sex-linkage in man, but since the female number of chromosomes in man is stated by Guyer to be 24, and by von Winiwarter to be 48, it is unsafe as yet to appeal

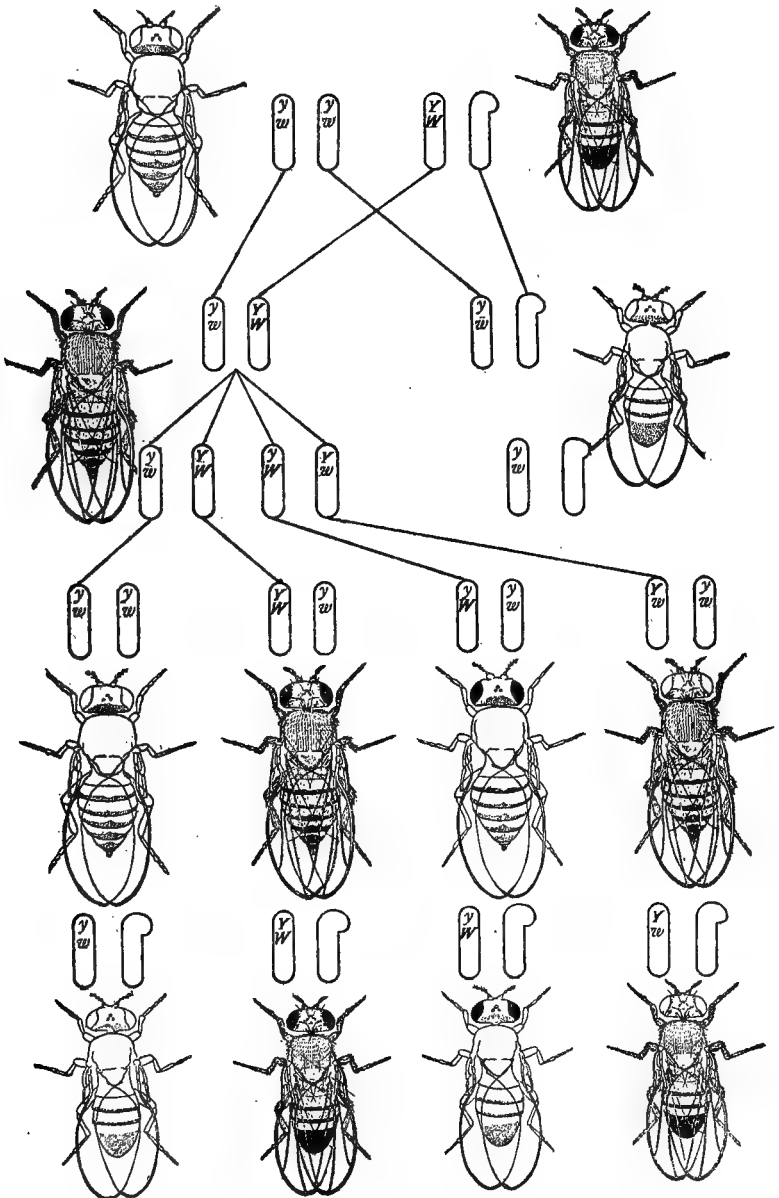

FIG. 71.—Cross between a yellow, white-eyed female and a wild-type ("gray"), red-eyed male.

to this evidence as showing the identity of the sex-determining mechanism of man and the vinegar fly.

When two or more sex-linked characters are involved at the same time, the situation is different only in so far as crossing over may take place in the female. It will be simpler to consider such a cross and its reciprocal in the reverse order from that just given. If a female with yellow wings ( $yy$ ) and white eyes ( $ww$ ) is crossed to a wild-type male, "gray" wings ( $Y$ ) and red eyes ( $W$ ), the sons are yellow white and the daughters are gray red (Fig. 71). When these are inbred there are four types in  $F_2$  (ignoring sex), *viz.*, the two original combinations yellow white and gray red, and the two crossover combinations yellow red and gray white. They occur in the following ratios:

Yellow white	Gray red	Yellow red	Gray white
99 per cent.		1 per cent.	

In this case the  $F_1$  male acts as a double recessive, revealing the amount of crossing over in the  $F_1$  female. Since neither his female-producing nor his male-producing sperms carry factors that cover up the characters carried by the four classes of gametes in the  $F_1$  female, all four classes of her gametes are revealed in their numerical proportions. Reciprocally, when a male with yellow wings ( $y$ ) and white eyes ( $w$ ) is crossed to a wild-type female (gray ( $YY$ ) red ( $WW$ )), both sons and daughters are gray red, because both get the dominating genes for these characters carried by the X-chromosome received from the mother. If these  $F_1$ 's are inbred (Fig. 72), the  $F_2$  females are gray red, since each contains an X with the two dominant genes derived from the father whose genes have remained completely linked, as there is no crossing over in the male. On the other hand, there are four kinds of  $F_2$  males: yellow white; gray red; yellow red; gray white; because each male shows the

character of his single X-chromosome, and there are four kinds of these chromosomes in his mother on account of crossing over in the female. The other sex-chromosome, the Y, has no dominating influence.

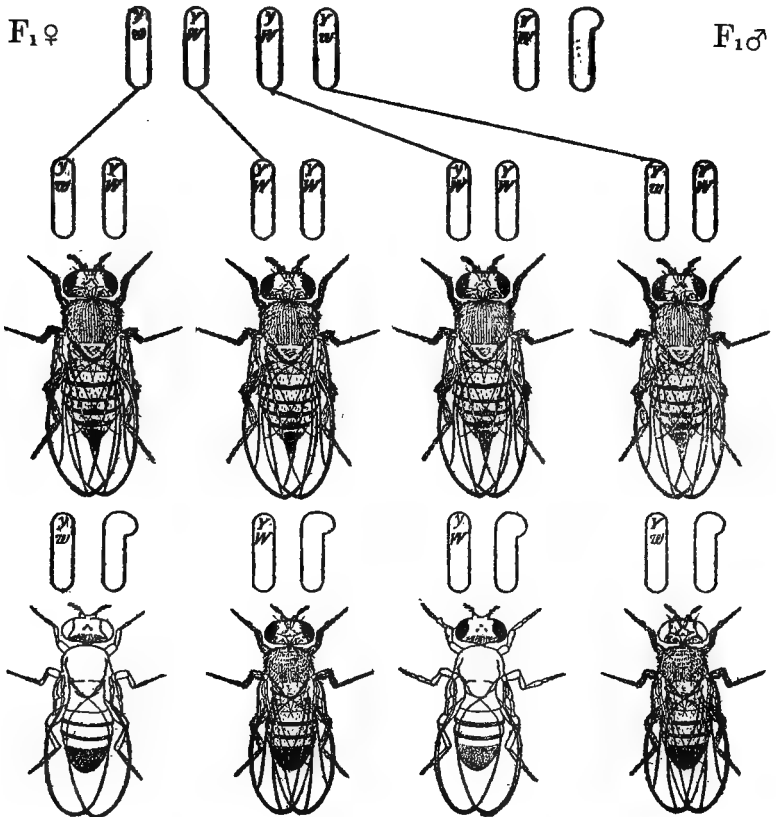

FIG. 72.—The F<sub>2</sub> results from the reciprocal cross of that shown in Fig. 71.

**SEX-LINKED INHERITANCE OF THE ABRAXAS TYPE**

In certain moths and birds it has been shown by the genetic evidence that the female is heterozygous for sex-linked factors. The cytological evidence, as far as it goes, supports this evidence, but for birds the material is so

difficult to interpret that Guyer's conclusions do not seem to me as yet to be on as secure grounds as those of Seiler's for moths. Both descriptions give, however, the bases for a consistent explanation of sex-linked inheritance in this type ( $WZ-ZZ$ ).

Since we do not know as yet whether the same or different sex factors are involved in the *Drosophila* and in the *Abaxas* types, it seems best not to use the same sym-

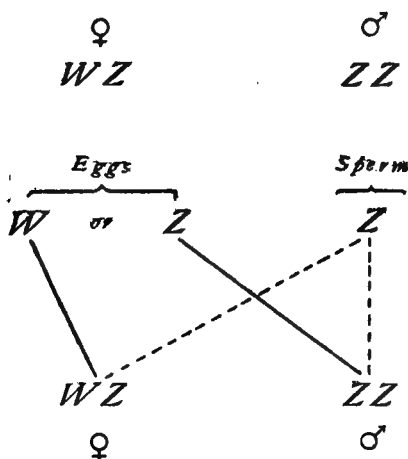

Fig. 73.—Scheme showing the relation of the sex-chromosomes of the moth (and of the bird) in sex-determination.  $WZ-ZZ$  type.

bols in both for the sex-factors. If in both types a single sex-factor is concerned, and if it is the same in both, the conditions that make for a female in one case and for a male in the other must be due to a difference in the rest of the hereditary complex that reverses the reaction. It would appear simpler to assume that the sex-factor itself is different in the two cases. If there is more than one factor for sex, the two types may have some in common, but the theoretical situation would remain the same. For our present purpose these possible distinctions are of no importance.



If the sex-chromosome that carries the sex-linked genes in birds and moths be symbolized by  $Z$ , and its homologue that occurs in the female by  $W$ , the scheme for sex-determination is that shown in Fig. 73: The eggs of the female extrude either one or the other sex-chromosome. If  $Z$  stays in, and this egg is fertilized by a sperm ( $Z$ -bearing

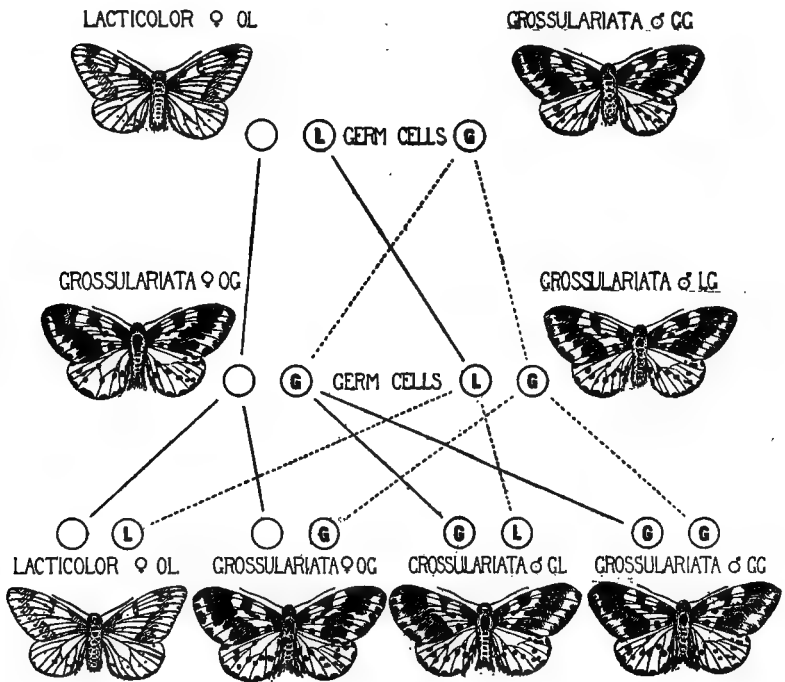

FIG. 74.—Cross between *Abraxas lacticolor* female and *grossulariata* male.

also) a male ( $ZZ$ ) is produced; if  $W$  stays in, and the egg is fertilized by a  $Z$ -bearing sperm, a female ( $WZ$ ) is produced. The way in which sex-linked characters are transmitted may be illustrated by the inheritance of a color difference in the currant moth *Abraxas*. The wild species (*grossulariata*) has a mutational variety called *lacticolor*, that differs from the former by having less

black pigment in the wings. When a dark (*grossulariata*) male is mated to a light (*lacticolor*) female, both sons and daughters are dark (Fig. 74). If these are inbred all the  $F_2$  sons are dark, half the daughters are dark, half light. As the diagram shows, the distribution of the *Z*-chromosome furnishes the mechanism by means of which we can

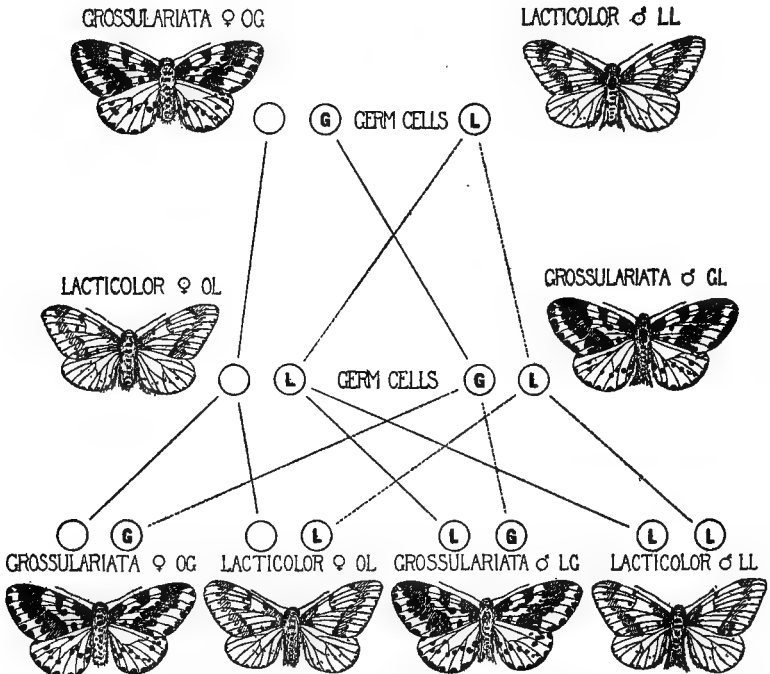

FIG. 75.—Cross between *Abraxas grossulariata* female and *lacticolor* male.

explain, as in *Drosophila*, the process of sex-linked inheritance in this moth.

The reciprocal cross is shown in the next diagram (Fig. 75) in which a dark (*gross.*) female is mated to a light (*lact.*) male. The daughters are light like the father, the sons dark like the mother—criss-cross inheritance. The daughters get their one *Z*-chromosome carrying the light

factor from their father, the sons get in addition to a light  $Z$  from their father a dark dominating  $Z$  from their mother. When the  $F_1$ 's are bred together four classes result in the proportion of 1:1:1:1, when sex is taken into consideration, or in the ratio 1:1 for the color differences alone.

According to Doncaster, the male and the female *Abraxas* have each 56 chromosomes, *i.e.*, the female is  $ZW$  rather than  $ZO$ ; but as yet the sex-chromosomes as such have not been identified. That sex is connected with such chromosomes is not only established by sex-linked inheritance, but is also indicated by an aberrant race of *Abraxas* found by Doncaster. The males of the race had the normal number of chromosomes (56), but the females had only 55 chromosomes. Doncaster found that in these females an unpaired chromosome, presumably the  $Z$ -chromosome, was more often thrown out into the polar body than left in the egg, so that most of the resulting eggs had only 27 chromosomes. Any egg of this kind fertilized by a spermatozoön should give a 55-chromosome individual, *i.e.*, a female. The few eggs that retained the unpaired  $Z$ -chromosome, fertilized by a  $Z$ -spermatozoön, would be expected to give rise to the rare males, which like normal males have 56 chromosomes. The excess of females is thus accounted for, and incidentally the results show that the  $W$ -chromosome carries no essential factors for the life of the individual, since females without it develop and look like normal females. Probably it is empty as is the  $Y$  of *Drosophila*.

In poultry there are several cases of sex-linked inheritance that follow the *Abraxas* type. One of the most striking cases is the cross between Barred Plymouth Rock and Langshan. When a barred male is crossed to a black female, the sons and daughters are barred (Fig. 76). Barring is dominant to black. Two such  $F_1$ 's, inbred, give all barred males; half the hens are barred, half are black. It may be said here that the black grandmother transmits

her black color to only half of her grandsons. The chromosomal explanation can obviously be worked out on the same scheme as in *Abraxas* (Fig. 77). But if Guyer's recent account of spermatogenesis in birds is correct, the situation is different. Guyer describes the ripening of the sperm as follows: There are 18 chromosomes in the male, including two large  $Z$ 's ( $16 + 2$ ). After synapsis there are 9 double chromosomes in the first spermatocyte, all of which, except  $ZZ$  separate at the first maturation division, 8 going to one pole and 8 to the other. One

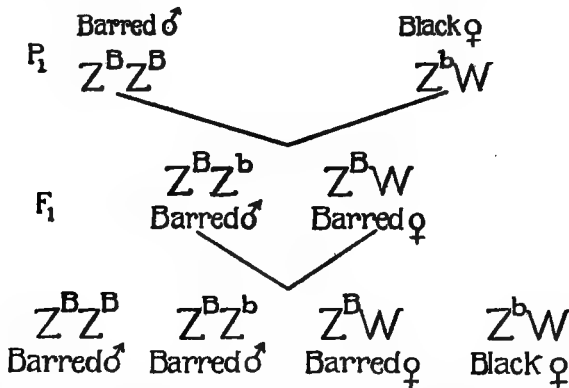

FIG. 77.—Scheme showing the transmission of the sex-linked characters B = barred, and b = black in the cross shown in Fig. 76.

daughter cell gets both  $Z$ 's ( $8 + 2$ ). This cell then divides again, the  $Z$ 's presumably separating so that two second spermatocytes are produced, each with 9 chromosomes ( $8 + 1$ ), including the  $Z$ . These become the functional sperm. The other spermatocyte, the one without a  $Z$ , may divide again, but it, or its products, degenerate, and never produce sperm. According to Guyer, there are 17 chromosomes in the female, including one  $Z$ . Presumably, then, after reduction half of the eggs will contain a  $Z$  ( $8 + 1$ ), the other half will be without it ( $8$ ). The egg that carries a  $Z$  ( $8 + 1$ ), fertilized by a sperm (each sperm carries a  $Z$  ( $8 + 1$ )), will make a male with 18 chromo-

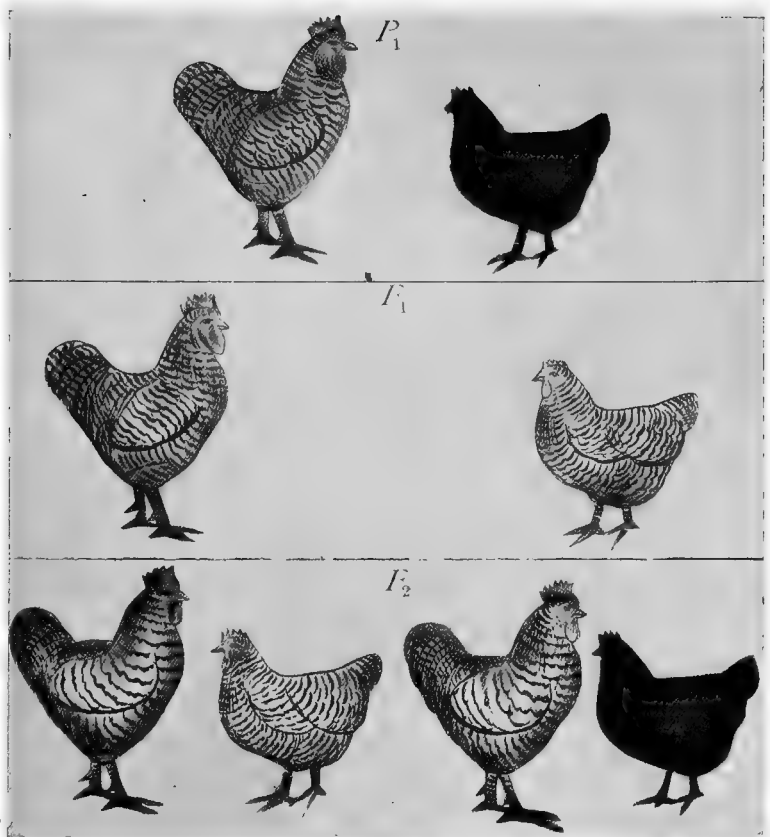

FIG. 76.—Cross between Barred Plymouth Rock male and Black Langshan female.



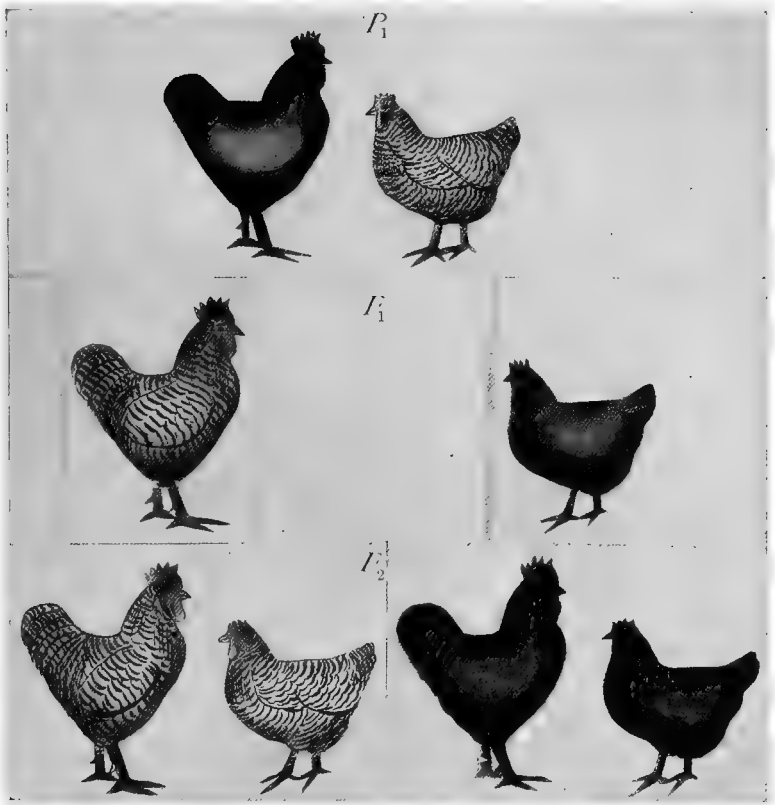

FIG. 78.—Cross between Black Langshan male and Barred Plymouth Rock female.





somes, including two  $Z$ 's. The egg that lacks a  $Z$  (8), fertilized by a sperm (8 + 1), makes a female with 17 chromosomes, including one  $Z$ .

This scheme gives consistent results for sex-linked inheritance in birds. Since the daughter gets her single  $Z$ -chromosome from her father, she will show any sex-linked characters carried by his  $Z$ -chromosome. If the father carries a sex-linked dominant gene his sons and his daughters will be alike. It should be noticed that while Guyer's scheme gives the same results so far as sex-link-

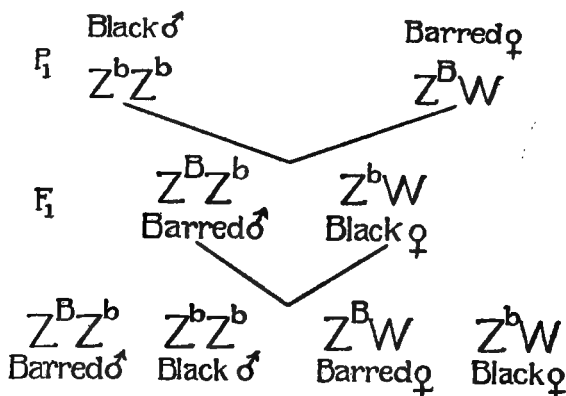

Fig. 79.—Scheme showing the transmission of the sex-linked characters B=barred, and b=black in the cross shown in Fig. 78.

age is concerned, as the one described by Seiler for some moths, the machinery in the male is different in the two cases, while that in the female is presumably the same. In both the female is heterozygous for  $Z$ ; in the moth the male is homozygous ( $ZZ$ ), but in the bird the two  $Z$ 's described by Guyer both go to one pole at one of the maturation divisions, and reduce at the other—a procedure not known in any other animal.

In the reciprocal cross (Fig. 78) a black cock is bred to a barred hen. The sons are barred—like their mother—the daughters are black—like their father, criss-cross inheritance. When the barred  $F_1$  cock and the black hen

are inbred, there are four  $F_2$  classes with sex taken into account in the proportion of 1:1:1:1; or ignoring sex, 1 barred to 1 black. The barred and the black races differ by one factor difference (Fig. 79), *viz.*, barred  $Z^B$  and its normal recessive allelomorph  $Z^b$ . This seems to mean that the Barred Plymouth Rocks is a black race with an additional dominant factor for barring. The Black Langshan is the same black race but without the barring factor.

Until quite recently no cases of crossing over had been observed in forms having the *Abraxas* type of sex-linked inheritance, for, except in one or two cases in poultry, only a single pair of sex-linked genes were known, and two at least must be studied together in order to demonstrate linkage. Goodale has recently studied two sex-linked characters in poultry, and states that crossing over occurs in the male, but whether or not in the female is not stated.

#### SEX-DETERMINATION AND NATURAL PARTHENOGENESIS

Variations in the ordinary sex-determining mechanism account in some cases for the normal output of males and females produced by parthenogenesis, and determine the exceptional sex-ratios of such species. The honey bee furnishes the best known example. The queen comes from a fertilized egg, and has therefore the double ( $2N$ ) number of chromosomes. Her eggs give off two polar bodies, hence have the reduced, or single number of chromosomes. Any egg that is not fertilized develops parthenogenetically into a male. If there are two X-chromosomes in the bee, as in some of the other insects, the egg is expected to contain only one of them after the extrusion of the polar bodies. Hence, if it develops without doubling its chromosomes, it should give rise to a male. That the male has the single number of chromosomes is also borne out by the evidence from a peculiarity of the first spermatocyte division in which the cytoplasm divides, but the chromosomes do not separate into two

groups. Several stages in the maturation of the spermatozoon of the bee are shown in Fig. 80. In *a*, the spindle for the first spermatocyte division has appeared. A small piece of the cytoplasm cuts off, but the chromosomes do not separate, and they return again (*b* and *c*) to a resting

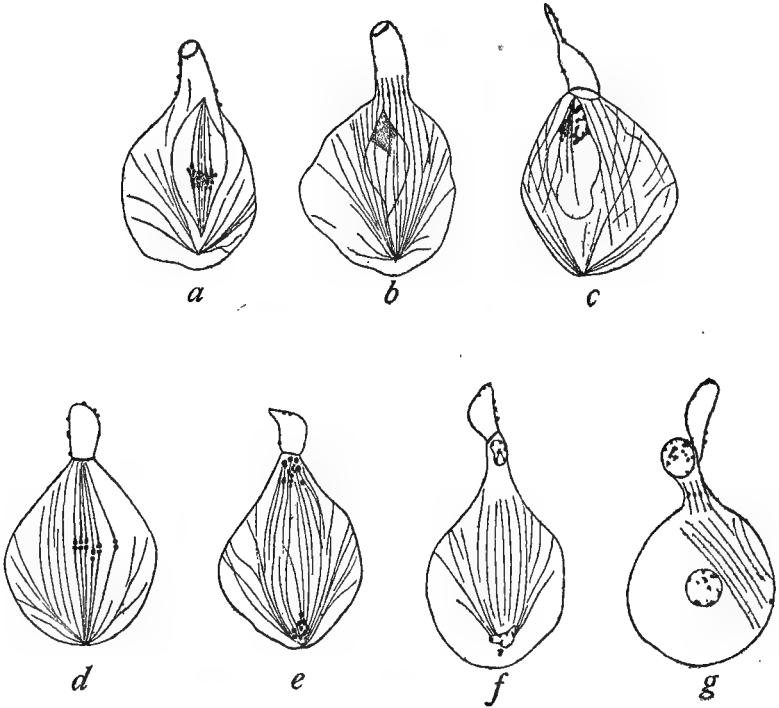

FIG. 80.—First spermatocyte divisions *a-c*, and the second spermatocyte division *d-g* in the bee. (After Meves.)

stage. Another spindle forms (*d*), and the chromosomes separate into two groups, one of which is pinched off as a rudimentary cell that never becomes a spermatozoon. Hence only one, and not four spermatozoöa as in ordinary cases, is formed from each spermatocyte. In the hornet (Fig. 81), the spermatogenesis is similar to that of the bee in that the first division is abortive. It is different

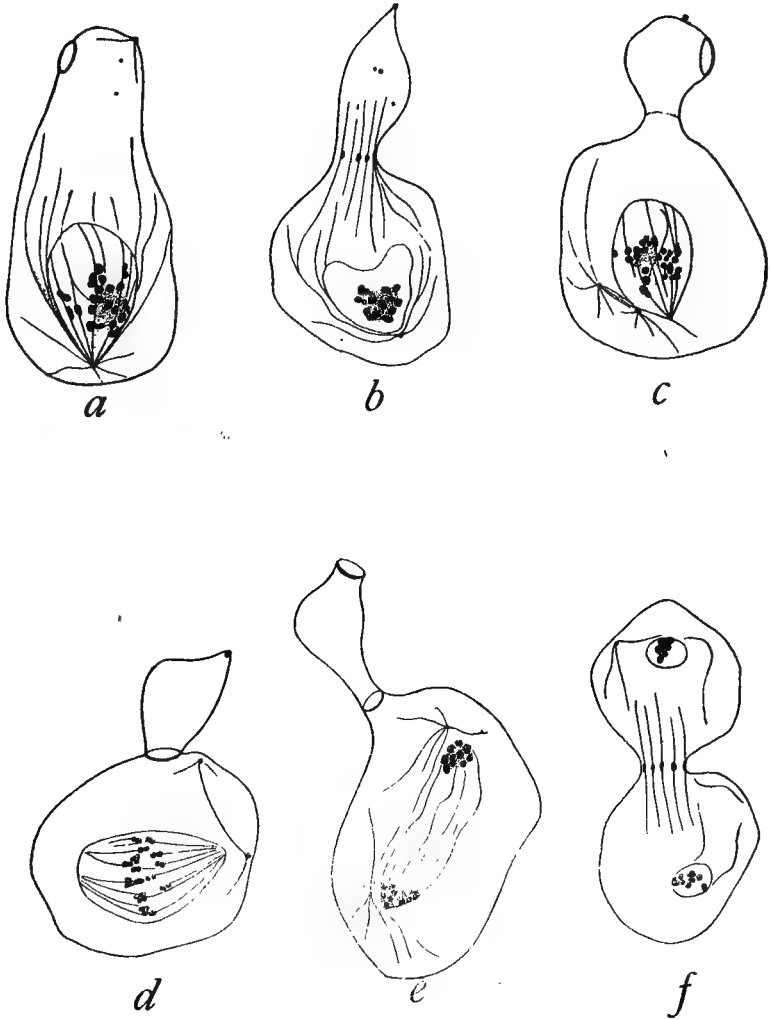

FIG. 81.—First spermatocyte division *a-c*, and the second spermatocyte division *d-f* in the hornet. (After Meves.)

in that the second division produces two functional sperms, both female producing.

Since the male comes from an unfertilized egg, the

*Phylloxera caryæcaulis*

Stem Mother



Migrant. {producer

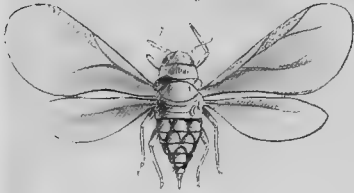

♀



♀

Migrant. {producer

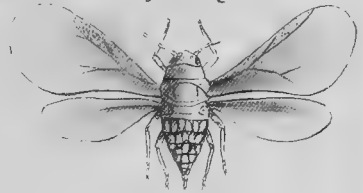

♂



♂

FIG. 82.—Life cycle of *Phylloxera caryæcaulis*.



queen must transmit to him all her characters, thus giving rise to a form of inheritance that has a superficial resemblance to sex-linked inheritance. A queen of a pure race, bred to a male of another race with a dominant factor, produces daughters all showing the dominant character of the father, and sons all showing the recessive character of the mother. Since the son gets his entire chromosome-complex from his mother, he must necessarily be like her, whether the character in question is in the sex-chromosome, or in some other one.

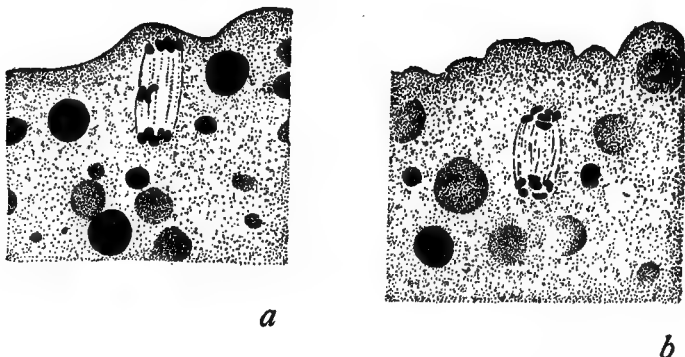

FIG. 83.—Extrusion of the polar body from a male-producing egg with lagging chromosomes on the spindle, *a*; and extrusion of the polar body from a female-producing egg, *b*; in *Phylloxera*.

In the phylloxerans there are two parthenogenetic generations followed by a sexual one (Fig. 82). In the second parthenogenetic generation two whole chromosomes leave certain eggs (Fig. 83) passing into the single polar body which is given off from the egg. Such eggs have two less sex-chromosomes and develop parthenogenetically into males. In other eggs of the same generation all four sex-chromosomes are retained after the polar body is produced. These eggs also develop parthenogenetically, but produce females. Similar changes take place no doubt in the aphids, for the males have been shown to have one less chromosome than the female, although the loss of one

chromosome in the polar body has not yet been observed in the group.

In both phylloxerans and aphids there are two classes of sperm produced in the males as in other insects, one with X, one without it. The latter degenerates, and only the X or female-producing sperm remains functional. A few stages in the spermatogenesis of the bearberry aphid

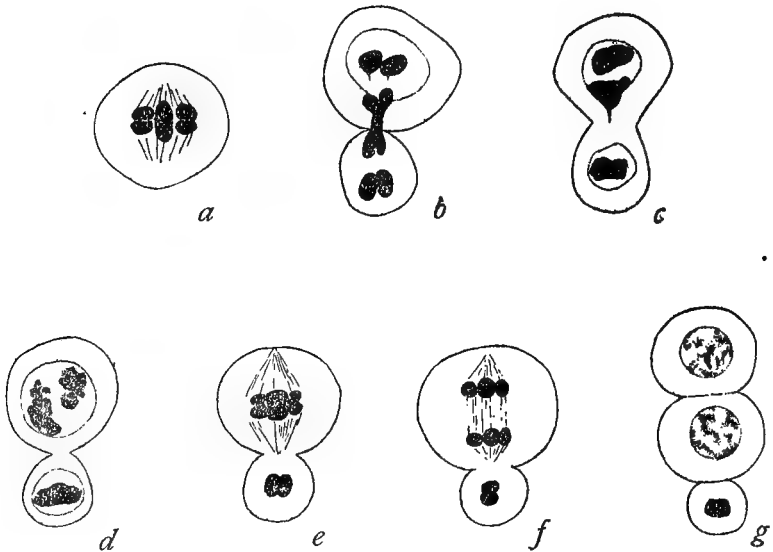

FIG. 84.—First and second spermatocyte division in the bearberry aphid with the formation of one rudimentary cell.

are shown in Fig. 84, *a-g*. In *b*, the chromosomes have divided and moved to opposite poles while the sex-chromosome is drawn out but has not moved yet to either pole. In *c*, the sex-chromosome has been drawn into the larger of the two cells that is produced. In *d*, the division into a larger and a smaller cell is completed. In *e*, preparations for another division are taking place in the larger cell, and in *f* and *g* this is completed. The smaller cell does not divide, and later degenerates. The two spermatozoa from



the two larger cells each contain one X-chromosome and two autosomes. They correspond obviously to the female-producing sperm of other insects. Hence only females arise from fertilized eggs.

The rotifers, especially *Hydatina senta*, are the only animals in which the transition from parthenogenetic to sexual reproduction has so far been gotten under control by regulating the environment, and although the evidence that the environment causes part of its effects by influencing the chromosomal mechanism is not yet established, there is, in my opinion, some indication that such is the case. The common method of reproduction in *Hydatina* is as follows: A parthenogenetic female (Fig. 85, *A*) lays eggs (*D*), each of which, after giving off a single polar body, develops at once (*i.e.*, without fertilization) into a female like the mother. The whole number of chromosomes is retained in the eggs. Several or many generations may be produced in this way. Whitney has shown that if such females are fed on a green alga, *Euglena*, daughters appear (structurally like the others) that produce smaller eggs (*E*). If these eggs develop without fertilization they become males (*C*). Examination of these small eggs show that they give off two polar bodies, and retain a reduced number of chromosomes. This process is the same by which the male bee is produced.

If the female, that produces the small eggs just described from which the males develop, should have been impregnated by a male soon after she hatched, her eggs would then grow larger and surround themselves with a thick-walled coat. They become the winter or resting eggs. Each such egg, after the sperm enters, gives off two polar bodies, reducing in this way the number of its chromosomes. By the addition of the sperm nucleus the full number of chromosomes is recovered.

Whitney has recently shown that there are two classes of spermatozoa produced by the male, large and small;

for, owing to the few sperms produced by each male their actual number can be counted. There are twice as many large as small spermatozoa, if, as may be the case, only the large ones contain chromosomes and are functional,

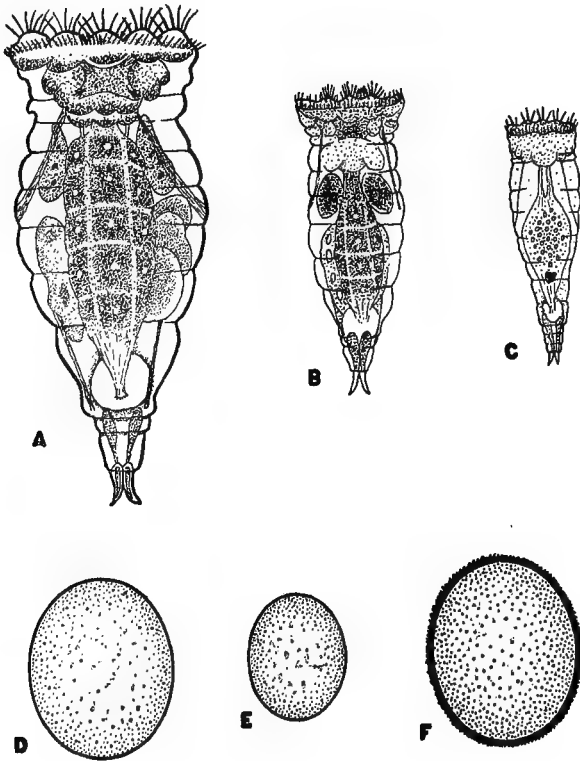

FIG. 85.—*Hydatina senta*, adult female, A; young female soon after hatching, B; adult male, C; parthenogenetic egg, D; male-producing egg, E; resting egg, F. (After Whitney.)

the conditions here would appear to be like those in the hornet, provided there are no chromosomes in the small spermatozoa. This would also explain why all fertilized eggs produce females.

So long as the ordinary parthenogenetic females are fed on the poor diet of *Polytoma*, they continue to produce

parthenogenetic females like themselves (Fig. 86), and this non-sexual process continues indefinitely. If on the contrary, parthenogenetic females are fed abundantly on a rich diet of the green alga *Euglena*, their eggs develop into individuals which, if early fertilized as explained above, become sexual females, *i.e.*, they lay fertilized eggs, but if not fertilized, produce small eggs that, developing parthenogenetically, become males. In other words, the same female becomes either a sexual female, or a female that

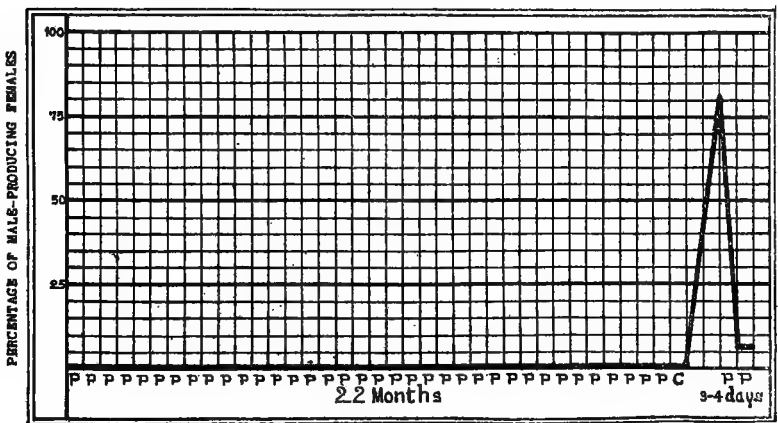

FIG. 86.—Diagram showing how a continuous diet of *Polytoma* (P-P) through twenty-two months yielded only female-producing females, but when the diet was suddenly changed to *Chlamydomonas* (at C), male-producing females appeared at once. (After Whitney.)

gives birth to males. Some recent writers, misunderstanding these relations, have tried to make it appear that the change here is one that is sex-determining, using this expression to all appearances as it is ordinarily employed in other cases, but in fact using the term in such a way as to obscure the one important fact that the results really show, *viz.*, that an environmental change of a specific kind produces a new kind of female that is either a producer of eggs that become males (after or because two polar bodies are extruded), or becomes a sexual female, should she early meet a male.

## SEX-DETERMINATION AND ARTIFICIAL PARTHENOGENESIS

Many interesting questions concerning sex-determination might be studied were it as easy for man, as it appears to be for nature, to make eggs develop without fertilization. Only three cases are known in which eggs developing under artificially induced conditions have reached maturity. Delage raised one sea urchin that had been produced artificially to maturity, and determined that it was a male. Tennent has shown that the male is heterozygous for the sex-chromosomes. Hence, if the artificially produced urchin has the half number of chromosomes it should, if like the bee, be a male, but if, as Herlandt has shown, the number of chromosomes may double before development, a female would be expected.

In the frog, Hertwig, and later his pupil Kuschakewitch, found that the number of males is increased up to 100 per cent. if the eggs are detained in the uterus for one to three days before adding sperm to them. Hertwig has attempted to explain the result as due to a relative change in the size of the nucleus that takes place in consequence of the delay, but since the chromosomes are at this time in the metaphase of the second polar spindle, it is not obvious how such an enlargement could be brought about, quite aside from the question as to whether the result imagined would follow even after such a change. I have suggested that these eggs with deferred fertilization may develop parthenogenetically, due either to the egg nucleus alone giving rise to the nuclei of the embryo, or to the sperm alone giving rise to these nuclei, in the latter case, the polar spindle of the egg having been caught at the surface and prevented from taking part in the development. The possibility of the nuclei of the frog arising in one or the other of these ways is shown by the work of Oscar and Gunther Hertwig who have found evidence that after treatment with radium, the sperm-nucleus alone may give rise to the somatic nuclei of the embryo. Packard also

has shown that such kinds of androgenetic embryos may arise in the eggs of *Chaetopterus* treated with radium, and by following every stage in the process he has determined also that the embryos have the reduced number of chromosomes.

Other work on the egg of the sea-urchin had seemed to show that while in most cases the egg, that begins to develop parthenogenetically, starts with, and continues to maintain the half number of chromosomes, yet according to a recent observation of Brachet, a parthenogenetic tadpole, eighteen days old, that he produced, had the double number of chromosomes. Whether it may turn out that when the egg nucleus gives rise to the nuclei of the parthenogenetic individual it may sometimes double its number of chromosomes (by failure of the first cytoplasmic division, for example), and that when a sperm gives rise to these nuclei the half number is retained, cannot be stated. Until we have farther information on these points the expectation as to what the sex of parthenogenetically produced frog individuals will be can only be speculative. Loeb has raised seventeen adult, or nearly adult male frogs and three nearly adult female frogs from eggs developing after Bataillon's puncture method of inducing parthenogenesis. One male frog had more than the half number of chromosomes (at least 20 and presumably the whole number, 26?). The number of chromosomes in the females was not determined.

#### GYNANDROMORPHS AND SEX

In the group of insects especially, it has long been known that individuals occasionally appear that are part male, part female. In the most striking cases the line of division runs down the middle of the body, but there are also antero-posterior gynandromorphs, and individuals with only a quadrant or even a small piece of the body different from the rest in its sex character. Several hypotheses have been advanced to explain these rare com-

binations of the two sexes, and it is probable that gynandromorphs may arise in more than one way, but in *Drosophila* it can be demonstrated that the great majority of gynandromorphs result from dropping out of one of the sex-chromosomes at some early division of the fertilized egg. The demonstration is made possible by using sex-linked characters that are known to be carried by the sex-chromosomes. For example: Yellow body color in *Drosophila* is due to a recessive gene carried by the X-chromosome. Its allelomorph (wild type) lies also, of course, in the normal X-chromosome. If yellow is crossed to wild, and a bilateral gynandromorph should arise, it may be yellow on the male side (as seen in the yellow wings and yellow hairs over half the body) and wild type on the female side (Fig. 87).

Since the male characters arise when only one sex-chromosome is present, it must be the yellow-bearing chromosome in this case that gives the male side. Since the female characters arise when two X's are present, both must be present in the female side, which will here be the wild type, since the gene for wild type dominates the yellow-producing gene. The gynandromorph must have arisen, therefore, at a very early nuclear division in the egg in which one daughter X-chromosome failed to pass into one of the daughter nuclei. The diagram (Fig. 88) shows how such a result might be supposed to have come about.

The diagram indicates that one daughter chromosome X' (bearing the gray gene) has failed to become incorporated in its proper nucleus, which is therefore left with only one X. From this nucleus the nuclei of the male half are produced, while from the XX nucleus the nuclei of the female half arise. That both of these nuclei, the XX and the X nucleus contain other chromosomes derived from both parents has been shown by making one of the original parents homozygous for some recognizable autosomal

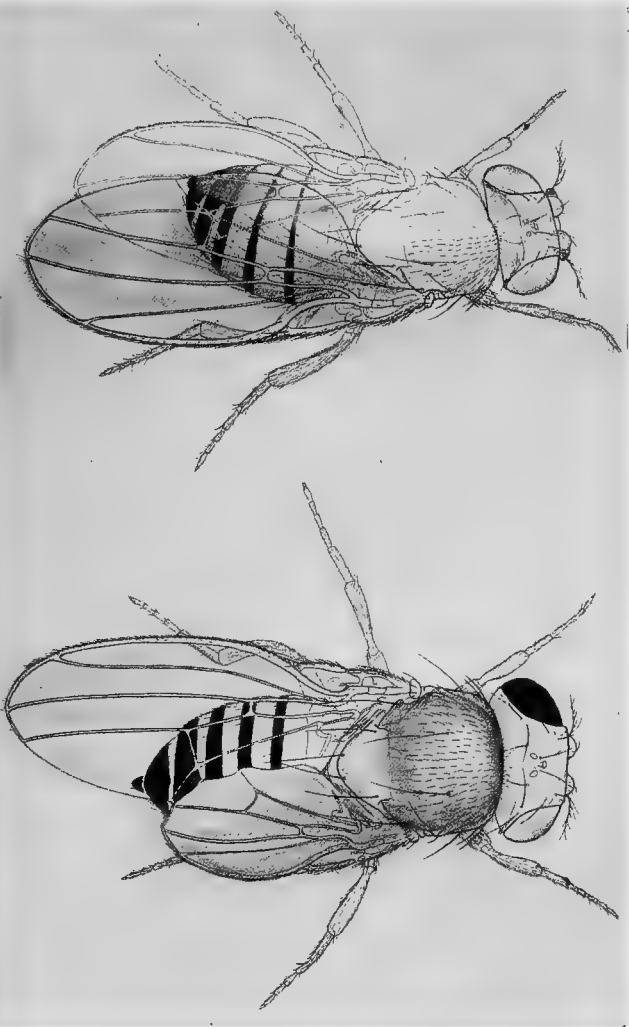

FIG. 87 A.—Gynandromorph. Left side of thorax and abdomen and left wing and legs are yellow in color and male. Right side of thorax and abdomen and wing and legs are gray and female. All of head is gray and female with "white-eosin-compound" eyes. Genitalia are female. The mother of this gynandromorph was a "white-eosin-compound,"  $i, e,$  she had one X-chromosome with an eosin gene and one with a white gene. The father was yellow white,  $i, e,$  his single X-chromosome carried the genes for yellow and for white. Elimination consisted in the loss of one of the maternally derived chromosomes,  $\frac{1}{2}$ , that one bearing eosin, leaving only the yellow white chromosome to produce the male side of the thorax and abdomen.

FIG. 87 B.—Gynandromorph. Left side is female. Left eye red and wing long, like that of a normal female. Right side, except abdomen, is male with eosin eye and miniature wing. Sex comb on right fore-leg only. The mother of this gynandromorph had one vermilion-bearing X-chromosome; and another X-bearing eosin and miniature genes; the father carried an X-chromosome bearing eosin and miniature.





character. It, or its normal allelomorph, should therefore be present in both nuclei if all the chromosomes of the fertilized egg have divided normally except the X-chromosomes. This, in fact, has been found to be the case (Morgan, Bridges, Sturtevant).

Nearly all of the many hybrid gynandromorphs of *Drosophila* can be explained as above. In a few cases, when the abdomen of the fly was sufficiently female to make mating possible, it has been found that the eggs give the results expected for a female having the sex-linked factors that entered the cross.

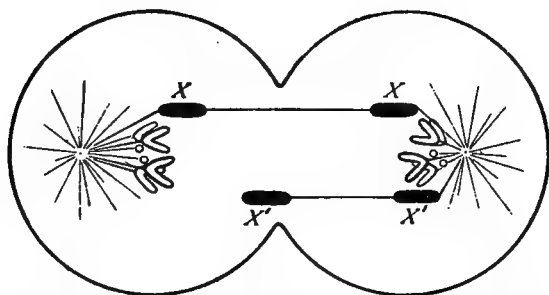

FIG. 88.—Diagram showing elimination of  $X'$  at an early cell-division, so that the nucleus to the right gets  $X$  and  $X'$  and that to the left only  $X$ .

In a few cases in *Drosophila* the explanation of chromosomal dislocation will not cover the results. Some of these cases can, however, be accounted for by another hypothesis. Should an egg arise with two nuclei (there are several possible ways for this to occur), one nucleus having one set of factors, the other the other set (the parent being heterozygous), then if each nucleus is separately fertilized a different combination of factors is possible from that possible on the elimination theory. A gynandromorph, described by Toyama, appears to belong to this category. Toyama found two gynandromorphs of the silkworm (Fig. 89) whose mother belonged to a race with banded caterpillars, and whose father belonged to a

race with pale caterpillars. One of these was banded on the left side (which side was also female) and pale on the right side (which was also male). The sex of the two sides was only apparent after the moth had appeared. The banded character of the worm is known to be dominant to the pale character, but neither is sex-linked. The case can be explained, if as the evidence indicates, the mother was

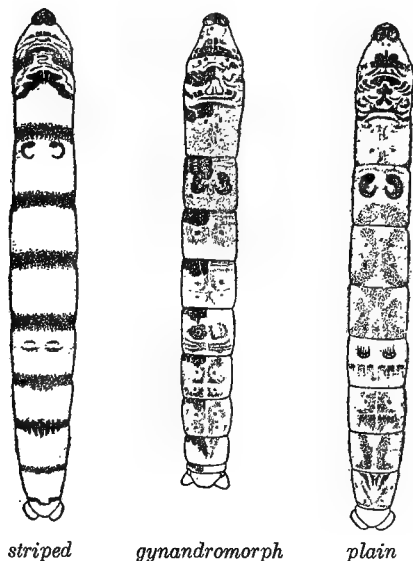

FIG. 89.—Caterpillars of the silkworm moth. A striped one to the left, a plain one to the right, a hybrid gynandromorph in the middle.

heterozygous for a not sex-linked character, banded, and if she produced an egg with two nuclei (Fig. 90). Doncaster has found such eggs in *Abraxas*, and has shown that each nucleus extrudes separately polar bodies, and that each reduced egg nucleus is fertilized by a separate spermatozoön. If as shown in the next diagram one reduced nucleus has a *W*-chromosome, and a factor for banded carried in one of the autosomes, and the other reduced nucleus has a *Z*-chromosome, and in one of the

autosomes a factor for pale, and if a spermatozoön, carrying the factor for pale, fertilizes each nucleus, the two zygotic nuclei will be  $ZW$  female and banded, and  $ZZ$  male and pale. This gives at least a formal explanation of the results, and helps us to see how such a rare event, the appearance of two gynandromorphs in the same brood, happened to occur at the same time; because, as Doncaster's evidence shows, a double nuclear condition may be characteristic of the eggs of certain females.

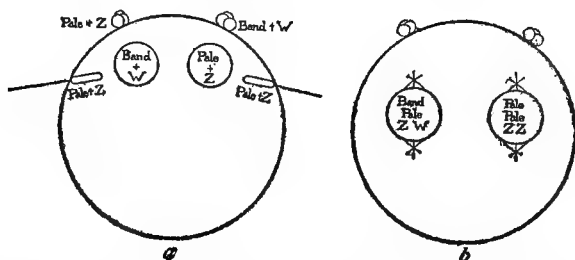

FIG. 90.—Diagram illustrating how a heterozygous egg with two nuclei fertilized by two sperms might produce a gynandromorph like that shown in Fig. 89.

### “INTERSEXES” AND SEX GENES

The quantitative relation of one  $X$  for male and two  $X$ 's for female that has been found to hold in many of the groups of animals might seem from a purely *a priori* point of view capable of being modified in such a way that an intermediate condition might be realized, but whether such conditions should be expected to give rise to hermaphrodites or to non-sex-somethings (intermediates)—or to a mosaic of both sexes, or should rather be expected to die could scarcely be foretold. There are three cases in which individuals called “intersexes” have been found, or produced; and since their interpretation has led to a view that has appeared to contradict the ordinary sex-determination scheme, these cases must be briefly referred to here. Goldschmidt has studied very thoroughly “inter-

sexes" that arise when the European and Japanese race of gypsy moths, *Lymantria dispar* and *L. japonica*, are crossed. Riddle has described doves obtained by crossing the white ring dove (*Streptopelia alba*) and the Japanese turtle dove (*Turtur orientalis*) that are intersexual in their mating habits. Olga Kuttner and Banta have found that certain lines of Cladocerans (*Simocephalus*) may produce (parthenogenetically) "intersexual individuals" in the sense that an individual may possess some of the secondary sexual differences of one sex and some of the other.

Some of Goldschmidt's combinations between different races of gypsy moth produce only intersexual females, *i.e.*, individuals that are mostly female, but have also, in spots, male characters. In the most extreme cases they are almost like males, not only in color, but even in the partial production of testes. Other racial combinations give male intersexes, *i.e.*, individuals that are for the most part males, but show, in spots, some of the characteristics of the female. Goldschmidt explains these results by the assumption that the sex factors have different quantitative values in the different races. He represents the female by  $FFMm$ , and the male by  $FFMM$ . If the  $FF$  "factorial set" is represented by 80 units, and the "present" male factor,  $M$ , by 60 units, then the above formula for the female becomes  $80-60 = +20$ , and the male formula becomes  $80-(60+60) = -40$ . In the former, female units "dominate," in the latter, the male. Values like these can be arbitrarily set for all the different races. For instance, to the "weak" European race and the "strong" Japanese the following values are assigned:

Weak European Race			Strong Japanese Race	
♀	FF	Mm	FF	Mm
	80,	60	100,	80
♂	FF	MM	FF	MM
	80,	60, 60	100,	80, 80

If a Japanese female is crossed to a European male, the  $F_1$  female and male may be represented in the following formula:

$$\begin{array}{ccc} F_1 \text{ ♀ } FF & Mm & \\ 100, & 60 & \end{array} \qquad \begin{array}{ccc} F_1 \text{ ♂ } FF & MM & \\ 100, 80, & 60 & \end{array}$$

Both "normal" female and male offspring are expected in equal numbers. The reciprocal cross gives a different result, *viz.*:

$$\begin{array}{ccc} F_1 \text{ ♂ } FF & MM & \\ 80 - (80 + 60) & & \end{array} \qquad \begin{array}{ccc} F_1 \text{ ♀ } FF & MM & \\ 80, 80, & 60 & \end{array}$$

The  $F_1$  female is  $FF - M = 0$ ; and is therefore represented as intersexual. It will be observed that the so-called "female factors" in these formulæ are supposed to be inherited entirely through the mother.

By assigning different values to  $FF$  and  $M$  in the different races it is possible to express the results in such a way that the sexes obtained by various crosses have different minimal values—those less or more than any assigned value for a given sex are interpreted as intersexes. In the example cited, an exact balance ( $=0$ ) between the conflicting factors produces an individual that is represented as neither male nor female. It is not obvious, however, why it should be made up of parts each of which is strictly comparable to the same part in a male or a female.

While the assignment of arbitrary values to sex factors is a legitimate procedure, it is not a quantitative analysis in the ordinary sense, since the quantities are not referred to some external measure, but are purely arbitrary.

How far an erratic elimination of sex-chromosomes in later stages of cell-division might account for the result cannot be stated, since there are at present no facts to go upon—the chromosome count in somatic cells of the hybrid has not yet been reported, but Goldschmidt thinks

that the mode of development of the embryo precludes this interpretation.

Riddle obtained his intersexual hybrids by causing their mother to produce many more eggs than she would ordinarily produce. This was done by removing the eggs from the nest as soon as they were laid. Towards the end of a series obtained in this way an overworked female produced an excess of males. Some of these males Riddle regards as females that have been changed into males—the completeness of the change being shown in their sexual behavior towards other males, etc. But there is involved in the cross a sex-linked factor that behaves, as R. M. Strong had already shown several years ago, as do sex-linked factors in other birds. It is thus possible to identify the chromosomal make-up of Riddle's intersexual hybrids. His own results show that the hybrids have the expected combination of chromosomes for males. It appears, therefore, that whatever it may be that affects their behavior their sex is determined by their possessing the ordinary chromosome constitution for males.

#### HERMAPHRODITISM AND SEX

As has been shown, the sex-mechanism, whether  $XX-XY$  or  $WZ-ZZ$ , gives rise to two kinds of individuals—males and females. There are, however, many groups and species of animals where both eggs and sperm are found within the same individuals, and in typical cases there are in such individuals special ducts that are outlets for the male germ-cells and others for the female germ-cells. In these hermaphrodites “sex-chromosomes” are not known to be present, or if present as in *Ascaris nigrovenosa*, they act as sex determinants only in alternate generations.

The usual interpretation of the determination of the sex-cells of hermaphrodites is that their differentiation is determined by the same kind of specific influences that determine, for example, that certain cells of the primitive gut develop into liver cells, others into lung cells, still

others into pancreas cells, etc. There is nothing inconsistent in such a view with the theory that in other cases a different mechanism produces different kinds of germ-cells. Logically, this viewpoint is consistent, but I can sympathize with efforts that are continually being made to find an explanation that makes use of the same kind of process in genetic segregation and in embryonic differentiation. In fact, in 1902, while still under the influence of the then recent advances in the field of experimental embryology (developmental mechanics), I suggested that one might attempt to treat the phenomenon of segregation from the same theoretical standpoint (*viz.*, the realization of alternative states) as was then appealed to for embryonic differentiation. It soon became apparent to me, however, that (1) the two kinds of results depended upon entirely different situations, and therefore need not have a common explanation; (2) that the genetic evidence showed the improbability of explaining segregation and differentiation in the same way; (3) that special tests that I carried out failed to support the supposition of a common explanation; (4) that while no detailed explanation is possible at present for the general phenomena of specific differentiation, yet for Mendelian segregation the reduction division supplies all that the results call for.

#### SEX RATIOS

The theory of sex-determination has been deduced from the evidence of equality of males and females as well as from the cytological evidence. It remains to explain why in some cases the machine fails to give equality of the two sexes; why, for example, all fertilized eggs of phylloxerans and aphids, or daphnians, or rotifers, or bees, are female; why certain mutant races of flies give twice as many daughters as sons; why other races of flies produce nearly all sons; why the sex ratio in man is about 106 males to 100 females.

It is perhaps needless to point out that if, in a species

in which sex is determined by a chromosome mechanism, it were possible to change the sex by other agencies in spite of the chromosome arrangement, the latter relation would be entirely thrown out of gear and males would transmit sex-linked characters and sex itself like females, and females like males. As no such cases have been found, it is futile to discuss such a possibility.

It has been shown that only the female-producing sperm in phylloxerans and aphids becomes functional, hence it is obvious why all the fertilized eggs develop into females. In daphnians and other crustacea it is not known whether one class of spermatozoa degenerates, but the results are explicable on such a view. In rotifers the production of males only by certain females is due to the eggs developing by parthenogenesis with the haploid number of chromosomes and this explains also the case of the bees, wasps and other hymenoptera. If a queen bee is unfertilized or if her supply of sperm gives out she produces only males. If she contains sperms, then any egg that is fertilized produces a female, and as Petrunkevitch showed several years ago, spermatozoa are to be found in eggs laid in worker cells—such eggs being known to produce workers (♀ ♀). In rotifers, too, the presence of a large and a small class of sperm suggests that only the former is functional.

Certain females of *Drosophila* give a sex ratio of two females to one male. By making such a female heterozygous as to her X-chromosomes (each carrying different factors) it can be determined that the half of the expected sons that die are the ones containing one of these two chromosomes. It is easily possible by means of linked genes to locate a factor in the sex-chromosome (Fig. 91) and to show that whenever it goes to a male the fly dies. All the daughters survive because the lethal factor being recessive does not harm a female whose other chromosome comes from a normal father. The scheme is shown on the next page.



As many as 20 different lethals have been found in the X-chromosomes of *Drosophila*. Their occurrence in these chromosomes is first noticed by the appearance of such exceptional sex ratios. Lethal factors like these need not be thought of as different in kind from any other mutant factors. They may mean only that the changes that they cause are of such a kind, structural or physiological, that the affected individual cannot develop normally. Some of the lethals may be fatal in

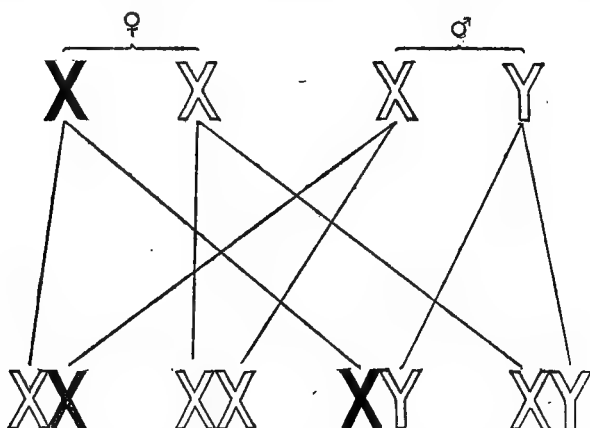

FIG. 91.—Scheme showing the transmission of a lethal sex-linked factor in an X-chromosome the black one in the diagram.

the egg stages, others are known to cause the death of the larvæ, others probably act on the pupæ, and a few even allow an affected male to occasionally come through.

In man and in several other mammals there is at birth a slight excess of males over females. Since male babies die oftener than females, the difference has been said to be an "adaptation," with the implication that it calls for no further explanation. Several possible solutions suggest themselves. The male-producing sperm bearing the sex-chromosome may more frequently develop abnormally than the female-producing sperm. Again, since the spermatozoa must, by their own activity, travel the entire

length of the oviduct to reach the egg as it enters the tube, the greater size or weight of the female-producing sperm may give a slight advantage to the male-producing sperm in the long trip up the tube. This would lead to an excess of males. There are still other possibilities, which if realized, would suffice to slightly change the equality of the output of the machine.

#### NON-DISJUNCTION

Females of *Drosophila* are occasionally found that give exceptional breeding results which have been explained by Bridges on the view that these females are

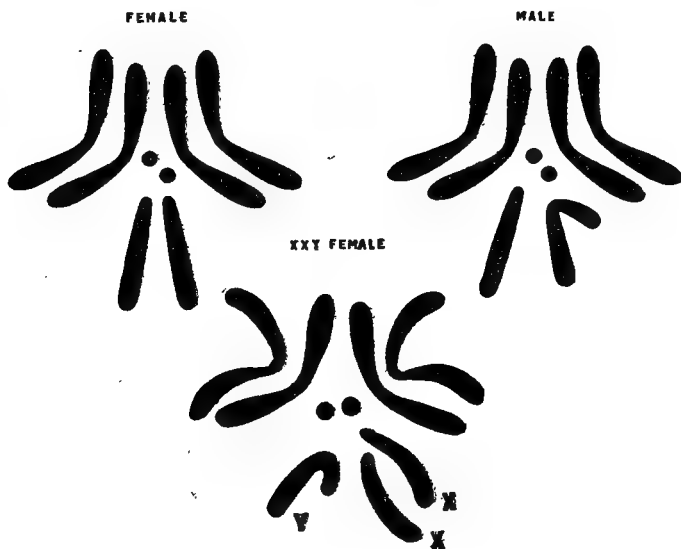

FIG. 92.—Normal female and male groups of chromosomes of the vinegar fly, with the XXY female group below.

XXY individuals (Fig. 92). It has been shown by cytological examination that such females do actually contain an additional Y-chromosome. The four possible ways in which these three chromosomes might be expected to behave at the reduction division when the polar bodies

are given off by the egg are shown in the next diagram (Fig. 93). One X may go out of the egg, and the other X and the Y stay in; or one X may stay in the egg and the other X and the Y go out. In these two cases, X and X may be thought of as members of a pair that conjugate, as in the normal female, and then separate, and chance alone determines whether the Y stays in or passes out. Again Y may go out of the egg and X and X stay in; or X and X

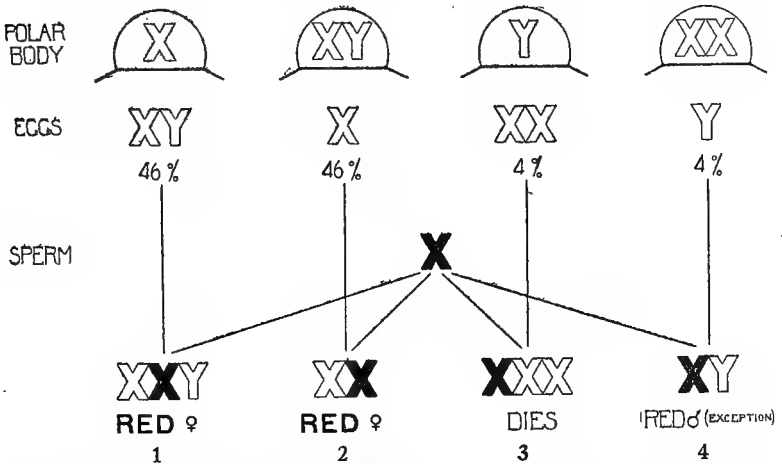

Fig. 93.—Non-disjunction. In the upper part of the figure the four possible modes of elimination of the sex-chromosome from XXY eggs are shown; the results of their fertilization by an X-bearing sperm of the male is shown below.

go out and Y stay in. Here X and Y may be supposed to be members of the conjugating pair, and the free X goes to the same pole as the X that conjugated.

In the diagram, each of these four types of eggs is represented as fertilized by an X-bearing sperm. In order to make the outcome more apparent the original XXY female may be supposed to have had white eyes (clear X's) and the male that fertilized her red eyes (here represented by the black X carrying the gene for red eyes).

Four classes of individuals are expected: (1) Red-eyed females (XXY); (2) red-eyed females (XX); (3) red-eyed

females ( $XXX$ ) that die, and (4) red-eyed males ( $XY$ ). The last are exceptional, since white-eyed females normally never produce anything but white-eyed sons. Here the exceptional male is due to an egg without an  $X$ , being fertilized by a "female-producing" (or  $X$ -bearing) sperm. The three  $X$  individuals have never been found, and undoubtedly die, presumably from too many  $X$ 's. The remaining red females are of two kinds, one normal  $XX$

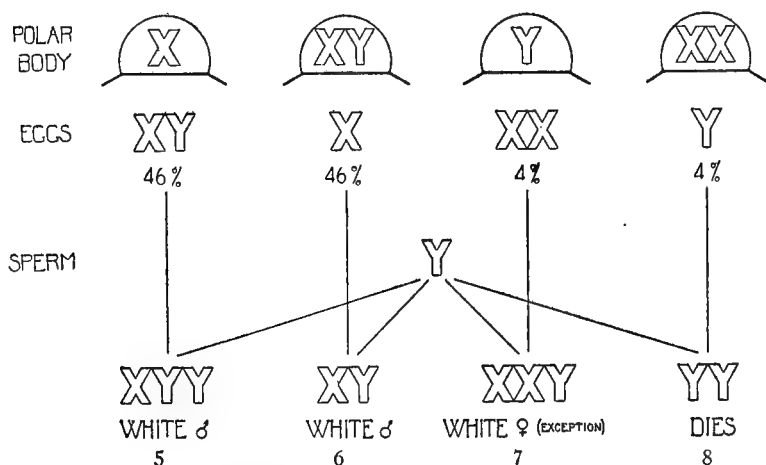

FIG. 94.—Non-disjunction. In the upper part of the figure the four possible modes of elimination of the sex-chromosome from the  $XXY$  eggs are shown, and the results of their fertilization by a  $Y$ -bearing sperm of the male is shown below.

and the other ( $XXY$ ), which is expected to repeat the exceptional behavior of her mother. In fact, this is what she does.

In the next diagram (Fig. 94) the fate of the same four kinds of eggs is shown if they are fertilized by a  $Y$ -bearing sperm. Four classes of individuals are expected (5) white males ( $XYY$ ); (6) white males ( $XY$ ); (7) white females ( $XXY$ ); and (8)  $YY$  individuals. No individuals having the last make-up have ever been found, and there can be no doubt that an individual without at least one  $X$  dies. The white-eyed females are exceptional, since white-eyed

mothers by red-eyed fathers have normally only red-eyed daughters. These exceptional white-eyed females ( $XXY$ ) must repeat the phenomena of non-disjunction, and it has been found that they do so invariably. The white-eyed male  $XY$  is normal; the other male should produce some  $XY$  sperm and thus transmit both  $X$  and  $Y$  to some of his daughters. Such daughters as get both  $X$  and  $Y$  from the entering sperm should show non-disjunction. This has been proven to occur.

An analysis of the data has shown that two of the four types of eggs are more common than the other two. As indicated in both diagrams the types of eggs that result after  $X$  and  $X$  have united occurs in 92 per cent. of the cases, and since in this type the unmated  $Y$  has a random distribution, the  $XY$  egg is found in 46 per cent. of cases and the  $X$  egg in 46 per cent. The more uncommon type of egg would be expected to result if  $X$  and  $Y$  united and then separated while the other  $X$  had a random distribution.<sup>1</sup> Eight per cent. of such cases occur, giving  $XX$  eggs in 4 per cent., and  $Y$  eggs in the other 4 per cent. of cases.

These results not only furnish very strong proof of the chromosome theory of sex, but serve also to show how a knowledge of the actual mechanism involved leads to the discovery of how a change in the mechanism gives a new output. The conclusion that females behaving in this way must contain a  $Y$ -chromosome was confirmed by the cytological demonstration that showed in them two  $X$ 's and a  $Y$ .

---

<sup>1</sup> Since this was written it has been found that after  $XY$  synapsis the free  $X$  always goes to the same pole as the synapsed  $X$ .

## CHAPTER XV

### PARTHENOGENESIS AND PURE LINES

IN so far as parthenogenetic reproduction takes place without reduction in number of the chromosomes, the expectation for any character is that it will have the same frequency distribution in successive generations, because the chromosome group is identical in each generation. There are a few cases where parthenogenetic inheritance has been studied. The results conform to expectation.

The only difference between a species reproducing by diploid parthenogenesis and one propagating vegetatively is that in the latter a group of cells starts the new generation and in the former only one cell, *viz.*, an egg, that no longer undergoes reduction, or needs to be fertilized. In both, the chromosome complex remains the same as in the parent. Strictly analogous to the two foregoing methods of propagation are the cases of sexual reproduction in a homozygous group of individuals, composed of males and females or in a group of hermaphroditic forms that are homozygous. Successive generations are here also expected to have the same frequency distribution, whether selected or not, because they have the same germ-plasm. Johannsen's pure lines furnish an example of the last case, for, in principle, pure lines, parthenogenetic reproduction, and vegetative propagation, are concerned with nearly the same situation.

Johannsen worked with one of the garden beans (*Phaseolus vulgaris*) taking the weight of the seeds, in some cases, and measuring their sizes in other cases. It is known that this bean regularly fertilizes itself. As a consequence of self-fertilization there is a tendency for the descendants of any form to become in time homozygous, even when heterozygous forms were present at first.

In fact, in a few generations perpetuated by self-fertilization with chance elimination of individuals, a homozygous race will result. This comes about as follows: Starting with a heterozygous hermaphroditic individual, some of its offspring will, through recombination of factors, become homozygous, and if self-fertilization prevails they will continue homozygous; other offspring will be heterozygous. From the latter both homo- and hetero-zygous offspring will again be produced, the former remaining such in later generations, the latter continuing the process of splitting. Since only a part of each generation survives, there is in the long run a better chance that the homozygous individuals will be the survivors, because those that have become such in each generation are fixed, and those that are not will continue to produce some homozygotes. There will be in consequence a steady process of recurrence of homozygotes which, on chance alone, will sooner or later win out.

The beans that Johannsen worked with had apparently reached a homozygous condition, and at the start there must have been several such lines. He studied nineteen of them. The offspring of any one plant produced beans that gave the same frequency distribution as the beans of the last generation. This condition continued through all successive generations. It is to be noted that the beans on any one plant differ in size, but any one will give the same frequency distribution as the beans of the preceding generation. It made no difference whether the larger or the smaller beans were chosen for planting—they gave the same group in the next generation.

It is interesting to compare this result with what would have happened had the beans been propagating by cross-fertilization at the time when Johannsen began his work with them. If this had been their normal method of reproduction they would probably have been heterozygous at the start, and would have given different genetic types for several generations, even if self-fertilized. Pure lines

would have appeared only after the beans had become homozygous through repeated inbreeding. But Johannsen, starting with homozygous beans, was able to obtain his extremely important results, because if selection could bring about any change it would have to be due to a change in the genes themselves. Here, by means of a crucial experiment, he exposed an error that had been accepted by selectionists from 1859 to 1903. It would have been difficult, almost impossible, to give this demonstration on any plant or animal in which self-fertilization or asexual reproduction was not the rule; for, if the material had been heterozygous either for the main factors for a character, or for modifying factors for that character, selection in one or another direction would be expected through recombination of factors to change the original frequency distribution. It is true that any stock, even such as reproduces by males and females, may be made homozygous by inbreeding brother and sister for ten or more generations, but even such stock would have to be constantly watched for mutation.

Johannsen defined a pure line as a race or family of individuals descended through an unbroken series of self-fertilizations from an ancestor homozygous in all its genes. By making this definition precise he made clear the essential point of his demonstration. Now that his point is made, it seems no longer necessary or even desirable, I think, to narrow the definition of a pure line to races that self-fertilize, since this is only one form of inbreeding, resulting in the production of homozygous individuals. By extending the definition of a pure line to all forms whose genes are the same in all individuals (whether the pairs are homozygous or not), the definition covers all cases of parthenogenesis that do not undergo reduction, and all cases propagating by non-sexual means, for, in these cases the same complex of genes is present in successive generations.

Many plants are propagated by offshoots, stolons,



tubers, cuttings, etc. East has studied the effect of selection of tubers of certain races of the common potato. A race was first grown from a single tuber. By boring holes into the tubers enough material could be obtained for a chemical test of the amount of nitrogen in them. The rest of each tuber could, if desired, be cut into pieces of standard size and planted. Ten tubers, high in nitrogen, and ten, low in nitrogen, were selected. The tubers of the next generation showed that there was no relation found between the amount of nitrogen in the original tuber and in those that came from it. A repetition of the experi-

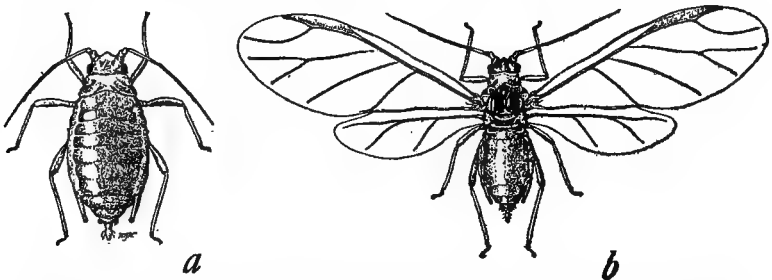

FIG. 95.—A wingless aphid to the left and a winged to the right, both belonging to the same species. (After Webster and Phillips.)

ment in another generation gave only meagre results owing to drought. As far as the facts went, this generation, too, showed no effect of selection.

Most of the protozoa propagate by dividing into equal or nearly equal parts—*i.e.*, by a process of cell-division. Jennings has studied the effect of selection in a culture of paramecium, all members of which had descended from a single individual. No change was induced. Later, however, working on another protozoön, *Diffugia corona*, Jennings found that selection brought about changes in the direction of selection. In this case, the method of division may possibly include irregular distribution of the chromatin material, and the recent work of Hegner indicates that such an interpretation is not improbable. Pos-

sibly, too, the irregular distribution of chromatin particles (chromidia) in the cytoplasm—aside from the nuclear phenomena, or in connection with them—may make the results similar in certain aspects to the distribution of plastids in certain plant cells.

Many species of plant lice—aphids—(Fig. 95, *a*) propagate throughout the summer by parthenogenesis. There is no chromosomal reduction during the development of the egg. Each egg gives off only one polar body,

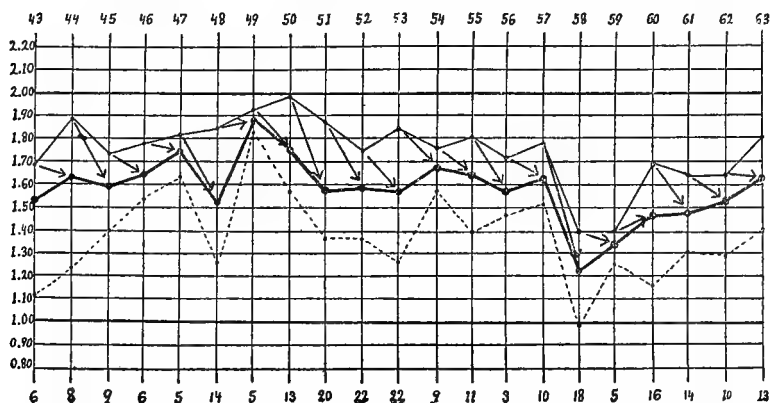

FIG. 96.—Curve showing the non-effect of selection for the first twelve generations for increase in body length, the heavy solid lines represent the fluctuations of the fraternal means; the light solid line the fluctuations of the longest variant; the broken line the fluctuation of the shortest variant. (After Ewing.)

each chromosome splitting into two daughter chromosomes, so that the egg retains the whole number of chromosomes. Ewing has carried out an extensive experiment with *Aphis avenae*, selecting individuals through a number of generations for the length of the cornicles (honeydew tubes), for the length of the antennæ, and for body length. Considering here only the last, individuals were selected for forty-four generations in a plus and in a minus direction. The graph for the forty-fourth to the sixty-third generation is shown in Fig. 96. The heavy solid line represents the fluctuations of the longest vari-

ants, the broken line the fluctuations of the shortest variants. It was found that much of the fluctuation observed was connected with temperature. The temperature was therefore kept constant at about 65° F. for the next twenty generations, and as shown in Fig. 97, the fluctuation in the fraternal line was cut down. No influence of the selection is observable in the chart. This evidence, in conjunction with that for other characters, shows that no change takes place in the characters of

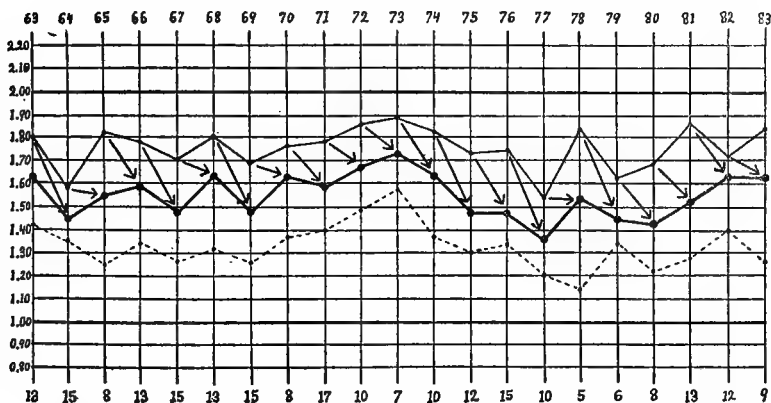

FIG. 97.—Curve showing the effect of selection for the second score of generations. (See Fig. 96.)

the insect so long as the same group of chromosomes remains. It would be difficult to find a better example than these parthenogenetic insects to test the claim that selection can change the germ-plasm, for here the conditions are even simpler than in unisexual forms unless they have first been made homozygous.

The aphids also furnish favorable material to illustrate how the environment may cause very great changes, even when the genetic complex remains the same. The parthenogenetic aphids appear often as winged individuals (Fig. 95, *b*). There is an entire change in structure involving practically every part of the body. The winged

and wingless individuals may differ more strikingly than do species of the same genus. The winged forms arising from the wingless produce wingless forms again in the next generation that may be identical with those from which they came. It has long been believed that environmental influences bring about these transitions in aphids, but only recently has critical evidence been obtained. The clearest evidence is that of Shinji, with the rose aphid. By sticking twigs of the rose in sand and flooding the sand with water containing substances in solution—a method first suggested by W. T. Clarke—the fluid being drawn up into the leaves is sucked out by the aphids on the leaves. As the following table shows, young aphids reared on the

	Winged Individuals.	Apterous Individuals
AgNO <sub>3</sub> .....	51	0
CuSO <sub>4</sub> .....	34	1
HgCl <sub>2</sub> .....	31	6
NiSO <sub>4</sub> .....	955	5
SbCl <sub>3</sub> .....	41	5
PbCl <sub>2</sub> .....	12	2
SnCl <sub>4</sub> .....	579	8
ZnCl <sub>2</sub> .....	49	2
Mg salts .....	840	9
Sugar .....	365	160
Alcohol .....	2	288
Alum .....	3	34
Acetic acid .....	0	67
Na salts .....	2	1029
Ca salts .....	1	433
K salts .....	3	324
Sr Salts .....	1	220
Tannin .....	1	14
Urea .....	5	153
Water, distilled .....	0	394
Water, tap and creek .....	17	461
Peptone .....		15

salts of the heavy metals as well as on magnesium salts and sugar became winged, while those reared on the other substances in this list remain apterous. Here we have an excellent example of how in one environment a given germ-plasm produces one result, and in another environment a different result without any intermediate forms.

The change from wingless to winged aphids is far greater than most mutational changes that we know, yet must involve a different kind of change because the result is reversible, while a mutation, having once taken place, is relatively irreversible.

Summing up, it may be said that the evidence shows that whenever the same chromosomal complex containing the same genes is found, the measurements of any character in successive generations show the same frequency distributions of the measurements, and the form may be said in a general sense to belong to a pure line. The evidence shows that whether the chromosomal complex is heterozygous or homozygous, the results are the same, so far as the pure line is concerned; but it is also obvious that in most animals and plants, where redistribution (reduction) of the chromosomes takes place in each generation, only forms already homozygous will give pure lines. This was the special feature of the material that Johanssen worked with, but aside from its practical value in studying the selection problem, the limitation of the definition of pure lines to such an exceptional situation leaves out of sight the wider bearing of the evidence.

## CHAPTER XVI

### THE EMBRYOLOGICAL AND CYTOLOGICAL EVIDENCE THAT THE CHROMOSOMES ARE THE BEARERS OF THE HEREDITARY UNITS

LONG before the genetic evidence brought forward its abundant data that are explicable on the theory that the chromosomes carry the genes, embryologists had already found other evidence that led them to regard the chromosomes as the bearers of the hereditary factors. Taken as a whole, this evidence makes out a very strong case for the chromosomes, but since it did not establish the relation beyond question, the genetic evidence was all the more welcome.

The earliest evidence, sometimes cited in favor of chromosomal inheritance, was based on the statements that in some cases at least, only the head of the spermatozoon enters the egg. Since it was then thought that the head is composed almost entirely of the nucleus, and since the child inherits equally (in the older parlance) from its father and from its mother, it followed that the nucleus carries the hereditary elements. When later it became known that the head of the sperm represents almost exclusively the mass of condensed chromatin, it was supposed that the chromosomes, in particular, must be that part of the nucleus that is the bearer of hereditary characters. Such a conclusion received indirect support from the facts, then becoming known, that the chromosomes remain constant through successive generations of cells, whereas the nuclear sap becomes lost in the general cytoplasm each time that the nuclear wall is dissolved. It was also found that the spindle fibres disappear in the resting stages, while the nuclear reticulum (chromatin) remains.

This evidence failed, however, in so far as there might be present a certain amount of nuclear plasm in the sperm-head that is carried in with the head, and if so, would be later mixed with the egg cytoplasm. The discovery that at the base of the sperm-head there is present in some eggs a centrosome that becomes, through division, the dynamic centre of the next division, opened the door to suspicion that the sperm might bring in other things than the chromosomes to influence development, and hence heredity.

In conclusion then, while it may be said that the evidence that the sperm-head alone enters the egg may be claimed as favorable for the chromosome view, it cannot be accepted as critical proof, because it is uncertain whether other things also may not be brought in besides the chromatin of the sperm.

Boveri's evidence for chromosomal heredity from dispermic sea urchin eggs was open to less objection. It was known that when two sperms enter the sea urchin's egg simultaneously, the first division of the egg is into three or into four parts, because four (instead of two) division-centres appear in these dispermic eggs. It was also known that these eggs rarely produce normal embryos or larvæ. Boveri, studying the mode of division of the dispermic eggs, found that there was an irregular distribution of the chromosomes to the three or four poles that appear, and consequently to the three or four resulting cells (Fig. 98). The abnormal development of the whole egg that generally follows might be ascribed to the irregular distribution of chromosomes to different regions; for, quite apart from the specific nature of each chromosome or group of chromosomes, the activity of one region being quantitatively different from that of a corresponding region in another part of the egg might be responsible for the failure to develop normally. But Boveri went further in his analysis. He shook apart the three or four blastomeres coming from dispermic eggs (by using Herbst's calcium-free sea-water method), and compared the num-

ber that developed into normal plutei with the number of plutei from one-fourth normally fertilized blastomeres. From the latter a large proportion give rise to normal embryos, from the former normal embryos are rarer. Their greater rarity, Boveri thought safe to attribute to the chromosomal deficiencies present in most of such iso-

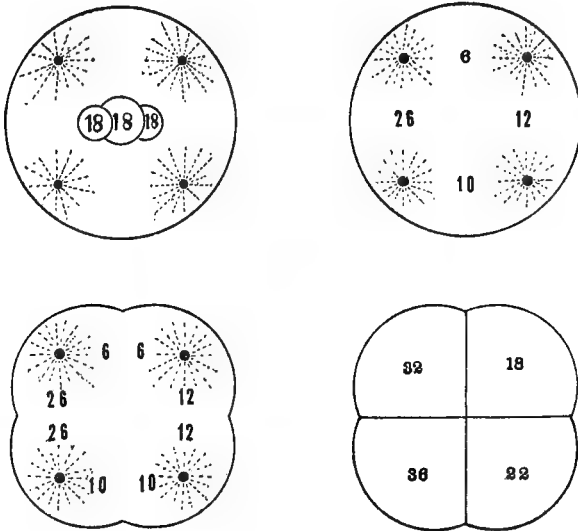

FIG. 98.—Scheme showing dispermic fertilization of the egg of the sea urchin with the subsequent irregular distribution of the chromosomes. (After Boveri.)

lated blastomeres. He suggested that the chance of a blastomere developing normally depends on its having at least one full set of chromosomes. For these triploid sea urchin eggs with three times 18 chromosomes, the chance of one full set of chromosomes getting into each blastomere is, according to Boveri's calculation, only one to 10,000. The chance of getting at least one chromosome of each kind in one cell is greater. He concluded that the few embryos he obtained came from quadrants that had at least one haploid set of chromosomes. There is, however,



to-day some uncertainty concerning the assumption that normal development is to be expected if in addition to one haploid set of chromosomes other chromosomes are also present, because while one set alone might permit normal development, it is by no means certain that if there were one, two, or more additional chromosomes, the balance might not be upset and abnormal development follow. On chance distribution alone the isolation of just one set and no more would seem a very remote possibility,

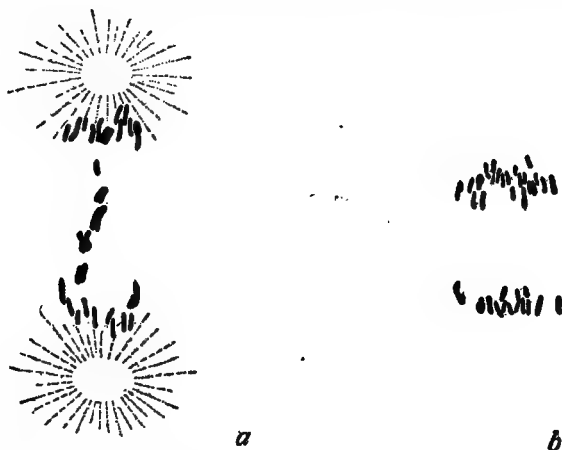

FIG. 99.—First division of a hybrid egg showing the elimination of chromosomes at the equator of the spindle, *a*. The reciprocal cross, *b*, shows no such elimination. (After Baltzer).

but if there is to some degree a tendency for a group of daughter chromosomes to move off together as a result of their method of division, there might be a better chance of such a group getting into one of the three or four blastomeres than by chance distribution alone. At present it is not possible to make any calculation based on such an assumption. While, therefore, Boveri's argument cannot be accepted as demonstrative, yet it has probability in its favor.

Baltzer has found a different kind of evidence of chromosomal influence. When the eggs of one sea urchin,

*Strongylocentrotus*, are fertilized by the sperm of another sea urchin, *Sphaerechinus*, the segmentation nucleus, formed by the union of the egg- and sperm-nucleus shows irregularities in the movements of the daughter chromosomes to the poles of the spindle. While some of the chromosomes after dividing pass normally to the poles, others become scattered irregularly between the two poles and fail to become incorporated in the two-daughter nuclei (Fig. 99, *a*). They appear to become lost and take no

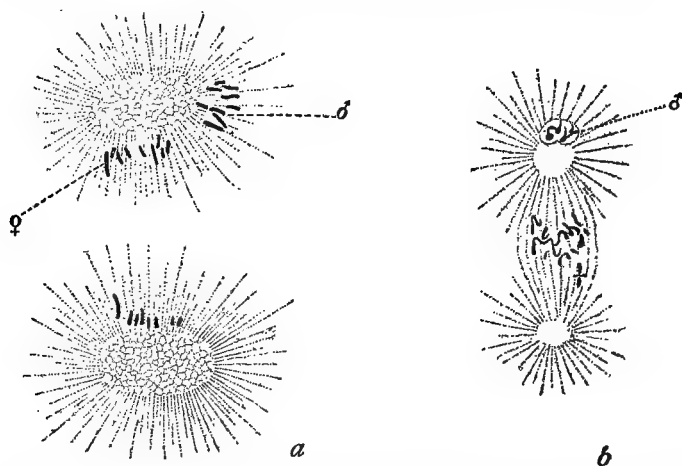

FIG. 100.—Fertilization of an egg that had started to develop parthenogenetically. The belated sperm unites with one of the daughter chromosomes groups only, *a*; an earlier condition of the same procedure. (After Herbst.)

part in the further development. Counts of the chromosome plates in the later divisions of the egg give about 21 chromosomes, whereas 36 are expected as the whole number. It appears that 15 chromosomes are lost, and presumably they belong to the foreign sperm. Many of these eggs develop abnormally, but those that reach the pluteus stage show a maternal skeleton only. This seems to mean that the sperm has done no more than start the development. It has contributed nothing, or little, to the embryo, and it seems reasonable to attribute this to the

loss of the paternal chromosomes, especially in the light of the reciprocal cross.

In this reciprocal cross, the egg of *Sphærechinus* is fertilized by the sperm of *Strongylocentrotus*. All the chromosomes of the segmentation nucleus divide and pass regularly to the two poles (Fig. 99, *b*). The hybrid embryo shows characters of both parental species.

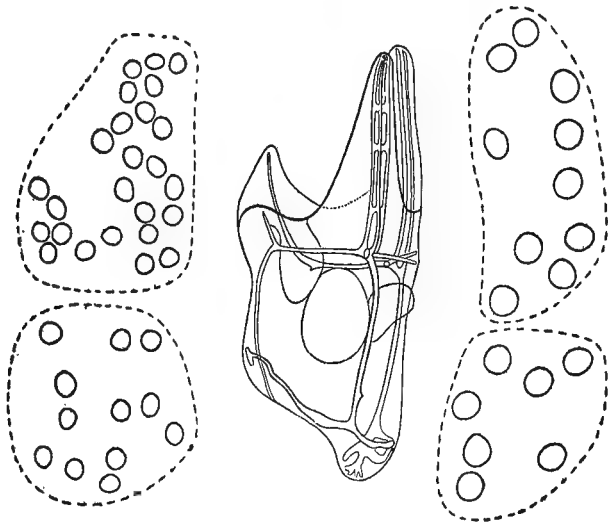

FIG. 101.—Larval sea urchin seen in side view. On one side it shows hybrid characters, on the other side it is maternal. The sizes of the nuclei on these two sides, as seen in the figure, coincide with the view that the hybrid side is diploid and the maternal side haploid. (After Herbst.)

The difference in the two cases can be safely attributed to the observed differences in the fate of the chromosomes, rather than to unrecognized differences in other elements brought in by the sperms.

Herbst's experiments contribute further evidence in favor of the chromosome interpretation. He caused the unfertilized eggs of a sea urchin to begin to develop parthenogenetically by adding a little acid to the sea water. After five minutes the eggs were removed to pure sea water, and sperm of another species, *Strongylocen-*

*trotus*, was added. The sperm entering the egg after its nucleus had started to divide, failed to reach the egg nucleus until the latter had divided (Fig. 100). The sperm nucleus then formed a nucleus of its own, that passed into one only of the daughter cells. This cell got two nuclei. The other cell had only one of the daughter nuclei. Such half-fertilized eggs give rise to larvæ that are maternal on one side, and hybrid on the other—or at least larvæ of this kind are sometimes found in such cultures (Fig. 101), and Herbst believes it is safe to refer them to the half-fertilized eggs. If so, there can be little doubt that the hybrid half owes its peculiarities to the presence of both sets of chromosomes in its cells, while the maternal half owes its peculiarities to its single set of maternal chromosomes. This in itself, however, shows little more than do whole hybrids and whole parthenogenetic eggs themselves, for the demonstration that it is the chromosomes and not other constituents of the sperm-nucleus that make the difference in the two sides rests on the unproven inference that if other things than the nucleus are involved they would be distributed equally throughout the cytoplasm, but produce no effects. There is no reason to suppose that they would be so distributed, and no evidence that they are. Hence the proof is not cogent, however probable it may seem that only the sperm-nucleus is responsible for those cases where there is a difference in the two sides.

On the whole, then, while I am inclined to give much weight to this evidence from experimental embryology as very favorable to the hypothesis that the chromosomes carry the hereditary characters, it is the genetic evidence that furnishes convincing evidence in favor of this view.

## CHAPTER XVII

### CYTOPLASMIC INHERITANCE

IN the preceding pages so much emphasis has been laid on the chromosomes as bearers of the hereditary material that it may appear that no very important rôle is left to the rest of the cell. Such an impression would be quite misleading; for the evidence from embryology appears to show that the reactions by means of which the embryo develops, and many physiological processes themselves, reside at the time in the cytoplasm. Furthermore, there is also genetic evidence to show that certain forms of inheritance are the outcome of self-perpetuating bodies in the cytoplasm, most of which go under the name of plastids. Recognition of plastid inheritance carries with it the idea that if there are such materials in the cytoplasm that are self-perpetuating they will have to be taken into account in any complete theory of heredity.

In the case of certain chlorophyll characters there is excellent genetic evidence to show that a peculiar kind of inheritance is due to the mode of transmission of plastids in the cytoplasm. There is a race of four-o'clocks known as *Mirabilis Jalapa albomaculata*, whose leaves are made up of patches of green and white. Such leaves are said to be checkered (Fig. 102, *b*). The amount of green, or of white, varies on different leaves, and on such plants there frequently appear leaves and entire branches that are green and others that are white. The white is due to the absence of green in the chlorophyll grains. Some cells have only green chlorophyll bodies, and others only white, still others may have the two mixed in various amounts.

Correns has shown that if the flowers on a green branch are self-fertilized they produce only green plants, and these again only green plants. Flowers on white

branches give only white offspring. Flowers on the checkered branches give some checkered plants, some white plants and some green plants. The proportions in which these different types arise varies according to the amount of green in the branch from which the self-fed seed came.

When the ovary of a flower on a green branch is fertilized by pollen from a white branch, the plant produced is green like the maternal branch. If the ovary of a flower on a white branch is fertilized by pollen from a

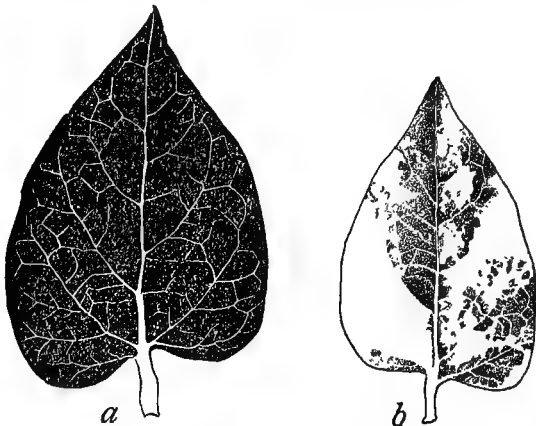

FIG. 102.—Green leaf and checkered leaf of four-o'clock. (After Baur.)

green branch the offspring is white like the maternal branch. These and other combinations show that this color inheritance is only through the mother. The results are explicable on the assumption that there are normal (green) chlorophyll bodies and abnormal chlorophyllless bodies, both kinds propagating in the cytoplasm by division, and that these two kinds are transmitted only through the egg-cell. The green or white color of the leaves of a given branch is an index of the kind of chlorophyll body that the ovaries will probably contain. At each division of the body-cells the chlorophyll grains present in it are sorted out more or less at random—hence from a cell that

contains both kinds, more white granules than green ones may at times get into a cell, and at other times only white granules will get into one daughter cell, so that a white branch arises.

In other species of plants that have white leaves and branches and green leaves and branches, the cross may give a different result. Thus in *Melandrium* and *Antirrhinum*, green by white gives green  $F_1$  (whichever way the cross is made), in  $F_2$  there are 3 green to 1 white plant. In this case the results can be explained as due to the action of genes in the chromosome on the production of chlorophyll in the cytoplasm—an action of such a kind that

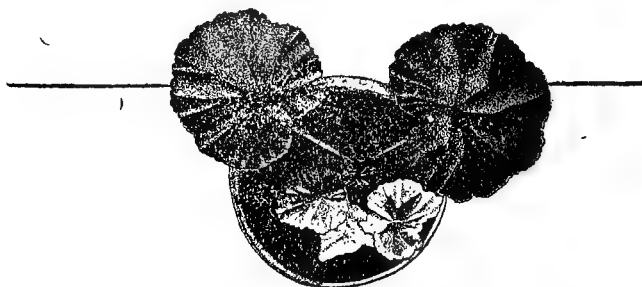

FIG. 103.—*Pelargonium* that gave rise to a white branch. (After Baur.)

the granules do not develop green color unless the (normal) gene is present, in single dose at least. In this case, even if the eggs only transmit plastids, the  $F_1$  individual from a white-leaved mother by a green-leaved father is green, because the paternal nucleus introduces a gene that causes the green color to develop in the plastids. It is the segregation of the genes in the germ-cells of the  $F_1$  individual that leads to the 3:1 ratio in  $F_2$ , and not the distribution of the plastids as in the preceding case.

The most peculiar case is that of *Pelargonium* described by Baur. White leaves and branches, and green leaves and branches occur on the same plant (Fig. 103). Self-fertilized seeds from each breed true to color of branch. White to green gives a different result, *viz.*,

mosaic seedlings with patches of green and white on stems and leaves (Fig. 104). When these seedlings grow into plants, the color of the leaves will depend on the color of that part of the stem from which the terminal bud, and lateral buds grow out. If a bud lies in a green part of the stem the new part will be green (Fig. 104, *a*): if the new bud lies in a white part of the stem the new part will be white (Fig. 104, *c*): and if it lies in a partly green, partly white region the new part will have some white, some

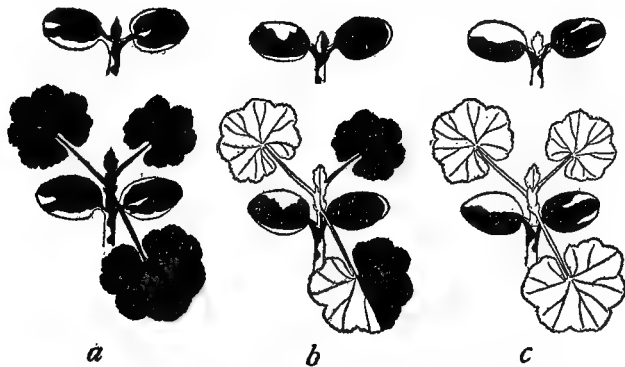

FIG. 104.—Diagram to show how a sectorial chimera may be produced. If the terminal bud has come from a region of the seedling entirely green, all of the future leaves will be green, *a*; if from a region without chlorophyll, all the future leaves will be white, *c*; but if the terminal bud lies partly in one, partly in the other region, some white and some green leaves will arise, *b*. (After Baur.)

green parts (Fig. 104, *b*). The only explanation that is suggested by Baur is that in this plant the plastids are transmitted both by the egg and by the pollen. The white plant with defective plastids contributes part of the plastids in the fertilized egg, the green plant with normal plastids the other part. The fertilized egg contains therefore both kinds of plastids. During division of the egg and embryo, the granules become irregularly distributed in the cells. Whenever a cell gets only defective granules, it and its descendants are white, producing white parts: when a cell gets mostly or only green granules, it and its descendants are green, producing green parts. Hence



arise the checkered seedlings from which white or green branches grow out.

The preceding facts and theories relating to plastid inheritance show that if any element outside the nucleus has the power to propagate itself it may be transmitted through the egg, and even possibly through the sperm (pollen) also. There is no contradiction here in any sense to Mendelian inheritance but only an additional type of inheritance that can be studied by as exact methods as those used in Mendelian work. The chief difference between chromosomal and plastid inheritance lies in the orderly sequence of the distribution of the genes in all divisions by means of the mitotic figure, whereas the plastids are supposed to be shuffled about at random to the daughter cells (partly because their division period does not correspond with that of the cell). This haphazard distribution of the plastids at any and all divisions is in striking contrast to the sorting out of the genes that occurs only at one specific cell-division when the germ-cells pass through the maturation stage. Hence the orderliness of Mendelian inheritance as contrasted with the more irregular procedure in plastid inheritance.

To embryologists familiar with the fact that differentiation of the egg is closely associated with the cleavage pattern, it was a natural inference that in the cytoplasm lay the inherited characteristics that gave form to the embryo, and even to all of its essential features. Little room would seem to be left for the action of the chromosomes except to fill in the details of the characters already outlined by cytoplasmic activity. This view might be laconically referred to as the theory of the "Embryo in the Rough," or more generally as the "Theory of the Organism as a Whole." Boveri discussed some such view (1903), and at first considered it favorably. It has since been seriously discussed by others. Boveri pointed out that when a horse is crossed to an ass it makes no difference which way the cross is made, for both egg and sperm

bring in the characteristics that make the organism first a bilateral one, then a vertebrate, then a mammal, and, lastly, a perissodactyl. In all these aspects, both parents agree, and beyond these limits hybridizing is impossible. Whatever the germ develops into must contain these common characters. The important point to determine, Boveri thought, is whether the *species* characteristics are or are not in the nucleus. He concluded, after discussing the pros and cons, that it is doubtful if these preformed qualities of the egg-protoplasm extend beyond the larval periods, but that in general all characteristics that distinguish the individual from all others of its species and from the characteristics of related species are inherited through the chromosomes. Later he restated his conclusion as follows: "All essential characteristics of the *individual* and of the *species* are epigenetic, and the determination is brought about through the nucleus." Conklin at one time expressed even more sharply the idea that group characteristics may be inherited in a different way from specific characters in the following paragraph:

We are vertebrates because our mothers were vertebrates and produced eggs of the vertebrate pattern; but the color of our skin and hair and eyes, our sex, stature, and mental peculiarities were determined by the sperm as well as by the egg from which we came. There is evidence that the chromosomes of the egg and sperm are the seat of the differential factors or determiners for Mendelian characters, while the general polarity, symmetry and pattern of the embryo are determined by the cytoplasm of the egg.

In another statement, however, Conklin takes what seems to me to be more nearly a correct view in regard to the question, *viz.*, that "There is no doubt that most of the differentiations of the egg cytoplasm have arisen during the ovarian history of the egg, and as a result of the interaction of nucleus and cytoplasm; but the fact remains that at the time of fertilization the hereditary potencies of the two germ-cells are not equal, all the early stages of development, including the polarity, symmetry, type of

cleavage, and the pattern, or relative positions and proportions of future organs, being foreshadowed in the cytoplasm of the egg-cell, while only the differentiations of later development are influenced by the sperm. In short, the egg cytoplasm fixes the general type of development, and the sperm and egg nuclei supply only the details." If, as implied, the egg nucleus at first has already produced its effect on the cytoplasm, it has done something more than supply the details; and as to the sperm nucleus I should substitute nearly all the stages of development later than the gastrula. Moreover, sex is certainly one of the fundamental characters of the organism, yet it appears to be determined at fertilization by the chromosomal combination formed at that time. Conklin later abandoned his earlier interpretation.

Quite recently, in his book on "The Organism as a Whole," Loeb has discussed the question as to whether the protoplasm of the egg is "the future embryo in the rough," the sperm furnishing only the "individual characters." Loeb suggests that the "specificity of the species" must be due to their proteins, and that the "heredity of the genus is determined by proteins of a definite constitution differing from the proteins of other genera. This constitution of the proteins would therefore be responsible for the genus heredity. The different species of a genus have all the same genus proteins, but the proteins of the species of the same genus are apparently different again in chemical constitution and hence may give rise to the specific biological or immunity reactions." The possible relations of these considerations to heredity are summed up in the following paragraph:

It is thus doubtful whether or not any of the constituents of the nucleus contribute to the determination of the species. This in its ultimate consequences might lead to the idea that the Mendelian characters which are equally transmitted by egg and spermatozoön determine the individual or variety heredity, but not the genus or species heredity. It is, in our present state of knowledge, impossible to cause a spermato-

zoön to develop into an embryo, while we can induce the egg to develop into an embryo without a spermatozoön. This may mean that the protoplasm of the egg is the future embryo, while the chromosomes of both egg and sperm nuclei furnish only the individual characters.

The evidence from Mendelian heredity is adverse to any such distinctions as those made by the three authors referred to above. We find in them, I think, an echo of an old and somewhat mystical conception of fundamental distinctions between order, family and generic characters of animals and plants—distinctions that even most systematic writers recognize to-day as little more than conventions that change from group to group. In the second place, since the cytoplasm of the egg has been under the influence of its own nucleus with a paternal and a maternal group of chromosomes there is no direct means of determining whether its characteristics are due to such an influence or have always been free from it. The fact that sperm of a foreign species does not change the cytoplasm of the egg at once is to be expected even from a chemical viewpoint. Mendelian workers can find no distinction in heredity between characteristics that might be called ordinal or specific, or fundamental, and those called "individual." This failure can scarcely be attributable to a desire to magnify the importance of Mendelian heredity, but rather to experience with hereditary characters. That there may be substances in the cytoplasm that propagate themselves there and that are outside the influence of the nucleus, must, of course, be at once conceded as possible despite the fact that, aside from certain plastids, all the Mendelian evidence fails to show that there are such characters. In a word, the distinction set up between generic versus *specific* characters or even "specificity" seems at present to lack any support in fact.

## CHAPTER XVIII

### MATERNAL INHERITANCE

THERE is a kind of inheritance shown by eggs and embryos, sometimes called maternal inheritance, that is not the same as plastid inheritance, even although the latter is maternal in another sense. Nor is this so-called maternal inheritance to be confused with cases of inheritance in which all or some of the paternal chromosomes fail to function, leaving the embryo at the mercy of its maternal set alone. Nor should it be confused with sex-linked inheritance where the son gets certain characters only from the mother, because he gets his single sex-chromosome from her.

“True” maternal inheritance relates to peculiarities of the egg or larva that are due to materials already present in the egg-cytoplasm when the egg is laid. For example, if pigment is scattered in the egg, it may collect in certain regions after fertilization, and produce color in them, as does the yellow pigment in the egg of *Cynthia*, studied by Conklin. In this ascidian, much of the yellow pigment is carried at the moment of fertilization to that part of the egg that later goes into the muscle of the tail. If the sperm used to fertilize such an egg should come from a species without pigment in the egg, the inheritance of color of the young embryo would obviously be entirely maternal. In cases like this one, the formed material, or any substance producing such materials, is already present in the cytoplasm, but whether it has always been free from nuclear influence must be shown by other tests. In only one cross, *viz.*, in the silkworm, has a third generation been raised, and until this has been done in others we cannot know whether we are dealing in them with plastid or with deferred nuclear influence (“maternal inheritance”).

In certain races of the domesticated silkworm moth, Toyama has shown that pigment develops in the embryonic membrane (serosa) which, seen through the egg-shell, gives a specific color character to the embryo. It is not clear from Toyama's account whether the pigment is present at first, scattered in the cytoplasm, and collects later at the surface, or whether it develops only after the embryo develops. When races are crossed with characteristic but different embryonic membranes, the color of the hybrid is like that of the maternal race only.

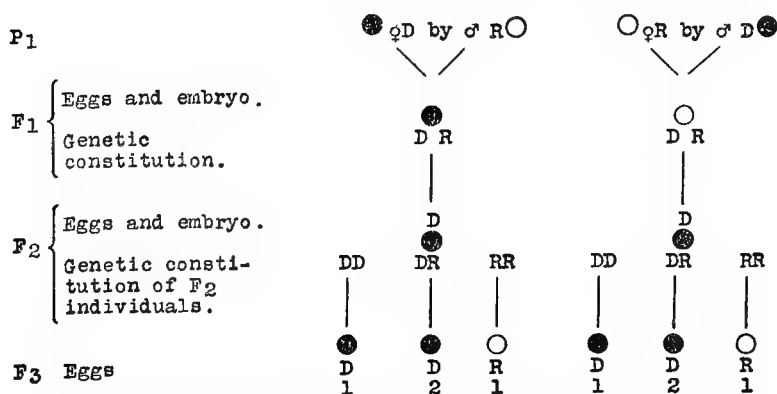

FIG. 105.—Diagram to illustrate maternal inheritance. The black circle stands for a dominant character affecting the serosa coat of the embryo.

If adults ( $F_1$ ) are raised from these eggs, it is found when they in turn produce embryos, that the color of their embryonic membrane is determined by the dominant character of the preceding generation that had been carried in the chromosomes, irrespective of whether it came in from the father or the mother (Fig. 105). That the result is really chromosomal is shown by still another generation in which some of the females show the dominant character in the membranes of their embryos and others no color in the ratio of 3:1.

It appears therefore in this case, the only one known that furnishes critical evidence, that maternal inheritance

does not differ in any essential respect from ordinary Mendelian heredity.

A peculiar case that in some respects and in certain combinations appears to be maternal inheritance, is shown in the character of the seed of corn (*Zea mais*).

The endosperm of maize is produced, as in some other plants, at the time of fertilization—one pollen nucleus unites with the egg to form the embryo, another pollen nucleus unites with two nuclei in the embryo-sac to produce the endosperm whose cells, therefore, are triploid. Floury corns have an endosperm, that is almost wholly made up of cells containing “soft” starch, while flint corns have only a small amount of soft starch in the centre of the seed which is surrounded by a large amount of hard “corneous” starch. Hayes and East have shown that if a floury corn be used as the mother and a flint corn as the father, the seeds are floury like those of the pure race of floury corn. If a flint corn be used as the mother and a floury corn as the father, the seeds are flinty. In both cases there is apparently maternal inheritance, at least as far as the endosperm is involved, which is not, however, a part of the embryo proper. If the *seeds* from races of the foregoing crosses are sown and the plants allowed to self-fertilize, the following results are obtained: The  $F_1$  derived from floury ♀ by flint ♂ produces both floury and flint in  $F_2$  in the ratio of 1:1. The  $F_1$  flinty reciprocal cross gives exactly the same result. The explanation of the  $F_1$  and  $F_2$  results is as follows: If the factor for flinty be  $F$ , and that for floury be  $f$ , then in the first cross the endosperm is  $ffF$  and in the reciprocal cross  $FFf$ . Since  $ffF$  is floury and  $FFf$  flinty it follows that two doses of floury dominate over one dose of flinty, and conversely two doses of flinty dominate over one dose of floury.

The  $F_1$  *embryo*, however, in each of the crosses has only one  $F$  and one  $f$  factor ( $Ff$ ). Its gametes are  $F$  and  $f$ , and so are its endosperm nuclei which, as shown by Weatherwax have the same reduced formula as the ovules

in the embryo sac. Hence half the embryo sacs are  $F$  and half  $f$ . The former,  $F (+F)$ , fertilized by  $F$  pollen gives  $FFF$  endosperm, by  $f$  pollen give  $FFf$ ; the latter,  $f (+f)$ , fertilized by  $F$  pollen gives  $ffF$  endosperm, by  $f$  pollen  $fff$  endosperm. The four kinds of endosperm fall into two classes, soft and hard, in the ratio of 1:1 in the  $F_2$  seeds.

There are races of maize with yellow dominant endosperm and others with recessive white. If the mother belongs to a yellow race and the father to a white one, the  $F_1$  endosperm is yellow like the mother. In the reciprocal cross it is also yellow. If, however, races with floury seeds are used, the  $F_1$  yellow endosperm in the former cross is somewhat paler than the pure yellow of the yellow race. Races with purple or with red endosperm crossed to white give the same results, except that in these crosses the quantitative effects seen in the floury flint crosses are not observed, for, one dose of the dominant (purple) to two doses of white gives the same color as two doses of purple to one dose of white.

There are two kinds of maize with white endosperm. These when crossed together give  $F_1$  colored endosperm. In these cases one race has one of the factors for color, and the other, another complementary factor—like the two white sweet peas. There is also a race with a dominant white endosperm factor. The occurrence of these kinds of whites led to some confusion in the earlier experiments of Correns on endosperm inheritance. The word *Xenia*, that had earlier a different meaning, is used to-day for these cases of double fertilization in which the pollen has an influence on the seed (the endosperm) that is not a part of the  $F_1$  plant itself. East and Hayes sum up the results given above (exclusive of the floury-flint cross) as follows:

When two races differ in a single visible endosperm character in which dominance is complete, *Xenia* occurs only when the dominant parent is the male; when they differ in a single visible endosperm character in which dominance is incomplete, or in two characters both of which are necessary for the development of the visible difference, *Xenia* occurs when either is the male.



In cases in which a foreign sperm may start development but take no further part in it, the resulting embryo is like the maternal race. Here we are dealing not so much with maternal inheritance, but rather with a special kind of parthenogenesis. Such eggs, however, rarely go beyond the cleavage stages.

The rate of cleavage of an egg fertilized by foreign sperm usually coincides with that of the species to which the egg belongs. Since the cytoplasm of the egg has, prior to fertilization, always been under the influence of its own nucleus, this relation is what might be expected. It is necessary to study eggs from an  $F_1$  generation in such cases in order to judge how far paternal chromosomes may influence the cleavage. It is thinkable, for example, that a spermatozoön might bring in a factor dominant for rate of cleavage, but because this factor had not had time to influence the cytoplasm its effect would not show in the  $P_1$  cross. In the  $F_1$ , on the other hand, the paternal character might prove dominant. Both Driesch and Boveri have shown in the sea urchin that the rate of cleavage, the pigmentation, and the kind of gastrulation are entirely or largely determined by the egg—they differ in opinion only as to how soon the influence of the sperm can be seen.

At the time when the larval skeleton is formed most observers agree that the influence of the foreign sperm makes itself felt. Most of the accounts of the skeleton of hybrid sea urchins describe it as intermediate in structure, but one that varies widely under different external conditions. Tennent has shown, in fact, that the character of the hybrid larval skeleton is so greatly influenced by the alkalinity or acidity of the sea water that it can be artificially thrown towards one or the other side—maternal or paternal. Loeb, King and Moore have attempted to determine whether the larval skeleton has dominant characters in certain parts and recessive ones in other parts. They crossed the sea urchins, *Strongylocentrotus Franciscanus* and *S. purpureus*. Both the straight cross and its

reciprocal showed neither a great predominance of the characters of the paternal race, nor of the maternal race, but rather certain characteristic features of *purpuratus* and others of *Franciscanus*. The larval characters appeared to be dominant or recessive taken singly. Until an  $F_2$  generation can be raised it is obviously hazardous to speak here of Mendelian dominance and recessiveness of characters that are based on  $F_1$  observations alone, especially since it is becoming more and more apparent that many  $F_1$  characters are more or less intermediate, and there are no general grounds for expecting pure dominance or recessiveness.

Many crosses have been made between different species of fish, and in some of these the young, at the time of hatching, are maternal. It has generally been supposed that such cases are due to the absorption of the paternal chromosomes at the first or at later cleavage stages. Loss of chromosomes has in fact been recorded in several of these cases of maternal inheritance. On the other hand, Miss Pinney's observations, summarized in the following table,

Cross	Development Results	Chromosomal Behavior
Ctenolabrus ♀ X Fundulus ♂	Development cases during gastrulation.	Early mitotic behavior is prevalingly normal.
Ctenolabrus ♀ X Stenotomus ♂	Many hatching embryos of the maternal type.	Early mitoses are normal.
Ctenolabrus ♀ X Menidia ♂	Advanced development.	Early mitoses are normal.
Ctenolabrus ♂ X Fundulus ♀	One hatching embryo reported. Many advanced embryos—maternal type.	Abnormal nuclear behavior occurs.
Ctenolabrus ♂ X Stenotomus ♂	Development ceases during gastrulation.	Abnormal mitosis predominant.
Ctenolabrus ♂ X Menidia ♀	Two hatching embryos reported. Maternal type.	Abnormal mitosis is of frequent occurrence.

show that the maternal type may appear not only when the *early* mitoses are abnormal, but in one case at least when they are normal. It is quite possible, therefore, that while

early loss of the paternal chromosomes may account for some of the cases of maternal embryos, there may also be cases where the chromatin may divide normally but fail to produce any conspicuous effects on the cytoplasm sufficiently soon to become apparent in the young fish. In this connection the tobacco crosses described by Goodspeed and Clausen may be recalled. In these cases it was a particular group of chromosomes, regardless of whether it was of paternal or of maternal origin, whose "reaction system" dominated in the  $F_1$  hybrid.

## CHAPTER XIX

### THE PARTICULATE THEORY OF HEREDITY AND THE NATURE OF THE GENE

THE attempt to explain biological phenomena by means of representative particles has often been made in the past. The superficial resemblance of the theory of the gene to some of the older theories, long since abandoned, has furnished the opponents of the Mendelian theory of heredity an opportunity to injure the latter by pretending that the modern idea of the gene is the same as the older ideas of Herbert Spencer concerning physiological units, of Darwin relating to pangenes, and especially of Weismann about biophors. There is no need for such confusion, for even a little knowledge of the evidence on which the old and the new views rest ought to have sufficed to make evident some important and essential differences. It need not be denied, however, that there is an historical connection between the mediæval theory of preformation and the particulate theory of heredity. Bonnet, one of the best known adherents of preformation, believed at first in "whole" germs, but later admitted that pieces of germs might be stowed away in regions of the body likely to be injured. Weismann, also, the most prominent modern adherent of preformation, held that whole germs, *ids*, are present in the germ-plasm, each standing for a whole organism—each (or most or one?) becoming unravelled as the embryonic development proceeded. In fact, Weismann's entire theory was invented primarily to explain embryonic development rather than genetics. Its connection with the modern idea of the germ-plasm is little more than an analogy—for reduction in Weismann's original

sense meant the sorting out of the wholes of ancestral germ-plasms with which he peopled the chromosomes.<sup>1</sup>

The danger of any appeal to a theory of representative particles obviously lies in the ease with which by its means any phenomenon might be accounted for, if the theorizer is allowed to endow the particles with any and all the attributes that he wishes to use in his explanation. It was because Bonnet, Spencer, and Weismann assigned arbitrarily attributes to the ultimate particles of living matter, that these views appear to-day highly speculative. The different kind of evidence to which the modern theory of the gene appeals is what I wish to emphasize here.

#### THE EVIDENCE FOR THE GENE

The evidence that Mendelian inheritance rests on the distribution of separate elements has already been given. The numerical results obtained in the second generation from any Mendelian cross involving a pair of contrasted characters, find their explanation on the assumption that the two original germ-plasms (or some element in them) separate cleanly in the germ-cells of the  $F_1$  hybrid. Tested by back-crossing the assumption is verified. Recombining the  $P_1$ ,  $F_1$ ,  $F_2$  individuals in all possible ways also gives results consistent with the very simple assumption that whatever it is that causes one race to produce one character, and another race another character, the two separate in the hybrid in such a way that equal numbers of germ-cells of each kind are produced. Up to this point the results do not tell us whether the two germ-plasms separate as wholes—one from the other—or whether only some part or parts behave in this way. But when two or more

---

<sup>1</sup>The nominal adoption (1904) toward the end of his career of hereditary units in the Mendelian sense did not go deep. Weismann still adhered to his view of dissociation of the ids as their most characteristic feature—the only one in fact for which they were originally invented. The evidence on which Mendelian units rest has nothing whatever to do with this cardinal doctrine of Weismann's teaching.

pairs of contrasted characters are involved in the same cross, we get further information as to the situation.

For example, Mendel showed that when peas that are both yellow and round are crossed to peas that are both green and wrinkled, there appear in the  $F_2$  generation not only the original combinations, but also recombinations of these, *viz.*, yellow and wrinkled; and green and round (Fig. 106). Here also the numerical results 9:3:3:1 can be explained on the theory that the representatives of each pair of characters separate in the germ-plasm, and that the separation of each pair is independent of what takes place in the other pair. Obviously it can no longer be whole germ-plasms that separate, but there must be different pairs of elements in the germ-plasm that assort independently of each other. It has been found that this principle of independent assortment may apply to a considerable number of pairs of characters segregating at the same time. The only restriction that is found is in the case of linked pairs of characters. This relation will be considered later.

The independent assortment of the pairs of characters proves that the elements that stand for the characters in the two original germ-plasms may separate from each other. If each such pair of characters represented one of the pairs of homologous chromosomes, the evidence, so far considered, would be in accord with the view that the chromosomes were the ultimate units involved in the processes of segregation and assortment. The chromosomes are, as has been shown, independent units in the germ-plasm. But as *Drosophila* shows, there are many more pairs of characters than there are pairs of chromosomes.

It is obvious that if the chromosomes are the ultimate units involved, and remain intact, there could be no more *independent pairs* of characters than there are pairs of chromosomes. In animals and in plants there are no cases known where there are more independent pairs than there are chromosomes, so that, as has been pointed

out in another connection, this evidence may also be appealed to as favorable.

The behavior of linked pairs shows, however, that the analysis must be carried further, because, despite linkage, the elements that went in together may be separated. The evidence shows that while some linked genes separate almost as freely as do independent genes, so that their linkage to each other can only be safely determined by their relation to certain other genes, other linked genes may separate not once in a hundred times, or even less often. Between these extremes all intermediate linkage values are found. These results indicate that the chromosomes do not represent the ultimate elements that may be separated out of the original complex (germ-plasm).

We are led, then, to the conclusion that there are elements in the germ-plasm that are sorted out independently of one another. The *Drosophila* evidence shows at least several hundred independent elements, and as new ones still appear as frequently as at first, the indications are that there are many more such elements than those as yet identified.

These elements we call genes, and what I wish to insist on is that their presence is directly deducible from the genetic results, quite independently of any further attributes or localizations that we may assign to them. It is this evidence that justifies the theory of particulate inheritance.

So far as representative elements in the germ-plasm are concerned, we might be content to rest the case on the preceding analysis of the results; but recent work has now advanced far enough to tempt us to assign further attributes to the genes than those deducible from the preceding analysis alone. Some of these attributes may appear better established than others, but, all together, they give a consistent body of data, and have therefore a certain value and use.

It has been pointed out that the evidence shows not only that the genes are carried by the chromosomes, but that there may be interchanges between paternally-derived and maternally-derived chromosome pairs. The evidence shows that this interchange is a normal feature of the germ-cell, and not peculiar to hybrids, or to a heterozygous condition of the pairs.

This analysis leads then to the view that the gene is a certain amount of material in the chromosome that may separate from the chromosome in which it lies, and be replaced by a corresponding part (and by none other) of the homologous chromosome. It is of fundamental significance in this connection to recognize that the genes of the pair that interchange do not jump out of one chromosome into the other, so to speak, but are changed by the thread breaking as a piece in front of or else behind them, but not in both places at once, as would be the case if only a single pair of allelomorphs were involved each time.

That the gene does not stand for the whole length of the chromosome between two other known genes is shown by the fact that new genes arising by mutation in the intermediate region do not affect the character of the gene already known. This fact recurring continually in *Drosophila*, where new mutations frequently appear, reassures us that the idea of the gene as a very small part of the thread is a legitimate conclusion, even if we can not tell how large or how small that region is.

### 1. THE MANIFOLD EFFECTS OF EACH GENE

If we examine almost any *mutant* race, such as the race of white-eyed *Drosophila*, we find that the white eye is only one of the characteristics that such a mutant race shows. The productivity of the individual is also much affected, and the viability is lower than in the wild fly. All of these peculiarities are found whenever the white eye emerges from a cross, and are not separable from the



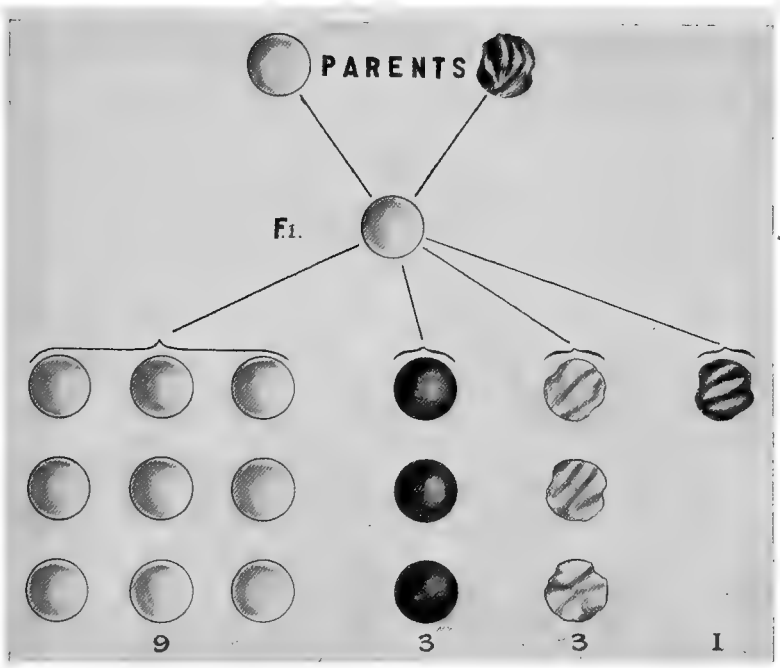

FIG. 106.—Diagram to show the inheritance of two pairs of Mendelian characters, viz., yellow versus green peas, and round versus wrinkled skin in garden peas.



white-eyed condition. It follows that whatever it is in the germ-plasm that produces white eyes, also produces other modifications as well, and modifies not only such "superficial" things as color, but also such "fundamental" things as productivity and viability. Many examples of this manifold effect are known to students of heredity.

It is perhaps not going too far to say that any change in the germ-plasm may produce many kinds of effects on the body. Clearly then the character that we choose to follow in any case is only the most conspicuous or (for purposes of identification) the most striking or convenient modification that is produced. Since, however, these effects always go together, and can be explained by the assumption of a single unit difference in the germ-plasm, the particular difference in the germ-plasm is more significant than the character chosen as its index.

## 2. THE VARIABILITY OF THE CHARACTER IS NOT DUE TO THE CORRESPONDING VARIABILITY OF THE GENE

All characters are variable, but there is at present abundant evidence to show that much of this variability is due to external conditions that the embryo encounters during its development. Such differences as these are not transmitted in kind—they remain only so long as the environment that produces them remains. By inference the gene itself is stable, although the character varies; yet this point is very difficult to establish. The evidence is becoming stronger nevertheless that the germ-plasm is relatively constant, while the character is variable.

## 3. CHARACTERS THAT ARE INDISTINGUISHABLE MAY BE THE PRODUCT OF DIFFERENT GENES

We find, in experience, that we cannot safely infer from the appearance of the character what gene is producing it. There are at least three white races of fowls, produced by different genes. We can synthesize white-

eyed flies that are somatically indistinguishable from the ordinary white-eyed race, yet they are the combined product of several known color-producing genes. The purple eye color of *Drosophila* is practically indistinguishable from the eye colors maroon and garnet. In a word, we are led again to units in the germ-plasm in our final analysis rather than to the appearance of a character.

#### 4. INFERENCE THAT EACH CHARACTER IS THE PRODUCT OF MANY GENES

We find that any one organ of the body (such as an eye, leg, wing) may appear under many forms in different mutant races as a result of changes of genes in the germ-plasm. It is a fair inference, I think, that the normal units—the allelomorphs of the mutant genes—also often affect the same part. We have found about 50 different factors that affect eye-color, 15 that affect body-color, and at least 10 factors for length of wing in *Drosophila*.

If, then, it is a fair inference that the units in the wild fly, that behave as Mendelian mates to the mutant genes, also affect the same organ that the mutant gene affects, it follows that many genes, and perhaps a very large number, are involved in the production of each organ of the body. It might perhaps not be a very great exaggeration to say that every gene in the germ-plasm affects several or many parts of the body; in other words, that the whole germ-plasm is instrumental in producing each and every part of the body.

Such a statement may seem at first hearing to amount almost to an abandonment of the particulate conception of heredity, but on the contrary, the statement conveys a very important idea in the modern conception of the nature of the genes and the way they act.

*The essential point here is that even although each of the organs of the body may be largely a product of the entire germ-plasm, yet this germ-plasm is made up of units that are independent of each other in at least two*

*respects, viz., in that each one may change (mutate) without the others changing, and in segregation and in crossing over each pair is separable from the others.*

##### 5. "THE ORGANISM AS A WHOLE," OR THE COLLECTIVE ACTION OF THE GENES

Several writers have stated their objections to the particulate theory of heredity on the grounds of their belief that the organism is a "whole." If this phrase is intended to mean that there is some sort of an entity or entelechy that directs all processes that go on in each living thing, there is little to be said here, except that this very old idea has not been found profitable as a working hypothesis. It is improbable, however, that many biologists mean to appeal to any such vitalistic agency when they speak of the "organism as a whole," but have rather some other idea in mind. I am inclined to think that certain phenomena of embryonic development are responsible for the slogan of the "organism as a whole." In the segmentation of the egg the entire chromosomal complex is distributed to every cell in the body. Each cell *inherits* the whole germ-plasm. How then it may be asked can the result depend on the particular make-up of its chromosomes rather than on the action of the whole material?

Granted that we know very little about the interactions between the cells that cause some of them to differentiate in one direction, others in other directions, yet if one fertilized egg should begin its development with one kind of material, and another egg with a different material, should we not expect the end products to be different, irrespective of the way in which the materials were present in the original egg? No matter where the differences may lie, *i.e.*, whether in the nucleus or in the cytoplasm, there is nothing here in any way inconsistent with this particulate theory of the composition of the germ-plasm. On the contrary, the only conclusion that seems at all reasonable

is that if differences are present at the beginning, the end product is expected to be correspondingly different. So much is clear. But why, it may still be asked, are not two organisms that are different at the start, if only in some one difference, different later in every part, rather than in only some one small part such as in a red or in a white eye. The answer is, of course, that the first difference was such that it affected principally a particular process, *viz.*, the formation of the red pigment of the eye, and to a less degree, or not at all, other chemical processes. This seems to me an entirely consistent view.

Perhaps the difficulty in accepting the particulate theory lies in the erroneous idea that the specific effect comes into action only at the moment when the red pigment is about to form. But no one has, so far as I know, made such a claim. It may be true, but it has not been proven, and is moreover not in any way essential to the assumption of the particulate theory. On the contrary, as our knowledge of Mendelian heredity has increased many cases have been found where a special factor-difference affects not only one part of the body but many parts. It is true that the particulate theory as held at one time by Roux and for a long time by Weismann was used to explain the differentiating changes in the segmenting egg and embryo in the sense that development was looked upon as a process that resulted immediately in the sorting out of the inherited chromosomal particles to the different parts of the organism. Differentiation resulted in the sorting out of particular genes to particular groups of cells whose development they controlled. But the cytological evidence in regard to the chromosomes gave no evidence in support of the view, and the evidence from the experimental study of embryology seemed to entirely disprove any such basis for the developmental phenomena. In fact, Roux himself abandoned this view in the light of the brilliant experiments of Driesch and of other embryologists.

Our present conception of the relation of the germ-plasm to developmental phenomena has then only a most superficial resemblance to the older theories. The newer point of view may be summed up in a few words, and has in fact been stated already. First, that each gene may have manifold effects on the organism, and second, that every part of the body, and even each particular character, is the product of many genes. The evidence for these two conclusions has been so repeatedly referred to in the preceding pages that it is not necessary to go over it again. but it may be worth while to emphasize that these two conclusions are not pure speculations, but derived from the evidence itself. It may also be well to point out that even if the whole germ-plasm—the sum of all the genes—acts in the formation of every detail of the body, still the evidence from heredity shows that this same material becomes segregated into two parts during the maturation of the egg and sperm, and that at this time individual elements separate from each other largely independently of the separation of other pairs of elements. It is in this sense, and in this sense only, that we are justified in speaking of the particulate composition of the germ-plasm and of particulate inheritance.

There is a further idea deducible from well-known facts of physiology that may at first sight seem to give an impression that the organism is a "whole." This is the action of one part of the body on other parts by means of substances set free in the blood, called hormones. Many of them arise through the action of certain so-called endocrine glands. But the relation here is so obviously different from the problem dealt with as particulate inheritance that it calls for little more than passing notice. It may, however, not be without interest to refer to one case of the kind in which an endocrine secretion depends on a genetic factor inherited in the same way as are other genetic factors. There is a race of poultry known as Sebrights (Fig. 107, *a*) in which the

males are always hen-feathered. This means that the feathers of the neck and back and the tail coverts of the Sebright cock are nearly like those of the hen of this breed, and not long and pointed as in the ordinary cock. When Sebrights are crossed to game bantams (which have ordinary males), the  $F_1$  males are hen-feathered. When these are inbred the two types reappear in the  $F_2$  males. One, or probably two, Mendelian factor differences account for the results.

It has been shown that when the testes are removed from the Sebright male, he then develops at the next moult (or at once if some feathers are plucked out) the long and highly colored feathers of the ordinary male (Fig. 107, *b*). It is probable, therefore, that the testes of the Sebright produce an internal secretion that inhibits in the male the full development of certain feathers. This makes him like the hen, and in this connection it is interesting to note that when the ovary of a hen of an ordinary breed is removed she also develops the full plumage of the cock, as Goodale has clearly demonstrated. Whether the testes of a male are of the sort to develop this inhibiting substance, depends on the presence in the cells of the testes of certain genetic factors. These factors are present, presumably, in all the cells of the body, but if they are, their activity is ineffective in the absence of secretions produced by the testes, as is shown by the castrated Sebright becoming cock-feathered. Whether this substance belongs in the heterogeneous group of substances called hormones—defined by the kind of action they produce rather than by any chemical peculiarity—or to the groups of enzymes that have a more or less specific action, cannot be stated.

The foregoing discussion touches upon the question as to whether there is any evidence that the genes themselves are to be regarded as enzymes.\* In almost all of the

---

\* Inadequate as is our knowledge of the physico-chemical processes that go on in development, it is enough to indicate that many processes are at work.



recent papers (Beijerinck, Riddle, Goldschmidt) that touch on this question it is argued, from the evidence of the specific enzymes supposed or demonstrably involved in the production of some final stage in the chemical reaction that leads to the character in question, that the gene itself is the same specific enzyme. The argument shifts back and forth from unit-character to unit-factor. The reasonable position to take in this matter is, in my opinion, that stated by Loeb and Chamberlain (1915), "The hereditary factor in this case must consist of material which determines the formation of a given mass of these enzymes, since the factors in the chromosomes are too small to carry the whole mass of the enzymes existing in the embryo or adult." It should not be forgotten, however, that the evidence in favor of enzyme action as the most important developmental process is by no means established, and even were the evidence for this view adequate, the stages between such action and the ultimate chemical nature of the gene may be too great to be cleared at a single bound. Some of the modern work on the chemical composition of the nucleus indicates that extremely complex protein compounds *may* be present in it—even though some of the split products obtainable from it may be relatively simple. It seems to me therefore that it is both premature and highly speculative at present to tie up the genetic evidence concerning the genes with hypotheses concerning their chemical composition. I urge this, but at the same time I realize of course that we should endeavor to obtain as soon as possible better knowledge as to the chemical nature of the chromatin.

Another question concerning the gene, that has been raised, is whether it is to be regarded as something having a definite molecular constitution, or whether the gene is to be regarded as a quantity of material fluctuating about a mode—its definiteness representing only a general tendency for the same frequency distribution to recur in each species. From the nature of the case such a question

is speculative, and would have little importance were it not that, by imputing to the advocates of Mendelian heredity the assumption of absolute fixity to the gene, attempts have been made to throw the burden of proof that the genes are "constant" on the advocates of Mendelism.

So far as the genetic evidence is involved, I see at present no way of deciding whether the gene has a definite molecular constitution, or is only something that fluctuates under the condition of its occurrence about a mode. Interesting as it might be to speculate about these alternatives, it seems futile to do so at present, but there is one implication that I should like to examine. If the gene is a chemical molecule it is not evident how it could change except by altering its chemical constitution. Its influence, *i.e.*, the chemical effects it produces, might, however, be altered by changing other substances with which the material it produces reacts. This is the idea involved in the theory of "modifying genes."

But if the gene is a fluctuating amount of something it might seem that any "fluctuation" that is present at one time might be perpetuated by selection, and that a further fluctuation in the same direction might be utilized for a further advance, etc. It may be pointed out that this picture of the process is quite fanciful, and its success would depend largely on a denial of the premise as to the nature of the gene, *viz.*, that it is of a fluctuating amount. Johannsen's facts contradict an interpretation of the fluctuations of the character being due to a new modal position of the gene standing for that character. And his facts furnish the only crucial evidence we have at present.

A

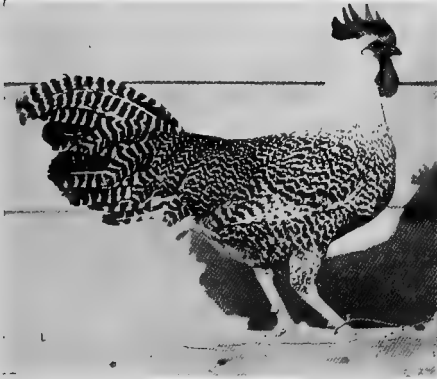

C



B



D

FIG. 107.—A. Adult hen-feathered Campine male. B. Adult male of same race that had been castrated while still a young bird. When it became older it developed cock-feathering. It resembles the male of another race of Campines in which the male is normally cock-feathered. C. Adult hen-feathered Sebright male. D. Adult male Sebright, that had been castrated while still a young bird. It developed cock-feathering when it became older.



## CHAPTER XX

### MUTATION

CONCERNING the origin of the germinal differences that give rise to mutant characters very little is known at present except, (1) that they appear infrequently, (2) that the change is definite from the beginning, (3) that some of the changes at least are recurrent, and (4) that the difference between the old character and the new one is small in some cases and greater in others. I do not think that any of the work purporting to produce specific mutational changes has succeeded in establishing its claims, at least in the sense that we can pretend at present to control the appearance of specific mutant changes, and until this is done we can not hope to find out very much as to the nature of these changes. Our study of the germ-plasm is largely confined, therefore, for the present, to a study of transmission of the genes, to the kinds of effects they produce on the organism, and to the special relations of the genes in the chromosomes where they are located.

Concerning the frequency of mutation there is a slowly increasing body of evidence showing in some animals and plants how often or how rarely changes of this kind take place. The impression prevails that mutation is less rare in some species than in others, and while I am inclined to think that this may be true, not much value can be ascribed to such impressions; for it is not improbable that the frequency with which mutations are found is often directly in proportion to the number of individuals examined and to familiarity with the type in question, so that the smaller changes are not overlooked. The discovery of new mutant types in almost every plant and animal that has been carefully examined indicates at least the very general occurrence of definite mutations, and the

great variety of types shown by nearly all of our domesticated animals and plants—varieties that follow Mendel's law—appears to give further support to the view that the process of mutation is widespread.

One of the most interesting phenomena connected with mutation is the recurrence of the same change. It has long been recognized that certain "sports" such as albinos and melanic forms are found again and again in nature. In insects there are many records of the sporadic appearance of the same type, such as the light form (lacticolor) of the moth *Abraxas*. It is true that not all such appearances are to be accepted offhand as the first appearance of the mutative change, since when these are recessive it is probable in most cases \* that the actual mutation occurred several generations before the mutated genes came together to produce the mutant character. But granting this, it is at least probable that the same type has appeared in many cases independently. The only evidence that can be relied upon in such cases is from pedigreed cultures, followed up by evidence that the mutants that look alike are really due to mutations in the same locus. Fortunately there is actual evidence, both for plants and for animals, that can be appealed to to show that the same mutations recur.

The most extensive evidence is from *Drosophila melanogaster*. One of the first mutants that appeared, viz., white eyes, has appeared anew in our cultures about three times, in cultures known to be free from it before and not contaminated. The same mutant has been found by several other observers. The eye-color vermilion has appeared at least six times; the wing character called rudimentary, five times; cut wing has been found four times; truncate wing has frequently appeared, but has not necessarily been always produced by the same change. Certain characters such as notch wings, that have

---

\* Recessive mutations in the X-chromosomes of the XX-XY type may appear in the male in the next generation.

appeared quite often, represent, it seems, a peculiar change whose relation to the changes that stand behind other mutant characters is not yet worked out.

In plants the best evidence is that reported by Emerson for Indian corn. Emerson has shown that when a race of corn (*Zea mais*) having red cobs and red seeds is crossed to a race having white cobs and white seeds only, the two original combinations appear in the second ( $F_2$ ) generation giving plants with red cobs and red seeds and plants with white cobs and white seeds. Either a single factor determines that both cob and seed are red in one case and white in the other, or if the color of each part is due to a separate factor these factors are completely linked. Now striped seeds with white cobs sometimes mutate to red seeds and red cobs. The new combination (red and red) acts as a unit toward the other known combinations. Therefore a single factor must have changed, for, if not, mutation must occur in two (or more) closely linked factors, *i.e.*, for seed and cob color at the same time, which is highly improbable.

In forms propagating by sexual methods it cannot be told whether mutation has occurred in one locus or in both homologous loci at the same time, because in the egg one of each pair of genes is lost in the polar body, and irrespective of whether one or two mutated genes were present only one member of the pair is left in the ripe egg; and in the sperm the chance of any one sperm reaching the egg is so small that it is unlikely that the difference between one sperm or two sperms having the mutated locus could be detected. It is true that of the twelve dominant mutants that have appeared in *Drosophila* each appeared at first in a single individual—never two—which might appear to favor the single locus view, but this evidence is too meagre to be significant. Mutants from recessive genes usually come to light in about a quarter of the offspring of a given pair. This means that both parents were heterozygous for the mutant gene, but this gene

must have arisen at least one generation earlier, and have been carried over into the two heterozygous individuals in question.

It would be a point of capital importance if it could be determined beyond doubt that at times recessive mutant genes change back to the original (wild type) gene, or even if a recessive gene could mutate to a dominant one. The appearance of the wild type in a pure culture of a mutant race can be accepted as good evidence of such a change only when every possibility of contamination by the wild type is excluded, and this is difficult to regulate. In our cultures we have come across such cases, but have not ventured to exploit them, since wild-type flies are always present in the laboratory, and hence the discovered form may have arisen through accidental contamination. Thus even when a red-eyed yellow fly appeared in the white-eyed yellow stock there is the barest chance that a yellow red-eyed fly, or an egg of such a fly, had somehow gotten into the stock. Certainty can be attained only when a stock, pure for *several* mutant characters, reverts to the normal in one of these characters, and not in the others. Only one case of this kind that is above suspicion has been as yet recorded. This is a mutant stock in which, as May has recorded, reversion to the wild type occurs with such frequency that there can be no chance of error. The stock in question, bar eye, is a *dominant* mutant and the reversion therefore is to the recessive wild type of eye (round eye). The change back to normal is complete, since such individuals give only normal offspring. When such a mutant chromosome comes from the mother and goes into a son he has normal (wild type) eyes; when it comes from the father, and goes to a daughter, she is heterozygous for bar eye. Baur has recently recorded the appearance of recessive (?) mutants from self-fertilized plants (snap-dragon) that bred true at once. Punnett has described a similar case (1919). The result can be accounted for, if a mutation occurred in only a single chromosome far enough



back in the germ-tract to give rise, after reduction, both to pollen and to ovules, each one carrying the mutated genes. Such an interpretation is supported by the evidence from *Drosophila*, where, although mutations are much more numerous, no such cases have been observed, and none such would be expected if mutation occurs in a single chromosome at a time, since here the germ-cells come from separate individuals.

Probably the most important evidence bearing on the nature of the genes is that derived from multiple allelomorphs. Now that the proof has been furnished that the phenomena connected with these cases are not due to nests of closely linked genes, we can properly appeal to these as crucial cases. As already explained, in ever-increasing numbers of animals and plants, series of genes have been found in each of which mutant characters with the same normal allelomorph have been found. These mutant characters of each series are also allelomorphs of one another—only two ever existing in the same individual. Obviously, not all such mutants can be due to the absence of a factor present in the germ-plasm of the wild type, since only one kind of absence is thinkable. If to save the situation for the theory of presence and absence it be assumed that only a part of the original gene is absent, and a different part in each case, then nothing is gained by the admission; and while this may be true it is equally possible that the genes change in other ways. It is not essential that we should specify the nature of the change, but simpler to look upon the mutant gene as due to some kind of change or changes that have taken place in the original germ-plasm at a specific locus—there is nothing known at present to furnish even a clue as to the nature of this change.

The demonstration that multiple allelomorphs are modifications of the same locus in the chromosome, rather than cases of closely linked genes, can come only where their origin is known, and at present this holds only in



type if crossed to *a* or to *b*. Similarly for a mutation in the fourth and in the fifth normal gene. Now this is exactly what does *not* take place when members of an allelomorphic series are crossed—they do not give the wild type, but one of the other mutant types or an intermediate character. Evidently independent mutation in a nest of linked normal genes will not explain the results if the new genes arise directly each from a different normal allelomorph.

But suppose, as shown in Fig. 4 (line *C*) after a mutation had occurred in the first gene a new mutant, *b*, arose from a new gene, and from *b* a mutation arose in a third gene *c*, and *c* similarly gave rise to *d*; then *a* crossed to *b* will give *a* (or something intermediate if the heterozygote is an intermediate type). Likewise *c* crossed to *b* will give *b*, or *c* crossed to *a* will give *a*, etc. If mutant allelomorphic genes in a series such as *C*, *a*, *b*, *c*, *d*, *e*, arise as successive steps, *i.e.*, *Ca* to *Cb* and *Cb* to *Cc*, etc., then the hypothesis of closely linked genes would seem to be a possible interpretation of the data, but if they do not arise in this way, but by independent mutations from the wild type (or even from each other, but not *seriatim*), then they must be due to mutations in the same gene: for, to assume that they are not, requires that, when the second mutation took place both gene *a* and gene *b* mutated at the same time, and that when *c* appeared three genes mutated, when gene *d* appeared four; when gene *e* five genes mutated at once, four of them being mutant genes that have already arisen independently. Such an interpretation is excluded, since it is inconceivable, even in a readily mutating form like *Drosophila*, that five mutations could have occurred at the same time in distinct but neighboring loci. As has been stated, the evidence from *Drosophila* shows positively that multiple allelomorphs arise at random.

Only two members of a series of multiple allelomorphs can be present in any one individual, and in the case of

genes carried by the sex-chromosome only one can exist at a time in the sex that has only one of these chromosomes. In the individual with two mutant allelomorphs one of them replaces the normal allelomorph of the ordinary Mendelian pair. The two mutant allelomorphs behave towards each other in the same way as does the normal towards its mutant allelomorphs. It is doubtful whether we can conclude anything more from this relation of Mendelian pairs than we knew before,<sup>1</sup> although there is at least a sentimental satisfaction in knowing that both normal allelomorphs can be replaced by mutant ones without altering the working of the machinery.

The linkage relation of each member of a series of multiple allelomorphs to all other genes of its chromosome is, of course, the same. While the theory of identical loci requires this as a primary condition it is not legitimate to use this evidence as a proof of the identity of the loci, because it is not possible to work with sufficient precision in locating genes by their relation to other linked genes to distinguish between identical loci and close-linked genes.

The question of lethal genes has attracted in recent years increasing attention, both on account of their frequency and because of a curious complication they may produce in hiding the effects of other genes also present. In *Drosophila* we have records of more than 20 sex-linked lethals, and about 15 not sex-linked, and scattering records of many others. Gametic lethal genes are those that destroy eggs or pollen cells that contain such genes. Zygotic lethal genes affect the embryo, the larva, or the adult, so that it dies. In the case of the garden plant known as double "stocks," the genetic evidence obtained by Miss Saunders indicates that certain kinds of pollen are not produced, and presumably die because of a contained factor. The same factor does not kill the ovules,

---

<sup>1</sup> The substitution by crossing over really furnishes as good a demonstration of this point.

which may therefore transmit the recessive lethal gene to half the progeny. How far the frequent occurrence of imperfect pollen grains in many species of plants is due to such factors is still uncertain.

Belling found that while the Florida velvet bean produces normal pollen grains and ovules, and the Lyon bean, another bean of the same genus, also produces normal gametes, the  $F_1$  hybrid contains 50 per cent. abortive pollen grains, and possibly about 50 per cent. of the ovules are abortive. In the second generation ( $F_2$ ) half of the pollen grains of half of the plants are abortive. The other half of the plants have normal pollen grains. This is the result expected if there are present in one of the species the factors  $AAbb$ , and in the other species the factors  $aaBB$ , the viable gametes in the  $F_1$  generation being those containing  $Ab$ ,  $Ba$ , and the two gametes that die being  $AB$ ,  $ab$ .

Other observers have made records of abortive pollen in hybrids, but without knowing the condition of the pollen in the parents the interpretation of the results is doubtful, for, as Jeffrey has emphasized, abortive pollen is a characteristic of many wild species. There is one fact of capital importance recorded by several botanists, *viz.*, that the degeneration of the germ-cells only takes place after the tetrad has been produced, and only in some of the cells of each tetrad. In other words, the lethal effect is not observed until the chromosomes have undergone reduction. It is obvious that if there is present a recessive lethal for the germ-cells (or for any cells, in fact), it causes no injury in the presence of its normal allelomorph, but kills when the counter-effect of its partner is removed.

Tischler found in a hybrid currant that tetrad formation was normal, and that the shrinking of the pollen grains occurred afterwards. Geerts found that one-half of the pollen grains of *Oenothera Lamarckiana* degenerate, and that half of the embryo sacs abort in the tetrad

stage. Other related (wild) species and genera of the evening primrose have also been found to have some abortive pollen and ovules.

Complete or nearly complete abortion has been seen in other hybrids; *viz.*, by Rosenberg in the sundew, by Osawa in the Satsuma orange, by Goodspeed and others in the hybrid tobacco (*N. tabacum* by *N. sylvestris*), by Jesenko in the wheat-rye hybrid, and by Sutton in the hybrid between the Palestine pea (*Pisum humile*) and the edible pea. These cases may be in part the same phenomenon and in part a different one connected with failure of the chromosome to conjugate or to be properly distributed during the maturation divisions.

The "yellow mouse case" is an example of a *zygotic lethal* effect. The gene that produces the dominant yellow color is lethal in double dose, so that all homozygous yellow mice die, as Cuénot first discovered, and as has been more positively demonstrated by the work of Castle and Little. There is some evidence indicating that these homozygotes die as young embryos. Little has also shown that black-eyed white mice carry a lethal, that acts in the same way. In *Drosophila* there is a sex-linked recessive lethal factor that causes the development of tumors in the larvæ, destroying every male larva that contains the sex-chromosome carrying this gene. This effect, discovered by Bridges, has been the basis for an extensive series of experiments by Miss Stark. The gene is present in the X-chromosomes; it follows the rules for all sex-linked genes in its inheritance. The females of the stock are of two kinds: One has the lethal in one sex-chromosome, and its normal, dominant allelomorph in the other. Such a female has survived because the effect of the lethal gene is counteracted by the effect of its normal allelomorph. Half of her sons get the affected chromosome. All such sons develop the tumor—one or more melanitic growths that appear in the imaginal discs or in other parts of the larva. The other sons get the other chromosome with the

normal allelomorph. They never produce a tumor and never transmit the disease. The same mother that gave these two kinds of sons—having been fertilized by a normal male, since no affected males exist—produces also two kinds of daughters, one containing the gene for the tumor (and its normal allelomorph), the other having two normal genes. The former transmit the disease as just explained, the latter daughters are perfectly normal and do not transmit the disease.

Other lethal genes kill the pupæ, a few of them even allow the fly occasionally to come through, but such flies rarely propagate. Certain races of *Drosophila* have sterile or nearly sterile females, other races sterile males. The sterility is here lethal in so far as it affects the germ-cells. Some effects on other characters are also generally to be seen.

The presence of a lethal gene near to, *i.e.*, linked to, another mutant gene may affect the kinds of individuals that appear because owing to the linkage the other mutant character fails to appear, except when crossing over takes place. Some examples of this relation may be given. There is a mutant race called beaded (Fig. 109) in which the margin of the wing is irregularly broken, giving the appearance of a beaded edge. The gene for beaded is dominant, and lethal when homozygous.

As in the case of the yellow mouse, only the hybrid (heterozygous) combination exists, and consequently when two beaded flies mate they produce two beaded to one normal fly, as shown in Fig. 110. Here the first pair of vertical lines stand for the pair of third chromosomes present in the egg before its reduction. The two genes here involved, that for beaded and its allelomorph for normal, are indicated at the lower end of the vertical lines. The two corresponding chromosomes in the male are represented to the right of the last. After the ripening of the germ-cells each egg and each sperm carries one or the other of these chromosomes. Chance meetings of egg

and sperm are indicated in the figure by the arrow-scheme below, which gives the combinations (classes) included in the four squares. The double dominant  $BB$  is the class that does not come through. The result is two beaded (heterozygous) to one normal fly.

The beaded stock remained in this condition for a long time; although selected in every generation for beaded, it did not improve, but continued to throw 33 per cent. of normal flies. Then it changed and bred nearly true.

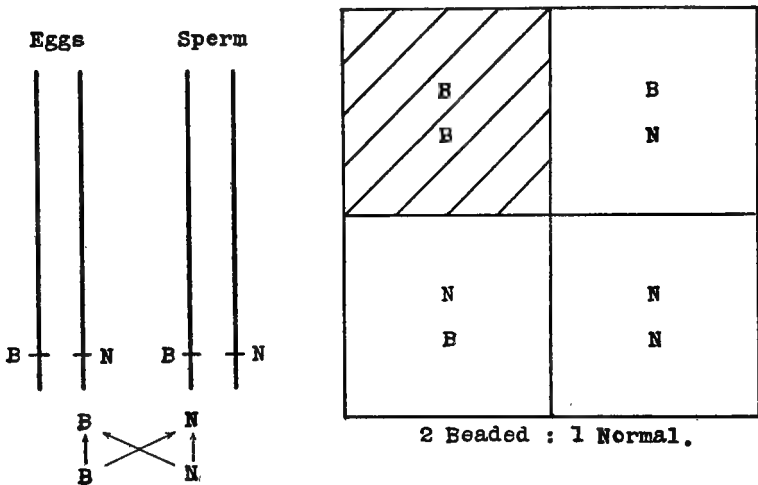

FIG. 110.—Diagram showing the relation of the chromosomes (represented by the vertical rods) in a cross of "beaded" by "beaded." Flies homozygous for beaded die as indicated by the cross-hatched square.

The change must have been due to the appearance of another lethal factor (now called lethal three, here  $l_1$ ) in Fig. 111). Such a gene was found in the race when studied later by Muller.

The lethal gene that appeared in the beaded stock was also in the third chromosome, and in the chromosome that is the mate of the one carrying the gene for beaded, *i.e.*, in the *normal* third chromosome of the beaded stock. The lethal gene lies so near to the level of the beaded-normal



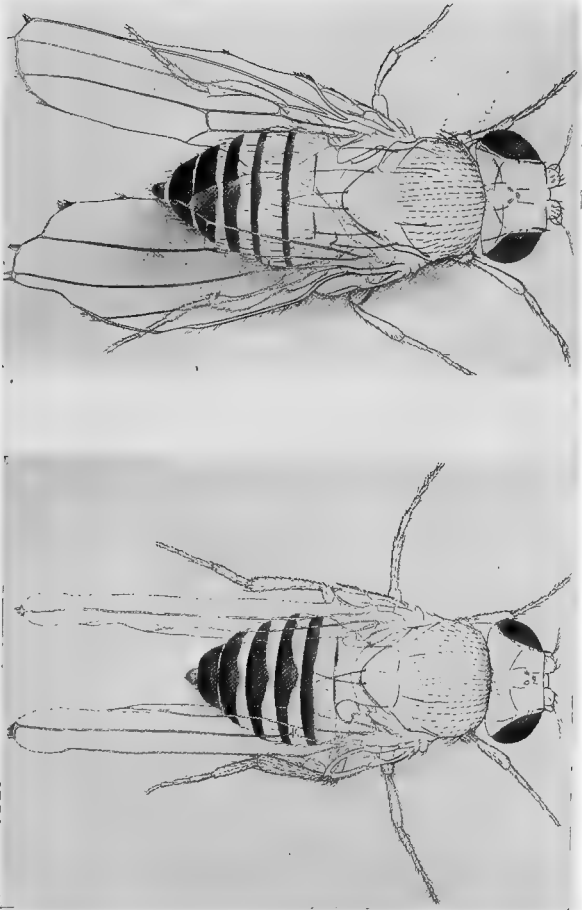

Fig. 109.—Two flies (*Drosophila*) with beaded wings.



pair of genes that almost no crossing over takes place between the levels occupied by the two pairs. These relations are illustrated in the next diagram, Fig. 111. Here again the two pairs of vertical lines to the left represent the two third-chromosome pairs in the female and to the right in the male. The location of the two pairs of genes involved,  $N-l_1$  and  $B-N$ , are indicated. These combinations give the four classes in the squares of which two classes die, *viz.*,  $NNBB$  (pure for beaded) and  $l_1l_1NN$

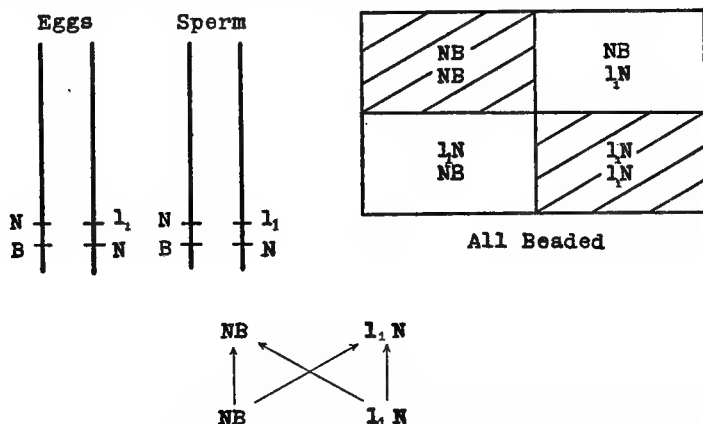

FIG. 111.—Diagram to show how the appearance of a lethal near beaded causes the stock to produce only beaded except for the small number of crossovers, as shown by the next diagram.

(pure for lethal three). The result is that only beaded flies come through, and since all these are heterozygous both for  $B$  and  $l_1$ , the process is self-perpetuating.

If the preceding account represented all of the facts in the case, the stock of beaded should have bred perfectly true, but it has been shown in *Drosophila* that crossing over between the members of the pairs of genes takes place in the female. Hence we should expect a complication due to crossing over here unless the level of the two pairs of genes was so nearly the same as to preclude this possibility. In fact, in addition to the beaded flies the

stock in this condition alone should give 10 per cent. of crossing over, *i.e.*, it should still produce a small percentage of normal flies. It so happened, however, that there was present in the stock a third gene that lowers the amount of crossing over in the female to such an extent that, for the two "distances" here involved, practically none takes place. When it does, a normal fly appears, but this is so seldom that such an occurrence, if it happened in a domesticated form of which the wild type was unknown,

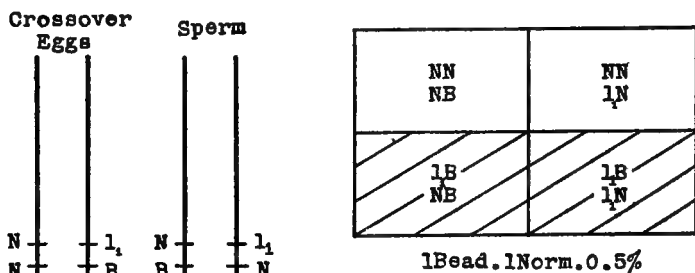

FIG. 112.—Diagram showing the results of crossing over in a stock containing both beaded and lethal, as shown in Fig. 111.

would be set down as a mutation like that shown by the evening primrose.

The third factor that entered into the result is not unique, for Sturtevant has shown that crossover factors are not uncommon in *Drosophila*. The analysis that Muller has given for beaded, while theoretical, is backed up by the same kind of genetic evidence that is accepted in all Mendelian work. It makes an assumption but one that can be demonstrated by any one who will make the necessary tests. It is also possible to produce at will other balanced lethal stocks that will "mutate" in the sense that

they will throw off a small predictable number of a "mutant" type—a type that we can introduce into the stock for the express purpose of recovering it by such an apparent mutation process.

For example, dichete is a third chromosome dominant wing-and-bristle character and, like beaded, a recessive lethal. Sturtevant bred flies with the gene for dichete in one of the third chromosomes and with a gene for the recessive eye-color, peach, in the other for several genera-

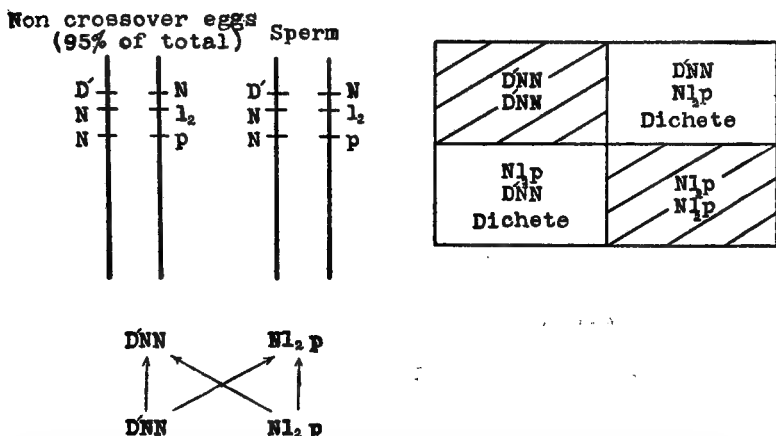

FIG. 113.—Diagram illustrating how in the presence of a dominant factor, dichete, and a lethal in its homologous chromosome at about the same level, together with another factor, peach-colored eyes (p), gives the result shown in the squares. No peach appears in the offspring except where crossing over takes place as shown in the next diagram.

tions. A lethal appeared by mutation in the peach-bearing chromosome very near the level of the dichete gene in the opposite chromosome.

The order of these genes is shown in Fig. 113. This is then a balanced lethal stock that throws only dichete flies,<sup>2</sup> except for a small percentage of dichete peach flies due to crossing over. The result for the non-crossover classes is shown in the square to the right. Only two of the four classes come through: the two that die are the

<sup>2</sup> Very rarely a crossover not-dichete fly will appear.

one pure for dichete and the one pure for lethal. The surviving classes continue to produce the same kind of offspring since they are, like the parents, heterozygous for the two lethal factors. But the factors are not near enough together to prevent crossing over, which occurs in about 5 per cent. of cases between the lethal and peach genes. The next diagram, Fig. 114, shows how when crossing over takes place in the female, there result four

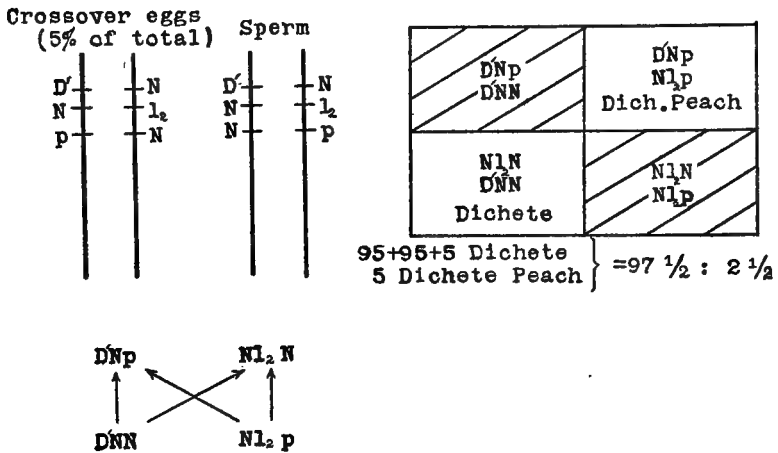

FIG. 114.—Diagram illustrating crossing over of factors shown in Fig. 113.

classes (see squares), of which two die (as before), and of the two that survive one is dichete peach. Taking both non-crossover and crossover results together, the expectation is  $95 + 95 + 5$  dichete to  $5$  dichete peach or  $97\frac{1}{2}$  to  $2\frac{1}{2}$ . This stock then breeds true for dichete without showing the gene it carries for peach eye-color except in a small percentage of cases, and if the peach-eyed fly should be unable to establish itself in nature, like some of the *Enothera* mutants, the stock would not be changed by it, but continue to throw off a few "mutants" with peach-colored eyes.

Now this process is not what is ordinarily meant by mutation, for we mean by the latter that a new type has suddenly arisen in the sense that some change has taken place in the germ-plasm—a new gene has been formed. The process here described is one of recombination of genes shown by Mendelian hybrids, the only unusual feature being that all the phenomena involved do not come to the surface because many classes are destroyed by lethals.

The results are interesting also in another way. It has been assumed by those who think that *O. Lamarckiana* is

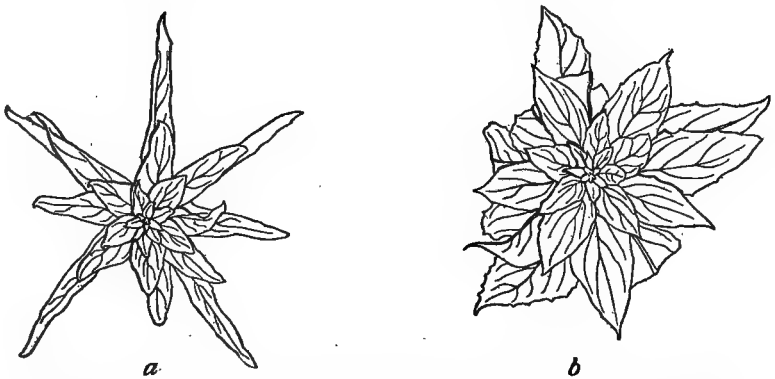

FIG. 115.—Rosettes of the twin hybrids of the evening primrose, the plant to the left is called *læta*, and that to the right *velutina*. (After De Vries.)

a hybrid that the mutant types are only the segregation products of the types or combinations that went in to produce the hybrid. But the *Drosophila* cases show that balanced lethal stocks may arise within stocks themselves by the appearance in them of lethal factors closely linked to other factors—new or old ones. When new genes arise in such lethal stocks the process may be one of true mutation, but the revelation of the presence of the gene is hindered by the lethal factors, so that when the *character* appears, it appears as a “new” mutant, but is in reality due to recombination of mutant genes that had arisen in an earlier generation. As a matter of fact, the first

appearance of even ordinary mutants, unless they be dominant, must come two or more generations after the mutation has taken place; for, the evidence indicates that mutation appears in only one chromosome at a time.<sup>3</sup> In the case of sex-linked genes, however, any mutation that takes place in one of the X-chromosomes of the mother is revealed if the egg containing it gives rise to a son, because he has but one X-chromosome and that comes from his mother.

The delayed occurrence then of mutants in balanced stocks is not different from the delay in other stocks—

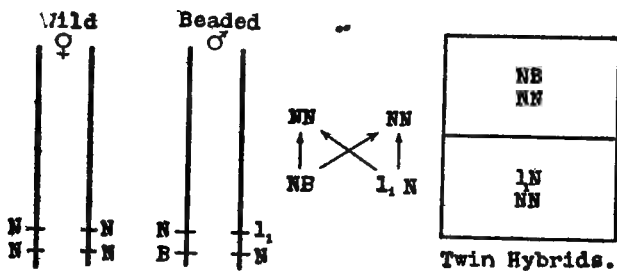

FIG. 116.—Diagram illustrating balanced lethals and twin hybrids.

only when the recombinations occur in balanced lethal stocks they must have been preceded by crossing over, which diminishes the number of mutants that appears. The number of mutants that appears is determined by the distance of the genes for the character from the nearest lethal gene.

One of the most interesting features of Lamarck's primrose arises when it is bred to certain other species or varieties. It gives rise to two kinds of offspring called Twin Hybrids, to which De Vries gives the names *læta* and *velutina* (Fig. 115). Now it is a feature

<sup>3</sup> If in self-fertilizing forms a mutation takes place so early in the germ-plasm that it gets into both eggs and sperm the new character may appear at once (see ante).



of balanced lethal stocks like beaded that they repeat precisely this phenomenon. For instance, if a beaded male is crossed to wild female, two kinds of offspring are produced, *viz.*, beaded and normal. A similar process would account for twin hybrids in *Œnothera* crosses. There is another peculiar phenomenon that has been described for crosses in the evening primroses, *viz.*, the occurrence in  $F_1$  of four types. This phenomenon, too, can be imitated in *Drosophila* by crossing balanced lethal dichete to balanced lethal beaded (Fig. 117).

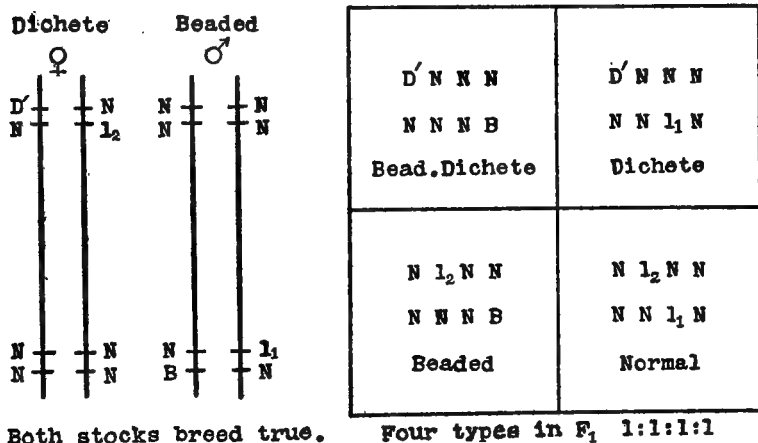

FIG. 117.—Diagram illustrating lethals and four types in  $F_1$ .

Other parallels might be cited, but these, I think, will suffice to indicate that the discovery of balanced lethal stocks may solve some at least of the outstanding difficulties of mutation and inheritance in *Œnothera*, and bring it into line with other groups. There are, of course, other peculiarities of the evening primrose that such zygotic lethals will not explain; such, for instance, as the 15-chromosome type, and *O. gigas*. But these cases are already on the road to solution.

The occurrence of other lethals, called *gametic* lethals,

that kill the germ-cells—gametes—before they are ready for fertilization, has already been invoked by De Vries and others to explain the peculiarity of “double reciprocal hybrids.”

#### IS THE DIRECTION OF MUTATION GIVEN IN THE CONSTITUTION OF THE GENES?

When writers have brought forward evidence of continuous and progressive change in a character, they have not concerned themselves with the analysis of the change in the germ-plasm that has brought it about—in fact, in most of these cases the possibility of advance in a principal gene or of advance through modifying genes has not been appreciated or even understood. Paleontologists who have in the main been the strong advocates of orthogenesis have based their conclusions on the observed advances in a character in the same series and in “parallel” series. They overlook the fact that to-day there is experimental evidence demonstrating that variations as small even as those they record have been shown to rest on mutational stages. If the progress has been in the direction of adaptation, natural selection of small mutant differences will completely cover their findings. If it is claimed that in some of these cases the orthogenetic series is not in the line of adaptive advance, the burden of proof lies heavily on their shoulders. Moreover, the fact, that recent work has made clear, that genes generally have more than a single effect on the organization, opens wide the door of suspicion, for the observed morphological progress might be a by-product of influences that have other and important, though unseen or unknown, effects. In a word, an orthogenetic series of changes does not in itself without a closer analysis than has as yet been furnished, establish that an *innate principle, urge, vis-a-tergo, “kick,” or vital “force”* is causing the successive moves. The genetic evidence concerning multiple factors must create at least a strong suspicion against the “will to

believe" in the mystic sentiments for which these terms always stand. That a progressive series of advances in a gene might take place with a consequent advance in the many characters involved is *thinkable*, especially if it could be shown that environmental changes cause parallel progress in the gene, and this in turn on the character. How *probable* this is the reader must decide for himself in the light of the very clear evidence that each character is affected by changes in many genes differently located in the germ-plasm, and that it is not a progressive change in one gene that makes selection possible, but changes in any one of many genes.

#### CHANCE MUTATION AND NATURAL SELECTION

The mutation process rests its argument for evolution on the view that among the possible changes in the genes, some combinations may happen to produce characters that are better suited to some place in the external world than were the original characters. Apparently this appeal to chance, like Darwin's appeal, has offended some of the adherents of the doctrine of organic evolution, because it has seemed to them inconceivable that chance could ever bring about the assembling of such an intricate piece of machinery as a highly complex organism. The attempt to mitigate the rude shock of the appeal to chance was made by Darwin by pointing out that evolution had been gradual and that the assemblage has not taken place out of chaos, but each stage has been built up on one a little less complex than the preceding one. Nevertheless the fact remains that persistent efforts continue to be made from time to time to introduce into the theory of evolution some sort of directive mystical agency. The Lamarckian theory has tried to bring about a more immediate relation between the organism and its environment of such a kind that the adaptive change that appears in the body as a result of a reaction between the environment and the animal or plant, is reflected into the germ-plasm. Bergson

has cut the knot by postulating an innate adaptive responsiveness of the animal to every critical situation that calls out a response. The adherents of orthogenesis appeal, apparently—in so far as they commit themselves—to some sort of innate principle that causes advance in complexity along one line, and they seem to hint at times even along directed lines of adaptation. Still more elusive are vague appeals made to some unknown principle—some sort of mysterious element, some “*Bion*,” resident in living material and peculiar to it that is *responsible* for evolution.

We are not concerned with any of these so-called agents, but there is a relation between chance and evolution shown by living things that has been largely neglected, or at least vaguely referred to, even by natural selectionists, that is of fundamental importance when evolution is treated as a phenomenon of chance.

This relation may be stated in a general way as follows: Starting at any stage, the degree of development of any character increases the probability of further stages in the same direction. The relation can better be illustrated by specific cases. The familiar example of tossing pennies will serve. If I have thrown heads five times in succession, the chance that at the next toss of a penny I may make a run to six heads is greater than if I tossed six pennies at once. Not, of course, because five separate tosses of heads will increase the likelihood that at the next toss a head rather than a tail will turn up, but only that the chances are equal for a head or a tail, so that I have equal chances of increasing the run to six by that throw, while if I tossed six pennies at once the chances of getting six heads in one throw are only once in 64 times.

Similar illustrations in the case of animals and plants bring out the same point. If a race of men average 5 feet, 10 inches, and *on the average* mutations are not more than two inches above or below the racial average, the chance of a mutant individual appearing that is 6 feet tall is greater than in a race of 5-foot men. If increase in height

is an advantage, the taller race has a better chance than the smaller one. This statement does not exclude the possibility that a short race might *happen* to beat out in height a taller race, for it might more often mutate; but chance favors the tall. In this sense evolution is more likely to take place along lines already followed, if further advantage is to be found in that direction.

A rolling snowball that already weighs 10 pounds is more likely to reach 15 pounds than is another that has just begun to roll. The chance that a monkey could change into a man is far greater than that an amoeba could make the transition. The monkey has accumulated, so to speak, so many of the things that go to make up a man that his chance of reaching that goal is vastly greater than the amoeba's.

There is also a peculiarity of animals and plants that assists greatly towards progress along lines already started. The individual multiplies itself, and a new mutant character that is advantageous becomes established in a large number of individuals, or even in all individuals of the race. The number of individuals increases the chance of a new random mutation along the path already taken. It is true that the chance of a random variation in the opposite direction is equally great, but as this, by hypothesis, is the less advantageous direction it will fail to establish itself in numbers.

Darwin built up his evidence for natural selection and even for evolution, on the *artificial* selection of *variations* of animals and plants under domestication. It is in this field that the student of Mendelism revels. Almost without exception he finds that the domestic races of animals and plants are built up by mutational differences. It is this evidence that to-day is a hundredfold stronger for the theory of evolution than it was in Darwin's time.

The slightest familiarity with wild species will suffice to convince any one that they differ from each other generally, not by a single Mendelian difference, but by

a number of small differences. The student of Mendelian heredity at least is not likely to fall into the error of identifying single Mendelian differences with the sum total of differences by which wild types and often even wild varieties differ from each other, but whenever he has had an opportunity to study these single differences in wild varieties he has found that they seem to originate and to be inherited in the same way as other Mendelian characters.

#### SPECIES AS GROUPS OF GENES

If related species have many genes in common they may be expected to produce at times the same mutants. In fact, it is not at all uncommon to find even in Mendelian literature such forms as albinos spoken of as though they represent the same mutation wherever it arises. Attractive as such a view appears, experience has shown that it is very unsafe to judge as to the nature of the mutation from the appearance of the character alone. Two different white-flowered races of sweet peas are known which give the wild purple-flowering pea when crossed, showing that they represent different mutations. Similarly, at least two recessive white races of fowls are known, as well as a third dominant white race. Three independent mutations have produced white birds. Whether albino mice, rats, rabbits, squirrels and guinea pigs have arisen through a mutation in a common gene cannot be determined because they cannot be crossed to each other. When we consider that many factors may combine to produce a given pigmented animal, and that a change in any one of them may affect the end result, it will be evident that the expectation would be against rather than for the conclusion that the same gene had changed in all cases. Only when it could be shown that a particular gene of the complex is more likely to change in a given direction than other genes of the complex would this interpretation become plausible.

There is evidence in *Drosophila melanogaster* showing that the same mutation to white eyes has occurred several times, and the additional and all-important proof has been obtained that it is the same locus that has produced the white-eyed mutant. This may appear to give some slight support to the view that albino mutants appearing in other related species may be due to the same mutative changes, but without additional evidence this conclusion is problematical.

In the mammals melanic individuals have been frequently described, but there is no direct evidence to show that they are due all to the same change. In the roof rat there is a black type that is dominant to the gray of this race, while the black type of the Norway rat is recessive to the gray of that race. It seems probable that they are different mutations, but not necessarily so.

Yellow in the mouse is dominant and lethal; two races of yellow rats are known, both recessive forms. The relation of yellow to black in mice is different from the relation of either of the yellows to black in the Norway rat. If the blacks are the same mutant the yellows are different; if either yellow of the rat is the same as the yellow of the mouse, the blacks must be different, etc.

The uncertainty of reaching any conclusion in regard to the nature of the mutation from the appearance of the character of the mutant is excellently illustrated in such a group of mutants as that of the fruit fly, where a considerable number of cases are known in which mutants that are almost indistinguishable externally have been shown to be due to mutations in different parts of the germ-plasm. There are five kinds of black mutants, three or more yellows and several eye colors that are practically indistinguishable. The evidence showing their difference is obtained from the results of crossing, where, as a rule (except, for example, cases of complete or incomplete dominants), reversion to the wild type occurs. In addi-

tion, the localization of the gene causing the modification shows them to be different.

The method of localizing genes offers an opportunity for obtaining evidence in regard to like-mutants in related species that cannot be crossed, and a step forward in this direction has been taken by C. W. Metz for other species of the genus *Drosophila*. In one species, *D. virilis*, he has found 12 mutants, and these fall into three groups of linked genes. Three of them, yellow, forked and confluent, resemble externally characters of *D. melanogaster*. Yellow and forked are sex-linked and look like the same characters in *melanogaster*. Confluent is like a second chromosome character of the same name in *melanogaster* in three respects: first, in that the structures are similar; second, in that the character is dominant in both forms; and, third, in that it is lethal in the homozygous state. The terminal position of yellow and the large amount of crossing over with forked are, roughly speaking, the same in both.

Even in this case further work is needed, first, because within the same species the occurrence of similar-looking characters due to different factors is known, *e.g.*, there are two genes for yellow color (yellow and lemon) in the first chromosome of *D. melanogaster* and in the same part of that chromosome, and second, because it is not to be expected that the number of crossovers would be identically the same between the same loci in different species, since marked variations are known within a single species. Unless such species can be crossed, the only convincing evidence that we can hope to get will be to establish the *same linear order* in the chromosome for several genes whose characters appear to be the same or similar.

Other evidence of a different kind also helps to make probable that the same mutations occur in different species. For example, in cases where a mutant gene produces a number of changes in different parts of the body, the probability that it is the same as one in a different species that causes the same modifications, is in propor-



tion to the number of the same kinds of change that they produce. The two following cases recorded by Sturtevant illustrate this relation:

Two species, *viz.*, *Drosophila melanogaster* and *D. funebris*, have each produced a mutation called notch. This character, notch, involves not only a notching at the end of the wings but also the thickening of the second and fifth veins of the wings, frequent reduction and roughening of the eyes, inequalities of the rows of hairs on the thorax, frequent doubling of the anterior scutellar bristles, and a recessive lethal effect. The character is also dominant and sex-linked. It is one of the commonest mutations in *melanogaster* and was the first to be picked out in *funebris*. So many peculiarities in common make it hard to believe that they do not represent the same genetic change. Another mutant also found in *D. funebris* that parallels one in *D. melanogaster* is called hairless, producing several similar effects in both. In both the factor is an autosomal dominant; it affects the hairs, certain bristles, and the second, fourth and fifth veins of the wings, and has a recessive lethal effect.

One of the most interesting ideas that De Vries brought forward in his mutation theory is that groups of "small species" or of varieties are made up of many common genes and differ in a relatively small number of genes. The genetic analysis of a group of smaller species would consist in finding out how the different genes are distributed amongst the members of this group. Phylogenetic relationship comes to have a different significance from the traditional relationship expressed in the descent theory; but this point of view is so novel that it has not yet received the recognition which we may expect that it will obtain in the future when relationship by common descent will be recognized as of minor importance as compared with relationship due to a community of genes.

## LITERATURE

- AGAR, W. E.: Parthogenetic and Sexual Reproduction in *Simocephalus vetulus* and other *Cladocera*. *Jour. Gen.*, 1914, iii.
- ALTENBURG, E.: Linkage in *Primula sinensis*. *Genetics*, 1916, i.
- BABCOCK, E. B., and R. E. CLAUSEN: Genetics in Relation to Agriculture. 1918.
- BAILEY, P. G.: Primary and Secondary Reduplication Series. *Jour. Gen.*, 1914, iii.
- BALTZER, F.: Ueber die Beziehung zwischen dem Chromatin und der Entwicklung und Vererbungsrichtung bei Echinodermenbastarden. *Arch. f. Zellf.*, 1910, v.
- BALTZER, F.: Die Bestimmung des Geschlechts nebst einer Analyse des Geschlechts-dimorphismus bei *Bonellia*. *Mitteil. Zoöl. Station Neapel*, 1914, xxii.
- BARTLETT, H. H.: Additional Evidence of Mutation in *Oenothera*. *Bot. Gaz.*, 1915, lix.
- BARTLETT, H. H.: The Mutations of *Oenothera stenomeris*. *Am. Jour. Bot.*, 1915, ii.
- BARTLETT, H. H.: Mutations *en masse*. *Am. Nat.*, 1915, xlix.
- BARTLETT, H. H.: Mass Mutation in *Oenothera pratincola*. *Bot. Gaz.*, 1915, lx.
- BARTLETT, H. H.: The Experimental Study of Genetic Relationships. *Am. Jour. Bot.*, 1915, ii.
- BATESON, W.: Materials for the Study of Variation, 1894, London.
- BATESON, W.: The Methods and Scope of Genetics, 1898, Cambridge.
- BATESON, W.: The Present State of Knowledge of Color-heredity in Mice and Rats. *Proc. Zoöl. Soc.*, 1913, ii.
- BATESON, W.: Problems of Genetics. *Yale Univ. Press*, 1913.
- BATESON, W.: Mendel's Principles of Heredity, third impression, Cambridge (Eng.) and New York, 1913.
- BATESON, W.: Address of the President, British Assoc. Adv. Sci. *Science*, 1914, n.s., xl, pp. 287-302; 319-334.
- BATESON, W.: Root Cuttings, Chimeras and Sports. *Jour. Gen.*, 1916, vi.
- BATESON, W., and PELLEW, C.: On the Genetics of "Rogues" among Culinary Peas. *Jour. Gen.*, 1915, v.
- BATESON, W., and R. C. PUNNETT: On the Interrelations of Genetic Factors. *Proc. Roy. Soc.*, 1911, lxxxiv.
- BATESON, W., and R. C. PUNNETT: The Inheritance of the Peculiar Pigmentation of the Silky Fowl. *Jour. Gen.*, 1911, i.

- BATESON, W., and R. C. PUNNETT: On Gametic Series Involving Reduplication of Certain Terms. *Jour. Gen.*, 1911, i.
- BATESON, W.; SAUNDERS, E. R.; PUNNETT, R. C.; HURST, C. C.; *et al.*: Reports (I to V) to the Evolution Committee of the Royal Society, London, 1902-1909,
- BAUR, E.: Das Wesen und die Erbliehkeitsverhältnisse der "Varietates albomarginatæ hort." von Pelargonium zonale. *Zeits. Abst. u. Vererb.*, 1909, i.
- BAUR, E.: Propfbastarde. *Biol. Centr.*, 1910, xxx.
- BAUR, E.: Ein Fall von Faktorenkoppelung bei *Antirrhinum majus*. *Verh. naturf. Ver. Brünn*, 1911, xlix.
- BAUR, E.: Vererbungs- und Bastardierungsversuche mit *Antirrhinum*—II. Faktorenkoppelung. *Zeits. Abst. u. Vererb.*, 1912, vi.
- BAUR, E.: Ein Fall von geschlechtsbegrenzter Vererbung bei *Melandrium album*. *Zeits. Abst. u. Vererb.*, 1912, viii.
- BAUR, E.: Einführung in die experimentelle Vererbungslehre 1914.
- BELLING, J.: Third Generation of the Cross Between Velvet and Lyon Beans. *Rept. Fla. A.E.S.*, 1913.
- BELLING, J.: The Mode of Inheritance of Semi-sterility in the Offspring of Certain Hybrid Plants. *Zeit. Abst. Vererb.*, 1914, xii.
- BELLING, J.: Inheritance of Pöd Pubescence and Partial Sterility in *Stibolobium Crosses*. *Rept. Fla. A.E.S.*, 1915.
- BENEDICT, R. C.: Some Modern Varieties of the Boston Fern and Their Source. *Jour. N. Y. Bot. Gard.*, 1915, xvi, 189.
- BENEDICT, R. C.: The Origin of New Varieties of *Nephrolepis* by Orthogenetic Saltation. I. Progressive Variations. *Bull. Torrey Bot. Club*, 1916, xliii, 5.
- BIFFEN, R. H.: Mendel's Laws of Inheritance and Wheat Breeding. *Jour. Agric. Sci. Cambridge*, 1905, i.
- BORING, ALICE M., and RAYMOND PEARL: The Odd Chromosome in the Spermatogenesis of the Domestic Chicken. *Jour. Exp. Zööl.*, 1914, xvi.
- BORING, A. M., and T. H. MORGAN: Luteal Cells and Henfeathering. *Jour. Gen. Phys.*, 1918, i.
- BOVERI, TH.: Ueber den Einfluss der Samenzelle auf die Larvencharaktere der Echiniden. *Arch. Ent. der Organismen*, 1903, xvi.
- BOVERI, TH.: Zellen Studien. Die Entwicklung dispermer Seeigel-Eier, etc. Jena, 1907.
- BOVERI, TH.: Ueber die Beziehung des Chromatins zur Geschlechtsbestimmung. *Sitz. Phys.-Med. Gesell. Würzburg*, 1908.
- BOVERI, TH.: Die Blastomerenkerne von *Ascaris megaloccephala* und die Theorie der Chromosomen-Individualität. *Arch. Zellf.*, 1909, iii.
- BOVERI, TH.: Ueber "Geschlechtchromosomen" bei Nematoden. *Arch. Zellf.*, 1909, iv.

- BOVERI, TH.: Ueber die Charaktere von Echiniden-Bastardlarven bei Hermaphroditismus. *Verh. Phys.-Med. Gesell. Würzburg*, 1911, xli.
- BOVERI, TH.: Ueber die Charaktere von Echiniden-Bastardlarven bei verschiedenem Mengenverhältnis mütterlicher and väterlicher Substanzen. *Verh. Phys.-Med. Gesell. Würzburg*, 1914, xliii.
- BRAUER, A.: Zur Kenntniss der Spermatogenese von *Ascaris megalocephala*. *Arch. mikr. Anat.*, 1893, xlii.
- BRIDGES, C. B.: Non-disjunction of the Sex-chromosomes of *Drosophila*. *Jour. Exp. Zoöl.*, 1913, xv.
- BRIDGES, C. B.: The Chromosome Hypothesis of Linkage Applied to Cases in Sweet Peas and Primula. *Am. Nat.*, 1914, xlvi.
- BRIDGES, C. B.: A Linkage Variation in *Drosophila*. *Jour. Exp. Zoöl.*, 1915, xix.
- BRIDGES, C. B.: Non-disjunction as a Proof of the Chromosome Theory of Heredity. *Genetics*, 1916, i.
- BRIDGES, C. B.: An Intrinsic Difficulty for the Variable Force Hypothesis of Crossing Over. *Am. Nat.*, 1917, li.
- BRIDGES, C. B.: Deficiency. *Genetics*, 1917, ii.
- BRIDGES, C. B.: Maroon—A Recurrent Mutation in *Drosophila*. *Proc. Natl. Acad. Sciences*, 1918, iv, 316-318.
- BRIDGES, C. B.: The Genetics of Purple Eye Color in *Drosophila*. *Jour. Exp. Zoöl.*, 1919, xxviii.
- BRIDGES, C. B.: Vermilion-deficiency. *Jour. Gen. Physiology*, 1919, i, July.
- BRIDGES, C. B.: Specific Modifiers of Eosin Eye Color of *Drosophila*. *Jour. Exp. Zoöl.*, 1919, xxviii.
- BRIDGES, C. B., and MORGAN, T. H.: The Second Chromosome Group of Mutant Characters. Carnegie Pub. No. 278, Part II, 1919.
- BRIDGES, C. B., and STURTEVANT, A. H.: A New Gene in the Second Chromosome of *Drosophila* and Some Considerations on Differential Viability. *Biol. Bull*, 1914, xxvi.
- CALKINS, G. N.: Studies on the Life History of Protozoa. III. *Biol. Bull.*, 1902, iii.
- CALKINS, G. N.: Studies on the Life History of Protozoa. IV. *Jour. Exp. Zoöl.*, 1904, i.
- CANNON, W. A.: Studies in Plant Hybrids: The Spermatogenesis of Hybrid Peas. *Bull. Torrey Bot. Club*, 1903, xxx.
- CAROTHERS, E. E.: The Mendelian Ratio in Relation to Certain Orthopteran Chromosomes. *Jour. Morph.*, 1913, xxiv.
- CAROTHERS, E. E.: The Segregation and Recombination of Homologous Chromosomes Found in Two Genera of *Acrididae* (Orthoptera). *Jour. Morph.*, 1917, xxviii.
- CASTLE, W. E.: Heredity in Relation to Evolution and Animal Breeding, 1911.

- CASTLE, W. E.: Some New Varieties of Rats and Guinea-pigs and Their Relation to Problems of Color Inheritance. *Am. Nat.*, 1914, **xlvi**.
- CASTLE, W. E.: Size Inheritance and the Pure Line Theory. *Zeits. Abst. Vererb.*, 1914, **xii**.
- CASTLE, W. E.: Yellow Varieties of Rats. *Am. Nat.*, 1914, **xlvi**.
- CASTLE, W. E.: Genetics and Eugenics, 1916.
- CASTLE, W. E.: Further Studies on Piebald Rats and Selection with Observations on Gametic Coupling. *Carnegie Inst., Wash., Pub.* 241 Part III, 1916.
- CASTLE, W. E.: Is the Arrangement of the Genes in the Chromosome Linear? *Proc. Nat. Acad. Sci.*, 1919, **v**.
- CASTLE, W. E.: The Linkage System of Eight Sex-linked Characters of *Drosophila Virilis* (Data of Metz). *Proc. Nat. Acad. Sci.*, 1919, **v**.
- CASTLE, W. E., and PHILLIPS, JOHN C.: Piebald Rats and Selection. *Carnegie Inst., Wash., Pub.* 195, 1914.
- CAULLERY, M.: Les Problèmes de la Sexualité, 1913.
- CLAUSEN, R. E., and GOODSPEED, T. H.: Hereditary Reaction-system Relations—an Extension of Mendelian Concepts. *Proc. Nat. Acad. Sci.*, 1916, **ii**.
- COLE, L. J.: A Case of Sex-linked Inheritance in the Domestic Pigeon. *Science*, 1912, **n.s.**, **xxxvi**.
- COLE, L. J.: Studies on Inheritance in Pigeons. *Rhode Island A. E. S. Bull.*, 158, 1914.
- COLE, L. J., and LIPPINCOTT, W. A.: The Relation of Plumage to Ovarian Condition in a Barred Plymouth Rock Pullet. *Biol. Bull.*, 1919, **xxxvi**.
- COLLINS, G. N.: Inheritance of Waxy Endosperm in Hybrids of Chinese Maize. *Proc. Fourth Intern. Conf. Genetic*, Paris, 1911.
- COLLINS, G. N.: Gametic Coupling as a Cause of Correlations. *Am. Nat.*, 1912, **xliv**.
- COLLINS, G. N., and KEMPTON, J. H.: Inheritance of Endosperm Texture in Sweet and Waxy Hybrids of Maize. *Am. Nat.*, 1914, **xlvi**.
- COLLINS, G. N.: Maize. *Am. Nat.*, 1914, **xlvi**.
- COLLINS, G. N., and KEMPTON, J. H.: Patrogenesis. *Jour. Hered.*, 1916, **xii**.
- CONKLIN, E. G.: Heredity and Environment. *Princeton Univ. Press*, 1915.
- CONKLIN, E. G.: The Share of the Egg and Sperm in Heredity. *Proc. Nat. Acad. Sci.*, 1917.
- CORRENS, C.: Bastarde zwischen Maisrassen. *Biblioth. Botanica*, 1901, **liii**.
- CORRENS, C.: Ueber den Modus und den Zeitpunkt der Spaltung, etc. *Bot. Zeit.*, 1902, **lx**.

- CORRENS, C.: Zur Kenntniss der Rolle von Kern und Plasma bei der Vererbung. *Zeit. Abst. Vererb.*, 1909, ii.
- CORRENS, C.: Vererbungsversuche mit blass (gelb) grünen und buntblättrigen Sippen bei *Mirabilis Jalapa*, *Urtica pilulifera* und *Lunaria annua*. *Zeit. Abst. u. Vererb.*, 1909, i.
- CORRENS, C.: Der Uebergang aus dem homozygotischen in einen heterozygotischen Zustand in selben Individuum bei buntblättrigen und gestreiftblühenden *Mirabilis*-Sippen. *Ber. Deutsch. Ges.*, 1910, xxviii.
- CORRENS, C., and GOLDSCHMIDT, R.: Die Vererbung und Bestimmung des Geschlechtes, 1913, Berlin.
- CUÉNOT, L.: L'hérédité de la pigmentation chez les souris (2), Hérédité de la pigmentation chez les souris noires. *Arch. Zoöl. Exp. et Gén.*, 1903, i.
- CUÉNOT, L.: L'hérédité de la pigmentation chez les souris (3), Les formules héréditaires. *Arch. Zoöl. Exp. et Gén.*, 1904, ii.
- CUÉNOT, L.: Les races pures et leurs combinaisons chez les souris (4). *Arch. Zoöl. Exp. et Gén.*, 1905, iii.
- CUÉNOT, L.: L'hérédité de la pigmentation chez les souris (5). *Arch. Zoöl. Exp. et Gén.*, 1907, vi.
- CUÉNOT, L.: Sur quelques anomalies apparentes des proportions mendéliennes (6). *Arch. Zoöl. et Gén.*, 1908, ix.
- CUÉNOT, L.: Les déterminants de la couleur chez les souris étude comparative (7). *Arch. Zoöl. Exp. et Gén.*, 1911, viii.
- CUÉNOT, L.: L'hérédité chez les souris. *Verh. naturf. Vereines in Brünn*, 1911, xlix.
- CUÉNOT, L.: Recherches sur l'hybridation. *Proc. VII Inter. Zoöl. Congress.* 1909.
- DARBISHIRE, A.: Note on the Result of Crossing Japanese Waltzing Mice with European Albino Races. *Biometrika*, 1902, ii.
- DARBISHIRE, A.: Breeding and the Mendelian Discovery, 1911, London.
- DARWIN, C.: The Origin of Species by Means of Natural Selection, or the Preservation of Favored Races in the Struggle for Life, 1859, London.
- DARWIN, C.: The Variation of Animals and Plants under Domestication, second ed., 1868, New York.
- DAVENPORT, C. B.: Inheritance in Poultry. *Carnegie Inst., Wash., Pub.* 53, 1906.
- DAVENPORT, C. B.: Inheritance of Characteristics in Domestic Fowl. *Carnegie Inst., Wash., Pub.* 121, 1909.
- DAVENPORT, C. B.: Heredity in Relation to Eugenics. New York, 1911.
- DAVENPORT, C. B.: Sex-limited Inheritance in Poultry. *Jour. Exp. Zoöl.*, 1912, xiii.

- DAVENPORT, G. C., and C. B.: Heredity of Hair Color in Man. *Am. Nat.*, 1909, xliii.
- DAVENPORT, C. B.: Sex-limited Inheritance in Poultry. *Jour. Exp. Zool.*, 1912, xiii.
- DAVIS, B. M.: Cytological Studies on *Œnothera*. *Annals of Botany*, 1909-11, xxiii, xxiv, xxv.
- DAVIS, B. M.: Genetical Studies on *Œnothera*. *Am. Nat.*, xlv, xlv, xlv, xlv, xlv.
- DAVIS, B. M.: The Problem of the Origin of *Œnothera lamarckiana* De Vries. *New Phytol.*, 1913, xii.
- DAVIS, B. M.: The Test of a Pure Species of *Œnothera*. *Proc. Am. Phil. Soc.*, 1915, liv.
- DAVIS, B. M.: Additional Evidence of Mutation in *Œnothera*. *Am. Nat.*, 1915, xlix.
- DAVIS, B. M.: A Method of Obtaining Complete Germination of Seeds in *Œnothera* and of Recording the Residue of Sterile Seed-like Structures. *Proc. Nat. Acad. Sci.*, 1915, i.
- DAVIS, B. M.: *Œnothera neo-Lamarckiana*, Hybrid of *O. franciscana* Bartlett  $\times$  *O. binnis*. *Am. Nat.*, 1916, l.
- DELCOURT, A., and GUYÉNOT, E.: Génétique et milieu. *Bull. Scient. France et Belg.* 1911, xlv.
- DETLEFSEN, J. A.: Genetic Studies on a Cavy Species Cross. *Carnegie Inst. Wash. Pub.* 205, 1914.
- DEXTER, J. S.: On Coupling of Certain Sex-linked Characters in *Drosophila*. *Biol. Bull.*, 1912, xxiii.
- DEXTER, J. S.: The Analysis of a Case of Continuous Variation in *Drosophila* by a Study of Its Linkage Relations. *Am. Nat.*, 1914, xlviii.
- DEXTER, J. S.: Nabours' Breeding Experiments with Grasshoppers. *Am. Nat.*, 1914, xlviii.
- DIGBY, L.: The Cytology of *Primula kewensis* and of Other Related *Primula* Hybrids. *Ann. of Bot.*, 1912 xxvi.
- DONCASTER, L.: Inheritance and Sex in *Abraxas grossulariata*. *Nature*, 1907, lxxvi.
- DONCASTER, L.: Gametogenesis and Fertilization in *Nematus ribesii*. *Q. J. M. S.*, 1907, li.
- DONCASTER, L.: On Sex Inheritance in the Moth, *Abraxas grossulariata* and Its Var. *Lacticolor*. *4th Rep. Evol. Comm., R. Soc. Lond.*, 1908.
- DONCASTER, L.: Some Stages in the Spermatogenesis of *Abraxas grossulariata* and Its Var. *Lacticolor*. *Jour. Genet.*, 1911, i.
- DONCASTER, L.: The Chromosomes in the Oögenesis and Spermatogenesis of *Pieris brassicæ*, and in the Oögenesis of *Abraxas grossulariata*. *Jour. Genet.*, 1912, ii.

- DONCASTER, L.: Note on the Chromosomes in Oögenesis and Spermatogenesis of the White Butterfly, *Pieris brassicae*. *Proc. Camb. Phil. Soc.*, 1912, xvi.
- DONCASTER, L.: On the Relations between Chromosomes, Sex-limited Transmission and Sex-Determination in *Abraxas grossulariata*. *Jour. Genet.*, 1914, iv.
- DONCASTER, L.: Chromosomes, Heredity, and Sex. *Quart. Jour. Micr. Sc.*, 1914.
- DONCASTER, L.: The Determination of Sex, 1914.
- DONCASTER, L., and RAYNOR, G. H.: Breeding Experiments with Lepidoptera. *Proc. Zool. Soc. Lond.*, 1906.
- DUNCAN, F. N.: An Attempt to Produce Mutations through Hybridization. *Amer. Nat.*, 1915, xlix.
- DUNCAN, F. N.: A Note on the Gonads of Gynandromorphs of *Drosophila ampelophila*. *Am. Nat.*, 1915, xlix.
- DUNN, L. C.: The Genetic Behavior of Mice of the Color Varieties "Black and Tan" and "Red." *Am. Nat.*, 1916, l.
- DURHAM, F. M.: On the Presence of Tyrosinases in the Skins of Some Pigmented Vertebrates. *Proc. Roy. Soc. Lond.*, 1904, lxxiv.
- DURHAM, F. M.: Note on Melanins. *Jour. Physiol.*, 1907, xxxv.
- DURHAM, F. M.: A Preliminary Account of the Inheritance of Coat Color in Mice. *Jour. Gen.*, 1908, i.
- DURHAM, F. M., and MARRYAT, D. E. C.: Note on the Inheritance of Sex in Canaries. *4th Rept. Evol. Comm., Roy. Soc. Lond.*, 1908.
- EAST, E. M.: The Relation of Certain Biological Principles to Plant Breeding. *Conn. A.E.S. Bull.*, 1907, clviii.
- EAST, E. M.: A Study of the Factors Influencing the Improvement of the Potato. *Ill. A.E.S. Bull.* 127, 1908.
- EAST, E. M.: The Transmission of Variations in the Potato in Asexual Reproduction. *Conn. A.E.S. Rept.*, 1909-10.
- EAST, E. M.: The Distinction between Heredity and Development in Inbreeding. *Am. Nat.*, 1909, xliii.
- EAST, E. M.: The Genotype Hypothesis and Hybridization. *Am. Nat.*, 1910, xlv.
- EAST, E. M.: A Mendelian Interpretation of Variation that is Apparently Continuous. *Ibid.*, 1910, xlv.
- EAST, E. M.: The Genotype Hypothesis and Hybridization. *Am. Nat.*, 1911, xlv.
- EAST, E. M.: A Study of Hybrids between *Nicotiana bigelovii* and *N. quadrivalvis*. *Bot. Gaz.*, 1912, liii.
- EAST, E. M.: The Mendelian Notation as a Description of Physiological Facts. *Am. Nat.*, 1912, xlvi.



- EAST, E. M.: Inheritance of Flower Size in Crosses between Species of *Nicotiana*. *Bot. Gaz.*, 1913, lv.
- EAST, E. M.: The Chromosome View of Heredity and Its Meaning to Plant Breeders. *Am. Nat.*, 1915, xlix.
- EAST, E. M.: Size Inheritance in *Nicotiana*. *Genetics*, 1915, i.
- EAST, E. M.: The Bearing of Some General Biological Facts on Bud Variation. *Am. Nat.*, 1917, li.
- EAST, E. M., and HAYES, H. K.: Inheritance in Maize. *Conn. Exp. Sta. Bull.*, 1911, clxvii.
- EAST, E. M., and HAYES, H. K.: Heterozygosis in Evolution and in Plant Breeding. *U. S. Dept. Agric., Bureau Plant Ind. Bull.*, 1912, cexliii.
- EAST, E. M., and HAYES, H. K.: A Genetic Analysis of the Changes Produced by Selection in Experiments with Tobacco. *Am. Nat.*, 1914, xlviii.
- EAST, E. M., and HAYES, H. K.: Further Experiments on Inheritance in Maize. *Connecticut Agr. Exp. Sta., Bull.* 188, 1915.
- EMERSON, R. A.: Inheritance of Color in the Seeds of the Common Bean, *Phaseolus vulgaris*. *Ann. Rep. Nebr. Agr. Exp. Sta.*, 1909, **xxii**.
- EMERSON, R. A.: The Inheritance of Sizes and Shapes in Plants. *Am. Nat.*, 1910, xlv.
- EMERSON, R. A.: Genetic Correlation and Spurious Allelomorphism in Maize. *Ann. Rep. Nebr. Agr. Exp. Sta.*, 1911, xxiv.
- EMERSON, R. A.: The Inheritance of Certain Forms of Chlorophyll Reduction in Corn Leaves. *Ann. Rep. Nebr. Agr. Exp. Sta.*, 1912, **xxv**.
- EMERSON, R. A.: The Inheritance of the Ligule and Auricles of Corn Leaves. *Ann. Rep. Nebr. Agr. Exp. Sta.*, 1912, xxv.
- EMERSON, R. A.: The Unexpected Occurrence of Aleurone Colors in  $F_2$  of a Cross between Non-colored Varieties of Maize. *Am. Nat.*, 1912, xlv.
- EMERSON, R. A.: The Inheritance of a Recurring Somatic Variation in Variegated Ears of Maize. *Am. Nat.*, xlviii and *Neb. A.E.S. Research Bull.*, 1914, iv.
- EMERSON, R. A.: A Genetic Study of Plant Height in *Phaseolus vulgaris*. *Neb. A.E.S. Research Bull.*, 1916, vii.
- EMERSON, R. A.: The Calculation of Linkage Intensities. *Am. Nat.*, 1916, l.
- EMERSON, R. A.: Genetical Analysis of Variegated Pericarp in Maize. *Genetics*, 1917, ii.
- EMERSON, R. A., and EAST, E. M.: The Inheritance of Quantitative Characters in Maize. *Univ. Neb. Agric. Exp. Station Bull.*, 1913, ii.

- EWING, H. E.: Eighty-seven Generations in a Parthogenetic Pure Line of *Aphis avenae* Fab. *Biol. Bull.*, 1916, xxxi.
- FEDERLEY, H.: Vererbungsstudien an der Lepidopteren-Gattung *Pygæra*. *Arch. Rass. Gesell.*, 1911.
- FEDERLEY, H.: Das Verhalten der Chromosomen bei der Spermatogenese der Schmetterlinge *Pygæra anachoreta*, *curtula* und *pigra* sowie einiger ihrer Bastarde. Ein Beitrag zur Frage der konstanten intermediären Artbastarde und der Spermatogenese der Lepidopteren. *Zeitschr. f. inductive Abstammungs- und Vererbungslehre*, 1912, ix.
- FEDERLEY, H.: Ein Beitrag zur Kenntnis der Spermatogenese bei Mischlingen zwischen Eltern verschiedener systematischer Verwandtschaft. *Ofversigt af Finska Vetenskaps-Societetens Förhandlingar*. 1914, lvi.
- FOOT, K., and STROBELL, E. C.: Preliminary Note on the Results of Crossing Two Hemipterous Species, etc. *Biol. Bull.*, 1913, xxiv.
- FOOT, KATHERINE, and STROBELL, E. C.: Results of Crossing *Euschistus variolarius* and *Euschistus servus* with Reference to the Inheritance of an Exclusively Male Character. *Linn. Soc. Jour.*, 1914, xxxii.
- GALTON, F.: Inquiries into Human Faculty, 1883, New York.
- GALTON, F.: Natural Inheritance, 1889, London.
- GALTON, F.: Hereditary Genius, 1892, London.
- GALTON, F.: The Average Contribution of Each of Several Ancestors to the Total Heritage of the Offspring. *Proc. Roy. Soc. Lond.*, 1897, lxi.
- GATES, R. R.: The Material Basis of Mendelian Phenomena. *Am. Nat.*, 1910, xlv.
- GATES, R. R.: Pollen Formation in *Oenothera gigas*. *Ann. Bot.*, 1911, xxv.
- GATES, R. R.: Tetraploid Mutants and Chromosome Mechanisms. *Biol. Centr.*, 1913, xxxiii.
- GATES, R. R.: On the Modification of Characters by Crossing. *Am. Nat.*, 1915, xlix.
- GATES, R. R.: The Mutation Factor in Evolution, with Particular Reference to *Oenothera*, 1915, London.
- GATES, R. R.: On Pairs of Species. *Bot. Gaz.*, 1916, lxi.
- GATES, R. R.: Vegetative Segregation in a Hybrid Race. *Jour. Gen.*, 1917, vi.
- GATES, R. R., and THOMAS, N.: A Cytological Study of *Oenothera mut. lata* and *O. mut. semilata* in Relation to Mutation. *Quart. Jour. Micr. Sc.*, 1914.
- GEERTS, J. M.: Beiträge zur Kenntnis der Cytologie und der partiellen Sterilität von *Oenothera Lamarckiana*. *Recueil des Trav. Bot. Neerl.*, 1909, v.
- GEROULD, J. H.: The Inheritance of Polymorphism and Sex in *Colias philodice*. *Am. Nat.*, 1911, xlv.

- GODLEWSKI, E.: Untersuchungen über die Bastardierung der Echiniden- und Chrinoidenfamilie. *Arch. Ent.-mec.*, 1906, xx.
- GOLDSCHMIDT, R.: Einführung in die Vererbungswissenschaft. Leipzig, 1911.
- GOLDSCHMIDT, R.: Erbliehkeitsstudien an Schmetterlingen. I, *Zeits. Abst. Vererb.*, 1912, vii.
- GOLDSCHMIDT, R.: Bemerkungen zur Vererbung des Geschlechtspolymorphismus. *Zeits. Abst. Vererb.*, 1912, viii.
- GOLDSCHMIDT, R.: A Preliminary Report on Further Experiments in Inheritance and Determination of Sex. *Proc. Nat. Ac. Sci.*, 1916, ii.
- GOLDSCHMIDT, R.: The Function of the Apyrene Spermatozoa. *Science*, n.s., 1916, xlv.
- GOLDSCHMIDT, R.: Experimental Intersexuality and the Sex Problem. *Am. Nat.*, 1916, l.
- GOLDSCHMIDT, R.: Genetic Factors and Enzyme Reaction. *Science*, 1916, xliii.
- GOLDSCHMIDT, R.: Crossing Over Ohne Chiasmotypie? *Genetics*, 1917, ii.
- GOLDSCHMIDT, R.: On a Case of Facultative Parthenogenesis in the Gypsy-moth *Lymantria dispar.*, with a Discussion of the Relation of Parthenogenesis to Sex. *Biol. Bull.*, 1917, xxxii.
- GOLDSCHMIDT, R.: A Further Contribution to the Theory of Sex. *Jour. Exp. Zoöl.*, 1917, xxii.
- GOODALE, H. D.: Studies on Hybrid Ducks. *Jour. Exp. Zoöl.*, 1911, x.
- GOODALE, H. D.: Some Results of Castration in Ducks. *Biol. Bull.*, 1911, xx.
- GOODALE, H. D.: Sex-limited Inheritance and Sexual Dimorphism in Poultry. *Science*, 1911, xxxiii.
- GOODALE, H. D.: Castration in Relation to the Secondary Sexual Characters of Brown Leghorns. *Am. Nat.*, 1913, xlvii.
- GOODALE, H. D.: A Feminized Cockerel. *Jour. Exp. Zoöl.*, 1916, xx.
- GOODALE, H. D.: Gonadectomy in Relation to the Secondary Sexual Characters of Some Domestic Birds. *Carnegie Inst., Wash., Pub. No. 243.* 1916.
- GOODALE, H. D., and MORGAN, T. H.: Heredity of Tri-color in Guinea-pigs. *Am. Nat.*, 1913, xlvii.
- GOODSPEED, T. H.: Quantitative Studies of Inheritance in Nicotiana Hybrids I-IV. *Univ. Calif. Pub. Bot.*, 1912-15, v.
- GOODSPEED, T. H.: On the Partial Sterility of Nicotiana Hybrids Made with *N. sylvestris* as a Parent. *Univ. Calif. Pub. Bot.*, 1913, v.
- GOODSPEED, T. H.: Parthenogenesis, Parthenocarpy and Phenospermy in Nicotiana. *Univ. Calif. Pub. Bot.*, 1915, v.
- GOODSPEED, T. H., and CLAUSEN, R. E.: Variation in Flower Size in Nicotiana. *Proc. Nat. Acad. Sci.*, 1915, i.

- GOODSPEED, T. H., and CLAUSEN, R. E.: Factors Influencing Flower Size in *Nicotiana* with Special Reference to Questions of Inheritance. *Amer. Jour. Bot.*, 1915, ii.
- GOODSPEED, T. H., and CLAUSEN, R. E.: The Nature of the  $F_1$  Species Hybrids between *Nicotiana sylvestris* and Varieties of *Nicotiana Tabacum* with Special Reference to the Conception of Reaction-system Contrasts in Heredity. *Univ. Cal. Pub. Bot.*, 1917, v.
- GOODSPEED, T. H., and CLAUSEN, R. E.: Mendelian Factor Differences Versus Reaction-system Contrasts in Heredity. *Am. Nat.*, 1917, 1.
- GÖRTNER, R. A.: Spiegler's "White Melanin" as Related to Dominant or Recessive White. *Am. Nat.*, 1910, xlv.
- GÖRTNER, R. A.: Studies on Melanin I-III. *Jour. Biol. Chem.*, viii; IV. *Am. Nat.*, 1910-11, xlv.
- GOULD, H. N.: Studies on Sex in the Hermaphrodite Mollusc *Crepidula plana*. I. History of the Sexual Cycle, 1917, xxiii.
- GREGORY, R. P.: Note on the Histology of the Giant and Ordinary Forms of *Primula sinensis*. *Proc. Cambridge Phil. Soc.*, 1909, xv.
- GREGORY, R. P.: Experiments with *Primula sinensis*. *Jour. Gen.*, 1911, i.
- GREGORY, R. P.: On Gametic Coupling and Repulsion in *Primula sinensis*. *Proc. Roy. Soc.*, 1911, B, lxxxiv.
- GREGORY, R. P.: The Chromosomes of a Giant Form of *Primula sinensis*. *Proc. Cambridge Phil. Soc.*, 1912, xvi.
- GREGORY, R. P.: On the Genetics of Tetraploid Plants in *Primula sinensis*. *Proc. Roy. Soc.*, 1914, B, lxxxvii.
- GREGORY, R. P.: On Variegation in *Primula sinensis*. *Jour. Gen.*, 1915, iv.
- GREGORY, R. P.: Note on the Inheritance of Heterostylism in *Primula acaulis* Jacq.. *Jour. Gen.*, 1915, iv.
- GULICK, A.: Ueber die Geschlechtschromosomen bei einigen Nematoden. *Arch. f. Zellf.*, 1911, vi.
- GUYER, M. F.: Hybridism and the Germ-cell. *Univ. of Cincinnati Bull.*, 1902, No. 21.
- GUYER, M. F.: The Germ-cell and the Results of Mendel. *Cincinnati Lancet-Clinic*, 1903.
- GUYER, M. F.: The Spermatogenesis of the Domestic Chicken. *Anat. Anz.*, 1909, xxxiv.
- GUYER, M. F.: Atavism in Guinea-chicken Hybrids. *Jour. Exp. Zoöl.*, 1909, vii.
- GUYER, M. F.: Accessory Chromosomes in Man. *Biol. Bul.*, 1910, xix.
- GUYER, M. F.: Nucleus and Cytoplasm in Heredity. *Am. Nat.*, 1911, xlv.
- GUYER, M. F.: Accessory Chromosomes in Man. *Science*, n.s., 1914, xxxix.
- GUYER, M. F.: Studies on the Chromosomes of the Common Fowl as seen in Testes and in Embryos. *Biol. Bul.*, 1916, xxxi.

- GUYER, M. F.: Being Well Born. 1916. Indianapolis.
- HADLEY, P. B.: Studies on Inheritance in Poultry: I. The Constitution of the White Leghorn Breed. *R.I.A.E.S. Bull.* 155. II The Factor for Black Pigmentation in the White Leghorn Breed. *Ibid.*, *Bull.* 161, 1913-14.
- HAGEDOORN, A. L.: The Genetic Factors in the Development of the House Mouse, etc. *Zeits. Abst. Vererb.*, 1912, vi.
- HANCE, R. T.: Variations in the Number of Somatic Chromosomes in *Enothera scintillans* De Vries. *Genetics*, 1918, iii.
- HARRISON, J. W. H., and DONCASTER, L.: On Hybrids between Moths of the Geometrid Sub-family Bistoninae, with an Account of the Behavior of the Chromosomes in Gametogenesis in *Lycia* (*Biston*) *hirtaria*, *Ithysia* (*Nyssia*) *zonaria* and in Their Hybrids. *Jour. Genet.*, 1914, iii.
- HAYES, H. K., and EAST, E. M.: Further Experiments on Inheritance in Maize. *Conn. A. E. S. Bull.*, 1915, clxxxviii.
- HEGNER, R. W.: Variation and Heredity during the Vegetative Reproduction of *Arcella dentata*. *Proc. Nat. Acad. Sci.*, 1918, iv.
- HEGNER, R. W.: Quantitative Relations between Chromatin and Cytoplasm in the Genus *Arcella*. *Proceed. Nat. Acad. Sci.*, 1919, v.
- HENKING, H.: Untersuchungen über die ersten Entwicklungsvorgänge in den Eiern der Insekten. *Zeits. f. wiss. Zool.*, 1891, li.
- HERIBERT-NILSSON, N.: Die Variabilität der *Enothera Lamarckiana* und das Problem der Mutation. *Zeit. ind. Abst. u. Vererb.*, 1912, viii.
- HERLANT, M.: Étude sur les bases cytologiques du mécanisme de la parthénogenèse expérimentale chez les Amphibiens. *Archives de Biologie*, 1913, xxviii.
- HERLANT, M.: Le Mécanisme de la Parthénogenèse Expérimentale chez les Amphibiens et les Echinodermes. *Bull. Scientifique de la France et de la Belgique*, 1917, li.
- HERLANT, M.: Un Cas d'Hermaphrodisme Complet et Fonctionnel chez *Paracentrotus Lividis*. *Arch. Zool. Exp. et Gén.*, 1918, lvii.
- HERLA, V.: Études des Variations de la Mitose chez l'Ascaride Mégalo-céphale. *Arch. Biol.*, 1895, xiii.
- HOGE, M. A.: The Influence of Temperature on the Development of a Mendelian Character. *Jour. Exp. Zool.*, 1915, xviii.
- HOGE, M. A.: Another Gene in the Fourth Chromosome of *Drosophila*. *Am. Nat.*, 1915, xlix.
- HYDE, R. R.: Fertility and Sterility in *Drosophila ampelophila*. I-IV *Jour. Exp. Zool.*, 1914, xvii.
- HYDE, R. R.: Two New Members of a Sex-linked Multiple (Sextuple), Allelomorph System. *Genetics*, 1916, i.
- HYDE, R. R.: Mosaics in *Drosophila ampelophila*. *Genetics*, 1916, i.

- IBSEN, H. L.: Tricolor Inheritance, I. The Tricolor Series in Guinea-pigs. *Genetics*, 1916, i.
- IBSEN, H. L.: Tricolor Inheritance, II. The Basset Hound. *Genetics*, 1916, i.
- IBSEN, H. L.: Tricolor Inheritance, III. Tortoise-shell cats. *Genetics*, 1916, i.
- ISHIKAWA, MITSU HARU: A List of the Number of Chromosomes. *Bot. Mag.*, 1916, Tokyo, xxx.
- JANSSENS, F. A.: Evolution des auxocytes Mâles du *Batrachoseps Attenuatus*. *La Cellule*, 1905, xxii.
- JANSSENS, F. A.: La Théorie de la chiasmotypie. Nouvelle interprétation des cinèses de maturation. *La Cellule*, 1909, xxv.
- JENNINGS, H. S.: Assortative Mating, Variability and Inheritance of Size in the Conjugation of Paramecium. *Jour. Exp. Zoöl.*, 1911, xi.
- JENNINGS, H. S.: Pure Lines in the Study of Genetics in Lower Organisms. *Am. Nat.*, 1911, xlv.
- JENNINGS, H. S.: The Effect of Conjugation in Paramecium. *Jour. Exp. Zoöl.*, 1913, xiv.
- JENNINGS, H. S., and HARGITT, G. T.: Characteristics of the Diverse Races of Paramecium. *Jour. Morph.*, 1910, xxi.
- JENNINGS, H. S., and LASHLEY, K. S.: Biparental Inheritance and the Question of Sexuality in Paramecium. *Jour. Exp. Zoöl.*, 1913, xiv.
- JESENKO, F.: Sur une hybride fertile entre *Triticum sativum* et *Secale céréale*. *Rap. IV Conf. Internat. de Génétique*, 1913.
- JESENKO, F.: Ueber Getreide-Speziesbastarde. *Zeits. Abts.*, 1913, x.
- JOHANNSEN, W.: Ueber Erblichkeit in Populationen und in reinen Linien, 1903, Jena.
- JOHANNSEN, W.: Ueber Knospenmutation bei *Phaseolus*. *Zeit. Abst. Vererb.*, 1908, i.
- JOHANNSEN, W.: Elemente der exakten Erblichkeitslehre, 1909, Jena.
- JOHANNSEN, W.: The Genotype Conception of Heredity. *Am. Nat.*, 1911, xlv.
- JONES, D.: Dominance of Linked Factors as a Means of Accounting for Heterosis. *Genetics*, 1917, ii.
- KEEBLE, F.: Gigantism in *Primula sinensis*. *Jour. Gen.*, 1912, ii.
- KEEBLE, F., and PELLEW, C.: The Mode of Inheritance of Stature and Time of Flowering in Peas (*Pisum sativum*). *Jour. Gen.*, 1910, i.
- KELLOGG, VERNON L.: Inheritance in Silkworms, I. *Stanford Un. Pub.*, 1908, i.
- KING, H. D.: The Sex Ratio in Hybrid Rats. *Biol. Bull.*, 1911, xxi.
- KUSCHAKEWITSCH, SERGIUS: Die Entwicklungsgeschichte der Keimdrüsen von *Rana esculenta*. Ein Beitrag zum Sexualitätsproblem. *Festschrift zum sechzigsten Geburtstag Richard Hertwigs*, II, 1910.

- LANG, A.: Vererbungswissenschaftliche Miscellen. *Zeits. Abst. Vererb.*, 1912, viii.
- LASHLEY, K. S.: Inheritance in the Asexual Reproduction of Hydra. *Jour. Exp. Zool.*, 1915, xix.
- LASHLEY, K. S.: Results of Continued Selection in Hydra. *Jour. Exp. Zool.*, 1916, xx.
- LIEFF, JOSEPH: Data on a Peculiar Mendelian Ratio in *Drosophila ampelophila*. *Am. Nat.*, 1915, xlix.
- LILLIE, F. R.: The Theory of the Free-martin. *Science*, 1916, n.s., xliii.
- LILLIE, F. R.: Sex-determination and Sex-Differentiation in Mammals. *Proc. Nat. Acad. Sci.*, 1917, iii.
- LILLIE, F. R.: The Free-martin. A Study of the Action of Sex-hormones in the Fœtal Life of Cattle. *Jour. Exp. Zool.*, 1917, xxiii.
- LIPPINCOTT, W. A.: The Case of the Blue Andalusian. *Am. Nat.*, 1918, lii.
- LIPSCHUTZ, A.: On the Internal Secretion of the Sexual Glands. *Jour. Physiol.*, 1917, li.
- LITTLE, C. C.: Preliminary Note on the Occurrence of a Sex-limited Character in Cats. *Science*, 1912, xxxv.
- LITTLE, C. C.: Experimental Studies of the Inheritance of Color in Mice. *Carnegie Inst., Wash., Pub.* 179, 1913.
- LITTLE, C. C.: Dominant and Recessive Spotting in Mice. *Am. Nat.*, 1914, xlviii.
- LITTLE, C. C.: The Inheritance of Black-eyed White Spotting in Mice. *Am. Nat.*, 1916, xlix.
- LITTLE, C. C.: The Relation of Yellow-Coat Color and Black-eyed White Spotting of Mice in Inheritance. *Genetics*, 1917, ii.
- LITTLE, C. C., and PHILLIPS, J. C.: A Cross Involving Four Pairs of Mendelian Characters in Mice. *Am. Nat.*, 1913, xlvii.
- LLOYD-JONES, O.: Studies on Inheritance in Pigeons. *Jour. Exp. Zool.*, 1915, xviii.
- LOCK, R. H.: Recent Progress in the Study of Variation, Heredity and Evolution. 1906. London and New York.
- LOCK, R. H.: On the Inheritance of Certain Invisible Characters in Peas. *Proc. Roy. Soc.*, 1907, B, lxxix.
- LOCK, R. H.: The Present State of Knowledge of Heredity in *Pisum*. *Annals. Roy. Bot. Gar.*, 1908, iv.
- LOEB, J.: Ueber den autokatalytischen Charakter der Kernsynthese bei der Entwicklung. *Biol. Cent.*, 1910, xxx.
- LOEB, J.: Heredity in Heterogeneous Hybrids. *Jour. Morph.*, 1912, xxiii.
- LOEB, J.: Artificial Parthenogenesis and Fertilization, 1913, Chicago.
- LOEB, J.: The Organism as a Whole. 1916. New York.

- LOEB, J.: Is Species Specificity a Mendelian Character? *Science*, 1917, xlv.
- LOEB, J.: Further Experiments on the Sex of Parthenogenetic Frogs. *Proc. Nat. Ac. Sci.*, 1918, iv.
- LOEB, J., and BANCROFT, F. W.: Further Observations on Artificial Parthenogenesis in Frogs. *Jour. Exp. Zool.*, 1913, xv.
- LOEB, J., and CHAMBERLAIN, M. M.: An Attempt at a Physico-chemical Explanation of Certain Groups of Fluctuating Variation. *Jour. Exp. Zool.*, 1915, xix.
- LOEB, J. W., KING, W. O. R., and MOORE, A. R.: Ueber Dominanzerscheinungen bei den hybriden Plutein des Seeigels. *Arch. Entw. Org.*, 1910, xxix.
- LOTSY, J. P.: Hybrides entre espèces d'Antirrhinum. *Repts. 4th Intern. Conf. Genet.*, 1911, Paris.
- LOTSY, J. P.: Evolution by Means of Hybridization. 1916. The Hague.
- LOVE, H. H., and LEIGHTY, C. E.: Variation and Correlation of Oats (*Avena sativa*). *Cornell A.E.S.*, 1914.
- LOVE, H. H., and LEIGHTY, C. E.: Changes on Biometrical Constants. *Cornell A.E.S., Memoir 3*, 1914.
- LUTZ, A. M.: Triploid Mutants in *Oenothera*. *Biol. Centr.*, 1912, xxxii.
- LUTZ, A. M.: *Oenothera* Mutants with Diminutive Chromosomes. *Am. Jour. Bot.*, 1916, iii.
- LUTZ, A. M.: Fifteen- and Sixteen-Chromosome *Oenothera* Mutants. *Am. Jour. Bot.*, 1917, iv.
- LUTZ, F. E.: Experiments with *Drosophila ampelophila* Concerning Evolution. *Carnegie Inst., Wash., Pub. 143*, 1911.
- LUTZ, F. E.: Experiments Concerning the Sexual Difference in the Wing Length of *Drosophila ampelophila*. *Jour. Exp. Zool.*, 1913, xiv.
- McCLUNG, C. E.: The Accessory Chromosome—Sex-Determinant? *Biol. Bull.*, 1902, iii.
- McCLUNG, C. E.: Notes on the Accessory Chromosome. *Anat. Anz.*, 1902, xx.
- McCLUNG, C. E.: The Chromosome Complex of Orthopteran Spermatoocytes. *Biol. Bull.*, 1905, ix.
- McCLUNG, C. E.: A Comparative Study of the Chromosomes in Orthopteran Spermatogenesis. *Jour. Morph.*, 1914, xxv.
- McCLUNG, C. E.: The Multiple Chromosomes of *Hesperotettix* and *Mermiria*. *Jour. Morph.*, 1917, xxix.
- MACCURDY, H. M.: Nuclear Reorganization and Its Relation to Conjugation and Inheritance in *Arcella vulgaris*. *Anat. Record*, 1919, xv.
- MACDOUGAL, D. T.: Alterations in Heredity Induced by Ovarian Treatments. *Bot. Gaz.*, 1911, li.
- MACDOUGAL, D. T.; VAIL, A. M.; SHULL, G. H.; and SMALL, J. K.: Mutants and Hybrids of the *Oenotheras*. *Carnegie Inst., Wash., Pub. 24*, 1905.



- MACDOUGAL, D. T.; VAIL, A. M.; and SHULL, G. H.: Mutations, Variations and Relationships of the *Oenotheras*. *Ibid.*, *Pub.* 81, 1907.
- MACDOWELL, E. C.: Size Inheritance in Rabbits. *Carnegie Inst., Wash., Pub.* 196, 1914.
- MACDOWELL, E. C.: Multiple Factors in Mendelian Inheritance. *Jour. Exp. Zool.*, 1914, xvi.
- MACDOWELL, E. C.: Bristle Inheritance in *Drosophila*. *Ibid.*, 1915, xix.
- MARCHAL, ÉL. and ÉM.: Recherches Expérimentales sur la Sexualité des Spores chez les Mousses dioïques. *Mém. couronnés, par la Classe des sciences, dans la séance du 15 décembre 1905*, 1906.
- MARCHAL, ÉL. and ÉM.: Aposporie et Sexualité chez les Mousses. *Bull. de l'Acad. roy. de Belgique. (Classe de science)*, no. 7, 1907.
- MARCHAL, ÉL. and ÉM.: Asporie et Sexualité chez les Mousses. *Bull. de l'Acad. roy. de Belgique. (Classe de science)*, no. 1, 1919.
- MARCHAL, ÉL. and ÉM.: Asporie et Sexualité chez les Mousses. III. *Bull. de l'Acad. roy. de Belgique. (Classe de science)*, nos. 9-10.
- MARÉCHAL, J.: Sur l'Ovogénèse des Sélaciens et de quelques autres Chordates., I. Morphologie de l'Element chromosomique dans l'Ovocyte I chez les Sélaciens, les Téléostéens, les Tuniciers et l'Amphioxus. *La Cellule*, 1906, xxiv.
- MAY, H. G.: The Appearance of Reverse Mutations in the Bar-eyed Race of *Drosophila* under Experimental Control. *Proc. Nat. Acad. Sci.*, 1917, iii.
- MAY, H. G.: Selection for Higher and Lower Facet Numbers in the Bar-eyed Race of *Drosophila* and the Appearance of Reverse Mutations. *Biol. Bull.*, 1917, xxxiii.
- DE MELJERE, J. C. H.: Ueber Jacobsons Züchtungsversuche bezüglich des Polymorphismus von Papilio Memnon. *Zeit. Abst. Vererb.*, 1910, iii.
- DE MELJERE, J. C. H.: Ueber getrennte Vererbung der Geschlechter. *Biol. Centr.*, 1910, xxx.
- DE MELJERE, J. C. H.: Ueber getrennte Vererbung der Geschlechter. *Arch. Rass. Gesell.*, 1911, viii.
- MEISENHEIMER, J.: Experimentelle Studien zur Soma- und Geschlechtsdifferenzierung, I. Jena, 1909.
- MEISENHEIMER, J.: Experimentelle Studien zur Soma- und Geschlechtsdifferenzierung. *Fests zum 60 Geburtstag von Dr. J. W. Spengel*, 1912, iii.
- MENDEL, G.: Versuche über Pflanzen-hybriden. *Verh. d. Naturf. Vereins in Brünn*, 1865, iv.
- METZ, C. W.: An Apterous *Drosophila* and Its Genetic Behavior. *Am. Nat.*, 1914, xlvi.
- METZ, C. W.: Chromosome Studies in the Diptera, I. *Jour. Exp. Zool.*, 1914, xvii.

- METZ, C. W.: Mutations in Three Species of *Drosophila*. *Genetics*, 1916, i.
- METZ, C. W.: Chromosome Studies on the Diptera. II. The Paired Association of Chromosomes in the Diptera, and Its Significance. *Jour. Exp. Zool.*, 1916, xxi.
- METZ, C. W.: Chromosome Studies on the Diptera. III. Additional Types of Chromosome Groups in the *Drosophilidæ*. *Am. Nat.*, 1916, l.
- MEVES, F.: Die Spermatocytenteilungen bei der Honigbiene. *Arch. mikr. Anat.*, 1907, lxx.
- MEVES, F.: Die Spermatocytenteilungen bei der Hornisse (*Vespa crabro* L.) *Arch. mikr. Anat.*, 1908, lxxi.
- MORGAN, T. H.: An Alternative Interpretation of the Origin of Gynandromorphous Insects. *Science*, 1905, n.s., xxi.
- MORGAN, T. H.: *Experimental Zoölogy*, 1907, New York.
- MORGAN, T. H.: The Determination of Sex in Frogs. *Am. Nat.*, 1908, xlii.
- MORGAN, T. H.: A Biological and Cytological Study of Sex-Determination in Phylloxerans and Aphids. *Jour. Exp. Zool.*, 1909, vii.
- MORGAN, T. H.: Hybridology and Gynandromorphism. *Am. Nat.*, 1909, xliii.
- MORGAN, T. H.: Sex-limited Inheritance in *Drosophila*. *Science*, 1910, xxxii.
- MORGAN, T. H.: The Chromosomes in the Parthenogenetic and Sexual Eggs of Phylloxerans and Aphids. *Proc. Soc. Exp. Biol. and Med.*, 1910, vii.
- MORGAN, T. H.: Chromosomes and Heredity. *Am. Nat.*, 1910, xlv.
- MORGAN, T. H.: The Method of Inheritance of Two Sex-limited Characters in the Same Animal. *Proc. Soc. Exp. Biol. Med.*, 1910, viii.
- MORGAN, T. H.: An Attempt to Analyze the Constitution of the Chromosomes on the Basis of Sex-limited Inheritance in *Drosophila*. *Jour. Exp. Zool.*, 1911, xi.
- MORGAN, T. H.: Mosaics and Gynandromorphs in *Drosophila*. *Proc. Soc. Exp. Biol. Med.*, 1914, xi.
- MORGAN, T. H.: Two Sex-linked Lethal Factors in *Drosophila* and Their Influence on the Sex Ratio. *Jour. Exp. Zool.*, 1914, xvii.
- MORGAN, T. H.: A Third Sex-linked Lethal Factor in *Drosophila*. *Jour. Exp. Zool.*, 1914, xvii.
- MORGAN, T. H.: The Constitution of the Hereditary Material. *Proc. Am. Philos. Soc.*, 1915, liv.
- MORGAN, T. H.: Localization of Hereditary Material in the Germ-cells. *Proc. Nat. Acad. Sci.*, 1915, i.
- MORGAN, T. H.: The Rôle of the Environment in the Realization of a Sex-linked Mendelian Character in *Drosophila*. *Am. Nat.*, 1915, xlix.

- MORGAN, T. H.: A Critique of the Theory of Evolution. *Princeton Univ. Press*, 1916.
- MORGAN, T. H.: The Theory of the Gene. *Am. Nat.*, 1917, li.
- MORGAN, T. H.: Concerning the Mutation Theory. *Sci. Mon.*, May, 1918.
- MORGAN, T. H.: Changes in Factors Through Selection. *Sci. Monthly*, June, 1918.
- MORGAN, T. H.: Evolution by Mutation. *Sci. Mon.*, July, 1918.
- MORGAN, T. H.: A Demonstration of Genes Modifying the Character "A Notch." *Carnegie Pub. No. 278, Part IV*, 1919.
- MORGAN, T. H., and BRIDGES, C. B.: Dilution Effects and Bicolorism in Certain Eye Colors of *Drosophila*. *Jour. Exp. Zool.*, 1913, xv.
- MORGAN, T. H., and BRIDGES, C. B.: Sex-linked Inheritance in *Drosophila*. *Carnegie Inst., Wash., Pub. 237*, 1916.
- MORGAN, T. H., and BRIDGES, C. B.: The Origin of Gynandromorphs. *Carnegie Pub. No. 278, Part I*, 1919.
- MORGAN, T. H., and CATTELL, E.: Data for the Study of Sex-linked Inheritance in *Drosophila*. *Jour. Exp. Zool.*, 1912, xiii.
- MORGAN, T. H., and CATTELL, E.: Additional Data for the Study of Sex-linked Inheritance in *Drosophila*. *Jour. Exp. Zool.*, 1913, xiv.
- MORGAN, T. H., and GOODALE, H. D.: Sex-linked Inheritance in Poultry. *Ann. N. Y. Acad. Sci.*, 1912, xxii.
- MORGAN, T. H., and LYNCH, C. J.: The Linkage of Two Factors in *Drosophila* That are Not Sex-linked. *Biol. Bull.*, 1912, xxiii.
- MORGAN, T. H., PAYNE, F., and BROWNE, E. N.: A Method to Test the Hypothesis of Selective Fertilization. *Biol. Bull.*, 1910, xviii.
- MORGAN, T. H.; STURTEVANT, A. H.; MULLER, H. J., and BRIDGES, C. B.: The Mechanism of Mendelian Heredity, 1915, New York.
- MORRIS, MARGARET: The Behavior of the Chromatin in Hybrids between *Fundulus* and *Ctenolabrus*. *Jour. Exp. Zool.*, 1914, xvi.
- MULLER, H. J.: A New Mode of Segregation in Gregory's Tetraploid *Primulas*. *Am. Nat.*, 1914, xlviii.
- MULLER, H. J.: The Bearing of the Selection Experiments of Castle and Phillips on the Variability of Genes. *Ibid.*, 1914.
- MULLER, H. J.: A Gene for the Fourth Chromosome of *Drosophila*. *Jour. Exp. Zool.*, 1914, xvii.
- MULLER, H. J.: The Mechanism of Crossing Over. *Am. Nat.*, 1916, l.
- MULLER, H. J.: An *Enothera*-like case in *Drosophila*. *Proc. Nat. Acad. Sci.*, 1917, iii.
- MULLER, H. J.: Genetic Variability, Twin Hybrids and Hybrids, in a Case of Balanced Lethal Factors. *Genetics*, 1918, iii.
- MULSOW, K.: Der Chromosomenzyklus bei *Ancyracanthus cystidicola* Rud. *Arch. f. Zellf.*, 1912, ix.
- NABOURS, R. K.: Studies of Inheritance and Evolution in Orthoptera I. *Jour. Genet.*, 1914, iii. II. *Ibid.*, 1917. III. *Ibid.*, 1917.

- NABOURS, R. K.: Parthenogenesis and Crossing Over in the Grouse Locust *Apotettix*. *Am. Nat.*, 1919, liii.
- NACHTSHEIM, H.: Parthenogenese, Eireifung und Geschlechtsbestimmung bei der Honigbiene. *Sitzgunsber. Gesell. Morph. u. Phys. München*, 1912.
- NAKAO, M.: Cytological Studies on the Nuclear Division of the Pollen Mother-cells of Some Cereals and Their Hybrids. *Jour. Coll. Agr., Tohoku Imp. Uni.*, Sapporo, Japan, 1911, v.
- NEWMAN, H. H.: Spawning Behavior and Sexual Dimorphism in *Fundulus heteroclitus* and Allied Fish. *Biol. Bull.*, 1907, xii.
- NEWMAN, H. H.: Further Studies of the Process of Heredity in *Fundulus* Hybrids. *Jour. Exp. Zool.*, 1910, viii.
- NILSSON-EHLE, H.: Om lifstyper och individuell Variation. *Bot. Notiser, Lund*, 1907.
- NILSSON-EHLE, H.: Einige Ergebnisse von Kreuzungen bei Hafer und Weizen. *Bot. Notiser*, 1908.
- NILSSON-EHLE, H.: Kreuzungsuntersuchungen an Hafer und Weizen. *Lund's Univ. Arsskrift*, 1909.
- PHILLIPS, J. C.: A Further Study of the Size Inheritance in Ducks with Observations on the Sex Ratio of Hybrid Birds. *Jour. Exp. Zool.*, 1914, xvi.
- PINNEY, E.: A Study of the Relation of the Behavior of the Chromatin to Development and Heredity in Teleost Hybrids. *Jour. Morph.*, 1918, xxxi.
- PLATE, L.: *Vererbungslehre*. 1913. Leipzig.
- PLOUGH, H. H.: The Effect of Temperature on Crossing Over. *Jour. Exp. Zool.*, 1917, xxiv.
- PLOUGH, H. H.: Linear Arrangement of Genes and Double Crossing Over. *Proceed. Nat. Acad.*, 1919, v.
- PUNNETT, R. C.: On Nutrition and Sex-Determination in Man. *Proc. Camb. Phil. Soc.*, 1903, xii.
- PUNNETT, R. C.: Sex-Determination in Hydatina, with Some Remarks on Parthenogenesis. *Proc. Roy. Soc.*, 1906, lxxviii.
- PUNNETT, R. C.: Mendelism, third ed., New York, 1911.
- PUNNETT, R. C.: Inheritance of Coat Color in Rabbits. *Jour. Gen.*, 1912, ii.
- PUNNETT, R. C.: Reduplication Series in Sweet Peas. *Jour. Gen.*, 1913, iii.
- PUNNETT, R. C.: Further Experiments on the Inheritance of Coat Color in Rabbits. *Jour. Gen.*, 1915, v.
- PUNNETT, R. C., and BAILEY, P. G.: On Inheritance of Weight in Poultry. *Jour. Gen.*, 1914, iv.
- OSAWA, I.: Cytological and Experimental Studies in Citrus. *Jour. Coll. Agr. Imp. Uni. Tokyo*, 1912, iv.

- PACKARD, C.: The Effect of Radium Radiations on the Development of Chaetopterus. *Biol. Bull.*, 1918, xxxv.
- PANTEL, J., and SINÉTY, R. DE: Sur l'Apparition des mâles et d'Hermaphrodites dans les pontes parthénogénétiques des Phasmes. *C. R. Acad. Sci.*, 1908, cxlvii.
- PAYNE, F.: An Experiment to Test the Nature of the Variations on which Selection Acts. *Indiana Univ. Studies*, 1918, v.
- PAYNE, F.: The Effect of Artificial Selection on Bristle Number in *Drosophila ampelophila* and Its Interpretation. *Proc. Nat. Acad. Sci.*, 1918, iv.
- PEARL, R.: The Mode of Inheritance of Fecundity in the Domestic Fowl. *Jour. Exp. Zool.*, 1912, xiii.
- RAWLS, E.: Sex Ratios in *Drosophila ampelophila*. *Biol. Bull.*, 1913, xxiv.
- RIDDLE, O.: Our Knowledge of Melanin Color Formation and Its Bearing on the Mendelian Description of Heredity. *Biol. Bull.*, 1909, xvi.
- RIDDLE, O.: Preliminary Chemical Studies on Male- and Female-Producing Eggs of Pigeons. *Science*, 1912, xxxv.
- RIDDLE, OSCAR: Sex Control and Known Correlations in Pigeons. *Am. Nat.*, 1916, 1, pp. 385-410.
- RIDDLE, OSCAR: Success in Controlling Sex. *Jour. Hered.*, 1916, vii.
- RIDDLE, OSCAR: The Theory of Sex as Stated in Terms of Results of Studies on Pigeons. *Science*, 1917, n.s., xlvi.
- RIDDLE, OSCAR: The Control of the Sex Ratio. *Journ. Wash. Acad. Sc.*, 1917, vii.
- RIDDLE, OSCAR: The Theory of Sex as Stated in Terms of Results of Studies on Pigeons. *Science*, 1917, n.s., xlvi.
- ROBERTSON, W. R. B.: Chromosome Studies. III. Inequalities and Deficiencies in Homologous Chromosomes: Their Bearing upon Synapsis and the Loss of Unit Characters. *Jour. Morph.*, 1915, xxvi.
- ROBERTSON, W. R. B.: Chromosome Studies. I. Taxonomic Relationships Shown in the Chromosomes of *Tettigidae* and *Acrididae*: V-shaped Chromosomes and Their Significance in *Acrididae*, *Locustidae*, and *Gryllidae*: Chromosomes and Variation. *Jour. Morph.*, 1916, xxvii.
- ROBERTSON, W. R. B.: Chromosome Studies IV: A Deficient Supernumerary Accessory Chromosome in a Male of *Tettigidea parvippennis*. *Kansas Uni. Sci. Bull.*, 1917, x, No. 14.
- ROSENBERG, O.: Das Verhalten der Chromosomen in einer hybriden Pflanze. *Ber. Deutsch. bot. Gesell.*, 1903, xxi.
- ROSENBERG, O.: Ueber die Tetradenteilung eines *Drosera*-Bastardes. *Ber. deutsch. bot. Gesell.*, 1904, xxii.

- ROSENBERG, O.: Cytologische und morphologische Studien an *Drosera longifolia* × *rotundifolia*. *Kungl. Svenska Vetensk.-Kaps. akad. Handl.*, 1909, xliii.
- SAUNDERS, E. R.: Further Experiments on the Inheritance of "Double-ness" and Other Characters in Stocks. *Jour. Genet.*, 1911, i.
- SAUNDERS, E. R.: Studies in the Inheritance of Doubleness in Flowers. I. *Petunia*. *Jour. Genet.*, 1911, i.
- SAUNDERS, E. R.: Further Contribution to the Study of the Inheritance of Hoariness in Stocks. (*Mathiola*.) *Proc. Roy. Soc.*, 1912, B, lxxxv.
- SAUNDERS, E. R.: On the Mode of Inheritance of Certain Characters in Double-throwing Stocks. A reply. *Zeit. Abst. Vererb.*, 1913, x.
- SEILER, J.: Das Verhalten der Geschlechtschromosomen bei Lepidopteren. *Zoöl. Anz.*, 1913, xli.
- SEILER, J.: Das Verhalten der Geschlechtschromosomen bei Lepidopteren. *Archiv. für Zellfor.*, 1915, xiii.
- SHEARER, C., MORGAN, W. DE, and FUCHS, H. M.: On Paternal Characters in Echinoid Hybrids. *Q. J. M. S.*, 1912, lviii.
- SHINJI, G. O.: A Contribution to the Physiology of Wing Development in Aphids. *Biol. Bull.*, 1918, xxxv.
- SHULL, A. F.: Studies in the Life Cycle of *Hydatina senta*, I. *Jour. Exp. Zoöl.*, 1910, viii.
- SHULL, A. F.: Inheritance in *Hydatina senta*, II. *Jour. Exp. Zoöl.*, 1915, xviii.
- SHULL, G. H.: The Composition of a Field of Maize. *Am. Breeders' Assoc.*, 1908, iv.
- SHULL, G. H.: The "Presence and Absence" Hypothesis. *Am. Nat.*, 1909, xliii.
- SHULL, G. H.: A Pure Line Method in Corn Breeding. *Am. Breed. Ass.*, 1909, v.
- SHULL, G. H.: Hybridization Methods in Corn Breeding. *Am. Breeder's Mag.*, 1910, i.
- SHULL, G. H.: Inheritance of Sex in *Lychnis*. *Bot. Gaz.*, 1910, xlix.
- SHULL, G. H.: Reversible Sex-mutants in *Lychnis dioica*. *Bot. Gaz.*, 1911, lii.
- SHULL, G. H.: Genotypes, Biotypes, Pure Lines, and Clones. *Science*, 1912, xxxv.
- SHULL, G. H.: Hermaphrodite Females in *Lychnis dioica*. *Science*, 1912, xxxvi.
- SHULL, G. H.: Duplicate Genes for Capsule Form in *Bursa bursa-pastoris*. *Zeits. Abst. Vererb.*, 1914, xii.
- SMITH, G.: Fauna und Flora des Golfes von Neapel. Rhizocephala. *Zoöl. Sta. Neapel. Monographie*, 1906, xxix.
- SMITH, G.: Crustacea. *Cam. Nat. Hist.*, 1909.

- SMITH, G.: Studies in the Experimental Analysis of Sex. Parts 1 and 2. *Q. J. M. S.*, 1910, liv.
- SMITH, G.: Studies in the Experimental Analysis of Sex. Parts 3 and 4. *Q. J. M. S.*, 1910, lv.
- SMITH, G.: Studies in the Experimental Analysis of Sex. Part 5. *Q. J. M. S.*, 1911, lvi.
- SMITH, G.: Studies in the Experimental Analysis of Sex. Part 6. *Q. J. M. S.*, 1911, lvii.
- SMITH, G.: Studies in the Experimental Analysis of Sex. Part 7. *Q. J. M. S.*, 1911, lvii.
- SPILLMAN, W. J.: Spurious Allelomorphism. Results of Recent Investigations. *Am. Nat.*, 1908, xlii.
- SPILLMAN, W. J.: Barring in Barred Plymouth Rocks. *Poultry*, 1909, v.
- STAPLES-BROWN, R.: Second Report on the Inheritance of Color in Pigeons, with Special Reference to Sex-limited Inheritance, 1912.
- STARK, M. B.: An Hereditary Tumor in the Fruit Fly, *Drosophila*. *Jour. Cancer Research*, 1918, iii.
- STARK, M. B.: An Hereditary Tumor. *Jour. Exp. Zoöl.*, 1919, xxvii.
- STEVENS, N. M.: Studies in Spermatogenesis with Especial Reference to the "Accessory Chromosome." *Carnegie Inst., Wash., Pub.* 36, 1905.
- STEVENS, N. M.: A Study of the Germ-cells of Certain Diptera. *Jour. Exp. Zoöl.*, 1908, v.
- STEVENS, N. M.: Heterochromosomes in the Guinea-pig. *Biol. Bull.*, 1911, xxi.
- STOUT, A. B.: The Establishment of Varieties in *Coleus* by the Selection of Somatic Variations. *Carnegie Inst., Wash., Pub.* 218, 1915.
- STRASBURGER, E.: Kernteilung bei der Erbse. *Flora oder Allg. Bot. Zeit. München*, 1911, ii.
- STRONG, R. M.: Results of Hybridizing Ring-doves, Including Sex-linked Inheritance. *Biol. Bull.*, 1912, xxiii.
- STURTEVANT, A. H.: An Experiment Dealing with Sex-linkage in Fowls. *Jour. Exp. Zoöl.*, 1912, xii.
- STURTEVANT, A. H.: Is There Association between the Yellow and Agouti Factors in Mice? *Am. Nat.*, 1912, xlvi.
- STURTEVANT, A. H.: The Linear Arrangement of Six Sex-linked Factors in *Drosophila*, etc. *Jour. Exp. Zoöl.*, 1913, xiv.
- STURTEVANT, A. H.: The Himalayan Rabbit Case, with Some Considerations on Multiple Allelomorphs. *Am. Nat.*, 1913, xlvii.
- STURTEVANT, A. H.: A Third Group of Linked Genes in *Drosophila ampelophila*. *Science*, n.s., 1913, xxxvii.
- STURTEVANT, A. H.: The Reduplication Hypothesis as Applied to *Drosophila*. *Am. Nat.*, 1914, xlviii.

- STURTEVANT, A. H.: Linkage in the Silkworm Moth. *Am. Nat.*, 1914, xlviii.
- STURTEVANT, A. H.: No Crossing Over in the Female of the Silkworm Moth. *Ibid.*, 1915, xlix.
- STURTEVANT, A. H.: A Sex-linked Character in *Drosophila repleta*. *Ibid.*, 1915.
- STURTEVANT, A. H.: Experiments on Sex-Recognition and the Problem of Sexual Selection in *Drosophila*. *Jour. Am. Behav.*, 1915, v.
- STURTEVANT, A. H.: The Behavior of the Chromosomes as Studied through Linkage. *Zeit. Abst. Vererb.*, 1915, xiii.
- STURTEVANT, A. H.: Genetic Factors Affecting the Strength of Linkage in *Drosophila*. *Nat. Acad. Sci.*, 1917, iii.
- STURTEVANT, A. H.: Crossing Over without Chiasmatype. *Genetics*, 1917, ii.
- STURTEVANT, A. H.: An Analysis of the Effects of Selection. *Carnegie Inst., Wash., Pub.* 264, 1918.
- STURTEVANT, A. H.: A Parallel Mutation in *Drosophila funebris*. *Science*, 1918, xlvi.
- STURTEVANT, A. H.: Inherited Linkage Variations in the Second Chromosome. *Carnegie Pub.* 278, Part III, 1919.
- STURTEVANT, A. H., BRIDGES, C. B., and MORGAN, T. H.: The Spatial Relations of Genes. *Proceed. Nat. Acad.*, 1919, v.
- SUMNER, F. B.: Genetic Studies of Several Geographic Races of California Deer-mice. *Am. Nat.*, 1915, xlix.
- SUMNER, F. B.: Several Color Mutations in Mice of the Genus, *Peromyscus*. *Genetics*, 1917, ii.
- SUTTON, W.: On the Morphology of the Chromosome Group in *Brachystola Magna*. *Biol. Bull.*, 1902, iv.
- SUTTON, A. W.: Experiments in Crossing a Wild Pea from Palestine with Commercial Peas. *Rap. IV Conf. Internat. de Génétique.*, 1913.
- TANAKA, Y.: A Study of Mendelian Factors in the Silkworm, *Bombyx mori*. *Jour. Col. Ag. Tohoku Imp. Univ.*, 1913, v.
- TANAKA, Y.: Gametic Coupling and Replulsion in Silkworms. *Ibid.*, 1913, v.
- TANAKA, Y.: Further Data on the Reduplication in Silkworms. *Ibid.*, 1914, vi.
- TANAKA, Y.: Sexual Dimorphism of Gametic Series in the Reduplication. *Trans. Sapporo Nat. Hist. Soc.*, 1914, v.
- TANAKA, Y.: Further Data on the Reduplication in Silkworms. *Jour. Coll. Agr. Sapporo, Japan*, 1914, vi.
- TENNENT, D. H.: A Heterochromosome of Male Origin in Echinoids. *Biol. Bull.*, 1911, xxi.



- TENNENT, D. H.: Studies in Cytology, I and II. *Jour. Exp. Zool.*, 1912, xii.
- THOMPSON, J. A.: Heredity, 1908, London and New York.
- TISCHLER, G.: Ueber Embryosack-Obliteration bei Bastardpflanzen. *Bot. Centralbl. Beihefte*, 1903, xv.
- TISCHLER, G.: Ueber die Entwicklung der Sexualorgane bei einem sterilen Bryonia-Bastard. *Ber. deutsch. bot. Gesell.*, 1906, xxiv.
- TISCHLER, G.: Ueber die Entwicklung des Pollens und der Tapetenzellen bei Ribeshybriden. *Jahr. wiss. Bot.*, 1906, xlii.
- TOWER, W. L.: An Investigation of Evolution in Chrysomelid Beetles of the Genus *Leptinotarsa*. *Carnegie Inst., Wash., Pub.*, 1906, xlviii.
- TOWER, W. L.: The Determination of Dominance and the Modification of Behavior in Alternative (Mendelian) Inheritance by Conditions Surrounding or Incident upon the Germ-cells at Fertilization. *Biol. Bull.*, 1910, xviii.
- TOYAMA, K.: Studies on the Hybridology of Insects, I. On Some Silk-worm Crosses, with Special Reference to Mendel's Law of Heredity. *Bull. Coll. Agr., Tokyo Imp. Uni.*, 1906, vii.
- TOYAMA, K.: On Certain Characteristics of the Silkworm Apparently Non-mendelian. *Biol. Cent.*, 1912, xxxii.
- TROW, A. H.: On the Inheritance of Certain Characters in the Common Groundsel—*Senecio vulgaris*—and Its Segregates. *Jour. Genet.*, 1913, ii.
- TROW, A. H.: Forms of Reduplication—Primary and Secondary. *Jour. Genet.*, 1913, ii.
- TROW, A. H.: A Criticism of the Hypothesis of Linkage and Crossing Over. *Jour. Gen.*, 1916, v.
- TSCHERMAK, E.: Ueber künstliche Kreuzung bei *Pisum sativum*. *Zeit. landw. Versuch. Oest.*, 1900.
- v. TSCHERMAK, A.: Ueber den Einfluss der Bastardierung auf Form, Farbe und Zeichnung von Kanarieneiern. *Biol. Centr.*, 1910, xxx.
- v. TSCHERMAK, A.: Ueber Veränderung der Form, Farbe und Zeichnung von Kanarieneiern durch Bastardierung. *Arch. f. Gesell. Phys.*, 1912, cxlviii.
- v. TSCHERMAK, E.: Der moderne Stand des Vererbungsproblems. *Arch. Rass. und Gesell.*, 1908, v.
- DE VILMORIN, P., and BATESON, W.: A Case of Gametic Coupling in *Pisum*. *Proc. Roy. Soc.*, 1911, B, lxxxiv.
- DE VRIES, H.: Die Mutationstheorie. 1901. Leipzig.
- DE VRIES, H.: Species and Varieties; Their Origin by Mutation, 1905, Chicago.
- DE VRIES, H.: Plant-Breeding; Comments on the Experiments of Nilsson and Burbank, 1907, Chicago.
- DE VRIES, H.: On Twin Hybrids. *Bot. Gaz.*, 1907, xlv.

- DE VRIES, H.: Ueber die Zwillingsbastarde von *Cenothera nanella*. *Ber. deutsch. bot. Ges.*, 1908, xxvi.
- DE VRIES, H.: Bastarde von *Cenothera gigas*. *Ber. deutsch. bot. Ges.*, 1908, xxvi.
- DE VRIES, H.: On Triple Hybrids. *Bot. Gaz.* 1909, xlix.
- DE VRIES, H.: Ueber Doppeltreziproke Bastarde von *Cenothera biennis* and *O. muricata*. *Biol. Centr.*, 1911, xxxi.
- DE VRIES, H.: Gruppenweise Artbildung, 1913, Berlin.
- DE VRIES, H.: The Probable Origin of *Cenothera Lamarckiana* Ser. *Bot. Gaz.*, 1914, xvii.
- DE VRIES, H.: Ueber künstliche Beschleunigung der Wasseraufnahme in Samen durch Druck. *Biol. Centr.*, 1915, xxxv.
- DE VRIES, H.: *Cenothera gigas nanella*, a Mendelian Mutant. *Bot. Gaz.*, 1915, lx.
- DE VRIES, H.: New Dimorphic Mutants of the *Cenotheras*. *Bot. Gaz.*, 1916, lii.
- DE VRIES, H.: Mass Mutation in Zea Mays. *Science*, 1918, xlvii.
- DE VRIES, H.: Van Amoëbe tot Mensch. *Laatste Les aan de Universiteit van Amsterdam*, op 13 Juni 1918.
- WEINSTEIN, A.: Coincidence of Crossing Over in *Drosophila melanogaster* (ampelophila). *Genetics*, 1918, iii.
- WENRICH, D. H.: The Spermatogenesis of *Phrynotettix Magnus* with Special Reference to Synapsis and the Individuality of the Chromosomes. *Bull. Mus. Comp. Zoöl.*, Harvard Coll., 1916, lx.
- WEISMANN, A.: The Germ-plasm, English translation by W. N. Parker and Harriet Rönnefeldt, New York, 1893.
- WEISMANN, A.: Vorträge über Deszendenztheorie, Jena, 1913.
- WHEELER, W. M.: The Origin of Female and Worker Ants from the Eggs of Parthenogenetic Workers. *Science*, 1903, xviii.
- WHEELER, W. M.: The Effects of Parasitic and Other Kinds of Castration in Insects. *Jour. Exp. Zoöl.*, 1910, viii.
- WHEELER, W. M.: A Gynandromorphous Mutillid. *Psyche*, 1910, xvii.
- WHEELER, W. M.: Gynandromorphous Ants, Described During the Decade, 1903-1913. *Am. Nat.*, 1914, xlviii.
- WHELDALE, M.: On the Nature of Anthocyanin. *Proc. Cambridge Phil. Soc.*, 1909, xv.
- WHELDALE, M.: The Colors and Pigments of Flowers, with Special Reference to Genetics. *Proc. Roy. Soc.*, 1909, B, lxxxii.
- WHELDALE, M.: Die Vererbung der Blütenfarbe bei *Antirrhinum majus*. *Zeit. Abst. Vererb.*, 1910, iii.
- WHELDALE, M.: The Chemical Differentiation of Species. *Biochem. Jour.*, 1911, v.
- WHELDALE, M.: On the Formation of Anthocyanin. *Jour. Gen.*, 1911, i.

- WHELDALE, M., and BASSETT, H. L.: The Flower Pigments of *Antirrhinum majus*. III. The Red and Majenta Pigments. *Biochem. Jour.*, 1914, viii.
- WHELDALE, M.: The Chemical Interpretation of Some Mendelian Factors for Flower Color. *Proc. Roy. Soc.*, 1914, B, lxxxvii.
- WHITE, O. E.: Inheritance Studies in *Pisum* I. Inheritance of Cotyledon Color. *Am. Nat.*, 1916, l.
- WHITE, O. E.: Inheritance Studies in *Pisum* IV. Interrelation of the Genetic Factors of *Pisum*. *Jour. Agr. Research*, 1917, xi.
- WHITE, O. E.: Inheritance of Endosperm Color in Maize. *Am. Jour. Bot.*, 1917, iv.
- WHITE, O. E.: Studies of Inheritance in *Pisum*. II. The Present State of Knowledge of Heredity and Variation in Peas. *Proc. Am. Phil. Soc.*, 1917, lvi.
- WHITE, THOS H.: Tomato Variations Induced by Culture. *Md. A.E.S. Bull.* 173, 1913.
- WHITNEY, D. D.: Reinvigoration Produced by Cross Fertilization in *Hydatina senta*. *Jour. Exp. Zoöl.*, 1912, xii.
- WHITNEY, D. D.: The Influence of Food in Controlling Sex in *Hydatina senta*. *Jour. Exp. Zoöl.*, 1914, xvii.
- WHITNEY, D. D.: The Control of Sex by Food in Five Species of Rotifers. *Jour. Exp. Zoöl.*, 1916, xx.
- WHITNEY, D. D.: The Relative Influence of Food and Oxygen in Controlling Sex in Rotifers. *Jour. Exp. Zoöl.*, 1917, xxiv.
- WHITTEN, J. C.: Progress Report on Horticultural Investigations. *Mo. A.E.S. Bull.* 131, 1915.
- WICHURA, M.: Die Bastardbefruchtung im Pflanzenreich, 1865, Breslau.
- WIEMAN, H. L.: The Chromosomes of Human Spermatoocytes. *Am. Jour. Anat.*, 1917, xxi.
- WILSON, E. B.: The Cell in Development and Inheritance. 1899. New York.
- WILSON, E. B.: Studies on Chromosomes, I and II. *Jour. Exp. Zoöl.*, 1905, ii.
- WILSON, E. B.: Studies on Chromosomes, III. *Jour. Exp. Zoöl.*, 1906, iii.
- WILSON, E. B.: Studies on Chromosomes, IV and V. *Jour. Exp. Zoöl.*, 1909, vi.
- WILSON, E. B.: Studies on Chromosomes, VI. A New Type of Chromosome Combination in *Metapodius*. *Jour. Exp. Zoöl.*, 1910, ix.
- WILSON, E. B.: The Chromosomes in Relation to the Determination of Sex. *Sci. Progress*, 1910, xvi.
- WILSON, E. B.: The Sex-chromosomes. *Arch. Mikr. Anat.*, 1911, lxxvii.
- WILSON, E. B.: Studies on Chromosomes, VII. *Jour. Morph.*, 1911, xxii.

- WILSON, E. B.: Studies on Chromosomes, VIII. *Jour. Exp. Zoöl.*, 1912, xiii.
- WILSON, E. B.: Some Aspects of Cytology in Relation to the Study of Genetics. *Am. Nat.*, 1912, xlv.
- WILSON, E. B.: Croonian Lecture: The Bearing of Cytological Research on Heredity. *Proc. Roy. Soc.*, 1914, lxxxviii.
- WINGE, O.: The Chromosomes. Their Numbers and General Importance. *Comp.-ren. des trav. du. Lab. de Carlsberg*, 1917, xiii.
- VON WINIWARTER, H.: Études sur la Spermatogenèse humaine. I. Cellule de Sertoil. II. Hétérochromosome et mitoses de l'épithélium séminal. *Arch. Biol.*, 1912, xxvii.
- WINKLER, H.: Ueber die Nachkommenschaft der Solanum Pfropfbastarde und die Chromosomen Zahlen ihrer Keimzellen. *Zeit. für Botanik.*, ii. Rev. in *Zeit. für indukt. Abst.-u. Vererb.*, 1910, iii.
- WINKLER, H.: Die Chimärenforschung als Methode experimenteller Biologie. *Phys.-Med. Gessellschaft Würzburg, Jahrg.*, 1913-14.
- WOLTERECK, R.: Ueber Veränderung der Sexualität bei Daphniden. Leipzig, 1911.
- WOOD, T. B.: Inheritance of Horns and Face Color in Sheep. *Jour. Agr. Sci.*, 1909, iii.
- WOODRUFF, L. L.: An Experimental Study of the Life History of Hypotrichous Infusoria. *Jour. Exp. Zoöl.*, 1905, ii.
- WOODRUFF, L. L.: The Life Cycle of Paramecium when Subjected to a Varied Environment. *Am. Nat.*, 1908, xlii.
- WOODRUFF, L. L.: On So-called Conjugating and Non-conjugating Races of Paramecium. *Jour. Exp. Zoöl.*, 1914, xvi.
- WOODRUFF, L. L., and ERDMANN, RHODA: A Normal Periodic Reorganization Process without Cell Fusion in Paramecium. *Jour. Exp. Zoöl.*, 1914, xvii.
- WRIGHT, SEWALL: Duplicate Genes. *Am. Nat.*, 1914, xlvi.
- WRIGHT, SEWALL: Color Inheritance in Mammals. *Jour. Hered.*, 1917, viii.
- YATSU, N.: Notes on the Spermatogenesis of the wild and the Domesticated Silkworms. *Annotationes Zoologica Japonenses*, 1913, viii.
- ZELENY, C.: Full-eye and Emarginate-eye from Bar-eye in *Drosophila* Without Change in the Bar Gene. *Abst. 15th Ann. Meet. Am. Soc. Zoöl.*, 1917.
- ZELENY, C.: Selection for High-facet and for Low-facet Number in the Bar-eyed Race of *Drosophila*. *Abst. 15th Ann. Meet. Am. Soc. Zoöl.*, 1917.
- ZELENY, C., and MATTOON, E. W.: The Effect of Selection upon the "Bar-eye" Mutant of *Drosophila*. *Jour. Exp. Zoöl.*, 1915, xix.
- ZELENY, C., and SENAY, C. T.: Variation in Head Length of Spermatozoa in Seven Additional Species of Insects. *Jour. Exp. Zoöl.*, 1915, xix.

# INDEX

- Abnormal abdomen, 28-29, 32, 33  
Abraxas, 175-178, 192, 248  
  type, 173-177, 180  
Albinism, 67  
Albinos, 248  
Allelomorphs, 23, 59, 60  
Allen, 152  
Altenburg, 85, 146  
Amphibians, 114  
Ancyracanthus cystidicola, 39-44  
Andalusian fowls, 26, 32  
Androgenetic, 189  
Annelids, 114  
Antheridia, 152  
Antirrhinum, 221  
Aphids, 197, 207  
Aphid, bearberry, 184  
Apotettix, 146  
Aphis avenae, 208  
Archegonia, 152  
Ascaris, 51, 52, 100, 160  
  nigrovenosa, 196  
Assortment, 73-79  
Atavistic type, 252 253
- Baltzer, 215-217  
Banta, 194  
Bar-eyed, 31, 120, 121, 250  
Bataillon, 189  
Bates, 245  
Bateson, 25, 70, 85, 115-117  
Batracoseps, 46-49, 100, 113  
Baur, 85, 135, 220-222, 250  
Beaded wing, 257-260  
Bean, Florida velvet, 255  
  Lyon, 255  
Beans, 204  
Bearberry aphid, 184  
Bee, 180, 181, 197, 198  
Belling, 255  
Bergson, 267  
Bifid wing, 119  
Bion, 268
- Biophor, 234  
Bird, 174  
Biston, 53, 164  
Black fly, 30, 31, 63, 81-83, 87-90, 96,  
  123, 124, 139-144  
Bonnet, 234, 235  
Boveri, 51, 52, 160, 213-215, 223,  
  224, 231  
Brachet, 189  
Bridges, 55, 97, 114, 122, 127, 129,  
  138, 157, 159, 191, 200, 246  
Bursa pastoris, 71
- Carothers, 74-77  
Castle, 86, 87, 131, 132, 146, 256  
Castration, 244  
Chamberlain, 245  
Chromosomes, 39-58, 73, 96-117  
Circotettix, 74  
Cladocerans, 186  
Clarke, W. T., 210  
Clausen, 233  
Cobs of corn, 249  
Color blindness, 170  
Confluent wing, 272  
Conjugation, 49, 50  
Conklin, 224, 225, 227  
Contamination, 34  
Corn, 85, 135, 229, 249, 252  
Correns, 219-220, 230  
Criss-cross inheritance, 176  
Crossing over, 87-95, 96-117, 139  
Cuénot, 25, 256  
Curved wing, 96, 124, 140-144  
Cut wing, 122, 248  
Ctenolabrus, 54, 232  
Cynthia, 227  
Cytoplasmic inheritance, 219-226
- Dachs, 123  
  deficiency, 124  
Daphnians, 197  
Darwin, 234, 267, 269

- Davenport, 33, 34  
 Deficiency, 159  
 Delage, 188  
 Dichete, 261, 262  
*Diffugia corona*, 207  
 Digby, 151  
*Dilina*, 164  
 Diluting factor, 70  
 Diploid, 84, 153-154  
 Disjunction, 23  
 Doncaster, 55, 164, 177, 192, 193  
 Dominance, 25, 60  
 Double crossing over, 119  
 Driesch, 231, 242  
*Drosera longifolia*, 160  
   *rotundifolia*, 160  
*Drosophila busckii*, 57, 86, 135  
   *funnebris*, 273  
   *melanica*, 57  
   *melanogaster*, 27, 28, 30, 31, 37,  
     54, 57, 63, 66, 80, 84, 85, 87,  
     94-96, 113-115, 118, 127, 129,  
     130, 133, 134, 139, 143, 145, 146,  
     157, 159, 167, 170, 176, 177, 190,  
     191, 198-200, 236-238, 240, 248,  
     249, 251, 253, 256-258, 260, 263,  
     270, 271  
   *repleta*, 86, 135  
   *virilis*, 85, 135, 272  
 Dumpy wing, 66, 67  
 Duplication, 159  
  
 East, 229, 230  
 Ebony fly, 27, 63  
 Echinus eye, 122  
 Emerson, 249  
 Endosperm, 229, 230  
 Engledow, 85  
 Enzyme, 245  
 Eosin eye, 70  
 Equation division, 43  
*Euglena*, 185, 187  
 Ewing, 208  
  
 Federley, 54, 162  
 Flinty corn, 229  
 Flowery corn, 229  
 Fish, 54  
 Forked bristles, 92, 93, 122, 272  
 Four-o'clock, 25, 220  
  
 Fowls, 239, 270  
 Fruit fly, 252, 272  
*Fundulus*, 54, 232  
  
 Game bantam, 244  
 Gamete, 84  
 Gametic lethal, 254, 265  
 Garnet eye, 122  
 Gates, 149, 155, 156  
 Geerts, 155  
 Gene, 234-246  
 Genes, the order of, 118-125  
 Germ-plasm, 234, 239  
*Gigas*, *Oenothera*, 149, 265  
 Goldschmidt, 245  
 Goodale, 86, 180, 244  
 Goodspeed, 233, 256  
 Gowen, 127, 146  
 Grasshopper, 74, 75  
 Gregory, 85, 146, 150  
 Groundsel, 85  
 Grouse locust, 146  
 Guinea pigs, albino, 271  
 Guyer, 136, 137, 170, 174, 178, 179  
 Gynandromorph, 190-193  
 Gypsy moth, 194  
  
*Hæmophilia*, 170  
 Hairless fly, 273  
 Hance, 157  
 Haploid, 55, 153, 154  
 Harrison, 55, 164  
 Hayes, 229, 230  
 Hegner, 207  
 Herbst, 213, 217, 218  
 Herlandt, 188  
*Hermaphrodite*, 197  
   plant, 154  
 Hertwig, G., 188  
 Hertwig, O., 114, 188  
 Hertwig, R., 188  
 Heterozygous, 23  
 Homozygous, 23  
 Hornet, 181  
*Hydatina senta*, 185  
  
 Individuality of the chromosomes,  
   51  
 Insects, 114  
 Interference, 126-132

- Internal secretion, 244  
 Intersexes, 193  
  
 Janssens, 46, 48, 102, 110, 112  
 Jennings, 207  
 Jesenko, 256  
 Johannsen, 204-206, 246  
 Jones, 85  
 Keeble, 150  
 King, 231  
 Kuschakewitsch, 188  
 Kuttner, O., 194  
 Lamarckian theory, 267  
 Langshan, 177-180  
 Leptotene thread, 100, 107  
 Lethal, 254, 257-265  
     factor, 198-200  
 Linkage, 80-86, 94  
     groups, 133  
 Lippincott, 26  
 Little, 256  
 Liverwort, 152  
 Loeb, J., 189, 225, 226, 231, 245  
 Lutz, A., 155, 157  
 Lymantria dispar, 194  
     japonica, 194  
  
 Maize, 229  
 Man, 137, 170, 200  
 McClung, 165  
 Marchal, Élie and Émile, 151-154  
 • Maréchal, 49  
 Marshall, 35  
 Maternal inheritance, 227-233  
 Maturation division, 43  
 May, 250  
 Melandrium, 221  
 Melanic forms, 248, 271  
 Men, 136  
 Mendel, 15-17, 19, 22, 23, 37, 38, 85,  
     236  
 Mendelism, 36  
 Mendel's first law, 19-38, 73  
     second law, 59-72, 79  
 Menidia, 232  
 Metapodius, 57  
 Metz, 57, 85, 135, 137, 272  
 Meves, 181, 182  
 Mice, albino, 271  
 Miniature wing, 66, 67, 91-93  
  
 Mirabilis jalapa, 25, 32, 219, 220  
 Mitotic division, 40  
 Modifying genes, 246  
 Moenkhaus, 55  
 Moore, 231  
 Morgan, 35, 112, 191  
 Morris, 55  
 Moss, 151-154  
 Moths, 55  
 Mouse, 67, 68, 70, 135, 137  
     albino, 70  
     blue, 70  
     chocolate, 70  
     silver-fawn, 70  
     yellow, 257  
 Muller, 35, 85, 127, 129, 130, 150,  
     258, 260  
 Mulsow, 39, 41  
 Multiple Allelomorphs, 251-254  
 Mutation, 247-273  
  
 Nabours 37, 86, 146  
 Natural selection, 267-270  
 Nicotiana sylvestris, 256  
     tabacum, 256  
 Non-disjunction, 200-203  
 Notch, 35  
 Notch wing, 248  
 Nova Scotia stock, 143, 144  
  
 Oats, 85, 135  
 Oenothera lœta, 264  
     Lamarckiana, 53, 85, 149, 155,  
         262-264  
     scintillans, 157  
     velutina, 264  
 Ouslow, 245  
 Oögonia, 154  
 Orthogenesis, 266  
 Osawa, 256  
  
 Pachytene thread, 49  
 Packard, 188, 189  
 Paleontologists, 266  
 Parthenogenesis, 39, 180, 204-211  
     artificial, 188, 189  
 Pea comb, 68, 69  
 Pea, Garden, 19-23, 32, 59-62, 85  
     Palestine, 256  
     wild, 270

- Peach eye, 261  
 Pelargonium, 221  
 Petrunkevitch, 198  
 Phaseolus vulgaris, 204  
 Phillips, 207  
 Phrynotettix, 104-110  
 Phylloxera caryocaulis, 183  
 Phylloxerans, 197  
 Pinney, 55, 232  
 Pisum humile, 256  
   sativum, 19, 134  
 Plough, 96-99, 115, 139-142  
 Plymouth rock, barred, 176, 180  
 Polar body, 40  
 Polytoma, 186  
 Prematuration stage, 142  
 Primary split, 101, 102, 107, 108  
 Primrose, 85  
 Primula floribunda, 150, 151  
   kewensis, 151  
   sinensis, 85, 87, 135, 146, 150  
   verticillata, 150, 151  
 Pristiurus melanostomus, 49  
 Protenor, 55, 56  
 Protozoa, 207  
 Punnett, 70, 85, 115-117, 250  
 Pure culture, 250  
   lines, 204, 211  
 Purple eye, 96, 124, 139-144, 240  
 Pygæra, 161, 163
- Rabbits, albino, 271  
 Rat, black, 271  
   Norway, 271  
   roof, 271  
   yellow, 271, 272  
 Recessive, 23, 25  
 Reduction division, 43, 75, 101  
 Reduplication, 115-117  
 Regeneration, 154  
 Reversal of dominance, 33  
 Riddle, 194, 196, 245  
 Ring dove, 194  
 Robertson, 74, 102, 103, 111-112  
 Rose comb, 68, 69  
 Rosenberg, 160, 161, 256  
 Rotifer, 185, 197, 198  
 Roux, 142  
 Rudimentary wing, 248
- Sable body color, 158, 159  
 Saunders, 85, 254  
 Satsuma, 256  
 Schreiners, 44  
 Scute, 122  
 Sebrights, 243, 244  
 Secondary split, 101, 102  
 Sea urchin, 188, 189  
 Segregation, 16, 23, 39  
 Seiler, 174, 179  
 Selachian egg, 50  
 Selachians, 114  
 Senecio vulgaris, 85  
 Sex, 196-203  
   chromosomes, 42, 57  
   determination, 180  
   genes, 193  
   linked characters, 84  
   ratios, 197-200  
 Shinji, 210  
 Shull, 71  
 Silkworm, 135, 137, 146, 186, 228  
 Simocephalus, 194  
 Smerinthus, 164  
 Single comb, 68, 69  
 Snapdragon, 85, 135, 255  
 Sooty fly, 27  
 Species, 270  
 Speck, 123, 144  
 Spencer, Herbert, 234  
 Spermatogonia, 154  
 Spermatogenesis, 104-110  
 Spermatozoon, 43  
 Sphærechinus, 216, 217  
 Spores, 151  
 Sports, 248  
 Squirrels, albino, 271  
 Star eye, 122, 123  
 Stark, 256  
 Stenotomus, 232  
 Stevens, 145, 165  
 Stocks, 85, 254  
 Stomps, 149, 155  
 Streptopelia abla, 194  
 Strong, 196  
 Strongylocentrotus, 216, 217  
   Franciscanus, 231, 232  
   purpureus, 231, 232



- Sturtevant, 86, 114, 117, 125, 127,  
     143-145, 191, 260, 261, 272  
 Sundew, 256  
 Surface, 85, 135  
 Sutton, 16, 256  
 Sweet peas, 70, 85  
 Synaptic stage, 47  
 Syndactyls, 33, 34  
 Synzesis stage, 46  
  
 Tadpole, 189  
 Tanaka, 86, 135  
 Temperature, 96-97, 139-142  
 Tennent, 188, 231  
 Tetrads, 39, 43, 50, 75, 107, 114  
 Tetraploid, 150, 154, 159  
 Tettigidea, 111  
 Tomatoes, 85  
 Tomopteris, 44-46, 100, 113  
 Toyama, 191, 192, 228  
 Trimerotropsis, 74, 75, 78  
 Triploid, 155, 160  
 Trow, 117  
 Truncate wing, 248  
 Turtle dove, 194  
 Turtur orientalis, 194  
 Twin hybrids, 264  
  
 Variation—in linkage, 139-146  
 Variation—in number of chromo-  
     somes, 147-164  
 Vermilion eye, 158, 159, 248  
 Vestigial fly, 63, 81-83, 87-90, 123,  
     124  
  
 Vilmorin, 85  
 Vinegar fly, 27, 28, 70, 168-170, 172  
 Voinov, 74  
 Vries, de, 85, 149, 155, 263, 264,  
     266, 273  
  
 Walnut comb, 68, 69  
 Warren, 85  
 Wasps, 198  
 Weatherwax, 229  
 Weinstein, 127, 129, 131  
 Weismann, 234, 235, 242  
 Wenrich, 74, 102, 110, 113  
 Wheat, 85, 135  
 White, O. E., 20, 67, 85, 134  
 White-eyed fly, 91-93, 118, 167, 168,  
     171-173, 238, 248, 271  
 Whiting, 70  
 Whitney, 185, 186  
 Wilson, E. B., 55, 165  
 Winiwarter, 136-137, 170  
 Wright, 86, 87  
  
 Xenia, 230  
  
 Yatsu, 135, 137  
 Yellow mouse, 257  
 Yellow-winged fly, 91, 118, 120, 171-  
     173, 190, 250, 272  
 Yocom, 137  
  
 Zea mais, 229, 249  
 Zygote, 84  
 Zygote stage, 107  
 Zygotic lethal, 254, 256









