

CORNELL
UNIVERSITY
LIBRARY



Cornell University Library
QH 205.H71

Microscope :



3 1924 024 737 136

oIn

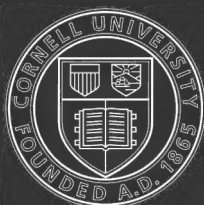

Cornell University
Library

The original of this book is in
the Cornell University Library.

There are no known copyright restrictions in
the United States on the use of the text.

<http://www.archive.org/details/cu31924024737136>



MICROSCOPE
ITS
HISTORY,
CONSTRUCTION, AND
APPLICATIONS.

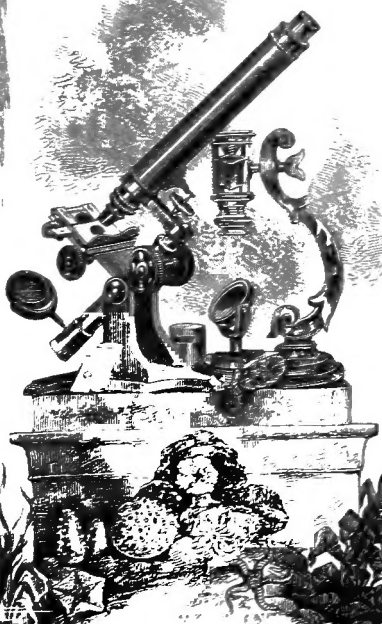

**LORD HOUSE
STRAND.**

Pearson, Sc.

THE
MICROSCOPE:

ITS

HISTORY, CONSTRUCTION, AND APPLICATIONS.

BEING A

FAMILIAR INTRODUCTION TO THE USE OF THE INSTRUMENT

AND

The Study of Microscopical Science.

BY JABEZ HOGG, M.R.C.S.

ASSISTANT SURGEON TO THE ROYAL OPHTHALMIC HOSPITAL CHARING CROSS,
FELLOW OF THE MEDICAL SOCIETY OF LONDON,
MEMBER OF THE MICROSCOPICAL AND PATHOLOGICAL SOCIETIES OF LONDON,
AUTHOR OF ELEMENTS OF NATURAL PHILOSOPHY, ETC.

Illustrated with upwards of Five Hundred Engravings.

SECOND EDITION.

LONDON:
HERBERT INGRAM AND CO. 198 STRAND.

1856.

PREFACE TO THE SECOND EDITION.

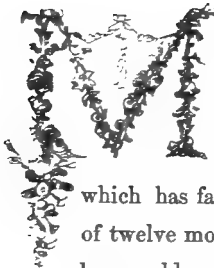
 MY endeavour, in the First Edition of this work, to produce a cheap and popular guide to the use of the Microscope, and thus to supply a want which I had long believed it very desirable to see supplied, has been rewarded by a success which has far exceeded my expectations. In the short space of twelve months a large edition of *five thousand copies* has been sold; and I am now called upon to prepare a Second Edition.

My efforts on this occasion have been directed to the thorough correction and revision of the whole work, rather than to extending it with much new matter; and I trust I shall have succeeded in making the present Edition more free from blemish and more generally useful to the public than the preceding one. In endeavouring to do so, I have fully availed myself of the judicious suggestions and criticisms of many kind friends; and I wish to take this opportunity of acknowledging the obligations I am under to those who have so generously accorded to this small work, whatever its defects, their meed of approbation.

August 1855.

PREFACE TO THE FIRST EDITION.



THE author of the present publication entered upon his task with some hesitation and diffidence ; but the reasons which influenced him to undertake it may be briefly told ; and they at once explain his motives, and plead his justification, for the work which he now ventures to submit to the indulgent consideration of his readers.

It had been to him for some time a subject of regret, that one of the most useful and fascinating of studies—the study that belongs to the domain of microscopic observation—should be, if not wholly neglected, at best but coldly and indifferently appreciated, by the great mass of the general public ; and he formed a strong opinion, that this apathy and inattention were mainly attributable to the want of some concise, yet sufficiently comprehensive, *popular* account of the Microscope, both as regards the management and manipulation of the instrument, and the varied wonders and hidden realms of beauty that are disclosed and developed by its aid. He saw around him valuable, erudite, and splendid volumes ; which, however, being chiefly destined for circulation amongst a special class of readers, were necessarily, from the nature of their contents and the style of their production, published at a price that renders them practically unattainable by the great bulk of the public. They

constitute careful and beautiful contributions to the purposes of science ; but they cannot adequately serve to bring the value and charm of microscopic studies home, so to speak, to the firesides of the people. Repeatedly, day after day, new and interesting discoveries, and further amplifications of truths already discerned, have been made ; but they have been either scattered in serials, or, more usually, devoted to the pages of class publications. Thus this most important and attractive study has been, in a great measure, the province of the few only, who have derived from it a rich store of enlightenment and gratification ; the many not having, however, participated, to any general extent, in the instruction and entertainment which follow in its train.

The manifold and various uses and advantages of the Microscope crowd upon us in such profusion, that we can only attempt to enumerate them in the briefest and most rapid manner in these few prefatory pages. It is not many years since this invaluable instrument was regarded in the light of a costly toy ; it is now the inseparable companion of the man of science.

In the medical world its utility and necessity are fully appreciated, even by those who formerly were slow to see its benefits. Knowledge which could not be obtained by the minutest dissection is acquired by the aid of the Microscope, which has become as essential to the anatomist and pathologist as the scalpel to the one and bedside observation to the other. The smallest portion of a diseased structure, placed under a Microscope, will tell more in one minute to the experienced eye than could be ascertained by many days' examination of the gross masses of disease in the ordinary method. Microscopic agency, in thus assisting the medical man, materially contributes to the alleviation of those multiplied "ills which flesh is heir to."

So fully impressed were the Council of the Royal College of Surgeons with the importance of the facts brought to light in a short space of time, that in 1841 they determined to establish a Professorship of

Histology, and to form a collection of preparations of the elementary tissues of both animals and vegetables, healthy and morbid, adapted to illustrate the uses and results of microscopical investigations. From that time histological anatomy deservedly became an important branch of the education of the medical student.

By "conducting the eye to the confines of the visible form," the Microscope proves an effective auxiliary in defining the geometric properties of bodies. Its influence as an instrument of research upon the structure of bodies has been compared to that of the galvanic battery, in the hands of Davy, upon Chemistry. It has enabled us to detect the smallest structural difference, heretofore inappreciable; and in our analysis to define *positively* the structure of tissues beyond the capability of the greatest magnifying power to change or modify.

The Microscope, as an ally of Chemistry, enables us to discover very minutely and completely the changes of form and colour effected by test-fluids upon solids; it dissects for us, so to speak, the most multiplex compounds; it opens out to the mind an extended and vast tract, opulent in wonders, rich in beauties, and boundless in extent.

In prosecuting the study of Vegetable Physiology, the Microscope is an indispensable instrument; it empowers the student to trace the earliest forms of vegetable life, and the functions of the different tissues and vessels in plants. Valuable assistance is derived from its agency in detecting the adulteration of our articles of food, as has been verified by the exposures—which must have done great good—that have from time to time appeared in the *Lancet*, and subsequently collected into a volume by Dr. Hassall. In the examination of suspected flour, an article of so much importance to all persons, the Microscope enables us to judge of the size and shape of the starch-grains, the markings of them, and their isolation and agglomeration, and thus to distinguish the starch-grains of one meal from those of another. In the necessarily limited space of this work, the author has only been able to glance at the subject of the minute structure of vegetables; but the remarks and

reflections which he has devoted to it will, he hopes, lead the microscopist to a fuller investigation of one of the most beautiful departments of nature.

The Zoologist finds in the Microscope a necessary co-operator. To the Geologist it reveals, among a multiplicity of other facts, "that our large coal-beds are the ruins of a gigantic vegetation; and the vast limestone rocks, which are so abundant on the earth's surface, are the catacombs of myriads of animal tribes, that are too minute to be perceived by the unaided vision."

In medico-legal investigations the Microscope has been frequently called into use; and in some cases human life has been pending upon its accuracy of decision.

The Microscope not only assists studies, and develops objects of profound interest, but it also opens up innumerable sources of entertainment and amusement, in the ordinary conventional acceptance of these terms. It discloses to us peculiarities and attractions in abundance. It impresses us with the wonderful and beautifully-skilful adaptation of all parts of creation, and fills our minds with additional reverence and admiration for the beneficent and Almighty Creator.

The author begs now to conclude these preliminary observations with a few words in explanation of his arrangements, and by way of acknowledgment to those to whom he is indebted. He has sought, in the volume that he now lays before the public, to point out and elucidate, at once in a practical manner and in a popular style, the vast fund of utility and amusement which the Microscope affords; and has endeavoured to touch upon most of the interesting subjects for microscopic observation as fully as the restrictions of a limited space, and the nature of a succinct summary, would permit. To have dwelt upon each in complete detail would have necessitated volume upon volume,—expensive books must have resulted,—and this would have entirely frustrated the aim which the writer had in view; he has, therefore, contented himself with the humble, but, he trusts, not useless task, of

setting up a finger-post, so to say, to direct the inquirer into the wider road. In the section of the work devoted to the very minute portion of creation, he has ventured to dwell somewhat longer upon the subject, in the belief that that department is more especially the province of the microscopist than many others. He has arranged his topics under special headings, and in separate chapters, for the sake of greater clearness and precision ; and has brought the ever-welcome aid of illustrations to convey his explanatory remarks more vividly to the minds of his readers. To his friend, Mr. J. G. Kelly, he has to express his thanks for valuable assistance afforded in making drawings of the objects from the microscope and *camera lucida* ; as also to Mr. George Pearson, for the admirable manner in which he has engraved them. The author has minutely described the use and manipulations of the Microscope, so as to render its management, he ventures to hope, intelligible to all ; and his marked and warm acknowledgments are due to the eminent maker and improver of the Microscope, Mr. Ross, for his revision of this portion of the work. He is peculiarly indebted to Professor John Quekett, whose very valuable lectures, delivered in the Royal College of Surgeons, and other multifarious and successful researches, have pre-eminently distinguished him as *the* microscopist of the day. From notes made at the lectures spoken of, and from the many admirable papers which this gentleman has published, much sound information has been gleaned ; and the author has to thank him, in the most sincere and cordial manner, for the ready acquiescence that he gave to the writer's wish to cull from the choicest of the mass of contributions with which he has enriched microscopical science. The author has also freely availed himself of the researches of other scientific investigators,—Leeuwenhoek, Ehrenberg, Carpenter, Johnston, Ralfs, Busk, Gosse, Hassall, and the members of the Microscopical Society of London, to the foundation of which excellent society we may ascribe the rise and progress of many improvements in the instrument ; and it has tended, moreover, to stimulate discoveries, and induce greater accuracy of observation.

Finally, it is the author's hope that, by the instrumentality of this volume, he may possibly assist in bringing the Microscope, and its most valuable and delightful studies, before the general public in a more familiar, compendious, and economical form than has hitherto been attempted ; and that he may thus, in these days of a diffused taste for reading and the spread of cheap publications, submit some further food for the exercise of the mental and intellectual faculties,—contribute to the additional amusement and instruction of the family circle around the domestic hearth,—and aid the student of nature in investigating the wonderful and exquisite works of the Almighty Hand. If it shall be the good fortune of this work, which is now confided with great diffidence to the consideration of the public, to succeed, in however slight a degree, in furthering this design, the author will feel sincerely happy ; and will be fully repaid for the attention, time, and labour, that he has expended in writing, arranging, and compiling it.

6 Gower Street, Bedford Square,
May 1854.

DIRECTIONS FOR PLACING THE PLATES.

Frontispiece and Engraved Title to face each other, and precede the printed title-page.

PLATE	to face page
II. Fossil Infusoria	154
IV. Sponges, Spicula from	176
V. Zoophytes	194
VI. Echino-dermata, &c.	252
VII. Proboscis of Fly	286
VIII. Tongue, &c. of Drone-fly	296
IX. Antenna, &c. of Moth	304
X. Scales from Wings of Butterflies	306
XI. Parasites	326
XII. Animal Structures	344
XIII. Animal Tissues	352
XIV. Human Skin and Hair	360
XV. Vegetable Cells, &c.	394
XVI. Vegetable Structures	424

CONTENTS

PART I.

History of the Invention and Improvements of the Microscope.

CHAPTER I.

History of the Microscope	PAGE 1
-------------------------------------	-----------

CHAPTER II.

Mechanical and Optical Principles involved in the Construction of the Microscope—Lenses—Mode of Estimating their Power, &c.—Achromatic Lenses—Magnifying Power—Wollaston's Doublet—Coddington's Lens—Ross's Simple and Compound Microscopes—Baker's Microscopes—Micrometers, &c.	12
--	----

CHAPTER III.

Preliminary Directions—Illumination—Accessory Apparatus—Achromatic Illuminator—Gillett's Condenser—Preparing and Mounting Objects—Injecting—Chemical re-agents—Collecting Objects—The Camera Lucida—Polarised Light—Binocular Instrument—Photographic Drawing	53
---	----



PART II.

CHAPTER I.

Protozoa—Rhizopoda—History of Infusorial Animalcules—Monads—Diatomaceæ, Fossil Infusoria, Vorticellidæ, Stentors, Rotifera, Floscularidæ, Xanthidia—Sponges	129
---	-----

	PAGE
CHAPTER II.	
Polypifera. Hydroida—Zoophytes, or Polyyps—Bryozoa—Acalephæ— Echinidæ—Holothuridæ	195
CHAPTER III.	
Mollusca—Gasteropoda—Collecting Specimens	253
CHAPTER IV.	
Articulata. Entozoa—Annelida—Crustacea—Arachnidæ	270
CHAPTER V.	
Articulata. Insects—Acarina	286
CHAPTER VI.	
Animal Structure. Physiology—Histology—Cell Theory—Growth of Tissues—Special Tissues—Skin, Cartilage, Teeth, Bone, &c.	343
CHAPTER VII.	
Vegetable Structure—Vital and Chemical Characteristics—The Vege- table Cell—Fungi—Mosses—Algæ—Volvox—Desmidaceæ—Struc- ture of Plants—Fungoid Diseases—Adulteration of Articles used for Food—Preparation for Microscopic Examination—Cutting Sec- tions—Warrington's Microscope—Magnifying Power of the Eye— Conclusion	394

THE MICROSCOPE.

PART I.

HISTORY OF THE INVENTION AND IMPROVEMENTS OF THE MICROSCOPE.

CHAPTER I.

HISTORY OF THE MICROSCOPE.

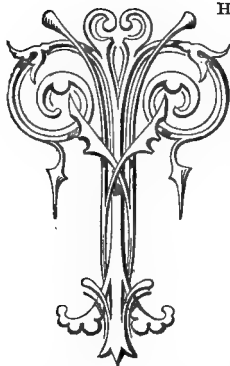

THE instrument known as the Microscope derives its name from two Greek words, *μικρός* *small*, and *σκοπέω* *to view*; that is, to see or view such minute objects as without its aid would be invisible.

The invention of the microscope cannot be traced with any degree of certainty before the year 1660, a period fruitful in discoveries. The honour of the invention is claimed by the Italians and the Dutch; the name of the inventor, however, is lost. Probably the discovery did not at first appear sufficiently important to engage the attention of those men who, by their reputation in science, were able to establish an opinion of its merit with the rest of the world, and to hand down the name of its inventor to succeeding ages.

It is not difficult to fix the period when the microscope first began to be generally known, and to be used for the purpose of examining minute objects; for though we are ignorant of the name of the first inventor, we are acquainted with the names of those who introduced it to public view. Zacharias Jansens and his son are said to have made microscopes before the year 1590: about that time the ingenious Cor-

nelius Drebell brought one made by them with him to England, and showed it to William Borrell and others. It is possible this instrument of Drebell's was not strictly what is now called a microscope, but was rather a kind of microscopic telescope, something similar in principle to that lately described by M. Aepinus in a letter to the Academy of Sciences at St. Petersburg. It was formed of a copper tube six feet long and one inch in diameter, supported by three brass pillars in the shape of dolphins; these were fixed to a base of ebony, on which the objects to be viewed by the microscope were placed. Fontana, in a work which he published in 1646, says that he had made microscopes in the year 1618: this may be perfectly true, without derogating from the merit of the Jansens; for we have many instances in our own times of more than one person having made the same invention nearly simultaneously, without any communication from one to the other. In 1685 Stelluti published a description of the parts of a bee, which he had examined with a microscope.

If we consider the microscope as an instrument consisting of one lens only, it is not at all improbable that it was known at a very early period, nay even in a degree to the Greeks and Romans; at any rate, it is tolerably certain that spectacles were used as early as the thirteenth century. Now as the glasses of these were made of different convexities, and consequently of different magnifying powers, it is natural to suppose that smaller and more convex lenses were made, and applied to the examination of minute objects.

Aristophanes, who lived five centuries before Christ, speaks of a "burning-sphere." Seneca, who wrote in the first half-century of the Christian era, says that small and indistinct objects become larger and more distinct in form when seen through a globe of glass filled with water. Pliny also mentions the burning property of lenses made of glass.

The history of the microscope, like that of nations and arts, has had its brilliant periods, in which it shone with uncommon splendour, and was cultivated with extraordinary ardour; and these have been succeeded by intervals marked with no discovery, and in which the science seemed to fade away, or at least to lie dormant, till some favourable circumstance—the discovery of a new object, or some new improvement in the instruments of observation—awakened the attention of the curious, and reanimated their researches. Thus, soon after the invention of the microscope, the field it presented to observation was cultivated by men of the first rank in science, who enriched almost every branch of natural history by the discoveries they made by means of this instrument.

We shall first speak of the single microscope, that, as we have already observed, having been invented and used long before the double or compound microscope. When the lenses of the single microscope are very convex, and consequently the magnifying power very great, the field of view is small; and it is so difficult to adjust with accuracy their focal distance, that it requires some practice to render the use of them familiar. It was with an instrument of this kind that Leeuwenhoek and Swammerdam, Lyonet and Ellis, examined the invisible forms of nature, laid open some of her hidden recesses, and by their example stimulated others to the same pursuit.

About the year 1665, small glass globules began to be occasionally applied to the single microscope, instead of convex lenses. By these globules an immense magnifying power was obtained. Their invention has been generally attributed to M. Hartsoeker; though it appears that we are really indebted to the celebrated Dr. Hooke for this discovery, for he described the manner of making them in the preface to his *Micrographia Illustrata*, published in the year 1656.

Mr. Stephen Gray* having observed some irregular particles within a glass globule, and finding that they appeared distinct and prodigiously magnified when held close to his eye, concluded, that if he placed a globule of water in which there were any particles more opaque than the water near his eye, he should see those particles distinctly and highly magnified. The result of this idea far exceeded his expectation. His method was, to take on a pin a small portion of water which he knew contained some minute animalcules; this he laid on the end of a small piece of brass wire, till there was formed somewhat more than a hemisphere of water; on applying it then to the eye, he found the animalcules most enormously magnified; for those which were scarcely discernible with his glass globules, with this appeared as large as ordinary-sized peas. Montucla observes, that when any objects are enclosed within this transparent globule, the hinder part of the globule acts like a concave mirror, provided the objects be situated between that surface and the focus; and that by this means they are magnified three times and a half more than they would be in the usual way.

An extempore microscope may be formed by taking up a small drop of water on the point of a pin, and placing it over a fine hole made in a piece of metal; but as the refractive power of water is less than that of glass, these globules do not magnify so much as glass ones of the same size: this was also one of Mr. Gray's magnifiers. The

* Philosophical Transactions, 1696.

same ingenious author invented another water-microscope, consisting of two drops of water separated in part by a thin brass plate, but touching near the centre, which were thus rendered equivalent to a double-convex lens of unequal convexities.

Dr. Hooke described the method of using this single microscope: "If you are desirous," he says, "of obtaining a microscope with one single refraction, and consequently capable of procuring the greatest clearness and brightness any one kind of microscope is susceptible of, spread a little of the fluid you intend to examine on a glass plate; bring this under one of your microscopic globules, then move it gently upwards till the fluid touches the globule, to which it will soon adhere, and that so firmly as to bear being moved a little backwards or forwards. By looking through the globule, you will then have a perfect view of the animalcules in the drop."

The construction of the single microscope is so simple, that it is susceptible of but little improvement, and has therefore undergone few alterations; and these have been chiefly confined to the mode of mounting it, or to additions to its apparatus. The greatest improvement this instrument has received was made by Dr. Lieberkuhn,* about the year 1740: it consists in placing the small lens in the centre of a highly-polished concave speculum of silver, by which means a strong light is reflected upon the upper surface of an object, which is thus examined with great ease and pleasure. Before this contrivance, it was almost impossible to examine small opaque objects with any degree of exactness and satisfaction; for the dark side of the object being next the eye, and also overshadowed by the proximity of the instrument, its appearance was necessarily obscure and indistinct.

Lieberkuhn adapted a separate microscope to every object: but all this labour was not bestowed on trifling objects; his were generally the most curious anatomical preparations, twelve of which, with their microscopes, are deposited in the Museum of the Royal College of Surgeons.

fig. 1. Lieberkuhn's instrument, fig. 1, is thus described by Professor Quekett: † *a b* represents a piece of brass tube, about an

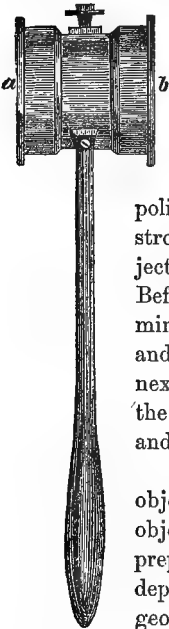

* Dr. Nathaniel Lieberkuhn of Berlin.

† Practical Treatise on the Microscope, p. 16.

inch long and an inch in diameter, which is provided with a cap at each extremity; the one at *a* carries a small double-convex lens of half an inch in focal length, whilst the one at *b* carries a condensing lens three-quarters of an inch in diameter.

A vertical section of one of these instruments is seen in fig. 2: *a* represents the magnifier, which is lodged in a cavity formed partly by the cap *a* and by the silver cup or speculum *l*. In front of the lens is the speculum *l*, which is a quarter of an inch thick at its edge, and whose focus is about half an inch; in front of this again there is a disk of metal *c*, three-eighths of an inch in diameter, connected by a wire with the small knob *d*; upon this disk the injected object is fastened, and is covered over with some kind of varnish which has dried of a hemispherical figure. Between this knob and the inside and outside of the tube there are two slips of thin brass, which act as springs to keep the wire and disk steady. When the knob is moved, the injected object is carried to or from the lens, so as to be in its focus, and to be seen distinctly, whilst the condensing lens *b* serves to concentrate the light on the speculum. To the lower part of the tube a handle of ebony, about three inches in length, is attached by a brass ferrule and two screws. The use of this instrument is obvious: it is held in the hand in such a position that the rays of light from a lamp or white cloud may fall on the condenser *b*, by which they are concentrated on the speculum *l*; this, again, further condenses them on the object and the disk *c*, which object, when so illuminated, can readily be adjusted by the little knob *d*, so as to be in the focus of the small magnifier at *a*.

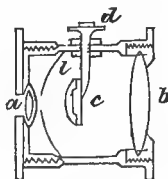

fig. 2.

*Lieberkuhn's
Microscope.*

We must not omit in this place some account of Leeuwenhoek's microscopes, which were rendered famous throughout all Europe, on account of the numerous discoveries he had made with them, as well as from his afterwards bequeathing a part of them to the Royal Society.

The microscopes he used were all single, and fitted up in a convenient and simple manner: each consisted of a very small double-convex lens, let into a socket between two plates riveted together, and pierced with a small hole; the object was placed on a silver point or needle, which, by means of screws adapted for that purpose, might be turned about, raised or depressed at pleasure, and thus be brought nearer to, or be removed farther from, the glass, as the eye of the observer, the nature of the object, and the convenient examination of its parts required.

Leeuwenhoek fixed his objects, if they were solid, to these points with glue ; if they were fluid, he fitted them on a little plate of talc, or exceedingly thin-blown glass, which he afterwards glued to the needle in the same manner as his other objects. The glasses were all exceedingly clear, and of different magnifying powers, proportioned to the nature of the object and the parts designed to be examined.

He observed, in his letter to the Royal Society, that, from upwards of forty years' experience, he had found the most considerable discoveries were to be made with glasses of moderate magnifying power, which exhibited the object with the most perfect brightness and distinctness. Each instrument was devoted to one or two objects ; hence he had always some hundreds by him.

The three first compound microscopes that attract our notice are those of Dr. Hooke, Eustachio Divini, and Philip Bonnani. Dr. Hooke gives an account of his in the preface to his *Micrographia*, published in the year 1667 : it was about three inches in diameter, seven inches long, and furnished with four draw-out tubes, by which it might be lengthened as occasion required ; it had three glasses—a small object-glass, a middle glass, and a deep eye-glass. Dr. Hooke used all the glasses when he wanted to take in a considerable part of an object at once, as by the middle glass a number of radiating pencils were conveyed to the eye which would otherwise have been lost ; but when he wanted to examine with accuracy the small parts of any substance, he took out the middle glass, and only made use of the eye and object lenses ; for the fewer the refractions are, the clearer and brighter the object appears.

Dr. Hooke also gave us the first and most simple method of finding how much any compound microscope magnifies an object. He placed an accurate scale, divided into very minute parts of an inch, on the stage of the microscope ; adjusted the microscope till the divisions appeared distinct ; and then observed with the other eye how many divisions of a rule similarly divided and laid on the stage were included in one of the magnified divisions ; “for if one division, as seen with one eye through the microscope, extends to thirty divisions on the rule, which is seen by the naked eye, it is evident that the diameter of the object is increased or magnified thirty times.”

An account of Eustachio Divini's microscope was read at the Royal Society in 1668. “It consisted of an object-lens, a middle glass, and two eye-glasses, which were plano-convex lenses, and were placed so that they touched each other in the centre of their convex surfaces ;

by which means the glass takes in more of an object, the field is larger, the extremities of it less curved, and the magnifying power greater. The tube in which the glasses were enclosed was as large as a man's leg, and the eye-glasses as broad as the palm of the hand. It had four several lengths: when shut up was 16 inches long, and magnified the diameter of an object 41 times, at the second length 90, at the third length 111, and at the fourth length 143 times." It does not appear that Divini varied the object-glasses.

Philip Bonnani published an account of his two microscopes in 1698. Both were compound. The first was similar to that which Mr. Martin published as new, in his *Micrographia Nova*, in 1712. His second was like the former, composed of three glasses, one for the eye, a middle glass, and an object lens; they were mounted in a cylindrical tube, which was placed in a horizontal position; behind the stage was a small tube with a convex lens at each end; beyond this was a lamp; the whole capable of various adjustments, and regulated by a pinion and rack. The small tube was used to condense the light on to the object, and spread it uniformly over, according to its nature, and the magnifying power that was used.

A short time before this, Sir Isaac Newton having discovered his celebrated theory of light and colours, was led to improve the telescope; and in 1672 he is said to have applied his principles most successfully to the construction of a compound reflecting microscope. He also pointed out the proper mode of illuminating objects by artificial light, as he describes it, "of any convenient colour not too much compounded, *mono-chromatic*." We find other two plans of this kind; the first that of Dr. Robert Barker, and the second that of Dr. Smith. In the latter there were two reflecting mirrors, one concave, and the other convex: the image was viewed by a lens. This microscope, though far from being executed in the best manner, performed, says Dr. Smith, very well, so that he did not doubt it would have excelled others, had it been properly finished.

In 1738, Lieberkuhn's invention of the solar microscope was communicated to the public. The vast magnifying power, obtained by this instrument, the colossal grandeur with which it exhibited the "minutiae of nature," the pleasure which arose from being able to display the same object to a number of observers at the same time, by affording a new source of rational amusement, increased the number of microscopic observers, who were further stimulated to the same pursuits by Mr. Trembley's famous discovery of the polyp. The discovery of the wonderful properties of this little animal, together with the works of

Mr. Trembley, Mr. Baker, and Mr. Adams, combined to spread the reputation of the instrument.

In 1742, Mr. Henry Baker, F.R.S., published an admirable treatise on the microscope. He also read several papers before the Royal Society on the subject of his microscopic discoveries. In our title-page we have represented an elegant scroll "pocket microscope with a speculum," described by him as a new invention.

In 1770, Dr. Hill published a treatise, in which he endeavours by means of the microscope to explain the construction of timber, and to show the number, the nature, and office of its several parts, their various arrangements and proportions in the different kinds; and he points out a way of judging, from the structure of trees, the uses they will best serve in the affairs of life.

M. L. F. Delabarre published an account of his microscope in 1777. It does not appear that it was superior in any respect to those that were then made in England. It was inferior to some; for those made by Mr. Adams, in 1771, possessed all the advantages of Delabarre's in a higher degree, except that of changing the eye-glasses.

In 1774, Mr. George Adams, the son of the above, improved his father's invention, and rendered it useful for viewing opaque as well as transparent objects. This instrument, made and described by him,* continued in use up to the time of the invention of the achromatic improvement, proposed and made in 1815 for Amici, who subsequently gave so much time to the investigation of polarised light, and the adaptation of a polarising apparatus to the microscope.

In the year 1816, Fraunhofer, a celebrated optician of Munich, constructed object-glasses for the microscope of a single achromatic lens, in which the two glasses, although in juxtaposition, were not cemented together: these glasses were very thick, and of long focus. Although such considerable improvements had taken place in the making of achromatic object-glasses since their first discovery by Euler in 1776, we find, even at so late a period as 1821, M. Biot writing, "that opticians regarded as impossible the construction of a good achromatic microscope." Dr. Wollaston also was of the same opinion, "that the compound instrument would never rival the single."

In 1823, experiments were commenced in France by M. Selligues, which were followed up by Fraunhofer in Munich, by Amici in Modena, by M. Chevalier in Paris, and by the late Dr. Goring and Mr. Tulley in London. To M. Selligues we are indebted for the first plan

* Microscopical Essays, 1787.

of making an object-glass composed of four achromatic compound lenses, each consisting of two lenses. The focal length of each object-glass was eighteen lines, its diameter six lines, and its thickness in the centre six lines, the aperture only one line. They could be used combined or separated.

A microscope constructed on this principle, by M. Chevalier, was presented by M. Selligues to the *Académie des Sciences* on the 5th of April, 1824. In the same year, and without a knowledge of what had been done on the Continent, the late Mr. Tulley, at the suggestion of Dr. Goring, constructed an achromatic object-glass for a compound microscope of nine-tenths of an inch focal length, composed of three lenses, and transmitting a pencil of eighteen degrees; this was the first that had been made in England.

It was at one time hoped, as precious stones are more refractive than glass, and as the increased refractive power is unaccompanied by a corresponding increase in chromatic dispersion, that they would furnish valuable materials for lenses, inasmuch as the refractions would be accomplished by shallower curves, and consequently with diminished spherical aberration. But these hopes were disappointed. Every thing that ingenuity and perseverance could accomplish was tried by Mr. Varley and Mr. Pritchard, under the patronage of Dr. Goring. It appeared, however, that the great reflective power, the doubly-refracting property, the colour, and the heterogeneous structure of the jewels which were tried, much more than counterbalanced the benefits arising from their greater refractive powers, and left no doubt of the superiority of skilfully-made glass doublets and triplets. The idea is now, in fact, abandoned; and the same remark is applicable to the attempts at constructing fluid lenses, and to the projects for giving to glass other than spherical surfaces; none of which have come into extensive use.

Mr. Lister, who was engaged with Mr. Tulley in the perfecting the achromatic object-glass, finding that none of the microscope-stands hitherto made were sufficiently steady for the use of high powers, directed his attention to the improvement of this part of the instrument; and in order to carry out his views, he employed Mr. James Smith, now one of our first opticians, to execute a stand from his own drawings, which he completed early in 1826.

In March 1825 M. Chevalier presented to the Society for the Encouragement of the Sciences an achromatic lens of four lines focus, two lines in diameter, and one line in thickness in the centre. This lens was greatly superior to the one before noticed, which had been made by him for M. Selligues.

In 1826, Professor Amici, who from the year 1815 to 1824 had abandoned his experiments on the achromatic object-glass, was induced, after the report of Fresnel to the Academy of Science, to resume them; and in 1827 he brought to this country and to Paris a horizontal microscope, in which the object-glass was composed of three lenses superposed, each having a focus of six lines and a large aperture. This microscope had also extra eye-pieces, by which the magnifying power could be increased. A microscope constructed on Amici's plan by Chevalier, during the stay of that physician in Paris, was exhibited at the Louvre, and a silver medal was awarded to its maker.

"While these practical investigations were in progress," says Mr. Ross, "the subject of achromatism engaged the attention of some of the most profound mathematicians in England. Sir John Herschel, Professors Airy and Barlow, Mr. Coddington, and others, contributed largely to the theoretical examination of the subject; and though the results of their labours were not immediately applicable to the microscope, they essentially promoted its improvement."

Mr. Jackson Lister, in 1829, succeeded in forming a combination of lenses upon the theory propounded by these gentlemen, and effected one of the greatest improvements in the manufacture of object-glasses, by joining together a plano-concave flint lens and a convex, by means of a transparent cement, Canada balsam. This is desirable to be taken as a basis for the microscopic object-glass: it diminishes very nearly half the loss of light from reflection, which is considerable at the numerous surfaces of a combination; the clearness of the field and brightness of the picture is evidently increased by doing this; and it prevents any dewiness or vegetation from forming on the inner surfaces. Since this time, Mr. Ross has been constantly employed in bringing the manufacture of object-glasses to their greatest perfection, and at length they have attained to their present improved manufacture. Having applied Mr. Lister's principles with a degree of success never anticipated, so perfect were the corrections given to the achromatic object-glass, so completely were the errors of sphericity and dispersion balanced or destroyed, that the circumstance of covering the object with a plate of the thinnest glass or talc disturbed the corrections, if they had been adapted to an uncovered object, and rendered an object-glass which was perfect under one condition sensibly defective under the other. Here was another and unexpected difficulty to be overcome, but which was finally accomplished; for in a communication made to the Society of Arts in 1837, Mr. Ross stated, that by separating the anterior lens in the combination from the other two, he

had been completely successful. The construction of this object-glass will be illustrated and explained in a future chapter.

The rapid progress of improvement in the manufacture of the achromatic compound microscope in this country has been greatly furthered by the spirit of liberality evinced by the late Dr. Goring, Mr. R. H. Solly, and Mr. Bowerbank. To the patronage of the former we owe the construction, by Tulley, of the first triplet achromatic object-glass, of the diamond lens, and of the improved reflecting instrument of Amici by Cuthbert.

To Mr. Solly is due the credit of bringing before the public the improved microscope of Mr. Valentine, the excellent workmanship of Mr. Ross; and by his intimate connection with the Society of Arts, he has been the means of making its *Transactions*, since 1831, the vehicle through which nearly all the improvements in the construction of telescopes and microscopes have been made known to the world. The achromatic microscopes now manufactured by our London makers, Mr. Ross, Messrs. Powell and Lealand, and Messrs. Smith and Beck, are unequalled in any part of the world. This opinion is confirmed by the reports of the juries on the Exhibition of Works of Industry of all Nations, 1851; at that time the instruments exhibited by the above makers by far excelled those of all other countries. See Juries' Reports for much interesting matter on this subject; article "*Microscope*," *Penny Cyclopædia*, by Mr. Ross; *Cyclopædia of Anatomy and Physiology*, by Dr. Carpenter; *Practical Treatise on the Microscope*, by Professor Quekett; Brewster's *Treatise on the Microscope*; Dujardin's *Observateur*; Maudl, *Traité pratique du Microscope*; Dr. Robin, *Du Microscope*, &c.

CHAPTER II.

MECHANICAL AND OPTICAL PRINCIPLES INVOLVED IN THE CONSTRUCTION OF THE MICROSCOPE—LENSES—MODE OF ESTIMATING THEIR POWER, ETC.—ACHROMATIC LENSES—MAGNIFYING POWER—WOLLASTON'S DOUBLET—CODDINGTON'S LENS—ROSS'S SIMPLE AND COMPOUND MICROSCOPES—MICROMETERS, ETC.

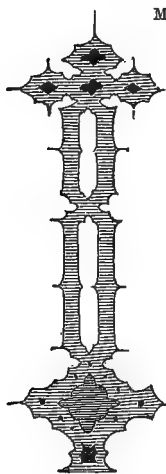

IN the construction of the modern microscope optical and mechanical principles of some importance are involved. These principles we now proceed to notice, together with the more recent improvements effected in the instrument generally.

The microscope depends for its utility and operation upon concave and convex lenses, and the course of the rays of light passing through them. Lenses are usually defined as pieces of glass, or other transparent substances, having their two surfaces so formed that the rays of light, in passing through them, have their direction changed, and are made to converge or diverge from their original parallelism, or to become parallel after converging or diverging. When a ray of light passes in an oblique direction from one transparent medium to another of a different density, the direction of the ray is changed both on entering and leaving; this influence is the result of the well-known law of *refraction*,—that a ray of light passing from a *rare* into a *dense* medium is refracted towards the perpendicular, and *vice versa*.

Dr. Arnott remarks: "But for this fact, which to many persons might at first appear a subject of regret, as preventing the distinct vision of objects through all transparent media, light could have been of little utility to man: There could have been neither lenses, as now; nor any optical instruments, as telescopes and microscopes, of which lenses

form a part ; nor even the eye itself." Rays of light falling perpendicularly upon a surface of glass or other transparent substance, pass through without being bent from the original line of their direction. Thus, if a ray pass from k perpendicularly to the surface of the piece of

glass at e (fig. 3), it will go on to h in the right line $keogh$. But if the same ray be directed to the surface e obliquely, as from a , instead of passing through in a direct line to b in the direction aeb , it will be refracted to d , in a direction approaching nearer to the perpendicular line kh . The ray ae is termed the ray of incidence, or

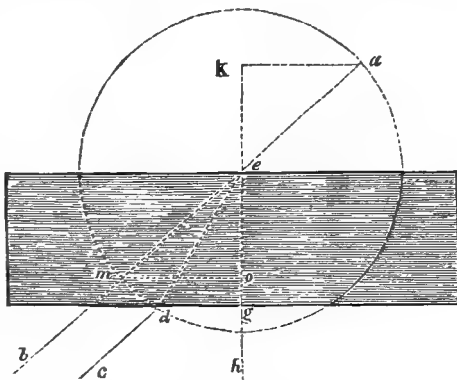

fig. 3.

the incident ray ; and the angle $ae k$ which it makes with the perpendicular kh is called the angle of incidence. That part of the ray from e to d passing through the transparent medium is called the ray of refraction, or the refracted ray ; and the angle deg which it makes with the perpendicular is called the angle of refraction. The ray projected from a to e and refracted to d , in passing out of the transparent medium as at d , is as much bent from the line of the refracted ray ed as that was from the line of the original ray aeb ; the ray then passes from d to c , parallel to the line of the original ray aeb . It follows, then, that any ray passing through a transparent medium, whose two surfaces, the one at which the ray enters, and the one at which it passes out, are parallel planes, is first refracted from its original course ; but in passing out is bent into a line parallel to, and running in the same direction as the original line, the only difference being, that its course at this stage is shifted a little to one side of that of the original. If from the centre e a circle be described with any radius, as de , the arc gm measures the angle of incidence gem , and the arc gd the angle of refraction ged . A line mo drawn from the point m perpendicular to kh is called the sine of the angle of incidence, and the line dg the sine of the angle of refraction. From the conclusions drawn from the principles of geometry, it has been found, that in any particular transparent substance the sine of the angle of incidence mo has always the same ratio to the sine dg of the

angle of refraction, no matter what be the degree of obliquity with which the ray of incidence ae is projected to the surface of the transparent medium. If the ray of incidence passes from air obliquely into water, the sine of incidence is to that of refraction as 4 to 3; if it passes from air into glass, the proportion is as 3 to 2; and if from air into diamond, it is as 5 to 2.

By the help of glasses of certain forms, we unite in the same sensible point a great number of rays proceeding from one point of an object; and as each ray carries with it the image of the point from whence it proceeded, and all the rays united must form an image of the object from whence they were emitted, this image is higher in proportion as there are more rays united, and more distinct in proportion as the order in which they proceeded is better preserved in their union. The point at which the object must be placed is called the *focus* of the lens; and the distance from the middle of the lens to the focus is called the *focal length*, or distance. In every lens the right line perpendicular to the two surfaces is called the *axis* of the lens, and is seen in the annexed figure; the point where the axis cuts the surface is called the *vertex* of the lens; the middle point between them the *centre*; and the distance between them the *diameter*.

Fig. 4 is intended to represent the different forms of lenses in use:

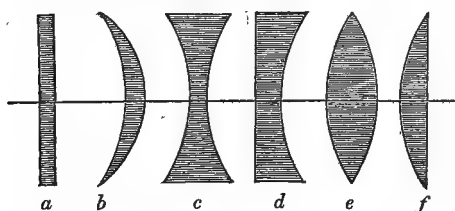

fig. 4.

a is a plane glass of equal thickness throughout; b a meniscus, concave on one side, convex on the other; c , a double-concave; d , a plano-concave; e , a double-convex; f , a plano-convex.

Refraction of Light through Lenses, and Method of tracing the Progress of Rays.

When a ray of light enters the concave surface of a dense medium, or quits a similar surface and enters the convex surface of a rare medium, the method of tracing its progress is shown in fig. 5, where $m'n$ is a dense medium of glass with two concave surfaces, forming a thick concave lens. Let $c'c$ be the centres of the two surfaces lying in the axis $c'c$, and $h'r, h''r'$ parallel rays incident on the first surface. As cr is per-

pendicular to the surface at r , hrc will be the angle of incidence; and if a circle is described with a radius rh , hm will be the sine of the angle: the same happens as was shown occurring with parallel surfaces in fig. 3. From a scale on which hm is 1.500 take in the compasses 1, and find some point, b , in the circle, where when one foot of the compasses is placed, the other will fall only on one point, n , of the perpendicular, rc ; the line rb , drawn through this point, will be the re-

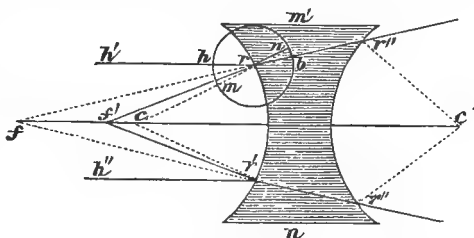

fig. 5.

fracted ray. By continuing this ray, br , backwards, it will be found that it meets the axis at f . In like manner it will be seen that the ray $h'r'$ will be refracted in the direction of $r'r''$, as if it also diverged from f . Hence f will be the focus of the parallel rays refracted by a single concave surface, and may be found by the following rule: Divide the index of refraction by its excess above unity, and the quotient will be the principal focal distance $f'c$, the radius of the surface. If, by a similar method, we find the refracted ray rc at the emergence of the ray rb from the second surface rr' of the lens, and continue it backwards, it will be found to meet the axis at f' ; so that the divergent rays rr'' , $r'r''$ are rendered still more divergent by the second surface, and c will be the focus of the lens $m'n$.

Rays of light falling upon a convex lens parallel to its axis are refracted in precisely the same manner as those falling on a sphere; and the refracted ray may be found in the very same way. But as a sphere has an axis in every direction, every incident ray must be parallel to an axis of it; whereas in a lens, which has only one axis, many of the incident rays must be oblique to that axis. In every case, whether of spheres or of lenses, all the rays that pass along the axis suffer no refraction at all, because the axis is always perpendicular to the refracting surfaces.

When parallel rays, rl , $r'c$, $r''l'$, fig. 6, fall upon a double-convex lens, ll' , parallel to its axis, $r'f'$, the ray $r'c$, which coincides with the axis, will pass through without suffering any refraction; but the other rays, rl , $r''l'$, will be refracted at each of the surfaces of the lens; and the refracted rays corresponding to them, namely lf' , $l'f''$, will be found, by the method already given, to meet at some point, f' , in the axis.

But when the rays are oblique to the axis, as sl , $s'l$, tl , $t'l$, the rays $s'c$, $t'c$, which pass through the centre, c , of the lens, will suffer refraction at each surface; but as the two refractions are equal and in opposite directions, the finally refracted rays cf , cf'' will pass from

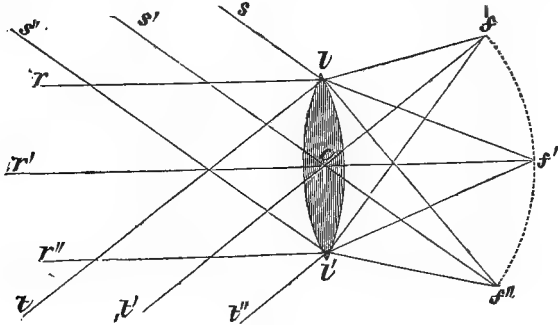

fig. 6.

$s'c$, $t'c$; and it will be found that sl , $s'l$ will be refracted to a common point, f'' , in the direction of the central ray $s'f''$, and tl , $t'l$ to the point f . When the lens is of glass and equally convex, the focal distance will be equal to the radius. As each ray carries with it the image of the object from whence it proceeded, it follows, that if those rays, after intersecting each other, and having formed an image at their intersection, are again united by refraction or reflection, they will form a new image, and that repeatedly, so long as their order is not disturbed. It follows also, that when the progress of the luminous ray is under consideration, we may look on the image as the object, and the object as the image; and consider the second image, as if it had been produced by the first, as an object, and so on. This is one of the principles involved in the adaptation of these lenses to magnifying objects. It has been shown in fig 6, that if the point of light be situated above the line of the axis, the focus will then be below it, and *vice versa*; but the surface of every luminous body may be regarded as comprehending an infinite number of such points, from all of which a pencil of light-rays proceeds, and is refracted according to the general law; so that a perfect but inverted image or picture of the object is formed upon any surface placed in the focus, and adapted to receive the rays.

And if the object be placed at twice the distance of the principal focus, the image being formed at an equal distance on the other side

of the lens, will be of the same dimensions with the object, as in fig. 7 ;

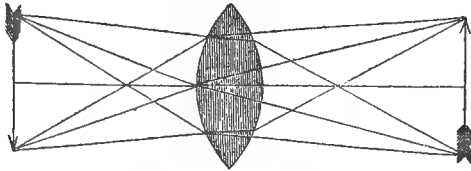

fig. 7.

but if the object be placed nearer to the lens, the image will be farther from it and of larger dimensions, as in fig. 8 ; and on the other hand,

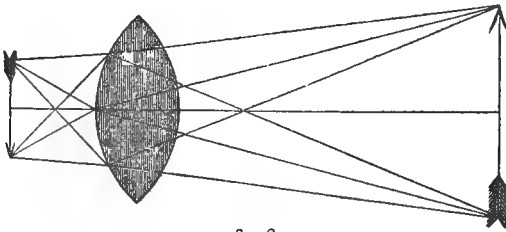

fig. 8.

if the object be farther from the lens, the image will be nearer to it and smaller than itself. But it is to be observed, that the larger the image is in proportion to the object, the less bright it will be, because the same amount of light has to be spread over a greater surface ; whilst a smaller image will be much more brilliant.

Spherical Aberration of Lenses.

We have many imperfections to contend with in our optical arrangements and combinations ; one of which results from the *spherical aberration* of the rays passing through lenses whose curvatures are equal over their whole surfaces. If the course of the rays be observed, it will be seen that they *do not all meet exactly* in the foci already stated, but that the focus of the rays which have passed through the circumferential portion of the lens is much closer to it than that of the rays which are nearer the line of its axis. This is shown in fig. 9 : *a b*, the rays, are seen falling on the circumference and coming to a focus, *f* ; *a' b'*, *a'' b''* are rays falling nearer the centre, and coming to a more distant focus, *f'* ; so that if a screen be held at *c d*, the rays which have passed through the central portion of the lens will be stopped at *f* before they come to a focus, or they will come to it in a state of diverg-

ence at $c d$: in either case the image will have a certain degree of indistinctness; and the difference between the focal points of their circumferential and central rays is termed the *spherical aberration*. It

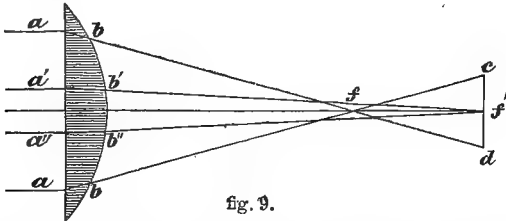

fig. 9.

therefore becomes apparent that, to produce the desired effect, the curvature of the lens is required to be increased around the centre, so as to bring the rays which pass through it more speedily to a focus; and to be diminished towards the circumference, so as to throw the focus of the rays influenced by it to a greater distance. This condition is in a measure fulfilled in the meniscus form of lens, which is shown to be the segment of an ellipsoid instead of a sphere.

But the ellipse and the hyperbola are curves of this kind, in which the curvature diminishes from the central ray, or axis, to the circumference b ; and mathematicians have shown how spherical aberration may be entirely removed by lenses whose sections are ellipses or hyperbolas. This curious discovery we owe to Descartes.

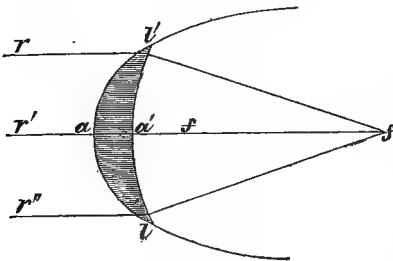

fig. 10.

If al, al' for example, fig. 10, be part of an ellipse whose greater axis is to the distance between its foci ff as the index of refraction is to unity, then parallel rays r, r', r'' incident upon the elliptical surface lal' , will be refracted by the single action of that surface into lines which would meet exactly in the farther

focus f , if there were no second surface intervening between lal' and f . But as every useful lens must have two surfaces, we have only to describe a circle $la'l$ round f as a centre, for the second surface of the lens $l'l$.

As all the rays refracted at the surface lal' converge accurately to f , and as the circular surface $la'l$ is perpendicular to every one of the refracted rays, all these rays will go on to f without suffering any

refraction at the circular surface. Hence it should follow, that a meniscus whose concave surface is part of an ellipsoid, and whose convex surface is part of any spherical surface whose centre is in the farther focus, will have no spherical aberration, and will refract parallel rays incident on its convex surface to the farther focus.

In like manner, a concavo-convex lens, fig. 11, ll' , whose concave surface $la'l'$ is a circle described round the farther focus of the ellipse, will cause parallel rays $bl, b'l'$ to diverge in directions $lr, l'r''$, which, when continued backwards, will meet exactly in the focus f , which will be its virtual focus.

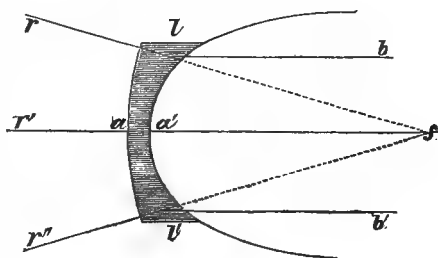

fig. 11.

If a plano-convex lens, fig. 12, has its convex surface $la'l'$ part of a hyperboloid, formed by the revolution of a hyperbola whose greater axis is to the distance between the foci as unity is to the index of refraction, then parallel rays $r'l, r''l'$ falling perpendicularly in the plane surface will be refracted without aberration to the further focus of the hyperboloid. The same property belongs to a plano-concave lens having a similar hyperbolic surface, and receiving parallel rays in its plane surface.*

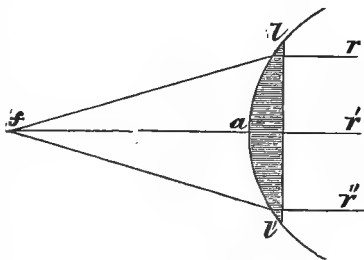

fig. 12.

When the convex side of a plano-convex lens is exposed to parallel rays, the distance of the focus from the plane side will be equal to twice the radius of its convex surface diminished by two-thirds of the thickness of the lens; but when the plane is exposed to parallel rays, the distance of the focus from the convex side will be equal to twice the radius.

A meniscus with spherical surfaces, fig. 13, has the property of refracting all converging rays to its focus, if its first surface is con-

* It should be borne in mind, that in none of these lenses would the object be correctly seen in focus, except at the one point known as the mathematical or geometrical axis of the lens.

vex, provided the distance of the point of convergence or divergence from the centre of the first surface is to the radius of the first surface

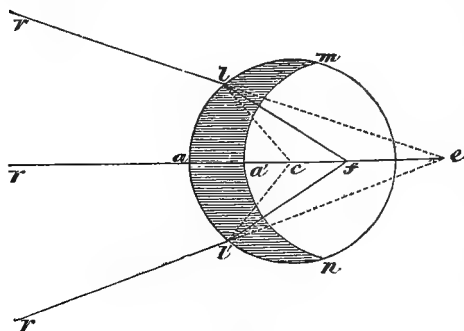

fig. 13.

as the index of refraction is to unity. Thus, if ml ln is a meniscus, and rl , rl' rays converging to the point e , whose distance ec from the centre of the first surface lal' of the meniscus is to the radius ca , or cl , as the index of refraction is to unity, that is as 1.500 to 1 in glass; then if f is the focus of the first surface, describe, with any radius

less than fa , a circle $ma'n$ for the second surface of the lens. Now it will be found by projection, that the rays rl , rl' , whether near the axis ae or remote from it, will be refracted accurately to the focus f ; and as all these rays fall perpendicularly on the second surface mn , they will still pass on, without refraction, to the focus f . In like manner, it is obvious that rays fl , fl' , diverging from f will be refracted into rl , rl' , which diverge accurately from the virtual focus.*

There are certain mechanical difficulties in the way of such lenses as these, but which have to some extent been surmounted by diminishing the working aperture with *stops*, for correcting their aberration. This is still better effected, or even got rid of altogether, by using combinations of lenses, so disposed that their opposite aberrations shall correct each other, whilst magnifying power is gained. For it is easily seen that, as the aberration of a concave lens is just the opposite of that of a convex lens, the aberration of a convex lens placed in its most favourable position may be corrected by a concave lens of much less power in its most favourable position. This is the principle of a combination proposed by Sir John F. W. Herschel, fig. 14, consisting of a plano-convex lens and a meniscus; and a doublet of this kind will be found extremely useful and available for microscopic purposes: it affords a large field,



fig. 14.

like the Coddington lens. Another and serious difficulty arises to the optician in the unequal refrangibility of the different coloured rays which together make up white light, so that they are not

* Brewster's Optics.

all brought to the same focus even by a lens free from spherical aberration. It is, indeed, this difference in their refrangibility which causes their complete separation by the prism into a spectrum. This is termed *chromatic aberration*, and will be best explained by a reference to fig. 15: ab are rays of white light refracted by a convex lens;

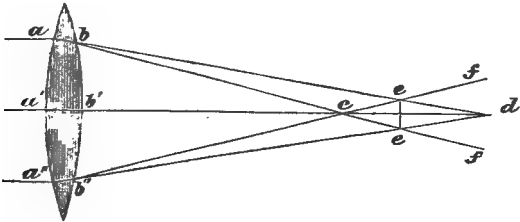

fig. 15.

c the focus of the violet rays, which then cross and diverge towards ef ; d is the focus of the red rays, which are crossed at the points ee' by the violet rays; the middle point, therefore, of this line is the mean focus, or focus of least aberration.

The correction of chromatic aberration has been accomplished by bringing into use the different dispersive powers of various materials which bear no relation to their simple refracting power,—in other words, by a combination of flint and crown glass; and by a most curious series of experiments the dispersive power of flint-glass was found to be so much greater than that of crown-glass, that if the lens aa (fig. 16) be made of *crown-glass*, whose index of refraction is 1.519, and dispersive power 0.036, and the lens bb of *flint-glass*, whose index of refraction is 1.589, and dispersive power 0.0393, and if the focal length of the convex crown-glass lens is made $4\frac{1}{2}$ inches, and that of the concave flint-glass lens $7\frac{2}{3}$ inches, they will form a lens with a focal length of ten inches, and will bring rays of light, cc' , to a single focus, d , free of colour.

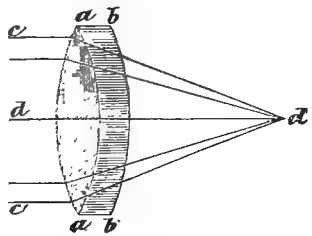

fig. 16.

Such a lens is called an *achromatic lens*; and when used in combination with other glasses in constructing the microscope, it is termed an *achromatic microscope*.

To assist us in gaining a clearer notion of the mode in which a single lens serves to magnify minute objects, it is necessary to take a

passing glance at the ordinary phenomena of vision. The human eye is so constituted, that it can only have distinct vision when the rays falling upon it are parallel or slightly divergent; because the retina, on which the image impinges, requires the intervention of the crystalline lens to bring the rays to an accurate focus upon its surface. The limit of distinct vision is generally estimated at from six to ten inches; objects viewed nearer, to most persons, become indistinct, although they may be larger. The apparent size of an object is, indeed, the angle it subtends to the eye, or the angle formed by two lines drawn from the centre of the eye to the extremity of the object. This

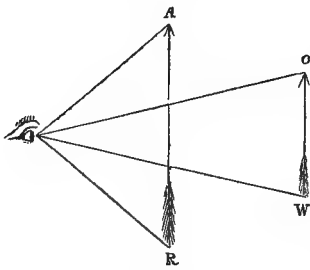

fig. 17.

will be understood upon reference to fig. 17. The lines drawn from the eye to A and R form an angle, which, when the distance is small, is nearly twice as great as the angle from the eye to O W, formed by lines drawn at twice the distance. The arrow at A R will therefore appear nearly twice as long as O W, being seen under twice the angle; and in the same proportion for any greater or lesser difference in distance. This, then, is called the angle of vision, or the visual angle. Now the utility of a

convex lens interposed between a near object and the eye consists in its reducing the divergence of the rays forming the several pencils issuing from it; so that they enter the eye in a state of moderate diver-

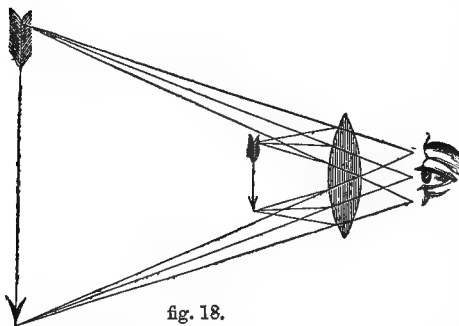

fig. 18.

gence, as if they had issued from an object beyond the nearest limit of distinct vision; and a well-defined image is consequently formed upon the retina. In fig. 18 a double-convex lens is placed before the eye, near which is a small arrow, to represent the object under examination; and the cones

drawn from it are portions of the rays of light diverging from those points and falling upon the lens. These rays, if permitted to fall

at once upon the pupil, would be too divergent to allow of their being brought to a focus upon the retina by the optical arrangements of the eye. But being first passed through the lens, they are bent into nearly parallel lines, or into lines diverging from some points within the limits of distinct vision. Thus altered, the eye receives them precisely as if they had emanated directly from a larger arrow placed at ten inches from the eye. The difference between the real and the imaginary arrow is called the magnifying power of the lens. Fig 19 will perhaps convey a clearer idea of the increase of the angle of vision by interposing a convex lens :

without this lens placed at $f' g'$, the eye would see the dart at $b' c'$ under the angle formed by the eye and $b' c'$; but the rays $b' f'$ and $c' g'$ from the extremities of the dart, in passing through the lens, are refracted to the eye in the direction of f and g , which causes the dart to be seen under the much larger angle formed with the eye

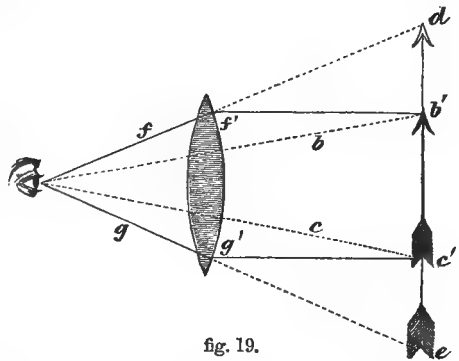

fig. 19.

and $d e$; and it therefore appears so much magnified as to extend from d to e . The object, when thus seen, appears to be magnified nearly in the proportion which the focal distance of the lens bears to the distance of the object when viewed by the unassisted eye; and is entirely owing to the object being distinctly viewed so much nearer to the eye than it could be without the lens.* With these preliminary remarks as to the medium by which microscopic power is obtained, we shall proceed to apply them to the construction of a perfect instrument. A microscope, as we have before explained, may be either a *single* or *simple*, or a *compound* instrument. The *simple* microscope may consist of one, as seen in fig. 18, or of two or three lenses; but these latter are so arranged as to have the effect only of a single lens. In the compound microscope, not less than two lenses must be employed: one to form the inverted image of the object, which being the nearest to the object, is called the *object-glass*; and the other to magnify this image, and from being next the eye of the observer, called the *eye-glass*. Both these

* "The Magnifying Power of Short Spaces" has received an able elucidation from John Gorham, Esq. M.B.C.S. *Journal of Microscopical Society*, October 1854.

may be formed out of a combination of lenses, as will be hereafter seen.

We have hitherto considered a lens only in reference to its enlargement of the object, or the increase of the angle under which the object is seen. A further and equally important consideration is that of the number of rays or quantity of light by which every point of the object is rendered visible; but it at the same time becomes as important that we do not sacrifice *definition* to this end. Much may be accomplished, as we have before pointed out, by the combination of two or more lenses instead of one, thus reducing the angles of incidence and refraction.

The first satisfactory arrangement for this purpose was the invention of the celebrated Dr. Wollaston. His doublet (fig. 20) consisted of

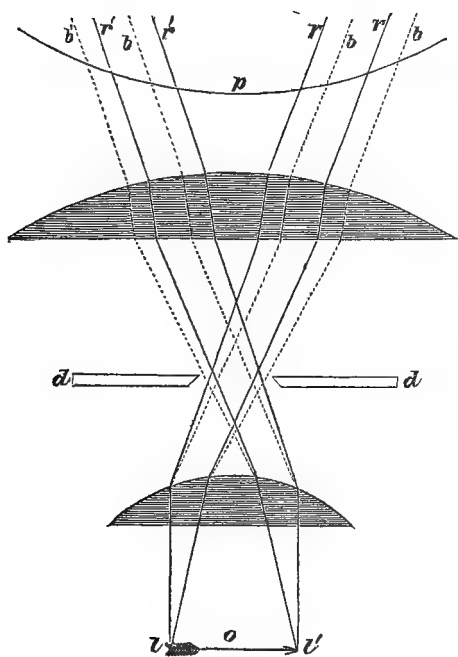

fig. 20.

two plano-convex lenses having their focal lengths in the proportion of one to three, or nearly so, and placed at a distance which can be ascertained best by actual experiment. Their plane sides are placed towards the object, and the lens of shortest focal length next the object.

It appears that Dr. Wollaston was led to this invention by considering that the achromatic Huyghenian eye-piece, which will be presently described, would, if reversed, possess similar good properties as a simple microscope. But it will be evident, when the eye-piece is understood, that the circumstances which render it achromatic are very imperfectly applicable to the simple microscope, and that the doublet, without a nice adjustment of the stop, would be valueless. Dr. Wollaston makes no

able to the simple microscope, and that the adjustment of the stop, would be valueless. Dr. Wollaston makes no

allusion to a stop, nor is it certain that he contemplated its introduction; although his illness, which terminated fatally soon after the presentation of his paper to the Royal Society, may account for the omission.

The nature of the corrections which take place in the doublet is explained in the annexed diagram, where lol' is the object, p a portion of the pupil, and dd the stop, or limiting aperture.

Now it will be observed that each of the pencils of light from the extremities ll' of the object is rendered excentric by the stop; consequently each passes through the two lenses on opposite sides of their common axis op ; thus each becomes affected by opposite errors, which to some extent balance and correct each other. To take the pencil l , for instance, which enters the eye at rb , rb' : it is bent to the right at the first lens, and to the left at the second; and as each bending alters the direction of the blue rays more than the red, and moreover as the blue rays fall nearer the margin of the second lens, where the refraction, being more powerful than near the centre, compensates in some degree for the greater focal length of the second lens, the blue rays will emerge very nearly parallel, and of consequence colourless to the eye. At the same time the spherical aberration has been diminished by the circumstance that the side of the pencil which passes one lens nearest the axis passes the other nearest the margin.

This explanation applies only to the pencils near the extremities of the object. The central pencils, it is obvious, would pass both lenses symmetrically, the same portions of light occupying nearly the same relative places on both lenses. The blue light would enter the second lens nearer to its axis than the red; and being thus less refracted than the red by the second lens, a small amount of compensation would take place, quite different in principle, and inferior in degree, to that which is produced in the excentric pencils.

In the intermediate spaces the corrections are still more imperfect and uncertain; and this explains the cause of the aberrations which must of necessity exist even in the best-made doublet. It is, however, infinitely superior to a single lens, and will transmit a pencil of an angle of from 35° to 50° without any very sensible errors. It exhibits, therefore, many of the usual test-objects in a very beautiful manner.

The next step in the improvement of the simple microscope bears more relation to the eye-piece; this was effected by Mr. Holland: it consists in substituting two lenses for the first in the doublet, and retaining the stop between them and the third. The first bending being thus effected by two lenses instead of one, is accompanied by smaller aberrations, which are, therefore, more completely balanced

or corrected at the second bending, in the opposite direction, by the third lens.

Every increase in the number of lenses is attended with one drawback, from the circumstance that a certain portion of light is lost by reflection and absorption each time that the ray enters a new medium.

The combination of three lenses approaches so very close to the object under observation as, indeed, to prevent the use of more than three; and this constitutes a limit to the improvement of the simple microscope,—for it is called a simple microscope, although consisting of three lenses.

Before we proceed to describe the simple microscope and its appendages, it will be well to explain such other points in reference to the form and materials of lenses as are most likely to be interesting.

A very useful form of lens was proposed by Dr. Wollaston, and called by him the Periscopic lens. It consisted of two hemispherical lenses cemented together by their plane faces, having a stop between them to limit the aperture. A similar proposal was made by Mr. Coddington, who, however, executed the project in a better manner, by cutting a groove in a whole sphere, and filling the groove with opaque matter. His lens, which is the well-known Coddington lens, is shown at fig. 21: it gives a large field of view, which is equally good in all directions, as it is evident that the pencils ab and ba pass through under pre-

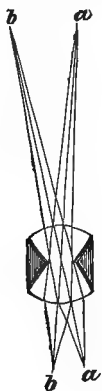

fig. 21.



fig. 22.

cisely the same circumstances. Its spherical form has the further advantage of rendering the position in which it is held of comparatively little consequence. It is therefore very convenient as a hand magnifier; but its definition is, of course, not so good as that of a well-made

doublet or achromatic lens. It is generally set in a folding case, as represented in the figure, and so contrived that it is admirably adapted for the waistcoat-pocket; which, together with the small *holder*, fig. 22, for securing small objects and holding them during examination, are all that is required for a *field instrument* during a day's ramble. The useful little holder may be purchased in a case of Mr. Weedon, 41 Hart-street, Bloomsbury. The Stanhope lens is similarly constructed, although not so good and convenient as the former, and is but seldom to be purchased properly made.

When the magnifying power of a lens is considerable, or when its focal length is short, and its proper distance from the object equally short, it then becomes necessary to be placed at a proper distance with great precision; it cannot therefore be held with sufficient accuracy and steadiness by the unassisted hand, but must be mounted in a frame, having a rack or screw to move it towards or from another frame or stage which holds the object. It is then called a microscope; and it is furnished, according to circumstances, with lenses and mirrors to collect and reflect the light upon the object, with other conveniences.

The best of the kind was that contrived by Mr. Ross: it is repre-

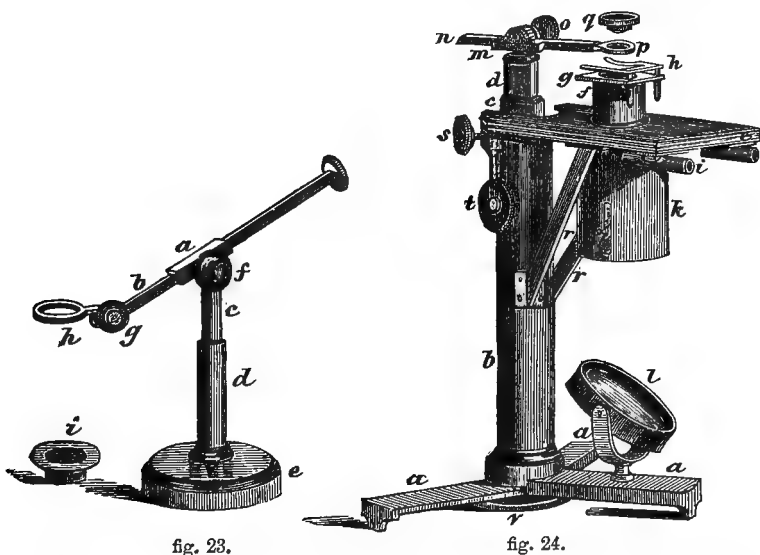

fig. 23.

fig. 24.

sented in fig. 23, and consists of a circular foot *e*, from which rises a short tubular stem *d*, into which slides another short tube *c*, carrying at its top a joint *f*; to this joint is fixed a square tube *a*, through

which a rod b slides; this rod has at one end another but smaller joint g , to which is attached a collar h , for receiving the lens i . By means of the joint at f , the square rod can be moved up or down, so as to bring the lens close to the object; and by the rod sliding through the square tube a , the distance between the stand and the lens may be either increased or diminished: the joint g , at the end of the rod, is for the purpose of allowing the lens to be brought either horizontally or at an angle to the subject to be investigated. By means of the sliding arm the distance between the table and the jointed arm can be increased or diminished. This microscope is provided with lenses of one-inch and half-inch focal length, and is thereby most useful for the examination and dissection of objects. It is readily unscrewed and taken to pieces, and may be packed in a small case for the pocket.

Another highly-useful and more complete *simple microscope* was contrived by Mr. W. Valentine, and made for him by Mr. Ross in 1831. It is thus described by the latter gentleman, and is represented in fig. 24. It is supported on a firm tripod, made of bell-metal, the feet of which, $a a a$, are made to close up for the purpose of packing it in a box. The firm pillar b rises from the tripod, and carries the stage e ; this is further strengthened by the two supports $r r$. From the pillar a triangular bar d , and a triangular tube c , is moved up and down by a screw, having fifty threads in the inch, and turned by a large milled head v , which is situated at the base of the pillar: this is the fine adjustment. The small triangular base d is moved up and down within the triangular bar c , by turning the milled head t , forming the coarse adjustment: this bar carries the lens-holder $m n o p$. The stage e consists of three plates; the lowest one is firmly attached to the pillar, and upon this the other two work. The upper one carries a small elevated stage g , on which the objects are placed; this stage is mounted on a tube f , and has a spring clip h for holding, if necessary, the objects under examination. By means of two screws placed diagonally, one of which is seen at s , this elevated stage can be moved in two directions, at right angles to one another; and thus different parts of objects can be brought successively into the field of view. The arm $n p$, for carrying the lenses, is attached to the triangular bar d by a conical pin, on which it is made to turn horizontally, and the arm itself can be lengthened or shortened by means of the rack and pinion $m o$; hence the lens q can be applied to every part of an object without moving the stage.

The mirror l is fitted into the largest of the three legs, and consists of a concave and plane glass reflector. To the under side of the stage is fitted a Wollaston's condenser k ; and the lens is made to slide up

and down by means of two small handles projecting from the cell in which the lens is set. Two small tubes *i*, with either a condensing lens for opaque objects, or a pair of forceps, may be attached to this side of the stage. The magnifiers are either simple lenses or doublets; or it could be easily converted into a compound microscope by inserting a compound body, supported on a bent arm, in the place of the one carrying the single lenses.

THE COMPOUND MICROSCOPE.

The compound microscope may, as before stated, consist of only two lenses, while a simple microscope has been shown to contain sometimes three. In the triplet for the simple microscope, however, it was explained that the object of the first two lenses was to do what might have been accomplished, though not so well, by one; and the third merely effected certain modifications in the light before it entered the eye. But in the compound microscope the two lenses have totally different functions: the first receives the rays from the object, and bringing them to new foci, forms an image, which the second lens treats as an original object, and magnifies it just as the single microscope magnified the object itself,

Fig. 25 shows the earliest form of the compound microscope, with the magnified image of a fly, as given by Adams, which he describes as consisting of an object-glass, *ln*, and an eye-glass, *fg*; the object, *b' o'*, being placed a little further from the lens than its principal focal distance, the pencil of rays from which converge to a focus, and form an inverted image of the object at *p q*, which image is viewed by the eye placed at *a* through the eye-glass *fg*. The rays remain parallel after passing out until they reach the eye, when they will converge by the refractive powers of this organ, and be collected on the retina. But the image differs from the real object in a very essential particular. The light being emitted from the object in every direction, renders it visible to an eye placed in any

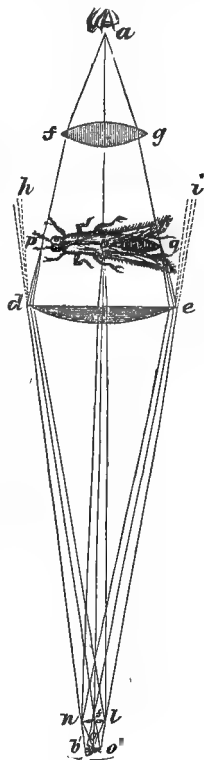

fig. 25.

position ; but the points of the image formed by a lens emitting no more than a small conical body of rays, which it receives from the glass, can be visible only to the eye situate within its range. Thus the pencil of rays emanating from the object at o is converged by the lens to f , cross each other, and diverge towards h , and therefore would never arrive at the lens fg , without the interposition of the plano-convex lens at de , placed at a smaller distance from the object ; and by this means the pencil dn , which would have proceeded to h , is refracted or bent towards the lens fg , having a radial point at pq . The object is magnified upon two accounts : first, because if we view the image with the naked eye, it would appear as much longer than the object as the image is really longer than it, or as the distance fb is greater than the distance from the real object to f ; and secondly, because this picture is again magnified by the eye-glass. The compound microscope, then, consists of an object-lens, ln , by which the image is formed, enlarged, and inverted ; an amplifying lens, de , by which the field of view is enlarged, and is consequently called the *field-glass* ; and an eye-glass or lens, by which the eye is permitted to approach very near, and consequently enabled to view the image under a large angle of apparent magnitude. The two, when combined, are called the eye-piece.

Upon the construction of this microscope Mr. Ross observes : “ Since the power depends on the ratio between the anterior and posterior foci of the object-glass, it is evident that by increasing that ratio any power may be obtained, the same eye-glass being used ; or having determined the first, any further power may be obtained by increasing that of the eye-glass ; and thus, by a pre-arrangement of the relative proportions in which the magnifying power shall be divided between the object-glass and the eye-glass, almost any given distance (within certain limits) between the first and its object may be secured. This is one valuable peculiarity of the compound instrument ; and another is the large field, or large angle of view, which may be obtained, every part of which will be nearly equally good ; whereas with the best simple microscopes the field is small, and is good only in the centre.”

Mr. Lister, as we stated in a previous chapter, first set about investigations which have ultimately proved of the utmost value. The results arrived at by him were published in the *Philosophical Transactions* ; and the principles have since been applied and exhibited by Mr. Hugh Powell and Mr. Andrew Ross. It is due to the late Mr. Tulley to say, that he constructed an achromatic object-glass of nine-tenths of an inch focal length, composed of three lenses, transmitting a pencil of eighteen degrees ; and as regards accurate correction throughout the

field, his combination has not been excelled by any subsequent set of three lenses. By Mr. Lister's combination he was enabled to produce lenses which transmitted a pencil of fifty degrees with a large field correct in every part. In the paper referred to above he enters into many interesting particulars, which, however, are not necessary to the comprehension of our subject. Mr. Ross presented to the Society of Arts, in 1837, a paper on the subject, which was published in the 51st volume of their *Transactions*. This being essential to a full understanding of the ultimate refinements of the instrument, we give it in full :

"In the course of a practical investigation, with the view of constructing a combination of lenses for the object-glass of a compound microscope which should be free from the effects of aberration, both for central and oblique pencils of great angle, I obtained the greatest possible distance between the object and object-glass ; for in object-glasses of short focal length, their closeness to the object has been an obstacle in many cases to the use of high magnifying powers, and is a constant source of inconvenience.

"In the improved combination the diameter is only sufficient to admit the proper pencil ; the convex lenses are wrought to an edge, and the concave have only sufficient thickness to support their figure : consequently the combination is the thinnest possible, and it follows that there will be the greatest distance between the object and the object-glass. The focal length is $\frac{1}{8}$ of an inch, having an angular aperture of 60° , with a distance of $\frac{1}{2\frac{1}{8}}$ of an inch, and a magnifying power of 970 times linear, with perfect definition on the most difficult Podura scales. I have made object-glasses $\frac{1}{8}$ of an inch focal length ; but as the angular aperture cannot be advantageously increased if the greatest distance between the object and object-glass is preserved, their use will be very limited.

"The quality of the definition produced by an achromatic compound microscope will depend upon the accuracy with which the aberrations, both chromatic and spherical, are balanced, together with the general perfection of the workmanship. Now in Wollaston's doublets and Holland's triplets there are no means of producing a balance of the aberrations, as they are composed of convex lenses only ; therefore the best thing that can be done is to make the aberrations a minimum. The remaining positive aberration in these forms produces its peculiar effect upon objects (particularly the detail of the thin transparent class), which may lead to misapprehension of their true structure ; but with the achromatic object-glass, where the aberrations are correctly balanced, the most minute parts of an object are accurately displayed, so that a

satisfactory judgment of their character may be formed. When an object has its aberrations balanced for viewing an opaque object, and it is required to examine that object by transmitted light, the correction will remain; but if it is necessary to immerse the object in a fluid, or to cover it with glass, an aberration arises from these circumstances which will disturb the previous correction, and consequently deteriorate the definition; and this defect will be more obvious with the increase of distance between the object and object-glass.

“If an object-glass is constructed as represented in fig. 26, where the posterior combination p and the middle m have together an excess of negative aberration, and if this be corrected by the anterior combination a having an excess of positive aberration, then this latter combination can be made to act more or less powerfully upon p and m , by making it approach to or recede from them; for when the three act in close contact, the distance of the object from the object-glass is greatest, and consequently the rays from the object are diverging from a point at a greater distance than when the combinations are separated; and as a lens bends the rays more, or acts with

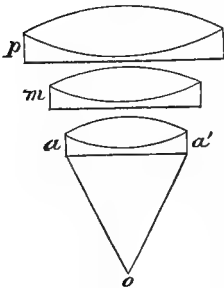

fig. 26.

greater effect, the more distant the object is from which the rays diverge, the effect of the anterior combination a upon the other two, p and m , will vary with its distance from thence.

“When, therefore, the correction of the whole is effected for an opaque object, with a certain distance between the anterior and middle combination, if they are then put in contact, the distance between the object and object-glass will be increased; consequently the anterior combination will act more powerfully, and the whole will have an excess of positive aberration. Now the effect of the aberration produced by a piece of flat and parallel glass being of the negative character, it is obvious that the above considerations suggest the means of correction, by moving the lenses nearer together, till the positive aberration thereby produced balances the negative aberration caused by the medium.

“The preceding refers only to the spherical aberration; but the effect of the chromatic is also seen when an object is covered with a piece of glass: for in the course of my experiments I observed that it produced a chromatic thickening of the outline of the Podura and other delicate scales; and if diverging rays near the axis and at the margin are pro-

jected through a piece of flat parallel glass, with the various indices of refraction for the different colours, it will be seen that each ray will emerge, separated, into a beam consisting of the component colours of the ray, and that each beam is widely different in form. This difference, being magnified by the power of the microscope, readily accounts for the chromatic thickening of the outline just mentioned. Therefore, to obtain the finest definition of extremely delicate and minute objects they should be viewed without a covering: if it be desirable to immerse them in a fluid, they should be covered with the thinnest possible film of talc, as, from the character of the chromatic aberration, it will be seen that varying the distances of the combinations will not sensibly affect the correction; though object-lenses may be made to include a given fluid, or solid medium, in their correction for colour.

“The mechanism for applying these principles to the correction of an object-glass under the various circumstances is represented in fig. 27, where the anterior lens is set in the end of a tube *a*, which slides on the cylinder *b*, containing the remainder of the combination; the tube *a*, holding the lens nearest the object, may then be moved upon the cylinder *b*, for the purpose of varying the distance, according to the thickness of the glass covering the object, by turning the screwed ring *c*, or more simply, by sliding the one on the other, and clamping them together when adjusted. An aperture is made in the tube *a*, within which is seen a mark engraved on the cylinder; and on the edge of which are two marks, a longer and a shorter, engraved upon the tube.

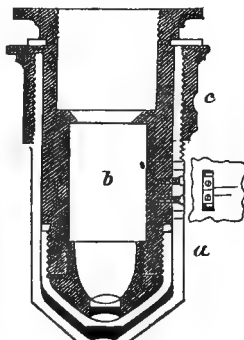

fig. 27

When the mark on the cylinder coincides with the longer mark on the tube, the adjustment is perfect for an uncovered object; and when the coincidence is with the short mark, the proper distance is obtained to balance the aberrations produced by glass the hundredth of an inch thick, and such glass can be readily supplied. This adjustment should be tested experimentally by moving the milled edge, so as to separate or close together the combinations, and then bringing the object to distinct vision by the screw adjustment of the microscope. In this process the milled edge of the object-glass will be employed to adjust for character of definition, and the fine screw movement of the microscope for correct focus.

“It is hardly necessary to observe, that the necessity for this correc-

tion is wholly independent of any particular construction of the object-glass, as in all cases where the object-glass is corrected for an object uncovered, any covering of glass will create a different value of aberration to the first lens, which previously balanced the aberration resulting from the rest of the lenses; and as this disturbance is effected at the first refraction, it is independent of the other part of the combination. The visibility of the effect depends on the distance of the object from the object-glass, the angle of the pencil transmitted, the focal length of the combination, the thickness of the glass covering the object, and the general perfection of the corrections for chromatism and the oblique pencils.

“With this adjusting object-glass, therefore, we can have the requisites of the greatest possible distance between the object and object-glass, an intense and sharply-defined image throughout the field, from the large pencil transmitted, and the accurate correction of the aberrations; also, by the adjustment, the means of preserving that correction under all the varied circumstances in which it may be necessary to place an object for the purpose of observation.”

Angle of Aperture.

The definition of an object-glass much depends upon the increased “angle of aperture.” The angle of aperture is that angle which the most extreme rays that are capable of being transmitted through the object-glass make with the point of focus: bab , in figs. 28 and 29, is the angle of aperture; but it will be seen that the angle of aperture is

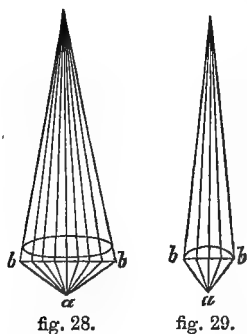

much greater in fig. 28 than in fig. 29, which represents an uncorrected lens; consequently a much larger quantity of light is transmitted by the former than by the latter, when any object is subjected to examination. In order to see an object at all distinctly with an uncorrected lens, it is necessary to diminish the aperture so much, by the aid of stops, as to interfere with the transmission of the amount of light required to see the object perfectly. We shall have occasion to speak of this again.

A very perfect instrument for measuring the angle of aperture, designed by Mr. Gillett, consists of two microscopes, the optical axes of which may be adjusted to coincidence. One of these is attached horizontally to the traversing arm of a hori-

zontal graduated circle, and is adjusted so that the point of a needle, made to coincide with the axis of motion of the movable arm, may be in focus and in the centre of the field of view. The other microscope, to which the object-glass to be examined is attached, is fixed, and so adjusted that the point of the same needle may be in focus in the centre of its field. The eye-piece of the latter is then removed, and a cap with a very small aperture is substituted, close to which a lamp is placed. It is evident that the rays transmitted by the aperture will pursue the same course in reaching the point of the needle as the visual rays from that point to the eye, but in a contrary direction; and being transmitted through the movable microscope, the eye will perceive an image of the bright spot of light throughout that angular space that represents the true aperture of the object-glass examined. The applications of this instrument in the construction of object-glasses are too numerous to be here detailed: amongst the most obvious of which may be mentioned the ready means it presents of determining the nature, and measuring the amount of the aberration in any given optical combination.

Fig. 30 represents the body of one of Mr. Ross's compound microscopes with the triple object-glass, where *o* is an object; and above it is seen the triple achromatic object-glass, in connection with the eye-piece *ee*, *ff* the plano-convex lens; *ee* being the eye-glass, and *ff* the field-glass, and between them, at *bb*, a dark spot or diaphragm. The course of the light is shown by three rays drawn from the centre, and three from each end of the object *o*; these rays, if not prevented by the lens *ff*, or the diaphragm at *bb*, would form an image at *aa*; but as they meet with the lens *ff* in their passage, they are converged by it and meet at *bb*, where the diaphragm is placed to intercept all the light except that required for the formation of a perfect image; the image at *bb* is further magnified by the lens *ee*, as if it were an original object. The triple achromatic combination constructed on Mr. Lister's improved plan, although capable of transmitting large angular pencils, and corrected as to its own errors of

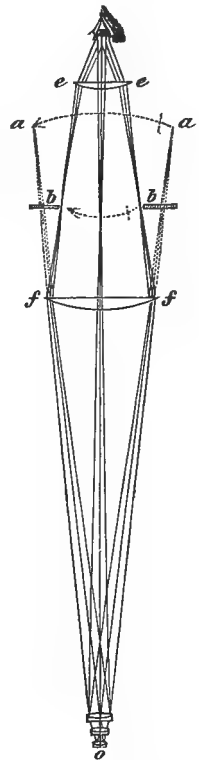

fig. 30.

spherical and chromatic aberration, would, nevertheless, be of little service without an eye-piece of peculiar construction.

If we stopped here, we should convey a very imperfect idea of the beautiful series of corrections effected by the eye-piece, and which were first pointed out in detail in a paper on the subject, published by Mr. Varley, in the fifty-first volume of the *Transactions of the Society of Arts*. The eye-piece in question was invented by Huyghens for telescopes, with no other view than that of diminishing the spherical aberration by producing the refractions at two glasses instead of one, and of increasing the field of view. It consists of two plano-convex lenses, with their plane sides towards the eye, and placed at a distance apart equal to half the sum of their focal lengths, with a stop or diaphragm placed midway between the lenses. Huyghens was not aware of the value of his eye-piece; it was reserved for Boscovich to point out that

he had, by this important arrangement, accidentally corrected a great part of the achromatic aberration. Let fig. 31 represent the Huyghenian eye-piece of a microscope, *ff* being the field-glass, and *ee* the eye-glass, and *lmn* the two extreme rays of each of the three pencils emanating from the centre and ends of the object, of which, but for the field-glass, a series of coloured images would be formed from *rr* to *bb*; those near *rr* being red, those near *bb* blue, and the intermediate ones green, yellow, and so on, corresponding with the colours of the prismatic spectrum. This order of colours is the reverse of that of the common compound microscope, in which the single object-glass projects the red image beyond the blue.

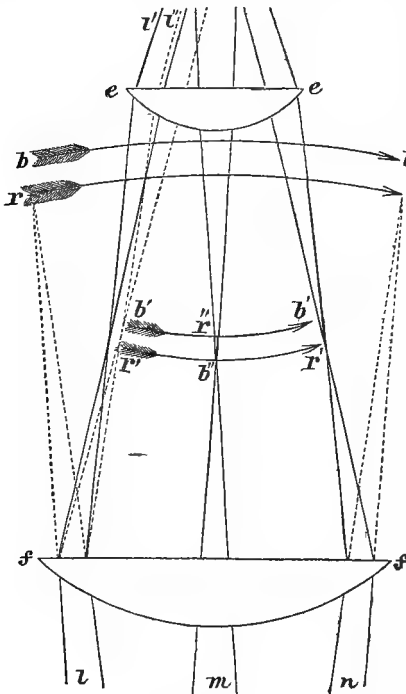

fig. 31.

The effect just described, of projecting the blue image beyond the

red, is purposely produced for reasons presently to be given, and is called over-correcting the object-glass as to colour. It is to be observed also, that the images bb and rr are curved in the wrong direction to be distinctly seen by a convex eye-lens, and this is a further defect of the compound microscope of two lenses. But the field-glass, at the same time that it bends the rays and converges them to foci at $b'b'$ and $r'r'$, also reverses the curvature of the images as there shown, and gives them the form best adapted for distinct vision by the eye-glass ee . The field-glass has at the same time brought the blue and red images closer together, so that they are adapted to pass uncoloured through the eye-glass. To render this important point more intelligible, let it be supposed that the object-glass had not been over-corrected, that it had been perfectly achromatic; the rays would then have become coloured as soon as they had passed the field-glass; the blue rays, to take the central pencil, for example, would converge at b'' , and the red rays at r'' , which is just the reverse of what the eye-lens requires; for as its blue focus is also shorter than its red, it would demand rather that the blue image should be at r'' , and the red at b'' . This effect we have shown to be produced by the over-correction of the object-glass, which protrudes the blue foci bb as much beyond the red foci rr as the sum of the distances between the red and the blue foci of the field-lens and eye-lens; so that the separation br is exactly taken up in passing through those two lenses, and the whole of the colours coincide as to focal distance as soon as the rays have passed the eye-lens. But while they coincide as to distance, they differ in another respect,—the blue images are rendered smaller than the red by the superior refractive power of the field-glass upon the blue rays. In tracing the pencil l , for instance, it will be noticed that, after passing the field-glass, two sets of lines are drawn, one whole and one dotted, the former representing the red, and the latter the blue rays. This is the accidental effect in the Huyghenian eye-piece pointed out by Boscovich. The separation into colours of the field-glass is like the over-correction of the object-glass,—it leads to a subsequent complete correction. For if the differently coloured rays were kept together till they reached the eye-glass, they would then become coloured, and present coloured images to the eye; but fortunately, and most beautifully, the separation effected by the field-glass causes the blue rays to fall so much nearer the centre of the eye-glass, where, owing to the spherical figure, the refractive power is less than at the margin, that that spherical error of the eye-lens constitutes a nearly perfect balance to the chromatic dispersion of the field-lens, and the blue and red rays l' and l'' emerge

sensibly parallel, presenting, in consequence, the perfect definition of a single point to the eye. The same reasoning is true of the intermediate colours and of the other pencils.

From what has been stated, it is obvious what we mean by an achromatic object-glass: one in which the usual order of dispersion is so far reversed, that the light, after undergoing the singularly beautiful series of changes effected by the eye-piece, shall come uncoloured to the eye.

The Huyghenian eye-piece, which we have described, is the best for merely optical purposes; but when it is required to measure the magnified image, we use the eye-piece invented by Mr. Ramsden, and called by him the micrometer eye-piece. The arrangement may be readily understood upon reference to fig. 32. The eye and field glasses

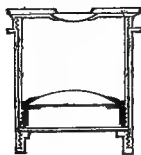

fig. 32.

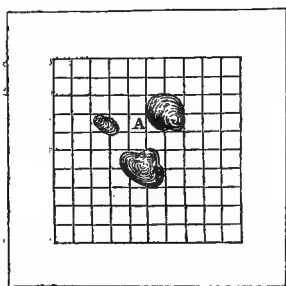

fig. 33.

have now their plane faces turned towards the object; the rays from the object are made to converge immediately in front of the field-glass; and here is placed a plane-glass, on which are engraved divisions of 1-100th of an inch or less. The markings of these divisions come into focus, therefore, at the same time as the image of the object, and both are distinctly seen together. The glass with its divisions is shown in fig. 33, and at it are seen some magnified grains of starch. Thus the measure of the magnified image is given by mere inspection; and the value of such measures, in reference to the real object, when once obtained, is constant for the same object-glass.

Mr. Lister placed on the stage of his instrument a divided scale, the value of which was known; and viewing the scale as the microscopic object, observed how many of the divisions on the scale attached to the eye-piece corresponded with one of those in the magnified image. If, for instance, ten of those in the eye-piece correspond with one of those in the image, and if the divisions are known to be equal, then

the image is ten times larger than the object, and the dimensions of the object are ten times less than indicated by the micrometer. If the divisions on the micrometer and on the magnified scale were not equal, it becomes a mere rule-of-three sum; but in general this trouble is taken by the maker of the instrument, who furnishes a table showing the value of each division of the micrometer for every object-glass with which it may be used.

While on the subject of measuring, it may be well to explain the mode of ascertaining the magnifying power of the compound microscope, which is generally taken on the assumption before mentioned, that the naked eye sees most distinctly at the distance of ten inches.

Place on the stage of the instrument, as before, a known divided scale, and when it is distinctly seen, hold a rule at ten inches distance from the disengaged eye, so that it may be seen by that eye overlapping or lying by the side of the magnified picture of the other scale; then move the rule till one or more of its known divisions correspond with a number of those in the magnified scale, and a comparison of the two gives the magnifying power.

Mr. Jackson has adopted a simpler and cheaper form of micrometer, represented in fig. 34, which is thus described by him in the *Microscopical Society's Transactions*: It consists of a slip of glass placed in the focus of the eye-glass, and can be used with the divisions sufficiently fine to have the value of the ten-thousandth of an inch with the quarter-inch object-glass, and the twenty-thousandth with the eighth; and at the same time the half, or even the quarter of a division may be estimated, thus affording the means of attaining all the accuracy that is really available. It may therefore entirely supersede the more complicated and expensive screw-micrometer, being much handier to use, and not liable to derangement in inexperienced hands.

The positive eye-piece gives the best view of the micrometer, the negative of the object. The

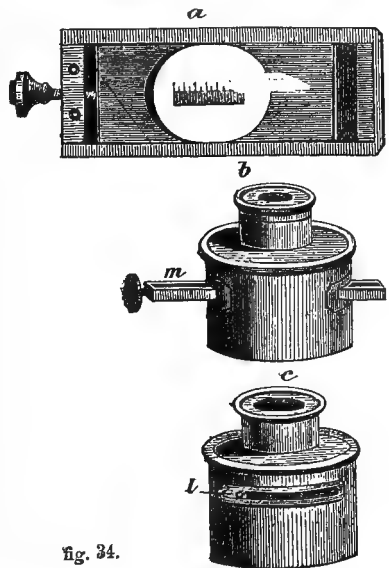

fig. 34.

former is quite free from distortion, even to the edges of the field ; but the object is slightly coloured. The latter is free from colour, but is slightly distorted at the edges. In the centre of the field, however, to the extent of half its diameter, there is no perceptible distortion ; and the clearness of the definition gives a precision to the measurement which is very satisfactory. For this reason Mr. Jackson gives it the preference.

Short bold lines are ruled on a piece of glass, *a*, fig. 34 ; and to facilitate counting, the fifth is drawn longer, and the tenth still longer, as in the common rule. Very finely levigated plumbago is rubbed into the lines, to render them visible ; and they are covered with a piece of thin glass, cemented by Canada balsam, to secure the plumbago from being wiped out. The slip of glass thus prepared is placed in a thin brass frame, so that it may slide freely ; and is acted on at one end by a pushing-screw, and at the other by a slight spring.

Slips are cut in the negative eye-piece on each side, *b*, fig. 34, so that the brass frame may be pressed across the field in the focus of the eye-glass, as at *m* ; the cell of which should have a longer screw than usual, to admit of adjustment for different eyes. The brass frame is retained in its place by a spring within the tube of the eye-piece ; and in using it the object is brought to the centre of the field by the stage movements ; and the coincidence between one side of it and one of the long lines is made with great accuracy by means of the small pushing-screw that moves the slip of glass. The divisions are then read off as easily as the inches and tenths on a common rule. The operation indeed is nothing more than the laying a rule across the body to be measured ; and it matters not whether the object be transparent or opaque, mounted or not mounted ; if its edges can be distinctly seen, its diameter can be taken.

Previously, however, to using the micrometer, the value of the divisions should be ascertained with each object-glass ; the mode of doing which is best performed as follows :—

Lay a slip of ruled glass on the stage ; and having turned the eye-piece so that the lines on the two glasses are parallel, read off the number of divisions in the eye-piece which cover one on the stage. Repeat this process with different portions of the stage-micrometer, and if there be any difference, take the mean. Suppose the hundredth of an inch on the stage requires eighteen divisions in the eye-piece to cover it ; it is quite plain that an inch would require eighteen hundred, and an object which occupied nine of these divisions would measure the two-hundredth of an inch. This is the common mode of express-

ing microscopical measurements ; but I am of opinion that a decimal notation would be preferable, if universally adopted. Take the instance supposed, and let the microscope be furnished with a draw-tube, marked on the side with inches and tenths. By drawing this out a short distance, the image of the stage-micrometer may be expanded until one division is covered by twenty in the eye-piece. These will then have the value of two-thousandths of an inch, and the object which before measured nine will then measure ten ; which, divided by 2000, gives the decimal fraction $\cdot 005$.

Enter in a table the length to which the tube is drawn out, and the number of divisions on the eye-piece micrometer equivalent to an inch on the stage ; and any measurements afterwards taken with that micrometer and object-glass may, by a short process of mental arithmetic, be reduced to the decimal parts of an inch, if not actually observed in them.

In ascertaining the value of the micrometer with a deep object-glass, the hundredth of an inch on the stage will occupy too much of the field ; the two-hundredth or five-hundredth should then be used, and the number of divisions corresponding to that quantity be multiplied by two hundred or five hundred, as the case may be.

The micrometer should not be fitted into too deep an eye-piece, for it is essential to preserve clear definition. The middle eye-piece is for most purposes the best, provided the object-glass be of the first quality ; otherwise use the eye-piece of lowest power. The lens above the micrometer should not be of shorter focus than three-quarters of an inch, even with the best object-glasses ; and the slit cut in the tube can be closed at any time by a small sliding bar, as at *l*, fig. 34.

We subjoin the following comparative micrometrical measures given by Dr. Hannover, as a reference-table.

Millemetre.	Paris lines.	Vienna lines.	Rhenish lines.	English inch.
1	0.443296	0.4555550	0.458813	0.0393708
2.255829	1	1.027643	1.035003	0.0888138
2.195149	0.973101	1	1.0071625	0.0864248
2.179538	0.966181	0.992888	1	0.0858101
25.39954	11.25952	11.57076	11.65364	1

The wonderful tracing on glass executed by M. Nobert, of Barth, in Prussia, deserves attention. The plan adopted by him is, to trace on glass ten separate bands at equal distances from each other, each

band being composed of parallel lines of some fraction of a Prussian inch apart; in some they are 1-1000th, and in others only 1-4000th of a Prussian inch separated. The distance of these parallel lines forms part of a geometric series :

0·001000 lines.	0·000463 lines.
0·000857 "	0·000397 "
0·000735 "	0·000340 "
0·000630 "	0·000292 "
0·000540 "	0·000225 "

To see these lines at all, it is requisite to use a microscope with a magnifying power of 100 diameters; the bands containing the fewest number of lines will then be visible. To distinguish the finer lines, it will be necessary to use a magnifying power of 2000, and then the lines which are only 1-47000th of an inch apart will be seen as perfectly traced as the coarser lines. Of all the tests yet found for object-glasses of high power, these would seem the most valuable. These tracings have tended to confirm the undulating theory of light, the different colours of the spectrum being exhibited in the ruled spaces according to the separation of the lines; and in those cases where the distances between the lines are smaller than the length of the violet-coloured waves, no colour is perceived; and it is stated, that if inequalities amounting to 0·000002 line occur in some of the systems, stripes of another colour would appear in them.

Achromatic object-glasses for microscopes are of various foci, differing from 2 inches to 1-16th of an inch.

Magnifying Power of Mr. Ross's Object-Glasses with his various Eye-Pieces.

EYE-GLASSES.	OBJECT-GLASSES.					
	1-inch.	2-inch.	$\frac{1}{2}$ -inch.	$\frac{1}{4}$ -inch.	$\frac{1}{8}$ -inch.	$\frac{1}{16}$ -inch.
A	20	60	100	220	420	600
B	30	80	130	350	670	870
C	40	100	180	500	900	1200
Value of each space in the Micro-meter eye-glass, with the various object-glasses.	$\frac{1}{200}$ ·0025	$\frac{1}{670}$ ·001031	$\frac{1}{1000}$ ·0005263	$\frac{1}{3500}$ ·0002325	$\frac{1}{6000}$ ·0001111	$\frac{1}{12000}$ ·000074

Schmidt's goniometer positive eye-piece, for measuring the angles of crystals, is so arranged as to be easily rotated within a large and accurately graduated circle. Across the focus of the eye-piece a single cobweb is drawn, and to the upper part is attached a vernier. The crystals being placed in the field of the microscope, and care being taken that they lie *perfectly flat*, the vernier is brought to zero, and then the whole apparatus turned until the line is parallel with one face of the crystal; the frame-work bearing the cobweb, with the vernier, is now rotated until the cobweb becomes parallel with the next face of the crystal, and the number of degrees which it has traversed may then be accurately read off.

The Eye-piece.—To the most complete instruments a set of eye-pieces, consisting of three, is generally made. These differ in power; the longest is always the lowest power, and is marked A. Its angular aperture, which determines the size of the field of view, is generally less than that of the others (if constructed on the Huyghean plan), being limited by the diameter of the body. It is usually about 20 degrees. The next eye-piece, or middle power, marked B, and the deepest, C, have more than 30 degrees of angular aperture.

For viewing thin sections of recent or fossil woods, coal, the fructification of ferns and mosses; fossil-shells, seeds, small insects, or parts of large ones; molluscs, or the circulation in the frog, &c., the eye-piece A is best adapted.

For examining the details of any of the above objects, it will be advisable to substitute the eye-piece B, which also should be used in the observation of crystals when illuminated by polarised light, the pollen of flowers, minute dissection of insects, the vascular and cellular tissues of plants, the Haversian canals and lacunæ of bone, and the serrated laminæ of the crystalline lens in the eyes of birds and fishes.

The eye-piece C is of use when it is requisite to investigate the intimate structure of delicate tissues; and also in observations upon fossil infusoria, volvox, scales from moths' wings, raphides, &c. The employment of this eye-piece, when a higher power is required, obviates the necessity of using a deeper object-glass, which always occasions a fresh arrangement of the illumination and focus. It must be borne in mind, that the more powerful the eye-piece, the more apparent will the imperfections of the object-glass become; hence less confidence should be placed in the observations made under a powerful eye-piece than when a similar degree of amplification is obtained with a shallow one and a deeper object-glass.

The degree of perfection in the construction of the optical part of a

microscope is judged of by the distinctness and comfort with which it exhibits certain objects, the details of which can only be made visible by combinations of lenses of high magnifying power, and a near approach to correctness. Such are called by the microscopist *test-objects*. Mr. C. Brooke, F.R.S., whose labours have been devoted to the correction of errors which have crept into this part of philosophical research, says: "In order to arrive at any satisfactory conclusions regarding the action of any transparent medium on light, it is necessary to form some definite conceptions regarding the external form and internal structure of the medium. This observation appears to apply in full force to microscopic test-objects; and for the purposes of the present inquiry, it will suffice to limit our observations to the structure of two well-known test-objects,—the scales of *Podura plumbea*, and the siliceous loriceæ, or valves of the genus *Pleurosigma*, freed from organic matter: the former of these is commonly adopted as the test of the *defining* power of an achromatic object-glass, and the several species of the latter as the tests of the *penetrating* or *separating* power, as it has been termed. The defining power depends only on the due correction of chromatic and spherical aberrations, so that the image of any point of an object formed on the retina may not overlap and confuse the images of adjacent points. This correction is never theoretically perfect, since there will always be residual terms in the general expression for the aberration, whatever practicable number of surfaces we may introduce as arbitrary constants; but it is practically perfect when the residual error is a quantity less than that which the eye can appreciate. The separation of the markings of the *Pleurosigmata* and other analogous objects is found to depend on good defining power associated with large angle of aperture.

The *Podura* scale appears to be a compound structure, consisting of a very delicate transparent lamina or membrane, covered with an imbricated arrangement of epithelial plates, the length of which is six or eight times their breadth, somewhat resembling the tiles on a roof, or the long pile of some kinds of plush. This structure may be readily shown by putting a live *Podura* into a small test-tube, and inverting it on a glass-slide; the insect should then be allowed for some time to leap and run about in the confined space. By this means the scales will be freely deposited on the glass; and being subsequently trodden on by the insect, several will be found from which the epithelial plates have been partially rubbed off, and at the margin of the undisturbed portion the form and position of the plates may be readily recognised. This structure appears to be rendered most evident by mounting the

scales thus obtained in Canada balsam, and illuminating them by means of Wenham's parabolic reflector. The structure may also be very clearly recognised when the scale is seen as an opaque object under a Ross's $\frac{1}{12}$ th (specially adjusted for uncovered objects), illuminated by a combination of the parabola and a flat Lieberkuhn. The under-side of the scale thus appears as a smooth glistening surface, with very slight markings, corresponding probably to the points of insertion of the plates on the contrary side. The minuteness and close proximity of the epithelial plates will readily account for their being a good test of *definition*, while their prominence renders them independent of the *separating* power due to large angle of aperture.

The structure of the second class of test-objects above mentioned differs entirely from that above described ; it will suffice for the present purpose to notice the valves of three species only of the genus *Pleurosigma* ; which, as arranged in the order of easy visibility, are, *P. formosum*, *P. hippocampus*, *P. angulatum*. These appear to consist of a lamina of homogeneous transparent siliceous, studded with rounded knobs or protuberances, which, in *P. formosum* and *P. angulatum*, are arranged like a tier of round shot in a triangular pile, and in *hippocampus* like a similar tier in a quadrangular pile, as has frequently been described ; and the visibility of these projections is probably proportional to their convexity. The "dots" have by some been supposed to be depressions ; this, however, is clearly not the case, as fracture is invariably observed to take place *between* the rows of dots, and not *through* them, as would naturally occur if the dots were depressions, and consequently the substance is thinner there than elsewhere.

This, in fact, is always observed to take place in the siliceous loricae of some of the border tribes that occupy a sort of neutral, and yet not undisputed, ground between the confines of the animal and vegetable kingdoms ; as, for example, the *Isthmia*, which possesses a reticulated structure, with depressions between the meshes, somewhat analogous to that which would result from pasting together bobbin-net and tissue-paper. The valves of *P. angulatum*, and other similar objects, have been by some writers supposed to be made up of two substances possessing different degrees of refractive power ; but this hypothesis is purely gratuitous, since the observed phenomena will naturally result from a series of rounded or lenticular protuberances of one homogeneous substance. Moreover, if the centres of the markings were centres of greatest density, if, in fact, the structure were at all analogous to that of the crystalline lens, it is difficult to conceive why the oblique rays only should be visibly affected. When *P. hippocampus* or *P. for-*

mosum is illuminated by a Gillett's condenser, with a central stop placed under the lenses, and viewed by a quarter-inch object-glass of 70° aperture, both being accurately adjusted, we may observe in succession, as the object-glass approaches the object, first a series of well-defined bright dots; secondly, a series of dark dots replacing these; and thirdly, the latter are again replaced by bright dots, not, however, as well defined as the first series. A similar succession of bright and dark points may be observed in the centre of the markings of some species of *Coscinodiscus* from Bermuda.

These appearances would result if a thin plate of glass were studded with minute, equal, and equidistant plano-convex lenses, the foci of which would necessarily lie in the same plane. If the focal surface, or plane of vision, of the object-glass be made to coincide with this plane, a series of bright points would result from the accumulation of the light falling on each lens. If the plane of vision be next made to coincide with the surfaces of the lenses, these points would appear dark, in consequence of the rays being refracted towards points *now* out of focus. Lastly, if the plane of vision be made to coincide with the plane *beneath* the lenses that contain their several foci, so that each lens may be, as it were, combined with the object-glass, then a second series of bright points will result from the accumulation of the rays transmitted at those points. Moreover, as all rays capable of entering the object-glass are concerned in the formation of the second series of bright focal points, whereas the first series are formed by the rays of a conical shell of light only, it is evident that the circle of least confusion must be much less, and therefore the bright points better defined in the first than in the last series.

If the supposed lenses were of small convexity, it is evident that the course of the more oblique rays only would be sensibly influenced; hence probably the structure of *P. angulatum* is recognised only by object-glasses of large angular apertures, which are capable of admitting very oblique rays.

It does not appear to be desirable that objects should be illuminated by an entire, or, as it may be termed, a *solid* cone of light of much larger angle than that of the object-glass. The extinction of an object by excess of illumination may be well illustrated by viewing with a one-inch object-glass the *Isthmia*, illuminated by Gillett's condenser. When this is in focus, and its full aperture open, the markings above described are wholly invisible; but as the aperture is successively diminished by the revolving diaphragm, the object becomes more and more distinct, and is perfectly defined when the aperture of

the illuminating pencil is reduced to about 20° . The same point may be attained, although with much sacrifice of definition, by gradually depressing the condenser, so that the rays may diverge before they reach the object; and it may be remarked, generally, that the definition of objects is always most perfect when an illuminating pencil of suitable form is accurately adjusted to focus, that is, so that the source of light and the plane of vision may be conjugate foci of the illuminator. If an object-glass of 120° aperture, or upwards, be used as an illuminator, the markings of Diatomaceæ will be scarcely distinguishable with an object-glass, the glare of the central rays overpowering the structure of those that are more oblique."

MECHANICAL ARRANGEMENTS.

Having now explained the more important optical principles of the achromatic compound microscope, it remains only to describe the mechanical and accessory arrangements for giving those principles their full effect. The mechanism of a microscope is of much more importance than might be imagined by those who have not studied the subject. In the first place, steadiness, or freedom from vibrations which are not equally communicated to the object under examination and to the lenses by which it is viewed, is a point of the utmost consequence.

One of the best modes of mounting a compound microscope is that shown, fig. 35, which, although it does not exhibit all the details, will serve to explain the chief features of the arrangement.

"The mechanical construction," says Mr. Ross, "is derived from a practical acquaintance with the various improvements made in the microscope for many years. The general arrangement, which is properly the province of the mechanic, has been contrived to obtain the utmost freedom from tremor, and to afford the greatest facility in using the various movements; while the extent, direction, and number of these have been collected from the experience of the most indefatigable observers in all the various branches of microscopic inquiry.

The optical part, also, has arrived at such perfection, that points or lines whose distance is such that their separation is bordering on interfering with the physical constitution of light can be distinctly separated, thus insuring a reality in the appearance of objects where the minuteness of the detail approaches the natural limit of microscopic vision."

In the larger instrument, fig. 36, two uprights, J, are strengthened by

two internal buttresses mounted on a strong tripod; at the upper part, and between the uprights, we have an axis, upon which the whole of the upper part of the instrument turns, so as to enable it to take a horizontal or vertical position, or any intermediate inclination,—such, for instance, as that shown in the drawing. This movable part is fixed to

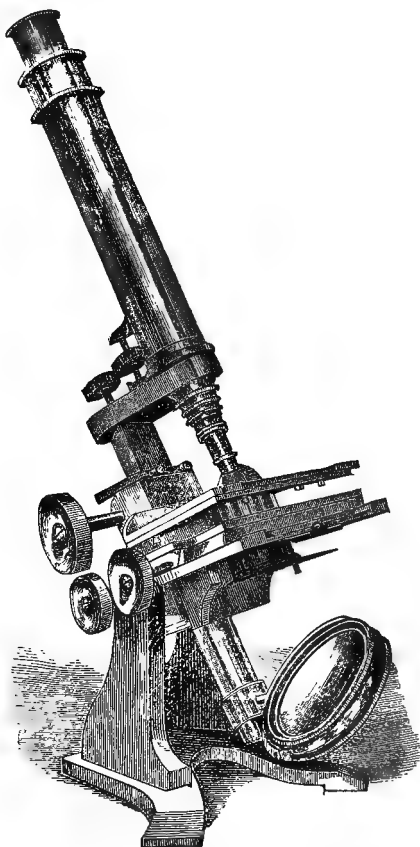

fig. 35. *Baker's Compound Microscope.*

the axis near its centre of gravity, and consists of the stage *F G*; the arm *K* is screwed into the triangular bar, and carries the microscope tube or body *A*, at the upper end of which is the eye-piece *B*, and at the lower the object-glasses *C*. The stage *F G* has rectangular move-

ments one inch in extent on the racket-cylinders, and are moved by the pinions connected with the milled-heads at G. The triangular bar, together with the arm and microscope-tube, is moved by the large

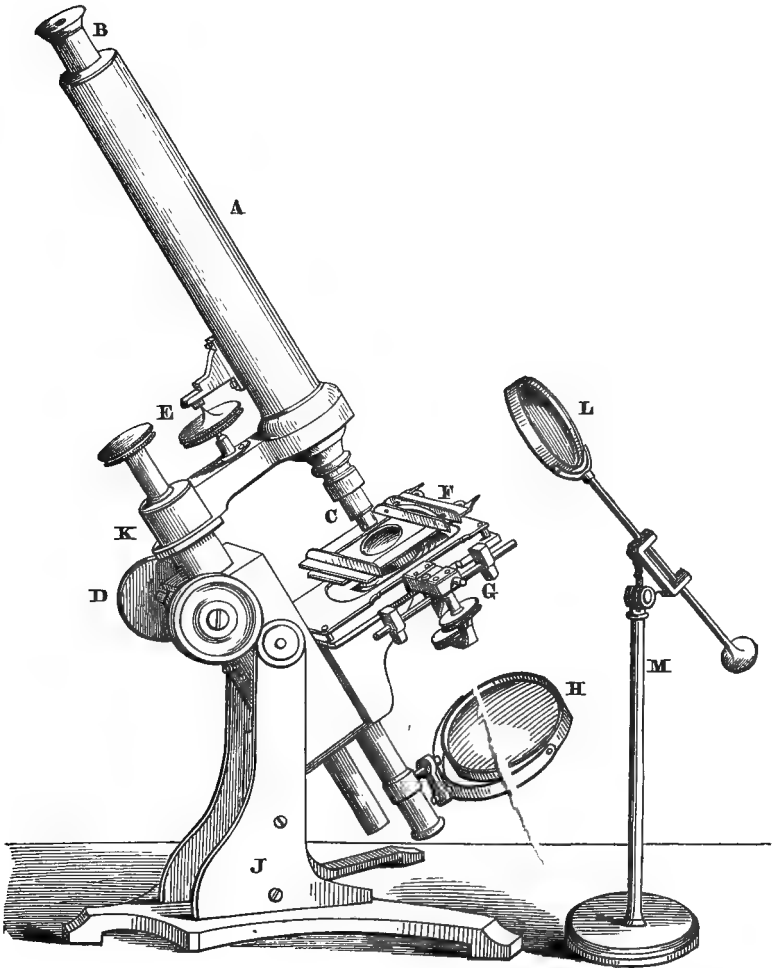

fig. 36. *The Compound Microscope.*

milled-heads at D ; and a more delicate adjustment of this optical part is effected by the milled-head E. The other milled-head fixes the arm K to the triangular bar. H is the mirror, which slides up or down the tube to which it is attached ; standing near which is the condenser M, with its upright support of brass for holding the condensing-lens L,—this is made to unscrew, for the convenience of packing. Such instruments are manufactured by Mr. Ross at prices varying from 10*l.* to 100*l.*

Mr. Ross's small achromatic compound microscope is supported on a firm tripod base, from which rise two strong uprights, supporting at their upper parts the trunnions to which the square frame, carrying the stage and triangular bar, with the body, are attached. Within the tube a smaller one is made to slide up and down by rack and pinion : this forms the coarse adjustment. The fine adjustment consists of a conical-pointed steel screw pressing against the top of a slit in the inner tube, to the end of which the adapter for receiving the object-glasses is fixed. The stage has the usual rectangular motions, that from the side being performed by a screw and nut, by turning the milled-head ; whilst the up-and-down movement is performed by a rack and pinion, turned by the milled-head below the other. The stage-plate is provided with a sliding-rest, by which the distance of an object from the central hole in the plate may be regulated before focussing : this is sometimes made to answer the purpose of the complicated sliding-frame in the more expensive instruments. At the upper part of this stage-plate there are two holes for the reception of the forceps and side reflector. To the under part of the stage, the achromatic condensers, the diaphragm-plate, and polarising-prism may all be adapted as in the larger instruments ; and for convenience of package, the stage itself may be turned on a pivot, so as to be at right angles with the tube. The mirror is mounted in the usual manner, and is made to slide up or down the tube on which it is supported. This is recommended to those whose means are limited, in consequence of the low price ; it being of a form which may be added to from time to time, according to the wants of the employer : thus, for instance, a vertical stand, with two eye-pieces, exclusive of the object-glasses, may be procured without the stage movements or the fine adjustment, at the small cost of 4*l.* 10*s.* ; and as both the stage and the compound body are of the same size as in the more perfect instrument, the fine adjustment and the stage movement may be added to the former at any time, and render it as complete.

A smaller compound achromatic microscope, fig. 37, is particularly adapted for students : this is packed into a neat mahogany case, com-

plete, with lenses, for the small sum of 5*l.* 15*s.*, by Mr. Baker, 244 Holborn, who likewise furnishes all the requisites for microscopical purposes, with well-selected specimens of mounted objects, at a small cost.

In Messrs. Powell and Lealand's microscope, the body moves on a triangular bar, having a bearing of three inches, which renders it very steady. The coarse and fine adjustment are both carefully attended to; and the stage is large and convenient. On the same bar that the body rests, moves the "achromatic condenser;" by such an arrangement it is certain to move in the same line with the body, which is very essential.

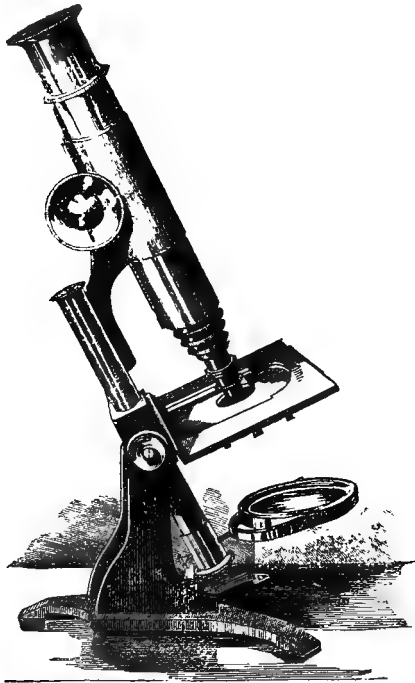

fig. 37. Baker's Student's Microscope.

Their object-glasses are of the most faultless construction, and are preferred for pathological investigations. Messrs. Smith and Beck, Mr. Salmon, and other makers, supply cheap and useful forms of instruments. Mr. Warrington has had constructed a very portable and economical microscope, adapted either for the examination of objects in a *vivarium*, or for dissecting purposes. It is packed in a neat case; and

being of light weight, can be carried in the coat-pocket : the cost complete is 2*l.* 10*s.*

The following useful remarks on the microscope are extracted from the Juries' Reports of the Great Exhibition, 1851 : " The powers varying from one-inch to a quarter-inch focus, inclusive, are by far the most generally useful in the whole range of microscopic combinations, especially for educational purposes. It must be remarked, that the angle of aperture of the combinations^s should not be extended to its utmost possible limit when destined for the general purposes of natural history or anatomical investigation. Combinations of high power, and extremely extended angle of aperture, are excellent in developing one class of test objects, viz. minute lines or dots on plane surfaces, and admirably demonstrate the high perfection to which such glasses are capable of being carried by scientific opticians ; but such combinations, with a less angle of aperture and more penetrating power, are far more generally useful and valuable to the minute anatomist and the naturalist. In regard to the brass-work, the qualities especially requisite in the stand of a microscope are simplicity of construction, portability, combined with sufficient weight to ensure safety and steadiness, with smoothness and accuracy of action in all the working parts, and such a construction as to distribute any tremor that may be communicated to the instrument equally over its body, stage, and other working parts."

CHAPTER III.

PRELIMINARY DIRECTIONS—ILLUMINATION—ACCESSORY APPARATUS—
ACHROMATIC ILLUMINATOR—GILLETT'S CONDENSER—PREPARING AND
MOUNTING OBJECTS—POLARISED LIGHT—BINOCULAR INSTRUMENT—
PHOTOGRAPHIC DRAWING, ETC.

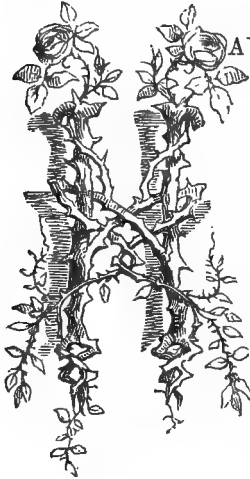

HAVING selected an apartment with a northern aspect, and, if possible, with only one window, and that not overshadowed by trees or buildings: in such a room, on a firm, steady table, keep your instruments and apparatus open, and at all times ready for observation. A large bell-glass will be found of great service in keeping dust from a microscope when set up for use. In winter it will be proper to slightly warm the instrument before it is used, otherwise the perspiration from the eye will be perpetually condensing on the eye-glass, thus greatly impeding vision. Always begin the examination of your object with the lowest power you have, unless it be very minute.

As a general rule, large objects require low powers, and small ones high powers: low powers show the whole or general view of an object, the high ones only its parts in succession; and as the power increases, so does the difficulty of finding the object and adjusting the focus. When you clean the eye-glasses, do not remove more than one at a time, and replace it before you touch another; by so doing you will preserve the component glasses in their proper places: recollect that if intermingled they are useless. Keep a piece of well-dusted and very dry chamois leather, slightly impregnated with the finest tripoli or rotten-stone powder in a small box, to wipe your glasses: a small piece of dried elder-pith is preferred by some for the purpose.

When you look through the instrument, be sure to place your eye quite close to the eye-piece, otherwise the whole field of view will not be visible; and observe, moreover, if you see a round disc of light, at least

when the object is not on the slider-holder: if you do not, it is a sign that something is wrong; perhaps the body is not placed directly before the aperture of the slider-holder, or may not be truly directed towards the light. Use the least amount of light possible, if you work for any length of time. Choose a steady light, with a shade to protect the eyes; one of the old-fashioned *fan-shades* will be found useful for this purpose. Look at the object with both eyes open, and use the eyes alternately. Sit in a comfortable position, and bring the instrument to the proper angle, which will prevent congestion of the eyes; this is indicated if the microscopist is annoyed with little moving objects apparently floating before them: if the eye-lashes be reflected from the *eye-glass*, you are looking *upon* the eye-glass instead of *through* it. Take care also that the mirror is properly arranged.

Sir David Brewster's excellent directions for viewing objects should be made familiar to the microscopist. He observes:

"First. Protect the eye from all surrounding light, letting only the rays which proceed from the illuminated centre of the object fall upon it.

"Secondly. Delicate observations should not be made when the fluid which lubricates the cornea is in a viscid state, or there is any irritation or inflammation about any part of the eye.

"Thirdly. The best position for microscopic observations is with the microscope bent to such an angle with the body, that the head may always remain in a natural and easy attitude; consequently, the worst position would be that which compels us to look downwards vertically.

"Fourthly. If we lie horizontally on the back, parallel markings and lines on objects will be seen more perfectly when their direction is vertical, or in a contrary direction to that in which the lubricating fluid descends over the cornea of the eye.

"Fifthly. Only a portion of the object should be viewed at one time, and every other part excluded. The light which illuminates that part should be admitted through a small diaphragm: at night, from the concentrated light of a sperm-oil or gas lamp, having a faint blue-tinted chimney-glass to correct the yellow colour which predominates in all our artificial illumination. If in the day-time, close a portion of the window-shutters.

"Sixthly. In all cases when high powers are used, the intensity of the illumination should be increased by optical contrivances below the object and stage: this is generally effected by using achromatic condensers beneath the stage."

Mr. James Smith contributed the subjoined practical observations on the same subject to the *Microscopical Transactions*: Much of the

beauty of the objects seen depends upon the management of the light that is thrown upon or behind them, which can only be fully mastered by practice. It may be remarked, however, as a general rule, that in viewing those which are transparent, the plane mirror is most suitable for bright daylight; the concave for a lamp or candle, which should have the bull's-eye lens, when that is used, so close to it that the rays may fall nearly parallel on the mirror.

If the bull's-eye lens is not used, the illuminating body should not be more than five or six inches from the mirror. The latter is seldom required to be more than three inches from the object, the details of which are best shown when the rays from the mirror fall upon it before crossing; and the centre should be, especially by lamplight, in the axis of the microscope. For obscure objects, seen by transmitted light, and for outline, a full central illumination is commonly best; but for seeing delicate lines, like those on the scales of insects, it should be made to fall obliquely, and in a direction at right angles to the lines to be viewed.

The diaphragm is often of great use in modifying the light and stopping such rays as would confuse the image (especially with low or moderate powers); but many cases occur when the effects desired are best produced by admitting the whole from the mirror. If an achromatic condenser is employed instead of the diaphragm, its axis should correspond with that of the body; and its glasses, when adjusted to their right place, should show the image of the source of artificial light; or by day, that of a cloud or window-bar in the field of the microscope, while the object to be viewed is in focus. The most pleasing light for objects in general is that reflected from a white cloud on a sunny day; but an Argand's lamp or wax candle, with the bull's-eye lens, is a good substitute. A large proportion of opaque objects are seen perfectly well (especially by daylight) with the side reflector, and the dark bore as a background; and for showing irregularities of surface, this lateral light is sometimes the best; but the more vertical illumination of the Lieberkuhn is usually preferable; the light thrown up to it from the mirror below being, with good management, susceptible of much command and variety.

Mr. Ross very properly remarks, that the manner in which an object is lighted is second in importance only to the excellence of the glass through which it is seen. In investigating any new or unknown specimen, it should be viewed in turns by every description of light direct and oblique, as a transparent object and as an opaque object, with strong and with faint light, with large angular pencils thrown in

all possible directions. Every change will probably develop some new fact in reference to the structure of the object, which should itself be varied in the mode of mounting in every possible way.

It should be seen both wet and dry, and immersed in fluids of various qualities and densities ; such as water, alcohol, oil, and Canada balsam ; which last has a refractive power nearly equal to that of glass.

If the object be delicate vegetable tissue, it will be, in some respects, rendered more visible by gentle heating or scorching before a clear fire, between two plates of glass. In this way the spiral vessels of asparagus and other similar vegetables may be beautifully displayed. Dyeing the objects in tincture of iodine, or some one of the dye-woods, will, in some cases, answer this purpose better.

But the principal question in regard to illumination is the magnitude of the illuminating pencil, particularly in reference to transparent objects. Generally speaking, the illuminating pencil should be as large as can be received by the lens, and no larger. Any light beyond this produces indistinctness and glare. The superfluous light from the mirror may be cut off by a screen, having various-sized apertures placed below the stage.

The *Diaphragm*, fig. 38, is the instrument used for effecting this purpose. It consists of two plates of brass, one of which is perforated

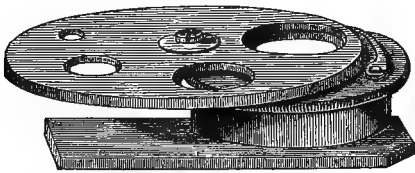

fig. 38.

figure, and is made to revolve upon another plate by a central pin or axis ; this last plate is also provided with a hole as large as the largest in the diaphragm-plate, and corresponds in situation to the axis of the compound body. To ascertain when

either of the holes in the diaphragm-plate is in the centre, a bent spring is fitted into the second plate, and rubs against the edge of the diaphragm-plate, which is provided with notches. The space between the smallest and largest is great enough to use for the purpose of shutting off all the light from the mirror.

A good mode of imitating artificially the light of a white cloud opposite the sun has been proposed by Mr. Varley : he covers the surface of the mirror under the stage with carbonate of soda, or any similar material, and then concentrates the sun's light upon its surface by a large condensing lens.

GILLETT'S ILLUMINATOR, OR CONDENSER.

The advantages of employing an achromatic condenser were first pointed out by Dujardin, since which time an object-glass has been frequently but inconveniently employed ; and more recently achromatic illuminators have been constructed by most of our instrument makers. Some years since, Mr. Gillett was led by observation to appreciate the importance of controlling not merely the quantity of light which may be effected by a diaphragm placed any where between the source of light and the object, but the angle of aperture of the illuminating pencil, which can be effected only by a diaphragm placed immediately behind the achromatic illuminating combination. An elastic diaphragm, or artificial pupil, as it might be called, was first proposed by Mr. Brooke, which was shown to answer very well in a large model, and produced a remarkable semblance of vital contractility ; but mechanical difficulties interfered with its application, and the revolving diaphragm in the instrument, now well known as Gillett's condenser, was substituted. It is represented in fig. 39 as manufactured by Mr. Ross, and consists of an achromatic illuminating lens *c*, which is about equal to an object-glass of one-quarter of an inch focal length, having an angular aperture of 80° . This lens is placed on the top of a brass tube, intersecting which, at an angle of about 25° , is a circular rotating brass plate *ab*, provided with a conical diaphragm, having a series of circular apertures of different sizes *hg*, each of which in succession, as the diaphragm is rotated, proportionally limits the light transmitted through the illuminating lens. The circular plate in which the conical diaphragm is fixed is provided with a spring and catch *ef*, the latter indicating when an aperture is central with the illuminating lens, also the number of the aperture as marked on the graduated circular plate. Three of these apertures have central discs, for circularly oblique illumination, allowing only the passage of a hollow cone of light to illu-

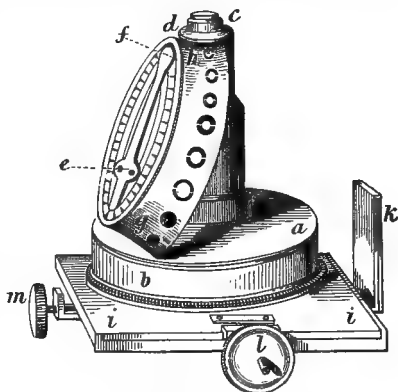

fig. 39. Gillett's Condenser.

minate the object. The illuminator above described is placed in the secondary stage, *ii*, which is situated below the general stage of the microscope, and consists of a cylindrical tube having a rotatory motion, also a rectangular adjustment, which is effected by means of two screws, *lm*, one in front, and the other on the left side of its frame. This tube receives and supports all the various illuminating and polarising apparatus, and other auxiliaries which are placed underneath the object. The tube and its frame are affixed to a dovetailed sliding bar, *k*, which can be easily moved up or down, or taken off for conveniently attaching the various apparatus. This sliding bar fits into a second sliding bar, which by means of a milled-head screw, moving a rack and pinion, regulates the distance of the apparatus from the stage.

Directions for Use, by Day or Lamplight.

In the adjustment of the compound body of the microscope with the illuminator above described, two important results are to be sought, first, their centricity, and secondly, the fittest condensation of the light to be employed. With regard to the first, place the illuminator in the cylindrical tube, and press upwards the sliding bar in its place, until checked by the stop; move the microscope body either vertically or inclined for convenient use; and with the rack and pinion which regulates the sliding bar, bring the illuminating lens to a level with the upper surface of the object-stage; then move the arm which holds the microscope body to the right until it meets the stop, whereby its central position is attained; adjust the reflecting mirror so as to throw light up the illuminator, and place upon the mirror a piece of clean white paper to obtain a uniform disc of light. Then put on the low eye-piece, *a*, and a low power (the half-inch) as more convenient for the mere adjustment of the instrument; place a transparent object on the stage, adjust the microscope-tube, until vision is obtained of the object; then remove the object, and take off the cap of the eye-piece, and in its place fix on the eye-glass called the "centering eye-glass," described below, which will be found greatly to facilitate the adjustment now under consideration, namely, the centering of the compound body of the microscope with the illuminating apparatus of whatever description.* The centering-glass, being thus affixed to the top of the

* This centering-glass consists of a tubular cap containing two plano-convex lenses, which are applied and adjusted so that the image of the aperture in the object-glass, and the images of the apertures at the lenses and in the diaphragms contained in the

eye-piece, α , is then to be adjusted by its sliding-tube (without disturbing the microscope-tube) until the images of the diaphragms in the object-glass and centering lens are distinctly seen. The illuminator should now be moved by means of the left-hand screw on the secondary stage, while looking through the microscope, to enable the observer to recognise the diaphragm belonging to the illuminator, and by means of the two adjusting screws, to place this diaphragm central with the others; thus the first condition, that of centricity, will be accomplished. Remove the white paper from the mirror, and also the centering-glass, and replace the cap on the eye-piece, also the object on the stage, of which distinct vision should then be obtained by the rack and pinion, or fine screw adjustment, should it have become deranged.

The second process is to ascertain that the fittest concentration of light is obtained. For this purpose the mirror should now be so inclined that the image of some intercepting distant object, such as a house-top, or chimney, tree, window-frame, or (if lamp-light be employed) the lamp's flame, may be brought into the field of view; these, though not distinctly seen, may be recognised by partially darkening or otherwise occupying the field; then distinct vision of such object must be obtained by means of the rack and pinion moving the secondary stage to and from the object. Excepting the case of the lamp's flame, the above objects are considered as the representatives of the source of light; for when daylight is employed—as, for example, a white cloud—its motion prevents the image being easily produced: then it is convenient to employ a distant object, such as the above,—the difference of the focal length of the illuminating lens for such an object, and for the white cloud, being almost insensible. This last adjustment being effected by the movement of the secondary stage alone, the microscope tube remaining undisturbed, also the object on the object-stage uninterrupted in focus, the source of the illuminating light and the object to be examined will both be distinctly seen at the same time. These adjustments, whether for daylight or lamplight, being completed, the mirror may be turned so as wholly to reflect the light either of the sky or of the lamp; and the eye-piece and object-glass suitable for examining the object may be employed, and the focus adjusted accordingly. The conical diaphragm with its various apertures may now be rotated, until that quality of illumination is obtained

tube which holds the illuminating combination, may all be in focus at the same time, as with the same adjustment they may be brought sufficiently near in focus to recognise their centricity.

which gives a cool, distinct, and definite view of the object. Upon changing the object-glass, the centering eye-glass should always be employed to ascertain that the centricity of the illuminating condenser and microscope body has not been deranged.

It has been stated that the image of a white cloud opposite the sun is the best for illuminating transparent objects when viewed by transmitted light. Mr. Gillett has successfully imitated this natural surface by an apparatus consisting of a large parabolic reflector, with a small camphine lamp on an adjustable stand, having its flame nearly in the focus; also of two other reflectors of hyperbolic figure, which are employed according to the object-glasses used on the microscope. The parabolic mirror and one of these are attached opposite to each other on the bent arm by which they are supported, having their axes coincident, and the enamel disc placed between them. The small hyperbolic reflector receives the light reflected from the large parabolic reflector, and concentrates the rays on the small enamel disc. The surface of this disc is roughened, so that the forms of all the incident pencils are broken up, and the effect of a white cloud produced.

ROSS'S ACHROMATIC ILLUMINATOR, OR CONDENSER.

When employing this apparatus, the general practice is to insert in it, as an illuminating lens, the object-glass next lowest in power to that which is intended to be attached to the microscope; so that when the one-eighth is used on the microscope, the one-fourth is screwed into the illuminating apparatus; and so, in like manner, with the rest. But when economy is not regarded, a system of three achromatic combinations is supplied, adapted for the illumination of the whole range of the powers of the microscope: the whole system being employed for the highest powers; two of such combinations with the middle powers; and the largest combination by itself for the lowest powers. This illumination is not required for objects when viewed with object-glasses transmitting small pencils of rays, or whose angular aperture is less than thirty degrees; that is, where the object-glass is of greater focal length than half an inch.

The apparatus is fixed to the under side of the stage of the microscope, in the place of the diaphragm-plate; and before fixing, the proper object-glass, as an illuminating lens, must be screwed on to it. In fig. 40, two tubes are seen sliding one within the other; to the outer one, *b*, is attached a flat plate *a*, which slides underneath the stage, and is adjusted for distance by the screw *f*; at *c* the milled-head is

connected to a pinion; and by means of a rack attached, the inner tube, carrying the achromatic combination d , is raised or lowered: the upper part of the outer tube is larger than that where the milled-head is seen, for the purpose of allowing the milled ridge of the achromatic to pass up and down. For the $\frac{1}{2}$ or $\frac{1}{4}$ inch, the combination d is used; and for the higher power, $\frac{1}{8}$ or $\frac{1}{12}$, the second e is slipped over d . Place the object to be viewed upon the stage of the microscope; and when the instrument is not directed at once to the source of light, such as the flame of a lamp, or a white cloud, arrange the reflector (having the plane mirror upwards) so as to throw the light up the tube of the apparatus; which may be ascertained by turning aside the microscope tube, and observing when the spot of light appears on the object placed on the stage. The microscope-tube is then to be replaced as nearly over the spot of light as possible, and vision of the object obtained, disregarding the precise *quality* of the light. Then proceed for perfect adjustment as directed in using Gillett's condenser.

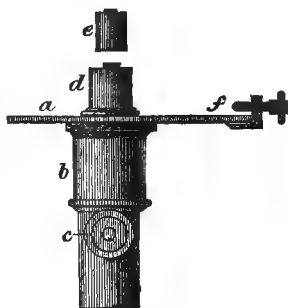

fig. 40.

Slight obliquity of the illumination subdues the glare attendant upon perfectly central and full illumination by lamp-light; and this obliquity may be obtained by slightly altering the position of the mirror; or if the mirror is not employed, but light is obtained by pointing the microscope-tube directly to the lamp, then the obliquity required may be obtained by a small variation of the inclination of the microscope. It is essential that the mirror and lamp-glass be free from dust and soot.

F. H. Wenham, Esq., (*Microsc. Trans.* 1851) proposed a new illuminator, for the purpose of obtaining perfect definition under high powers. Those who have experimented on the subject, may have observed that there is something in the nature of oblique light reflected from a metallic surface particularly favourable for the purpose of bringing out minute markings, which may, in some measure, be attributed to the circumstance of light so reflected being purely achromatic. In order to render this property available, Mr. Wenham contrived a very ingenious metallic reflector, by which the condensation of lateral light may be effected.

"The apparatus is shown in section in fig. 41: *aa* is a parabolic reflector, of a tenth of an inch focus, with a polished silver surface, having the apex so far cut away as to bring the focal point at such a distance above the top of the apparatus (which is closed with a screw-cap when not in use) as may allow the rays to pass through the thickest glass commonly used for mounting objects upon before coming to a focus.

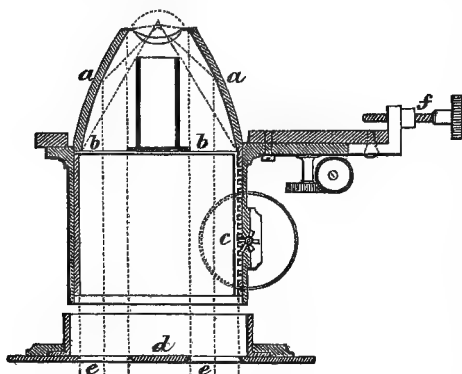

fig. 41.

At the base of the parabola is placed a disc of thin glass *bb*, in the centre of which is cemented a dark well, with a flange equal in diameter to the aperture at the top of the reflector, for the purpose of preventing the direct rays from the source of light passing through the apparatus.

The reflector is moved to and from the object by means of the rack and pinion *c*, and has similar adjustments for centering, and is fixed under the stage of the microscope in the same way as the ordinary achromatic condenser: in addition there is a revolving diaphragm *d*, made to slide on the bottom tube of the apparatus; it has two apertures *ee*, placed diametrically, for the purpose of obtaining two pencils of oblique light in opposite directions. The effects of the chromatic and spherical aberrations, in the shape of fog and colour about the objects, caused by the glass slides upon which they are mounted, frequently require compensation; for as the parabola has the property of throwing parallel rays uncoloured to a point, when used alone, it is most suitable for objects without glass underneath.

By the addition of a meniscus, this compensation is obtained, and also greater purity and intensity of illumination is procured; and as the silver reflector is now closed with glass, it is hermetically sealed, and permanently protected from dust and damp, and will therefore retain its polish. The light most suitable for this method of illumination is lamp or candle light, the rays of which must in all cases be rendered parallel by means of a large plano-convex lens, or condenser; the light may then be used direct, or reflected from the plane mirror. The ob-

ject having been adjusted, the illuminator is moved to and fro till the best effect is produced. For the purpose of viewing some objects, such as the navicula, the circular diaphragm should be slid on the extremity of the apparatus, and revolved till the two pencils of light are thrown most suitably across the object.

All objects, either transparent or opaque, with the exception of white, absorb some of the rays of light, and are rendered visible by that portion which they radiate: a predominance of those rays, either primary or compound, of which ordinary white light is composed, is the cause of their various colours, the intensity of which depends upon the quantity radiated; therefore any object at all capable of radiating light will be well shown by this mode of illumination, and, if the light thrown on them is achromatic, in all their natural colours.

In viewing objects by light transmitted directly through them, we have two sets of rays entering the eye—viz. those emanating from the source of light, and those radiating from the object; the imperfections produced by the former passing through and around the object mingling with the latter, and preventing them from producing their proper effect.'

As the method of illuminating microscopic objects by means of a large angular pencil of light, having the central rays obscured, is of recent introduction, we shall mention a few instances where transparent objects are shown, under similar circumstances, with perfect or improved definition.

The lateral mode of illumination will be found to possess peculiar advantages in the examination of test-objects and the internal mechanism of infusoria. The markings on most of the test-objects are either depressions or projections by direct light: all parts of an object are illuminated with equal intensity, and delicate colours are in great part destroyed, consequently there is a want of contrast. The effect of an angular pencil of rays of 175° , with the central ones stopped, is, that there is a greater relative amount of light thrown on these prominences, as they intercept the largest portion of the marginal rays near the apex of the reflector, leaving the base of the prominence in comparative shadow, consequently the markings we wish to see are the most strongly lighted. The different organs in the interior of an animalcule may be much of the same colour and transparency, and yet possess a different refraction, according to their density. Direct light will pass through these transparent membranes in straight lines without being affected by their various refractive powers. The effect of lateral or oblique light on such tissues is, that the rays are more re-

fracted according to their inclination, and proportionate to the various densities of the medium, the most refractive structure transmitting the greatest quantity of light, and being in consequence the most illuminated; and this reason is somewhat confirmed by the circumstance of lateral illumination showing the structure of some objects which, from slight variation in density, were invisible, except by the use of polarised light. Mr. Shadbolt has since modified this reflector, which he denominates "a sphero-annular condenser:" it has superior reflecting arrangements, with less liability of derangement, and is constructed of a solid cylinder of glass terminating above in a solid cone, the surface of which has the form of a parabola, and replaces the silver reflecting surface.

It is due to Mr. Lister to mention that in his paper on the "Achromatic Object-Glass," published in the 120th vol. of the *Transactions of the Royal Society*, he makes mention "of some objects being better seen when the *central rays* are obscured." This observation has been carried out in many ways. The Rev. Mr. Reade's "back-ground illuminator" is one in which the light is thrown under the object in such a direction as to avoid or pass by the aperture of the object-glass, and give a black field. The structure under view, if large, must have sufficient transparency to allow the light to enter into its substance, and to be diffused or radiated therefrom in all directions. This illuminator is very suitable for objects requiring a low power to view them.

Condensing lenses are used either for opaque objects, or to condense the light upon the mirror attached to the microscope. Two lenses, as represented in fig. 42, are sometimes used. A bull's-eye, or plano-convex lens, of three inches focal length, is best suited for the larger; and the mode of employing the two condensers upon an object placed on the stage of the microscope at *a* is here shown. The bull's-eye lens *c* slides up and down a brass rod, screwed into a steady foot; *b*, the smaller lens, working on a joint, or it may be fixed into the stage of the microscope, through which the light is finally concentrated upon the object from the table gas-lamp *d*. Mr. Brooke's method of viewing opaque objects under the highest powers of the microscope (the $\frac{1}{8}$ and $\frac{1}{12}$ inch object-glass) is effected by two reflections. The rays from a lamp rendered parallel by a condensing lens are received on an elliptic reflector, the end of which is cut off a little beyond the focus; the rays of light converging from this surface are reflected down on the object by a plane mirror attached to the object-glass, and on a level with the outer surface. By these means the structure of the scale of the Podura, and the different characters of its inner and outer surfaces, are rendered distinctly visible. Silver

specula, known as Lieberkuhn's, are much employed, and preferred by some microscopists. The Lieberkuhn is concave, and attached to the

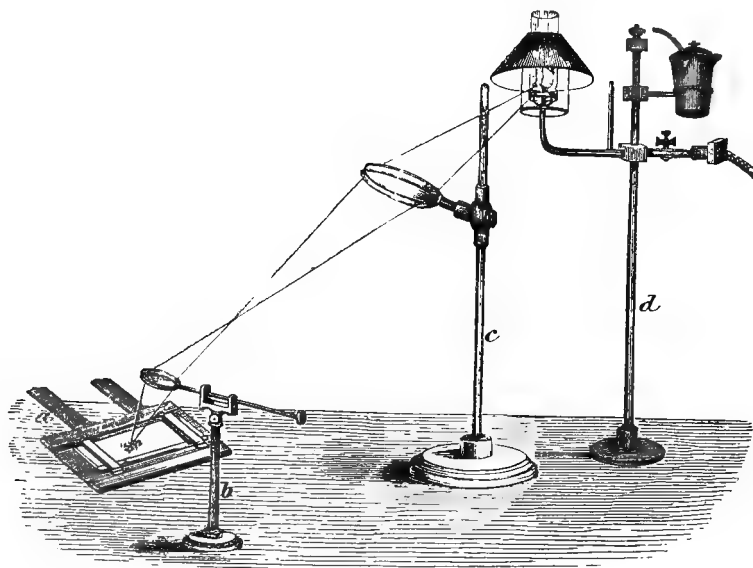

fig. 42.

object-glasses, from the two-inch to the half-inch, in the manner represented at fig. 43, where *a* exhibits the lower part of the compound body; *b* the object-glass, over which is slid a tube and the Lieberkuhn *c* attached to it; the rays of light reflected from the mirror are brought to a focus upon an object *d*, placed between it and the mirror. The object may either be mounted on a slip of glass, or else held in the forceps *f*; and when too small to fill up the entire field of view, or when transparent, it is necessary to place behind it the dark well *e*.

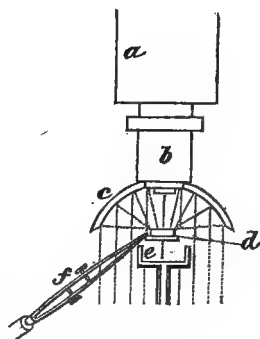

fig. 43.

Each Lieberkuhn being mounted on a short piece of tube, can be slid up and down on the outside of the object-glass, so that the maximum of illumination may be readily obtained. In the higher powers the end of

the object-glass is turned small enough to pass through the aperture in the centre of the Lieberkuhn ; but in the lower powers, where a great amount of reflecting surface would be lost on account of the large size of the glasses employed if this plan were adopted, the aperture in the centre of the Lieberkuhn is made to admit as many rays as will fill the field of view, and no more.

Mr. S. Highley's achromatic gas-lamp, fig. 44, is now much in use, for condensing the light on the mirror. Gas, as a source of light, presents great advantages over oil and spirit, on account of cleanliness, being ever ready for use, and affording a perfect control over

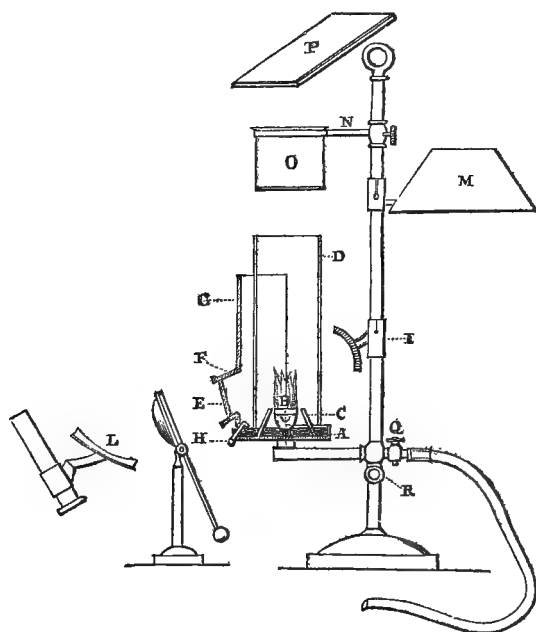

fig. 44.

the flame ; but when the ordinary gas-lamps are used for the purpose of illuminating the field of the microscope, a yellow glaring light is given, alike injurious to the eye and the definition of the object under examination. To correct these evils this lamp was arranged, which is also otherwise useful to the microscopist. It consists of a stage *A*, supported by a tube and socket, sliding on an upright rod rising from

the stand. This carries an argand burner B; a metal cone C rises to the level of the burner, and is about one-eighth of an inch from its outer margin.

This arrangement gives a bright *cylindrical* flame. The bottom of the stage A is covered with wire-gauze, to cut off irregular currents of air, and thus secures a *steady flame*. Over the burner is placed a Leblond's blue glass chimney D. This corrects the colour of the flame to a certain extent; but it is still further rectified by a disc of bluish-black neutral-tint glass E, fitted in a tube F, attached obliquely to the shield G. G is a half-cylinder of metal, which serves to shield the eyes from all extraneous light, but may be rotated on the stage A by aid of the ivory knot H, when the full light from the flame is desired. A metallic reflector I, fixed on its supports, so as to be parallel to E, concentrates the light. By the combination of the two glasses D and E, the yellow rays of the flame are absorbed, and the arrangement affords a soft white light, which may be still further improved by receiving the rays on a concave mirror, backed with plaster-of-Paris, L; and where a very strong light is required, a condensing lens should be interposed, as shown in the cut, between the lamp and the mirror of the microscope. By removing the shield G, and bringing the shade M over the burner, it may be used as a reading-lamp. A retort ring N supports a water-bath O, or a wrought-iron plate P, 6 inches by 2½ inches, both used in mounting objects. The stop-cock Q gives the means of regulating the flame. The screw R clamps the lamp-head at any height desired. The lamp may be attached to any gas-supply by vulcanised India-rubber tubing.

Forceps. — For holding minute objects, such as parts of plants or insects, to be examined either as transparent or opaque objects, the most useful is represented by fig. 45, and consists of a piece of steel

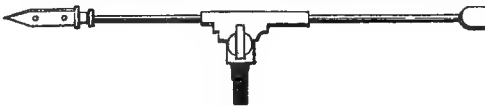

fig. 45.

wire, about three inches long, which slides through a small tube, connected to a stout pin by means of a cradle-joint; to one end of the wire is attached a pair of blades, fitting closely together by their own elasticity, but which, for the reception of any object, may be separated

by pressing the two projecting studs ; to the opposite end of the wire is adapted a small brass-cup, filled with cork, into which pins, passed through discs of cork, card-board, or other material, having objects mounted on them, may be stuck.

Dipping-tubes for taking up Animalcules.—These are tubes of glass, fig. 46, about nine inches in length, open at both ends, and from one-

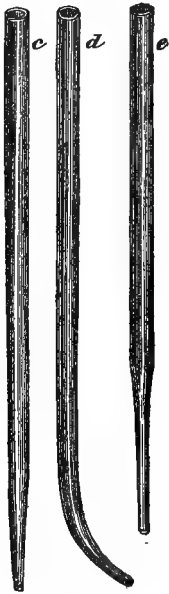

fig. 46.



fig. 47.

eighth to one-fourth of an inch in diameter. The ends should be nicely rounded off in the flame of a blow-pipe ; some of them may be straight, whilst others should be drawn out to a fine point, and made of either of the shapes represented at *cde*. Mr. Varley describes the method of using them in volume forty-eighth of the *Transactions of the Society of Arts*. Supposing the animalcules that are about to be examined to be contained in a phial or glass jar, as in fig. 47, having observed where they are most numerous,—either with the naked eye, if they are large; or with a pocket-magnifier, if they are small,—either of the glass-tubes, having one end previously closed by the thumb or fore-finger, wetted for the purpose, is introduced into the phial in the manner represented

by the figure,—this prevents the water from entering the tube ; and when the end is near to the object which it is wished to obtain, the finger is to be quickly removed and as quickly replaced. The moment the finger is taken off, the atmospheric pressure will force the water, and with it, in all probability, the desired objects, up the tube. When the finger has been replaced, the tube containing the fluid may be withdrawn from the phial ; and as the tube is almost certain to contain much more fluid than is requisite, the entire quantity must be dropped into a watch-glass, which spreads it, and the insect may be again caught by putting the tube over it, when a small quantity of fluid is sure to run in by capillary attraction. This small quantity is to be placed upon the tablet ; but should there be still too much for the tablet, if it be touched with the tube again, it will be diminished accordingly. If we wish to place several individuals together on the tablet, it is necessary that each should be taken up with the smallest amount of water : to effect this, Mr. Varley suggests that the tube should be emptied on a slip of glass, in separate drops ; and with one of the capillary tubes but little larger than enough to catch them, they may be lifted out one by one, and be placed on the tablet. Generally speaking, it is necessary to add a small quantity of vegetable matter to animalcules, to keep them alive ; and as many species of them are found on confervæ and duck-weed, some instrument is required to take small portions of these plants out of the jar in which they are growing. For this purpose Mr. Varley uses the forceps fig. 48. These are made



fig. 48.

of brass ; the points are a little curved, to keep them accurately together, and the blades are provided with a hole and steadying-pin. This instrument serves for transferring small portions of vegetable matter, or for picking up minute objects.

Collecting Animalcules.—For collecting the living water animalcules, the cambric-muslin net, made similar to a landing-net, fig. 49, will be found very useful ; this should be secured to a brass-ring *a*, and fitted into a socket *b*, by which it can be attached to the end of a walking-stick, or, when not in use, the socket may be carried in the pocket ; and the net, by contracting the diameter of the ring (which the construction

admits of) can be put inside of the hat. Fig. 50, is a box containing six bottles for holding the animalcules when caught. These bottles should



fig. 49.

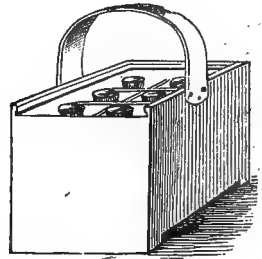

fig. 50.

be filled with the water when you collect the insects, and the larger insects put by themselves. When collecting from different localities, take care not to mix the insects from one brook with those from another, otherwise serious conflicts may take place, and on reaching home you will find the greater part of your stock either dead or dying. Always separate the various sizes and races as speedily as possible. This can be done most easily by emptying each bottle in its turn into a soup-plate; then with the feather of a pen first lift out the smaller ones, and with the quill-end cut like a scoop lift out the larger, classifying and allotting each species to its separate "fish-pond." The best localities in the neighbourhood of London for collecting are Epping Forest, Hampstead Heath, and Blackheath.

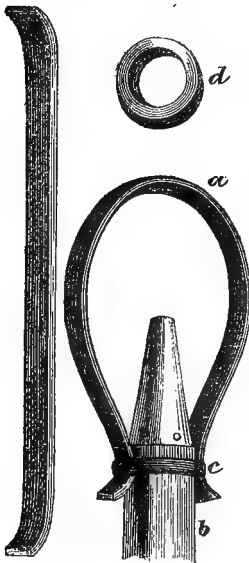

fig. 51.

Mr. Williamson has a very cheap and simple contrivance for converting the end of a walking-stick or umbrella into what he terms a "collecting-stick." In fig. 51, *a* represents a piece of whalebone, about 18 inches long, bent round the end of the stick or umbrella, *b*, and made fast in that position by one or two rings, *c*, of gutta-percha, india-rubber, or of brass, *d*. A small wide-mouthed

bottle, having a rim which will prevent its falling through, is now inserted in the loop thus formed, and is held tightly there by the ends of the whalebone being drawn further through the ring, and thus diminishing the size of the loop. The bottle thus fixed may be used for dipping out the animalcules. Whalebone can be moulded to any form by placing it for a short time near the fire.

Animalcule Cage.—Mr. Varley, in the year 1831, greatly improved the form of this instrument, and gave to it the name of capillary-tablet, or cage. He made a channel all round the object-plate, so that the fluid and the animalcules in it were retained at the top of the object-plate by capillary attraction; and they then bear turning about in all directions without leaving the top, provided the cage be not suddenly shaken. The cover is made to slide down upon the object-plate. The plate of brass to which the tube supporting the tablet and cover is attached is of a circular form, slightly flattened on two opposite sides for convenience of package. One of these instruments is seen in elevation and in section in fig. 52. A B, in both figures, is the flat plate of brass to which the short tube carrying the object-plate or tablet is fixed; *d* the piece of brass into which the tablet *c* is fastened; *b* the tubular part of the cover, into the rim of which the thin plate of glass *a* is cemented.

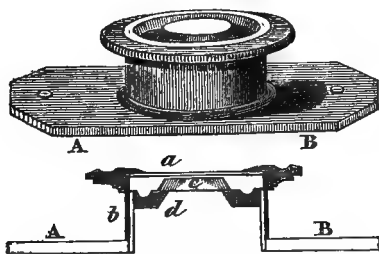

fig. 52.

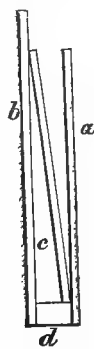

fig. 53.

Many microscopists make great use of the *compressorium*, an instrument in which an object may be submitted to graduated pressure between two plates of glass, the parallelism of which is perfectly maintained. The class of investigations in which the *compressorium* is valuable, is that in which such structures as the minute ovum need be closely scrutinised, without any further change in their shape than may render their contents more distinctly visible. For such purposes

a steady hand and a well-made animalcule cage, such as we have previously described, will answer the purpose sufficiently.

Smith and Beck's troughs for chara and polyps, a sectional view of which is shown at fig. 53, are made of three pieces of glass, the bottom being a thick strip, and the front *a* of thinner glass than the back *b*; the whole is cemented together with Jeffery's marine-glass. The method adopted for confining objects near to the front-glass varies according to circumstances. One of the most convenient plans is to place in the trough a piece of glass that will stand across it diagonally, as at *c*; then if the object be heavier than water, it will sink, until stopped by this plate of glass. At other times, when used to view chara, the diagonal plate may be made to press it close to the front by means of thin strips of glass, a wedge of glass or cork, or even a folded spring. When using the trough, it is necessary that the microscope should be in a position nearly horizontal. A useful trough, described by Mr. Varley, in the *Transactions of the Society of Arts*, consists of a bottom-plate of stout glass, upon which is cemented with pitch and bees'-wax a thin one for the top; slips of glass between it and the bottom-plate forming the sides. The top-plate is not so broad as the bottom, in order that a slip of chara may be more readily placed in the trough, as it can be first laid upon the bottom-plate, and then gradually be slid down between it and the other. In order to render the trough more manageable, it can be cemented to a larger bottom-plate by Canada balsam; but it will be found far more advantageous if the bottom-plate itself be large and broad, and the cover cemented to that, and not to another plate, as two extra surfaces will then be dispensed with.

Dissecting Knives, &c.—Knives and needles of various kinds and sizes are required for microscopic dissection: the best for the purpose are represented in fig. 54, being, in fact, the very delicately made knives used by surgeons in operations upon the eye. Dissecting needles may be either straight or curved. They may be fixed, or made to take in and out of their handles. Three of the most convenient are shown in fig. 55; which are made expressly by Mr. Weedon for the use of the microscopist.

In the preparation of objects, no microscopist was ever more successful than Swammerdam: His chief art seems to have been in constructing very fine scissors, and giving them an extreme sharpness; these he made use of to cut very minute objects, because they dissected them equally, whereas knives, if ever so fine and sharp, are apt to disorder delicate substances. His knives, lancets, and styles were so fine, that he could not see to sharpen them without a magnifying glass.

The mode adopted for breaking up tissues into very small pieces is usually conducted as represented at fig. 56, with a pair of the small

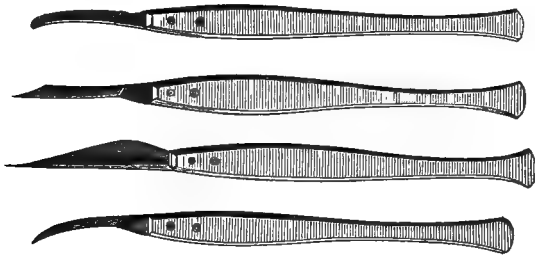

fig. 54.

needles held firmly between the fore-finger and thumb. The structure must be *teased* out; an operation which requires care and perseverance,

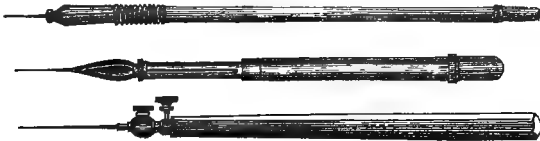

fig. 55.

as most of the animal tissues are very difficult of separation, especially when it is wished to examine them under high powers. All substances

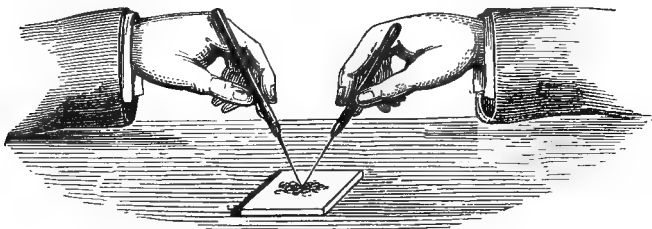

fig. 56.

should be carefully separated from dust and other impurities which would render their structure indistinct, or confusing. With very delicate membranes, and with those of the nervous system of the smaller animals, insects, &c., it becomes necessary that the investigation should

be carried on under water, or in fluid of some sort, the object being contained in a glass case, and having a very strong light thrown down upon it by the aid of the condensing lens, as represented in fig. 57. A certain amount of change of structure must be expected and allowed for; nearly all will imbibe some portion of the fluid. The cells or troughs are generally made of pieces of stout plate-glass, their edges being accurately ground, and cemented together with *marine-glue* or sealing-wax: the size of the trough should be about three inches square and one inch deep.

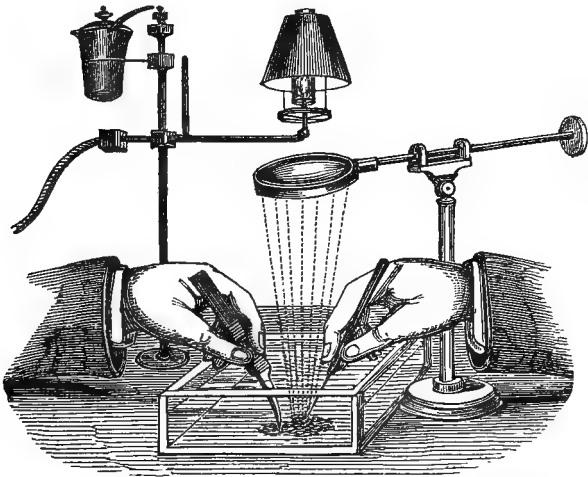

fig. 57.

If desirable to dissect under the microscope itself, the instrument must be brought over the trough, and the subject adjusted to the focus of an inch or a two-inch magnifier, as it is very difficult to employ a much higher power. The simple microscope (p. 27, fig. 23) is that generally employed for the purpose. If the object be a portion of an injected animal, it is better to pin it out on a piece of cork covered with *white wax*, and then immerse it in the water-trough; the more delicate the structure, the sooner after death should it be examined, especially in animals. With most vegetable structures, the dissection should be carried on under water. The separation of the woody and vascular tissues, and the spiral vessels, is only effected by maceration and tearing with the fine needles under water.

The improved Valentin's Knife.—For making fine sections of large substances, or those soft in structure, such as the liver, spleen, and kidney, the double-bladed knife, the invention of Professor Valentin, may be used with advantage. An improved construction of this knife by Professor Quekett is represented in fig. 58. It consists of two blades, one of which is prolonged by a flat piece of steel to form a handle, and has two pieces of wood riveted to it for the purpose of its

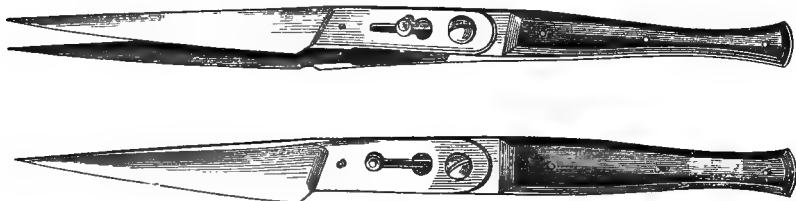

fig. 58.

being held more steadily; to this blade another one is attached by a screw; this last is also lengthened by a shorter piece of steel, and both it and the preceding have slits cut out in them exactly opposite to each other, up and down which slit a rivet with two heads is made to slide, for the purpose either of allowing the blades to be widely separated or brought so closely together as to touch. One head of this rivet, being smaller than the hole in the end of the slit, can be drawn through it; so that the blade seen in the front of the figure may be turned away from the other in order to be sharpened, or allow of the section made by it being taken away from between the blades. The blades are so constructed that their opposed surfaces are either flat or very slightly concave, so that they may fit accurately to each other, which is effected more completely by a steadying-pin, seen at the base of the front blade. When the instrument is required to be used, the thickness of the section about to be made will depend upon the distance the blades are apart: and this is regulated by sliding up or down the rivet, as the blades, by their own elasticity, will always spring open and keep the rivet in place; a cut is then to be made by it, as with an ordinary knife, and the part cut will be found between the blades, from which it may be separated either by opening them as wide as possible by the rivet, or by turning them apart in the manner before described, and floating the section out in water.

Dissecting Scissors.—In addition to the forceps and knives, scissors will be necessary for the purposes of dissection: of these the most useful

are shown in fig. 59. They are either straight or curved; of the first kind, two pairs will be required, one having the extremities broad, and the other sharp-pointed; and if large dissections be undertaken, a still stronger pair, with the extremities broad, and made rough like a file, will also be necessary. In dissecting under the microscope, the curved-pointed pair shown at *f* will be found most convenient. In all of these

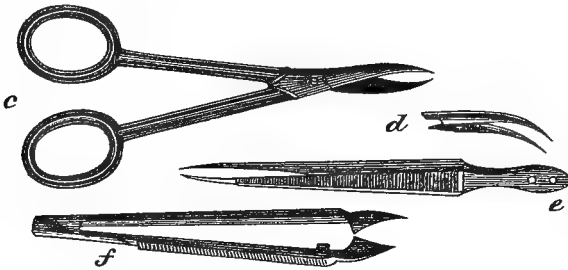

fig. 59.

instruments the points should fit accurately together: sometimes those that are very sharp are apt to cross; this may in a great measure be prevented by having the branches wide at the base where they are riveted. The points can be sharpened on a hone, and a magnifier employed to examine if they fit closely together.

Circular Disc.—For the purpose of cutting glass covers, or making shallow cells with jappanners' gold-size for mounting objects, fig. 60

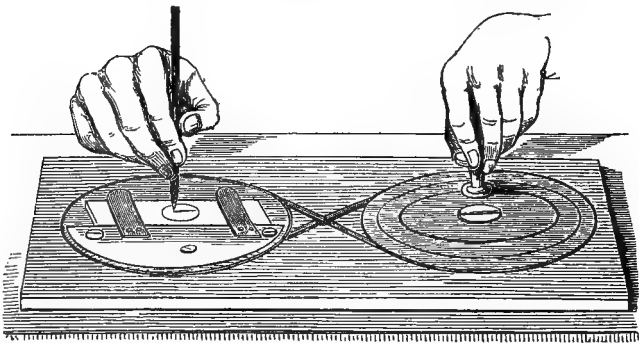

fig. 60.

will be found useful; it is made of two circular wheels of wood, these being let into a solid block of wood, and secured there by central

screws. A handle of wood is fixed into the upper part of one, for the purpose of turning it round, the motion being communicated to the other by an endless band of catgut running in the grooved edge of each. On the upper surface of the wheel, under the right hand, are fixed, by means of screws, two strips of brass, which serve as springs for securing the glass-slip; a camel's-hair pencil previously dipped in jappanners' gold-size is then taken between the finger and thumb, and held as represented in the woodcut, when the wheel is put in motion, and a perfect circle is rapidly formed; the cell is then removed, and put aside to dry. In the same way, by securing a sheet of thin glass under the brass springs, and substituting for the pencil a cutting diamond, a circular cover may be readily cut out. A cutting diamond is not only useful to the microscopist for the above purpose, but also for writing the names of mounted objects on the ends of the glass slides. A glazier's diamond for cutting glass slides is both convenient and economical: the mode of using it may be learned in any glazier's shop.

On mounting and preserving Objects.—Microscopic objects are usually mounted on slips of glass three inches by one inch, either dry or immersed in some fluid. The minute structures, such as the tissues of animals, parts of insects, vessels of plants, &c., must be preserved in thin cells, made as directed above, with a small amount of fluid.* Clean the glass with a weak solution of ammonia or potash from all grease, and wipe it dry with a piece of chamois leather or cotton velvet; cloth generally leaves behind it small filaments, which are always unsightly when seen near the object. Let fall a drop of the preserving fluid or Canada balsam on the centre of the glass; then place the object in it with a small pair of forceps, and spread it out very carefully with the point of one of your fine needles. Select a thin glass cover, previously

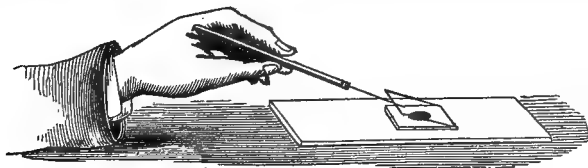

fig. 61.

cleaned, touch its edges with cement, and let it fall gently and gradually down upon the object, as represented in fig. 61; press it lightly:

* Cells for microscopic purposes may be purchased of Mr. Bender, 6 Brunswick Place, City Road, or of Mr. Baker, 244 High Holborn.

to exclude any excess of fluid, which remove with strips of blotting-paper, being careful to do all this with a light hand, that small bubbles of air may not insinuate themselves to replace any lost fluid: air-bubbles are at all times unsightly, and liable to spoil an object when allowed to remain. Lastly, cement the edges of the cover to the bottom glass with jappers' gold-size, or sealing-wax varnish, carefully drawn around the edges with a camels'-hair pencil. Mr. John Gorham has lately proposed the use of a "*Brass cementing Pencil*," fig. 62. It is a brass tube, six inches long, with a conical bore, having a lid to screw on. A small portion of the cement crumbled into fragments is shot into the tube, which is then ready for use. In using this instrument, the extremity is gently heated in the flame of a spirit-lamp; and when the cement begins to ooze out, holding the pencil like a pen, the point is traced along each side of the cover, leaving a line of cement in the angle. It is thus laid on much easier than with a brush, and after a little manipulation, it will be found that the point will suffice to polish off, instead of using the flattened wire. The cement recommended by Mr. Quekett for cementing deep cells is made by melting together two ounces of black resin, one ounce of bees'-wax, and one of vermilion. Mr. Hett prefers dark-coloured and old jappers' gold-size for securing the cells of his beautifully delicate injected preparations.* Mr. Brooke uses Brunswick black, to which has been previously added a little India-rubber dissolved in mineral naphtha, to prevent its cracking when dry.

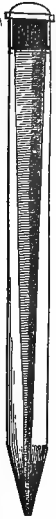

fig. 62.

Mr. Gorham's drawing and description of a "holder" is similar to

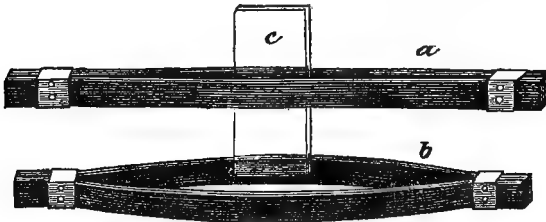

fig. 63.

one long used by the author, fig. 63, for the purpose of pressing together objects mounted in the dry way, and during the drying process,

* For methods of making various good cements, consult Ure's *Dictionary of Arts and Manufactures*.

after maceration, which facilitates removal of the object from time to time for the purpose of examining it. It is made of two stout strips of whalebone three or four inches in length, held together at each end with square pieces of brass; these may be moved at pleasure towards the centre, and thus made to exert considerable pressure upon the pieces of glass and the object, which are placed crossways between the strips of whalebone.

For the purpose of more effectually removing bubbles of air from the cells before cementing them down, the small air-pump, fig. 64, will be found serviceable. This can be purchased of Baker, Holborn,

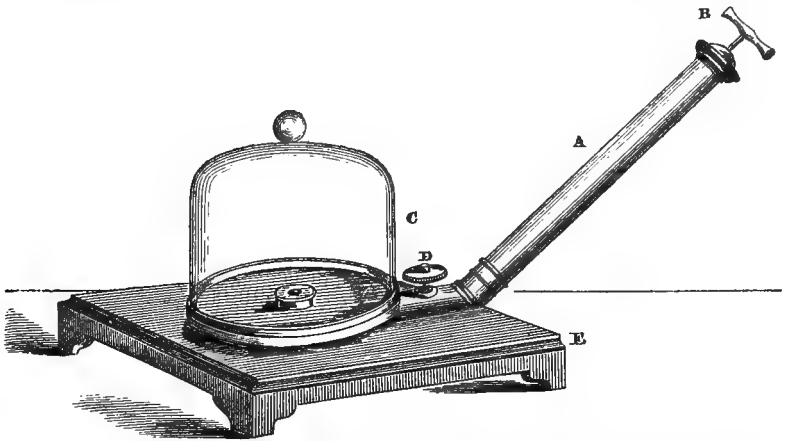

fig. 64.

at a moderate price. The mode of using it, is simply to place the object, after having warmed it and covered it with the thin glass, under the bell-glass *c*; then, by drawing up and pushing down the handle *B*, pump out the air until the whole of the small bubbles are withdrawn from around the object to be secured and preserved. By turning the small screw at *D*, you will let in sufficient air to remove the bell-glass; or allow your object to remain under it for several hours until the cement around the edge of the glass-cover becomes perfectly dried and secure, when exposure to the external air will no longer affect it. It will be also found useful in withdrawing the air from the cells of woods or limbs of insects. The pump itself, *A*, when unscrewed, can be used as an injecting-syringe for fine anatomical injections.

Mr. Thomas Boys, in giving directions for mounting objects in Canada balsam, says, the first thing to be considered is the apparatus required.

1st. A small single-wick oil-lamp, having a glass chimney about four inches long ; the flame to be about the size of that in a hand-lantern : a spirit lamp will do even better.

2d. Slips of glass of required size, and small pieces of thin glass to cover the object, all well cleaned.

3d. A pair of nippers to hold the glass-slips.

4th. A pointed iron-piercer in a wooden handle.

5th. A bottle containing the clearest Canada balsam, diluted with the best spirits of turpentine to a consistency allowing it to drop readily from one end of the iron-piercer, or Mr. Gorham's *cementing-pencil*. The preceding articles being spread before you ready for use, and the object to be displayed well examined for choice of position, and cleaned if necessary, fix the glass-slip in the nippers, dip the piercer into the balsam, and withdraw a full-sized drop to place upon the slide. The centre of the slide should now be rested across the chimney of the lamp until the balsam begins to spread, when it must be immediately withdrawn. The object is then to be placed on this balsam, and at once covered with a second drop, applied in the same way as the first ; in this state the slide should remain (covered to exclude the dust) for two or three minutes, that the balsam may have time to penetrate ; the thin glass is then to be taken up between the finger and thumb, and placed gently upon the balsam covering the object. The slide being now held by the nippers at one end, place the other extremity over the lamp-chimney, so that the heat may be gradually extended towards the object. The proof of its having done so sufficiently will be that the balsam flows to the edge of the thin glass, taking with it all air-bubbles from that part nearest the heat. The slide is now to be turned, the heated end being placed in the nippers, and the process repeated. The slide should remain flat till nearly cool, when pressure should be made with a small piece of wood perpendicularly on the upper glass ; this will expel all superfluous balsam, and with it all extraneous matter. Should any air-bubbles remain, they generally disappear in a few days. If the balsam requires hardening, place the slide on the mantel-piece, the gentle heat from which will prove sufficient.

Mr. Deane recommends a composition of gelatine for mounting dry or moist animal or vegetable structures in place of Canada balsam ; his formula for which is as follows : "Take of White's patent size,

6 ounces by weight; honey 9 ounces by weight; add a little spirits of wine and a few drops of creosote; mix and filter whilst hot, to render perfectly clear. Or take of pure glycerine, 4 fluid ounces; distilled water, 2 fluid ounces; gelatine, 1 ounce by weight; dissolve the gelatine in the water made hot, then add the glycerine and mix with care; this need not be filtered.

Fresh animal or vegetable structures containing their natural juices require little or no preparation before mounting in this substance. Those contained in water, as the desmidiæ, crustacea, &c. may, when taken out of their native element, be placed on a proper slip of glass previously warmed, the superfluous water removed with blotting-paper, and then mounted at once by dropping a little warm medium upon them and covering with thin glass. Animalcules mounted in this way do not appear to alter either in colour or dimensions. The latter may be accounted for in this way, viz. that the contraction of the medium is entirely in thickness, and the pressure of the cover prevents any alteration taking place in the object laterally.

It is probable that some animalcules may be better shown if some moisture be allowed to remain in the medium, the evaporation from which may be stopped at any stage by filling round the edge of the cover with some gold-size varnish, or even boiled linseed-oil.

For many delicate objects this has a great advantage over Canada balsam, in not possessing the high refractive power of that substance; and the minute hairs and other parts of insects, that are quite obliterated with the balsam, are beautifully shown in this medium."

Glycerine was introduced by Mr. Warington, as a preservative fluid for mounting organic substances in. The method adopted by him in the employment of glycerine, is simply to mount the object in the manner it is usually performed when spirit of wine or creosote-water is used as a medium, and having covered the immersed object with the thin glass, and removed all excess of liquid, to cement the margin with a coating of shell-lac varnish; the one usually employed consists of the ordinary black sealing-wax dissolved in rectified spirit of wine. Care must be taken during this operation to maintain the slider in a flat position, until the varnish has become dry from the evaporation of the spirit, and also until a sufficient number of coatings or layers of the varnish have been applied to render the subject perfectly secure, and prevent any escape of the fluid. Gold-size or copal dissolved in oil of lavender may be employed to effect the same purpose; and the second and third coatings may, with advantage, consist of

either of these, which yield a tough varnish above the lac, which is otherwise liable to become brittle.

The glycerine may be used in its concentrated form or treacly state, or it may be diluted with distilled water to any required extent, according to the object of the operator, and the subject to be mounted; if there be extremely fine markings on the subject, it is better to add about four or five times its volume of water, as otherwise the thick fluid may prevent these from being so sharply defined as may be desired. "I have," adds Mr. Warington, "a number of slides of *Desmidiææ*, which have been mounted from four to ten months by this means, and they have kept excellently. The glycerine may also be used with the addition of a small portion of culinary salt, corrosive sublimate, creosote, or spirit of wine, if considered desirable."

Castor-oil may be used as a medium for mounting crystals of salts and other objects. The object required to be mounted is placed on the slider in its dry state, or deposited wet and allowed to dry; or if in solution, a drop of the liquid is to be placed on the slip of glass, and allowed to crystallise by spontaneous evaporation; in the latter case I prefer taking a drop of a warm saturated solution of the salt required, and when a good group of well-defined crystals has been obtained, to break through the marginal ring of crystalline deposit with a small point of wood, and carefully conduct off the uncrystallised portion or mother-liquor to the extremity of the slide, at the same time placing it in a vertical position to drain until it is dry. A small quantity of castor-oil is to be next carefully dropped on the subject, and guided over the field with the point of a needle; in this way it readily displaces the air and occupies the most minute cavities. After a short time the upper glass is to be placed on the surface, taking care to lower it gradually so as to exclude the air; if the field is too full of oil, the excess may be removed by a small piece of bibulous paper; and if, on the contrary, sufficient oil has not been used, an additional portion can be readily introduced by the capillary action between the glasses. I mention these points of practical manipulation, because on them the success of the operation may often depend, as it must be evident, that in the first case the excess would prevent the cell from being properly sealed by the varnish, and in the latter it would be drawn into the field, and the whole operation spoiled. The shell-lac varnish is then to be used as the cementing medium in the same way as has been described, and with the same precautions. I may also observe, that this varnish cannot be replaced by either of the others, as it is actually necessary (and this should always be borne in mind) that there should exist no

affinity between the fluid in the cell and the varnish used to seal it permanently. Hundreds of excellent objects have been lost from this cause, and much valuable time and labour thrown away.

The reason why oil was selected by Mr. Warington for this purpose arose from want of action on most crystalline salts, many of which could not be preserved uninjured in any other medium. Castor-oil was chosen in consequence of its not depositing a crystalline stearin by reduction of temperature, as is the case with most oils, and even in some specimens of this material; it therefore requires to be carefully examined in this respect before it is employed. In the same year I used this medium as a mounting-fluid for minute *fungi* and *pediculi* with complete success.

Mr. Goadby has succeeded in supplying to microscopists a ready, cheap, and effectual means for mounting animal structures with the greatest possible ease and security. The following are his formulæ:

Take for No. 1 solution, bay salt, 4 oz.; alum, 2 oz.; corrosive sublimate 2 grains; boiling-water, 1 quart: mix. For No. 2 solution, bay salt, 4 oz.; alum, 2 oz.; corrosive sublimate, 4 grs.; boiling-water, 2 quarts: mix.

The No. 1 is too strong for most purposes, and should only be employed where great astringency is needed to give form and support to very delicate structures. No. 2 is best adapted for permanent preparation; but neither should be used in the preservation of animals containing carbonate of lime (all the mollusca), as the alum becomes decomposed, sulphate of lime is precipitated, and the preparation spoiled. For such use the following:

Bay salt, 8 oz.; corrosive sublimate, 2 grs.; water, 1 quart: mix.

The corrosive sublimate is used to prevent the growth of vegetation in the fluid; but as this salt possesses the property of coagulating albumen, these solutions cannot be used in the preservation of ova, or when it is desired to maintain the transparency of certain tissues, such as the cellular tissue, the white corpuscles of the blood, &c.

Mr. Goadby's method of making *marine*-glue for cementing cells is as follows: dissolve separately equal parts of shell-lac and India-rubber in coal or mineral naphtha, and afterwards mix the solutions carefully by the application of heat. It may be rendered thinner by the addition of more naphtha, and is always readily dissolved by naphtha, ether, or solution of potash, when it becomes hard or dry in our stock-pots.

Professor Quekett's preservative fluid is made of creosote, $1\frac{1}{2}$ drs.; wood naphtha, 3 ounces; distilled water, 32 ounces; chalk, as much as

may be required to make the creosote and naphtha into a paste before adding the water: let it stand by a day or two, then filter through white blotting-paper. Add to this solution two small lumps of camphor, and stand it by for a week. At the end of that time filter again through clean blotting-paper. This is an excellent fluid for mounting all vegetable substances in, and many of the more delicate animal tissues keep very well in it; it has also the advantage of not dissolving the cement used in making the cells.

INJECTING MINUTE VESSELS.

For minute injections the most essential instrument is a proper syringe. This is usually made of brass, of such a size that the top of the thumb may press on the button at the top of the piston-rod when drawn out, while the body is supported between the two fingers. Fig. 65 represents the syringe: *a* is a cylindrical brass body, with a screw at the top for the purpose of firmly screwing down the cover *b*, after the piston *c* is introduced into it; this is rendered airtight with leather; the bottom of the syringe *d* also unscrews for the convenience of cleaning; *e* is a stop-cock, on the end of which another stop-cock *f* fits accurately; and on the end of this either of the small pipes *g*, which are of different sizes, may be fixed. The transverse wires across the pipes are intended to secure them more tightly to the vessels into which they may be inserted with thread, so that they may not slip out. In addition to the syringe, a large tin vessel, to contain hot water, with two or three lesser ones fixed in it, for the injections, will be found useful.

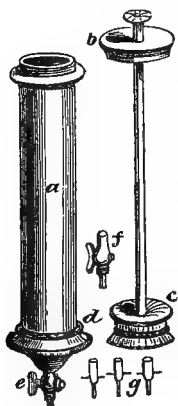

fig. 65.

To prepare the material for injecting:—Take of the finest and most transparent glue one pound, break it into small pieces, put it into an earthen pot, and pour on it three pints of cold water; let it stand twenty-four hours, stirring it now and then with a stick; then set it over a slow fire for half an hour, or until all the pieces are perfectly dissolved; skim off the froth from the surface, and strain through a flannel for use. Isinglass and cuttings of parchment make an excellent size, and are preferable for very particular injections.

The size thus prepared may be coloured with any of the following:

For <i>Red.</i>	To a pint of size, add 2 oz. of Chinese vermilion.
„ <i>Yellow.</i>	„ „ 2½ oz. of chrome-yellow.
„ <i>White.</i>	„ „ 3½ oz. of flake-white.
„ <i>Blue.</i>	„ „ 6 oz. of fine blue smalts.

It is necessary to remember, that whatever colouring matter is employed must be very finely levigated before it is mixed with the injection. This is a matter of great importance; for a small lump or mass of colour, dirt, &c. will clog the minute vessels, so that the injection will not pass into them, and the object will be defeated. The mixture of size and colour should be frequently stirred, or the colouring matter will sink to the bottom. Respecting the choice of a proper subject for injecting, it may be remarked, that the injection will usually go furthest in young subjects; and the more the fluids have been exhausted during life, the greater will be the success of the injection.

To prepare the subject, the principal points to be aimed at are, to dissolve the fluids, empty the vessels of them, relax the solids, and prevent the injection from coagulating too soon. For this purpose it is necessary to place the animal, or part to be injected, in warm water, as hot as the operator's hand will bear. This should be kept at nearly the same temperature for some time by occasionally adding hot water. The length of time required is in proportion to the size of the part and the amount of its rigidity. Ruysch (from whom the art of injecting has been called the Ruyschian art) recommends a previous maceration for a day or two in cold water.

The size must always be kept hot with the aid of warm water; for if a naked fire be used, there is danger of burning it. The size may be placed in a vessel which can be heated by standing it in a common tin saucepan of hot water. A convenient form of apparatus for melting the size, and afterwards keeping it at a proper temperature, is shown in fig. 66. It consists merely of a water-bath, in which the cans containing the injecting fluid can be kept hot, and their contents protected from dust by means of their covers. A small apparatus of this kind could be

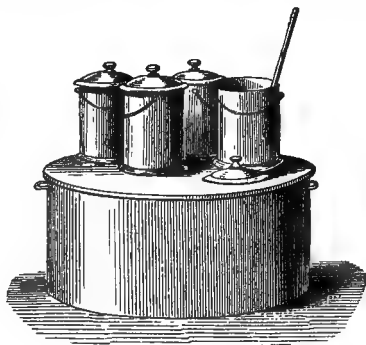

fig. 66.

made by any tin-worker, and fitted over a gas jet to stand on the table.

The operator should be provided with several pairs of strong forceps, for seizing the vessel or stopping the escape of injection. A small needle, fig. 67, will be found useful for passing the thread round the vessel into which the injecting pipe is to be inserted. Where the vessels are large, a needle commonly known as an aneurism needle answers the purpose very well. The thickness of thread must vary according to the size of the vessel. The silk used by surgeons will be found the best adapted for the purpose, and not too thin, or it may cut through the vessel.



fig. 67.

When the size and the subject have both been properly prepared, have the injection as hot as the fingers can well bear. One of the pipes *g*, fig. 65, must then be placed in the largest artery of the part, and made secure by tying. Put the stop-cock *f* into the open end of the pipe *e*, and it is then ready to receive the injection from successive applications to the syringe *a*, leaving sufficient space only for the piston *c*. The injection should be thrown in by a very steady and gentle pressure on the end of the piston-rod. The resistance of the vessels, when nearly full, is often considerable; but it must not be overcome by violent pressure with the syringe. When as much injection is passed as may be thought advisable, the preparation may be left (with the stop-cock closed in the pipe) for twenty-four hours, when more material may be thrown in.

As the method of injecting the minute capillaries with coloured size is often attended with doubtful success, various other plans have been proposed. Ruysch's method, according to Rigerius, was to employ melted tallow coloured with vermilion, to which in the summer a little white wax was added. A material used by some is made of resin and tallow: take of each two ounces, melted and strained through linen, to which add three ounces of vermilion or finely ground indigo, first well rubbed with eight ounces of turpentine varnish. Monro recommended coloured oil of turpentine for the small vessels; after the use of which, he threw in the common coarse injection.

Professor Breschet frequently employed with success milk, isinglass, the alcoholic solution of gum-lac, spirit varnish, and spirit of turpentine; but he highly commends the colouring matter extracted from Campeachy, Fernambone, or Sandal woods. He says: "The colouring matter of Campeachy wood easily dissolves in water and in

alcohol; it is so penetrating that it becomes rapidly spread through the vascular net-works. The sole inconvenience of this kind of injection is, that it cannot be made to distend any except most delicate vessels, and that its ready penetration does not admit of distinguishing between arteries, veins, and lymphatics." He also recommends a solution of caoutchouc.

Another process, which may be termed the chemical process, was published in the *Comptes Rendus*, 1841, as the invention of M. Doyers. According to this, an aqueous solution of bichromate of potass, 1048 grains to two pints of water, is propelled into the vessels; and after a short time, in the same manner and in the same vessels, an aqueous solution of acetate of lead, 2000 grains to a pint of water, is injected. This is an excellent method, as the material is quite fluid, and the precipitation of the chromate of lead which takes place in the vessels themselves gives a fine sulphur-yellow colour. Mr. Topping prepares many fine injections in this way.

Mr. Goadby has improved upon the process last named by uniting to the chemical solutions a portion of gelatine, as follows:

Saturated solution of bichromate of potash, 8 fluid ounces; water, 8 ounces; gelatine, 2 ounces.

Saturated solution of acetate of lead, 8 fluid ounces; water, 8 ounces; gelatine, 2 ounces.

The majority of preparations thus injected require to be dried and mounted in Canada balsam. Each preparation, when placed on a slip of glass, will necessarily possess more or less of the coloured infiltrated gelatine (by this is meant the gelatine coloured by the blood, which, together with the acetate of potash resulting from the chemical decomposition, may have transuded through the coats of the vessel,) which, when dry, forms, together with the different shades of the chromate of lead, beautiful objects, possessing depth and richness of colour. The gelatine also separates and defines the different layers of vessels: the arteries are always readily distinguishable by the purity and brightness of the chromate of lead within them, while the veins are detected by the altered colour imparted by the blood.

Those preparations which require to be kept wet can be preserved perfectly in Mr. Goadby's No. 2 fluid, specific gravity 1,100; the No. 1 fluid destroys them.

I would recommend that the slips of glass employed for the dry preparation be instantly inscribed with the name of the preparation, written with a diamond; for, when dry, it is difficult to recognise one preparation from the other, until the operator's eye be educated to

the effects of this chemico-gelatinous injection. Where so much wet abounds, gummed paper is apt to come off.

When dry, it is sufficient, for the purpose of brief examination by the microscope, to wet the surface of a preparation with clean oil of turpentine; immediately after examination, it should be put away carefully in a box, to keep it from the dust, until it can be mounted in Canada balsam.

The bichromate of potash is greatly superior in colour to the chromate, which yields too pale a yellow; and subsequent experience has proved that the acetate of potash frequently effects its liberation by destruction of the capillaries, and this even long after the preparations have been mounted in Canada balsam; perhaps this may be owing to some chemical action of the acetate of potash upon them.

I would suggest the substitution of the *nitrate* for the *acetate* of lead, as we should then have, in the liberated nitrate of potash, a valuable auxiliary in the process of preservation.

Although highly desirable, as the demonstrator of the capillaries of *normal* tissues, I do not think this kind of injection fitted for morbid preparations; the infiltrated gelatine producing appearances of a puzzling kind, and calculated to mislead the pathologist.

In preparing portions of dried well-injected skin for examination by the microscope, I have tried the effect of dilute nitric acid as a corrodent with very good results. But, probably, liquor potassa would have answered this purpose better.

When size-injection is to be employed, coloured either with vermilion or the chromate of lead, the animal should be previously prepared by bleeding, to empty the vessels; for if they be filled with coagulated blood, it is quite impossible to transmit even size, to say nothing of the colouring matter. Hence the difficulty of procuring good injections of the human subject.

But with the chemico-gelatinous injections no such preparation is necessary; and success should always be certain, for the potash liquefies the blood, while constant and long-continued pressure by the syringe drives it through the parietes of the vessel into the cellular tissue. The large quantity of infiltrated blood—the invariable concomitant of Mr. Goadby's process—characterises it from all other modes of injecting, and is a distinctive feature of the preparations.

Still another plan has been suggested. It consists in adding a quantity of sulphuric ether to the finely levigated colouring matter, which is also first ground or mixed with linseed-oil, in the manner employed by painters. Upon this plan (as well as upon the last named)

some beautiful injections of the smallest capillaries are made; but sometimes it is a failure, owing to the too rapid evaporation of the ether, and the clogging up of the vessels from the early deposition of the solid colouring matter. Perhaps a solution of gum-mastic in ether, coloured with fine vermilion, will answer the purpose better. Prussian blue, mixed with an equal quantity of oxalic acid, finely powdered and dissolved in water, which should be gradually added, and afterwards the strong size solution, forms a very beautiful injection for the capillaries of the lungs.

A fœtus may be injected by the umbilical vein; the head, by the carotids; the liver, mucous membrane of the intestines, &c. by the portal vein; an extremity by the principal artery, &c.

In those cases in which we desire to examine the arrangement of the different systems of vessels in the same tissue or animal, it becomes necessary to use a distinct colouring matter for each system. M. Robin recommends blue for the arteries, yellow for the veins, red for the portal veins, and white for the bile ducts, or renal tubes.

Before portions of injected preparations are put up in the glass-cells, they should be allowed to harden some time in the preservative fluid they are intended to be kept in; clean sections can then be made with a sharp knife, and slightly washed in fresh fluid. If it is intended to preserve them in Canada balsam, it will be found advantageous to spread them out to dry, and wet the surface with a drop of turpentine before they are finally immersed in the balsam: a thin glass cover must be pressed down on the injection.

Many parts, after injection, require to be macerated in water, or corroded by dilute muriatic acid, &c., in order to exhibit the ramifications of the small vessels. They should be very carefully handled, or moved, in the macerating liquor, as the slightest force may break the vessels. When corroded, the pulpy flesh is to be carefully washed away, by placing it under a stream of water, flowing very slowly, or by the use of a syringe with water.

The lymphatics are now usually injected with coloured material instead of quicksilver, as formerly. M. Rusconi employed a small silver syringe, together with a kind of trocar, of which the canula is formed from the quill of the wing-feather of the quail or partridge,—the trocar being a tolerably large-sized surgical needle, the point having three facets. When desirous of injecting the lymphatic system of a lizard, tortoise, &c., he says: “I seize with a small pair of forceps the mesentery, close to the vertebral column, where the reservoir of the chyle is situated, and I introduce into it the point of the trocar; I

then retain the quill, and withdraw the needle from the tube. I then seize with the small forceps the quill, and introduce into it the small extremity of the syringe; and push the piston with a force always decreasing."

By carefully following out these directions, any one, after a little practice, will be enabled to succeed in making many useful and valuable preparations. Injections are best viewed by the aid of the Leiberkuhn, or under a condensed light with a one or two inch object-glass. For Harting's process of injecting, see translations in the *Edinburgh Monthly Journal*, 1852.

CHEMICAL RE-AGENTS.

Dr. Schacht recommends the following chemical re-agents and preservative fluids for microscopic uses :

1. *Alcohol*, principally for the removal of air from sections of wood and other preparations; also as a solvent for certain colouring matters.

2. *Æther*, chiefly as a solvent for resins, fatty and other essential oils, &c.; also useful for the removal of air.

3. *Solution of Caustic Potass*, as a solvent for fatty matters; also of use occasionally in consequence of its action upon the rest of the cell-contents and thickening layers. This solution acts best upon being heated.

4. *Solution of Iodine* (iodine one grain, iodide of potassium three grains, distilled water one ounce) for the coloration of the cell-membrane and of the cell-contents.

5. *Concentrated Sulphuric Acid*, employed chiefly in the examination of pollen and spores.

6. *Diluted Sulphuric Acid* (three parts acid, one part water), for the coloration of cells previously immersed in the iodine solution. The preparation is first moistened with the iodine solution, which is afterwards removed with a hair pencil, and a drop of sulphuric acid added by means of a glass rod; the preparation is then immediately covered with a piece of glass. The action of the sulphuric acid and iodine, as well as that of the iodised chloride of zinc solution, is not always uniform throughout the whole surface of the preparation. The colour is more intense where the mixture is more concentrated; it frequently happens that many spots remain uncoloured. The colour changes after some time, the blue being frequently changed into red after twenty-four hours.

7. *A Solution of Chloride of Zinc, Iodine, and Iodide of Potassium*. A drop of this compound solution, added to a preparation placed in a little water, produces the same colour as iodine and sulphuric acid.

This solution, which was first proposed and employed by Professor Schultz of Rostock, is more convenient in its application than iodine and sulphuric acid, and performs nearly the same services, while it does not, like the sulphuric acid, destroy the tissues to which it is applied. It is prepared by dissolving zinc in hydrochloric acid; the solution is then saturated with iodide of potassium: more iodine is to be added if necessary, and the solution diluted with water.

8. *Nitric Acid*, or what is better, chlorate of potass and nitric acid, as an agent to effect the isolation of cells. The mode of employing this means, also discovered by Professor Schultz, is as follows:—

The object, a thin section of wood for instance, is introduced, with an equal bulk of chloride, or chlorate of potass, into a long and moderately wide tube, and as much nitric acid as will at least cover the whole.

The tube is then warmed over a spirit-lamp; a copious evolution of gas takes place, upon which the tube is removed from the flame, and the action of the oxidising agent allowed to continue for two or three minutes. The contents of the tube are then poured into a watch-glass with water, from which the slightly cohering particles are collected and placed in a tube, and again boiled in alcohol as long as any colour is communicated.

They are again boiled in a little water. The cells may now be isolated under the simple microscope by means of needles. The boiling with nitric acid and chlorate of potass should never be carried on in the same room with the microscope, the glasses of which may suffer injury from the vapours.

Thin sections of vegetable tissue are warmed for half a minute, or a minute, in a watch-glass: boiling is here unnecessary. The section is taken out, and treated with water in a watch-glass.

9. *Oil of Lemons*, or any other essential oil, for the investigation of pollen and spores.

10. A moderately strong solution of *Muriate of Lime* (one part dry muriate of lime and three parts distilled water), for the preservation of microscopical preparations. This is applicable to most things, even for the most delicate preparations, excepting starch. If it is desired to keep a preparation, which is not to be retained permanently, for some days, a small drop of the solution may be placed upon it, and the whole put under a glass cover to keep it from dust.

Lastly may be enumerated a pretty strong solution of *Carbonate of Soda* and also of *Acetic Acid*; which latter, however, is more especially useful in the investigation of animal tissues.

To the above may be added a test for protein compounds. This

test is composed of sugar and sulphuric acid, and is thus employed: A thin section or portion of the tissue to be examined is placed in a drop of simple syrup. This is then removed by means of a hair pencil, and a drop of the diluted sulphuric acid added; the red colour usually does not appear until after the lapse of about ten minutes.

In making thin sections of tissues, it is recommended that, in the case of objects, the consistence of which differs in different parts, the section should be carried from the harder into the softer portion; also, in making a thin section of a very minute yielding substance, to enclose it between two pieces of cork, and to slice the whole together. It is also useful sometimes to saturate the object with mucilage, which is to be allowed to dry slowly; in this way very delicate tissues may be sliced, or otherwise divided without injury, and with great facility.

The preceding observations must be received with caution; a very useful warning having been recently given by Dr. Parkes in reference to unusual crystalline forms he has found some of these re-agents to assume, when in use, under the microscope. Without a knowledge of this singular fact, and a perfect recognition of the crystalline forms, errors in micro-chemical research cannot but occur. For example, if a drop of liquor potassæ be allowed to evaporate on a slip of glass, crystals appear, chiefly six-sided tables, precisely like cystine; when in quantity, they are often crowded together as the cystine plates are, and sometimes exhibit a similar nucleus-like body in their centres. These crystals do not arise from the presence of impurities; at least perfectly pure potash exhibits the same phenomenon.

He also states that the form of the crystals of acetate of potash varies according to the strength of the acid out of which it crystallises; and when formed out of strong acid, very much resembles that of the crystals of uric acid; for, mixed up with other forms, long dagger-like or lancet-shaped crystals are seen, which might well deceive us.

It may also be noticed in this place, that Majendie has lately pointed out that in certain albuminous mixtures iodine loses the property of colouring starch blue. This difficulty must be got rid of before iodine can be used without fear in micro-chemistry.

Preparation and Preservation of Algae, &c.—Mr. Ralf's excellent directions for making preparations of the algae for the microscope are as follows: "First to obtain a fluid which shall preserve the plant as little altered as possible from its appearance when living; and secondly, to adopt the best means for preventing the escape of this fluid after the object has been mounted in it. With respect to the first point, the fluid which I have found to answer best is made in the following

way : to sixteen parts of distilled water add one part of rectified spirits of wine, and a few drops of *creosote*, sufficient to saturate it ; stir in a small quantity of prepared chalk, and then filter ; with this fluid mix an equal measure of camphor-water (water saturated with camphor) ; and before using strain off through a piece of fine linen.

This fluid I do not find to alter the appearance of the endochrome of algæ more than distilled water alone does after some time ; and there is certainly less probability of confervoid filaments making their appearance in the preparations ; and there would seem to be nothing to prevent such a growth from taking place, when the object is mounted in water only, provided a germ of one of these minute plants happen to be present, as well as a small quantity of free carbonic acid.

Fluids containing a larger quantity of spirits of wine, and consequently of *creosote* also, than the one of which I have given the formula, produce a greater change in the appearance of the endochrome.

My method of making cells in which to mount preparations of algæ is as follows : some objects require very shallow, and others somewhat deeper cells. The former may be made with a mixture of jaspers' gold size and litharge, to which (if a dark colour is preferred) a small quantity of lamp-black can be added. These materials should be rubbed up together with a painter's muller, and the mixture laid on the slips of glass with a camel-hair pencil as expeditiously as possible, since it quickly becomes hard ; so that it is expedient to make but a small quantity at a time. For the deeper cells marine-glue answers extremely well, provided it is not too soft. It must be melted and dropped upon the slip of glass ; then flattened, whilst warm, with a piece of wet glass, and what is superfluous cut away with a knife, so as to leave only the walls of the cell ; these, if they have become loosened, may be made firm again by warming the under surface of the slip of glass. The surface of the cells must be made quite flat ; which can be easily done by rubbing them upon a wet piece of smooth marble, covered with the finest emery-powder.

When about to mount a preparation, a very thin layer of gold-size must be put upon the wall of the cell, as well as on the edge of the piece of thin glass which is to cover it ; before this is quite dry, the fluid with the object is to be put into the cell, and the cover of thin glass slowly laid upon it, beginning at one end ; gentle pressure must then be used to squeeze out the superfluous fluid ; and, after carefully wiping the slide dry, a thin coat of gold-size should be applied round the edge of the cell, and a second coat so soon as the first is dry ; a thin coat or two of black sealing-wax varnish may then be put

on with advantage, in order to prevent effectually the admission of air into the cell, or the escape of fluid out of it.”*

I would remark, that the gold-size employed should be of the consistence of treacle; when purchased, it is usually too fluid, and should be exposed for some time in an open vessel; a process which renders it fit for use. In mounting the *Desmidiæ*, great attention is necessary to exclude air-bubbles, which cannot be avoided unless the fluid completely fills the cells; and also not to use too much fluid, as in this case the smaller species will often be washed away on the escape of the superfluous portion. As the cells cannot be sealed whilst any moisture remains on their edge, it should be removed by blotting-paper, in preference to any other mode. A thin description of glass is manufactured expressly for the purpose of covering specimens when mounted.

The rarer species of *Desmidiæ* are frequently scattered amongst decayed vegetable matter, so that it is difficult to procure good specimens for mounting. In such cases, a small portion of the mass should be mixed with a little of the creosote fluid, and stirred briskly with a needle. After this has been done, the *Desmidiæ* will sink to the bottom, when the refuse should be carefully removed. Successive portions having been thus treated, specimens will at length be procured sufficiently free from foreign matter. Even in ordinary circumstances, if a small extra quantity of fluid be placed in the cell, and the slide gently inclined, most of the dirt can be removed by a needle before the cell is closed; which process will materially increase the beauty of the preparation.

If the cells are insufficiently baked, the japan occasionally peels off the glass after the specimen has been mounted for some time. To obviate this inconvenience, Mr. Jenner previously heats the cell, with much caution, over a rushlight, until the japan becomes of a dark colour, and vapour ceases to arise from it. When *gold-size* is used for closing the cell, the intrusion of some of it frequently destroys valuable specimens, whatever care may be taken. Mr. Jenner has therefore relinquished it, and now employs a varnish made of coarsely comminuted purified *shell-lac* or translucent sealing-wax, to which is added *rectified spirits of wine*, in sufficient quantity to cover it.

This varnish will be ready for use in about twelve hours: when it is too thick, a little more spirit should be added. Mr. Jenner applies three coats of this varnish, and about a week afterwards a fourth, composed of *japan varnish* or *gold-size*.

* Mr. Penney, of 251 Tottenham Court Road, supplies an excellent varnish, called “Coachmaker’s Black.”

I have tried this method extensively, and have never found my specimens spoiled by the varnish insinuating itself into the cell. This process requires less time, and herein it possesses another great advantage over the gold-size method ; for the second coat being applied within half an hour, the risk of admitting air into the cell is much diminished. To preserve the brush in a fit state, it should always be cleaned with spirits of wine whenever it has been used.

The fluid which Mr. Topping uses for mounting consists of one ounce of rectified spirit to five ounces of distilled water ; this he thinks superior to any other combination. To preserve delicate colours, however, he prefers to use a solution of acetate of alumina, one ounce of the acetate to four ounces of distilled water : of other solutions he says, that they tend to destroy the colouring matter of delicate objects, and ultimately spoil them by rendering them opaque.

ON COLLECTING OBJECTS.

The following hints for collecting objects for microscopical examination, by G. Shadbolt, Esq., are exceedingly useful and valuable to the microscopist.

“ Having procured a good microscope, it is often a source of perplexity to the novice to obtain a sufficient supply of objects on which to exercise his powers.

Rivers, brooks, springs, fountains, ponds, marshes, bogs, and rocks by the sea-side, are all localities that may be expected to be productive ; some being more prolific than others, and the species obtained differing, of course, in general, to a certain extent, according to the habitat.

On considering the nature of some of the places indicated, it will be apparent that, in order to spend a day in collecting with any comfort, it will be necessary to make some provision for keeping the feet dry, for which a pair of India-rubber goloshes will answer, or better still, a pair of waterproof fishing-boots ; but without one or other the work is by no means pleasant.

A dozen or two of small bottles made of glass-tubing, about half an inch in diameter, and without necks, and from one to two inches in length, are the most convenient depositories for the specimens, if intended ultimately for mounting ; and it is advisable also to take two or three wide-mouthed bottles of a larger size, holding from one to two fluid-ounces, an old iron spoon, a tin box, some pieces of linen or calico, two or three inches square, a piece of string, a slip or two of

glass, with the edges ground, such as are used for mounting objects ; and lastly, a good and pretty powerful hand-magnifier. Two Coddington lenses, mounted in one frame of about half an inch, and one-tenth of an inch in focal power, are specially convenient.

Perhaps it will be as well, in pointing out a few localities, to describe some that I have actually visited, with the means of access, and the appearance of the various species, *en masse*, that I have met with.

Swanscombe Salt-marsh will be found well worth a visit ; and it can be reached by steam-boat or railway from London-bridge to Northfleet. On quitting the railway-station, make towards the almshouses on the top of the hill ; and arriving at the road, turn to the left, descend the hill, and cross a sort of bridge over a somewhat insignificant stream. Continue along the main-road a little farther, to a point where it begins to ascend again, and diverges to the left towards the railway ; here quit it, taking your course along an obscure road, nearly in a direct line with the main one ; passing a windmill on the right hand, and continuing until you arrive at another still more obscure road, turning off to the right ; which road appears as if made of the mud dredged from the bottom of the river, and partially hardened. This is Swanscombe Salt-marsh ; and the road just described leads towards Broad Ness Beacon. On either side is a sort of ditch ; one containing salt or very brackish water, the other filled with a sort of black mud, about the consistence of cream, the surface being in parts of a slaty grey, with little patches here and there of a most *brilliant brown colour*, glistening in the sunshine, and presenting a striking contrast to the sombre shade. By carefully insinuating the end of one of the slips of glass under this brilliant brown substance, and raising it gently, it can be examined with the Coddington ; and it will probably be found to consist of myriads of specimens of *Pleurosigma* (*navicula* of Ehrenberg) *angulatum*, or *balticum*, or some other species of this genus. The iron spoon is now useful, as by its aid the brown stratum, with little or no mud, can be skimmed off and bottled for future examination. On the surface of the water in the other ditch may be noticed a floating mass of a *dark olive colour*, which to the touch feels not unlike a lump of the curd of milk, and consists of *Cyclotella menighiniana*, and a *surirella* or two embedded in a mass of *Spirulina hutchinsia* ; and another mass of floating weed, which feels harsh to the touch, proceeding from a quantity of a synedra, closely investing a filamentous alga ; and elsewhere *Meloseira nummuloides* (*gallionella* of Ehrenberg).

In a trench by the *sea-wall*, as it is termed, is a mass of brown

matter of a shade somewhat different to any hitherto observed, adhering to some of the parts of the trench, being partially submerged, and having a somewhat tremulous motion on agitating the water. This is a species of *Schizonema*; and it consists of a quantity of gelatinous hollow filaments filled with an immense number of bright-brown shuttle-shaped bodies, like very minute *naviculæ*.

It is not necessary to be particular about collecting the specimen free from mud, as the filaments are so tough that the mud can be readily washed away by shaking the whole violently in a bottle of water, and pouring off the mud, without at all injuring the specimen. The *Amphisporium alatum* communicates a somewhat frothy appearance to the otherwise clear water, and to get any quantity of this requires a little management; but by skimming the surface with the spoon, and using one of the larger bottles, an abundance may readily be obtained. Between the sea-wall and the river the marsh is intersected in every direction with a number of meandering creeks, being in some places eight to ten feet deep, though in others quite shallow; but it is exceedingly difficult to make one's way amongst them, and I have never found them so prolific any where, on the few occasions of my visiting the place, as in the parts more away from the influence of the tide. It will be observed, that the brilliant brown colour, of a deep but bright cinnamon tint, is one of the best indications of the presence of *diatomaceæ*; and though this is by no means universal, the variation is most frequently dependent upon the presence of something which qualifies the tint. The peculiarity of the colour is due to the endochrome contained in the frustule; and this must in general be got rid of before the beautiful and delicate marking can be made out. But it is highly advantageous and instructive to view them in a living state; and this should be done as soon as possible after reaching home with all specimens procured from salt-water localities, as they rapidly putrefy in confinement, and emit a most disgusting odour, not unlike that arising from a box of inferior congreve-matches.

Washing in fresh water, and then immersing in creosote water, preserves many of the species in a very natural-looking manner; but they are killed by the fresh water, and the endochrome becomes much condensed in the *Pleurosigmata* and some other species. The addition of spirits quite spoils the appearance of the frustules, as it dissolves the endochrome.

There is another salt-marsh a little farther down the same railway, at Higham, which it would be well to explore.

The most favourable months for procuring *diatomaceæ*, are April,

May, September, and October ; but some species are found in perfection as early as February, and many as late as November, and a few at all times of the year.

There is a piece of boggy ground near Keston, beyond Bromley in Kent, where the river Ravensbourne takes its rise, where many interesting species of desmidiæ and other fresh-water algæ may be procured. From Bromley, walk on towards Keston, passing near Hayes Common and Bromley Common on the right. Continue for about another half-mile along the road, and then turn to the right hand ; pass the reservoirs, and approach an open space where there is a bog of about a quarter of a mile in extent ; and tending towards the right, make your way amongst heaths, ferns, mosses, and the beautiful *Drosera rotundifolia* (sun-dew), to the lower part of the little stream rippling through a sort of narrow trench in the *Sphagnum*, &c. By working your way *up* the stream, you avoid the inconvenience which would otherwise be experienced of the water being rendered turbid, in consequence of having to tread in the boggy ground.

In the centre of the little stream may be observed something of a pale pea-green colour flickering about in the current, which, on your attempting to grasp, most likely eludes you, and slips through the fingers, from being of a gelatinous nature. It consists of a hyaline substance, with a comparatively small quantity of a bright green endochrome, disposed in little branches, and this is the *Draparnaldia glomerata*.

Another object is a mass of green filaments, rather harsh to the touch, and very slippery. When viewed with a lens of moderate power, each filament is seen to be surrounded with several bands of green dots, looking like a ribbon twisted spirally, and may be recognised as *Zygnema nitidum*. In various parts there are other species of *zygnema*, *tyndaridea*, *mougeotia*, *mesocarpus*, and many others.

Keeping up the stream, and occasionally diverging a little on either side of it, amongst the miniature bays and pools formed by the sphagnum, on looking straight down into the water we shall probably see at the bottom a little mass of *jelly* of a *bright green*, studded with numerous brilliant bubbles of oxygen-gas. This is the general appearance of most of the *desmidiæ*, as *Micrasteias*, *Euastrum*, *Closterium*, *Cosmarium*, &c. The spoon is also a handy tool in this case, though, by practice, the finger will do nearly as well ; the chief difficulty arises when the specimen is brought to the surface of the water, it not being easy to get it out without losing a considerable portion of it.

Little pools in the bog, made by the footsteps of cattle, are par-

ticularly good spots to find *desmidiæ*, many species being in a very contracted space. The most prolific bog is at Tunbridge Wells, near a house known as Fisher's Castle, not far from Hurst Wood. There is also a good one at Esher, at a spot called West-End.

It must not be imagined that nothing can be obtained in this department of botany without going some distance from town; but assuredly only commoner and fewer species can be met with nearer home. At the West India Docks are *Synedra fasciculata*, *Gomphonema curvata*, *Diatoma elongatum*, *Diatoma vulgare*, *Surirella ovata*, &c.; and at this same place a few objects, not of the botanical class, as *Spongilla fluviatilis*, *Cordylophora lacustris*, *Alcyonella stagnorum*, &c., are obtainable in abundance in the autumn.

In the ornamental water in St. James's Park may be found, *Cocconeis lanceolatum*, and other species of this genus, *Gomphonema cristatum*, &c. Epping Forest, about the neighbourhood of Leytonstone, Snaresbrook, Wanstead, and Woodford Bridge, are also capital localities for the filamentous algæ, especially the last-named, where *Nitella translucens* and *Chara vulgaris* abound.*

On the north side of the Serpentine, Hyde Park, especially near the bridge, may be found:

Cymbella maculata.
Gomphonema cristatum.
Scenedesmus quadricauda.
 „ *obliquus*.
Ankistrodesmus falcatus.
Pediastrum Heptactys.
Cocconeis lanceolatum.
Amphora ovalis.

Cocconeis placentula.
Uvella hyalina.
Gallionella nummuloides.
Euastrum elegans.
Pixidula operculata.
Cladophora glomerata and *Sphaeroplea crispa*, two of the filamentous algæ.

Mr. Topping, of New Winchester Street, Pentonville, has furnished me with the following list of 100 interesting and popular objects prepared by him:

Tests:

Navicula angulata.
 „ *strigosa*.
 „ *formosum*.
 Scales of *Podura*.
 „ *Lepisma*.
 Hair of Indian bat.
 „ mouse.
 „ Larva of *Dermestes*.

Triceratium from Thames mud.
Arachnaydiscus.

Fos. Infusoria from Guano.
 Fos. infusoria, Barbadoes.
 „ Upper Bann, Ireland.
 „ Island of Mull.
 „ Tuscany.
 Infusoria from Thames mud.
 Spicules of *Gorgonia*.
 „ sponge.
 „ „ fresh water.
 Gemmules of a sponge.
 Section of shell—*Pinna*.
 „ „ crab.

* *Quarterly Journal of Microscopical Science*.

Section of shell—Haliotis.	Trans. sect. of human bone.
„ spine of Echinus.	„ bone of bird.
„ „ Cidaris.	„ „ fish.
_____	„ „ reptile.
Xanthidia in flint.	_____
Moss agate.	Blood of bird.
Limestone.	„ fish.
_____	„ reptile.
Fossil tooth of shark.	„ human.
„ fish.	_____
Fossil bone of whale.	Opaque : !
„ reptile.	Gold dust.
„ elk.	Fossil shells.
_____	Pollens.
Fossil wood (Exogen).	Fern spores.
„ (Endogen).	Needle antimony.
Sections of coal.	Avanturine.
Simple cellular tissue.	_____
Stellate tissue.	Polariscope :
Fibro-cellular tissue.	Selenite.
Spiral vessels.	Starch.
Hairs from leaf of Deutzia.	Hairs from leaf.
Seeds of a fern.	Embryo oysters.
Sections of fir.	Rhinoceros horn.
„ oak.	Hoof of horse.
„ mahogany.	Agate.
„ clematis.	Sandstone.
Petal of geranium.	Sulphate of Cadmium.
_____	Salicine.
Leaf insect.	Tartaric acid.
Flea.	Carbonate of lime.
Parasite of peacock.	_____
Skin of caterpillar.	Anatomical :
Wing of a butterfly.	Section of cartilage, showing the
Scales of ditto.	formation of the bone-cells.
Proboscis of blow-fly.	Muscle of mammalia.
Stomach of ditto.	„ reptile.
Foot of ditto.	„ bird.
Spiracles of Dytiscus.	„ fish.
Foot of Ophion.	_____
Proboscis of moth.	Injections of
_____	Human lung.
Tran. sects. of human hairs.	„ intestine.
„ hairs of elephant.	„ skin.
„ whalebone.	„ kidney.
Feather of bird.	„ stomach.
	„ muscle.
	„ section of finger.

This forms a very nice cabinet. Mr. S. Stevens, 24 Bloomsbury Street, London, supplies neatly mounted microscopic objects at 10s. 6d. per dozen in racked boxes.

THE CAMERA LUCIDA.

The Camera Lucida, fig. 68, was invented by Dr. Wollaston, in 1807 : it is a valuable addition to the microscope, for making drawings of structures, and for obtaining, with a micrometer, accurate measurements. It consists of a four-sided prism of glass, set in a brass frame or case, as represented in the figure annexed ; and by means of a short tube it is slipped over the front part of either of the eye-pieces, its cap having been previously removed. Mr. Ross attaches the prism, by two short supports, to a circular piece of brass at the end of the tube ; on this it can be slightly rotated, whilst the prism itself can also be turned up or down, by means of two screws with milled heads. So arranged, the camera

may be adapted to the eye-piece, the microscope having been previously placed in a horizontal position ; if the light be then reflected up through the compound body, an eye placed over the square hole in the frame of the prism will see the image of any object on the stage upon a sheet of white paper placed on the table immediately below it. But should it happen that the whole of the field of view is not well illuminated, then, either by revolving the circular plate or turning the prism upon the screws, the desired object will be effected. The chief difficulty in the use of this instrument is for the artist to be able to see, at one and the same time, the pencil and the image. To facilitate this in some measure, the one or two lenses below the prism will cause the rays from the paper and pencil to diverge at the same angle as those received from the prism, whereby both object and pencil may be seen with the same degree of distinctness.

Professor Quekett gives the following directions for using the Camera

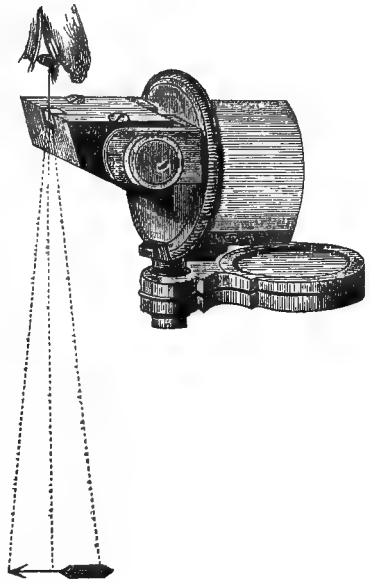

fig. 68.

Professor Quekett gives the following directions for using the Camera

Lucida with the microscope: The first step to be taken, after the object about to be drawn has been properly illuminated, adjusted, and brought into the centre of the field of view, is to place the compound body of the microscope in a horizontal position, and to fix it there. The cap of the eye-piece having been removed, the camera is to be slid on in its stead: if the prism is properly adjusted, a circle of white light, with the object within it, will be seen on a piece of white paper placed on the table immediately under the camera, when the eye of the observer is placed over the uncovered edge of the prism, and its axis directed towards the paper on the table. Should, however, the field of view be only in part illuminated, the prism must either be turned round on the eye-piece, or revolved on its axis, by the screws affixed to its frame-work, until the entire field is illuminated. The next step is to procure a hard, sharp-pointed pencil, which, in order to be well seen, may be blackened with ink round the point; the observer is then to bring his eye so near the edge of the prism that he may be able to see on the paper, at one and the same time, the pencil-point and the image of the object. When he has accomplished this, the pencil may be moved along the outline of the image, so as to trace it on the paper. However easy this may appear in description, it will be found very difficult in practice; and the observer must not be foiled in his first attempts, but must persevere until he accomplishes his purpose. Sometimes he will find that he can see the pencil-point, and all at once it disappears: this happens from the movement of the axis of the eye. The plan then is to keep the pencil upon the paper, and to move about the eye until the pencil is again seen, when the eye is to be kept steadfastly fixed on the same position until the entire outline is traced. It will be found the best plan for the beginner to employ at first an inch object-glass, and some object, such as a piece of moss, that has a well-defined outline, and to make many tracings, and examine how nearly they agree with each other; and when he has succeeded to his liking, he may then take a more complicated subject. If the operation is conducted by lamp-light, it will be found very advantageous not to illuminate the object too much, but rather to illuminate the paper on which the sketch is to be made, either by means of the lamp with the condensing lens, or a small taper placed near it. When the object is so complicated that too much time would be required for it to be completed at one sitting, the paper should be fixed to the table by a weight, or on a board by drawing-pins. An excellent plan to adopt is to fix the microscope on a piece of deal about two feet in length and one foot in breadth, and to pin the paper to the same; there will then be no risk

of the shifting of the paper, as, when the wood is moved, both microscope and paper will move with it. In all sketches made by the camera, certain things must be borne in mind: the eye, when once applied to it, should be kept steadily fixed in one position; and if the sketches are to be reserved for comparison with others, the distance between the paper and the camera should be always the same. A short rule or a piece of wood may be placed between the paper and the under-surface either of the compound body or the arm supporting it, in order to regulate the distance, as the size of the drawing made by the camera will depend upon the distance between it and the paper. It is also very desirable, before the camera is removed, to make a tracing in some part of the paper of two or more of the divisions of the stage micrometer, in order that they may form a guide to the measurement of all parts of the object. Some persons cover the whole of the drawing over with squares, to facilitate, not only the measurement, but in order that a larger or smaller drawing may be made from it than that given by the camera. It must be recollected that an accurate outline is the only thing the camera will give: the finishing of the picture will depend entirely upon the skill of the artist himself.

ON THE POLARISATION OF LIGHT AS APPLIED TO THE MICROSCOPE.

Huyghens and others having observed that a ray of light has not the same properties in every part of its circumference, compared it to a magnet, or a collection of magnets; and supposed that the minute particles of which it was said to be composed had different poles, which, when acted on in certain ways, arranged themselves in particular positions; and thence the term *polarisation*, a term having neither reference to cause nor effect. It is to Malus, however, who, in 1808, discovered polarisation by reflection, that we are indebted for the series of splendid phenomena which have since that period been developed; phenomena of such surpassing beauty as far to exceed any thing which can be presented to our eyes under the microscope. It has been truly observed by Sir David Brewster, that "the application of the principles of double refraction to the examination of structures is of the highest value. The chemist may perform the most dexterous analysis; the crystallographer may examine crystals by the nicest determination of their forms and cleavage; the anatomist or botanist may use the dissecting knife and microscope with the most exquisite skill; but there are still structures in the mineral, vegetable, and animal king-

doms which defy all such modes of examination, and which will yield only to the magical analysis of polarised light. A body which is quite transparent to the eye, and which might be judged as monotonous in structure as it is in aspect, will yet exhibit, under polarised light, the most exquisite organisation, and will display the result of new laws of combination which the imagination even could scarcely have conceived. In evidence of the utility of this agent in exploring mineral, vegetable, and animal structures, the extraordinary organisation of Apophyllite and Analcime may be referred to; also the symmetrical and figurate depositions of siliceous crystals in the epidermis of equisetaceous plants, and the wonderful variations of density in the crystalline lenses of the eyes of animals.

If we transmit a beam of the sun's light through a circular aperture into a darkened room, and if we reflect it from any crystallised or uncrystallised body, or transmit it through a thin plate of either of them, it will be reflected and transmitted in the very same manner, and with the same intensity, whether the surface of the body is held above or below the beam, or on the right side or left, provided that in all cases it falls upon the surface in the same manner; or, what amounts to the same thing, the beam of solar light has the same properties on all its sides; and this is true, whether it is white light as directly emitted from the sun, or from a candle or any burning or self-luminous body; and all such light is called *common* light. A section of such a beam of light will be a circle, like $a b c d$, fig. 69; and we shall

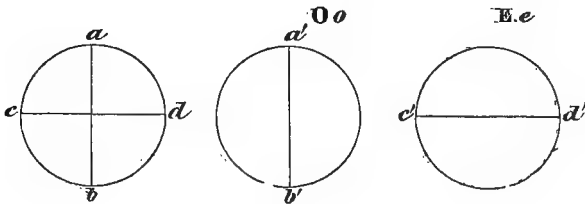

fig. 69

distinguish the section of a beam of common light by a circle with two diameters $a b$, $c d$, at right angles to each other.

If we now allow the same beam of light to fall upon a rhomb of Iceland spar, and examine the two circular beams, $O o$ $E e$, formed by double refraction, we shall find, 1st, that the beams $O o$ $E e$ have different properties on different sides, so that each of them differs in this respect from the beam of common light.

2d. That the beam $O o$ differs from $E e$ in nothing excepting that the former has the same properties at the sides $a' b'$ that the latter has at the sides c' and d' ; or in general, that the diameter of the beam, at the extremities of which the beam has similar properties, are at right angles to each other, as $a' b'$ and c' and d' for example.

These two beams, $O o$, $E e$, are therefore said to be *polarised*, or to be beams of *polarised* light, because they have sides or *poles* of different properties and planes passing through the lines $a b$, $c d$; or $a' b'$, $c' d'$, are said to be the *planes* of *polarisation* of each beam, because they have the same property, and one which no other plane passing through the beam possesses.

Now it is a curious fact, that if we cause the two polarised beams $O o$, $E e$ to be united into one, or if we produce them by a thin plate of Iceland spar, which is not capable of separating them, we obtain a beam which has exactly the same properties as the beam $a b c d$ of common light. Hence we infer that a beam of common light, $a b c d$, consists of *two* beams of polarised light, whose plane of polarisation, or whose diameters of similar properties are at right angles to one another. If $O o$ is laid above $E e$, it will produce a figure like $a b c d$; and we shall therefore represent common light by such a figure. If we were to place $O o$ above $E e$, so that the planes of polarisation $a' b'$ and $c' d'$ coincide, then we should have a beam of polarised light twice as luminous as either $O o$ or $E e$, and possessing exactly the same properties; for the lines of similar property in the one beam coincide with the lines of similar property in the other. Hence it follows that there are three ways of converting a beam of common light, $a b c d$, into a beam or beams of polarised light.

1st. We may separate the beam of common light, $a b c d$, into its component parts $O o$ and $E e$. 2d. We may turn round the planes of polarisation, $a b c d$, till they coincide or are parallel to each other. 3d. We may absorb or stop one of the beams, and leave the other, which will consequently be in a state of polarisation.*

The first of these methods of producing polarised light is that in which we employ a doubly reflecting crystal, which was first discovered to exist in a transparent mineral substance called *Iceland spar*, *calcareous spar*, or *carbonate of lime*. This substance is admirably adapted for exhibiting this phenomenon, and is the one generally used by microscopists. Iceland spar is composed of fifty-six parts of lime and forty-four parts of carbonic acid; it is found in various shapes in almost all countries; but whether found in crystals or in masses, we

* Brewster's *Optics*.

can always cleave it or split it into shapes represented by fig. 70, which is called a rhomb of Iceland spar, a solid bounded by six equal and similar rhomboidal surfaces, whose sides are parallel, and whose angles $b a c$, $a c d$, are $101^{\circ} 55'$ and $78^{\circ} 5'$. The line $a x$, called the *axis of the rhomb* or of the crystal, is equally inclined to each of the six faces at an angle of $45^{\circ} 23'$. It is very transparent, and generally colourless. Its natural faces when it is split are commonly even and perfectly polished ;

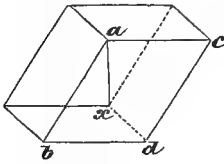

fig. 70.

but when they are not so, we may by a new cleavage replace the imperfect face by a better one, or we may grind and polish an imperfect face.

It is found that in all bodies where there seems to be a regularity of structure, as salts, crystallised minerals, on light passing through them it is divided into two distinct pencils. If we take a crystal of Iceland spar, and look at a black line or dot on a sheet of paper, there will appear to be two lines or dots ; and on turning the spar round, these objects will seem to turn round also ; and twice in the revolution they will fall upon each other, which occurs when the two positions of the spar are exactly opposite, that is, when turned one-hãlf from the position where it is first observed. In the accompanying diagram, fig. 71,

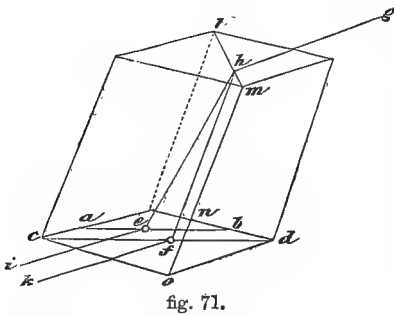

fig. 71.

the line appears double, as $a b$ and $c d$, or the dot, as e and f . Or allow a ray of light, $g h$, to fall thus on the crystal, it will in its passage through be separated into two rays, $h f$, $h e$; and on coming to the opposite surface of the crystal, they will pass out at $e f$ in the direction of $i k$, parallel to $g h$. The plane $l m n o$ is designated the principal section of the crystal,

and the line drawn from the solid angle l to the angle o is where the axis of the crystal is contained ; it is also the optic axis of the mineral. Now when a ray of light passes along this axis, it is undivided, and there is only one image ; but in all other directions there are two.

If two crystals of Iceland spar be used, the only difference will be, that the objects seem farther apart, from the increased thickness. But if two crystals be placed with their principal sections at right angles to

each other, the ordinary ray refracted in the first will be the extraordinary in the second, and so on *vice versa*. At the intermediate position of the two crystals there is a subdivision of each ray, and therefore four images are seen; when the crystals are at an angle of 45° to each other, then the images are all seen of equal intensity.

Mr. Nicol first succeeded in making rhombs of Iceland spar into *single-image prisms*, by dividing one into two equal portions. His mode of proceeding is thus described in the *Edinburgh Philosophical Journal* (vol. vi. p. 83): "A rhomb of Iceland spar of one-fourth of an inch in length, and about four-eighths of an inch in breadth and thickness, is divided into two equal portions in a plane, passing through the acute lateral angle, and nearly touching the obtuse solid angle. The sectional plane of each of these halves must be carefully polished, and the portions cemented firmly with Canada balsam, so as to form a rhomb similar to what it was before its division; by this management the ordinary and extraordinary rays are so separated that only one of them is transmitted: the cause of this great divergence of the rays is considered to be owing to the action of the Canada balsam, the refractive index of which (1.549) is that between the ordinary (1.6543) and the extraordinary (1.4833) refraction of calcareous spar, and which will change the direction of both rays in an opposite manner before they enter the posterior half of the combination." The direction of rays passing through such a prism is indicated by the arrow, fig. 72, and the combination is shown mounted, one for use under the stage of the microscope, fig. 73, termed the *polariser*; another, fig. 74, screwed on to and above the object-glasses, is called the *analyser*.

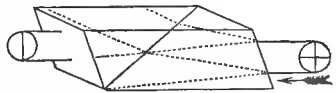

fig. 72.

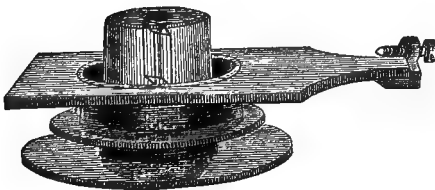

fig. 73.

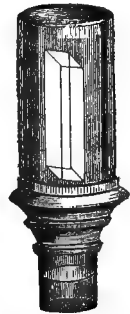

fig. 74.

Method of using the polarising Prism, fig. 73.—After having adapted it to slide into a groove on the under-surface of the stage, it is held in its place by turning the small milled-head screw at one end: the other prism, fig. 74, is screwed on above the object-glasses, and made to pass into the body of the microscope itself. The light having been reflected through them by the mirror, it becomes necessary to make the axes of the two prisms coincide; this is done by regulating the milled-head screw, until by revolving the *polarising* prism, the field of view is entirely darkened twice during one revolution. This should be ascertained, and carefully corrected by the maker and adapter of the apparatus. If very minute salts or crystals are to be viewed, it is preferable to place the polariser above the eye-piece; it will then require to be mounted as in fig. 75. Thus the *polariscope* consists of two parts; one

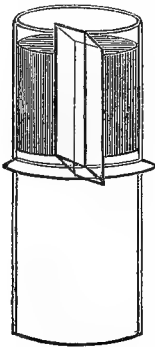

fig. 75.

for *polarising*, the other for *analysing* or testing the light. There is no essential difference between the two parts, except what convenience or economy may lead us to adopt; and either part, therefore, may be used as polariser or analyser; but whichever we use as the polariser, the other becomes the analyser.

The *tourmaline*, a precious stone of a neutral or bluish tint, forms an excellent analyser; it should be cut about $\frac{1}{10}$ th of an inch thick, and parallel to its axis. The great objection to it is, that the transmitted polarised beam is more or less coloured. The best tourmaline to choose is the one that stops the most light when its axis is at right angles to that of the polariser, and yet admits the most when in the same plane.

In the illumination of objects by polarised light, when under view with high powers, for the purpose of obtaining the maximum effect, it is also requisite that the angle of aperture of the polariser should be the same as the object-glass, each ray of which should be directly opposed by a ray of polarised light. The *Polarising Condenser* is merely an ordinary achromatic condenser of large aperture, close under the bottom lens of which is placed a plate of tourmaline, used in combination with a superposed film of selenite or not, as required. The effect of this arrangement on some objects is very remarkable, bringing out strongly colours which are almost invisible by the usual mode.

The production of colour by polarised light has been most clearly and comprehensively explained by Mr. Woodward, in his "Introduction to the Study of Polarised Light."* To render the diagram more

* Mr. Woodward constructed a very available form of polariscope for most pur-

intelligible, as we are unable to introduce them in the colours given by the above gentleman, we may state that ordinary light is represented by *a cross*, which denotes that its vibrations are in planes at right angles to each other; whereas when one set of such vibrations only is shown, the light is said to be *polarised*. In fig. 76, *a b c d* represent

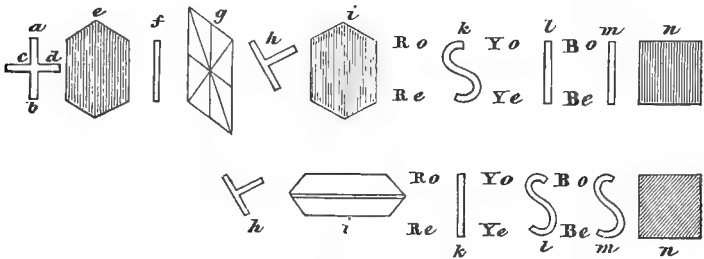

fig. 76.

the rectangular vibrations of common light; *e* a plate of tourmaline placed with its axis in a vertical direction—this is called the polariser; *f* a beam of polarised light obtained from *a b c d* by the stoppage of plane *c d*; *g* a film of selenite of such a thickness as to produce red or green light; *h* the polarised beam *f* split into two planes at right angles to each other; *i* a second tourmaline or analyser, with its axis in the same direction as that of *e*; by this all the vibrations that are not inclined at a greater angle than 45° to the axis of the analyser can be transmitted and again brought together; *k* the waves *R o R e* of red light, meeting in the same state of vibration, and forming a wave of red light of doubled intensity; *l m* the waves *Y o Y e* and *B o B e* for yellow and blue meeting together, with a difference of an odd number of half undulations, and thus neutralising each other by interference; *n* the resultant red light.

In the next line of figures may be seen what takes place by turning the analysing tourmaline one quarter of a circle. *h* represents the polarised beam split into two rays; *i* the tourmaline turned so that its axis is at right angles to that in the preceding figure; *k* the waves *R o R e* of red light destroying each other by interference; *l m* the waves *Y o Y e* and *B o B e* for yellow and blue, meeting together in the same state of vibration, and by their coincidences, waves of doubled intensity for yellow and blue light; *n* green light, resulting from the mixture of the yellow and blue light respectively. By substituting Nichol's prisms for

poses; the instrument is described in *Elements of Natural Philosophy*, by J. Hogg, p. 281.

the two plates of tourmaline, and by the addition of the object-glass and eye-piece, the diagrams would then represent the passage of polarised light through a microscope.

For showing objects by polarised light under the microscope, put upon the stage of a film of selenite, which exhibits, under ordinary circumstances, the red ray in one position of the polarising prism, and the green ray in another; each arc will assume one of these complementary colours, whilst the centre of the field will remain colourless. Into this field introduce any microscopic object which in the usual arrangement of the polariscope undergo no change in colour, when it will immediately display the most brilliant effects. Sections of wood, feathers, algæ, and scales, are among the objects best suited for this kind of exhibition.

The power suited for the purpose is a two-inch object-glass, the intensity of colour, as well as the separating power of the prism, being impaired under much higher amplification; although in some few instances, such as in viewing animalcules, the inch-object-glass is perhaps to be preferred.

Mr. J. King attributes the foregoing phenomenon to the double-image prism separating the constituents of the polarised ray into two planes, and causing them to overlap each other, except at the edges where the light is analysed; and of course, the combination of complementary colours in the centre of the field produces white light. Any object, therefore, placed in the white field, partakes of the characters of the selenite; one image being refracted into the plane which exhibits the green ray, assumes that colour; whilst the second image, being refracted into the plane of the red ray, partakes of that tint. Should the object, however, be so large that actual separation of the images is not effected, the extremities and interstices only will be polarised, whilst the middle will remain dark, or present only its natural hue.

Selenite is the native crystallised hydrated sulphate of lime. A beautiful fibrous variety called *satin gypsum* is found in Derbyshire. It is found also at Shotover Hill, near Oxford, where the labourers call it *quarry-glass*. Very large crystals of it are found at Montmartre, near Paris. The form of the crystal most frequently met with is that of an oblique rectangular prism, with ten rhomboidal faces, two of which are much larger than the rest. It is usually slit into thin laminæ parallel to these large lateral faces; the film having a thickness of from one-twentieth to the one-sixtieth of an inch. In the two rectangular directions they allow perpendicular rays of polarised light to traverse them unchanged; these directions are called the *neutral axis*. In two other

directions, however, which form respectively angles of 45° with the neutral axis, these films have the property of double refraction. These directions are known as the *depolarising doubly refracting axis*.

The thickness of the film of selenite determines the particular tint. If, therefore, we use a film of irregular thickness, different colours are presented by the different thicknesses. These facts admit of very curious and beautiful illustration, when used under the object placed on the stage of the microscope. The films employed should be mounted between two glasses for protection. Some persons employ a large film mounted in this way between plates of glass, with a raised edge, to act as a stage for supporting the object, it is then called the "selenite stage." Mr. Darker has constructed a very neat stage of brass for this purpose, and that of producing a mixture of all the colours by superimposing three films, one on the other; by a slight variation in their positions, produced by means of an endless-screw motion, all the colours of the spectrum are shown.

Dr. Herapath, of Bristol, has recently described a salt of quinine, which is remarkable for its polarising properties. The salt was first accidentally observed by Mr. Phelps, a pupil of Dr. Herapath's, in a bottle which contained a solution of disulphate of quinine: the salt is formed by dissolving disulphate of quinine in concentrated acetic acid, then warming the solution, and dropping into it carefully, and by small quantities at a time, a spirituous solution of iodine. On placing this mixture aside for some hours, brilliant plates of the new salt will be formed. The crystals of this salt, when examined by reflected light, have a brilliant emerald-green colour, with almost a metallic lustre; they appear like portions of the elytræ of cantharides, and are also very similar to murexide in appearance. When examined by transmitted light, they scarcely possess any colour, there is only a slightly olive-green tinge; but if two crystals, crossing at right angles, be examined, the spot where they intersect appears perfectly black, even if the crystals are not one five-hundredth of an inch in thickness. If the light be in the slightest degree polarised—as by reflection from a cloud, or by the blue sky, or from the glass surface of the mirror of the microscope placed at the polarising angle $56^\circ 45'$ —these little prisms immediately assume complementary colours: one appears green, and the other pink, and the part at which they cross is a chocolate or deep chestnut-brown, instead of black. As the result of a series of very elaborate experiments, Dr. Herapath finds that this salt possesses the properties of tourmaline in a very exalted degree, as well as of a plate of selenite; so that it combines the properties of polarising a ray and of depolarising

it. Dr. Herapath has succeeded in making artificial tourmalines large enough to surmount the eye-piece of the microscope ; so that all experiments with those crystals upon polarised light may be made without the tourmaline or Nicol's prism. The brilliancy of the colours is much more intense with the artificial crystal than when employing the natural tourmaline. As an analyser *above the eye-piece*, it offers some advantages over the Nicol's prism *in the same position*, as it gives a perfectly uniform tint of colour over a much more extensive field than can be had with the prism.*

A variety of interesting phenomena have been described by Mr. S. Legg in the *Transactions of the Microscopical Society*. He says :

"The following experiments, if carefully performed, will illustrate the most striking phenomena of double refraction, and form a useful introduction to the practical application of this principle.

A plate of brass, fig. 77, three inches by one, perforated with a series of holes from about one-sixteenth to one-fourth of an inch in

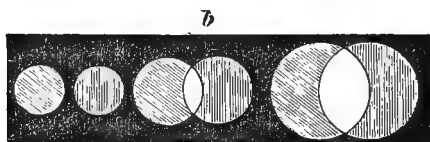

fig. 77.

diameter ; the size of the smallest should be in accordance with the power of the object-glass, and the separating power of the double refraction.

Experiment 1. Place the brass plate so that the smallest hole shall be in the centre of the stage of the instrument ; employ a low power ($1\frac{1}{2}$ or 2 inch) object-glass, and adjust the focus as for an ordinary microscopic object ; place the doubly-refracting crystal over the eye-piece, and there will appear two distinct images ; then, by revolving the eye-piece, these will describe a circle, the circumference of which cuts the centre of the field of view ; the one is called the ordinary, the other the extraordinary ray. By passing the slide along, that the larger orifices may appear in the field, the images will not be completely separated, but will overlap, as represented in the figure.

* Dr. Herapath has given a later and better process for the manufacture of these artificial tourmalines in the *Quarterly Journal of Microscopical Science* for January 1854. Also, for further researches on its polarising properties, see *Philosophical Magazine*, May 1855.

Experiment 2. Screw the Nicol's prism into its place under the stage, still retaining the double refractor over the eye-piece ; then, by examining the object, there will appear in some positions two, but in others only one image ; and it will be observed, that at 90° from the latter position this ray will be cut off, and that which was first observed will become visible ; at 180° , or one-half the circle, an alternate change will take place ; at 270° another change ; and at 360° , or the completion of the circle, the original appearance.

Before proceeding to the next experiment, it will be as well to observe the position of the Nicol's prism, which should be adjusted with its angles parallel to the square parts of the stage. In order to secure the greatest brilliancy in the experiment, the proper relative position of the selenite may be determined by noticing the natural flaws in the film, which will be observed to run parallel with each other ; these flaws should be adjusted at about 46° from the square parts of the stage, to obtain the greatest amount of depolarisation.

Experiment 3. If we now take the plate of selenite thus prepared, and place it under the piece of brass on the stage, we shall see, instead of the alternate black and white images, two coloured images composed of the constituents of white light, which will alternately change by revolving the eye-piece at every quarter of the circle ; then, by passing along the brass, the images will overlap ; and at the point at which they do so, white light will be produced. If, by accident, the prism is placed at an angle of 45° from the square part of the stage, no particular colour will be perceived ; and it will then illustrate the phenomena of the neutral axis of the selenite, because when placed in that relative position no depolarisation takes place. The phenomena of polarised light may be further illustrated by the addition of a second double refractor, and a film of selenite adapted between the double refractors. The systems of coloured rings in crystals cut perpendicularly to the principal axis of the crystal are best seen by screwing the Nicol's prism under the stage, and employing the lowest object-glass : place the crystals over the eye-piece, and use a tourmaline as the analyser."

It was long believed that all crystals had only one axis of double refraction ; but Brewster found that the great body of crystals, which are either formed by art, or which occur in the mineral kingdom, have *two axes* of double refraction as well as of polarisation.

Nitre crystallises in six-sided prisms with angles of about 120° . It has two axes of double refraction, along which a ray of light is not divided into two. These axes are each inclined about $2\frac{1}{2}^\circ$ to the axes

of the prism, and 5° to each other. If, therefore, we cut off a piece from a prism of nitre with a knife driven by a smart blow of a hammer, and polish the two surfaces perpendicular to the axis of the prism, so as to leave the thickness of the sixth or eighth of an inch, and then transmit a ray of polarised light along the axis of the prism, we shall see the double system of rings shown in figs. 78 and 79.

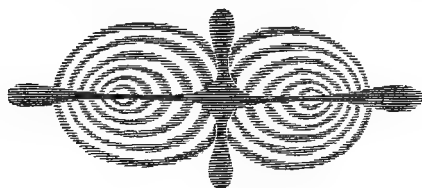

fig. 78.



fig. 79.

When the line connecting the two axes of the crystal is inclined 45° to the plane of primitive polarisation, the cross seen as first described, on revolving the nitre, opens, and gradually assumes the form of two hyperbolic curves, fig. 79. But if the tourmaline be revolved, the black crossed lines will be replaced by white spaces, and the red rings by green ones, the yellow by indigo, and so on.

These systems of rings have, generally speaking, the same colours as those of thin plates, or as those of a system of rings round one axis. The orders of the colours commence at the centres of each system; but at a certain distance, which corresponds to the sixth ring, the rings, instead of returning and encircling each pole, encircle the two poles as an ellipse does its two foci. When we diminish or increase the thickness of the plate of *nitre*, the rings are diminished or increased accordingly.

A large number of crystals exhibit this curious and beautiful system of coloured rings. Small specimens of salts may also be crystallised and mounted in Canada balsam for viewing under the stage of the microscope; by arresting the crystallisation at certain stages, a greater variety of forms and colours may be obtained: we may enumerate salicine, asparagine, acetate of copper, phospho-borate of soda, sugar, carbonate of lime, chlorate of potassa, oxalic acid, and all the oxalates found in urine, with the other salts in the same fluid, some of which are shown in fig. 80.

Dr. W. B. Herapath has contributed an interesting addition to the uses of polarised light, by applying it to discover the salts of alkaloïds, quinine, &c. in the urine of patients. He says: "It has long

been a favourite subject of inquiry with the professional man to trace the course of remedies in the system of the patient under his care, and

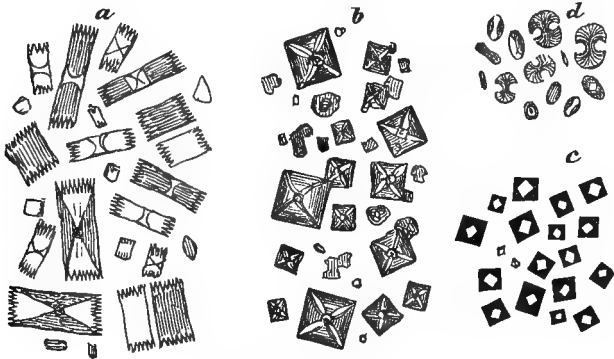

fig. 80. *Urinary Salts.*

a, Uric acid deposit. *b*, Oxalate of lime, octahedral crystals of. *c*, Oxalate of lime allowed to dry, forming a black cube. *d*, Oxalate of lime, as it occasionally appears, termed the dumb-bell form.

to know what has become of the various substances which he might have administered during the treatment of the disease.

Having been struck with the facility of application, and the extreme delicacy of the reaction of polarised light, when going through the series of experiments upon the sulphate of iodo-quinine, I determined upon attempting to bring this method practically into use for the detection of minute quantities of quinine in organic fluids; and after more or less success by different methods of experimenting, I have at length discovered a process by which it is possible to obtain demonstrative evidence of the presence of quinine, even if in quantities not exceeding the 1-100,000th part of a grain; in fact, in quantities so exceedingly minute, that all other methods would fail in recognising its existence. Take for

Test-fluid—A mixture of three drachms of pure acetic acid, with one fluid-drachm of rectified spirits-of-wine, to which add six drops of diluted sulphuric acid.

One drop of this test-fluid placed on a glass-slide, and the merest atom of the alkaloid added, in a short time solution will take place; then, upon the tip of a very fine glass-rod let an extremely minute drop of the alcoholic solution of iodine be added. The first effect is the production of the yellow or cinnamon-coloured compound of iodine and quinine,

which forms as a small circular spot; the alcohol separates in little drops, which, by a sort of repulsive movement, drive the fluid away; after a time, the acid liquid again flows over the spot, and the polarising crystals of sulphate of iodo-quinine are slowly produced in beautiful rosettes. This succeeds best without the aid of heat.

To render these crystals evident, it merely remains to bring the glass-slide upon the field of the microscope, with the selenite stage and single tourmaline, or Nicol's prism, beneath it; instantly the crystals assume the two complementary colours of the stage; red and green, supposing that the pink stage is employed, or blue and yellow, provided the

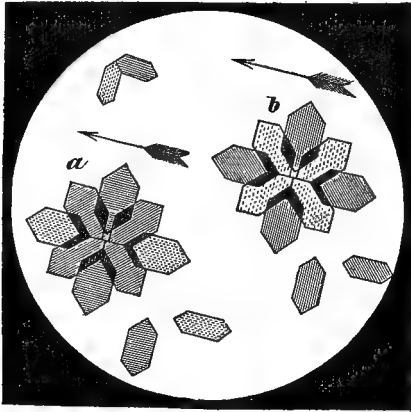

fig. 81. In this figure the heraldic lines are adopted to denote colour. The dotted parts indicate *yellow*, the straight lines *red*, the horizontal lines *blue*, and the diagonal, or oblique lines, *green*. The arrows show the plane of the tourmaline, *a*, blue stage; *b*, red stage of selenite employed.

blue selenite is made use of. All those crystals at right angles to the plane of the tourmaline, producing that tint which an analysing-plate of tourmaline would produce when at right angles to the polarising-plate; whilst those at 90° to these educe the complementary tint, as the analysing-plate would also have done if revolved through an arc of 90° ."

This test is so ready of application, and so delicate, that it must become *the test par excellence* for quinine: fig. 81, *a* and *b*.

Not only do these peculiar crystals act in the way just related, but they may be easily proved to possess the whole of the optical proper-

ties of that remarkable salt of quinine, so fully described by me in the *Philosophical Magazine* for March 1852, and the chemical analysis of which was published in the number for September in the same year. In fact, these crystals are perfectly identical with the sulphate of iodo-quinine in every respect.

To test for quinidine, it is merely necessary to allow the drop of acid solution to evaporate to dryness upon the slide, and to examine the crystalline mass by two tourmalines, crossed at right angles, and without the stage. Immediately little circular discs of white, with a well-defined black cross very vividly shown, start into existence, should quinidine be present even in very minute traces. These crystals are shown in fig. 82.

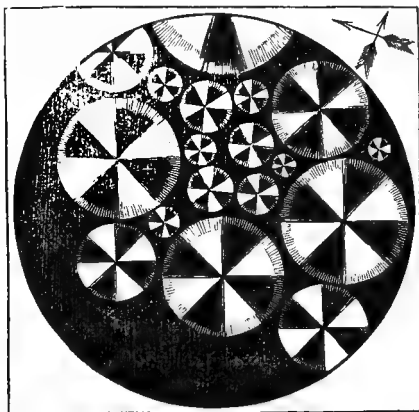

fig. 82.

If we employ the selenite stage in the examination of this object, we obtain one of the most gorgeous appearances in the whole domain of the polarising-microscope: the black cross at once disappears, and is replaced by one which consists of two colours, being divided into a cross having a red and green fringe, whilst the four intermediate sectors are of a gorgeous orange-yellow. These appearances alter upon the revolution of the analysing-plate of tourmaline; when the blue stage is employed, the cross will assume a blue or yellow tint, according to the position of the analysing-plate. These phenomena are analogous to those exhibited by certain circular crystals of boracic acid, and to those circular discs of salicine (prepared by fusion); the differ-

ence being, that the salts of quinidine have more intense depolarising powers than either of the other substances; besides which, the mode of preparation effectually excludes these from consideration. Quinine prepared in the same manner as the quinidines has a very different mode of crystallisation; but it occasionally presents circular corneous plates, also exhibiting the black cross and white sectors, but not with one-tenth part of the brilliancy, which of course enables us readily to discriminate the two.—*Philosophical Magazine*, 1853.

Ice doubly refracts, while water singly refracts. Ice takes the rhomboidic form; and snow in its crystalline form may be regarded as the skeleton crystals of this system. A sheet of clear ice, of about one inch thick, and slowly formed in still weather, will show the circular rings and cross when viewed by polarised light. Some of the Wenham Lake ice answers very well.

During the intense frost of February 1855, Mr. Glaisher made many beautiful drawings of snow crystals, figs. 83, 84, 85, and 86.

He writes: "This morning, February 21, with a temperature of 21° , they are falling sparingly, but are intensely beautiful; they are also minute, and highly crystalline. Up to the present time, 9h. 30m., all that I have observed are made up of prisms of six facets; and many are double, that is, two crystals alike in form are falling, united to an axis at right angles to the plane of each. These are generally fine specimens, and less minute; the rays of the under crystal in most cases filling the intermediate spaces between those of the upper, and, as

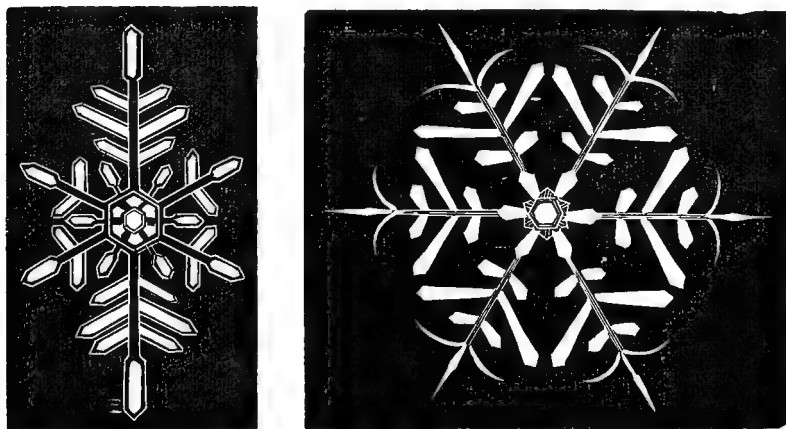

fig. 83. *Snow Crystals.*

crystals of a complex order, exhibiting a richness of effect hardly to be exaggerated.

It is a pleasant feature in the study of these figures that they give

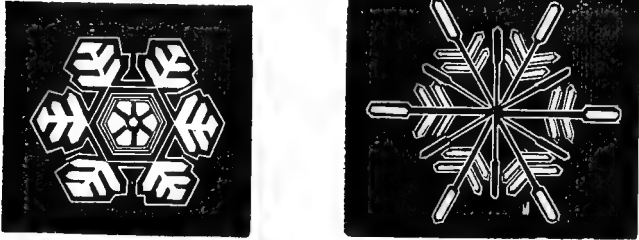

fig. 84. *Snow Crystals.*

pleasure to the observer, whether as seen by the naked eye with a lens of moderate power, or as expanded in all their beauty beneath the microscope. I received, a few days ago, from a gentleman at Huntingdon, drawings of twenty-four varieties, which he had observed in the year 1841. They were drawn about their natural size, with a fine pen; and,

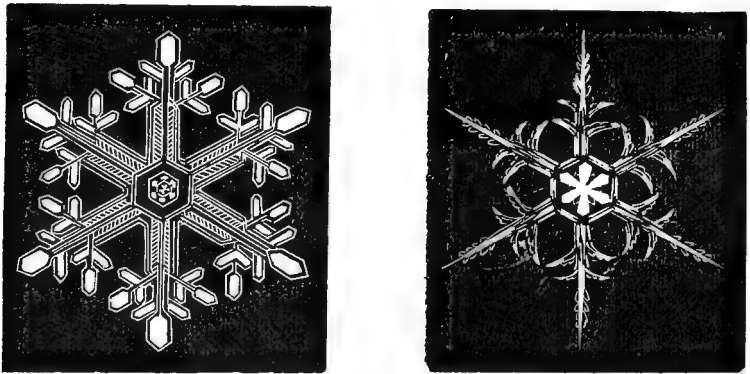

fig. 85. *Snow Crystals.*

if less wonderful in detail, were scarcely less beautiful than any I had seen with my highest-power lens.

My own observations of some of the more simple forms have been very satisfactorily confirmed by a lady, residing at Richmond, who has obligingly forwarded to me several of her sketches, made at the same time with many of my own. A collection of snow crystals, as observed

and accurately recorded, would be an interesting feature in meteorological investigation. At the same time, it is probable that the conditions of their formation are more complex than might be imagined,

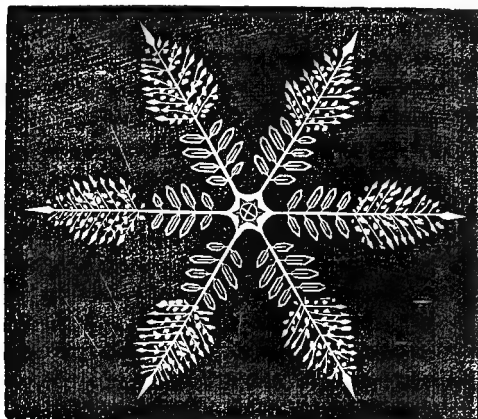

fig. 86. *Snow Crystals.*

familiar as we are with the conditions relating to the crystallisation of water on the earth's surface. Dr. Smallwood, of Isle Jesus, Canada East, has traced an apparent connection between the form of the compound varieties of snow crystals and the electrical condition of the atmosphere, whether negative or positive; and is, he informs me, instituting experiments for his better information on the subject."

A great variety of animal, vegetable, and other substances possess a doubly refracting or depolarising structure, as : a quill cut and laid out flat on glass ; the cornea of a sheep's eye ; skin, hair, a thin section of a finger-nail ; sections of bone, teeth, horn, silk, cotton, whale-bone ; stems of plants containing silica or flint ; barley, wheat, &c. The larger-grained starches form splendid objects ; *tous les mois*, being the largest, may be taken as the type of all the others. It presents a black cross, as at *a*, fig. 87, the arms of which meet at the hilum. On



fig. 87.

rotating the analyser, the black cross disappears, and at 90° is replaced by a white cross, as at *b* ; another, but much fainter black cross being perceived between the arms of the white cross. Hitherto, however, no colour is perceptible. But if a thin plate of selenite be interposed between the starch-grains and the polariser, most splendid and delicate colours appear. All the

colours change by revolving the analyser, and become complementary at every quadrature of the circle. West and East India arrow-root, sago, tapioca, and many other starch-grains, present the same appear-

ance; but in proportion as the grains are smaller, so are their markings and colourings less distinct.

“The application of this modification of light to the illumination of very minute structures has not yet been fully carried out; but still there is no test of differences in density between any two or more parts of the same substance that can at all approach it in delicacy. All structures, therefore, belonging either to the animal, vegetable, or mineral kingdom, in which the power of unequal or double refraction is suspected to be present, are those that should especially be investigated by polarised light. Some of the most delicate of the elementary tissues of animals, such as the tubes of nerves, the ultimate fibrillæ of muscles, &c. are amongst the most striking subjects that may be studied with advantage under this method of illumination. Every structure that the microscopist is investigating should be examined by this light, as well as by that either transmitted or reflected. Objects mounted in Canada balsam, that are far too delicate to exhibit any structure under transmitted, will often be well seen under polarised light; its uses, therefore, are manifold.”*

APPLICATION OF BINOCULARITY TO THE MICROSCOPE.

The application of this principle to microscopic purposes seems to have been tried as early as 1677, by a French philosopher, le Père Cherubin, of Orleans, a Capuchin friar. The following is an extract from the description given by him of his instrument: “Some years ago I resolved to effect what I had long before premeditated, to make a microscope to see the smallest objects with the two eyes conjointly; and this project has succeeded even beyond my expectation, with advantages above the single instrument so extraordinary and so surprising, that every intelligent person to whom I have shown the effect has assured me that inquiring philosophers will be highly pleased with the communication.”

This appears to have long slumbered and been forgotten; and nothing more was heard of the subject until Professor Wheatstone's very surprising invention of the stereoscope, when it again attracted the attention of the above philosopher, who applied to both Ross and Powell to construct him an instrument. But this was not done; and during the year 1853 a notice appeared in *Silliman's American Journal*

* Quekett's *Practical Treatise on the Use of the Microscope*.

of a binocular instrument constructed by Mr. J. L. Riddell. This even had many disadvantages and inconveniences, which Mr. F. H. Wenham has very ingeniously succeeded in modifying and improving.

In describing his improvements, he observes: "That in obtaining binocularity with the compound achromatic microscope, in its complete acting state, there are far greater practical difficulties to contend against; and which it is highly important to overcome, in order to correct some of the false appearances arising from what is considered the very perfection of the instrument.

All the object-glasses, from the one-inch upwards, are possessed of considerable angular aperture; consequently, images of the object are obtained from a different point of view, with the two opposite extremes of the margin of the cone of rays; and the resulting effect is, that there are a number of dissimilar perspectives of the object all blended together upon the single retina at once. For this reason, if the object has any considerable bulk, we shall have a more accurate notion of its form by reducing the aperture of the object-glass.

Select any object lying in an inclined position, and place it in the centre of the field of view of the microscope; then, with a card held close to the object-glass, stop off alternately the right or left hand portion of the front lens: it will be seen that during each alternate change certain parts of the object will alter in their relative position. To

illustrate this, figs. 88 *a b* are enlarged drawings of a portion of the egg of the common bed-bug (*Cimex lecticularis*), the operculum which covers the orifice having been forced off at the time the young was hatched. The figures exactly represent the two positions that the inclined orifice will occupy when the right and left hand portions of the object-glass are stopped off. It was illuminated as an opaque object, and drawn under a two-thirds object-glass of

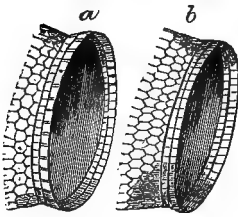

fig. 88.

about 28° of aperture. If this experiment is repeated, by holding the card over the eye-piece, and stopping off alternately the right and left half of the ultimate emergent pencil, exactly the same changes and appearances will be observed in the object under view. The two different images just produced are such as are required for obtaining stereoscopic vision. It is therefore evident that if, instead of bringing them confusedly together into one eye, we can separate them so as to bring figs. 88 *a b* into the left and right eye, in the combined effect of the two projections we shall obtain all that is necessary to enable us to

form a correct judgment of the solidity and distances of the various parts of the object.

If a rectangular plate of speculum-metal is ground and polished, so as to form two reflecting facets inclined to each other at the required angle, as represented at 4, fig. 89, and this is placed at an angle of 45° with the division of the facets intersecting the axis of the object-glass, we shall divide the rays, and reflect them horizontally by one single reflection. Any other direction than a right angle, with respect to the axis of the object-glass, may, of course, be given to the rays by inclining the reflector more or less. From the simplicity of this contrivance, and the facility with which it may be constructed, I shall take an early opportunity of giving it a trial. The only question I have is, whether a material may not be found that will reflect more light than even speculum-metal. I have heard an alloy of cast-steel and platinum well spoken of, but have never seen any of it.

In considering the aberrations which the thickness of glass contained in the reflecting prisms must inevitably produce, when placed immediately behind the object-glass, it occurred to me that if the same prisms were placed close to the top lens of the eye-piece, these errors, not being magnified, would be less sensibly felt.

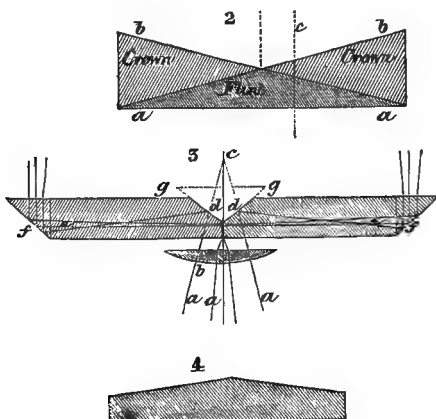

fig. 89.

Diagram 3, fig. 89, represents the methods that I have contrived for obtaining the effect of bringing the two eyes sufficiently close to each other to enable them both to see through the same eye-piece together. *aaa* are rays converging from the field lens of the eye-piece; after pass-

ing the eye-lens b , if not intercepted, they would come to a focus at c ; but they are arrested by the inclined surfaces, $d d$, of two solid glass prisms. From the refraction of the under incident surface of the prisms, the focus of the eye-piece becomes elongated, and falls within the substance of the glass at e . The rays then diverge, and after being reflected by the second inclined surface f , emerge from the upper side of the prism, when their course is rendered still more divergent, as shown by the figure. The reflecting angle that I have given to the prisms is $47\frac{1}{2}^{\circ}$. I also find it is requisite to grind away the contact edges of the prisms, as represented, as it prevents the extreme margins of the reflecting surfaces from coming into operation, which can seldom be made very perfect.

The definition with these prisms is good; but they are liable to objection, on account of the extremely small portion of the field of view that they take in, and which arises from the distance that the eyes are of necessity placed beyond the focus of the eye-piece, where, the rays being divergent, the pupil of the eye is incapable of taking them all in; also there is great nicety required in the length of the prisms, which must differ for nearly every different observer.

I have constructed an adjusting binocular eye-piece, not differing in principle from the last. The first reflection is performed by means of a triangular steel prism, with the two inclined facets very highly polished; this is represented by the dotted outline $g g$. The rays, after having been reflected at right angles, are taken up by two rectangular glass prisms, shown by the dotted lines at $f f$.

The loss of light in this is much greater than in the former instance, and the field of view more contracted; for the rays from the eye-piece, after being reflected from the surface of the steel prism, fall to their natural focal distance, instead of being elongated, as in the solid prism; consequently the eye is still further removed from the focus. I had chosen hard steel for the reflector, on account of the property this material possesses of allowing the figure of a small flat surface to be retained, or even perfected, during the operation of polishing. I have also tried a combination of prisms over the field-glass, using two eye-lenses; but with no good result. The best effect that I have yet produced in the way of binocular vision applied to the microscope, is that next to be described, in which I have altogether dispensed with reflecting surfaces, merely using three refracting prisms, which, when placed together, are perfectly achromatic. $a a$, diagram 2, fig. 89, is a single prism of dense flint-glass, with the three surfaces well polished; $b b$ are two prisms of crown-glass of half the length of the under flint-

PLATE II.

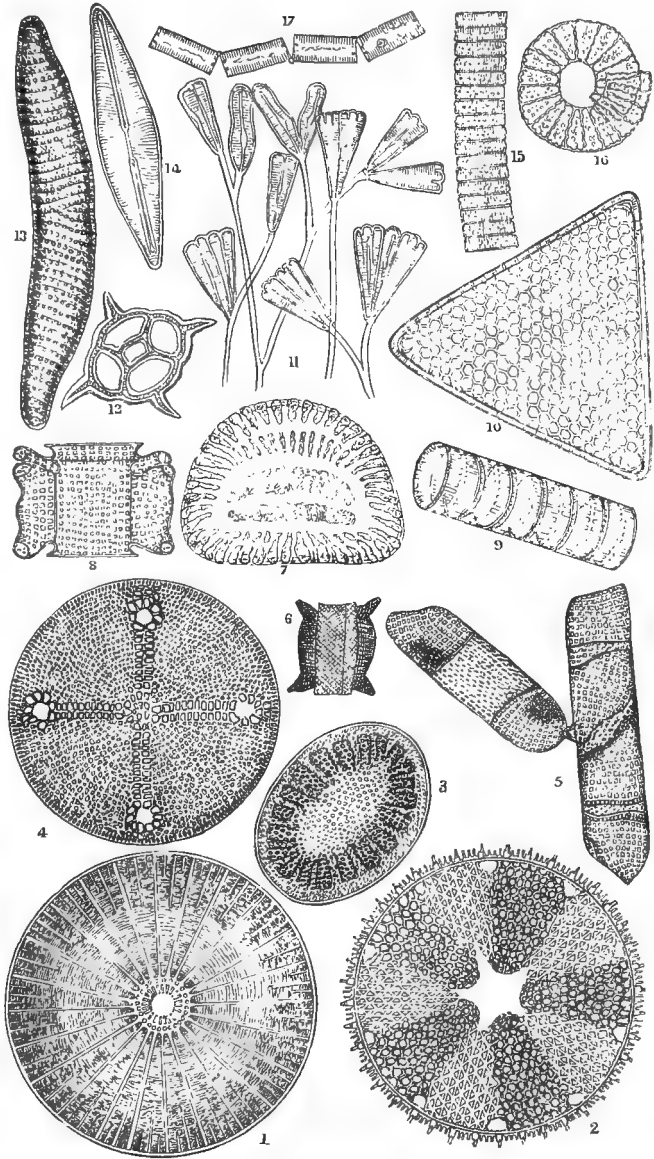

SILICEOUS SHELLS OF FOSSIL INFUSORIA.

prism, to the upper inclines of which they are cemented with Canada balsam.

The angle of inclination to be given to the prisms must depend upon the dispersive power of the flint and crown-glass employed. In the combination that I have worked out, I have used, for the sake of simplicity, some flint and crown that Mr. Smith kindly furnished me with, in which the dispersive powers are exactly as two to one; consequently I have had to make the angle of the crown just double that of the flint, in order to obtain perfect achromatism. The refractive power of each must also be known, that we may determine the angles of the prisms suitable for refracting the rays from the object-glass into the two eyes, at a distance of nine inches. *c*, fig. 89, represents a ray of light incident at right angles upon the under-surface of the flint-prism. On leaving the second surface, and entering the crown-prism, it is slightly bent inwards; and on finally emerging, it is refracted outwards in the direction required. On looking through this prism, I could not discover the slightest colour or distortion—it is almost like looking through a piece of plain glass; and the loss of light is so inappreciable, that it is difficult to distinguish any difference between an object and its refracted image. The base of the compound prism should not be larger than is sufficient to cover the stop of the lowest object-glass, in order that they may be made very thin.

The method of applying the prism to the binocular microscope is shown by fig. 90: *aa* is the object-glass, *b* the prism placed as close behind it as the fittings will admit. The prism is set in an aperture in a flat disc of brass, which has a horizontal play in every direction, in order that it may be adjusted and fixed in such a position that the junction of the prisms may bisect the rays from the object-glass, and at the same time be at right angles to the transverse centres of the eye-piece; *cc* are the two bodies of the microscope, provided with draw-tubes and the usual eye-pieces *dd*. The distance between them should be rather less than the average distance asunder of the eyes; and in cases where these are very wide apart, we can pull

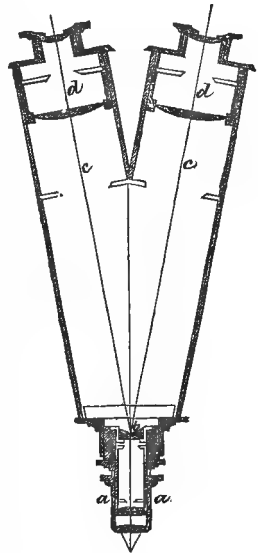

fig. 90.

out the draw-tubes, which will increase the distance between the eye-pieces.

With this apparatus I obtain the whole of the field of view in each eye; which circumstance I was not prepared to expect, as this must, in some measure, depend upon the correction of the oblique pencils of the object-glass, for we cannot expect to look obliquely through the objective of a compound achromatic microscope in the same way as in the single lens arrangement, but can only avail ourselves of such oblique pencils of rays as are corrected for passing through the axis of the microscope."

During the past year Mr. Wenham succeeded in further improving and simplifying this arrangement, a detailed account of which will be found in the volume of the *Journal of Microscopical Science* for 1854.

APPLICATION OF PHOTOGRAPHY TO THE MICROSCOPE.

When this book was first projected, it was thought that if the objects so beautifully exhibited under the microscope could be drawn by light on the page of the book, or on the wood-block, so that the engraver might work directly from the drawing thus made, truthfulness would be insured, and we should present to the reader a valuable record of microscopic research never before seen or attempted. But in this we were doomed to disappointment by the existence of a patent, which presented obstacles too great to be surmounted at that time; and the idea was abandoned, with the exception of a few drawings then prepared, and now ready to hand: the patent restrictions having been since removed, we have embodied them in our pages. The eye and feet of fly, antenna of moth, paddles of whirligig, with a few others, were first taken on a film of collodion, and then floated off the glass to the surface of a block of wood; the wood having been previously and lightly inked with printer's ink or amber-varnish; the film was then gently rubbed or smoothed down to an even surface, at the same time carefully pressing out bubbles of air or fluid.

For the purposes of photography the only necessary addition to the ordinary microscope is, that of a dark chamber; it must indeed form a camera obscura, having at one end an aperture for the insertion of the eye-piece end of the microscopic tube, and at the other a groove for carrying the crown-glass for focussing. This dark chamber should not exceed eighteen inches in length; for if longer, the pencil of light trans-

mitted by the object-glass is diffused over too large a surface, and a faint and unsatisfactory picture results therefrom. Another advantage is, that pictures at this distance are in size very nearly equal to the object seen in the microscope. In some instances better pictures are produced by taking away the eye-piece of the microscope altogether. The time of producing the picture varies from five to twenty seconds with the strength of the daylight. A camphine lamp, light Cannel coal-gas, or the lime-light, will enable a good manipulator to produce pictures nearly equal to the sunlight. Collodion offers the best medium, as a strong negative can be made to produce any number of printed positives.

The light is transmitted from the mirror through the object and lenses, and brought to a focus on the ground-glass, or prepared surface of collodion, in the usual manner. Care must be taken not to use the burning focus of the lenses. The gas microscope may be used to make an enlarged copy of an object; it is only necessary to pin up against the screen a piece of prepared calotype paper to receive the reflected image. Mr. Wenham has given directions for improving "microscopic photography" in the *Quarterly Journal of Microscopical Science* for January 1855. In this paper he has shown how to ensure quick and accurate focussing; or, in other words, the making of the *actinic* and *visual* foci of the objective coincident. The simplest and cheapest way of producing coincidence is to screw a biconvex lens into the place of the back-stop of the object-glass, acting as part of its optical combination. An ordinary spectacle lens, carefully centred and turned down to the required size, answers the purpose exceedingly well.

Mr. S. Highley's mode of adapting an object-glass to the ordinary camera, for the purpose of taking microscopic objects on collodion and other surfaces, is shown in fig. 91; a sectional view of his arrangement is given, which is very compact, steady, and ever ready for immediate use. The tube, A, screws into the flange of a camera which has a range of twenty-four inches; the front of this tube is closed, and into it screws the object-glass, B. Over A slides another tube, C; this is closed by a plate, D, which extends beyond the upper and lower circumference of C, and carries a small tube, E, on which the mirror, F, is adjusted. To the upper part of D the fine adjustment G is attached; this consists of a spring-wire coil acting on an inner tube, to which the stage-plate, H, is fixed, and is regulated by a graduated head, K, acting on a fine screw, likewise attached to the stage-plate, after the manner of Oberhauser's microscopes. An index, L, is fixed opposite the graduated head, K. The stage and clamp slides vertically on H; and by sliding

this up or down, and the glass object-slide horizontally, the requisite amount of movement is obtained to bring the object into the field. The object being brought into view, the image is roughly adjusted on the focussing-glass by sliding C on A; the focussing is completed by aid of the fine adjustments, G, K, and allowance then made for the amount of non-coincidence between the chemical and visual foci of the

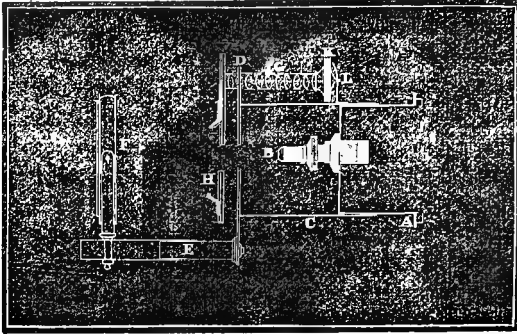

fig. 91.

object-glass. The difference in each glass employed should be ascertained by experiment in the first instance, and then noted. By employing a finely-ground focussing-glass greased with oil, this arrangement forms an agreeable method of viewing microscopical objects with both eyes, and is less fatiguing. As a very large field is presented to the observer, this arrangement might be advantageously employed for class demonstration.

Two exquisitely delineated *negative* objects obtained in this way by Mr. Delves were afterwards printed as *positives*, for the purpose of illustrating an excellent paper on the "Application of Photography to Microscopy," in No. 3 of the *Quarterly Journal of Microscopical Science*.

PART II.

CHAPTER I.

PROTOZOA — RHIZOPODA — HISTORY OF INFUSORIAL ANIMALCULES —
MONADS — FOSSIL INFUSORIA, ROTIFERA, VORTICELLA, STENTORS,
HYDRA, ZOÓPHYTES, SPONGES, MOLLUSCA, CRUSTACEA, ETC.



SCIENCE has defined matter, space, time, and natural history so infinitesimally, that the brain becomes bewildered from want of some familiar object to convey to the mind by comparison the results exhibited.

The precious metal gold can be reduced to a film the four-millionth part of an inch in thickness by manual ingenuity ; space measured and divided the hundred-thousandth part of an inch with truthfulness by a machine ; electricity proved to pass along a wire with the velocity of five hundred and seventy-six thousand miles in a second, and an object of the most elaborate

workmanship seized in every detail, and faithfully portrayed, by electricity and the camera, in the one-millionth part of the fraction of time denominated a second. At the least, a million of living creatures of delicate structure may be seen in active pursuit of prey in a space not larger than a mustard-seed, and a single one, increasing in twenty-four hours to the enormous number of one hundred and forty millions, is demonstrated by means of the philosophical instrument the microscope, the construction of which we have been describing.

PROTOZOA.

The first division, or lowest forms of the animal kingdom, appear as creatures of a low type of organisation, and have been considered to hold a medium state between animals and vegetables. Almost all of them live in water; and it would be a fruitless search to look for distinct internal organs, as the small bladder-looking spaces enclosed within their substance,—believed by Ehrenberg to be stomachs, and which have been termed by Dujardin *sarcode*,—present only the appearance of a transparent gelatinous cell, with or without moving spaces in



fig. 92. A drop of Water displayed.

Larva of *Dytiscus*, Cup Moss, Spurge Laurel, &c.

their interior ; they may be regarded as the earliest dawn of a circulatory system.

The *Protozoa* are divided into three classes. In the first, to which the name of *Rhizopoda* has been given, the body is composed entirely of the gelatinous matter above described, motion being effected by the extension of portions of the substance into filaments or processes of various forms.

The second class, including the sponges, consists entirely of associated cell animals, the individual cells resembling those of the preceding class in their power of extending the substance of their bodies in all directions ; but in this class they are united by a mucilaginous intercellular substance, and supported upon a horny framework. From the masses formed by these creatures being perforated in every part with minute orifices, they have received the denomination of *Porifera*.

The animals constituting the third class of the Protozoa have been called *Infusoria*. They are generally solitary unicellular animals, and differ from the *Rhizopoda* in having the outer surface of the body of a somewhat firmer consistence than the rest of their substance. They are usually furnished with a mouth, and their movements are effected by means of cilia, or of one or more long filiform appendages attached to one extremity of the body.

In the valuable voluminous treatises on this interesting department of nature, the above division would be strictly adhered to ; but as our object is to give a popular account of the wonders disclosed by the microscope, we will not closely follow the path of the learned investigators of this branch of science ; and hence will avoid as much as possible the adoption of those terms so alarming to the uninitiated, culling, as we pass, only those objects of most interest, and likely to create a desire for further knowledge ; whereby there will be found a future pleasure in overcoming the obstacles by which the learned render so mysterious and repugnant to the popular mind the stores of their gathered wealth.

AMÆBA.

In the deposit formed at the bottom of fresh-water ponds, we may often meet with a singular minute gelatinous body, which constantly changes its form even under our eyes ; and moves about by means of finger-like processes, which it appears to have the power of shooting out from any part of its substance. This shapeless mass is well known to microscopic observers under the name of the Proteus (*Amæba dif-*

fluens, fig. 95, 4, 5, and 6). From the continual changes of shape which it presents, it is honoured with the name of a fabled god, who could be either animal, vegetable, or elemental in his nature. This curious animal presents us with the essential characters of the class *Rhizopoda* in the simplest form. It appears to be of an exceedingly voracious disposition, seizing upon any minute aquatic animals or plants that may come in its way, and appropriating them to the nutrition of its own gelatinous body. The mode in which this tender and apparently helpless creature effects this object is very remarkable. The gelatinous matter of which it is composed is capable, as we have seen, of extension in every direction; accordingly, when the *Amæba* meets with any thing that it regards as suitable for its support, the substance of the creature, as it were, grows round the object until this is completely enclosed within the body, when it is gradually dissolved. The substances swallowed (if such a term be admissible) by this hungry mass of jelly are often so large, that the creature itself only seems to form a sort of gelatinous coat enclosing its prey.

Professor Ecker believes in an exact similarity of *contractile substance* between that of the lower animal forms, such as the *Rhizopoda*, and that observed in the *Hydra*. He says: "The properties of this substance, in its simplest form, are seen in the *Amæba*, the body of which, as is known, consists of a perfectly transparent albumen-like homogeneous substance, in which nothing but a few granules are imbedded, and which presents no trace of further organisation. This substance is in the highest degree extensible and contractile; and from the main mass are given out, now in one part and now in another, perfectly transparent rounded processes, which glide over the glass like oil, and are then again merged in a central mass. There is no external membrane. In the body of the *Amæba* there occur, besides the granules, clear spaces with fluid contents, which are sometimes unchangeable in form, and sometimes exhibit rhythmical contractions."

Owing to the general similarity which exists apparently throughout the rhizopodous class in the intimate structure of the soft part, their systematic arrangement can only be founded upon their shells, which exhibit an astonishing diversity of form. Out of these forms, it would appear that the labours of various naturalists in the last hundred years have made known nearly 2000 species of recent and fossil Foraminifera; and although the observations of Dr. Carpenter tend to show the probability that very many of these supposed species are merely varieties, still the number is sufficiently great to prove the importance and interesting nature of the subject. Dr. Schultze acknowledges the

difficulties attending the study of the *Rhizopoda*, and insists very properly upon the necessity of viewing them in all positions, and under different modes of illumination and of preparation, in order to arrive at a due conception of their conformation.

When recent Foraminifera are dissolved in dilute acid, an organic basis is always left after the removal of the calcareous matter, accurately retaining the form of the shell, with all its openings and pores. The earthy constituent is mainly carbonate of lime; but Dr. Schultze has satisfied himself of the presence of a minute amount of phosphate of lime in the shells of recent *Orbiculina adunca* from the Antilles, and of *Polystomella strigilata* from the Adriatic.

The solitary *Rhizopoda*, furnished with a horny shell or capsule, forming a case for the animal, constitute the family *Arcellidæ*. In the genus *Arcella*, from which the family derives its name, the shell is somewhat of a bell-shape, with a very large round opening. In *Englypha* it is of an oval or flask-like form, with the opening at the smaller end, and the shell appears as though formed of a sort of mosaic of small horny pieces. In *Diffugia* the shell is often globular.

All the *Polythalamia*, or *Foraminifera*, inhabit the sea, and fre-

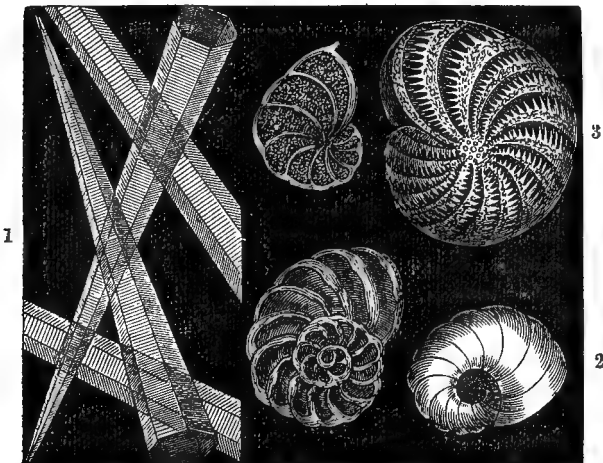

fig. 93.

1. Separated prisms from outer layer of *Pinna* shell.
2. Skeletons of Foraminifera from limestone.
3. Recent shell of *Polystomella crista*; seen by the aid of the dark-ground illuminator.

quently occur in such great numbers, that the fine calcareous sand which constitutes the sea-shore in many places consists almost entirely of their microscopic coats. At former periods of the earth's history, they existed in even greater profusion than at present; and their fragile shells form the principal constituents of several very important geological formations. Thus the chalk appears to consist almost entirely of the shells of these animals, either in a perfect state, or worn and broken by the action of the waves; and they occur in great quantities in the marly and sandy strata of the tertiary epoch. The stone which is universally employed in Paris as a building stone is almost entirely composed of the fossil shells of an animal belonging to the order *Miliola*.

In the *Stichostegidæ* the chambers are placed end to end in a row, so as to form a straight or but slightly curved shell. In the second family, the *Enallostegidæ*, the chambers are arranged alternately in two or three parallel lines; and as the construction of the shell is always commenced with a single small chamber, the whole necessarily acquires a more or less pyramidal form. The third family, the *Helicostegidæ*, presents us with some of the most beautiful forms that we meet with in these shells. They commence by a small central chamber; and each of the subsequent chambers, which are arranged in a spiral form so as to give the entire shell much the aspect of a minute flattened snail, is larger than the one preceding it. It is in this family that we find the nearest approach, in external form, to the large chambered shells of the cephalopodous mollusca, of which the nautilus and the argonaut are examples. The fourth family, the *Entomostegidæ*, stand in the same relation to the preceding as the *Enallostegidæ* to the *Stichostegidæ*; that is to say, the chambers are also arranged in a spiral form, but in a double series. A fifth family includes those shells in which the chambers are arranged round a common perpendicular axis in such a manner that each chamber occupies the entire length of the shell. The orifices of the chambers are placed alternately at each end of the shell, and furnished with a curious tooth or process. The *Miliola* will serve as an example of this family.

It is probable, although by no means certain, that the animals whose fossil shells, termed *Nummulites*, are found in great quantities in the chalk and lower tertiary strata, are also to be regarded as members of this class. No living example of this form of animal has yet been met with; but in a fossil state whole mountains consist almost entirely of their shells.

The great Pyramid of Egypt, covering eleven acres of ground, is

based on blocks of lime-stone consisting of Foraminifera, *nummulites*, or *stone coin*, and other fossil animalcules. The nummulites vary in size, from that of a most minute object to that of a crown-piece, and many appear like a snake coiled in a round form. A chain of mountains in the United States, 300 feet high, seems to be wholly formed of one kind of this fossil-shell. The crystalline marble of the Pyrenees, and the lime-stone ranges at the head of the Adriatic gulf, are composed of small nummulites. Vast deposits of Foraminifera have been traced in Egypt and the Holy Land, on the shores of the Red Sea, Arabia, and Hindostan, and, in fact, may be said to spread over thousands of square miles from the Pyrenees to the Himalayas.

The fossilised Foraminifera in the Poorbandar lime-stone, although occasionally reaching the twenty-fifth, do not average more than the hundredth part of an inch in diameter; so that more than a million of them may be computed to exist in a cubic inch of the stone. They may be separated into two divisions—those in which the cells are large, the regularity of their arrangement visible, and their bond of union consisting of a single constructed portion between each; and those in which the cells are minute, not averaging more than the 900th part of an inch in diameter, the regularity of their arrangement not distinctly seen, and their bond of union consisting of many thread-like filaments. To ascertain the mineral composition of the amber-coloured particles or casts, after having found that it was carbonate of lime with which they were surrounded, they were placed for a few moments in the reducing flame of a blow-pipe, and it was observed that on subsequently exposing them to the influence of a magnet, they were all attracted by it. Hence, in a rough way, this rock may be said to be composed of carbonate of lime and oxide of iron.

Truthfully does Lamarck say of the Foraminifera: "Their smallness renders their bodies contemptible to our eyes; in fact, we can hardly distinguish them; but we cease to think thus when we consider that it is with the smallest objects that nature produces the most imposing and remarkable phenomena. Now, it is here again that we have one of the numerous instances which attest that, in her production of living bodies, all that nature appears to lose on one side in volume, she regains on the other in the number of individuals, which she multiplies to infinity."

INFUSORIA.

The class *Infusoria*, described by Ehrenberg in his work *Infusionsthierchen*, published in 1838, was divided into two great groups, the

Polygastrica, or *many-stomached*; and the *Rotifera*, or *rotating*, wheel-animalcules: the latter are now classed with animals of a higher type of organisation. The classification of the *Infusoria* presents considerable difficulties, partly arising from their excessive minuteness, which renders the assistance of our best microscopes necessary to enable us even to see many of them, and partly from the impossibility of avoiding confusion from the intermixture of the genus of more highly organised animals, and some plants, as the *Volvocineæ*, the *Desmidiaceæ* or *Bacillariæ* of Ehrenberg, in various stages of development.

The term Infusoria* is applied to them because they were first discovered in water where vegetable matter was decomposing, and therefore, the infusion was considered necessary for their production. Now, however, it is an established fact, that they are in a higher state of organisation when taken from pure streams and clear ponds than from putrid and stagnant waters. A little bundle of hay, or sage leaves, left for about ten days in a mug containing some pure rain-water, caught before entering a butt, produces the common wheel-animalcules, which are found adhering to the sides of the mug near to the surface of the water. The only use of the vegetables seems to be to facilitate the development of the latent life of the atoms of organic matter, and perhaps as the first sources of their food.

The astronomer turns his telescope from the earth, and ranges over the vast vault of heaven, to detect and delineate the beautiful objects of his pursuit. The naturalist turns his microscope to the earth, and in a drop of water finds a wondrous world of animated beings, more numerous than the stars of the milky way; and these he classifies into genera and families, and catalogues in his history of the invisible world.

The Infusoria are a mighty family, as they frequently, in countless myriads, cover leagues of the ocean, and give to it a beautiful tinge from their vivid hue. They are discovered in all climes, have been found alive sixty feet below the surface of the earth, and in the mud brought up from a depth of sixteen hundred feet of the ocean. They exist at the poles and the equator, in the fluids of the animal body and plants, and in the most powerful acids. A brotherhood will be found in a little transparent shell, to which a drop of water is a world; and within these are sometimes other communities, performing all the functions granted them by their Creator, and eagerly pursuing the chase of others less than themselves as their prey.

The forms of the Infusoria are endless; some changing their shape

* *Infusoria* (from *infusor*, a pourer-in).

at pleasure, some resembling globes, eels, trumpets, serpents, boats, stars, pitchers, wheels, flasks, cups, funnels, fans, and fruits.

The multiplication of the species is effected in some by spontaneous division or fissuration, in others by gemmation or budding; whilst some species are oviparous, and others viviparous. The first step in the process by which infusorial animals are eliminated, is the formation of globular corpuscles or cells, which, by their aggregation in some cases, and individual evolutions in others, give birth to the organisms which subsequently appear.

The Infusoria have no night in their existence; they issue into life in a state of activity, and continue the duration of their being in one ceaseless state of motion; their term is short, they have no time for rest, and therefore have but one day, which ends only with their death and decomposition. Nevertheless, they appear to love that which promotes life,—the light of heaven; but others, born in the bowels of the earth, and who never partook of the blessing, still, like the ignorant among mankind, have their own contracted round of unenlightened joys; they perform their mechanical duties, and expire hidden and unknown.

On examining the structure of infusorial animalcules, some are found to have a soft yielding skin, so elastic as to stretch when food or other circumstances render it necessary, returning again to its previous condition as the cause of distension ceases; these are designated *illoricated*, which signifies shell-less. Others are termed *loricated*, from being covered with a shell, which is beautifully transparent, and flexible like horn. When the delicate and soft substance in which the functions of life perform their allotted duties perishes, the shell that protected it from injury during its hours of existence remains as a token of the past labours of nature; this sometimes consists entirely of flint, and in other cases of lime united with oxide of iron, destructible in some instances by fire, and in others not so.

Some of these minute beings have apportioned to them *setæ*, or bristles; these stiff hairs, attached to the surface of their bodies, do not rotate, but are movable, and appear to be a means for the support of their bodies, as aids in climbing over obstacles that present themselves, or as *feelers*. Others are possessed of *unci*, or hooks, projecting from the under part of the body, which are capable of motion; and by their means the animalcule can attach itself to any particular thing that it desires. Some, again, have *styles*, which are a kind of thick bristle, jointed at the base, possessing a movement, but not rotary; they are in the shape of a cone, large at their base, and delicate at their

summit. Many, also, can extend and withdraw their bodies at pleasure, in a similar manner to the snail or leech.

One of the most interesting and important organs possessed by the infusorial animalcule is scientifically known by the term *cilium*, which is the Latin word for eyelash, the plural being *ciliã*. Its appearance is that of a minute delicate hair.

The cilium is not only useful in the act of progression, but also as an assistance in procuring food; the two duties being performed at the same time, the motion of the organs that propels it forward causing a current to set towards the mouth, which carries with it the prey on which the animal feeds. From the cilia being found in the gills or beard of the tadpole, the oyster, and mussel, it would appear that they are serviceable as organs of respiration, by imbibing oxygen, and emitting the carbonic acid generated in the blood during its circulation through the body; they are also believed to be the medium of taste and touch. It is not only at the mouth, but over the whole body, that cilia are discovered; and it is now satisfactorily shown that cilia exist also in the internal organs of man and other vertebrated animals; and are agents by which many of the most important functions of the animal economy are performed. They vary in size from the 1000th to the 10,000th of an inch in length. These minute organs would often be invisible, were it not from the water being coloured when placed under a microscope; then the little currents made by the action of the cilia are easily perceived; and when the water is evaporated, the delicate tracing of their formation may be observed on the glass. They are differently placed, and vary in quantity in the numerous species of Infusoria. In some they are in rows the whole length of the body, in others on the base; many have them over the whole of the body; sometimes they fringe the mouth, form bands around projections on the body; and many have but two projecting from the mouth, as long as the body of the creature. Ehrenberg says they are fixed at their base by the bulb moving in a socket, in a similar manner to a man's outstretched arm; and by their moving round in a circle, they form a cone, of which the apex is the bulb. Poison, galvanism applied to the animal, and death, do not immediately stop the motion of the cilia, as they will continue in action some hours afterwards; even longer than nervous or muscular action can be sustained, until the fluids dry up and they stiffen.

Very little is known of their muscular development, from their extreme minuteness; but there can be no doubt of the existence of this structure in all. Now in the wheel-animalcules the cilia are in circular

rows; and each revolves around its bulb, giving a singular appearance, seeming to move together like a wheel upon its axle, whence their name *Rotifera*; in some of these muscles may be traced. The cilia must not be mistaken by young microscopists for the stiff hairs and bristles found on some animalcules, serving the purpose of locomotion in crawling or climbing.

If the roof of the mouth of a living frog be scraped with the end of a scalpel, and the detached mucous membrane placed on a glass slide, and examined with a power of 300 diameters, the ciliated epithelium-cells will be well seen. When a number of these are collected together, the movement is effected with apparent regularity; but in detached scales it is often so violent, that the scale itself is whirled about in a similar manner to an animalcule provided with a locomotive apparatus of the same description, and has frequently been mistaken for such. The animals more commonly employed for the examination of the cilia are the oyster and the mussel; but the latter are generally preferred. To exhibit the movement to the best advantage, the following method must be adopted:—open carefully the shells of one of those molluscs, spilling as little as possible of the contained fluid; then with a pair of fine scissors remove a portion of one of the gills (*branchiæ*); lay this on a slide, or the tablet of an animalcule cage, and add to it a drop or two of the fluid from the shell, and by means of the needle-points separate the filaments one from the other; cover it lightly with a thin piece of glass, and it is ready for examination. The cilia may then be seen in several rows beating and lashing the water, and producing an infinity of currents in it. If fresh water instead of that from the shell be added, the movement will speedily stop; hence the necessity of the caution of preserving the liquid contained in the shell. To observe the action of any one of the cilia, and its form and structure, some hours should be allowed to elapse after the preparation of the filaments above given; the movements then will have become sluggish. If a power of 400 diameters be used, and that part of the cilia attached to the epithelium scale carefully watched, each one will be found to revolve a quarter of a circle, whereby a “feathering movement” is effected, and a current in one direction constantly produced. In the higher animals the action of the cilia can only be observed a short time after death. In a polypus of the nose, when situated at the upper and back part of the Schneiderian membrane, the cilia may be beautifully seen in rapid action some few hours after its removal; but in the respiratory and other tracts, where ciliated epithelium is found, it would be almost impossible ever to see it in action, unless the body were opened imme-

diately after death. In some animals it may be seen in the interior of the kidney, as was first discovered by Professor Bowman in the expanding extremity of the small tube surrounding the network of blood-vessels forming the so-called Malpighian body. In order to exhibit the ciliary action, the kidney should have a very thin slice cut from it; and this is to be moistened with the serum of the blood of the same animal. The vascular and secreting portions of the organ may then be seen with a power of 250 diameters, and also the cilia in the expanded extremity of each tube, as it passes over to surround the vessels; the epithelium of the tubes themselves is of the spheroidal or glandular character.

These infusorial and invisible atoms of life have various periods allotted to them for the enjoyments of existence; some accomplish their destiny in a few hours, others in a few weeks. The watchful devotee in this branch of science has traced an animalcule through a course of existence extending to the old age of twenty-three days. The vital spark flies instantaneously in general; but in those of a higher organisation there is a spasmodic convulsion, as if the delicate and intricate machinery rendered life so exquisite, that the parting with the "heavenly flame" was reluctant and painful. The most surprising circumstance attendant on the nature of some of the Infusoria is that of apparent death. When the water or mud in which they have sported in the fulness of buoyant health becomes dried up, they lie in an inanimate speck of matter; but after months, nay years, a drop of water being applied, their bodies will be resuscitated, and in a short time their frames be active with life. Leeuwenhœck kept some in a hard and dry condition, and restored them to life after a sleep of death of twenty-one months. Professor Owen saw an animalcule that had been entombed in a grave of dry sand four years reborn to all the activity of life. Spallanzani tried the experiment of alternate life and death, and accomplished it in some instances on the same object *fifteen* times; after which nature was exhausted, and refused further aid in this miraculous care of those minute objects of her wonderful works.

The infusorial animalcules vary in their capabilities of the endurance of heat and cold; some of them retaining life in water 200° Fah., while others expire from the heat of a warm room. Many die when the mercury is as low as 80° Fah., while others survive. They have been found embedded in ice at the arctic regions, surrounded by a little water, which Ehrenberg supposes is not frozen from the natural heat of their bodies. Air is as necessary to their existence as it is to superior animals; for if placed in a tightly-corked bottle in water, where

oil is poured on its surface, or underneath the receiver of an air-pump, they are killed. They will live in water where poisons which mingle mechanically, not chemically, are infused. But all sudden transitions are destructive, as the mixture of sea with fresh water; still, if the change be gradual, they will adapt themselves to the new element and survive. The phosphorescent appearance of the ocean, arising chiefly from the presence of animalcules, is thus described by Darwin: "While sailing a little south of the River La Plata, on one very dark night, the sea presented a wonderful and most beautiful spectacle. There was a fresh breeze, and every part of the surface, which during the day is seen as foam, now glowed with a pale light. The vessel drove before her bows two billows of liquid phosphorus, and in her wake she was followed by a milky train. As far as the eye reached, the crest of every wave was bright; and the sky above the horizon, from the reflected glare of these livid flames, was not so utterly obscure as over the vault of the heavens. Near the mouth of the Plata some circular and oval patches, from two to four yards, shone with a steady but pale light, while the surrounding water only gave out a few sparks. The appearance resembled the reflection of the moon or some luminous body, for the edges were sinuous from the undulations of the surface."

Naturalists consider the phosphoric light of the marine animalcule to be the effect of vital action. The sparks are intermittent like the fire-fly; they measure from the 12,000th to 100th of an inch in size. Captain Scoresby found that the broad expanse of waters at Greenland was nearly all discoloured by animalcules, and computed that of some species one hundred and fifty millions would find ample room in a tumbler of water. Mr. Gosse thus describes the luminous appearances presented by a closer inspection of these minute animalcules: "Some weeks afterwards I had an opportunity of becoming acquainted with the minute animals, to which a great portion of the luminousness of the sea is attributed. One of my large glass vases of sea-water I had observed to become suddenly at night, when tapped with the finger, studded with minute but brilliant sparks at various points on the surface of the water. I set the jar in the window, and was not long in discovering, without the aid of a lens, a goodly number of the tiny jelly-like globules of *Noctiluca miliaris* swimming about in various directions. They swam with an even gliding motion, much resembling that of the *Volvox globator* of our fresh-water pools. They congregated in little groups, and a shake of the vessel sent them darting down from the surface. It was not easy to keep them in view when seen, owing rather to their extreme delicacy and colourless transparency than to

their minuteness. They were, in fact, distinctly appreciable by the naked eye, measuring from $\frac{1}{60}$ th to $\frac{1}{30}$ th of an inch in diameter." With

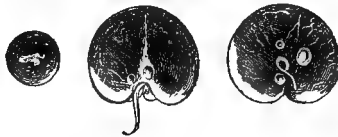

fig. 94. *Noctiluca miliaris*.

a power of about 200 diameters they are seen of various forms and stages of growth, as represented in fig. 94.

“Awaked before the rushing prow,
The mimic fires of ocean glow,
Those lightnings of the wave;
Wild sparkles crest the broken tides,
And, flashing round the vessel's sides,
With elfish lustre lave;
While far behind their livid light
To the dark billows of the night
A gloomy splendour gave.”

SCOTT.

MONADIDÆ—MONADS.

Monads.—These are amongst the smallest atoms of matter possessing the mysterious principle of life, discernible by the extraordinary magnifying power of the microscope. Minute, however, as they are, no one can say but that they derive their sustenance by preying on animals even less than themselves, as larger ones of the same species do upon them.

A drop of water only a tenth of an inch in diameter may glitter like a diamond from its translucency, and yet under the microscope be seen to hold 500 millions of these animated beings; an amount about equal to the human race now existing on the surface of our globe. Vainly does man, with all the subtlety of his mind, endeavour to conceive an object the twenty-four thousandth of an inch in length; yet this is the size of the monad: some have been discovered twice this length, but still they are inconceivably small when attempted to be defined by comparison. If each be allowed three times its bulk to move about in, a cubic inch of water will then contain 800,000 millions of these organised beings. Nay, some philosophers say this family of

Infusoria are seen only the one forty-thousandth of an inch in length. What incalculable numbers of animalcules must swarm the waters of creation !

Monads vary in their colours, some being red, green, yellow, and others colourless ; in shape they are round or oval (5 and 6, fig. 100), and possessed of immense activity, having one or more parts devoted to the purpose of locomotion. Monads have been claimed by the botanist, and accordingly placed among the genus *Volvocineæ*, confervoid algæ. Ehrenberg* regarded and described them as Infusoria. He says : "All true Infusoria, even the smallest monads, are organised animal bodies ; some consist of a homogeneous jelly, and are distinctly provided with at least a mouth and internal nutritive apparatus." Perceiving small round spots within the bodies of these animalcules, he judged them to be stomachs, in contradiction to the supposition of the former great philosopher in this branch of science, Müller, in whose work, published in 1773, they were stated to be the animal's eggs. To test the truth of his idea, and convince the world, Ehrenberg fed the little things with colouring matter diffused in the water which contained them. If the water be clear in which the animalcule is living, the stomachs are transparent, more so than the other parts of the body ; but are rendered visible by tinting the water with pure sap green, carmine, or indigo. Some of one of these colours is rubbed on a piece of glass, then a few drops of water added ; a portion of the water is then allowed to run off by tilting the glass on one side, and a little of the remainder of the coloured matter dropped into the water containing the animalcule. Portions of the coloured fluid are swallowed by the animalcule, when the stomachs, from their transparency, are distinctly seen of the same colour as the liquid, while the other portions of the body remain unchanged. Some species of the polygastrica have upwards of 100 stomachs, others only four. Sap green is the colour most easily imbibed by the tiny beings ; carmine shows development better than any other ; whilst the indigo, which Ehrenberg found to answer his purpose most satisfactorily, is rather difficult to manage. Care has always to be observed that the colours are not those that chemically combine with water, but only such as are diffusible through the fluid in a state of minute subdivision, as other-

* Christian Gottfried Ehrenberg, medical counsellor and professor at Berlin, was born at Delitzsch in 1795, and educated at Schulpforta and Leipzig. In 1820-25, he, in company with Hemprich, visited Egypt and Nubia at the expense of the Berlin Academy ; and in 1829 he accompanied Alexander von Humboldt to the Ural Mountains. The results of these journeys he published in various invaluable works, which will hand his name down to posterity with undying honour.

wise they are poisoned by it. This important discovery of feeding the little things on colour set aside the opinion of previous naturalists, that they effected nutrition by cuticular absorption; it also led to a classification, not, as formerly, by shape, but structure.

Monas Termo, or End Monad.—The name given these animalcules is from their appearing, under the greatest power of the microscope, as mere ends or points; in fact, to catch a glimpse of them is very difficult, as they are round in shape, and of a bright transparent appearance.

Monas Atomus.—The atom monad has always a round body, and varies from the 6000th to the 3000th of an inch in diameter; it is of the colour of water.

Monas Grandis.—The great monad appears in a variety of bright colours; it is oval in form, and when floating on the tops of ponds and ditches, the water seems encrusted with slime.

Monas Mica.—The grain monad is about the 1500th of an inch in size, and two oval-shaped bodies are perceptible in it; but that which renders it an object of interest when viewed through the microscope, is a beautiful halo that surrounds it, which is supposed to proceed from cilia, or hair in motion; it is often seen to revolve on its own axis.

Monas Uva.—The grape monad is so named from a resemblance to a bunch of grapes, when the animals form themselves into clusters, as they usually do. They are oval in form, have two cilia, and are wondrously active in pursuing and devouring their lesser brethren, several of whom they consume at a meal, having, according to Ehrenberg, no less than twelve stomachs to fill. They multiply both by eggs and self-division; scientifically, they are termed oviparous and gemmiparous. When they propagate in the latter mode, their bodies divide into four parts, forming as many distinct animals.

The Gonium, or Tablet Monad.—Enclosed in a flat hyaline envelope, irregular in shape, and not larger than one three-hundredth of an inch in length, is discovered a happy community of sixteen bright green-coloured cell masses, which at times exhibit a rhythmical contraction and expansion, as in the Volvox. These are sometimes called *Breast-plate Animalcules* (fig. 95, No. 3). They move about in all directions, upwards and downwards, forwards and backwards, and rolling on the edge like a wheel. The twenty-four cilia projecting from the sides, and eight from the centre, appear to be actively engaged in satisfying that first law of nature, self-preservation by food. They are bound to each other, not only by mutual will, but by six threads or tubes. The four centre animals are usually bigger than the others.

When they have all attained their growth, the shell divides into four parts, leaving four monads on each; these four grow in size, and each again divide into four, hence arises their magic number of sixteen; then, as soon as the sixteen are of a mature size, they divide into a community of four; and thus go on dividing and subdividing, endlessly fulfilling their appointed destiny in links of creation.

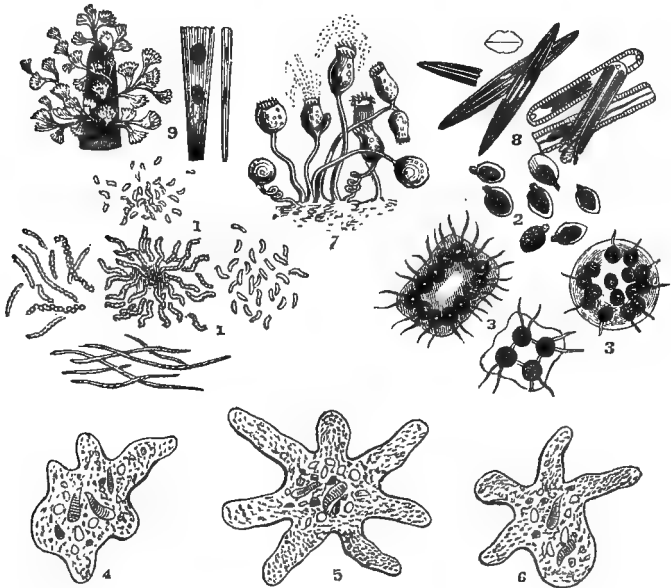

fig. 95. *Infusorial Animalcules.*

1. Group of *Vibrio Spirilla*. 2. *Enchelis*, or Flask Animalcules. 3. *Gonium pectorale*, or Breast-plate Animalcules. 4, 5, 6. *Amæba*, or the *Proteus*, represented in the forms it commonly assumes. 7. *Vorticella cyanthina*, or bell-shaped animalcules. 8. *Berg-mehl*, or Mountain-meal Animalcules. 9. *Echinella*, or Fan-shaped Animalcules; an enlarged view of one is seen by the side of the cluster.

VIBRIO. VIBRIONES.

In this family Ehrenberg includes the well-known eels of paste and vinegar, which must be altogether rejected.

Vibrio Spirilla, *Trembling Animalcules*, when motionless, are seen as very minute hairs; but when they exert the powers of locomotion, they take a spiral form, like the threads of a fine screw, and by undu-

lations wind themselves through the water with rapidity. Each apparent hair is a collection of animals bound together by a pliant band ; thus, as they are individually so small, little is known of their structure. Still they form very interesting objects to view ; their very minuteness claiming attention, while their activity and motions excite surprise. The species are numerous, as represented at No. 1, fig. 95. One in particular has been the especial subject of investigation by the medical microscopist : it is somewhat of an oval shape, and found in many forms of diseased structure ; doubtless it precedes or leads to the entire destruction of the tissue it is found in. This shape of the curious little animalcule, it should be observed, is confined to animal substances ; whereas the long, or hair-shaped, is generally to be met with in the disorganisation of vegetable matters.

These hair-like animalcules were very accurately described by Baker, who ascribes the discovery of them to Mr. Anderson. He says : "They were discovered in a large ditch running into a river near Norwich, the bottom of which was covered with them to some thickness ; when first examined, being motionless, they were taken for vegetable fibres ; but on keeping them under the microscope, and occasionally viewing them, they were seen to move in various forms."

ASTASIAE.

Astasia.—*Astasia*, signifying without a station, in contradistinction to those living in groups, is the term given to a kind of crimson-coloured animalcule the 350th of an inch in length, that exist in enormous numbers, and give the waters in which they live the appearance of their bodies.

Astasia Hæmatodes.—The *blood-like astasia* is first of a green colour ; but as it matures, becomes red, the tint by which it is designated.

Astasia Viridis.—On the surface of ponds and stagnant waters is sometimes seen a crimson covering, which, when examined by a microscope, is found to consist of a mass of oblong *blood-red eye-animalcules* the 300th of an inch in length. Ehrenberg states, that in the early part of their existence they are green ; and that the red and green spots on their bodies are caused by the condition of the eggs at different periods in their stomach-cells. A sparkling red eye is possessed by the living atom ; and a cilium proceeding from its mouth gives it motion, sometimes in a straight line, at others rolling about in all manner of ways. When two cilia are seen, then the animal is about to divide

into two perfect and separate beings, to proceed again in the career of its original. They seem to have the power of changing their shapes at will ; at one time they have a rolling-pin form, at another that of a fish without a tail, and are also seen with their bodies extended at the side like wings. This family corresponds to the *Englenia* of Dujardin ; but they are still very imperfectly known. *Astasia* are distinguished from *Amæba* by the absence of the irregular foot-like process sent out by the latter from all parts of the body.

Enchelia, *Flask Animalcule* (fig. 95, No. 2). These are described by Müller as simple invisible animalcules of a cylindrical form. On the surface of the waters of ponds and ditches is often seen a kind of green scum, from which people are accustomed to turn with disgust, and ascribe to it some injurious property. When this is brought under the powers of the microscope, the water is seen to be pure and clean, and the green found to consist of innumerable slender cylindrical-formed animalcules, whose stomachs, or interiors, impart the colour from being distended with vegetable matter. The wise and loving decrees of Providence are here exemplified, as, by the innate wants of this growing and living speck, varying in size from 1-1200th to 1-400th of an inch, the decaying and putrefying matter is removed, and the noxious effects on man and beast prevented. Others, of the same species of these industrious and useful mites in the animal economy of nature, with their little active ruby-coloured eye, whose masses alone render them visible to the human eye as a coloured substance, exhibit much variety in form and habit.

ACINETINÆA.

The Acineta of Ehrenberg.—*Actinophrys Sol*, “sun-animalcule,” abounds in pools, where *Desmidiaceæ* are found, in many parts of Dorsetshire ; they are ravenous feeders, not only upon the *Desmidiaceæ*, but also upon all kinds of minute spores and animalcules. It was on examining some beautiful *Desmidiaceæ* that my attention was arrested by the curious appearance of two or three very small *Actinophrys* floating very lightly upon the surface of the water in the form of a ball, with their delicate tentacular filaments perfectly erect all over their bodies ; in fact, they seemed to be floating upon these delicate filaments. The creature also seems to be capable of altering its entire form to a certain extent, and to be able to expand and again contract itself *in toto*. Stein’s researches render the existence of this species doubtful, by showing that similar forms are but the intermediate stages of development of *vorticella*.

DIATOMACEÆ.

Among the organic beings, whose existence the microscope has revealed, few possess a higher interest than the group of Infusoria now known as *Diatomaceæ*, or Brittleworts. Appearing every where as the

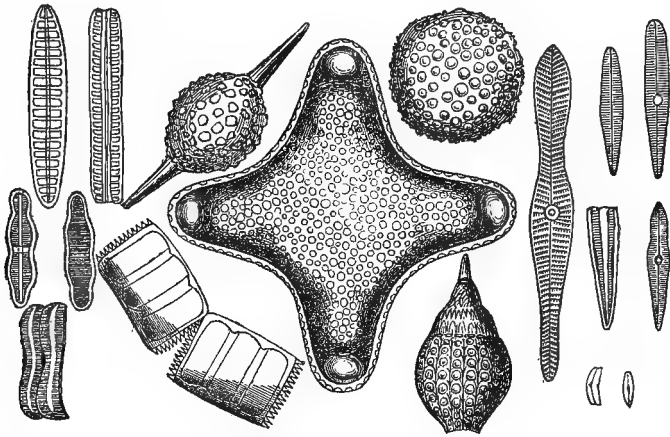

fig. 96. Skeletons of *Diatomaceæ*.

Gomphonema capitatum and *elongatum*; *Diatoma vulgare*; *Achnanthis lineare*, and *coarctatum*; *Amphitetras antediluviana*, front view; *Orthosira spinosa*, front view; with globular and oval forms, found at Springfield, Barbadoes.

first-born of life, and wherever inorganic matter is found in a condition fit for their development, and being provided with a siliceous shell, their forms remain unchanged from the remotest periods of this world's history. Recent specimens are of a green colour, with a tinge of brown; in form generally that of a prism, or four-sided; and their flinty remains consist of one or more pieces, the delicate lines of which, and the fineness of their tracing, set at defiance the most wonderful efforts of imitation. They are found abundantly, both in the inland waters and the ocean, often carried through the air as particles of fine dust. The earliest observers considered them to be animals, undoubtedly; and animals they were decidedly pronounced by Ehrenberg. Later investigators have declared them to belong to vegetables. I believe, with Kützing and others, that they are rightly placed by Ehrenberg among the earliest forms of animal life. During my examinations of the ciliary motion in the *Desmidiaceæ*, near the end of the

summer of 1854, I frequently noticed in many of the more common met-with forms of the Diatomaceæ a similar arrangement of cilia. I have attentively watched a diatomean moving slowly across the field of the microscope; when upon meeting with an obstacle to its progress, it has changed its course, or pushed the obstacle aside, as if conscious of an impediment. I have again and again satisfied myself that their motive power is derived from cilia, so arranged at either end, in some apparently around central openings, that they might readily act as propellers, or paddles. This arrangement is merely indicated in the very rough sketch I made at the time, hoping to have had other opportunities of rendering my illustrations more perfect. Before satisfying myself of the presence of cilia, I thought the motion of these little creatures somewhat remarkable, steering their course as they did by a power which they evidently were able to call into action, or restrain at will. I was therefore agreeably surprised to find this motive power due to cilia. The distribution of the cilia differs from that observed in the *Desmidiaceæ*; the ciliary motion seen in which I believe to be due to a physical force acting independently of any *controlling power*. On the contrary, with the Diatomaceæ, their cilia may be said to act in obedience to a will, for intervals of rest and motion are clearly perceptible.

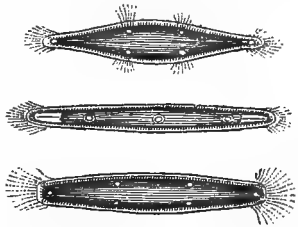

fig. 97.

With Kützing, we may say that every diatomean is formed of a siliceous shield, and a soft substance therein contained; this shield consists of pure silica, or in some cases, perhaps, of silica combined with alumina. Nägeli believes the silica is deposited in the outside organic membrane, but this he believes to be of a vegetable nature. In fact, an organic membrane ought to exist; for the silica could not become solid, except by crystallising or depositing itself on some pre-existing substance. On the other hand, we cannot admit, with Nägeli, that it has been deposited externally; for in many genera, and especially in the *Achnantheidia*, the siliceous shield is covered with a very delicate dilatable membrane, itself containing silica, as is proved by its sustaining unchanged the action of fire and acids. Therefore, comparing this shield with other organic formations, whether animal or vegetable, containing, in like manner, either silica or some other so-called mineral element, we might reasonably consider it to be formed of an organic tissue permeated by silica.

Comparing the arguments which seem to indicate the vegetable nature of Diatomaceæ with those which favour their animal nature, we are of necessity led to the latter opinion. If we suppose them to be plants, we must admit every frustule, every navicula, to be a cell. We must suppose this cell with walls penetrated by silica, developed within another cell of a different nature, at least in every case where there is a distinct peduncle, or investing tube. In this siliceous wall we must recognise a complication certainly unequalled in the vegetable kingdom. It would still remain to be proved that the eminently nitrogenous internal substance corresponded with the genimic substance, and that the oil globules could take the place of starch. The multiplication would be a simple cellular reduplication; but it would remain to be proved that it takes place, as in other vegetable cells, either by the formation of two distinct primitive utracles, or by the introflection or constriction of the wall itself. Finally, there would still remain unexplained the external motions and the internal changes; and we must prove Ehrenberg's observations on the exterior organs of motion to be false. But again, admitting their animal nature, much would remain to be investigated, both in their organic structure and their vital functions; excepting this, so far as we know, we have only one difficulty to overcome, that of the probably ternary non-azotised composition of the external gelatinous substance of the peduncles and investing tubes. But as the presence of nitrogen is not a positive character of *animal nature*, so the absence of it is not a proof of *vegetable*. And in order that the objection should really have some weight, it would be well to demonstrate that this substance is isomeric with starch. For then, supposing all the arguments in favour of the animal nature of Diatomaceæ were proved by new and more circumstantial observations, this peculiarity, if it deserve the name of objection, might still be regarded as an important discovery. We should then have in the animal, as well as in the vegetable kingdom, a ternary substance similar to that forming the basis of the vegetable tissue. "I conclude," observes Kützing, "however, that in the present state of science, the Diatomaceæ are to be enumerated among animals."

I should recommend microscopists to conduct their observations of these and similar bodies in very shallow cells, say of from 1-50th to 1-100th of an inch deep, covered with glass of from 1-150th to 1-250th of an inch thick. The objective must be a 1-4th or 1-8th, with a good eye-piece, and careful illumination—Rainey's moderator with a Gillett's condenser or parabolic reflector. The examination should be conducted during very bright weather, or sunlight.

Did our space permit, many other arguments might be adduced in favour of the views we have herein advocated; but we must refer the reader to the works of Kützing and Ehrenberg for further information.

Dr. Gregory believes that a large number of those Diatomaceæ usually given as separate species, are nothing more than transition forms of the same; and that more extended observation has proved that form, shape, or outline is not nearly so permanent a character as had been imagined; and he adds, "the more the Diatomaceæ are studied, the more we perceive that, in many species at least, the shape or outline is subject to endless variations."*

The markings of the Diatomaceæ are best seen when mounted dry: they are usually mounted in Canadian balsam, or weak spirit and water. Before quitting these interesting objects, we shall notice a few of the commoner forms, reserving our remarks upon other species until we come to fossil Infusoria.

Navicula.—*Navicula* is the Latin word for ship, and has been applied to these little creatures from their resemblance in form to a long ship or boat. In the catalogue of the microscopist there are upwards of twenty-four different species named, fourteen of which are at the present day found alive, fig. 98, Nos. 1, 2, and 3. From their beauty and minuteness, they are used as test objects. It was only in 1841 that Mr. Harrison, of Hull, discovered the beautiful longitudinal and transverse *striæ* (groovings) on the *Navicula hippocampus*, or sea-horse ship, No. 1. A curved graceful line runs down the shell, in the centre of which is an expanded oval opening, and smaller ones at each end. Near to the central opening the dots elongate crossways, presenting the appearance of small short bands. The

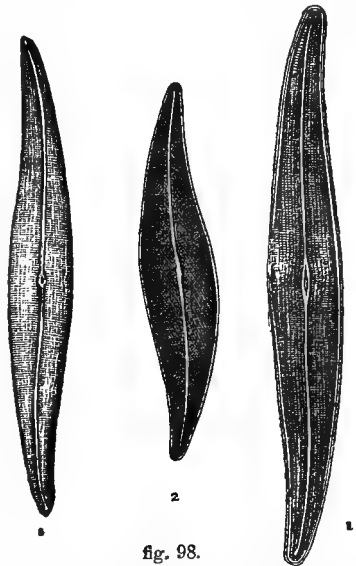

fig. 98.
1. *Navicula hippocampus*. 2. *Navicula angulata*, magnified 250 diameters. 3. *Navicula Spencerii*, magnified 350 diameters.

* Dr. Gregory, "On a remarkable group of Diatomaceous Forms,"—*Quarterly Journal of Microscopical Science*.

Navicula angulata, No. 2, *cornered little ship*, was first discovered in the Humber; the lines upon its surface resemble the most elegant tracery, which are resolvable into raised minute dots.

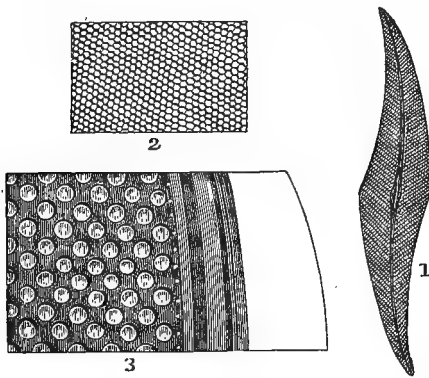

fig. 99.

1. *Pleurosigma angulatum*. 2. Portion of the same, magnified 1200 diameters. 3. Portion of *P. formosum* magnified 5500 diameters.

Nature's works, he feels abashed, and sinks, conscious of the futility of his attempts to rival the accuracy and completeness given by a guiding power to the most insignificant of its creations.

The Green Navicula was found by Dr. Mantell in a pool on Clapham Common; it is about the 100th part of an inch in length. In this specimen the ribbed division is distinctly seen, extending the whole length of its shell.

The Golden Navicula is another beautiful species, and was so named from the numerous points within the shell giving it a bright yellow appearance. The shell is an oblong oval, and has upon it numerous delicate and regular flutings.

The Eunotia.—In this species a furrow is seen the entire length of the shell, from which spring numerous ribs tending towards the edges; of these, eight may be counted in the 1200th of an inch; there can also be traced, in the length, a line, by which, when at maturity, the animal divides, and in this manner preserves its generation from age to age. See Plate II. No. 13.

Siebold says: "I have been unable to detect six openings in the *Navicula*; and precisely at the spots which Ehrenberg and others suppose they have seen openings, the siliceous cell-membrane becomes thickened, and forms rounded eminences which project internally. On the same two surfaces upon which the thickenings of the siliceous

PLATE IV.

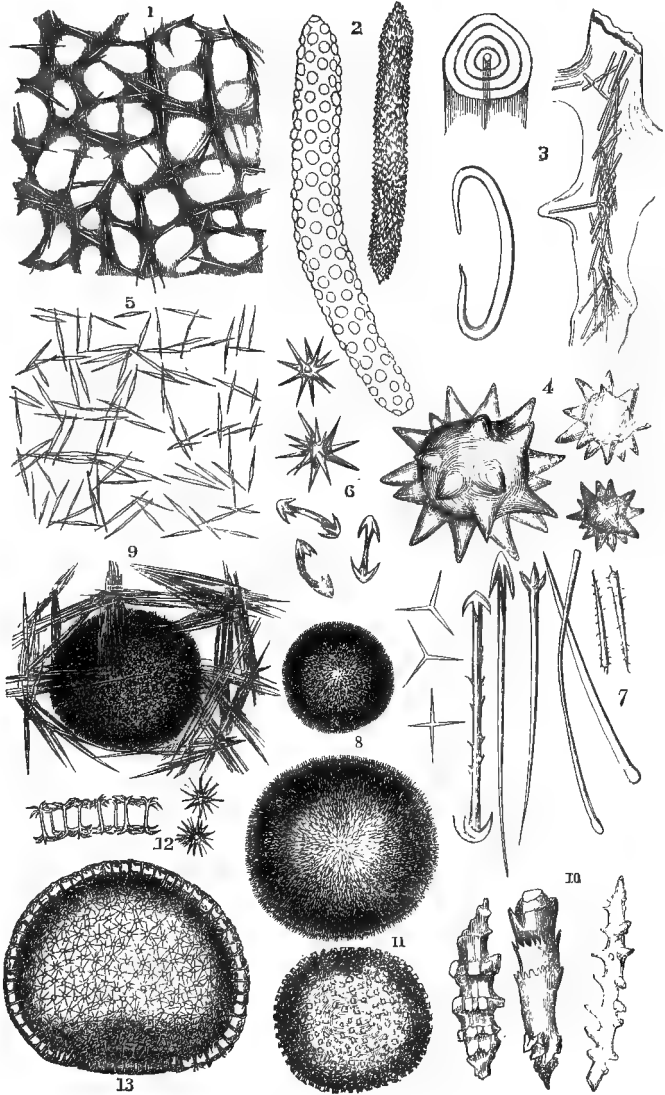

SPICULA FROM SPONGES.

shield of *Navicula* are placed, there may be observed four lines passing along the middle of the surfaces from one thickening to another. These lines—which have been long known, but hitherto little noticed—are to be referred to a suture, fissure, or rather gap, in which no siliceous matter is deposited; so that in these places the delicate primordial membrane which lines the siliceous shield can be brought in close relation with the outer world. It is exactly at these four sutures or fissures that the water surrounding the *Navicula* is set in motion. The existence of this current is readily demonstrated if some minute solid particles be added to the water in which are some fresh *Naviculæ*. When water coloured with indigo has come to a state of rest on the object-glass, it will soon be perceived by the microscope that those particles which come in contact with the living *Naviculæ* are set into a quivering motion, though previously quite still. It will also be perceived, that only those particles of indigo are set in motion which are in contact with the four sutures of the siliceous shield; whilst the particles adherent to the other parts of the shield remain altogether motionless. Another striking motion is perceptible in these particles when they come in contact with the sutures of the siliceous shield, being forced rapidly up and down upon it. Those particles which are propelled from the terminal towards the two central eminences, are never observed to pass beyond the latter; at this point there is always a quiet space, from which the particles are again repelled towards the extremities. This proves that the linear sutures do not extend over the central eminences of the shield. At these clefts the current is sometimes so strong, that comparatively large bodies are set in motion by it.”

COLLECTING AND PRESERVING DIATOMACEÆ.

The following directions by the Rev. W. Smith for collecting and preserving the Diatomaceæ, may prove useful to the student: “Let him provide himself, in the first place, with the necessary apparatus for the field: this includes a good stock of small wide-mouthed bottles, that each gathering may be kept perfectly distinct; a long rod or stick, to which can be attached a small muslin net; a cutting-hook of about three inches in length, and a broad flat spoon; the first, to collect such specimens as float upon the surface, or are held in suspension by the water; the second, to remove the larger algæ which may be covered with parasitic *Diatorus*; and the third, to skim the surface of the mud for those which lie at the bottom of the pool.

He will probably find, notwithstanding every care, that his speci-

mens are mixed with much foreign matter, in the form of minute particles of mud or sand, which impair their value, and interfere with observation, especially with the higher powers of his instrument. These substances the students may remove in various ways : by repeated washings in pure water, and at the same time profiting by the various specific gravities of the Diatorus and the intermixed substances, to secure their separation ; but, more particularly, by availing himself of the tendency which the Diatomaceæ generally have to make their way towards the light. This affords an easy mode of separating and procuring them in a tolerably clean state ; all that is necessary being to place the gathering which contains them in a shallow vessel, and leave them undisturbed for a sufficient length of time in the sunlight, and then carefully remove them from the surface of the mud or water.

The simplest method of preserving the specimens, and the one most generally useful to the scientific observer, is simply to dry them upon small portions of talc, which can at any time be placed under the microscope, and examined without further preparation ; and this mode possesses one great advantage,—that is, that the specimens can be submitted without further preparation to a heat sufficient to remove all the cell-contents and softer parts, leaving the siliceous epiderm in a transparent state.”

In the vicinity of Hull many very interesting varieties of Diatomaceæ have been found, the beauty of the varied forms of which are such as to delight the microscopist ; and, at the same time, some of them are highly useful, as forming that class of *test objects* which are best calculated of all others for determining the excellence and powers of our object-glasses. It has been shown by Mr. Sollitt that the markings on some of the shells were so fine as to range between the 30,000th and 60,000th of an inch ; the *Pleurosigma strigilis* having the strongest markings, and the *Navicula acus* the finest.

DESCRIPTION OF PLATE II.

1. Shell of *Arachnoidiscus*. 2. Shell of *Actinocyclus* (Bermuda). 3. Shell of *Cocconeis* (Algoa Bay). 4. Shell of *Coscinodiscus* (Bermuda). 5. Shell of *Isthmia enervis*. 6. *Zygoceros rhombus*. 7. *Campylodiscus clypeus*. 8. *Amphitetras*. 9. *Gallionella sulcata*. 10. *Triceratium*, found in Thames' mud. 11. *Gomphonema geminatum*, with their stalk-like attachments. 12. *Dictyocha fibula*. 13. *Eunotia*. 14. *Cocconema*. 15. *Fragilaria pectinalis*. 16. *Meridion circulare*. 17. *Diatoma flocculosum*.



FOSSIL INFUSORIA.

TARTLING and almost incredible as the assertion may appear to some, it is none the less a fact, established beyond all question by the aid of the microscope, that some of our most gigantic mountain-ranges, such as the mighty Andes, towering into space 25,250 feet above the level of the sea, their base occupying so vast an area of land ; as also our massive limestone rocks ; the sand that covers our boundless deserts ; and the soil of many of our wide-extended plains ; are principally composed of portions of invisible animalcules. And as Dr. Buckland truly observes, "The remains of such minute animals have added much more to the mass of materials which compose the exterior crust of the globe than the bones of elephants, hippopotami, and whales."

The stratum of slate, fourteen feet thick, found at Bilin, in Austria, was the first that was discovered to consist almost entirely of minute flinty shells. A cubic inch does not weigh quite half an ounce ; and in this bulk it is estimated there are not less than forty thousand millions of individual organic remains ! This slate, as well as the Tripoli, found in Africa, is ground to a powder, and sold for polishing. The similarity of the formation of each is proved by the microscope ; and their properties being the same, in commerce they both pass under the name of Tripoli. One merchant alone in Berlin disposes annually of twenty tons weight. The thickness of a single shell is about the sixth of a human hair, and its weight the hundred-and-eighty-seven-millionth part of a grain. The well-known Turkey-stone, so much used for the purpose of sharpening razors and tools ; the Rotten-stone of commerce, a polishing material ; and the pavement of the quadrangle of the Royal Exchange, are all composed of infusorial remains.

The bergh-mehl, or mountain-meal, in Norway and Lapland, has been found thirty feet in thickness ; in Saxony twenty-eight feet thick ;

and it has also been discovered in Tuscany, Bohemia, Africa, Asia, the South Sea Islands, and South America ; of this, almost the entire mass is composed of flinty skeletons of Diatomaceæ. That in Tuscany and Bohemia resembles pure magnesia, and consists entirely of a shell called *campilodiscus*, about the two-hundredth of an inch in size.

Dr. Darwin, writing of Patagonia, says : “ Here along the coast, for hundreds of miles, we have our great tertiary formation, including many tertiary shells, all apparently extinct. The most common shell is a massive gigantic oyster, sometimes a foot or more in diameter. The beds composing this formation are covered by others of a peculiar soft white stone, including much gypsum, and resembling chalk ; but really of the nature of pumice-stone. It is highly remarkable, from its being composed, to at least one-tenth of its bulk, of Infusoria ; and Professor Ehrenberg has already recognised in it thirty marine forms. This bed, which extends for five hundred miles along the coast, and probably runs to a considerably greater distance, is more than eight hundred feet in thickness at Port St. Julian.” Ehrenberg discovered in the rock of the volcanic island of Ascension many siliceous shells of fresh-water Infusoria ; and the same indefatigable investigator found that the immense oceans of sandy deserts in Africa were in great part composed of the shells of animalcules. The mighty Deltas, and other deposits of rivers, are also found to be filled with the remains of this vast family of minute organisation. At Richmond in Virginia, United States, there is a flinty marl many miles in extent, and from twelve to twenty-five feet in thickness, almost wholly composed of the shells of marine animalcules ; for in the slightest particles of it they are discoverable. On these myriads of skeletons are built the towns of Richmond and Petersburg. The species in these earths are chiefly the *Navicula* ; but the most attractive, from the beauty of its form, is the *Coscinodiscus*, or sieve-like disc, found alike near Cuxhaven, at the mouth of the Elbe, in the Baltic, near Wismar, in the guano, and the stomachs of our oysters, scallops, and other shell-fish. Another large deposit is found at Andover, Connecticut ; and Ehrenberg states, “ that similar beds occur by the river Amazon, and in great extent from Virginia to Labrador.” The chalk and flints of our sea-coasts are found to be principally shells and animal remains. Ehrenberg computes, that in a cubic inch of chalk there are the remains of a million distinct organic beings. The Paris basin, one hundred and eighty miles long, and averaging ninety in breadth, abounds in Infusoria and other siliceous remains. Ehrenberg, on examining the immense deposit of mud at the harbour of Wismar, Mecklenburg-Schwerin, found one-tenth to consist

of the shells of Infusoria ; giving a mass of animal remains amounting to 22,885 cubic feet in bulk, and weighing forty tons, as the quantity annually deposited there. How vast, how utterly incomprehensible, then, must be the number of once living beings, whose remains have in the lapse of time accumulated ! In the frigid regions of the North Pole no less than sixty-eight species of the fossil Infusoria have been found. The guano of the island of Ichaboe abounds with fossil Infusoria, which must have first entered the stomachs of fish, then those of the sea-fowl, and become ultimately deposited on the island, incrustating its surface ; whence they are transported, after the lapse of centuries, to aid the fruition of the earth, for the benefit of the present race of civilised man. The hazy and injurious atmosphere met with off Cape Verd Islands, and hundreds of miles distant from the coast of Africa, is caused entirely by a brown dust, which, upon being examined microscopically by Ehrenberg, was found chiefly to consist of the flinty shells of Infusoria, and the siliceous tissue of plants : of these Infusoria, sixty-four proved to belong to fresh-water species, and two were denizens of the ocean. From the direction of the periodical winds, this dust is reasonably supposed to be the finer portions of the sands of the desert of the interior of Africa.

The deposit of the beneficent Nile, that fertilises so large a tract of country, has undergone the keen scientific scrutiny of Ehrenberg ; and he found the nutritive principle to consist of fossil Infusoria. So profusely were they diffused, that he could not detect the smallest particle of the deposit that did not contain the remains of one or more of the extensive but diminutive family that once revelled in all the enjoyment of animal existence. It is very remarkable that at Holderness, in digging out a submerged forest on the coast, numbers of fresh-water fossil Diatomaceæ have been discovered, although the sea flows over the place at every tide.

Before entering on further details of the fossil Infusoria, we would first state how they may be prepared for microscopic examination. A great many of the infusorial earths may be mounted as objects without any previous washing or preparation ; some, such as chalk, however, must be repeatedly washed, to deprive the Infusoria of all impurities ; whilst others, by far the most numerous class, require either to be digested for a long time, or even boiled in strong nitric or hydrochloric acid, for the same purpose. Place a small portion of the earth to be prepared in a test-tube, or other convenient vessel, capable of bearing the heat of a lamp ; then pour upon it enough diluted hydrochloric acid to about half fill the tube. Brisk effervescence will now

take place, which may be assisted by the application of a small amount of heat, either from a sand-bath or from a lamp: as soon as the action of the acid has ceased, another supply may be added; and the same continued until no further effect is produced. Strong nitric acid should now be substituted for the hydro-chloric, when a further effervescence will take place, which may be greatly aided by heat; after two or three fresh supplies of this acid, distilled water may be employed to neutralise all the remains of the acid in the tube; and this repeated until the water comes away perfectly clear, and without any trace of acidity. The residuum of the earth, which consists of silica, will contain all the infusorial forms; and some of this may be taken up by a fishing-tube, laid on a slide, and examined in the usual manner. Should perfect specimens of the *Coscinodiscus*, *Gallionella*, or *Navicula* be present, they may be mounted in Canada balsam; if not, the slide may be wiped clean, and another portion of the sediment taken, and dealt with in the same way; or, if good, after being dried, may be mounted in Canada balsam.

Dr. Redfern has given us an excellent mode of isolating *Naviculæ* and other test-objects. He says: Having found the methods ordinarily employed very tedious, and frequently destructive of the specimens, I adopted the following plan. Select a fine hair which has been split at its free extremity into from three to five or six parts, and having fixed it in a common needle-holder by passing it through a slit in a piece of cork, use it as a forceps under a two-thirds of an inch objective, with an erecting eye-piece. When the split extremity of the hair touches the glass-slide, its parts separate from each other to an amount proportionate to the pressure, and on being brought up to the object, are easily made to seize it, when it can be transferred as a single specimen to another slide without injury. The object is most easily seized when pushed to the edge of the fluid on the slide. Hairs split at the extremity may always be found in a shaving-brush which has been in use for some time. Those should be selected which have thin split portions so closely in contact that they appear single until touched at their ends. I have also found entire hairs very useful, when set in needle-holders, in a similar manner; any amount of flexibility being given to them by regulating the length of the part of the hair in use.

We now proceed to notice in detail some of the most interesting of the fossil Infusoria.

Professor J. W. Bailey, of New York, has enriched the Museum of the College of Surgeons with several valuable specimens of the skeletons of Infusoria; among them is a fresh-water *Bacillaria*, named

Meridion circulare, which Professor Quekett in the *Historical Catalogue* describes as "consisting of a series of wedge-shaped bivalve siliceous loricae arranged in spiral coils; when perfect, and in certain positions, they resemble circles; each lorica is articulated by two lateral surfaces. It is asserted that they can creep about when free from the stalk-plate. (Plate II. No. 16.)

Cocconimo Boeckii is composed of two lanceolate flinty cases, that taper towards their ends, one of which is attached to a little foot. Each lorica has a line marked in its centre, and transverse rows of dots on both sides; Ehrenberg says there are twenty-six rows in the one-hundredth of a line. (Plate II. No. 14.)

Achnanthes Longpipes have at the margins two coarse convex pieces roughly dotted, and two inner pieces firmly grooved; the inside seems filled with green matter. At one corner they are affixed to a jointed pedicle, which in many specimens contains green granules. They propagate by self-division.

In a specimen of a fossil *Eunotia*, found in some Bermuda earth, the flinty case is in four parts; it is of a half-lanceolate shape, and a little indented on both margins; two of them have curved rows of dots, and the other two are partly grooved with finer rows. Ehrenberg says they have four openings, all on one side (Plate II. No. 13), presenting a row of dots varying very much in number; minute striæ in some cases extend from each dot towards the middle of the lorica; and on the circumference there are two of these dots. The spirals and the individual lorica are very fragile, and therefore easily separated from each other. Of a glistening whiteness is the ribbon-like flinty case of *Fragillaria pectinalis*, which consists of a number of bivalve parts: on the articulating surface there are small grooves, represented in Plate II. No. 15. A singular class of objects are *Diatomæ flocculosæ*, being rather oblong-looking, and joined to each other at opposite corners; sometimes they are grooved on each side. (Plate II. No. 17.)

A recent specimen of the flinty, wedge-shaped *Gomphonema geminatum* (No. 11), fixed on a horny stalk, is in the Museum of the College of Surgeons. Ehrenberg states they have two openings at their hemispherical or indented broad ends. The surfaces are grooved crossways. There is another kind, commonly called the *Swollen Eunotia*, which is generally about from the eleventh to the two-hundredth of an inch in length. A groove, that is widest in the centre, and tapers off to the ends, passes along its centre on both sides, with curved lines proceeding from it. So wonderfully close are these lines or ribs, that as

many as eight of them have been counted in the space of the twelve-hundredth of an inch. They are usually found when alive adhering to a branch of some weed that forms the green coating over stagnant waters. They propagate by self-division ; a slight line running down the centre marks where the separation will occur, on each becoming perfectly developed as a distinct object ; and thus from age to age they grow and separate, filling the earth with their flinty shells. The earth found in the river Upper Baun, Ireland, contains an abundance of *Gallionella distans*, so plentiful in the State of Bilin, and the bergh-mehl of Sweden.

Gallionella Sulcata is found in many parts of North America ; it somewhat resembles the cylindrical box for spices, which was at one time so common among good housewives ; scientifically, it is described as consisting of chains of cylindrical bivalve loriceæ, having their outer surfaces marked or furrowed with longitudinal striæ ; short joints may occasionally be seen having their ends uppermost, the depth of the furrows being shown on the margin ; within the margin is a thin transparent rim having radiating striæ. Sometimes as many as forty will be found joined together (See Plate II. No. 9). The *Gallionella* received its designation from a celebrated French naturalist named Gaillon, and is often termed the *Box-chain Animalcule* ; and when the flinty case is seen lying on its face, it much resembles a coin. These animalcules are found in almost all waters, and are stated to be so rapid in their growth, that one hundred and forty millions will by self-division be produced in twenty-four hours. A species named the *Striped Gallionella* was discovered by Dr. Mantell near London ; the same species is also found in the ocean. Sometimes the chains will be found three inches long ; the size is from the 14th to the 400th part of an inch.

The beautiful *Navicula*, or *Little Ship*, is found in all parts of the world ; and from being met with most readily near London, has been minutely examined and carefully described. Professor Quekett, in the catalogue we have before referred to, describes an "Earth from Bohemia, particularly rich in fossil specimens of *Navicula viridis*, which consists of four prismatic loriceæ, two ventral and two lateral ; the former having round, the latter truncate extremities ; and both provided with two rows of transverse markings and dots, longer and more marked on the ventral than on the lateral surfaces. The specimens having their ventral surfaces uppermost, exhibit a longitudinal marking in the centre, with a slight dilatation or knob at each extremity ; this marking is interrupted in the middle of the lorica, and a diamond-shaped spot is left ; if one of the lateral loriceæ be examined

two of the same spots will be seen, one on each side; they are of triangular figure, and appear to be thicker parts of the shell, described as holes by Ehrenberg. Four smaller triangular spots may be observed in the same lorica, one being situated at each corner; these also have been considered as openings by Ehrenberg: their length varies considerably; some exceed 1-100th, whilst others are even smaller than 1-1000th of an inch.

Isthmia Enervis (No. 5) is found attached to sea-weed. It is in three parts, and of a trapezoid shape. The centre part appears like a band passing over, and is bounded by broad straight lines. Its outer surface is covered with a network of rounded reticulations, arranged in parallel lines. Among the most remarkable are *Amphitetras antediluviana*; they are of a cubical or box-like figure, and consist of three portions, the one in the centre being in the form of a band, as shown at Plate II. No. 8, and the two lateral ones having four slightly-projecting angles, with an opening into each. When viewed in detached pieces, the central one is like a box, and the two lateral portions resemble the cover and bottom. The former may be readily known, as consisting merely of a square frame-work with striated sides; but both the latter are marked with radiating reticulations. When recent, they are found in zigzag chains, from their cohering only by alternate angles. In some instances, as in *Biddulphia* and *Isthmia*, two young specimens may be found within an old one.

Cocconeis is oval, and is marked with eight or ten lines proceeding from the inner margin to the centre; between which are dotted furrows, which leave a small elder spot in the centre. (Plate II. No. 3.) *Campylodiscus Clypeus* is oval, and curved in opposite ways at the long and short diameters. On the margin there are two series of dots, sometimes joined; and on the oval centre there are also dots about the margin, while the middle is nearly plain. (Plate II. No. 7.)

Actinocyclus has a round bivalve flinty case, with numerous cells formed by radiating partitions. Sometimes only every alternate cell is on the same plane. The specimen in the Museum of the College of Surgeons is exquisite in its markings; it was found in some Bermuda earth, and has a beautifully raised margin, and a five-rayed star in the centre; the number of cells is ten, five being on one plane and five on another. One set has the usual hexagonal reticulations crossed with diagonal lines, the other has the same lines, with a much smaller series of triangular reticulations, so disposed that they appear to form with each other parts of minute circles. One of the valves of this specimen is represented in Plate II. No. 2.

Artists who design for art-manufacturers might derive many useful hints from the revelations of the microscope, as evidenced in the arrangement of the shell last noticed, and in that of the genus *Coscinodiscus*, another handsome object; the shells are marked with a network of cells in a hexagonal form, arranged in radiating lines or circles; they vary from 1-200th to 1-800th of an inch in diameter. A specimen found in Bermuda earth has on one of its valves two parallel rows of oval cells that form a kind of cross; they are gradually larger from the centre to the margin. The angles of the cross are filled with the hexagonal cells previously noticed. (Plate II. No. 4.)

The unskilled manipulator may for some time endeavour to adjust a slide, having a piece of glass exposed not larger in size than a pea, on which he is informed an invisible object worthy his attention is fixed, before he is rewarded by a sight of *Triceratium favus*, extracted from the mud of the too-muddy Thames. The hexagonal markings or cells are beautiful, and at each corner there is a curved projecting horn or foot. (Plate II. fig. 10.) In Bermuda earth there is a small species found, which has its three margins curved; and also a curious species, which resembles a triradiate spiculum of sponge.

It is remarkable how, in these minute and obscure organisms, we find ourselves met by the same difficulties concerning any positive laws governing the formation of any generic types, as in the larger and more complex forms of animal and vegetable life. It appears as if we could carry our real knowledge little beyond that of species; and when we attempt to define kinds and groups, we are encountered on every side by forms which set at nought our definitions.

Zygoceros rhombus is in three parts; one central, which is like a broad band, the others lateral, of a rhomboidal shape, and curved; while at each corner is a projecting piece like a spine. It is entirely marked with very small dots. (Plate II. No. 6.)

As well as the beautiful shell of the *Coscinodiscus*, found both in a fossil and recent state, there is one of exquisite elegance and richness of the genus *Arachnoidiscus*, so named from the resemblance of the markings of the shell to the slender fibres of a spider's web. (Plate II. No. 1.) This is met with in the guano of Ichaboe; it is also found in the United States, as well as among the sea-weed from Japan, and the algæ of the Cape of Good Hope. Mr. Shadbolt says: "These shells are not, strictly speaking, bivalves, although capable of being separated into two corresponding portions; but are more properly *multivalves*, each shell consisting of *two* discoid portions, and *two* annular valves

exactly similar respectively to one another." See *Microscopical Society's Transactions* for an excellent paper on these shells by Mr. Shadbolt.

Man even uses infusorial remains as food; for the *berg-mehl*, or *mountain-meal* (represented in fig. 95, No. 8), found in Swedish Lapland, and which, in periods of scarcity, the poor are driven to mix with their flour, is principally composed of the flinty shells of the *Gallionella sulcata*, *Navicula viridis*, and *Gomphonema gemminatum*. Dr. Trail, on analysing it, found it to consist of 22 per cent of organic matter, 72 of silica, 5.85 of alumina, and 0.15 of oxide of iron. This would seem to be the same substance described by M. Laribe the missionary, and put to a similar use in China: "This earth," he says, "is only used in seasons of extreme dearth. One of our Christians, who, at the period of the last famine, fed upon this substance, with five other individuals composing his family, informed me, when they made use of it, they bruised it into a very fine powder, mixing three parts with two of rice-powder, or, better, the flour of wheat, to make small cakes, which were seasoned with salt or sugar. Recourse was only had to this in times of great want; and this being over, no one ever dreamt of making use of it as an article of food. Those accustomed to partake of it complained of a weight at the stomach and constipation. They could subsist for two months on this material formed into cakes; whilst without its assistance, their provisions would only suffice as food for one month. Those persons who employed the fossil-flour without mixing it with vegetable meal, scarcely ever escaped disease."

VORTICELLIDÆ.

We now come to a family which includes some of the most beautiful of the infusorial animalcules, and in which we meet with phenomena more curious than any we have yet witnessed, and perhaps as wonderful as any that will be presented to our notice, when studying the natural history of the higher classes of animals. This is the family of the *Vorticellidæ*, or *bell-animalcules*. The animals of which it is composed are characterised by the possession of a fringe of rather long cilia, surrounding the anterior extremity, which can be exerted and drawn in at the pleasure of the creature. Some are furnished with a horny case for the protection of their delicate bodies, whilst others are quite naked.

The genus *Vorticella*, from which the name given to the family is derived, consists of little creatures placed at the top of a long flexible stalk, the other extremity of which is attached to some object, such as the stem or leaves of an aquatic plant. This stem, slender as it is, is

nevertheless a hollow tube, through the entire length of which runs a muscular thread of still more minute diameter. When in activity, and secure from danger, the little *Vorticella* stretches its stalk to the utmost, whilst its fringe of cilia is constantly drawing to its mouth any luckless animalcule that may come within the influence of the vortex it creates; but at the least alarm the cilia vanish, and the stalk, with the rapidity of lightning, draws itself up into a little spiral coil. But the *Vorticella* is not wholly condemned to pass a sort of vegetable existence, rooted, as it were, to a single spot by its slender stalk; its Creator has foreseen the probable arrival of a period in its existence when the power of locomotion would become necessary, and this necessity is provided for in a manner calculated to excite our highest admiration. At the lower extremity of the body of the animal, at the point of its junction with the stalk, a new fringe of cilia is developed; and when this is fully formed, the *Vorticella* quits its stalk, and casts itself freely upon its world of waters. The development of this locomotive fringe of cilia, and the subsequent acquisition of the power of swimming by the *Vorticella*, is generally connected with the propagation of the species, which, in this and some of the allied genera, presents a series of most curious and complicated phenomena.

The *Vorticella* possess means of propagation which is denied to other Infusoria, with the exception of a few nearly allied genera, although we shall meet with it again in other classes of animals. The mode of reproduction is called *gemmation*. It consists in the production of a sort of bud, which gradually acquires the form and structure of the perfect animal. In the *Vorticellæ*, these buds, when mature, quit the parent stem after developing a circlet of cilia at the lower extremity, and fix themselves in a new habitation in exactly the same manner as the individuals produced by the division of the bell.

At an earlier or later period of their existence, the *Vorticellæ* withdraw the disc surrounded by cilia, which forms the anterior portion of their bodies, and contracting themselves into a ball, secrete a gelatinous covering, which gradually solidifies, and forms a sort of capsule, within which the animal is completely inclosed. By this process the little animal is said to become *encysted*; and at this point of its history it is seen to be more complicated. Sometimes its further progress commences by the breaking up of the nucleus into a number of minute oval discs, which swim about in the thin gelatinous mass into which the substance of the parent has become dissolved. The body of the parent animal inclosed within the cyst now becomes apparently divided into separate little sacs or bags, some of which gradually acquire a con-

siderable increase in size, and at length break through the walls of the cyst. After a time one of these projections of the internal substance bursts at the apex; and through the opening thus formed the gelatinous contents of the cyst, the enclosed embryos, are suddenly shot out into the water, there to become diffused, and give rise to a new generation. From the name *Acineta* given by Ehrenberg to these, who described them as a new genus, they are denominated Acineta-forms.

But the final object of this singular metamorphosis still remains to be described. The nucleus, which at the change of the encysted animalcule into the Acineta-form was still distinctly observable, becomes entirely and altogether converted into an active young *Vorticella*, acquiring an ovate form, with a circlet of cilia round its narrower extremity, and presenting at the opposite end a distinct mouth. Within this young animal, whilst still inclosed in the body of its parent, we see a distinct nucleus and the usual contractile space of the full grown creature. When mature, the offspring tears its way through the membranes inclosing the Acineta, which however immediately close again. The latter continues protruding and retracting its filaments, and soon produces in its interior a new nucleus, which in its turn becomes metamorphosed into young *Vorticella*.

The same faculty of inclosing themselves in a cyst is said to be made use of by the *Vorticella*, as a means of self-preservation when the water in which they have been residing dries up. When the animal is thus encased, the mud of the bottom of the pool may be baked quite hard in the sun without doing it the least injury; and in this state the creatures are often taken up by the wind with the dust which it raises from the surface of the parched ground and borne along to great distances, so as to cause their appearance in most unexpected localities (they are frequently found in roof gutters), where the first shower of rain calls them back to active life. These processes are repeated in several of the allied genera with so little variation, as far as observations have hitherto shown, that it will be unnecessary to mention them more particularly.

Vorticella cyanthina, fig. 95, No. 7, has a fringe of cilia surrounding the margin of its cup. A single animal is first seen, which increases and then divides into two perfect animals, joined by a stem.

Stentor, or *Trumpet Animalcule*, belongs to this family, fig. 100, No. 4. Its body is of a trumpet-shape, and it adheres to its point of attachment by a pointed extremity. They are of various colours—white, blue, yellow, red, and green. They swim in a parallel line to their sides, sometimes tail first, rotating on their own axis. They attach them-

selves to objects by a sucker at the lower part. Some of them have cilia over their entire bodies, and a good fringe over their gaping mouths, which is a type of their ravenous nature. The prey may be seen in their row of stomachs, as if strung like a strap of beads up and down its interior. They differ from many gluttons by possessing great activity, moving swiftly through the water. They are said to increase both by eggs and self-division. There are many species, differing in size, shape, and colour. Usually they are about the hundredth part of an inch in size. When found, they appear a mass of green jelly encircling a twig. Often, when swimming, they take the form of a cup, having their tails drawn within their bodies.

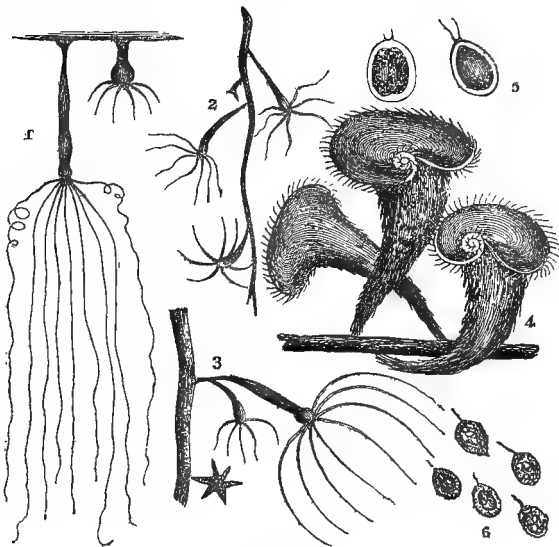

fig. 100.

1, 2, 3. *Hydræ*, or *fresh-water Polyps*, attached to the stem of a plant 4. A group of *Stentor polymorphus*, or *Multi-shaped Stentor*. 5, 6. *Monads*, *Viviparous* and *Cloak Monads*.

Stentor Cœruleus, or *Blue Stentor*, is remarkable from having a crest extending along its body; it assumes a peculiar shape when swimming, appearing to possess a thick tail nearly one half the breadth and length of its body.

Upon quitting these animalcules, we may notice this peculiarity, that when they are procured from infusions the first instances of life

are generally the Monads, which in a very short period increase to a most extraordinary extent. These afterwards gradually decrease, larger and more perfect creatures supplying their place, as the Peridinida, Paramesia, Trachelina, Acineta, and others; and these, again, are supplanted by the Vorticellæ and Branchionæ. Though the generations thus rise up, there is no regular order in their doing so, even in the same infusions.

THE ROTATORIÆ, ROTATING OR WHEEL-ANIMALCULES.

This higher grade of the Infusoria, now classed among the Articulata, derives its name from the appearance presented by the motion of its circles of cilia on the superior part of its body, which resembles the turning round of a wheel, as they rapidly vibrate. Many have been

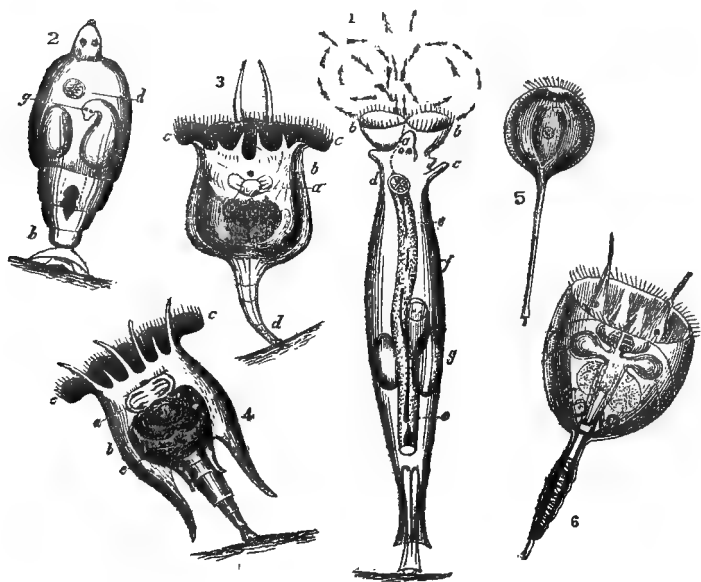

fig. 101.

1. The common Wheel-Animalcule, with its cilia or rotators pointed. 2. The same in a contracted state at rest: at *g* is seen the development of the eyes in the young. 3. Pitcher-shaped-Brachionus: *a* the jaws; *b* the shell; *c* the cilia, or rotators; *d* the tail. 4. Baker's Brachionus: *a* the jaws and teeth; *b* the shell; *c* the rotators; *e* the stomach. 5 and 6. Other forms of the same family.

the speculations as to the mechanism of this beautiful movement: some have considered it as a magnetic or electrical force; and as one passes

out of sight while the next appears, adding to the optical illusion, a philosopher of considerable note was led to look upon the whole as a deception of the sight, and affirmed they had no existence. The cilia processes appear but in one part of the Rotifera ; whereas in the Vorticellidæ, cilia are seen in various parts of the body.

These animalcules are only discovered in water, which is their native element ; still they are found in damp earth, and are indwellers of the cells of moss and sea-weed. They possess but one stomach, and generally have teeth and jaws to supply its wants. They can elongate and contract their bodies ; and some species have at their extremity a kind of tail with a sucker, by which they affix themselves to extraneous substances while the cilia is in rapid motion, and thus prevent the superior portion of the body being drawn in by the force of the rotatory action. They multiply by eggs ; but some bring forth their young alive. Both the animal and its eggs possess extraordinary tenacity of life, and will undergo the most opposite extremes of circumstances without destruction to the living principle.

In the atmosphere the eggs may often be discovered whirling along by the force of the wind to some resting-place, where, when circumstances admit, they spring into active life, and fulfil their appointed destiny. Ehrenberg accurately described the upper part of a common wheel-animalcule, with the cilia, jaws, teeth, eyes, as seen under a magnifying power of 200 diameters, represented at 1, fig. 101.

The small arrows show the direction of the currents produced by the cilia turning on their base. At the will of the animal a change is made in the direction in which the wheels appear to revolve, and they have the power of withdrawing, with the quickness of thought, the whole of the wheel-work ; when this is done, the head is elongated, and with a telescopic appearance, as if capable of sliding within itself. On assuming this form, a cluster of hairs appears at the extremity, that do not revolve, and are considered different from the cilia : as they are usually protruded when the creature is moving from place to place, their functions have been imagined to be that of feelers, shown in No. 2.

The red spots supposed to be the eyes of the Rotatoria are generally of a bright red colour ; but the number and arrangement of these organs vary. In some kinds there have been discovered as many as eight, sometimes placed on each side of the head, in a row, in a circle, or in clusters ; and in others, in a triangular shape.

Ehrenberg, from actual observation, found that the Rotatoria laid four eggs a day ; that the young, when two days old, followed the same law as their parents ; consequently, a single one in ten days had a

family of 1,000,000, in eleven days 4,000,000 ; and in twelve days the venerable progenitor was surrounded by 16,000,000 of an active, happy, energetic race, ceaseless in search of prey, and a famous feast for a larger animal.

The Rotatoria delight in the sunshine ; and when the bright luminary is hidden behind clouds, the animals sink down to the bottom of the water, and there remain. When the water of their haunts is becoming much evaporated, they rise to the top, and give a bright-red tint to it ; but when caught and placed in a jar, their beautiful colour fades in a few days. Locomotion is performed by swimming, the rotatory action of the crowns of cilia impelling it forward ; in other instances it bends its body, then moves its tail up towards the head, which it can do from having two processes that serve as feet near to the tail ; it then jerks its head to a further distance, again draws up its tail, and so proceeds on its journey. Another peculiarity they possess of drawing in the head and tail until nearly globular, from remaining in this condition fixed by the sucker ; at other times they become a complete ball, and can be rolled about by any agitation in the water.

The eggs are of an oval form, and from twenty to thirty may be seen in an animal. Some are of a brown colour, and others of a delicate pink and deep golden yellow. In those of a light colour, the young may be seen with their cilia in active vibration.

The body of the wheel-animalcule is of a whitish colour ; its form will be seen by the engraving ; and its tail has six points. The tube for respiration appears to allow of water passing to the inside. On the food being drawn by the currents to the cup part of the wheels, it passes down canals in the neck to the mouth, which is situated at the lower extremity of that part of the body. The food is crushed by the teeth on the plates of the jaw, with an action like a hammer. From this it passes on to the alimentary canal for the sustenance of the animal.

BRACHIONÆA.

Ehrenberg's genus *Brachionus*, or *Spine-bearing Animalcule*, belonging to the Rotatoria, are truly interesting from their perfect, high, and complex organisation. Some are entirely enclosed in a shell, and others only partially covered. Their structure is so beautiful and symmetrical as to cause them to be favourites with those who delight in the studies of microscopic observation.

Brachionus Striatus, or *Striped Shell Animalcule* (No. 3, fig. 101), is of an elegant, jug-like form, the transparent shell being fluted length-

wise, and having six scallops at the upper part, whence the pale citron-coloured inhabitant protrudes itself. Two horn-like processes are appended to its under-side. As occasions require, it sinks firmly and securely within its crystal home, through the sides of which its organisation can be distinctly seen. Its progress is effected by means of its rowing cilia.

Brachionus Pala, or *Bent Horn Animalcule*, *Anuræ Cervicornis*, is possessed of double rotatory organs, and four long processes, that project above the oval shell. It measures the 90th part of an inch.

Brachionus Ovalis, or *Egg-shaped Brachionus*, is remarkable for the strength of its transparent shell, which is beyond that of other shelled creatures. Its projecting tail, as well as head, can at pleasure be withdrawn into its powerful case. It attains to about the 250th of an inch in size.

Brachionus Tripes, or *Three-spined Brachionus*, has its shell in two parts, united by a joining at the back; it ends in three spines, and between the two first projects its cleft tail.

Brachionus Dentatus, or *Toothed Brachionus*. This active, bright, pink-eyed little creature, the 90th part of an inch in size, is enclosed in a two-valved shell, having each end indented so as to form two pair of teeth. Mr. Pritchard says: "In addition to the rotatory organs for supplying it with food, I have observed it attached to a stem of confervæ, and abrading it with its teeth fixed in the bulbous œsophagus, which, during the operation, oscillates quickly; the rotatory cilia at the same time move rapidly, which makes it highly probable that they perform some office connected with the organs of respiration, as their motion seems altogether unnecessary while the creature is feeding in this manner."

Brachionus Urceolaris, or *Flower-pot Brachionus*, resides in a shell one-half its own length, from which it thrusts out its tail at one end, and its vibrating cilia at the other: at this latter part it has sharp indentations at one side, and flowing scallops at the other.

Brachionus Bakeri, or *Baker's Brachionus* (fig. 101, No. 4), is a curious and beautifully-formed animal. At the points of a half-circle are situated the rotatory organs and cilia, between which rise some long spines, each side of the shell proceeding to a point in the lower part, while a square seems taken out of its body, forming thus two spines; from the centre projects a long tail. The eggs are sometimes attached to the spines, and in other instances to the tail.

Notommata Aurita, the *Eared Notommata*.—The anatomy of this animal, of the Rotatoria family, is most lucidly explained and beauti-

fully illustrated by Mr. P. H. Gosse in the *Microscopical Society's Transactions*.

Mr. Gosse states, that his specimens were found in a jar of water obtained in the autumn from a pond near Walthamstow, the jar having stood in his study-window through the winter; and from a swarm in the succeeding February he selected one the 70th of an inch in length when extended, but its contractions and elongations rendered its size variable.

"Its form, viewed dorsally, is somewhat cylindrical, but it frequently becomes pyriform by the repletion of the abdominal viscera. Viewed laterally, the back is arched, gibbous posteriorly, with the head somewhat obliquely truncate, the belly nearly straight. The posterior extremity is produced into a retractile foot, terminating in two pointed toes; this, both in function and structure, is certainly analogous to a limb, and must not be mistaken for the tail, which is a minute projection higher up the body. When not swimming or rotating, the head assumes a rounded outline, displaying through the transparent integument an oval mark on each side, within which a tremulous motion is perceived; but at the pleasure of the animal a semi-globular lobe is suddenly projected from each of these spots by evolution of the integument. These projections have suggested the trivial name of *aurita*. Each lobe is crowned with a wheel of cilia, the rapid rotation of whose waves forms the principal source of swift progression in swimming. The protrusions of these lobes are evidently eversions of the skin, ordinarily concealed in two lateral cavities. They may be protruded by pressure, and are then seen to be covered with long but firm and close-set cilia, which are bent backward, and move more languidly, as death approaches. The whole front is also fringed with short vibratile cilia, which extend all along the face, as far as the constriction of the neck. The whole body is clear and nearly colourless; but its transparency is much hindered by the net-work of dim lines and corrugations that are every where seen, particularly all about the head."

Mr. Gosse, on putting carmine into the water, saw the jaws working slightly, the points opening a little way, and then closing; the rods of the hammers were drawn towards the bottom for opening, and upwards for closing. A little mass of pigment was soon accumulated beneath the tips of the jaws, which spread itself over a rounded surface, but did not pass farther; nor did an atom at this time go into the stomach.

After entering into further minute details of the little animal, he observes: "They possess organs that many others do not, and want some

that others possess. They prove that the minuteness of the animals of this class does not prevent them from having an organisation most elaborate and complex; and therefore it justifies the belief that the Rotifera occupy a place in the scale of animal life much higher than that which has been commonly assigned to them."

Of the manners of the species, this careful observer states, that, in a phial, it frequently clings to the sides of the glass, and appears sluggish; but when put into a live-box it is active, especially if there be any confervæ, or leaves of chara, or roots of lemna, in the water. Among these it crawls about nimbly and impatiently, like a caterpillar, pushing itself in every direction, by means of its two-toed foot, and by the elongation and contraction of its body, but without any definite course.

It commonly keeps its ear-like lobes concealed while crawling; but will often suddenly protrude them, and in the same instant shoot off through the water with considerable rapidity, and with a smooth, gliding motion, partially revolving on the longitudinal axis as it proceeds.

Like most of the class, this Notommata is predatory. Mr. Gosse once saw one eagerly nibbling at the contracted body of a sluggish *Rotifera vulgaris*; the mouth was drawn obliquely forward, and the jaws were protruded to the food, so as to touch it. It did not appear, however, to do the rotifer much damage. It seemed chiefly to feed on monads.

FLOSCULARIDÆ.

The Stephanoceros, or Crowned Animalcule.—This beautiful little creature is about the 36th of an inch in length. It is enclosed in a transparent cylindrical flexible case, over which it protrudes five long arms in a graceful manner, which, touching at their points, give the form from which it derives its name. These arms are furnished with several rows of short cilia, and retain the prey brought within their grasp until it is swallowed. The case is attached to the animal on the part we may term the shoulders; so that when it shrinks down in its transparent home, the case is drawn inwards. To the bottom of its home it is fastened by an elongation of the body; and this part, as well as the body, contracts instantly on the approach of danger, the arms coming close together and into the sheath. Its mouth differs a little from the common wheel-animalcule, as it has two distinct sets of teeth, with which it tears and crushes its food. The eggs of the *Stephanoceros*, after leaving the animal's body, remain in the crystal-like shell until hatched, when they escape from the lower part. A cluster of eggs may be generally seen in the ovisac. Dr. Mantell, from close observation,

found that about eighty hours elapsed before their organs were all developed.

Limnias Ceratophylli, or *Water-Nymph*, is of this family, and is about one-twentieth of an inch in size, residing in a white transparent cylindrical case, one-half the length of the animal; which being glutinous, becomes of a brownish colour, from the adhesion of extraneous matter. Its rotatory apparatus is divided into two lobes, possessing vibrating cilia, as well as a singular projecting angular chin. The Water Nymph, when young, is said to have two red eyes; but they fade away as the term of their existence draws to a close. The body of the animal is fixed to the bottom of its little horn; and, by means of the attachment, it can retire on the slightest symptom of danger, or protrude itself out of it in search of that sustenance requisite to its existence. In the rows of little eggs seen in the body of the parent may clearly be distinguished many of the particular organs in a state of activity. From its fondness for *hornwort*, it often receives the name of that plant.

Floscularia Ornata, or *Elegant Floscularia*, is a beautiful type of this family, and has its rotatory organs divided into several parts; when it draws itself into a small compass, its transparent covering becomes wrinkled. This forms an interesting object, as its internal structure can be well seen through the translucent sheath that constitutes its dwelling. The little beings are very rapacious, although but the 108th part of an inch in size.

Floscularia Proboscidea, or *Horned Floscularia*, has six lobes fringed with cilia shorter than in the preceding kind. The name that distinguishes it arises from a kind of horn or proboscis, also having cilia, that is placed in the centre of the lobes. The eggs cast off by the parent are seen in the sheath, and are very pretty objects for microscopic observation. In fact, the tinted case, the light ethereal frame of the tiny animal, and the various colours of the food in the stomach, combine in rendering it deeply interesting.

Melicerta Ringens, or *Beaded Melicerta*.—Among the *Melicerta*, or *Honey floscularia*, this is the most beautiful. Its crystalline body is first enclosed in a pellucid covering, wider at the top than the bottom, of dark yellow, or reddish-brown colour, which gradually becomes encrusted with zones of a variety of shapes, glued together by some peculiar exudation that hardens in water: it is these little pellets that, appearing as rows of beads, give the name to the animal.

Mr. Gosse has given an excellent account of the "architectural instincts of *Melicerta Ringens*," which is not only truly surprising, but

full of interest. He says, it is an animalcule so minute as to be with difficulty appreciable by the naked eye, inhabiting a tube composed of pellets, which it forms and lays one by one. It is a mason, who not only builds up his mansion brick by brick, but makes his bricks as he goes on, from substances which he collects around him, shaping them in a mould which he carries upon his body.

The animal, as it slowly protrudes itself from its ingeniously-formed mansion, appears a complicated mass of transparent flesh, involved in many folds, displaying at one side a pair of hooked spines, and at the other two slender short blunt processes projecting horizontally. As it exposes itself more and more, suddenly two large rounded discs are expanded, around which, at the same instant, a wreath of cilia is seen performing its surprising motions. Often the animal contents itself with this degree of exposure; but sometimes it protrudes farther, and displays two other smaller leaflets opposite to the former, but in the same plane, margined with cilia in like manner. The appearance is not unlike that of a flower of four unequal petals, from which circumstance Linnaeus gave it the name *ringens*, by which it is still known.

Below the large petals on the ventral aspect, and just above the level of the projecting respiratory tubes, is a small circular disc or aperture, within the margin of which a rapid rotation goes on. This little organ, which seems to have hitherto escaped observation, he, Mr. Gosse, can compare to nothing so well as to one of those little circular ventilators which we sometimes see in one of the upper panes of a kitchen-window, running round and round, for the cure of smoky chimneys.

The gizzard, or muscular bulb of the gullet, is always very distinct, and its structure is readily demonstrated. It consists of two sub-hemispherical portions, or jaws, each of which is crossed by three developed teeth, which are succeeded by three or four parallel lines, as if new teeth might grow from thence. The teeth are straight, slender, swelling towards their extremity, and pointed. These armed hemispheres work on each other, and on a V-shaped or tabuliform apparatus beneath, common to most of the Rotifera, but in this genus very small.

The pellets composing the case are very regular in form and position: in a fine specimen, about 1-28th of an inch in length when fully expanded, of which the tube was 1-36th of an inch, Mr. Gosse counted about fifteen longitudinal rows of pellets at one view, which might give about thirty-two or thirty-four rows in all.

In November 1850, Mr. Gosse found a fine specimen attached to a submerged moss from a pond at Hackney; this he saw engaged in

building its case, and at the same time discovered the use of the curious little rotatory organ on the neck. When fully expanded, the head is bent back at nearly a right angle to the body, so that the disc is placed nearly perpendicularly, instead of horizontally; the larger petals, which are the frontal ones, being above the smaller pair. Now, below the large petals (that is, on the ventral side) there is a projecting angular chin, which is ciliated; and immediately below this is the little organ in question. It appears to form a small hemispherical cup, and is capable of some degree of projection, as if on a short pedicle. On mixing carmine with the water, the course of the ciliary current is readily traced, and forms a fine spectacle. The particles are hurled round the margin of the disc, until they pass off in front through the great sinus, between the larger petals. If the pigment be abundant, the cloudy torrent for the most part rushes off, and prevents our seeing what takes place; but if the atoms be few, we see them swiftly glide along the facial surface, following the irregularities of outline with beautiful precision, dash round the projecting chin like a fleet of boats doubling a bold headland, and lodge themselves one after another in the little cup-like receptacle beneath. Mr. Gosse, believing that the pellets of the case might be prepared in the cup-like receptacle, watched the animal; and presently had the satisfaction of seeing it bend its head forward as anticipated, and after a second or two raise it again, the little cup having in the meantime lost its contents. It immediately began to fill again; and when it was full, and the contents were consolidated by rotation, aided probably by the admixture of a salivary secretion, it was again bent down to the margin of the case, and emptied of its pellet. This process he saw repeated many times in succession, until a goodly array of dark-red pellets were laid upon the yellowish-brown ones, but very irregularly. After a certain number were deposited in one part, the animal would suddenly turn itself round in its case, and deposit some in another part. It took from two and a half to three and a half minutes to make and deposit a pellet. Some atoms of the floating carmine now and then passed down the gullet into the gizzard, and thence into the stomach; but these were quite independent of, and unconnected with, the pellets, which were composed exclusively out of the torrent that had passed off the disc. On one occasion the cup was brought down to the margin, but, from some cause or other, failed to deposit its pellet; it was raised for a moment, and then a second attempt was made, which was successful.

Such is the vivid picture and perfect description of the wondrous mechanism and ingenuity of this singular and beautiful animal.

Before quitting the consideration of the *Protozoa*, we must refer to a curious group of minute parasitic creatures, the genus *Gregarina*, of which we know six distinct species, all of them Entozoa, and all organised as simple cells, but endowed with contractility and expansibility quite sufficiently to put their animal nature beyond a doubt, and which appear to be more nearly allied to the Infusoria than to any other class in the animal kingdom. They are to be found in the intestines of the common garden worms, insects, and many other members of the articulate division of animals, and are but rarely to be met with in animals of any other group. These animals are generally of a cylindrical or somewhat elliptical form, although sometimes a sort of head appears to be produced by the constriction of the anterior extremity of the body, and this head-like portion is occasionally furnished with a curious soft process and lobes. They are very sluggish in their movements, although a few possess true cilia. Their curious mode of developments, with other points in the history of these minute parasites, are well worthy of investigation.

We have taken a rapid survey of some of the marvellous creations in the busy invisible world ; every glimpse inspiring awe, from the immensity, variety, beauty, and minuteness of the organised habitants.

Immensity, in its common impression on the mind, hardly conveys the idea of the myriads upon myriads of Infusoria that have lived and died to produce the tripoli, the opal, the flints, the bog-iron, ochre, and the limestone of the world.

Professor Owen beautifully explains the uses of this vast amount of animalcule life :

“ Consider their incredible numbers, their universal distribution, their insatiable voracity ; and that it is the particles of decaying vegetable and animal bodies which they are appointed to devour and assimilate. Surely we must, in some degree, be indebted to these ever-active, invisible scavengers, for the salubrity of the atmosphere and the purity of water. Nor is this all ; they perform a still more important office in preventing the gradual diminution of the present amount of organised matter upon the earth. For when this matter is dissolved or suspended in water, in that state of comminution and decay which immediately precedes its final decomposition into the elementary gases, and its consequent return from the organic to the inorganic world, these wakeful members of nature’s invisible police are every where ready to arrest the fugitive organised particles, and turn them back into the ascending stream of animal life. Having converted the dead and decomposing particles into their own living tissues, they

themselves become the food of larger Infusoria, and of numerous other small animals, which in their turn are devoured by larger animals; and thus a food, fit for the nourishment of the highest organised beings, is brought back, by a short route, from the extremity of the realms of organised matter. These invisible animalcules may be compared, in the great organic world, to the minute capillaries in the microcosm of the animal body; receiving organic matter in its state of minutest subdivision, and when in full career to escape from the organic system, turning it back, by a new route, towards the central and highest point of that system."

Such, then, seem to be some of the purposes for which are created the wonderful invisible myriads of infusorial animalcules. In the words of Holy Writ: "All these things live and remain for ever for all uses; and they are all obedient. All things are double one against another; and He hath made nothing imperfect. One thing establisheth the good of another; and who shall be filled with beholding His glory?"

PORIFERA.

SPONGES.*

THE term *Porifera*, or *Canal-bearing Zoophytes*, was applied by Professor Grant to designate the remarkable class of organised beings usually known as sponges, which are met with in most seas, growing in great abundance on the surface of rocks.

Ellis, in the course of his investigations, was astounded by discovering that sponges possessed a system of pores and vessels, in which sea-water passed, with all the appearance of the regular circulation of fluids in animal bodies, and a seeming purpose of conveying animalcules to the animal for food. Professor Owen gives it as his opinion

* DESCRIPTION OF PLATE IV.

1. Portion of sponge, showing siliceous spicula imbedded in a soft matrix. 2. Skeleton of sponges of the acerate form, covered with rows of spines. 3. Showing rings of growth, and a portion of horny fibre, enclosing a bundle of spicula of the genus *Verongia*. 4. Sphero-stellate spicula of *Tethea*. 5. Portion of sponge mounted in Canada balsam, showing the spicula more plainly. 6. Tricuspid-anchorate spicula, sphero-stellate. 7. Acuate-biclavate, double recurvo-ternate, expando-ternate, detri-
radiate spicula. 8. Gemmules of *Geodia*. 9. Gemmules of *Spongilla fluviatilis* enclosed in spicula. 10. Clavate spicula, covered with short spines. 11. Gemmules of *Geodia* in an advanced stage of growth. 12. Birotulate spicula from the *Fluviatilis*. 13. Gemmules of *Spongilla fluviatilis* immersed in acid, to show its coating of birotulate spicula.

that sponges should be placed in the vegetable kingdom : “ The living sponge, when highly magnified, exhibits a cellular tissue, permeated by pores, which unite into cells or tubes, that ramify through the mass in every direction, and terminate in larger openings. In most sponges the tissue is strengthened and supported by spines, or spicula of various forms ; and which, in some species, are siliceous, and in others calcareous. The minute pores, through which the water is imbibed, have a fine transverse gelatinous network and projecting spicula, by which large animalcules or noxious particles are excluded ; water incessantly enters into these pores, traverses the cells or tubes, and is finally ejected from the larger vents. But the pores of the sponge have not the power of contracting and expanding, as Ellis supposed ; the water is attracted to these openings by the action of instruments of a very extraordinary nature (cilia), by which currents are produced in the fluid, and propelled in the direction required by the economy of the animal.”

On the disputed point of sponges being animals, Dr. Johnston remarks : “ Although I agree with the advocates of the animality of zoophytes in general, I cannot go the length of Ellis in considering it proved that sponges and corallines belong to the same class. Ellis, we have seen, knew that no polyps were to be found in sponge ; and their existence in the pores of corallines was inferred merely from the structure of these latter, and their chemical composition. They have been examined by subsequent naturalists fully competent to the task ; and under the most favourable circumstances,—in particular by Cavolini and Schweigger,—and the result has been a conviction that these productions are truly apolypous. Now this fact, in my opinion, determines the point ; for if they are not the productions of polyps, the zoologist who retains them in his province must contend that they are individually animals ; an opinion to which I cannot assent, seeing that they have no animal structure or individual organs, and exhibit no one function usually supposed to be characteristic of that kingdom. Like vegetables, they are permanently fixed ; like vegetables, they are non-irritable ; their movements, like those of vegetables, are extrinsic and involuntary ; their nutriment is elaborated in no appropriate digestive sac ; and, like cryptogamous vegetables, or algæ, they usually grow and ramify in forms determined by local circumstances ; and if they present some peculiarities in the mode of the imbibition of their food, and in their secretions, yet even in these they evince a nearer affinity to plants than to any animal whatever.”

Müller writes on this question : “ If, therefore, it is still a matter

of doubt whether certain simple organised beings, such as the *Sponges* and several so-called *Alcyonella*, are animal or vegetable, the absence of all voluntary motion in these bodies, whether of the whole or of individual parts of it, must determine the question; and they must more properly be numbered among the vegetable marine structures. It may certainly be said, that the embryo of sponges (as Dr. Grant has shown), like the embryo of polyps and corals, moves by means of cilia; but the distinctive marks between the embryo of sponges and marine Infusoria are by no means certain, and similar motions have been many times observed in the embryo of true vegetables,—of the algæ, for example.”

Again, we read that “M. Dujardin, having repeated his observations on spongillæ, or fresh-water sponges, as well as others on marine sponges, thinks he has proved that these ambiguous beings are positively groups of animals, capable of contraction and extension. If a piece be detached from a living sponge, and submitted to a microscope, it will be seen to group itself into irregularly-rounded masses, and change the form of its edges incessantly: isolated portions, detached from the general mass, move slowly in the liquid, and creep along by means of their alternate contraction and expansion.”

The description given of sponges by Dr. Johnston is, that they are “organised bodies growing in a variety of forms, permanently rooted, unmoving and irritable, fleshy, fibro-reticular, or irregularly cellular; elastic and bibulous, composed of a fibro-corneous axis or skeleton, often interwoven with siliceous or calcareous spicula, and containing an organic gelatine in the interstices and interior canals; they are reproduced by gelatinous granules called *gemmules*, which are generated in the interior, but in no special organ. All are aquatic, and with few exceptions marine.” The same author says: “Mr. J. Hogg, in a letter dated June 25, states that the green colour of the fresh-water sponge (*Spongilla fluviatilis*) depends upon the action of light, as he has proved by experiments which showed that *pale*-coloured specimens became green when they were exposed for a few days to the light and full rays of the sun; while, on the contrary, *green* specimens were blanched by being made to grow in darkness or shade. He therefore infers the vegetable nature of this sponge; but leans to the opinion that the sea sponges are animals.”

Dr. Lankester has given a somewhat better definition for the determination of animal and vegetable life than other investigators. He proposes that the general fact of vegetables giving off oxygen gas and absorbing carbonic acid, whilst animals absorb oxygen and give off

carbonic-acid gas, should be generally admitted to constitute the true line of demarcation between the two, and would thus remove the objections raised by those who will not admit the presence of starch as sufficient to determine the point. Professor Grant has more recently examined the sponges; and from his patient and careful observations of them, they have been finally classed amongst the animal creation. He ascertained that the water was perpetually sucked into the substance of the sponge through the minute pores that cover its surface, and again expelled through the larger orifices. His own account is so very interesting, that we cannot resist giving, in his own words, the results arrived at in these investigations: "Having placed a portion of live sponge (*Spongia coalita*, fig. 102, No. 1) in a watch-glass with some sea-water, I beheld for the first time the splendid spectacle of this living

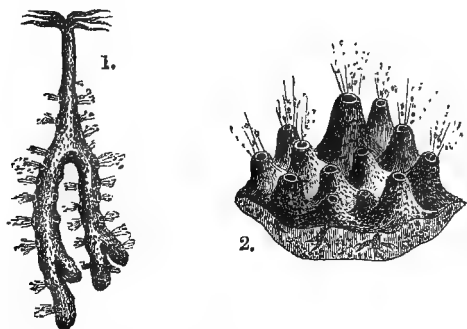

fig. 102. 1. *Spongia coalita*. 2. A piece of *Spongia panicea* highly magnified.

fountain, represented in fig. 102, No. 2, vomiting forth from a circular cavity an impetuous torrent of liquid matter, and hurling along in rapid succession opaque masses, which it strewed every where around. The beauty and novelty of such a scene in the animal kingdom long arrested my attention; but after twenty-five minutes of constant observation, I was obliged to withdraw my eye from fatigue, without having seen the torrent for one instant change its direction, or diminish the rapidity of its course. In observing another species (*Spongia panicea*), I placed two entire portions of this together in a glass of sea-water, with their orifices opposite to each other at the distance of two inches; they appeared to the naked eye like two living batteries, and soon covered each other with the materials they ejected. I placed one of them in a shallow vessel, and just covered its surface and highest orifice with

water. On strewing some powdered chalk on the surface of the water, the currents were visible to a great distance; and on placing some pieces of cork or of dry paper over the apertures, I could perceive them moving, by the force of the currents, at the distance of ten feet from the table on which the specimen rested."

Sponges grow attached to almost every thing which may serve them as a point of support, whether fixed or floating; some cover rocks, shells, and other submarine objects, with a close spongy incrustation; whilst others shoot up a branched stem into the water; and others again hang freely from the seaweeds floating in the ocean. Sometimes they select very unexpected objects on which to take up their abode. Thus, in one case recorded by Dr. Johnston in his *Natural History of British Sponges*, a specimen of the *Halichondria oculata*, a sponge not uncommon on some parts of the British coasts, was found growing from the back of a small live crab,—“a burden,” says the learned Doctor, “apparently as disproportionate as was that of Atlas,—and yet the creature has been seemingly little inconvenienced with its arboreous excrescence.”

In the second order, the *Hypocrepiæ*, all the members are inhabitants of fresh water; one of the most common species, and that which attracted the attention of Trembley as long ago as 1741, is the *Alcyonella stagnorum*. It occurs in great abundance, attached to the leaves of aquatic plants, on floating logs of timber, in the West India Docks. When first taken out of the water it is of a lobulated form and brown colour; the polypidom is soft and elastic, and feels very much like a sponge; but, as Mr. Teale observes, this polyp “is organically connected with the mass, the tube forming its tunic, from which the animated body issues by a process of evolution similar to that which develops the horn of a snail. When developed, the head projects a short way, and is crowned with a beautiful expansion of tentacula, about fifty in number, arranged in an unbroken circle, which is, however, depressed into a deep concavity on one of its sides, so as to produce the appearance of a double row of tentacula, in a horse-shoe form. About 1600 polyps are situated on a square inch of surface of the mass, consequently the number of polyps in one specimen, which weighed 17 ounces, and measured $14\frac{1}{2}$ inches in circumference, ‘may be computed at 106,000, and the tentacula at 5,320,000!’”

Trembley gave an excellent and interesting account of one of the family of *Alcyonella*, as far as the powers of the microscope at that time allowed. “This is one of the many kinds of water animals which live as it were in societies; of which some sorts hang together in clusters,

but can detach themselves at pleasure; whilst others are so intimately joined and connected together, that no one seems capable of moving or changing place without affecting the quiet and situation of all the rest. But this creature forms as it were an intermediate gradation between the other two, dwelling in the same general habitation with others of its own species, from whence it cannot entirely separate itself; and yet therein it appears perfectly at liberty to exert its own voluntary motions; and can either retire into the common receptacle, or push itself out from thence, and expand its curious members, without interfering with or disturbing its companions.

“They dwell together from the numbers of ten to fifteen (seldom exceeding the latter or falling short of the former number), in a filmy kind of mucilaginous or gelatinous case, which out of the water has no determined form, appearing like a lump of slime; but when expanded therein, resembles nearly the figure of a bell with the mouth upwards, and is usually about the length of half an inch, and one quarter of an inch in breadth or diameter. This case being very transparent, all the motions of its inhabitants may be discerned through it distinctly. It seems divided internally into several apartments, or rather, to contain several smaller *sacculi*, each of which encloses one of these animals. The openings at the tops of these *sacculi* are but just sufficient to admit the creature's head, and a very small part of its body, to be thrust beyond them, the rest remaining always in the case. The animal can, however, when it pleases, draw itself down entirely within the case, which is an asylum to secure it from its enemies (for it is not unlikely many of the larger aquatic insects prey upon it).

“The arms are set round the head to the number of forty, having each the figure of a long *f*, one of whose hooked ends is fastened to its head; and altogether, when expanded, compose a figure somewhat of a horse-shoe shape, convex on the side next the body, but gradually opening and turning outwards, so as to leave a considerable area within the outer extremities of the arms. And when thus extended, by giving them a vibrating motion, the creature can produce a current in the water, which brings the animalcules, or whatever other minute bodies are not beyond the sphere of its action, with great velocity to its mouth, whose situation is between the arms; where they are taken in if liked, or else, by a contrary current, which the creature can excite, they are carried away again; whilst at the same time other minute animalcules or substances that, by lying outside the enclosure made by the arms, are less subject to the force of the stream, are seized by them; for their sense of feeling is so exquisite, that on being touched

ever so slightly by any such little body, it is caught immediately and conveyed to the mouth. One may observe the creature, when disappointed of its prey, slowly extending itself again without retiring into its case.

“The bells or colonies of these animals are to be found adhering to the large leaves of duckweed and other aquatic plants; and may easiest be discovered by letting a quantity of water, with duckweed in it, stand quietly for three or four hours in glass vessels, in some window or other place where a strong light comes; for then, if any are about the duckweed, they will be found, on careful inspection, extending themselves out of their cases, spreading their plumes, and making an elegant appearance.

“They are extremely tender, and require no little care to preserve them; their most general disorder is a kind of slime or mouldiness, which will sometimes envelope them in such a manner as to prove mortal. The best way of curing this is by gently pouring a large quantity of water (perhaps two or three quarts) into the vessel where they are kept, and letting it run off slowly; by which means the sliminess will gradually be loosened, and carried away with the water.

“As to food, if fresh water be given them daily, they will find sufficient for themselves; and it is dangerous to try any other way of feeding them; for the smallest worms, or other visible insects one can think of giving them, will tear their delicate frame in pieces.”

In the journal of the Bombay branch of the Royal Asiatic Society for 1849, Surgeon H. J. Carter gives a minute and able account of the fresh-water sponges in the water-tanks of Bombay. Of five species that he discovered, one was the *Spongilla friabilis*, the others he named *Sp. cinerea*, *Sp. alba*, *Sp. meyeri*, *Sp. plumosa*.

Spongilla cinerea is stated to present on its surface a dark, rusty, copper colour, lighter towards the interior, and purplish under water. It throws up no processes, but extends horizontally in circular patches, over surfaces two or three feet in circumference, or accumulates on small objects; and is seldom more than half an inch in thickness. It is found on the sides of fresh-water tanks, on rocks, stones, or gravel. Seed-like bodies spheroidal, about 1-63d of an inch in diameter, presenting rough points externally. Spicula of two kinds, large and small; large spicula, slightly curved, smooth, pointed at both ends, about 1-67th of an inch in length; small spicula, slightly curved, thickly spiniferous, about 1-380th of an inch in length.

Spongilla friabilis.—Growing in circumscribed masses, on fixed bodies, or enveloping floating objects; seldom attaining more than

two inches in thickness. From the other sponges it is distinguished by the *smooth* spicula which surround its seed-like bodies, and the matted structure.

Spongilla alba.—Its texture is coarse and open; structure reticulated. The investing membrane abounds in minute spicula; has seed-like spheroidal bodies about 1-30th of an inch in diameter, with rough points externally. The large spicula are slightly curved, smooth pointed at each end, about 1-54th of an inch in length; the small spicula are slightly curved, thickly spiniferous, or pointed at both ends; the former, pertaining to the seed-like bodies, are about 1-200th of an inch in length; the latter, pertaining to the investing membrane, are more slender, and a little less in length; these last numerous small spiniferous spicula when dry present a white lacey appearance, from which Mr. Carter gives them the name of *alba*.

Spongilla meyeri is massive, having large lobes, mammillary eminences, or pyramidal, compressed, obtuse or sharp-pointed projections, of an inch or more in height; also low wavy ridges. Its seed-like bodies are spheroidal, about 1-47th of an inch in diameter, studded with little toothed disks.

Spongilla plumosa.—This is much the same in appearance and colour as the last, but looser and coarser in its texture and structure.

Mr. Carter states: "That fresh-water sponge is composed of a fleshy mass, supported on a fibrous, reticulated, horny skeleton. The fleshy mass contains a great number of seed-like bodies in all stages of development, and the horny skeleton is permeated throughout with siliceous spicula. When the fleshy mass is examined by the aid of a microscope, it is found to be composed of a number of cells, imbedded in and held together by an intercellular substance.

The granules are round or oval; translucent, and of an emerald or yellowish-green colour, varying in diameter below the 12,000th part of an inch, which is the average linear measurement of the largest. In some cells they are so minute and colourless as to appear only under the form of a nebular mass; while in others they are of the largest kind, and few in number.

The hyaline vesicles, on the other hand, are transparent, colourless, and globular; and although variable in point of size, like the green granules, are seldom recognised before they much exceed the latter in diameter. They generally possess the remarkable property of slowly dilating and contracting themselves, and present in their interior molecules of extreme minuteness in rapid commotion.

The intercellular substance, which forms the bond of union between

the cells, is mucilaginous. When observed in the delicate pellicle, which, with its embedded cells and granules, it forms over the surface, and throughout the canals of the sponge, it is transparent; but when a portion of this pellicle is cut from its attachments, it collapses, and becomes semi-opaque. In this state, the detached portion immediately evinces a tendency to assume a spheroidal form; but whether the intercellular substance participates in this act, or remains passive while it is wholly performed by the habit of the cells which are imbedded in it to approximate themselves, Mr. Carter has not been able to determine.

The *seed-like* bodies occupy the oldest or first-formed portions of the sponge, near its periphery. They are round or ovoid, according to the species, and each presents a single infundibular depression on its surface, which communicates with the interior. At the earliest period of development in which Mr. Carter recognised the seed-like body, it has been composed of a number of cells, united together in a globular or ovoid mass, according to the species, by an intercellular substance similar to that just described. The seed-like body passes from the state just mentioned into a more circumscribed form; then becomes surrounded by a soft, white, compressible capsule; and finally thickens, turns yellow, and develops upon its exterior a firm crust of siliceous spicula.

Thus matured, its cells, which were originally unequal in size, now become nearly all equal, almost motionless, and a little exceed the average diameter of the largest sponge-cells; while their germs, which in the first instance so nearly resembled the gemmules of the sponge-cells, are now four or five times larger; and vary in diameter below the 3000th part of an inch, which is the average linear measurement of the largest of their kind.

The capsule passes from a soft, white state, into a tough, yellow, coriaceous membrane, presenting in *meyeni* and *plumosa* a hexagonally-tessellated appearance, on the divisions of which rest asteroid disks of the vertically-placed spicula which surround it.

On the development of *Spongilla* Mr. Carter remarks: "When the cells of the seed-like body are forcibly expelled from their natural cavity under water, they are irregular in form and motionless, but soon swell out (by endosmose?), become globular, and after a few hours burst. At the time of bursting, their visible contents, which consist of a mass of germs, occupying about two-thirds of the cavity of the cell, subside, and afterwards gradually become spread over the bottom of the vessel in which they are contained. They are of various diameters below the 3000th part of an inch, which is the average linear measure-

ment of the largest, and they appear to be endowed with the power of locomotion in proportion to their size."

CLIONÆ.

Not the least wonderful circumstance connected with the history of the sponges is the power possessed by certain species of boring into substances, the hardness of which might be considered as a sufficient protection against such apparently contemptible foes. Shells, both living and dead, coral, and even solid rocks, are attacked by these humble destroyers, gradually broken up, and, no doubt, finally reduced to such a state as to render substances which would otherwise remain dead and useless in the economy of nature available for the supply of the necessities of other living creatures.

These boring sponges constitute the genus *Cliona*, and some allied genera. They are branched in their form, or consist of lobes united by delicate stems; they all bury themselves in shells or other calcareous objects, preserving their communication with the water by means of perforations in the outer wall of the shell. The mechanism by which a creature of so low a type of organisation contrives to produce such remarkable effects is still doubtful, from the great difficulties which lie in the way of coming to any satisfactory conclusions upon the habits of an animal that works so completely in the dark as the *Cliona*—it will probably long remain so. Mr. Hancock, to whom we are indebted for a valuable memoir upon the boring sponges, published in the *Annals and Magazine of Natural History*, attributes their excavating power to the presence of a multitude of minute siliceous crystalline particles adhering to the surface of the sponge; these he supposes to be set in motion by some means analogous to ciliary action. In whatever way this action may be produced, however, there can be no doubt that these sponges are constantly and silently effecting the disintegration of submarine calcareous bodies—the shelly coverings, it may be, of animals far higher in organisation than they; nay, in many instances they prove themselves formidable enemies even to living mollusca, by boring completely through the shell. In this case the animal whose domicile is so unceremoniously invaded, has no alternative but to raise a wall of new shelly matter between himself and his unwelcome guest; and in this manner generally succeeds at last in barring him out.

SKELETONS OF SPONGES.

The skeletons of Sponges, as well as those of Zoophytes, possess no blood-vessels; they are secreted by the fleshy mass of the animal, and

some of them are partially formed before the birth of the polyps which have to become their inhabitants.

The skeletons of some of the *Campanularia* consist of tubular granular matter, encased in a horny translucent substance, which is enlarged at the end of each branch into cells for the domiciliation of the polyps. The outline is waved from the cells with a jointed appearance, which allows of a certain elasticity to the cells.

Alcyonium digitatum are branched, and have tubes; some are curved, others straight, and many take the form of a cross. The dark-red margin of *Gorgonia petechialis* is a mass of large, red, flattened, angular spicula; while inside they are small and in bundles, forming a network around the pores or canals, thin and slightly-curved, with a small swelling in the centre.

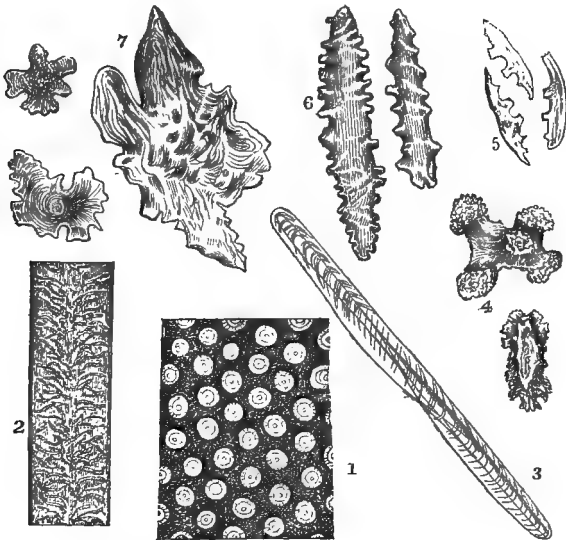

fig. 103.

1. Transverse section of a branch of *Myriapore*. 2. A section of the stem of *Virgularia mirabilis*. 3. A spiculum from the outer surface of a Sea-pen. 4. Spicula from crust of *Isis hippuris*. 5. Spicula from *Gorgonia elongata*. 6. Spicula from *Alcyonium*. 7. Spicula from *Gorgonia umbraculum*.

In a New Zealand specimen of *Alcyonium* the spicula are calcareous, of a brown colour, shaped like a cucumber, having all parts of their outer surface studded with conical tubercles; some of them exceed the

1-8th of an inch in length, others are as small as the 1-200th of an inch. (Fig. 103, No. 6.)

The purple-coloured spicula of the outer surface of the Sea-pen (*Renilla Americana*) are cylindrical, a little twisted, and seem to have a central canal; they are the 1-70th of an inch long, by the 800th in the short diameter. (Fig. 103, No. 3.)

The dull lake or dirty-white spicula of the crust of *Gorgonia elongata* are bowed with projectings from one side (fig. 103, No. 5); but they are commonly elongated, covered with tubercles arranged in rings.

Muricca elongata are yellowish-brown, of a pine-apple shape; one extremity covered with short sharp-pointed tubercles, the other expanded with spines; the free extremities of which all point in one direction.

Spicula from the fleshy crust of *Isis hippuris*, mostly of a quadrate or clavate figure, covered with large modulated tubercles, are represented in fig. 103, No. 4.

The *Gorgonia umbraculum* present two kinds, one found in the crust, of large stellate angular figure and rich brown colour; the other much smaller, and covered with modulated tubercles. (Fig. 103, No. 7.)

When a section is made of the Myriapora, *Nullepora alciformis*, it is seen, as in fig. 103, No. 1, to be of a reticulated structure, the diameter of each cell of which is about the 1-300th of an inch.

Professor Quekett states that the skeletons of sponges are composed principally of two materials, the one animal, the other mineral; the first of a fibrous horny nature, the second either siliceous or calcareous. The fibrous portion consists of a network of smooth, and more or less cylindrical threads, of a light-yellow colour, and, with few exceptions, always solid; they frequently anastomose, and vary considerably in size; when developed to a great extent, needle-shaped siliceous bodies termed *spicula* (*little spines*) are formed in their interior; in a few cases only one of these spicula is met with, but most commonly they occur in bundles. In some sponges, as those belonging to the genus *Halichondria*, the same horny kind of material is present in greater or less abundance, but its fibrous structure has become obscure; the fibres, however, in these cases are represented by siliceous needle-shaped spicula, and the horny matter serves the important office of binding them firmly together, as shown in Plate IV. No. 1. There is, however, one remarkable exception to this rule, viz. *Dictyochalia pumiceus*, described by Mr. S. Stutchbury, in which the fibrous skeleton is composed of threads of silex quite as transparent as glass.

The mineral portion, as before stated, consists of spicula composed either of silica or carbonate of lime ; the first kind is the most common and likewise most variable in shape, and presents every gradation in form, from the acute or needle-shaped to that of a star. The calcareous spicula, on the contrary, are more simple in their form, being principally acicular, but not unfrequently branched or even tri or quadriradiate ; the two kinds, the siliceous and calcareous, according to Dr. Johnston, not having hitherto been detected co-existent in any native sponges.

The spicula exhibit a more or less distinct trace of a central cavity or canal, the extremities of which are closed, or hermetically sealed ; in their natural situation they are invested by an animal membrane, which is not confined to their external surface ; but in many of the large kinds, as pointed out by Mr. Bowerbank, its presence may be detected in their central cavity, by exposing them for a short time to a red heat ; when the animal matter will become carbonised, and appear as a black line in their interior.

Many authors have described the spicula as being crystalline, and of an angular figure, and have considered them analogous to the *raphides* in plants ; but it requires no great magnifying power to prove that they are always round, and, according to their size, are made up of one or more concentric layers, as shown in Plate IV. No. 3. The spicula occupy certain definite situations in sponges ; some are peculiar to the crust, others to the flesh, others to the margins of the large canals, others to the fibrous network of the skeleton, and others belong exclusively to the gemmules. Thus, for instance, in *Pachymatisma Johnstonia*, according to Mr. Bowerbank, the spicules of the crust are simple, minute, and fusiform, having their surfaces irregularly tuberculated, and their terminations very obtuse ; whilst those of the flesh are of a stellate form, the rays varying in number from three to ten or twelve.

Silica, however, may be found in one or more species of sponge of the genus *Dysidea*, not only in the form of spicula, but as grains of sand of irregular shape and size, evidently of extraneous origin, but so firmly surrounded by horny matter as to form, with a few short and slightly-curved spicula, the fibrous skeleton of the animal. In these sponges the spicula are of large size, and are disposed in lines parallel with the masses of sand.

Most of the sponges of the earlier geological periods had tubular fibres ; but in all existing species, with one or two exceptions, they are solid. These tubular fibres are very commonly filled with portions of iron, which accounts for the colour of many of the remains in flint.

The *Moss-agates*, found among the pebbles at Brighton and elsewhere, are flints containing the fossilised remains of sponges. The coloured fibres seen in the *Green-jaspers* of the east are of the same character. There is reason to believe that most flints were originally sponges; those from chalk even retain their original form. Recent sponges from the Sussex coast present forms precisely similar to some chalk flints, but it is from sections made sufficiently thin to be transparent, for examination under the microscope, that we learn their true nature and origin.

Every horny sponge, when living, was invested with a coating of jelly-like substance, which can only be preserved by placing the sponge in spirit and water immediately after its removal from its place of growth.

Spicula are not exclusively confined to the body of sponges, but occasionally form the skeleton of the gemmules, and may be situated either on the external or internal surface of these bodies. A good example of the former kind occurs in the common fresh-water sponge (*Spongilla fluviatilis*), represented in Plate IV. Nos. 9 and 13. The spicula are very minute in size, and are disposed in lines radiating from the centre to the circumference, the markings on the outer surface of the gemmules being the ends of spicula. In all the young gemmules the spicula project from the outer margin as so many spines; but in process of growth the spines become more and more blunt, until at last they appear as so many angular tubercles.

Turkey sponge, or *Spongia officinalis*, is brought from the Mediterranean, has a horny network skeleton rather fine in the fibres, solid, small in size, and light in colour (Plate IV. No. 1.) In some larger specimens there is a single large fibre, or a bundle of smaller ones.

In *Halichondria simulans* the skeleton is a framework of siliceous needle-shaped spicula, arranged in bundles kept together by a thick coat of horny matter.

Other species of *Halichondria* have siliceous spicula pointed at both extremities—acerate (Plate IV. No. 7); while the spicula of some are round at one end and pointed at the other—acuate (see No. 7); and also spicula round at one end, the former being dilated into a knob—spinulate; some have a spinous surface.

From the South Seas specimens are found having spicula with both ends rounded; cylindrical; some curved, others straight.

In an unclassified genus, the spicula are discovered rather cylindrical in form, pointed at both ends, having the surface covered with spines

placed in an annular form (Plate IV. No. 2), and another in which the spicula exhibit many curious forms; within the circle may be seen one spiculum of remarkable beauty, being of large size, rounded at both ends, and slightly bent; its outer surface is covered with rows of tubercles of circular figure, which project some little distance beyond the free margin.

In *Halichondria* from New Zealand there are found some with the spicula of the acute form covered with spines, blunt at one end and sharp at the other; the spines are small, without order in their situation, but greater in number at the middle.

In the genus *Pachymatisma* some spicula are sharp at one extremity and expand into two points at the other—expando-binate; they are large, and their purpose is that of connecting the crust and the fleshy matter compactly together. The *P. Johnstonia* spicula are sharp at one end and expand into three points at the other—expando-ternate; arranged at angles at 45° to the other part of the stem (Plate IV. No. 7); there is also in this kind a variety having spicula sharp at one end and expanding into three branches at the other, each of which again divides into two dichotomo-expando-ternate kinds.

In the genus *Tethea* there are spicula having hooks at both extremities—bi-recurvo-ternate: at one end they are not so large or so numerous as at the other; the stem is a little spinous.

In *Tethea Lyncurium* the ends of the branches of the spicula are recurved, forming two, three, or four hooks, which serve to anchor the crust to the soft central fleshy part; their term is recurvo-binate, ternate, &c. Of the recurvo-ternate we give a specimen from a species of *Pachymatisma*. (Plate IV. No. 6.)

Among the genus *Grantia*, *Geodia*, and Levant sponge, are found spicula of a large size, radiating in three directions—triradiate. In the Levant specimen, a central communicating cavity can be distinctly seen. Some Smyrna sponge, and a species of *Geodia*, have four rays—quadriradiate.

There are spicula in *P. Johnstonia* and *Geodia* that have as many as ten rays—multiradiati; they vary in number. (No. 12.)

In some species of *Tethea* the spicula consist of a central spherical body, from which short conical spines proceed—stellate spicula. (Plate IV. No. 4.) These are also found in some of the genus *Geodia*.

Branched spicula, some covered with spines, have been taken from sponge brought from Ceylon; and from sponge from the same place, spicula more or less curved—curvate.

Spicula having both extremities bent alike—bicurvate—have been obtained from Trieste sponge. (See Plate IV. No. 3.)

Some South Sea sponges have spicula twice bent, and have extremities like the flukes of an anchor—bicurvate-anchorate; sometimes the flukes have three pointed ends. (Plate IV. No. 6.)

The gemmules in fresh-water sponges are generally found in the oldest portions near the base, and each one is protected by a framework of bundles of acerate spicula of the flesh, as shown in Plate IV. No. 9; but in many marine species, *Geodia* and *Pachymatisma*, they are principally confined to the crust. In the fresh-water sponges, the amount of animal matter in the gemmules is considerable; but in *Pachymatisma*, *Geodia*, and many other marine species, a very small quantity only is ever to be found, the substance of each gemmule being almost entirely composed of minute siliceous spicula; and if they be viewed when taken fresh from the sponge, and after boiling in acid to remove the animal matter, a slight increase in transparency is the only perceptible difference of appearance in these two opposite conditions.

XANTHIDIA.

In conjunction with the skeletons of the former species, it will be as well to offer a few remarks upon animals long classed with Infusoria, and but rarely found except in the fossil state. There is every reason to believe that the Xanthidia or double-bar animalcules belong to the Desmidiaceæ. In proof of this it can be shown that their skeletons are composed of horn, and not of silica, as was once supposed.

The name *Xanthidia* is derived from a Greek word signifying *yellow*, that being their prevailing hue. They are found plenteously in a fossil state, imbedded in flint, as many as twenty being detected in a piece the twelfth of an inch in diameter; in fact, it is rare to find a gun-flint without them. When living they may be described as having a round transparent shell, from which proceed spikes varying in shape in different species. One kind was found by Dr. Bailey in the United States of an oval shape, the 288th of an inch in length; and another kind, round in form, by the late Dr. Mantell, at Clapham; both these kinds were of a beautiful green colour. Specimens of the *Branched Xanthidium*, found in flint by Dr. Mantell, were from the 300th to the 500th of an inch in diameter. (Plate III. No. 4.) Mr. Ralfs says: "That the orbicular spinous bodies so frequent in flint are fossil sporangia of Desmidiaceæ, cannot, I think, be doubtful, when they are compared with figures of recent ones. Indeed, the late Dr. G. Mantell, who, in

his *Medals of Creation*, without any misgiving, had adopted Ehrenberg's ideas concerning them, changed his opinion; and in his last work regards them as having been reproductive bodies, although he is still uncertain whether they are of vegetable origin."

Ehrenberg and his followers describe these bodies as fossil species of *Xanthidium*; but no doubt erroneously, since their structure is very different. For the true *Xanthidium* has a compressed, bipartite, and bivalved cell; whilst these fossils have a globose and entire one.

The fossil forms vary like recent *Sporangia*, in being smooth, bristly, or furnished with spines, which in some are simple, and in others branched at the extremity. Sometimes, too, a membrane may be traced, even more distinctly than in recent specimens, either covering the spines, or entangled with them. Some writers describe the fossil forms as having been siliceous in their living state; but Mr. Williamson informs us that he possesses specimens which exhibit bent spines and torn margins; and this wholly contradicts the idea that they were siliceous before they were imbedded in the flint. In the present state of our knowledge, it would be premature to attempt identifying the fossil with recent species; it is better, therefore, at least for the present, to retain the names bestowed on the former by those who have described them.

Near to Sydden Spout and the Round Down Cliff on the Dover beach, Mr. H. Deane cut out a piece of pyrites with the adherent chalk, which, on examination, "exposed to view bodies similar to, if not identical with, the *Xanthidia* in flints; and clearly recognised *X. spinosum*, *ramosum*, *tubiferum*, *simplex*, *tubiferum recurvum*, *malleoferum*, and *pyxidiculum*, together with casts of *Polythalamia*, and other bodies frequently found in flints. In shape they are somewhat flattened spheres, the greater part of them having a remarkable resemblance to some gemmules of sponge, and having a circular opening in the centre of one of the flattened sides. The arms or spines of all appear to be perfectly closed at the ends, even including those which have been considered in the flint specimens to be decidedly tubiferous; showing that if the arms are tubes, they could afford no egress to a ciliated apparatus similar to those existing among Zoophytes. On submitting them to pressure in water between two pieces of glass, they were torn asunder laterally, like a horny or tough cartilaginous substance; and the arms in immediate contact with the glass were bent. Some specimens, put up after several weeks' maceration in water, were so flaccid, that, as the water in which they were suspended evaporated away, the spines or arms fell inclined to the glass. These cir-

cumstances alone seem clearly to disprove the idea of their being purely siliceous. The casts of the *Polythalamia*, portions of minute crustaceans, &c. appeared also to be, like the *Xanthidia*, some modification of organic matter; and in the case of the *Polythalamia*, the bodies are so perfectly preserved, that in some the lining membranes of the shells are readily distinguishable.

These investigations corroborate Mr. Ralfs, and also show that the same fossil remains, so abundant in flint, are to be found in the beds of chalk by which it is surrounded.

Mr. Wilkinson, who examined some *Xanthidia* found in the Thames mud and slime on piles and stones at Greenhithe, gives it as his opinion that they are not siliceous, but of a horny nature, similar to the wiry sponges, which Mr. Bowerbank describes as being very difficult to destroy without the action of fire.

He also met with a peculiarity in a *X. spinosum*, which he had never seen in any other species; it was in a piece of a gun-flint. There appeared, as it were, a groove or division round the circumference, similar to that formed by two cups when placed on each other, so as to make their rims or upper edges meet. There also seemed to be a peculiarity in the arrangement of the tentacula: the tentacula of *Xanthidia* generally pass from the body in a direction perpendicular to its centre, without any apparent fixed arrangement of position; but in this instance, both in the upper and lower portions, there were two circlets of tentacula; one placed round each extremity, and another round that part where the specimen appeared to be separated. The size was the 325th part of an inch in diameter, and the number of tentacula about twenty-five.

The other fossil Infusoria, found most abundantly in the chalk and flint of England, are the *Rotalia* or *wheel-shaped*, and the *Textularia* or *woven-work* animalcules; the latter having the appearance of a cluster of eggs in a pyramidal form, the largest being at the base, and lessening towards the apex.

CHAPTER II.

POLYPIFERA.

ZOOPHYTES, OR POLYPS.



Y the term Zoophytes, taken in its strictly limited sense, is understood a class of creatures which, in their form, or most remarkable characters, recall the appearance of a vegetable, or its leading properties. The most obvious character common to this vast race of animals is, that their mouths are surrounded by radiating tentacula arranged somewhat like the ray of a flower; and hence the term Zoophyte. So plant-like, indeed, are their forms, that the ancients regarded them as vegetating stones, and invented many theories to explain their growth. They are usually divided into two classes, the *Anthozoa* and *Polyzoa*. The first of these is again subdivided into three orders, the *Hydroïda*, *Asteroida*, and *Helianthoida*; the second, or *Polyzoa*, into two orders, the *Infundibulata* and the *Hyppocecria*.

The mass of scattered information that the investigators of this branch of natural history had published, has been collected and arranged, with refreshing enthusiasm, by Dr. George Johnston, of Berwick-upon-Tweed, under the title of *A History of the British Zoophytes*; in which work the ardent naturalist has not only combined "the whole under a system more in harmony with the anatomy of the objects than has hitherto been done," but enriched it by many personal researches and observations on the species found in his own neighbourhood. Of Polyyps,* Dr. Johnston gives the following definition: "Animals avertebrate, inarticulate, soft, irritable, and contractile, without a vascular or separate respiratory or nervous system; mouth superior, central, circular, edentulous, surrounded by tubular, or more commonly by filiform

* πολυς, many, and πους, a foot.

tentacula ; alimentary canal variable ; where there is an intestine, the anus opens near the mouth ; asexual ; gemmiparous ; aquatic. The individuals (*Polyps*) of a few families are separate and perfect in themselves ; but the greater number of Zoophytes are compound beings, viz. each Zoophyte consists of an indefinite number of individuals or polyps organically connected, and placed in a calcareous, horny, or membranous case or cells, forming by their aggregation corals, or plant-like *Polypidoms* * * * which is the house or support of the polyps ; and which, though commonly present, is yet not necessary to the existence of a Zoophyte.”

Opposed to all our common ideas of animal life is this singular creation. If we cut a limb off a tree, or sever that of an animal, these parts will wither and decompose, by passing into other forms of matter. Cut a tree across its middle, and its natural symmetry is irreparably disfigured ; slit it down its centre, and it is destroyed : all animals so treated suffer instant death, with the sole exception of the polyp ; for it will put forth new limbs, form a new head or tail, and if slit, become two separate existences.

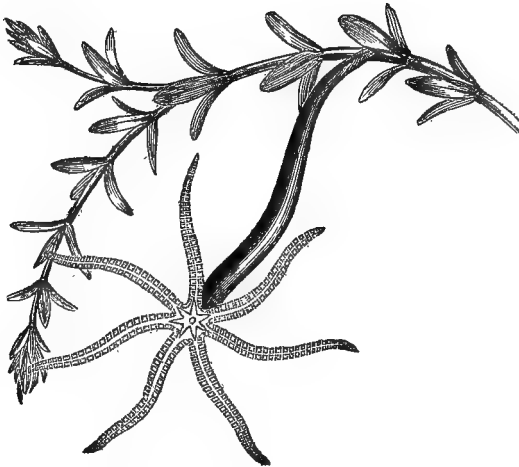

fig. 104.

Hydra, with its tentacles displayed and magnified, adhering to a stalk of the *Anacharis*.

The animals of the first order, the *Hydroïda*, are generally compound, and invested with a horny tubular polypidom ; the digestive

cavity is excavated in the substance of the body without any proper lining membrane, and the reproductive organs are always external. In the second order, the *Asteroida*, the polyps are always compound; the mouth is surrounded by eight tentacles; the digestive cavity is lined with a membrane, and the ovules are produced in the interior of the animal. The polyps in this order are imbedded in a more or less fleshy mass, which is generally supported on a horny or calcareous axis. The polyps of the third order, the *Helianthoida*, are single, and either possessed of a certain power of locomotion, or imbedded in a calcareous polypidom. The mouth is generally surrounded by a great number of tubular tentacles: the stomach is furnished with a distinct lining, and the ovaries are internal.

HYDROIDA—HYDRA, OR FRESH-WATER POLYPS.

It is in the polyps of this order that we find the nearest approach to the preceding division. The body in these generally consists of a homogeneous aggregation of visicular granules, held together by a sort of glairy intercellular substance, and capable of great extension and contraction; so that the creature can at pleasure assume a great variety of forms, extending its body and tentacles until the latter become so fine as to be almost invisible, and again retracting itself until it acquires the appearance of a small gelatinous mass. The tentacula which surround the anterior extremity are irregular in number; they are capable of extension to a very great length when seeking for prey; and on coming in contact with any object floating through the water, they immediately twine round it, and convey it to the mouth. In some genera the tentacles appear to be tubular, the internal cavity being continuous with that of the stomach. To assist in the capture of living prey, their surface is commonly roughened with a series of granules, which in some cases contain a curious poisonous or urticating apparatus. The mouth, which is situated in the centre of the circle of tentacles, leads directly into a simple digestive cavity, which is not lined with membrane.

In ponds and rivulets, adhering to the leaves of aquatic plants, or twigs and sticks that have fallen into the water, are found the *Hydræ*. When stretched out, they resemble pieces of hair, from a quarter to three quarters of an inch in length. Some are of a light-green colour, and others brown or yellow; that is, the five varieties found in England. It received its name from its several long arms being supposed to resemble the fifty-headed water-serpent called *Hydra*, and

destroyed by Hercules in the lake of Lerna, as we are informed in fabulous history.

Leeuwenhœck, in 1703, was the first to draw attention to the Hydra; and in 1739, M. Trembley, from the Hague, most accurately described the habits of the animal.

The extraordinary attenuation of the arms, until they can with difficulty be detected, renders it surprising that they possess strength sufficient to cope with the struggles of large worms and insects, round which the hydra wraps them; but, as the victim seems powerless when once in the fatal coil, it has been thought they possess some electric power similar to the eel and torpedo, that stun or destroy their prey by electrical force; and this belief is more especially entertained, as the little creature rests, like the above-named fish, before regaining power to resume its pursuit of prey.

Polyps are not vegetarians, and were fed by M. Trembley on minced fish, beef, mutton, and veal; they are voracious and active in seizing worms and larvæ much larger than themselves, which they devour with avidity. They carefully and adroitly bring their food towards their mouth; and when near, pounce upon it with eagerness. To make up for the want of teeth, the mouth enlarges to receive the food brought to it by the arms that have twined round the sacrifice. The red worm that tinges the mud of the Thames appears to be the dainty dish they like best to have set before them. Dr. Mantell saw the *lasso* of a polyp thrown over two worms at the same time; yet they could not escape, and lost all power of motion.

Dr. Johnston writes: "Sometimes it happens that two polyps will seize upon the same worm, when a struggle for the prey ensues, in which the strongest gains, of course, the victory; or each polyp begins quietly to swallow his portion, and continues to gulp down his half, until the mouths of the pair near, and come at length into actual contact. The rest that now ensues, appears to prove that they are sensible of their untoward position, from which they are frequently liberated by the opportune break of the worm, when each obtains his share; but should the prey prove too tough, woe to the unready! the more resolute dilates the mouth to the requisite extent, and deliberately swallows his opponent; sometimes partially, so as, however, to compel the discharge of the bait; while at other times the entire polyp is engulfed! But a polyp is no fitting food for a polyp, and his capacity of endurance saves him from this living tomb; for, after a time, when the worm is sucked out of him, the sufferer is disgorged with no other loss than his dinner."

This fact is the more remarkable, when it is contrasted with the fate which awaits the worms on which they feed. No sooner are these laid hold upon than they evince every symptom of painful suffering; but their violent contortions are momentary, and a certain death suddenly follows their capture. How this effect is produced, is mere matter of conjecture. Worms, in ordinary circumstances, are most tenacious of life, even under severe wounds; and hence one is inclined to suppose that there must be something eminently poisonous in the Hydra's grasp; as it is impossible to believe, with Baker, that this soft toothless creature can bite and inject a venom into the wound it gives. "I have sometimes," says Baker, "forced a worm from a polyp the instant it has been bitten (at the expense of breaking off the polyp's arms), and have always observed it to die very soon afterwards, without one single instance of recovery." Trembley states as a fact, that fishes cannot be made to swallow hydræ, seeming to prove the presence of some irritating quality in the latter.

The body of the *Hydra viridis* is said by Ecker to be composed of a vital contractile substance, soft, granular, and elastic, which is reticulated with clear spaces, containing more or less clear fluid. This contractile substance, from its want of definite form, cannot, according to Ecker, be termed muscular. "It is distributed throughout the whole body, and not formed into filaments or fasciculi; nor any more is the sensitive substance yet collected into nerves, but must be assumed to be dispersed through the whole body. The one is always most intimately connected with the other, as the investigation of all the lower animal forms teaches us. It is not until nerves are developed, that even scattered muscles are assigned for any given purpose in the economy. Muscles are not possible without a connecting nervous system."

The tentacles, or feelers, are tubular, and filled with an albuminous fluid. They are furnished with a variable number of tubercles, arranged in a spiral manner on the surface. These tubercles are beset with a number of spinigerous vesicles, which serve as organs of touch, in the midst of which, at the apex of the tubercle, a very singular organ of prehension is situated. Each spinigerous vesicle consists of two sacs, placed one within the other, with a small cavity in the centre of the inner one. At the point of contact of the two sacs is placed a long ciliary hair, which projects from the surface of the tentacle. The organ of prehension, which is called the *hasta*, consists of a sac opening at the surface of the tentacle, within which, at the lower portion, is placed a saucer-shaped vesicle, supporting a minute ovate body, which again

bears a sharp calcareous piece called the *sagitta*, or arrow. This can be pushed out at the pleasure of the animal, serving to roughen the surface of the tentacle, and afford a much firmer hold of its living prey.

The polyp increases rapidly: a portion of the body swells, a young one puts forth its head from the part, its arms begin to grow, it then is industrious in catching food, its body communicating with that of its parent, and participating in the fears and actions of its progenitor; finally, it is cast off to wander the world of waters. Betimes, ere yet free from parental attachment, it has two generations on its own body. Four or five offspring are thus produced weekly. But the most extraordinary circumstance in respect to this creature is thus described by M. Trembley: "If one of them be cut in two, the fore part, which contains the head and mouth and arms, lengthens itself, creeps, and eats on the same day. The tail part forms a head and mouth at the wounded end, and shoots forth arms more or less speedily, as the heat is favourable. If the polyp be cut the long way through the head, stomach, and body, each part is half a pipe, with half a head, half a mouth, and some of the arms at one of its ends. The edges of these half pipes gradually round themselves and unite, beginning at the tail end; and the half mouth and half stomach of each becomes complete. A polyp has been cut lengthways at seven in the morning, and in eight hours afterwards each part has devoured a worm as long as itself."

Still equally wonderful is the fact, that if turned inside out, the parts at once accommodate themselves to their new condition, and carry on all their functions as before the accident. Indeed, this animal seems so peculiarly endowed with the germs of vitality in every part of its body, that it may be cut into ten pieces, and every one will become a new, perfect, living animal. This seems bordering on the vegetable kingdom, in which it is common to propagate by means of slips from the mature shrub.

The polyp affixes itself by its tail to various substances, and frequently is a parasite to other animals, which it annoys, while benefited itself by taking advantage of their locomotive powers: this is more especially the case with the water-snail, on the body of which may often be found the polyp.

Dr. Roget, in his *Bridgewater Treatise*, copying Trembley, says: "The position in which they appear to take most delight is that of remaining suspended from the surface of the water by means of the foot alone; and this they effect in the following manner: When the flat surface of the foot is exposed for a short time to the air, above the

surface of the water, it becomes dry, and in this state exerts a repulsive action on the liquid ; so that when dragged below the level of the surface, by the weight of the body, it still remains uncovered, and occupies the bottom of the cup-shaped hollow in the fluid, thereby receiving a degree of buoyancy sufficient to suspend it at the surface. The principle is the same as that by which a dry needle is supported on water, in the boat-like hollow which is formed by the cohesive force of the liquid, if care be taken to lay the needle down very gently on the surface. If, while the hydra is floating in this manner, suspended by the extremity of the foot, a drop of water be made to fall upon that part, so as to wet it, this hydrostatic power will be destroyed, and the animal will immediately sink to the bottom."

The Hydroida, with the exception of the genera *Hydra* and *Cordylophora*, are all marine ; and vary in height from a line to that of a foot or more. A few of them are naked ; but the remainder are invested with a transparent horny-sheath, or skeleton, termed the *Polypidom*, which is of a tubular form, investing the soft parts. In the families *Sertularia*, *Tubularia*, *Plumularia*, *Antennularia*, and *Campanularia*, their names serve to a certain extent to explain the shape of the polypidom. We proceed to notice briefly a few individuals of the species *Hydra*.

Hydra vulgaris, or *Common Polyp* (No. 3, fig. 100), is often found upon plants, branches of trees, pieces of wood, rotten leaves, stones, and other substances in the water. They are of an orange-brown or oil-green colour, and round in shape. The number of its arms, or, as they are technically called, tentacula, vary, and are usually a little longer than the outstretched body of the animal itself. On moving from place to place, they dispose themselves in an arched position, grasping some object with their arms ; they then draw the tail towards the head, fix it, throw their head out again, and seizing some other substance, thus proceed onwards. A young one is seen sprouting from the body of this *Hydra*.

Hydra viridis, or *Green Polyp* (No. 2, fig. 100), differs little from the common polyp, except as regards its beautiful light-green colour, and its having shorter arms.

Hydra fusca, *Brown or Long-Armed Polyp*, is, like other polyps, composed of a jelly-like matter, formed into cells, which perform certain functions with a large mouth and a sucker at the opposite extremity ; the difference between it and the others named consists in the length of its arms, which will elongate several inches (see No. 1, fig. 100). In the extraordinary foresight of nature, it is provided that during the cold

weather the polyp shall continue its propagation not by budding, but by eggs; the latter being better calculated to protect the tender thread of life within against the destructive frosts of winter, than could possibly be resisted by the delicate construction of a new-born fragile creature thrust into its nipping influence.

There are other British kinds: the *Hydra verrucosa*, which is of a pale ashy colour, with six moderately long arms; and the *Hydra lutea*, a marine species, with a large head and ten very short arms.

Every reflecting person who reads even the slight sketch we have given of this polyp tribe must be struck with astonishment at a creature so primitive in structure, possessing the actions, sensations, and powers of higher organised beings. The stomach is but one simple structureless membrane, or cell, the external surface-cells condensed so as to form a kind of double skin; and the inside a mere wall of cells running crosswise, possessed of a velvet-like surface, the substance being red or brown grains held together by a sort of gluey substance.

This singular formation for the functions of animal life has led to many learned surmises and discussions tending to the most important results in the science of physiology.

SERTULARIDÆ.

The second family of polyps are the interesting and beautiful *Sertularidæ*; they are readily attainable on our own sea-shores. Linnæus made a large genus of them; but Lamarck considerably reduced his classification. The usual type presented is the beautiful *Sertularia pluma*, fig. 105, which Dr. Fleming proposes to divide into two groups, according as the stems are simple or compound.

The *Sertularia* have arms or feelers, which are abundantly supplied with cilia, with pitcher-shaped, dwarfish cells, arranged alternately, or in pairs obliquely, not exactly opposite, on the stem and branches of the polypidom, which is horny, fistulous generally, but attached in zigzag radiant fibres.

Within this family come the *Thoa*, of Lamouroux, of which there have been several kinds found in Great Britain. The name is supposed to be derived from

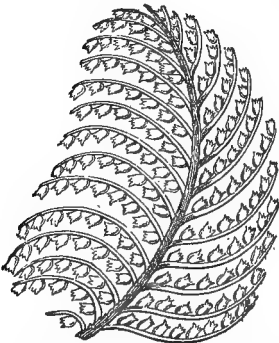

fig. 105. A single branch of *Sertularia*.

the Greek word for sharp; but we think with Dr. Johnston, that it more probably is a mis-spelling of Thoe, one of the Nereids, nymphs of the sea. They are generally of a brown and yellow colour, branched, and from an inch and a half to six inches in height.

Sertularia pumila.

—This is parasitic, and spreads its brown-coloured shoots over various fuci and sea-shells; but rarely attains more than half an inch in height. Stewart says, this species, and probably many others, in some particular states of the atmosphere, emits a phosphorescent light in the dark. If a leaf of the above fucus (*serratus*), with the *Sertularia* upon it, receives a smart stroke in the dark, the whole coralline is most beautifully illuminated, every denticle seeming to be on fire.

Sertularia Hibernica is thus named from being found near Donaghadee. Templeton says, "The branching of this



fig. 106. *Haliotis*, *Pollicipes*, *Chiton Marginatus*; Eggs of Cuttle-fish, or Sea-grapes; *Armeria maritima*, and other sea-side plants.

species is somewhat peculiar, each of the primary and secondary branches springing out at an angle of 40° or 50° . That part of the stem which bears the denticles is waved so as to bear each denticle on the projecting part; the denticles are elliptic, and the mouth of each apparently a little hollowed inwards, perhaps arising from the extremity being fractured; the vesicles are ovate, with four or five blunt teeth surrounding the mouth, and divided into six or eight portions by annulated undulating lines. It might be classed among the large and strong Sertularidæ, the principal shoot being of the thickness of a sparrow's quill at its base, and four inches or five inches long. The branches shoot forth from opposite sides; the whole coralline thus assuming a flat form, to the extent of four or five inches.

On the south-eastern coast of England the most common kind found is the *Sertularia setacea*, which, after rough weather, is cast on the shore attached to sea-weed. The stem and branches seem composed of separate pieces, fitting into each other as some foreign trees do, and terminate in a star-like head, from which radiate the feelers or arms. Dr. Mantell states he was present on one occasion when Mr. Lister was observing a living specimen: a little globular animalcule swam rapidly by one of the expanded polyps, the latter immediately contracted, seized the globule, and brought it to the mouth or central opening by its tentacula; these gradually opened again, with the exception of one, which remained folded, with its extremity on the animalcule. The mouth instantly seemed filled with cilia, which, closing over the prey, was carried slowly down its stomach; here it was imperfectly seen, and soon disappeared.

Appertaining to this family are the *Thuiarea*, so named from resembling a cedar-tree; but some kinds look more like a knobbed thornstick with a bottle-clearer at the top; others resemble a fir-tree. *Antennularia* are so called from resembling the lobster's antenna. They are found fixed to shells and rocks, are plentiful on the north-eastern coast of England and the coast of Ireland. They are of a brown colour, and covered with hair-like little branches; and as the hairy process is continued up its jointed stem, it is sometimes denominated *Sea-beard*.

The *Plumularia*, so named from the shoots and offsets being plumous, are an extensive and beautiful branch of this family. Professor Grant thus describes the *Plumularia falcata*: "This species is very common in the deeper parts of the Frith of Forth; its vesicles are very numerous, and its ova are in full maturity at the beginning of May. The ova are large, of a light-brown colour, semi-opaque, nearly

spherical, composed of minute transparent granules, ciliated on the surface, and distinctly irritable. There are only two ova in each vesicle; so that they do not require any external capsules, like those of the *Campanularia*, to allow them sufficient space to come to maturity. On placing an entire vesicle, with its two ova, under the microscope, we perceive through the transparent sides the cilia vibrating on the surface of the contained ova, and the currents produced in the fluid within by their motion. When we open the vesicles with two needles, in a drop of sea-water, the ova glide to and fro through the water, at first slowly, but afterwards more quickly, and their cilia propel them with the same part always forward. They are highly irritable, and frequently contract their bodies so as to exhibit those singular changes of form spoken off by Cavolini. These contractions are particularly observed when they come in contact with a hair, a filament of conferva, a grain of sand, or any minute object; and they are likewise frequent and remarkable at the time when the ovum is busied in attaching its body permanently to the surface of the glass. After they have fixed, they become flat and circular, and the more opaque parts of the ova assume a radiated appearance; so that they now appear, even to the naked eye, like so many minute grey-coloured stars, having the interstices between the rays filled with a colourless transparent matter, which seems to harden into horn. The grey matter swells in the centre, where the rays meet, and rises perpendicularly upwards surrounded by the transparent horny matter, so as to form the trunk of the future zoophyte. The rays first formed are obviously the fleshy central substance of the roots; and the portion of that substance which grows perpendicularly upwards, forms the fleshy central part of the stem. As early as I could observe the stem, it was open at the top; and when it bifurcated to form two branches, both were open at their extremities; but the fleshy central matter had nowhere developed itself as yet into the form of a polyp. Polyyps, therefore, are not the first formed of this zoophyte, but appear long after the formation of the root and stem, as the leaves and flowers of a plant."

Attached to fuci and sea-side shells in abundance on the southern coast of England, is found *Plumularia cristata*. It is affixed by a horny, branching, interlacing, tubular fibre to the object on which it grows. At different parts there are plumous shoots, usually about a little more than an inch in height. The cells are of a yellow colour, set in the stalk, of a bell-shape, and are compared to the flower of the lily of the valley; the rim is cut into eight equal teeth; the polyp minute, delicate; tentacles ten, annulated; mouth infundibuliform.

which after a time fall like blighted blossoms off a tree ; they do become ‘old in their youth,’ and, rendered hebetous and unfit for duty or ornament by age or accident, the common trunk throws them off, and supplies its wants by ever-young and vigorous growths. The phenomena are of those which justly challenge admiration, and excuse a sober scepticism, so alien are they to all we are accustomed to observe in more familiar organisms. Faithful observation renders the fact undeniable ; but besides that, a reflection on the history of the Hydra might almost have led us to anticipate such events in the life of these Zoophytes. ‘Verily, for mine own part, the more I look into Nature’s works, the sooner am I induced to believe of her even those things that seem incredible’”—*Baker*.

TUBULARIDÆ.

The third family are the Tubular or Vaginated Polyps : of an arborescent appearance, the animals live near the end of the branches, and are found attached to stones, sea-weeds, and shells. The *Tubularia indivisa*, or individed tubes, rise up like a tuft of herbage, of a horn colour, to the height of twelve inches. Ellis says, “they seem part of an oat-straw with the joints cut off.” At the summit protrudes the scarlet-coloured polyp, well furnished with tentacula, and connected with a pinkish fluid that fills the tubes. It was in this that Dr. Roget discovered the singular peculiarity of a circulation, similar to that in many plants, carried on without the mechanism necessary in higher organised animals : he says, “In a specimen of the *Tubularia indivisa*, when magnified one hundred times, a current of particles was seen within the tubular stem of the polyp, strikingly resembling, in the steadiness and continuity of its stream, the vegetable circulation in the chara. Its general course was parallel to the slightly spiral lines of irregular spots on the surface of the tube, ascending on the one side, and descending on the other ; each of the opposite currents occupying one-half of the circumference of the cylindric cavity. At the knots, or contracted parts of the tube, slight eddies were noticed in the currents ; and at each end of the tube the particles were seen to turn round, and pass over to the other side.

The particles carried by it present an analogy to those of the blood in the higher animals on one side, and of the sap of vegetables on the other. Some of them appear to be derived from the digested food, and others from the melting down of parts absorbed ; but it would be highly interesting to ascertain distinctly how they are produced, and what is the office they perform, as well as the true character of their

PLATE V.

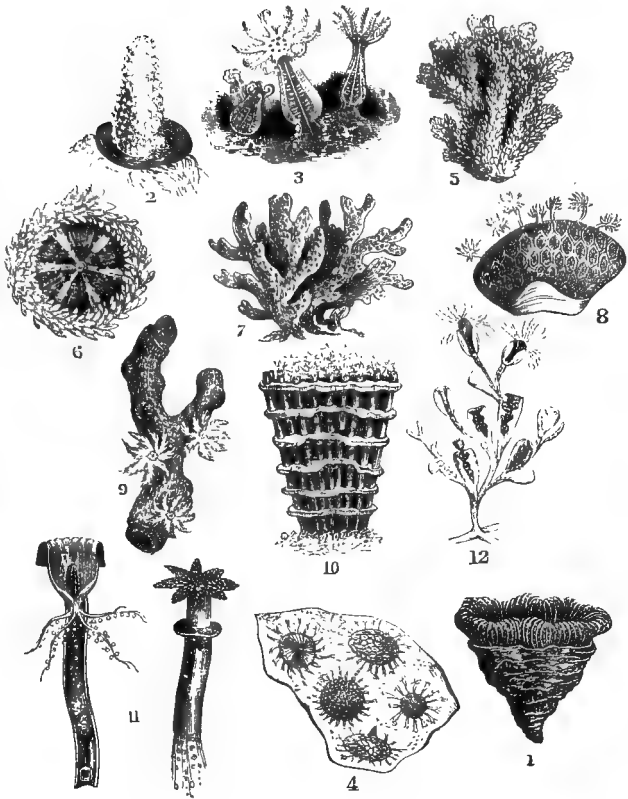

ZOOPHYTES, POLYPS, XANTHIDIA, ETC.

1. FUNGIA agariciformis.
2. ALCYONIUM, CYDONIUM MULLERI.
3. CYDONIUM, with polyps protruding and tentacles expanded, others closed.
4. XANTHIDIA in flint.
5. MADREPORE ABROTANOIDE.
6. MADREPORE cell magnified, showing its internal structure.
7. CORALLIDÆ: Copals.
8. CORAL, with polyps magnified and protruding from the cells.
9. GORGONIA nobilis, with polyps magnified and expanded.
10. TUBIPOERA MUSICA.
11. Tube of same, with polyp expanded, one being cut longitudinally to show its internal structure.
12. SERTULARIA, with polyps protruding; others being withdrawn into their cells.

remarkable activity and seemingly spontaneous motions; for the hypothesis of their individual vitality is too startling to be adopted without good evidence." Dr. Johnston cautions his readers against confounding this sort of circulation "with those aqueous currents which flow over the surfaces of the external organs of the ascidian polyps;" he adds, that innumerable cilia "clothe the surfaces of their tentacula, and by their rapid vibrations drive a constant equable stream of water along one side, which returns along the other in an opposite direction; and by this means the purposes of respiration are effected, and the nutrient fluid fitted for assimilation with the body."

Respecting the singular property of the head dropping off, Sir J. G. Dalyell says of the *Tubularia indivisa*, "the head is deciduous, falling in general soon after recovery from the sea. It is regenerated at intervals of from ten days to several weeks, but with the number of external organs successively diminishing, though the stem is always elongated. It seems to rise within this tubular stem from below, and to be dependent on the presence of the internal tenacious matter with which the tube is occupied. A head springs from the remaining stem, cut off very near the root; and a redundancy of heads may be obtained from artificial sections, apparently beyond the ordinary provisions of nature. Thus twenty-two heads were produced through the course of 150 days from three sections of a single stem."

One mode of propagation exhibited by these animals is that of the production of what have been called by Professor Van Beneden, "free or motive buds." They are produced in little clusters of bulbs, which grow from the bases of the tentacles at certain seasons, and for a certain period, after exclusion, possess a considerable power of locomotion. Sir J. G. Dalyell informs us, that on quitting the parent the bud of this species develops some little tubercles, the rudiments of the tentacles from its under-surface, and on these, as on so many feet, moves about the bottom of the water. After a time it appears to select a position in which to fix its permanent abode, when "it reverses itself to the natural position, with the tentacles upwards, and is then rooted permanently by a prominence, which is the incipient stalk, originating from the under part of the head. Gradual elongation of the stalk afterwards continues to raise the head, and the formation of the zoophyte is perfected." Other ovules undergo a certain degree of development whilst still enclosed in the ovisac, and are excluded from this shelter in a form somewhat resembling that of the common hydra. They then fix themselves, and become gradually developed into the form of the parent animal. Many polyps, apparently belonging to this family, give origin,

by a process of gemmation, to young Medusæ, which again produce ova, from which similar polyps are developed. The observation of this fact has given rise to the theory of what is called the "alternation of generations,"—a theory which has been applied by its originator, Steenstrup, to several other classes of animals.

Tubularia larynx is a most beautiful object; it is so named from its slender clustered tubes, which are of a horny texture, having the appearance of the windpipe of a bird. They are about three inches high, and the polyps have a delicate red colour, with white arms; one circle around the body, and the other round the oral opening.

In this family are the *T. ramous*, *T. ramea*, perfect trees in miniature; and the *Hermia glandulosa* of Dr. Johnston, who says: "I found the name in Shakspeare:

'What wicked and dissembling glass of mine,
Made me compare with Hermia's sphery eyne?'"

The fancy that the glands which surround the heads were the guardians of the animal, its "sphery eyne," suggested the name here adopted. These polyps are adherent by a tubular fibre, which creeps along the surface of the object on which they grow, seldom an inch in height, irregularly branched; the stem filiform, tubular, horny, sub-pellucid, wrinkled, and sometimes ringed at intervals, especially at the origin of the branches; each of which is terminated with an oval or club-shaped head of a reddish colour, and armed with short scattered tentacula, tipped with a globular apex. The ends of the branches are not perforated, but completely covered with a continuation of the horny sheath of the stem. The animal can bend its armed hands at will, or give to any separate tentaculum a distinct motion and direction; but all its movements are very slow and leisured.

We likewise have the *Coryne squamata*, and the *Coryne stauridia*, or *Slender Coryne* (fig. 107, No. 4), a sea-water polyp, thus described by Mr. Gosse: "It was found by me adhering to the footstalk of a *Rhodymenia*, about which it creeps in the form of a white thread; by placing both beneath the microscope, this thread appeared cylindrical and tubular, perfectly transparent, without wrinkles, but permeated by a central core, apparently cellular in texture, and hollow; within which a rather slow circulation of globules, few in number, and remote, is perceived. It sends off numerous branches; the terminal head of which is oblong, cylindrical, rounded at the end. At the extreme point are fixed four tentacula of the usual form, long, slender, and furnished with globular heads; one of which is shown at No. 5, detached, and

more highly magnified. It is much infested with parasites; a vorticella grows on it, and a sort of vibrio; the latter in immense numbers, forming aggregated clusters here and there; the individuals adhering to each other, and projecting in bristling points in every direction. These animalcules vary in length; some being as long as $\frac{1}{80}$ inch, with a diameter of $\frac{1}{7000}$ inch. They are straight, equal in thickness throughout, and marked with distinct transverse lines; they bend themselves about with considerable activity, and frequently adhere to the polyp by one extremity, while the remainder projects freely."

Some of this family attain a considerable size; the *Corymorpha nutans*, one of the most beautiful of the group, attains a length of four inches and a half. Of the beauty of its appearance, Forbes, who discovered it in the British seas, speaks in the following terms: "When placed in a vessel of sea-water, it presented the appearance of a beautiful flower. Its head gracefully nodded (whence the appropriate specific appellation given it by Sars), bending the upper part of its stem. It waved its long tentacula to and fro at pleasure, but seemed to have no power of contracting them. It could not be regarded as by any means an apathetic animal, and its beauty excited the admiration of all who saw it." The general colour of the creature is a delicate pink, with longitudinal lines of brownish or red dots. The tentacles are very numerous and long, and of a white colour; and the ovaries, which are situated immediately above the circle of tentacles, are orange. Most of the *Tubularidæ* inhabit the sea; but one species, the *Cordylophora lacustris*, is found in the dock of the Grand Canal, Dublin, in water which is perfectly fresh.

ASTEROIDA.

The next, or second order of Zoophytes is named *Asteroida* from the polyps presenting the form of a star on the surface of the fleshy mass in which they reside. (In title-page various species are distributed over the rock-work at the base.) Their organisation is superior to those previously described; and there exists this difference, that instead of the animals domiciling in a hard cell, they exist in a fleshy tough crust, which is supported by hard calcareous spicula, and others with thick branching processes, performing the part of the skeleton in the human frame. This central internal support is usually denominated the axis. The fleshy mass or covering is possessed of sensation, and ramified by various tubes and canals for the sustenance and other functions of life of the polyp. This order contains three families, the *Gorgoniadæ*, *Pennatulidæ*, and the *Alcyonidæ*:

The family *Gorgoniadæ* are named after the three celebrated sisters, daughters of Phorcus and Ceto, who turned to stone all on whom they fixed their eyes, and one of whom had her hair turned into serpents. They are of a large size, rising to a foot or more in height, and being from fifteen to sixteen inches in width (see Plate V. No. 9, and branches surrounding the title-page).

A widely-diffused class are the *Gorgoniadæ* in every sea; and though they naturally seem to dwell in deep water, yet when found in that more shallow, their colours are richer, deeper, and brighter. They are flexible, and seem like plants growing to the rocks to which they are fixed. Some are branching, covered with lace-like work; others like a feather or fan; while some, again, are straight, and others of a drooping form. The stems flat, angular, or round, of a dark colour, with an outer crust of a soft substance full of pores, out of which the polyps thrust themselves. The flesh when dry is earthy and friable, a considerable proportion of carbonate of lime entering into its composition; but in a recent state it is soft and fleshy, and excavated with numerous cells for the lodgment of the polyps. When a portion of a branch is macerated in a weak acid, the lime is entirely removed; but the branch retains its original size and figure, and shows the frame-work to be an irregular close texture of corneous fibres, the interstices of which had been, probably, filled with a gelatinous fluid.

The *Gorgonia patula* of Ellis and Solander is beautiful from its bright red colour; on its opposite sides it has holes projecting forwards, through which the polyps protrude in search of food.

Gorgonia flabellum, sometimes called the *Sea-fan*, *Flabellum Veneris*, or *Venus's Fan*, may often be seen of the height of five feet. It grows in the form of a net, with its branches compressed inwardly; the flesh is yellow, sometimes purple, with small mouths placed irregularly, having polyps with eight tentacles; the bone is black, horny, and slightly striated on the large branches. When alive, the colour is most beautiful, generally yellow with red spots, and is of a tough nature; but it varies much both in shape and colour, presenting some of the most delicate and graceful forms that can be conceived. Its elegant skeleton is generally seen decorating the houses of seafaring persons. Ray, referring to the fan-shape of some marine objects, says, "That the motion of the water descends to a good depth, I prove from those plants that grow deepest in the sea, because they all generally grow flat, in the manner of a fan, and not with branches on all sides like trees; which is so contrived by the providence of nature, for that the edges of them do in

that posture with most ease cut the water flowing to and fro; and should the flat side be objected to the stream, it would soon be turned edgewise by the force of it, because in that site it doth least resist the motion of the water; whereas, did the branches of these plants grow round, they would be thrown backward and forward every tide. Nay, not only the herbaceous and woody submarine plants, but also the lithophyta themselves affect this manner of growing, as I have observed in various kinds of corals."

In the British family there are also *G. verucosa*, *G. placomus*, *G. anceps*, *G. lepadifera*, *G. umbraculum*, *G. nobilis*.

The *Isis*, sea-shrubs belong to this class; they are small, but numerous scattered in the soft fleshy integument. *Isis hippuris*, or *Horse-tails*, so called from its resemblance to the *Equisetæ*, is the type by which this family is illustrated; it has a jointed stony stem, which rises into many loose branches. The stem or support of the animal consists of white, cylindrical, stony channelled joints, connected together by black, contracted, horny intermediate ones. The flesh is whitish, plump, and full of minute vessels; the surface of it is full of the little mouths of the cells, which are disposed in a quincunx order, covering the polyps with eight claws.

PENNATULIDÆ.

This family derives its name from *penna*, a quill, which the animal much resembles; a spiculum from one is shown at No. 3, fig. 103. Naturalists call them *Sea-pens*; and had they generally applied such simple appropriate terms to the objects of nature, they would have removed a bar to the study of science, and overcome a repugnance commonly felt on entering the enchanting field of knowledge.

The polypiferous mass of the *Pennatula* is fleshy or jelly-like; and the polyps are always found on the margin of the appendages of the polypidom. The skin is tough and horny, and has numerous calcareous spicula in a parallel position to each other, which Dr. Coldstream is of opinion are solid; and when connected with the body of the animal, seem to be red; but a slight degree of heat is sufficient to bleach them: they consist of phosphate and carbonate of lime, making thus a near approach to the bone of vertebrate animals.

On many parts of the coast, when the fishermen haul in their lines, and more especially if baited with mussels, there are found attached to the bait a number of polyps, which the boatmen call *Cocks'-combs*, but naturalists, *Pennatula phosphorea*; they are from two to four inches

long, of a purplish-red colour, except at the base of the smooth stalk, which is a pale yellow, from, as the fishermen say, this part being imbedded in the mud at the bottom of the sea. They are built up in the same manner as the former. The papillæ on the back of the rachis, and between the pinnæ, are disposed in close rows, and do not differ from the polyp-cells except in size. The latter are placed along the upper margin of a flattened fin; they are tubular, and have the aperture armed with eight spinous points, which are movable, and contract and expand at the will of the animated inmates. These are fleshy, white, provided with eight rather long retractile tentacula, beautifully ciliated on the inner aspect with two series of short processes, and strengthened moreover with crystalline spicula, there being a row of these up the stalk, and a series of lesser ones to the latter cilia. The mouth, in the centre of the tentacula, is somewhat angular, bounded by a white ligament, a process from which encircles the base of each tentaculum, which thus seems to issue from an aperture. The ova lie between the membranes of the pinnæ; they are globular, of a yellowish colour, and by a little pressure can be made to pass through the mouth.

Dr. Grant writes: "A more singular and beautiful spectacle could scarcely be conceived than that of a deep purple *Pennatula phosphorea*, with all its delicate transparent polyps expanded and emitting their usual brilliant phosphorescent light, sailing through the still and dark abyss, by the regular and synchronous pulsations of the minute fringed arms of the polyps." The power of locomotion is doubted by other writers, and the pale blue light is said only to be emitted when under the influence of some painful irritation.

In some genera, *Virgularia mirabilis* and *pavonaria*, to which the name of *Sea-rushes* has been given, the central stem is from six to ten inches long (see fig. 103). Sowerby describes them as like a quill stripped of its feathers. The base has some resemblance to a pen, as in the other species, swelling a little from the end, and then tapering. The upper part is thicker, with alternate semicircular pectinated swellings, larger towards the middle, tapering upwards, and terminating in a thin bony substance, which passes through the whole. Professor Grant writes: "Their *axis* is calcareous, solid, white, brittle, flexible, cylindrical, of equal thickness throughout, and exhibits no mark of attachment at either end. When broken, it exhibits a radiated surface, like the broken spine of an echinus. The axis appears to have little connection with the fleshy part, and to consist of concentric layers deposited by the soft parts surrounding it. When a portion of the axis is broken

off from either extremity, the animal retracts at that part, so as continually to expose a fresh naked portion of the axis ; hence we can take out the axis entirely from its soft sheath, and we always find the lower pinnæ of the animal drawn up closely together, as if by the frequent breaking of the base. These very delicate and brittle animals seem to be confined to a small circumscribed part of the coast, which has a considerable depth and a muddy bottom ; and the fishermen accustomed to dredge at that place believe, from the clearness of the *Virgulariæ* when brought to the surface, that they stand erect at the bottom with one end fixed in the mud or clay. Müller's specimens were likewise found on a part of the Norwegian coast with a muddy bottom. The polyps much resembling those of the common *Lobularia digitata*, are long, cylindrical, transparent, marked with longitudinal white lines, and have eight tentacula, which present long slender transparent filaments or cilia on each of the lateral surfaces when fully expanded. The polyps are easily perceived extending through the lateral expansions or pinnæ, to near the solid axis, where we observe two transverse rows of small round white ova placed under each pinna, and contained within the fleshy substance. These ova appear to pass along the pinnæ, to be discharged through the polyps, as in the *Lobularia*, *Gorgonia*, *Caryophyllea*, *Alcyonia*, &c."

ALCYONIDÆ.

The family of the *Alcyonium* derives its name from *Alcyone* or *Halcione*, the daughter of Neptune and wife of Ceyx, who, hearing of her husband's death at sea, cast herself into it ; and was, with her husband, changed into birds of the same name, to keep the waters calm while they sit in their nests of sea-foam for the space of seven, eleven, or fourteen days. Thus *Alcyon* signifies kingfisher, or sea-foam. The term *Lobularia* is sometimes applied to this family, but generally rejected from its botanical appellation.

Alcyonium digitatum, Pl. V. No. 2. Its name is derived from its fingered appearance ; the French call it *Main de Mer*, or "sea-hand," the Germans *Diebshand*, or "thief's hand." Sometimes they are very small ; but when larger are named by the fishermen *Cow's-paps*, and others, differing a little in form, *Dead Men's Toes*, or *Dead Men's Hands*. Their spiculæ are calcareous or siliceous crystalline, in the form of a cross, toothed at the sides, and lie scattered through the jelly-like mass.

The cells occupied by the polyps are placed at the terminations of canals which run through the polypidom, and which, by their union

with each other, serve to maintain a communication between the individual polyps constituting the mass. The rest of the polypidom is made up of a transparent gelatinous substance, containing the calcareous spicula above mentioned, and pervaded by numerous small fibres, which form a sort of irregular network. Alcyonidæ are always attached to submarine bodies. The species already mentioned is exceedingly common round our coasts; so much so that, as Dr. Johnston says, "scarce a shell or stone can be dredged from the deep that does not serve as a support to one or more specimens."

"The ova," says Professor Grant, "when placed under the microscope, and viewed by transmitted light, appeared as opaque spheres surrounded with a thin transparent margin, which increased in thickness when the ova began to grow, and such of the ova as lay in contact united and grew as one ovum. A rapid current in the water immediately around each ovum, drawing along with each all the loose particles and floating animalcules, was distinctly seen moving with an equal velocity as in other ciliated ova; and a zone of very minute vibrating cilia was perceptible, surrounding the transparent margin of all the ova. The progressive motion of the ova, always in a direction contrary to that of the current created by their cilia, was very obvious, though less rapid than in any other zoophyte in which I have observed the same remarkable phenomenon. The specimen, suspended in a glass jar filled with pure sea-water, I now brought so close to the transparent side of the vessel, that I could examine through it, with the assistance of a powerful lens, and without disturbing the animal, the motions and progress of the groups of ova passing through the colourless bodies of the polyps. To the naked eye, at first sight, all appeared motionless. The deep vermilion hue of the small round ova, and the colourless transparency of the outer covering of the polyps, formed a beautiful contrast with the pure white colour of the delicate longitudinal folds, the central open canal, and the slender filaments which wind down from its sides towards the clusters of white ova at the base: but the living phenomena discovered within were even more admirable than the beautiful contrast of colours, the elegant forms, and the exquisite structure of all the parts; when observed with a lens, the ova were seen to be in constant motion, and quite free within the bodies of the polyps. They moved themselves backwards and forwards, and frequently contracted their sides, as if irritated or capable of feeling. I could observe none passing upwards between the stomach and the sides of the polyps. They never assumed the appearance of a string of beads enclosed in a narrow, short, curved tube, as represented by Spix, but

swam freely in the water which distended the polyp, as figured by Ellis. Their motions in the polyps, though circumscribed, were so incessant, that, by watching attentively, I could observe them with the naked eye; and they became more conspicuous as the ova advanced to the open base of the stomach. From their restlessness, as they approached the last passage which separates them from the sea, they seemed to feel the impulse of a new element, which they were impatient to enjoy; and by following the direction of that impulse, they appeared to find their way into the lower extremity of the stomach, without any organic arrangement to lead them into that narrow canal. In their passage through the stomach, which was effected very slowly, the spontaneous motions of the ova were arrested, unless some imperceptible action of their cilia, or some contraction of their surface, might tend to irritate the sides of that canal, and thus direct or hasten their escape."

Alcyonium gelatinosum.—Attached to old stones and shells is this jelly-like transparent spongy zoophyte, growing to a height of nearly a foot, and sometimes much longer. It is branched, and of a brown or yellow colour, dotted with polyps, which are attached to the cells. Through angular openings they protrude their arms or feelers. Dr. Farre states, "The tentacula are sixteen in number (occasionally fifteen), fully two-thirds the length of the body of the animal, and extremely slender and flexible. When expanded they are frequently seen to roll up closely upon themselves, even down to their base; the revolution taking place either inwardly or outwardly, and in one or more arms at the same time. Their full expansion affords a more perfect campanulate form than is usually met with in this class, each of the arms having a slight curve outwards towards its extremity, which gives to the whole a very elegant appearance. It is remarkable that in some specimens the arms are much shorter on one side of the body than on the other."

The last specimen we notice, belonging to this family, is the handsome *Tubipora musica*, or *Organ-pipe Coral*, fig. 10, Plate V. This coral is composed of parallel tubes, united by lateral plates, or transverse partitions, placed at regular distances; in this manner large masses, consisting of a congeries of pipes or tubes, are formed. When the animals are alive, each tube contains a polyp of a beautiful bright-green colour, and the upper part of the surface is covered with a gelatinous mass, formed by the confluence of the polyps. This species occurs in great abundance on the coasts of New South Wales, of the Red Sea, and of the Molucca Islands, varying in colour from a bright

red to a deep orange. It grows in large hemispherical masses, from one to two feet in circumference : these first appear as small specks adhering to a shell or rock ; as they increase, the tubes resemble a group of diverging rays, and at length the other tubes are produced on the transverse plates ; thus filling up the intervals, and constituting a uniform tubular mass ; the surface being covered with a green fleshy substance beset with stellular animalcules.

ACTINIÆ.

All persons accustomed to wander by the sea-shore must have admired the livid green, dark little jelly-masses adhering to the rocks,—called *Actinia*, from a Greek word signifying a ray,—and left in some little pool by the ebbing tide, living as they do principally within high and low-water mark, and expanding their broad surfaces and fringing feelers to the finger of inquisitive youth, so often thrust into the centre to feel the effect of the suction, as the poor animal draws itself up in the form of a little fleshy hillock. The *Actiniæ* have the power of secreting some adhesive substance at their base, by which they affix themselves to rocks and other objects ; but can release their bodies when necessary, and, either by creeping on their feelers, or filling their bodies with water, and gliding along, change their location. Much interest has been excited by the exhibition of many of this class in the tanks in the Zoological Gardens. These zoophytes are more familiarly known by the name of *Sea-Anemonies*, or *Animal Flowers* : they belong to the order *Helianthoida* ; the polyps are single, free, or permanently attached ; fleshy, naked, or encrusted with a calcareous polypidom, the upper surface of which is crossed by radiating lamellæ. Representations are given of them in the Frontispiece, Nos. 5, 6, and 7, and elsewhere.

In their appetites they are voracious, and seize the little shelled inhabitants of the sandy shores. Dr. Johnston says : “ I had once brought me a specimen of *Actinia gemmacea*, that might have been originally two inches in diameter, and that had somehow contrived to swallow a valve of *Pecten maximus*, of the size of an ordinary saucer. The shell, fixed within the stomach, was so placed as to divide it completely into two halves ; so that the body, stretched tensely over, had become thin, and flattened like a pancake. All communication between the inferior portion of the stomach and the mouth was of course prevented ; yet, instead of emaciating and dying of atrophy, the animal had availed itself of what had undoubtedly been a very untoward accident, to increase its enjoyments and its chances of double fare. A new mouth, furnished

with two rows of numerous tentacula, was opened up on what had been the base, and led to the under-stomach: the individual had, indeed, become a sort of Siamese twin, but with greater intimacy and extent in its unions." The following curious observations made by Dique-mare upon these rivals of the weather-wise leeches, may be useful to some residents at the sea-shore; "My very earliest observation showed that the sea-anemonies feel, and prognosticate within doors, the different changes of temperature in the atmosphere. I had not leisure at that time to form tables of their various indications; but I have since done it. This fact, if applied to practice, might be of use in the formation of a sea-barometer; an object of no small importance, which several ingenious men have hitherto endeavoured in vain to furnish us with. I should prefer the anemonies of the third species for this purpose, their sensation being very quick; they are also easily procured, and may be kept without nourishment. Five of them may be put in a glass vessel four inches wide and as many in depth, in which they will soon cleave to the angle formed by the sides and the bottom. The water must be renewed every day; and as they do not require a great quantity of it, as much may be fetched from the sea (if they be kept on land) as will supply them for several days; its settling some time will only improve it. If the anemonies be at any time shut or contracted, I have reason to apprehend an approaching storm; that is, high winds and an agitated sea. When they are all shut, but not remarkably contracted, they forbode a weather somewhat less boisterous, but still attended with gales and a rough sea. If they appear in the least open, or alternately and frequently opening and closing, they indicate a mean state both of winds and waves. When they are quite open, I expect tolerably fine weather and a smooth sea. And lastly, when their bodies are considerably extended, and their limbs divergent, they surely prognosticate fixed fair weather and a calm sea. There are times when some of the anemonies are open, and others shut; the number must then be consulted; the question is decided by the majority. The anemonies used as barometers should not be fed; for then the quantity of nourishment might influence their predictions. Anemonies of this, and of the first species, live and do well for several years without taking any other food but what they find disseminated in the sea-water; but should a respite of some days be granted them, they might then be fed with some pieces of muscles, or soft fish, and thus restored to their original vigour. Whenever the vessel is sullied by the sediments of salts, slime, the first shoots of sea-plants, &c. the animals may, on changing the water, be cleansed, by wiping them with

a soft hair pencil, or even with the finger, carefully avoiding to rub or press hard on the anemonies. Should any of them drop off during this operation, they may be left at liberty; for they will soon of their own accord fix themselves to some other place. Should any of them die, which will soon be discovered by the milky colour of the water, and an offensive smell on changing it, it must be taken out, and on the first opportunity another of the same species be put in its place; those of a moderate size are the most eligible."

Actinia bring forth their young alive; one or more appear first in the tentacles, from whence they can be withdrawn and transmitted to others by the parent, and are at last produced by the mouth. In the course of six years, one specimen was found to produce above 276 young.

Like the Hydræ, the Actiniæ may be cut and its members lopped off without injury, the parts becoming perfect animals, or the limbs rebudding; in fact, the tentacles will be reproduced as often as the sympathising experimenter may choose to perform amputation. If the animal be divided in two, separating the base from the head, the former will become a perfect animal, and the latter industriously swallow food; which passes freely through it, but in time is retained, and a finished stomach effects the necessary function of digestion. Upon trying this experiment, there have been instances of a new head coming at the part where the separation from the base was effected; thus at each end the active and powerful feelers captured prey and conveyed it to the stomach. Hot water may blister its skin, and a transparent palace of ice encase its body, or an air-pump deprive it of air, the animal will not die; but fresh-water is the swift and sure messenger of death.

The commonest kind of this family, *Actinia mesembryanthemum*, or *Smooth Anemone*, is of a dark-flesh or olive colour; some are streaked with white, blue, or green, or spotted. The feelers, when stretched out, are about the same length as the body; the animal generally measures about an inch and a half in diameter. Dr. Johnston says: "The tubercles within the margin of the oral disk are formed by papillary projections of the parenchyma—spongy or porous flesh—of the body, covered over on the top with a thick layer of dense blue matter; in it, as well as in the skin generally, minute fusiform calcareous spicula, some slenderer than others, may be detected in abundance with the microscope."

Actinia rubra and *Bellis* (Nos. 4, 5, 6, and 7, Plate I.) generally live together in groups of four or five. Goertner thus describes them: "From the small base arises a cylindric stalk, which supports the roundish body of the animal, and from whence afterwards the calyx, being a continued

membrane of the body, draws its origin. The stalk, or pedunculus of the polyp is quite smooth, and its colour inclines towards the carnation. The outside of the calyx, and the body of this animal, are marked with a number of small white protuberances resembling warts, to which fragments of shell, sand-grains, &c. adhere, and hide the beautiful colour of these parts, which, from that of carnation, are insensibly changed towards the border of the calyx, first into purple, then violet, and at last into a dark brown. The inside of the calyx is covered with the feelers that grow in several ranges upon it; they differ considerably in length, those that are near the edge of the calyx being but small papillæ, in proportion to those that surround the disk, or the central part of the body. They are almost transparent, and some of them of a pale ash colour, with brown spots; others, on the contrary, are of a chestnut colour, marked with white spots. The disk is formed like a star, which, according to the figure that is traced out by the innermost row of the feelers, consists of many angles. The colour of this part of the body is a beautiful mixture of brown, yellow-ash colour, and white, which together form variegated rays, that, from the centre or the mouth of the animal, are spread over the whole surface of the disk. The polyp, contracting itself, changes its body into an irregular hemisphere, which is so covered with the several extraneous bodies that stick to it, that it is extremely difficult to know the animal in this state, and to discern it from the rubbish that commonly surrounds it."

Actinia gemmacea is larger than those previously named; it has three or four rows of thick short feelers around the oral disk, which have suckers at the ends, by which they seize and hold their unfortunate victims. This is a large and varied species of different colours, the feelers being usually variegated with red and white rings. Its body is rough, with glandular warts; and being covered by the sand, shells, or gravel surrounding it, is hidden from objects that may prey upon it, or unobserved by those upon which it preys. So singular is Nature in adapting its productions to the circumstances by which they are surrounded, that when this species becomes an inhabitant of waters that do not leave it dry, the masquerading-dress is cast aside, the warts almost disappear, and it stands forth in all its beauty, proving the words of the poet, that "when unadorned, adorned the most."

What will man not venture to eat, in hope of tickling the appetite with some new excitement! Dicquemare says: "Of all the kinds of sea-anemonies, I would prefer this for the table; being boiled some time in sea-water, they acquire a firm and palatable consistence, and may then be eaten with any kind of sauce. They are of an inviting

appearance, of a light silvery texture, and of a soft white and pinkish hue. Their smell is not unlike that of a warm crab or lobster."

Actinia maculata.—This is a curious and interesting object, as it is found enveloping a snail-like or periwinkled shell, having the superior part of a species of small crab projecting from the inside of the shell. Its body is of a reddish colour, marked with beautiful purple spots, and in its thickest part is not more than three-tenths of an inch; it is about three inches in diameter, and furrowed longitudinally.

Among the largest of the British species of *Actinia* is one found on the north-east coast, which, when contracted, usually measures three inches in length. Dr. Johnston, as sponsor, gives it the name of *Actinia Truedia*, the ancient appellation of the maritime parts of Berwickshire, to indicate the place of its first discovery, where it is often dredged from deep water by the fishermen. It is of a uniform reddish or brownish-orange colour, and either smooth or contracted at pleasure into circular folds. The base is smooth and orange-coloured. The mouth is ever varying in size and form, and there are often protruded from it vesicular-like lobes of a reddish colour, scored with fainter lines.

Anthea, a flower, is a name applied by Dr. Johnston to a branch of the order Helianthoida. *Anthea cereus* is of a pretty light-brown colour, having a somewhat cylindrical furrowed body. About 200 feelers arise from the disk of the animal, which, when expanded, are longer than the body, and of a bright sea-green colour tipped with red. But in some kinds this colour varies. They are common on the Cornwall coast: Ellis observes, "Their tentacula being disposed in regular circles, and tinged with a variety of bright lively colours, very nearly represent the beautiful petals of some of our most elegantly fringed and radiated flowers, such as the carnation, marigold, and anemone."

LUCERNARIIDÆ.

These beautiful and singular animals may be seen swimming quickly through the waters, or more generally adhering to sea-weed, and spreading out and contracting their bodies as they seize their prey; for as soon as the suckers at the end of their feelers have got a little animal within its power, it is carried to the mouth, and the body contracts to enclose and consume it. They are of a jelly-like nature, with a smooth and thickish skin; their bodies are arborescent, with bell-shaped cells, having a small sucker at the bottom, and are divided into eight compartments, as are others of the *Actinia*.

Lucernaria campanulata. — This graceful animal is about an inch

in height, of a bell-shape, terminating in a sucker resembling the stand of a stalked drinking-glass. The upper part is indented by eight short processes or arms, stretching upward, and terminated by a delicate tuft of a blossom-like appearance; these, about sixty in number, are glands or suckers, by which prey is caught. Its colours are various and rich. The interior is hollow like a flower, in the centre of which a square mouth is seen; from this seems to spread four leaves, which add to the beauty of the appearance.

Dr. Johnston mentions in the British family of *Lucernaria*, *L. fascicularis* and *L. auricula*; they differ but little from *L. campanulata*. They propagate by ova, which are seen as two rows of spots in the arms that extend around the mouth.

Nearly allied to the family Actiniæ, are those laminated, circular-form corals, called *Fungia*, or *Sea-Mushrooms* (Plate V. No. 1). They are found in great variety; are white, of a flattened round shape, made up of thin plates or scales, around which is a translucent jelly-like substance, and amidst it a large polyp; for, unlike others, they exist as individuals: the lower part is of a stony nature, by which the animal is affixed to the rock whereon it lives.

In Ellis's *Zoophytes* is the following passage, quoted from Rumphius in regard to the *Fungia agariciformis*: "The more elevated folds or plaits have borders like the denticulated edge of needlework-lace. These are covered with innumerable oblong vesicles, formed of a gelatinous substance, which appear alive under water, and may be observed to move like an insect. I have observed these radiating folds of the animal, which secrete the lamellæ, and which shrink between them when the animal contracts itself on being disturbed. They are constantly moving in tremulous undulations; but the vesicles appeared to me to be air-vessels placed along the edges of the folds, and the vesicles disappeared when the animal was touched."

In the British Museum there is a splendid specimen of the *Brainstone Coral*, or *Meandrina cerebriformis*, so named by the appearance of its surface resembling the convolutions of the medullary substance of the human brain. In a living state the mass is invested with a fleshy substance, variously coloured, and having numerous short, conical polypiform, confluent cells, arranged in rows between the ridges. It attaches itself by a strong stony secretion to rocks; and as one generation passes away, on the shelly remains another arises; and thus the imperishable charnel-houses are built upon and increased in magnitude.

MADREPORIDÆ.

Madrepores, *Mother-pores*, or "tree corals," differ from other corals in not having a smooth skeleton, but one inducted by numbers of small cells for the residence of the living animal: these are very visible in the *Madrepore muricata*, when the polyp is dead and decomposed; but most distinct in the *Oculina ramea*, or *Abrotanoide*, as they are situated at the apparently broken stumps that branch from the trunk of the skeleton (Plate V. fig. 5). Every branch is seen to be covered with multitudes of small pits or dots, scarcely visible to unassisted vision; but when viewed under the microscope, will be found to be cells of the most beautiful construction, remarkable alike for their mathematical regularity and the exquisite fineness of the materials employed in their composition. A magnified drawing of one of the cells is given at No. 6. The living polyps are most beautiful in their native waters; their varying colours adding to the richness of the hues covering the plains of the ocean.

Caryophyllia, or *Nut-leaf*. The *Caryophyllia Smithii* is found tightly fixed to rocks; it is round, of a dirty white colour. Dr. Fleming says of the plates: "The lamellæ are disposed in fours, and may be distinguished into three different kinds. The first are the highest and the broadest at the margin; but as they descend into the disk, they become narrower before they join the central plate. The second kind are narrower than the preceding at the margin, but towards the middle they suddenly enlarge and join the middle plate. The third kind are the smallest, and terminate before reaching the middle plate. The space included between a pair of the first kind of plates contains one of the second kind in the middle, with one of the third kind in each of the lateral spaces. Those on the sides are rough, with small scattered tubercles, and their margins are curled. This last circumstance occasions the roughness externally, where the longitudinal striæ are the remains of the gills. The plate which occupies the bottom of the cavity is smooth, variously twisted, and connected with the base of the lateral plates."

Dr. Coldstream, writing to his friend Dr. Johnston, gives the following interesting account of the animal: "When the soft parts are fully expanded, the appearance of the whole animal resembles very closely that of an *Actinia*. When shrunk, they are almost entirely hid amongst the radiating plates. The specimens I have seen have varied in size from three-tenths to half an inch in height. They are found pendent from large boulders of sandstone, just at low-water mark;

sometimes they are dredged from the middle of the bay (Torquay). Their colour varies considerably; I have seen the soft parts white, yellowish, orange-brown, reddish, and of a fine apple-green. The tentacles are usually paler. During expansion, the soft parts rise above the level of the calcareous disk to about twice its height. The tentacles are pushed forth very slowly, but sometimes are as long as the whole height of the body. They are terminated by a rounded head. The mouth has the appearance of an elongated slit in the centre of the disk; it is prominent, and the lips are marked with transverse striæ of a white colour. When a solid body is brought into contact gently with the tentacles, they adhere pretty strongly to it, just as the *Actinia* do; but when they are rudely touched, they contract very quickly, and if the irritation be continued, the whole soft parts sink within the calcareous cup."

The species best known from its skeleton is *Corallium rubrum*, or *Red Coral*. It is the coral of commerce, and is an inhabitant of the Mediterranean and adjacent seas. In appearance it resembles a tree devoid of leaves and small branches. It requires about ten years to arrive at maturity, and is then about a foot in length. Its skeleton or axis is the polished brilliant red-stone used in ornamentations. It is solid, channelled, ramified, and fixed by a broad base, with a thin external, fleshy covering, of a pale blue colour, and studded over with star-like polyps, that extend their feelers to grasp at prey. When brought into the air, the pulpy body of the animal soon decays, when its remains are prepared for market, and the neck or arm of matchless beauty is endeavoured to be rendered more attractive by being adorned with the pretty skeleton forms of the dead animal.

CELLEPORIDÆ.

This family have calcareous polypidoms, cellular, irregularly-lobed, or branched, formed of pitcher-shaped cells, heaped together or arranged in quincunx, that is, resembling the five on playing-cards.

On the British shores are found *C. pumicosa*, *C. ramulosa*, *C. Skenei* (named after the talented Dr. David Skene), *C. cervicornis*, and *C. lævis*. This last, Dr. Fleming says, is "in height an inch and a quarter; diameter, one-tenth; the branches are smooth, with the orifices of the cells smooth and concave; towards the extremities the branches are rough with the forming cells, and the orifices are more declining, circumscribed, a little prominent, with a blunt process at the proximal margin."

Lepralia, Sea-scurf,—from the Greek for marine leprosy,—is the name given to this branch of the Celleporidæ by Dr. Johnston.

Lepralia nitida, found attached to shells, is thus described: “Crust spreading circularly, closely adherent, rather thin, greyish white, calcareous; cells contiguous, in radiating rows, large, subalternate, ovate, ventricose, silvery, the walls fissured with six or seven cross slits which are on the mesial line; aperture subquadrangular, depressed, terminal; anterior to it there is often found a globular, pearly, smooth, oviferous operculum, with a round even aperture. The remarkable structure of the cells renders this one of the most interesting species under the microscope. There is sometimes an appearance of a spine on each side of the lower angle of the mouth, which is merely the commencement of the walls of the next cell.”

L. coccinea, *L. variolosa*, *L. ciliata*, *L. trispinosa*, and *L. immersa*, are the other British species.

The family *Cellularia*, or little cells, have mostly that wonderful provision of nature for their protection, an operculum, a lid or cover over the apertures of their cells. *Cellularia ciliata* is parasitical, branching, calcareous, white and tufted; grows about half an inch in height, and the oblique aperture is armed on the outer edge with four or five long hollow spines. The operculum is pearly, and near the base there is that singular appendage, described as the *bird's-head* process. Its beauty and transparency render it a favourite object with microscopists.

Cellularia avicularia has been more accurately described by Mr. Gosse, from his own observations upon specimens secured on the Devonshire coast, during a residence there. He says: “Well does it deserve the name of *Bird's-head Coralline*, given to it by the illustrious Ellis; for it presents those curious appendages that resemble vultures' heads in great perfection. All my specimens were most thickly studded with them; not a cell without its bird's head, and all see-sawing, and snapping, and opening their jaws with the most amusing activity; and what was marvellous, equally so in one specimen from whose cells all the polyps had died away, as in those in which they were still protruding their lovely bells of tentacles. The stem ascends perpendicularly from a slender base, which is attached to the rock, or to the cells of a *Lepralia* growing from the rock. The central part of the spine is most expanded, the diminution above and below being pretty regular; during life, the usual colour is a pale buff, but the cells become nearly white in death. When examined microscopically, it is, however, that the curious organisation of this zoophyte is discovered, especially when in

full health and vigour, with all the beautiful polyps protruded and expanded to the utmost, on the watch for prey. It seems to me as poor a thing to strain one's eyes at a microscope over a dead and dry polypidom, as it does to examine a shrivelled and blackened flower out of a herbarium ; though I know well that both are often indispensable for the making out of technical characters. But if you want to get an insight into the structure and functions of these minute animals, or if you would be charmed with the perception of beauty, or delighted with new and singular adaptations of means to an end,—or if you desire to see vitality under its most unusual, and yet most interesting phases,—or if you would have emotions of adoring wonder excited, and the tribute of praise elicited to that mighty Creator who made all things for his own glory,—then take such a zoophyte as this, fresh from the clear tide-pool, take him without inflicting injury ; therefore detach with care a minute portion of the surface-rock, and drop your prisoner, with every organ in full activity, into a narrow glass cell with parallel sides, filled with clear sea-water, and put the whole on the stage of the microscope, with a power of not more than 100 linear, at least, for the first examination. I greatly mistake if you will not confess that the intellectual treat obtained is well worth—ay, ten times more than worth—all your trouble.”

CRISIADÆ.

The *Crisiadae*, signifying a separation, are generally parasitical. *Crisia cornuta*, or *Goat's-horn Coralline* of Ellis, have the cells linked in a single series, as well as *C. chelata*, or *Bull's-horn Coralline*; the latter look like a number of shoes that come close to the ankle, joined by the toe-part to the heel of others. Ellis says: “This beautiful coralline is one of the smallest we meet with. It rises from tubuli growing upon fuci, and passes from thence into sickle-shaped branches, consisting of single rows of cells, looking when magnified like bull's horns inverted, each one arising out of the top of the other. The upper branches take their rise from the fore-part of the entrance of a cell, where we may observe a stiff, short hair, which seems to be the beginning of a branch. The opening of each cell, which is in the front of its upper part, is surrounded by a thin circular rim; and the substance of the cells appears to consist of a fine transparent shell or coral-like substance.”

Crisia eburnea, or *Tufted-Ivory Coralline*, attains the height of an inch, and displays its beautiful white, bushy tufts, with often a dash of light-red intermingled. Its cells are loosely aggregated, cylindrical,

bent and tubular orifices, free ; while the *Crisia aculeata* has cells closely aggregated, cylindrical, nearly straight, with long slender spines springing from the margin of every cell, giving it a delicate and pretty appearance.

EUCRATIADÆ.

Of the family *Eucratiadæ*, we have to notice a specimen of great interest, the *Anguinaria*,—from the Latin *anguis*, a snake. This is now classed with the *Bryozoa*, but from its external form, and resemblance to the Hydra-form zoophytes, we prefer to retain and describe it where it was originally placed. An account of the *Anguinaria spatulata*, or *Snake-head Coralline*, appeared in the *Transactions of the Microscopical Society*, by Mr. Busk, who corrects many errors before existing respecting this zoophyte. This polyp is parasitical upon fuci, and is not unfrequently associated with other kinds on the same plants, as in fig. 107, No. 2; it is there associated with *Campanularia integra*. The *A. spatulata* “as a whole, consists, like all its congeners, of two distinct portions, one usually termed the radical, and another which constitutes the proper polyp-cells. In the present instance, the arrangement of these parts is in some respects very peculiar and curious ; but it will be found upon strict examination to accord accurately with the universal type. The origin, or base, as it may termed, of the zoophyte, is a more or less rounded disk of small size, probably divided into compartments, as in the *Notamia*, from each of which arises a primary radical branch, in this species very short ; these primary radical branches or tubes are directly continued into a polyp-cell ; but the cavities of the tube and cell are not continuous, being separated by a distinct dissepiment, so that the coarsely-granular contents of the radical tube have no communication with the polyp-cell. The growth of the polyp-cell appears to precede in some degree that of the radical tube continuous from it ; and the development of these two parts seems to be carried on in the usual way, viz. first, in the appearance of a rounded bud filled with granular matter, which gradually increases in length, and the contents of which are finally moulded or resolved into the proper contents of the cell, of which the bud constitutes the origin. In some cases, more than one bud of a radical tube arises at the angle of the polyp-cell ; and in this way arise the apparent branches of the creeping-stem. The walls of the radical tubes and of the polyp-cells consist of a thin transparent horny material, which is insoluble in weak acids, and strengthened or rendered rigid, except in one part, by the deposit of calcareous matter. In the radical tubes, and on the dorsal

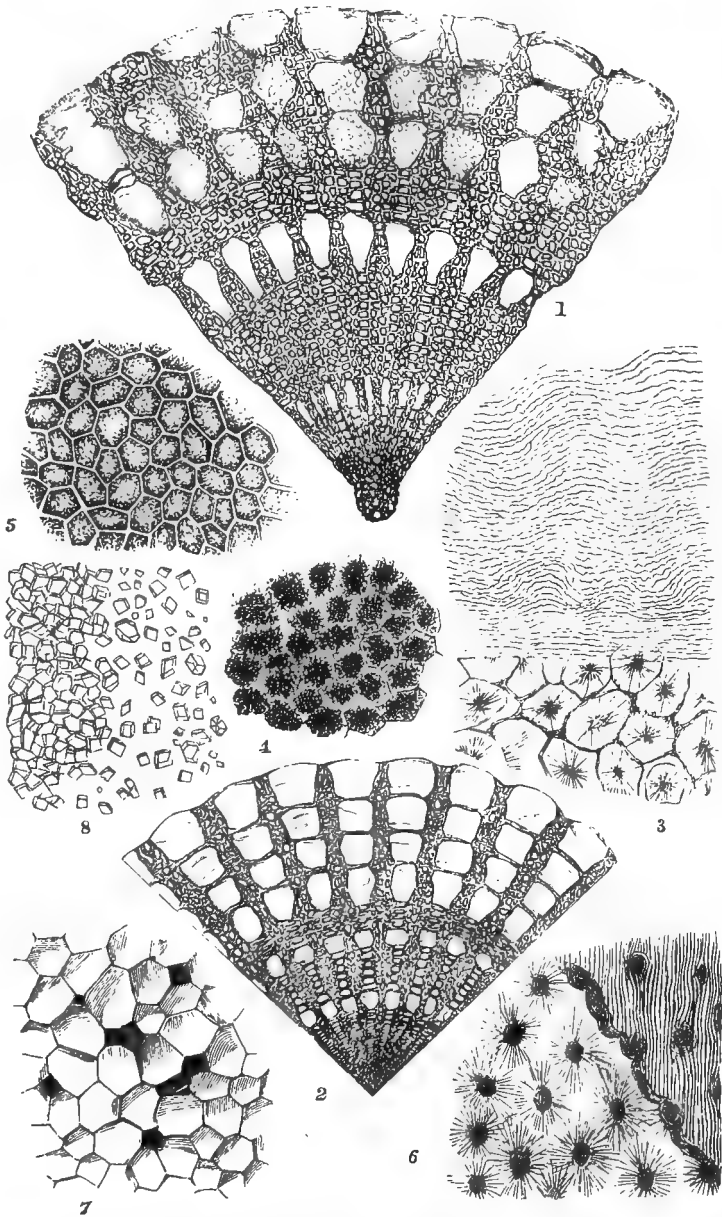

SHELL OF ECHINO-DERMATA, GASTEROPODA, ETC.

1. Portion of a transverse section of the Spine of an Echinus. 2. Another section, exhibiting reticulated structure, the calcareous portion having been dissolved out by acid. 3. Horizontal section of shell of *Haliotis splendens*, with stellate pigment in the interior. 4. Portion of Shell of a Crab, showing granules beneath the articular layer. 5. Another portion of same Shell, showing its hexagonal structure. 6. Horizontal section of Shell of *Terebratula rubicunda*, showing the radiating perforations. 7. Transverse section of shell of *Pinna ingens*. 8. Crystals of Carbonate of Lime, from the outer brown shell of the oyster.

or upper surface of the dilated extremity of the polyp-cell, represented at No. 2, this earthy matter is deposited in the form of minute angular or rounded particles, presenting faint traces of a linear arrangement; but in the main body of the polyp-cell, or the upright portion, the calcareous material is arranged in beautifully regular rings, giving that part of the zoophyte a peculiarly elegant appearance under the microscope. This calcareous ingredient is sufficiently abundant to render the contents of the radical tubes and polyp-cells indistinct; and to obtain a satisfactory view of these parts it is necessary to remove the earthy matter by some weak acid. When this is done, it will be found that the contents of the radical portion are coarsely granular, and the wall rather thicker than those of the proper polyp-cell. The latter contains an ascidian polyp, which has about twelve tentacles, and no gizzard. The polyp, as far as Mr. Busk has observed, is always lodged in the upright portion of the cell; but the long retractor muscular fibres arise near the commencement of the horizontal portion of the cell, and from its upper wall, nearly at one point.

The expanded portion of the cell, besides the special muscles of the aperture, contains other muscular fibres, in all respects resembling those described by Dr. Farre, as conducing to the extrusion of the polyp in *Bowerbankia*, and which are also very distinct in the *Notamia*; but which, in the present instance, would seem to have for their chief function the drawing-up or corrugation of the membranous portion of the polyp-cell. These muscular fibres have a distinct central nucleus or thicker portion, as is the case in the analogous muscles in the other cases just cited."

From the above description, the student in natural history will perceive the discoveries of Mr. Busk so far differ from the accepted account of this zoophyte as to remove it from the family in which it is generally placed, as well as *Notamia bursaria*, to the class Bryozoa.

ESCHARIDÆ.

This interesting family justly deserves the great attention many naturalists have bestowed upon it. Linnæus named it *Flustra*, from the Saxon word *flustrian*, to weave; they are commonly called *Sea-mats*, and resemble fine network spread over stones, rocks, shells, and marine-plants. This network, when submitted to the powers of the microscope, is found to be a cluster of cells, in each of which dwells an animal, that protrudes its feelers when searching for food, and sinks into its little home when tired, or fearful of danger.

Dr. Grant estimates that a single Flustran has as many as four hundred millions of these useful and restless appendages. The feelers vary from ten to twelve; their organisation consists of a long gullet, a gizzard, a stomach and intestines; the body being of a transparent substance. Some take the form of a delicate minute tree, having cells in all parts; and vary in colour, inhabiting every sea. Lamouroux says: "When the animal has acquired its full growth, it flings from the opening of its cell a small globular body, which fixes near the aperture, increases in size, and soon assumes the form of a new cell; it is yet closed, but through the transparent membrane that covers its surface the motions of the polyp may be detected; the habitation at length bursts, and the tentacles protrude; eddies are produced in the water, and conduct to the polyp the atoms necessary for its subsistence."

Dr. Grant writes: "The aperture of the cells is formed by a semi-circular lid, convex externally and concave internally, which folds down when the polyp is about to advance from the cell. The opening of this lid in the *F. truncata*, where it is very long, appears through the microscope like the opening of a snake's jaws; and the organs by which this motion is effected are not perceptible. The lids of the cells open and shut in the Flustræ without the slightest perceptible synchronous motion of the polyps."

Milne Edwards, in writing on the Eschares, remarks, "that the cell, in which it is said the polyp retires as into a shell, is a component part of the animal itself, in which it conceals itself, if we may use the comparison, as the hedgehog enters into the thorny skin of his back. It is not a calcareous crust, which is moulded on the surface of its body, but a portion of the general tegumental membrane of the skin of the polyp, which, by a molecular deposit of earthy matter in the meshes of its tissue, ossifies as the cartilages of superior animals ossify, without ceasing to be the seat of the nutritive movement."

In the formation of their stony skeletons, the animals appear to take no part, "being secreted by the integuments or membranes with which it was permeated and invested, in like manner as the bones and nails in man are secreted by the tissues designed for that purpose, and acting without his knowledge or control. From an analysis of the stony corals, it appears that their composition is very analogous to that of shells. The porcellaneous shells, as the cowry, are composed of animal gluten and carbonate of lime, and resemble, in their mode of formation, the enamel of the teeth; whereas the pearly shells, as the oyster, are formed of carbonate of lime and a gelatinous or cartila-

ginous substance, the earthy matter being secreted and deposited in the interstices of a cellular tissue, as in bones. In like manner, some corals yield gelatine upon the removal of the lime, while others afford a substance in every respect resembling the membranous structure obtained by an analysis of the nacreous (pearly) shells. A recent elaborate analysis of between thirty and forty species of corals, by an eminent American chemist (Mr. B. Silliman), has shown, contrary to expectation, that they contain a much larger proportion of fluorine than of phosphoric acid."

Flustra foliacea is the broad-leaved Horn-wrack of Ellis ; it is about four inches high, brown, and the polypidom is horny. The cells are small, in alternating rows; sometimes covered by a lid that opens downwards. Hook says : " For curiosity and beauty, I have not, among all the plants or vegetables I have yet observed, seen any one comparable to this sea-weed." *Flustra truncata* is abundant in deep water, and grows to a height of about four inches ; it is of a delicate yellow colour, and bushy. The cells have lines in an oblong direction. It is the narrow-leaved Horn-wrack of Ellis.

Flustra chartacea.—Ellis states : " The cells of this sea-mat are of an oblong square figure, swelling out a little in the middle of each side. The openings of the cells are defended by a helmet-like figure ; from hence the polyp-shaped suckers extend themselves. This sea-mat is of a slender and delicate texture, like a semi-transparent paper, of a very light straw-colour. It was first found on the coast of Sussex, adhering to a shell. I have since met, on the same coast, about Hastings, in the year 1765, with several specimens whose tops are digitated, and others that were very irregularly divided."

Flustra carbasea grows out in a leaf-like manner, gradually widening to the end. It is found on shells of a yellowish-brown colour ; on one of the sides the cells are both large and smooth. The animals have about twenty-two arms or feelers, which Dr. Grant, who has written a most careful paper on these polyps, says, are " nearly a third of the length of the body ; and there appear to be about fifty cilia on each side of a tentacle, making 2200 cilia on each polyp." In this species there are more than eighteen cells in a square line, or 1800 in a square inch of surface ; and the branches of an ordinary specimen present about ten square inches of surface ; so that a common specimen of the *F. carbasea* presents more than 18,000 polyps, 396,000 tentacles, and 39,600,000 cilia. The ova of the *F. carbasea* make their first appearance as a small yellow point, a little below the aperture of the cell, and behind the body of the polyp ; they are unconnected with

the polyp, and appear to be produced by the posterior wall of the cell, in the same manner as the axis, or common connecting substance of polyps, produced them in other zoophytes. In this rudimentary state they are found in the same cells with the healthy polyps; but, before they arrive at maturity, the polyps of such cells perish and disappear, leaving the entire cavity for the development of the ovum. There is never more than one ovum in a cell, and it occupies about a third of the cavity when full-grown and ready to escape. When first visible, it has a round or slightly oblong and regular form; when mature, it is ovate, with the small end next the aperture of the cell. The ova do not appear in all the cells at one time; nor is there any discernible order as to the particular cells which produce ova, or the part of the branch which contains them. Cells containing ova are found alike on every part of the branches, from the base to within two or three rows of the apex occupied only by young polyps.

Dr. Grant, in writing more especially of the *F. carbasea*, says: "They are very irritable, and are frequently observed to contract the circular margin of their broad extremity, and to stop suddenly in their course when swimming; they swim with a gentle gliding motion, often appear stationary, revolving rapidly round their long axis, with their broad end uppermost, and they bound straight forward, or in circles, without any other apparent object than to keep themselves afloat till they find themselves in a favourable situation for fixing and assuming the perfect state. The transformation of the ova, from that moving, irritable, free condition of animalcules, to that of the fixed and almost inert zoophytes, exhibits a new metamorphosis in the animal kingdom not less remarkable than that of many reptiles from their first aquatic condition, or that of insects from their larva state."

Flustra avicularis.—This is another of the little beauties of the deep, found usually on old shells, an inch in height, spreading itself fan-like, and of an ashy colour, deeply divided in a dichotomous manner into narrow, thin, plane segments; truncate at the end, formed of four or five series of oblong cells, capped with a hollow, globose, pearly operculum seated between the spines, of which there is one on either side of the circular aperture. The opercula are so numerous that they give to the upper surface the appearance of being thickly strewn with orient pearls; the under surface is even and longitudinally striated, the number of striæ corresponding to the number of rows in which the cells are disposed. Dr. Johnston describes, amongst many other British species, *F. membranacea*, "a gauze-like incrustation on the frond of

the sea-weed, spreading irregularly to the extent of several square inches."

Eschara foliacea (Frontispiece, No. 2).—"This curious polypidom," writes Dr. Johnston, "attains a large size, being often three or four inches high, and from twelve to twenty inches in diameter. It may be described as a broad membrane, twisted into winding folds, leaving large sinuosities and cavernous interstices; it is very light, and floats in water; crisp when dry, membrano-calcareous, cellular, of a yellowish-brown colour, roughish, and punctured with the numerous pores which open on both sides. The membrane is less than a line in thickness, and consists of two layers of cells, separated behind from one another by a thin plate down the middle. The cells open obliquely by contracted roundish apertures disposed in a quincunx order on the surface, and which, more especially when recently formed, are often covered by a small operculum. When a portion of its skeleton is macerated in diluted muriatic acid, it retains the original form, but becomes soft and flaccid from the subtraction of the carbonate of lime. The cells are liable to all the changes of form and character resulting from age in general."

The *Corallines* were at one time considered to be animals, and polyp cells were described by Ellis and Lamarck as existing upon their outer surface; such, however, has been shown to be an erroneous description, and the calcareous material existing in the form of a coating of variable thickness to a mass of cells evidently is of the vegetable character. In the *Nullapores* all the intercellular spaces are filled with lime, so that it would appear that the external surface of the cell-wall possesses the power of separating lime from the sea-water, the crystals of which take a certain definite form of arrangement. They are now classed among plants, under the scientific terms of *Lithophytes*, or Stone Plants, *Corallines*, and *Nullapores*.

As we glance at the map of the world, and think of the profusion of fragrant vegetation and delicious food almost spontaneously produced on the lovely sunny islands of the broad Pacific, how startling does it seem, when we reflect, that these islands, bearing on their bosoms gardens of Eden, are entirely formed by the slow-growing corallines, which, rising up in beautiful and delicate forms, displace the mighty ocean, defy its gigantic strength, and display a shelly bosom to the expanse of day! The vegetation of the sea, cast on its surface, undergoes a chemical change; the deposit from rains aids in filling up the little gaping catacomb, the fowls of the air and the ocean find a resting-place, and assist in clothing the rocks; mosses carpet the surface,

seed brought by birds, plants carried by the oceanic currents, animalcules floating in the atmosphere, live, propagate, and die, and are succeeded, by the assistance their remains bestow, by more advanced vegetable and animal life; and thus generation after generation exist and perish, until at length the coral island becomes a paradise filled with the choicest exotics, the most beautiful birds and delicious fruits, among which man may indolently revel to the utmost desire of his heart.

Dr. Maccullock, in his *Highlands and Western Islands*, observes: "Their plants are made of stone, and they construct islands and continents for the habitation of man. The labours of a worm, which man can barely see, form mountains like the Apennines, and regions to which Britain is as nothing. The invisible, insensible toil of an ephemeral point, conspiring with others in one great design, working unseen, unheard, but for ever guided by one volition,—by that One Volition which cannot err,—converts the liquid water into the solid rock, the deep ocean into dry land; and extends the dominions of man, who sees it not, and knows it not, over regions which even his ships had scarcely traversed. This is the Great Pacific Ocean, destined at some future day to be a world. That same Power, which has thus wrought, by means which blind man would have despised as inadequate, by means which he has just discovered, here too shows the versatility, the contrast of its resources. In one hour it lets loose the raging engines, not of its wrath, but of its benevolence; and the volcano and the earthquake lift up to the clouds the prop and foundation of new worlds, that from those clouds they may draw down the sources of the river, the waters of fertility and plenty."

Ehrenberg, on beholding the coral-beds in the Red Sea, exclaimed: "Where is the paradise of flowers that can rival in variety and beauty these living wonders of the ocean?"

In the *Narrative of the Surveying Voyage of H.M.S. Fly*, J. B. Jukes, Esq., naturalist of the expedition, thus writes: "In a small bight of the inner edge of the coral reef was a nook, where the extreme slope was well exposed, and where every coral was in full life and luxuriance. Smooth round masses of meandrinæ and astreeæ were contrasted with delicate, leaf-like, and cup-shaped expansions of explanariæ, and with an infinite variety of branching madreporæ, and some with mere finger-shaped projections; others with large branching stems; and others again exhibiting an elegant assemblage of interlacing twigs, of the most delicate and exquisite workmanship. Their colours were unrivalled; vivid greens, contrasting with more sober browns or

yellows, mixed with rich shades of purple, from pale pink to deep blue. Bright red, yellow, and peach-coloured millepores clothed those fleshy masses that were dead, mingled with beautiful pearly flakes of escharæ and reteporæ; the latter looking like lace-work in ivory. Amidst the branches of the corals, like birds among trees, floated many beautiful fish, radiant with metallic greens or crimsons, or fantastically banded with black and yellow stripes. Patches of clear white sand were seen here and there on the floor, with dark hollows and recesses, beneath overhanging masses and ledges. All these, seen through the clear crystal water, the ripple of which gave motion and quick play of light and shadow to the whole, formed a scene of the rarest beauty; and left nothing to be desired by the eye, either in elegance of form or brilliancy and harmony of colouring."

Captain Basil Hall thus describes a coral-reef near Loo Choo: "When the tide has left the rock for some time dry, it appears to be a compact mass, exceedingly hard and rugged; but as the water rises, and the waves begin to wash over it, the polyps protrude themselves from holes which were before invisible. These animals are of a great variety of shapes and sizes, and in such prodigious numbers, that in a short time the whole surface of the rock appears to be alive and in motion. The most common form is that of a star, with arms, or tentacles, which are moved about with a rapid motion in all directions, probably to catch food. Others are so sluggish, that they may be mistaken for pieces of the rock, and are generally of a dark colour. When the coral is broken above high-water mark, it is a solid hard stone; but if any part of it be detached at a spot where the tide reaches every day, it is found to be full of polyps of different lengths and colours; some being as fine as a thread, of a bright yellow, and sometimes of a blue colour. The growth of coral appears to cease when no longer exposed to the washing of the sea. Thus a reef rises in the form of a cauliflower, till the top has gained the level of the highest tides, above which the animalcules have no power to advance; and the reef, of course, no longer extends upwards."

Of the myriads upon myriads of organised beings created to work out the grand designs of Providence, all calculation seems futile; as the result would be beyond the grasp of our comprehension. The Polynesian Archipelago, now dubbed one of the great divisions of the globe, has its foundation formed of coral reefs, the spontaneous growth of once-living zoophytes. Of the immense extent of the geographical changes effected by the tiny polyps, Dr. Mantell observes: "We may form some idea, from the facts stated by competent observers, that in the

Indian Ocean, to the south-west of Malabar, there is a chain of reefs and islets 480 geographical miles in length ; on the east coast of New Holland, an unbroken reef of 350 miles long ; between that and New Guinea, a coral formation which extends upwards of 700 miles ; and that Disappointment Islands and Duff's Group are connected by 600 miles of coral reefs, over which the natives can travel from one island to another."

Nothing can be more impressive than the manner in which these diminutive creatures carry out their stupendous undertakings, which we denominate instinct, intelligence, or design. Commencing betimes from a depth of a thousand or fifteen hundred feet, they work upwards in a perpendicular direction ; and on arriving at the surface form a crescent, presenting the back of the arch in that direction from which the storms and winds generally proceed ; by which means the wall protects the busy millions at work beneath and within. These breakwaters will resist more powerful seas than if formed of granite ; rising as they do in a mighty expanse of water, exposed to the utmost powers of the heavy and tumultuous billows that eternally lash against them. It is almost unnecessary to remark, that the formations here referred to are not those of corallines alone, but of zoophytes also.

BRYOZOA.

Bryozoa were placed by Dr. Johnston under the head *Ascidioidea* ; in the generality of works they are named *Bryozoa*, and the individual, *Bryozoon* ; derived from the Greek words $\beta\rho\rho\acute{\iota}\omicron\nu$, sea-moss ; $\zeta\omega\omicron\nu$, animal. (Plate I. Nos. 1, 2.) The distinction to be drawn between it and those already described, consists in the polypidom being a living portion of the polyp, while all others are unorganised ; and that most of the zoophytes we have examined are devoid of cilia, whilst in the *Bryozoon* these are most bountifully supplied. The play of the cilia

DESCRIPTION OF PLATE I. (FRONTISPIECE.)

1. *Bryozoa Bowerbankia*, or *Bowerbank Bryozoon*, showing its internal structure : near it is a smaller animal completely withdrawn into its cell. 2. *Eschara cervicornis*, or *Sea-moss polyp* : the animal is seen drawn out from its shell or chalky covering. 3. *Plumularia pinnata*, or *Feather polyp*. 4. *Campanularia volubilis*, or *Twining polyp*. These polyps are all represented slightly magnified. 5. *Actinia rubra*, or *Sea-marigold*, near which is one shown retracted into its cell. 6. *Actinia Bellis*, or *Daisy sea-anemone* ; a side view of the animal. 7. The same animal seen with its crown of tentacles fully expanded. 8. *Doris tuberculata*. 9. *Laniogerus Eilfortii*. 10. *Aplysia* ; all species of water-snails, the last without a shell-covering. Fronds of *Algæ* are represented growing amongst the rocks. In the title-page many other specimens of marine Polyps, *Actiniæ*, &c., are given.

is most energetic, for the purpose of securing an abundant supply of food, almost without exertion on the part of the creature itself. From this most marked characteristic, Dr. Farre was induced to give them the name of *Ciliobrachiata*. But it has since been discovered that the *Bryozoa* possess a higher organisation than any of the preceding families of zoophytes; and also, from the presence of *striped muscular fibre* in their bodies, naturalists have transferred them, with other animals, the *Flustra*, *Leprælia*, *Anguinaria spatulata*, *Notamia*, &c., to the sub-kingdom *Mollusca*.

Bryozoa are generally found living together in great numbers, and always clothed with hardy coverings or polypidoms. They subsist on animal bodies, and differ from most other mollusca in being able to protrude themselves from their cells. When the animals draw themselves within their protective homes, to the bottom of which they are attached by a sinewy ligament, they double themselves up by bending the lower part of the body upwards. When the creature stretches forth, it presents a beautiful sight, from its blossom-like appearance and busy cilia; its protrusion and retraction are performed with surprising quickness, as it has two sets of muscles for the purpose, one acting on the body of the animal, the other upon its cell. The oral extremity is surrounded by a circle of long tubular tentacles covered with cilia; at each of these feelers or arms there is an aperture, the one at the base communicating with a canal that passes round the edge of the oral aperture or mouth. The food passes down a long gullet, that contracts during the process of swallowing. At the end of this is an orifice that opens into what appears to be a gizzard, having two bodies opposite to each other, with a rough surface, as if for the comminution of food, moved by muscular fibres. Those of the species without this gizzard have a digestive stomach that secretes a coloured fluid. From the upper part of the stomach near the entrance from the gizzard arises an intestine, having a narrow opening surrounded by cilia that proceeds upwards, ending in an orifice near to the tentacles, from which the refuse food is ejected.

“The connection of the polypidom with the soft portion of the polyp is effected,” says Dr. Johnston, “by means of an inner tunic, which, after enclosing the polyp’s body as in a pouch, is afterwards reflected over the aperture of the cell,—the reflected portion becoming exterior and solidified, either by calcareous depositions in its texture, or by a mutation of its thin membranous character into a horny investment, better suited to the office it has now to perform, of protecting the sentient body from a too rough contact of the medium in which

the animals live, and from worse foes. From this mode of connection it results, that when the animals retire within, they at the same time must close the aperture to their cells; for that portion of the inner tunic which is pushed outwards by their exit, in their withdrawal follows the body by a process of invagination, becoming at one and the same time a sheath for the column of tentacles, and a plug to the aperture, which, when of a flexible material, has its margins also drawn tighter and closer together."

The cells are of various shapes, and from one, grow into a family of millions, budding forth from the sides; and though the living matter disappears, the catacombs exist for the foundation of their families, branching out and enduring for ages.

Bryozoon Bowerbankia received its name from Dr. Arthur Farre, in honour of the well-known microscopist, Mr. Bowerbank. A magnified representation of the animal is seen in the frontispiece, Plate I. No. 1.

Dr. Farre gives the following description of *Bowerbankia densa*: "When fully expanded, it is about one-twelfth of an inch in length. In its retracted state, it is completely enclosed in a delicate horny cell, sufficiently transparent to admit of the whole structure of the contained animal being seen through its walls. The cells are connected together by a cylindrical creeping stem, upon which they are thickly set, sessile, ascending from its sides and upper surface. The animal, when completely expanded, is seen to possess ten arms of about one-third the length of the whole body; and each arm being thickly ciliated on either side, and armed at the back by about a dozen fine hair-like processes, which project at nearly right angles from the tentacles, remaining motionless, while the cilia are in constant and active vibration."

Notamia, or *Back-cell*, so named from the cells being exactly opposite, and united back to back with a thick partition, and having a joint above and below each pair.

In some species of the *Flustra* the interior of the cell is protected by a lid which bears some appearance to the head and beak of a bird, and hence it is termed the bird's-head process. This has long been a subject of investigation by naturalists: George Busk, Esq., F.R.S.* contributed to the *Transactions of the Microscopical Society* 1849 an admirable paper on the *Notamia busaria*, or *Shepherd's-purse Coral-line* (represented in fig. 107, Nos. 1 and 3), which adds to our know-

* Mr. Busk has added much to the description here given of this bird's-head process in the *Quarterly Journal of Microscopical Science* for January 1854.

ledge of this curious process. He says: "This most beautiful pearl-coloured coralline adheres by small tubes to fuci, from whence it changes into flat cells; each single cell, like the bracket of a shelf, broad at top and narrow at the bottom: these are placed back to back in pairs, one above another, on an extremely slender tube that seems to run through the middle of the branches of the whole coralline. The cells are open at top. Some of them have black spots in them; and from the top of many of them a figure seems to issue out like a short tobacco-pipe, the small end of which seems to be inserted in the tube that passes through the middle of the whole. The cells in pairs are thought by some to have the appearance of the small pods of the plant *Shepherd's Purse*, by others the shape of the seed-vessel of the *Veronica*, or *Speedwell*.

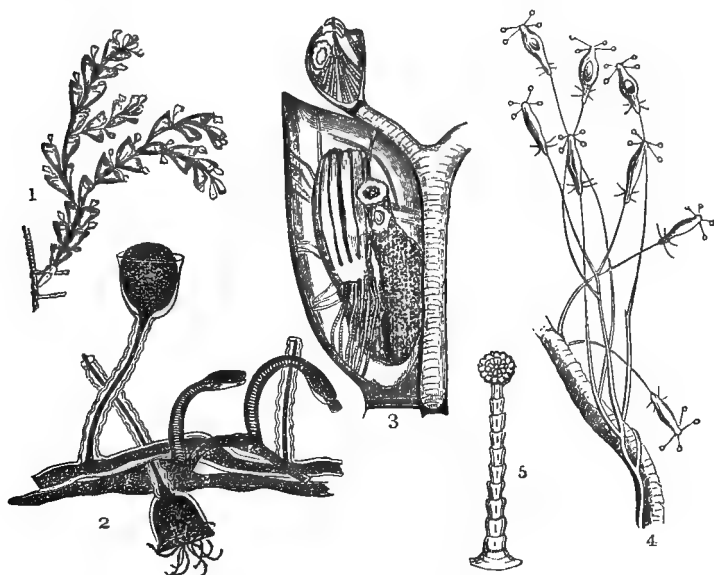

fig. 107.

1. *Notamia busaria*, or *Shepherd's-purse Coralline*. 2. *Anguinaria spatulata*, or *Snake Coralline*, growing with the *Campanularia integra*. 3. The *Shepherd's-purse Animalcule* drawn into its cup, the internal organism of which is shown greatly magnified. 4. *Coryne stauridia*, or *Slender Coryne*. 5. One of the tubercles detached and magnified.

The polypidom of this bryozoon, like those of most of its congeners, may be said to consist of a radical portion, by which it is affixed

to the objects upon which it grows, and of a celliferous portion or branches, upon which the polyps themselves are lodged. The radical portion in the present species consists of a central discoid body of a nearly circular form, and of branches radiating from the periphery of the disk, which thence exhibits something of the aspect of the body of an *ophiura*. The radical tubes or branches springing from the margin of the disk are usually five or six in number, and they are given off at pretty regular distances apart; but besides these radical tubes, one or more celliferous branches are not unfrequently seen to arise immediately from the upper surface of the discoid portion.

The central disk, and the radical tubes arising from it, exhibit a similar structure, and are formed of a thick, firm, apparently horny envelope, containing a coarse granular matter, of a yellowish-white colour, and which in some portions of the tubes assumes the form of distinct irregularly-globular masses, of nearly uniform size. The central disk is subdivided into distinct compartments by septa of considerable thickness, and each radiating branch arises from one of these distinct compartments; so that there appears to be no communication between one radical branch and another. The radical branches give off at irregular distances secondary branches, which ultimately become celliferous. Each of these secondary branches, however, arises from a distinct compartment, as it were, of the tube from which it springs. This compartment is formed, like those of the central disk, by a thick septum, which shuts off the origin of the secondary branch from the main cavity of the primary one."

The larger, or polyiferous cells, Mr. Busk proposes to term *cells*, and the smaller tobacco-pipe-shaped organs *cups*; the latter being usually above the former throughout the polypidom, "excepting immediately below each fork, where the cup is invariably absent above one of the cells of the pair from between which the fork springs.

The polyp-cells are several times larger than the cups, and their walls are much thinner; in fact, sufficiently transparent to allow of the contents of the cell being pretty well seen, without any preparation, even during the life of the animal. In shape they are inversely conical, and the outer and upper angle is usually produced into a prominent, sharp point. From the internal and upper angle arises the tubular prolongation going to form the next cell or cup, as the case may be, in succession. They are entirely closed at the top, contrary to what is stated in all previous notices; and, as has been shown, there is no connection whatever between the cell and the cup placed *immediately* above and behind it. The aperture of the cell is on the anterior

face, and towards the upper margin ; it is of a crescentic form, and placed obliquely, as it were, across the upper and internal angle of the cell, with the convexity of the curve directed upwards and inwards. The lips of the aperture are strengthened by thin bands of horny material ; and, under favourable circumstances, indications of short muscular fibres, for the purpose of opening or closing the aperture, may be observed."

The shell, which Mr. Busk believes to be entire at the bottom, though closed only by a very delicate membrane, contains an ascidioid polyp, of the usual typical form of that class. "It has ten tentacles, and no gizzard. Two sets of muscular fibres at least may be distinguished as appertaining to the polyp. The most important of these are the retractor muscles, which, arising from the bottom of the cell, in the form of long, somewhat flattened, transversely striped, isolated fibres, about the one ten-thousandth of an inch in width, are inserted, some of them at the base of the tentacles, and others lower down the body of the polyp."

When we consider the minuteness of the delicate little sprig which is the natural size of this polyp, we cannot but wonder at the triumphs of the microscope in giving such precise details as Mr. Busk relates of the *Notamia bursaria*. Its beautiful and perfect organisation, the careful provision for the safety and engagements of this minute being, make us awe-stricken at the power of Divine intelligence.

PRESERVATION OF THE POLYPIDOMS OF ZOOPHYTES.

The following excellent and simple plan for preserving Zoophytes as wet preparations, so as to retain the polyps and their tentacular arms *in situ*, was proposed by the late Dr. Golding Bird. "For this purpose a lively specimen should be chosen, and then plunged into cold pure water ; the polyps are killed almost immediately, and their tentacles often do not retract : proper-sized specimens should then be selected, and preserved in weak alcohol. Little phials about two inches long should be procured, made from thin flat glass tubes, so as to be half an inch wide, and about a quarter of an inch, or even less, from back to front. The specimens should be fixed to a thin platinum wire, and then placed in one of these phials (previously filled with weak spirits), so as to reach half-way down. When several are thus arranged, they should be put on a glass cylinder, and removed to the air-pump. On pumping out the air, a copious ebullition of bubbles will take place ; and many of the tentacles previously concealed will emerge

from their cells. After being left in vacuo for a few hours, the bottles should be filled up, closely corked, and tied over, like anatomical preparations in general. For all examinations with a one or two-inch object-glass these bottles are most excellent, and afford cheap and useful substitutes for the more expensive and difficultly-managed cells. In this manner specimens of the genera *Cycloum*, *Membranipora*, *Alcyonium*, and *Crisia*, exhibit their structure most beautifully.

A few dozen of these little bottles hardly occupy any room, and would form a useful accompaniment to the microscopist by the seaside. Any one visiting the caverns in St. Catherine's Island at Tenby, could reap a harvest which would afford amusement and instruction for many weeks. These caverns are so rich in zoophytes and sponges, that they are literally roofed with the *Laomedææ*, *Grantiæ*, and their allies; whilst the elegant *Tubulariæ* afford an ornament to the shallow pools on the floor; and the walls are wreathed with the pink, yellow, green, and purple *Actiniæ*.

When these objects are examined by polarised light, most interesting results are produced. For this purpose, let a piece of selenite be placed on the stage of the microscope, and the polarising prisms arranged so that the ray transmitted is absorbed by the analyser.

If a specimen of *Sertularia operculata* be placed on the selenite stage, and examined with a two-inch object-glass, the central stem is shown to be a continuous tube, assuming a pink tint throughout its whole extent. The cells appear violet in colour; their pointed orifices are seen much more distinctly than when viewed with common light. The vesicles are paler than the rest of the object; and their lids, which so remarkably resemble the operculum of the theca of a moss, are beautifully distinct, being of orange-yellowish colour.

This zoophyte is often covered with minute bivalve shells, distinguished by the naked eye from the vesicles only by their circular form; and these, when present, add much to the beauty of the specimen, presenting a striated structure, and becoming illuminated with most beautiful colours.

Sertularia filicula forms an interesting object; the waved stem becoming of a dusky-red, whilst the cells assume but little colour, renders their mutual relation very obvious. *Sertularia abietina* is also a fine object, especially when loaded with vesicles, as it often is in the autumn. *Plumularia falcata* acquires fresh beauty under polarised light, the cells being a pale green, whilst the tubular stem becomes of a crimson hue; thus presenting a feathered appearance.

The most splendid tints are exhibited by the calcareous structure

of the Polyzoa, and of these the *Flustra truncata*, when viewed on the selenite stage. The *Cellularia avicularia* is very brilliant when viewed in the same way; its cells being covered with plates of carbonate of lime, it presents a fine display of beautiful tints, especially its *bird's-head* appendages.'

The wonders we have brought to view in our glance at the families constituting the zoophytic kingdom, must be regarded with wonder and astonishment by every reflective being. We have seen how wonderfully and fearfully they are made; we have seen the surprising faculties with which they are endowed; we have seen the perfection and order bestowed upon them; we have seen the singular faculties they possess to perform the allotted duties of their destiny; and seeing all these things, we read in plain intelligible language the wisdom, power, and goodness, of an almighty and beneficent Being. We may here state, that we have taken a somewhat more extended view of this department of animated nature, from the very circumstance of its presenting a wider field of deeply interesting and curious subjects for inquiry to the microscopist; and the more especially have these subjects attracted great public attention, from the spirited attempt on the part of the Zoological Society of London to afford us the opportunity of more closely and frequently observing their remarkable habits, enclosed in glass tanks, forming what we now recognise as *marine vivaria*. In our frontispiece, and elsewhere, we have attempted to represent one of these glass cases, merely adding a few magnified figures of the *Bowerbankii*, &c. There the visitor may see the *Sabellæ*, the *Actinice*, of brilliant hues, and many kinds; *Mollusca*, both shelled and naked; *Crustacea*, *Annelida*, &c.; all pursuing their various avocations, enjoying themselves without restraint, under circumstances scarcely distinguishable from those of nature. Mr. Warrington and Mr. Gosse made the experiment about the same time; and from Mr. Gosse's delightful book, entitled *A Naturalist's Rambles on the Devonshire Coast*, we extract the plan he adopted to preserve his marine animals alive for many months in London. He says: "The following facts may be considered as established: marine animals and plants may be kept in health in glass vases of sea-water for a period of greater or less length, provided they be exposed to the influence of light. The oxygen given off by healthy vegetation under this stimulus, is sufficient for the support of a moderate amount of animal life; and this amount can be ascertained by experiment."

But another element in the question soon obtrudes itself. The *Actinæ* and other animals habitually throw off a mucous epidermis, and

other excretions, which fall to the bottom of the vessel, or accumulate around them. The progress of actual decay also continually goes on in the older fronds of the algæ; after a while the presence of this substance becomes too manifest in the offensive odour of the water; in a very short time this leads to disease, and the death of the animal. To prevent this, it is absolutely necessary to present the water to the action of the atmosphere in a divided state, which can only be effected by passing it in driblets, or in a slender stream, from another vessel suspended above that which contains the animals and plants. Another advantage is secured by this process, viz. the aeration of the water; for though the requisite oxygen may be supplied by the agency of the plants alone, the mechanical admixture of the atmospheric air with the water by artificial aeration is highly conducive to the health and comfort of the animals."

We must, as a fitting addenda to the above, give the plan pursued by Mr. Gosse, to establish his marine vivarium on a small scale. "The first thing to be done, is to obtain the algæ in a growing state. As they have no proper roots, but are generally found closely attached to the solid rock, from which they cannot be torn without injury by laceration, I have always used a hammer and chisel to cut away a small portion of the rock itself, having ready a jar of sea-water, into which I dropped the fragment with its living burden, exposing it as little as possible to the air. The red sea-weeds I have found most successful; the *Fuci* and *Laminariæ*, besides being unwieldy, discharge so copious a quantity of mucus as to thicken and vitiate the water. The *Ulvæ* and *Enteromorphae*, on the other hand, are apt to lose their colour, or become a colourless membrane, and decay from their attachments. The species most capable of being preserved are *Chondrus crispus*, the *Delessaria*, and *Iridea edulis*. The last named is the best of all, and next to it the *Delessaria sanguinea*, for maintaining the purity of the water; while the colours and forms of these render them very beautiful objects in the vase. Into this were placed specimens of *Anthea cereus*, *Actinia*, *Crisia denticulata*, *Coryne*, *Pedicillina Belgica*, *Membranipora pilosa*, *Doris*, *Polycera*, *Serpula*, *Acarida*, *Entomotraca*, *Infusoria*, *Grantia nivea*, and other smaller zoophytes and sponges." Most of these appeared to enjoy existence, and afforded, no doubt, months of most interesting microscope examinations; at the same time the vivarium will form a beautiful and attractive ornament for the conservatory or drawing-room.

Mr. Warington, in his trials, found that it was not sufficient that there be plants alone; but where the higher animals, such as fish, are

kept, it is necessary that some beings should be introduced for the purpose of *feeding* on the decaying vegetable matter. This desideratum is supplied by the various forms of phytophagous mollusca. So that, to maintain perfect health, it is necessary to place in the glass seaweeds, mollusca, fish, &c. ; but those should not be put together which will devour each other. The sea-water should be kept near the same temperature always, about 60° Far. ; and the loss by evaporation supplied by adding rain or distilled-water from time to time. All dead animal or vegetable matter should be removed, and the glass vase kept near the window, exposed to the influence of light.

It is quite possible to make an artificial sea-water, for the purpose of supplying these tanks. In water manufactured as follows, the animals and plants will thrive and do well. Take 15 pints of water from the house-cistern, and add to it 7 ozs. of table-salt, $\frac{1}{2}$ oz. of Epsom salts, 80 grains of chloride of potass, and 400 grains of chloride of magnesia. Any chemist can supply or prepare this.

Mr. N. B. Ward, whose fern-cases have now become universal favourites, made the earliest attempt to establish, on a small scale, an "*aquarium for fish and plants.*" He writes :* "I placed ten or twelve gold and silver fish, in company with several aquatic plants, viz. *Vallisneria spiralis*, *Anacharis alsinastrum*, *Pontederia crassipes*, *Papyrus elegans*, and *Pistia Stratiotes*, which plants, by means of their vital actions, as had long been well-known, maintained the purity of the water, and, as in the atmosphere, kept up the balance between the animal and vegetable respirations. Placed in the centre of my fern-house, and nearly surrounded by rock-work (rising five or six feet above the margin of the vessel), clothed with *Adiantum* and other lovely ferns, and partially overshadowed with the palmate leaves of *Corypha australis*, the plants and fish continued to flourish for years. The only enemy I had to contend with was a species of *Vau-cheria*, which from its rapid growth, required to be kept constantly in check. My friend, Mr. Bowerbank, always alive to scientific inquiries, followed up these experiments with equal success ; but substituted sticklebacks and minnows for the gold fish, and a few snails (*Limeus stagnalis*) to get rid of the decaying leaves of *Vallisneria spiralis*, &c."

* "On the Growth of Plants in closely-glazed cases," by N. B. Ward, Esq., F.R.S.

ACALEPHÆ.

In great variety of form and colour, swimming freely about the waters of the ocean, are found in abundance the beautiful Acalephæ. From some of them having a remarkable stinging property, they have derived their name of *Sea-nettles*, while others, from their gelatinous nature, are commonly called *Sea-jelly*, or *Jelly-fish*; one of which is shown in the title-page of this work, depending from the top.

These interesting animals were first arranged in three orders: *A. stabiles* (fixed), *A. liberæ* (free), and *A. hydrostaticæ* (hydrostatic). Cuvier classed them in two orders: *A. simplices*, and *A. hydrostaticæ*. They are now, however, divided into four orders, and classed in groups according to the peculiar mode in which they effect their locomotion.

The *Medusæ*, spread on the surface of the water, a beautiful jelly-like mass, that in form resembles an umbrella; and by a continual contraction and opening out of this part, they pass along in the path they desire. They are all more or less phosphorescent. The *Beroë*, like many of the Infusoria, propel themselves with active ciliated arms. (See fig. 115.) The *Physalidæ* have an organ common to fishes,—swimming bladders,—by filling or emptying which they rise or sink, and move along in their watery home.

The *Portuguese Men-of-war* have a large bladder, which, when filled with air, rises above the surface of the waves, and is propelled by the wind; a contrivance something similar to, though more successful, we suspect, than the proposition to drag along land-carriages by means of balloons.

The flat circular horny disk forming the skeleton of *Propita gigantea*, to the naked eye exhibits both radiating and concentric markings; and when examined with a power of 40 diameters, its upper surface is found to be furrowed, and two rows of small projecting spines occur upon the ridges between the furrows, the ridges being the radiating fibres above noticed. The under-surface, or that to which the greater portion of the soft parts of the animal are attached, is more deeply furrowed; and plicæ or folds of the mantle fit accurately into the furrows, from which they can easily be removed by the application of a gentle force. The concentric markings have in all cases small scalloped edges; they occur at certain regular intervals, and are so many indications of the lines of growth. In the centre there is a circular depression; and between its circumference and that of the first concentric marking, there are eight flattened radii. If the under-surface be examined with a power of 100 linear, the ridges will all be found to have small jointed tubular pro-

cesses like hairs projecting from them. In no part of this horny tissue is there a trace of a cellular or a reticular structure.

The most singular incidents in the history of the *Medusæ* are the circumstances connected with their reproduction. They are all propagated by eggs, which the females produce in glandular organs, sometimes arranged in bands or patches on the surface of the sub-umbrella, and sometimes in cavities at the base of the peduncle. But these ova, when excluded from the body of the parent, develop an animal quite different in form from that from which they sprang; and it is only in the second generation that the original *Medusa* is reproduced. The eggs are developed, to a certain extent, in small pouches, placed beneath the body, and in the arms of the mother, whence they are not excluded until they have acquired the form of an active infusorial animalcule, furnished with cilia, enabling them to swim freely in the water. After a time, the little animal attaches itself by one extremity in some suitable position, and awaits its further development. Arms are soon formed at its upper extremity, and it now presents the appearance and takes its food in the manner of a hydraform polyp. At this stage of its growth buds are often produced, just as in a true hydra. The body now increases considerably in length, and becomes constricted, or divided by wrinkles of the surface into numerous segments; these become more and more distinct, their edges become notched, and at length the animal resembles a pile of jagged saucers placed one upon another, and surmounted by a crown of tentacles. At length these separate, and swim about like little *Medusæ*; and, after undergoing some changes, they acquire the form and colouring of the common *Medusa aurita* of our coasts. So completely do what, for want of a better term, we must call the preparatory state of these animals, resemble hydroid polyps, that their connection with the *Medusæ* has only been quite recently discovered; and the species just referred to has been described under the name of *Hydratuba*; and from their great resemblance to the Tubularian and Sertularian polyps, some zoologists have proposed the removal of the whole of the hydroid polyps into the present class, of which many of them are certainly only stages of development. Opinions are still so much divided, however, as to the true affinities of these animals, that we have preferred leaving the hydroid polyps in their old position to placing them where few of our readers would think of looking for them.

Wonderfully beautiful as are these creatures in form and colour, the amount of solid matter contained in their tissues is incredibly small. The greater part of their substance appears to consist of a fluid, dif-

fering little, if at all, from the sea-water in which the animal swims; and when this is drained away, so extreme is the tenuity of the membranes which contained it, that the dried residue of a "jelly-fish," weighing only two pounds, which was examined by Professor Owen, weighed only thirty grains.

The transparency of the tissues renders the whole of the *Acalephæ* delightful objects for the microscope. (See an excellent paper in the *Transactions of the Microscopical Society*, "On the Anatomy of Two Species of Naked-eyed Medusæ," by G. Busk, Esq.; also Professor Forbes' various works on this family.)

ECHINIDÆ.

These creatures form an extensive class, to which the above name has been applied, as well as that of *Echino-dermata*, *Sea-urchins*, or *Sea-eggs*. *Asterias*, or *Star-fish*, are the best known family of this class.

The *Echino-dermata* are divided into four orders. In two of these the body is more or less flattened or discoid in its form, and usually furnished with five or more arms. These in the first order, the *Crinoidea*, are slender, and formed of complete calcareous rings or cylinders; whilst in the second, the *Stellerida*, the calcareous covering of the arms is composed of separate plates. In the third order, the *Echinida*, the calcareous plates have become united into a regular shell; and the fourth includes the worm-like forms, the *Holothuriæ*.

The amount of the calcareous deposit in the skin varies greatly in the different animals composing the class. In some (as the *Holothuriæ*) it forms small irregular grains, scattered, not very plentifully, through the substance of the skin; in others, as the *Star-fishes* (*Stellerida*), it constitutes plates of various forms, fitting closely to one another, but only connected by the agency of the true skin; so that although the body is completely encased in a suit of calcareous armour, every part of it still retains considerable flexibility. In others again, as the *Sea-eggs* or *Sea-urchins* (*Echinida*), these plates are positively united together, forming a continuous shell, within which all the organs of the animal are enclosed. Upon most of these calcareous plates tubercles are to be seen, which serve for the articulation of movable spines, often of considerable size. These assist the animal in its motions; and it is from their almost universal presence that the name of the class (*Echino-dermata*,—*echinos*, a spine, and *derma*, skin) is derived.

Echinida may be found in abundance upon our sea-shores, lurk-

ing among the rocks, where they entrap their prey. The spines and suckers are used as feet, or as a mode of progression, even to the climbing of rocks, in order to feed upon the corallines and zoophytes : he marches along with ease where apparently no footing could be found, or digs a hole with his spines to bury himself in the sand, to escape his pursuer, or to hide himself from observation.

The skeleton of these animals generally consists of an assemblage of plates, or joints, of calcareous matter. The minute structure of which presents more or less a reticulated character ; and the solid parts are usually composed of a series of superimposed laminæ or scales. The openings, or areolæ, in one layer being always placed over the solid cell-walls of the layer beneath it, the spines are situated on the external surface of the shell ; they are generally of a conical figure, and are articulated to the tubercles by a ball-and-socket joint. When a thin transverse section of one of these spines is examined with the naked eye, it appears to be made up of a series of concentric layers, varying considerably in number ; not, however, with the size of the spine, but with the distance from the base at which the section was made ; when a section taken from the middle of the spine is examined with a power of fifty diameters, it will be seen that the centre is occupied by a reticulated structure ; around the margin of this may be observed a series of small structureless spots, arranged at equal distances apart (Plate VI. No. 2) ; these are the ribs or pillars, and indicate the external surface of the first layer deposited ; passing towards the margin, other rows of larger pillars may be seen, giving it a beautiful indented appearance ; all the other parts of the section are occupied by the usual reticulated tissue. In the

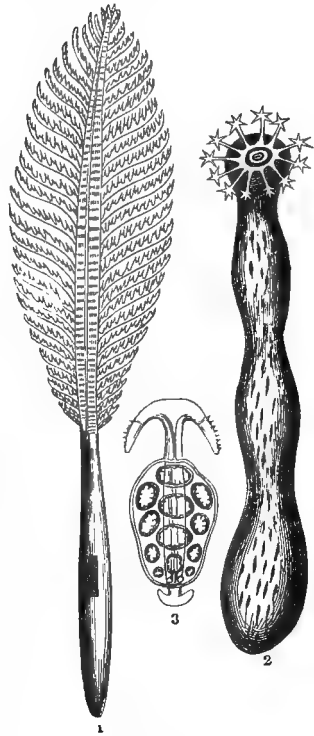

fig. 108.

1. Polypidom of *Pennatulæ phosphorea*. 2. *Synapta*. 3. Anchor-shaped spiculum and plate from its skin.

greater number of spines the sections of the pillars present no structure, in others they exhibit a series of concentric rings of successive growth, which strongly remind us of the medullary rays of plants; occasionally they are traversed by reticulated structures, as represented in Plate VI. No. 1. When a vertical section of a spine is examined, it will be found to be composed of a series of cones placed one over the other; the outer margin of each cone being formed by the series of pillars. In the genus *Echinus*, the number of cones is considerable, while in that of *Cidaris* there are seldom more than one or two; so that from such species transverse sections may be made, having no concentric rings, and in which only the external row of pillars may be seen.

“The skeleton of Echino-dermata contains very little organic matter. When it is submitted to the action of very *dilute acid*, to dissolve out the calcareous matter, the residuum is very small in amount. When obtained, it is found to possess the reticular structure of the calcareous shell (Plate VI. No. 7); the meshes or areolæ being bounded by a substance in which a fibrous appearance, intermingled with granules, may be discerned under a sufficiently high magnifying power, as was first pointed out by Professor Valentine. This tissue bears a close resemblance to the *areolar* tissue of higher animals; and the shell may probably be considered as formed, not by the consolidation of the cells of the epidermis, as in the mollusca, but by the calcification of the fibro-areolar tissue of the true skin. This calcification of areolar or simply fibrous tissue, by the deposit of mineral substance, not in the meshes of areolæ, but in intimate union with the organic basis, is a condition of much interest to the physiologist; for it presents us with an example, even in this low grade of the animal kingdom, of a process which seems to have an important share in the formation and growth of bone, namely, in the progressive calcification of the fibrous tissue of the periosteum membrane covering the bone.”*

From their peculiarity of structure, they may be said to be almost imperishable. Their shells exist abundantly in all our chalky cliffs, innumerable specimens of which may be obtained, exhibiting the same wondrous forms and characters as those which now frequent our shores.

The *Crinoidea*, or *Sea-lilies*,—so called from the resemblance which many of them present to flowers,—were exceedingly abundant in former ages of the world; and their remains often form the great bulk of large masses of rock. During the whole or a part of their existence,

* Dr. Carpenter, *Cyclopadia of Anatomy and Physiology*.

these animals are attached to submarine bodies by a longer or shorter stalk, composed of calcareous rings similar to those of which the arms are composed.

The family *Encrinidæ*, or *Sea-lilies*, fig. 109, includes an immense number of fossil forms ; and one or two are still to be found in the West Indian seas. These animals were all supported upon a long stalk, at the extremity of which they floated in the waters of those ancient seas, spreading their long arms in every direction in search of the small animals which constituted their food. Each of these arms, again, was feathered with a double series of similarly jointed appendages ; so that the number of separate calcareous pieces forming the *skeleton* of one of these animals was most enormous. It has been calculated that one species, the *Pentacrinus Briareus*, must have been composed of at least one hundred and fifty thousand joints ; and “as each joint,” according to Dr. Carpenter, “was furnished with at least two bundles of muscular fibre,—one for its contraction, the other for its extension,—we have three thousand such in the body of a single *Pentacrinus*—an amount of muscular apparatus far exceeding any that has been elsewhere observed in the animal creation.”

A *furrow* runs along the inside of the arms, covered with a continuation of the skin of the disk ; and from this the ambulacra are protruded, as in other Echino-dermata.

The third family, the *Comatulidæ*, or *Hair-stars*, includes a considerable number of animals, which bear a great resemblance, both in form and structure, to the *Encrinidæ*.

The *Encrinus* being supported upon a long flexible stalk, formed of calcareous cylinders, is so close a resemblance, that when first discovered the young of *Comatula* was described as a *Pentacrinus*. These animals are tolerably numerous in the seas of the present day, and may be said to represent the living type of this and the preceding class ; they are shown in fig. 116.

In the family of *Ophiuridæ*, so called from the resemblance of their arms to serpents' tails (Gr. *ophis*, a snake, *oura*, a tail), the body forms a roundish or somewhat pentagonal disk, furnished with five long simple arms, which have no furrow for the protrusion of the ambulacra. The *Ophiuridæ* are exceedingly plentiful in all our seas, and their remains

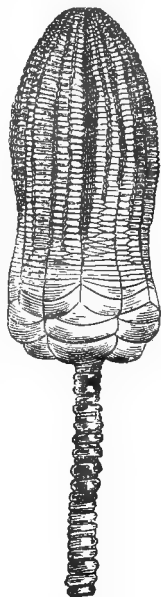

fig. 109.

Encrinus, or
Sea-lily.

occur in all the more recent marine strata of the earth's crust. They are commonly called *Sand Stars*, or *Brittle Stars*, fig. 110.

The family *Asteridæ*, the common Star-fish, so abundant on our coasts, is an example. In this family the arms appear to be merely prolongations of the disk; they are usually five in number, and the plates from which the ambulacra are exerted are placed in deep furrows, which run along the lower surface of the arms.

HOLOTHURIÆ, OR SEA-CUCUMBERS.

In this order the body acquires a worm-like form. The radiate structure is in fact scarcely recognisable in these animals, except in the arrangement of the tentacles which surround the mouth. The body is always more or less elongated, with the mouth at one end and the anal opening at the other; the calcareous deposit in the skin is reduced to scattered granules; and in one family the ambulacra are entirely wanting.

This order is divided into two families. The first, the *Synaptidæ*, are characterised by the total absence of ambulacra, the motions of the animals being assisted by peculiar anchor-like processes of the calcareous grains which project from the skin, and roughen the surface of the animal. The spiculum represented at fig. 108 is serrated on the convex edge, and the opposite extremity is recurved, and appears to be connected in some peculiar way with the oval plate upon which it lies. It is a beautiful object for polarised light.

In the *Holothuriæ*, on the contrary, the ambulacra, although short, exactly resemble those of the other *Echino-dermata* in their structure and action. The mouth is surrounded by a ring of calcareous plates serving for the attachment of the longitudinal muscles, by which the contractions of the body are effected. These animals inhabit the seas of most parts of the world. Some of them are eaten even by European populations; and the Trepang (*Holothuria edulis*) is an article of luxury amongst the Chinese. A few living specimens have been lately introduced into the tanks at the Zoological Gardens, where they are established as objects of great interest to the naturalist.

CHAPTER III.

MOLLUSCA.

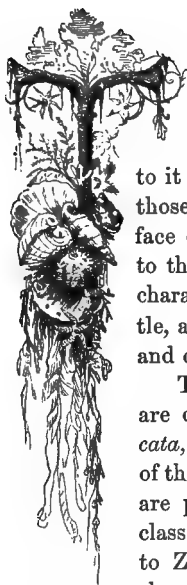

THE term *Mollusc* is derived from the Latin, and signifies soft; the body of the animal being soft and fleshy, partly or entirely covered by a shell attached to it by means of muscles. The shells are of two kinds; those of an epidermal character being formed upon the surface of a filmy cloak-like organ called a mantle, answering to the true skin of other animals; and those of a dermal character being concealed within the substance of the mantle, and frequently moulded into a great diversity of forms, and coloured with various tints.

The animals belonging to the molluscous sub-kingdom are divided into the following orders, viz. *Bryozoa*, *Tunicata*, *Conchifera*, *Gasteropoda*, *Pteropoda*, and *Cephalopoda*; of these, all, except the *Tunicata* and a few of the *Pteropoda*, are provided with a hard calcareous shell. In the first class of the Mollusca, the *Bryozoa* approximating so closely to Zoophytes, and from their having been until lately classified with them, we have thought it more convenient to the microscopist to retain them in that class with the Eschara.

In the *Conchifera* the most simple rudimentary form of shell is met with; for example, in the common slug, *Limax rufus*, it occurs as a thin oval plate, imbedded in the shield situated on the back and near the head of the animal. The shell of all the oyster genus (*Pinna*) is composed of a series of hexagonal cells filled with transparent calcareous matter, seen at fig. 7, Plate VI. Dr. Carpenter has shown that the outer layer of the shell can be split up into prisms, like so many basaltic columns, fig. 93, No. 1.

When molluscous shells are composed of a single piece, they are termed *univalves*; when of two pieces, *bivalves*. The bivalve *Mollusca* exhibit no traces of any distinct head; whilst, in the univalves, this part of the body is well-marked, and usually furnished with special organs of sense (tentacles, eyes, &c.).

The older naturalists also recognised a group of multivalve shells, or

shells composed of several valves. The majority of these belonged to the Cirrhopod order of *Crustacea*, which were regarded as *Mollusca* by



fig. 110.

Mollusca, &c. *Padina pavonia*, Peacock's-tail, from south-coast; Ophiura, Sand star, *Purpura lapillus*, Whelk, Limpet, &c.

the earlier observers. The *Pholades*, however, which in other respects are true bivalve *Mollusca*, are furnished with a pair of accessory plates in the neighbourhood of the hinge; whilst the Chitons, fig. 106, a small but singular group of *Mollusca* nearly allied to the univalve limpets, have an oval shell composed of eight movable plates, which gives them a great resemblance to enormous woodlice; and they have been regarded as forming a sort of transition towards the articulated division.

Many *Mollusca* are not furnished with a shell, or have only a small calcareous plate enclosed within the mantle. These are called naked *Mollusca*, an example of this family is seen in the frontispiece, *Aplysia*; but it is remarkable, that most of them are provided with a small shell at their first quitting the egg. In the shell-bearing, or *testaceous Mollusca*, this embryonic shell, which often differs greatly in shape and texture from the shell of the mature animal, forms the commencement of the latter, additions being constantly made to its free edge by the secretion of calcareous matter at the edge of the mantle. The delicate membranous part of the mantle, which lines the interior of that part of the shell inhabited by the animal, has, however, the power of secreting a thin layer of shelly matter upon the inner surface. This is frequently of a pearly lustre; and in many bivalves a new layer of this substance is deposited at the same time that the size of the shell is increased by additions to its margins,—for, it must be observed, that the formation of new shell is not constantly going on, but appears to be subject to periodical interruptions, indicated by lines on the surface of the shell; these are called lines of growth. In many cases the margin of the mantle, instead of being even, presents lobes or tubercles, which produce corresponding irregularities,—ribs, tubercles, or spines,—on the surface of the shell.

Mr. Bowerbank says, shell is developed from cells that in process of growth have become hardened by the deposition of calcareous matter in the interior. This *earthy* matter consists principally of carbonate of lime, deposited in a crystalline state; and in certain shell, as in that of the common oyster (Plate VI. No. 8), from the animal-cell not having sufficiently controlled the mode of deposition of the earth particles, they have assumed the form of perfect rhomboidal crystals.

The Oyster belongs to the class called *Acephalus*, or *non-headed*, as it has no distinct head. The gills, or breathing apparatus, form what is commonly called the beard of the oyster. The creature is attached by strong muscles to its shell. The mouth of the oyster is a mere opening in the body, without jaws or teeth; and its food consists of nourishing substances contained in the water, and which are

drawn into the shell when it is open by means of cilia. Oysters attach one of their valves to rocky ground, or some fixed substance, by a mucilaginous liquid, which soon becomes as hard as the shell. They generally spawn in May; and their growth is so rapid, that in three days after the deposition of the spawn, the shell of the young oyster is nearly a quarter of an inch broad; and in three months it is larger than a shilling. The spawn is a very interesting object for microscopic examination, especially when viewed under polarised light. The young fry is shown in fig. 121, nearly ready to escape from the shell.

The well-known ciliary currents in the fringes of the oyster induced me to examine the contents of the stomach, under the expectation of finding some minute forms of Infusoria; for it seemed but reasonable to infer that the absence of locomotive power, and the consequent inability of seeking for food, might be compensated by so beautiful a contrivance for ensuring constant nourishment. My expectations were fulfilled and surpassed. In the stomach of every oyster I examined, and in the alimentary canal, I found myriads of living Monads, the *Vibrio* also in great abundance and activity, and swarms of a conglomerate and ciliated living organism, which may be named *Volvox ostrearivus*, somewhat resembling the *Volvox globator*, but of so extremely delicate a structure, that it must be slightly charred to be rendered permanently visible.

The *Pearl Oyster*.—At one time a most extravagant value was set upon pearls: for one of these molluscous secretions, it is recorded that Tavernier paid the sum of 110,000*l.*; it was found at the Catifa fishery, off the coast of Arabia. At the Bahrein Islands, Persian Gulf, the produce of the two months' fishing is said to average 90,000*l.*

Pearls are usually found in the *Meleagrina Margaritifera*, or *Pearl Oyster*; also in a mussel termed *Mya Margaritifera*. An inferior kind of pearl is also found in many mussels of the rivers of Great Britain; and, at one time, the pearl-fishery of Ireland was greatly celebrated. The oysters on our coasts have frequently a dull, common kind of pearl within their shells.

Naturalists somewhat differ in their opinions as to the mode in which pearls are formed. Some think that they are caused by particles of sand having got into the stomach; the animal, to prevent the roughness of these particles from injuring its delicate structure, covers them over with a secretion from its body, and by continual additions, they are gradually increased in size. It is now, however, pretty generally admitted to be a disease; and it is quite certain that the pearls are matured on a nucleus, consisting of the same matter as that from

which the new layers of shell proceed at the edge of the mussel or oyster. The finest kind are formed in the body of the animal, or originate in the pearly part of the shell. It is by the size, roundness, and brilliancy of pearls that their value is estimated. They are found either in the mantle of the animal, or attached to the inner surface of the shell.

Pearls have been produced in an artificial manner; Apollonius, the philosopher of Tyana, who is supposed to have died at an advanced

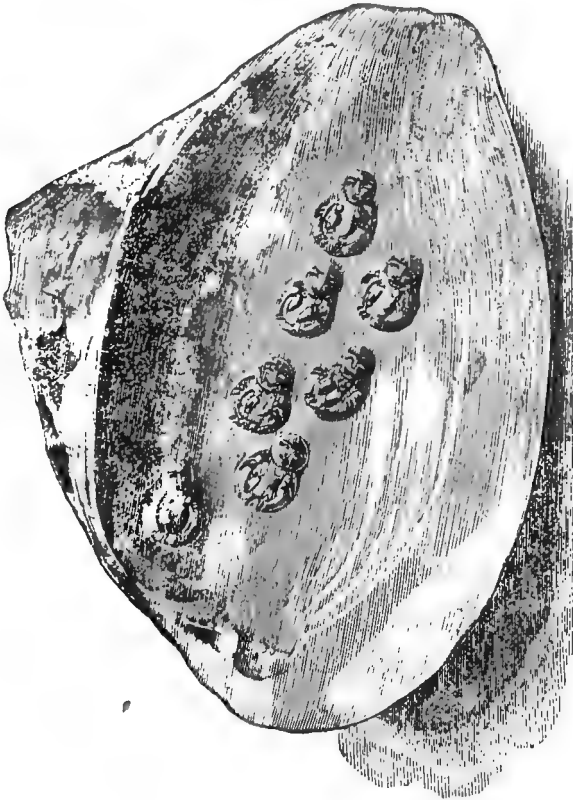

fig. 111. Artificial Pearls in the shell of *Mya margaritifera*.

age in the year 97, being the first to notice such a practice, on the borders of the Red Sea. Sir Joseph Banks had specimens of some Chinese mussels, in which were small pieces of iron covered with a

pearly substance, that at first seemed to give countenance to such a story.

Mussels, in which these artificial pearls had been formed by the Chinese, have been recently brought to this country by Mr. Rawson, from one of which the preceding drawing was made (fig. 111); it is represented of the natural size, with the simple pearls adhering to the shell. The account furnished by this gentleman at the same time is, "that they are only obtained near Ning-po. The *Hermes* steamer being on a visit to that place, he was able to obtain a few living specimens; in which, on being opened, several pearls, as many as eighteen or twenty, were found in the course of formation. It appears they are formed by

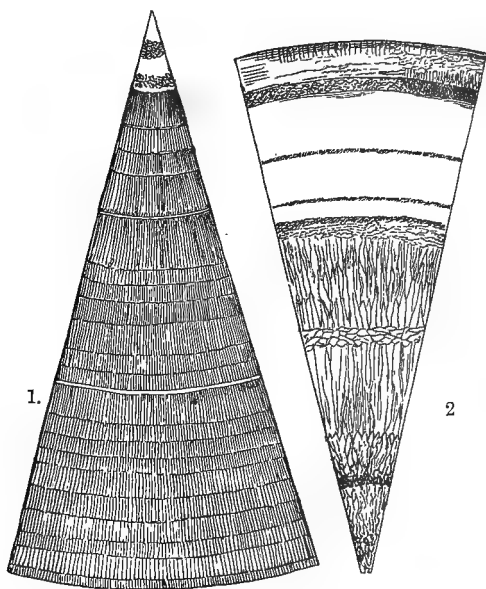

fig. 112.

1. A transverse section of a Pearl from the Oyster, showing its prismatic structure.
2. A transverse section of another Pearl, showing its central cellular structure and outside rings of true pearly matter. Magnified fifty diameters.

introducing some pieces of wood or baked earth into the animal while alive, which, irritating it, cause it to cover the extraneous substance with a pearly deposit. Little figures made of metal are frequently introduced; and, when covered with the deposit, are valued by the

Chinese as charms. These figures generally represent Buddha in the sitting position, in which that image is most frequently portrayed."

The microscope discloses the different structure of pearls: those having a prismatic cellular structure, have a brown horny nucleus, surrounded by small imperfectly-formed prismatic cells; then there is a ring of horny matter, followed by other prisms, and so on, as represented in fig. 112, which are transverse sections of pearls from oysters, showing successive rings of growth, or deposits.

In a horizontal section (fig. 113) of another pearl, the prismatic structure and the transverse grooves of the prisms are very well

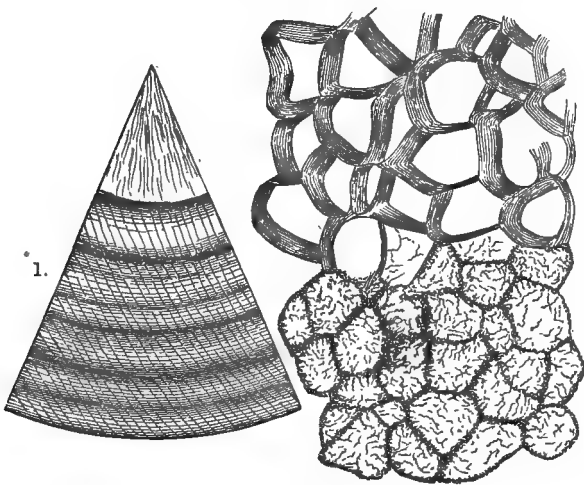

fig. 113.

1. A transverse section of a small pearl from a species of *Mytilus*. 2. A horizontal section of a Pearl magnified 250 diameters, showing its prismatic structure, and the transverse striæ of the prisms.

shown. The prisms are smallest in the centre, and nearly filled with dark matter, as are also some nearer the edge. In a segment of a transverse section of a small purple pearl from a species of *Mytilus*, all trace of prismatic structure has gone, and only a series of fine curved or radiating lines are seen. It consists of a beautiful purple-coloured series of concentric laminæ (fig. 113). Many of this kind of pearls have a series of concentric zones, and some are of a yellow tint. The most beautiful sections for microscopic examination are obtained from Scotch Pearls.

The true pearls are composed entirely of nacre, and are exquisite in their colouring. Their structure is shown highly magnified at No. 2, fig. 113. Some, again, are composed of nacre and prismatic cellular structure; the centre having the prismatic formation, banded outside by two rings of the true pearly matter—nacre, or “*mother-of-pearl*.”

In the shell of the *Terebratula*, or *Coach-spring shell*, there are openings surrounded by a series of radiating lines, which at first appear like dark oval spots; but in a vertical section they will be seen to be perforations or tubes running obliquely from the inner to the outer surface of the shell, and having a series of radiating lines on the edge, as in No. 6, Plate VI. The outer layer has here been removed to show the radiating structure around the perforations. Dr. Carpenter has elaborately described the *Terebratula* in the *Philosophical Magazine*, 1854.

Not less curious than beautiful is the internal layer of different kinds of bivalves, which present a nacreous or iridescent lustre, the whole of its surface being varied with a series of grooved lines running nearly parallel to each other. One of the most remarkable is the well-known Ear-shell, *Haliotis splendens*; this has been ascertained to consist of numerous plates, resembling tortoise-shell, forming a series of hexagonal cells, in the centre of which the stellate pigment is deposited (Plate VI. No. 3), alternating with thin layers of pearl, or *nacre*; and this exhibits, when highly magnified, a series of irregular undulating folds, represented in the upper portion of the section. The iridescent lines are often extremely pleasing; and if a piece be submitted to the action of diluted hydrochloric acid, until the calcareous portion of the nacreous layers be dissolved out, the plates of animal matter fall apart, each one carrying with it the membranous residuum of the layer of nacre that belonged to its inner surface. But the nacre and membrane covering some of these horny plates remain undisturbed; and their folded or plaited surfaces, although divested of calcareous matter, exhibit iridescent hues of the most gorgeous description. But if the membrane is spread out with a needle, and the plates unfolded to a considerable extent, the iridescence is no longer seen; a fact which clearly demonstrates, that the beautiful effects presented by the nacreous portions of shells, commonly called *mother-of-pearl*, are produced solely by the disposition of single membranous layers in folds or plaits, lying more or less obliquely to the general surface.

GASTEROPODA.

The *Gasteropoda* (*belly-creeping* animals) are characterised by their being provided with a fleshy disk, serving as a foot upon which to creep. The back is covered with a cloak, in or upon which the shell is secreted, and may consist of one or more pieces. All the shells are remarkable for the small amount of the animal as compared with that of the earthy matter, so that they are extremely brittle, and their fractured surfaces have a crystalline appearance. In some the shell is of a horny texture, for example, in the *Aplysia*, *Sea-hare* (Plate I. No. 10); it is also transparent and flexible.

The majority of the *Gasteropoda* are furnished with a shell, which has been denominated *spirivalve*. The cause of this spiral arrangement is said to be owing to the shape of the body of the animal inhabiting the shell, which, as it grows, principally enlarges its shell in one direction; thus, of course, making it form a spine, modified in shape according to the degree in which each successive turn surpasses in bulk that which preceded it. It would rather appear that this is principally owing to the ciliary motion imparted to the early stage of the embryo; the first deposit of calcareous matter forming the *axis*; the tube continues to rotate upon its axial pillar or *columella*, as it is called; and by reason of some other peculiar vital tendency, the shell is gradually deposited in a series of cells; thus enlarging its conical form, and winding obliquely from right to left.

Every turn around the axis is termed a *whorl*; and when the *columella* is hollow, it is said to be *umbilicated*. In the *spirivalve*-shelled *Gasteropoda*, we find a difference in structure between that part of the mantle which envelopes the viscera, and which is always concealed within the cavity of the shell, and the more vascular portion placed around its aperture.

The mouth of such of the *Gasteropoda* as devour vegetable matter consists of a strong muscular cavity, with a single crescent-shaped horny tooth, furnished along its upper edge with sharp points, separated by semicircular cutting spaces, admirably adapted for the division of vegetable food, and furnishing beautiful objects for the microscope—especially under polarised light. Several kinds of molluscous animals are to be found in shallow water, in brooks, and ditches. One of the most frequent of these is commonly known as the horny coil-shell, or *Planorbis corneus*. The shell of this creature at first sight looks like that of one of those little flat snails which are sometimes

found in cellars ; but, on examination, it will be found to differ from these creatures in being exactly the same on both sides ; or, in the language of a naturalist, having neither spine nor column. The animal belonging to this shell is extremely like a snail, when it is crawling with its tentacles extended ; but it is much smaller in all its parts. It is found in ditches and ponds. The amber snail (*Succinea amphibia*)



fig. 114. *The Amber Snail. Physa fontinalis. Moor Snail and Mountain Butimus.*

has a beautiful transparent shell of a light amber colour ; and it is from this that it derives its scientific name—as *Succinum* signifies amber. The puddle-mud snail (*Limnæus peregra*) is also very generally found in this country. Its shell bears considerable resemblance to that of *Succinea* ; but it is less transparent, and has a more horny look. The shells of all the species of *Limnæa* have the aperture on the right hand, and the plait on the left hand, which distinguishes them from *Succinea*. Another kind of pond-snail, called the stream-bubble shell (*Physa fontinalis*), is distinguished from *Limnæus* by its opening being on the left hand instead of the right.

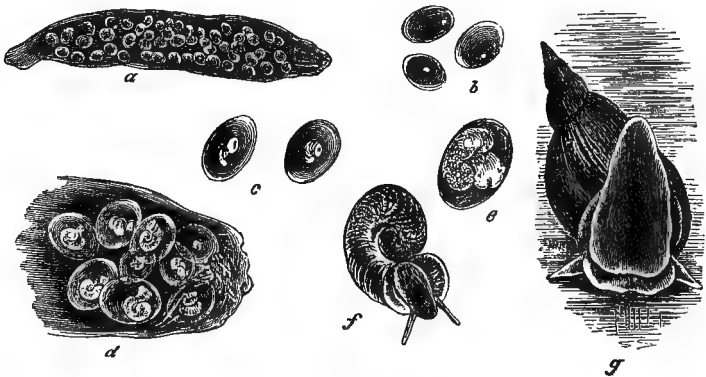

fig. 115. *Limnæa stagnalis.*

It is extremely curious to watch the development of the spawn of these animals under a magnifying-glass. The spawn of the water-snail

is usually found attached to the surface of stones, pieces of weed, or other matters, under the water; and generally connected together in long ribbons or delicate ova-sacs of a curious and beautiful form. The mass of eggs deposited by the *Doris* resembles a frill of lace of great beauty. In the *Aplysia* the spawn resembles long strings of vermicelli, of varying tints throughout the different parts of the thread. In the *Limnæus stagnalis* it is deposited in small sacs, containing from fifty to sixty ova; one of which is represented at *a*, fig. 115. If examined soon after they are deposited, the vesicles appear to be filled with a perfectly clear fluid; at the end of twenty-four hours a very minute yellow spot may be detected adhering to one side of the cell-wall. In about forty-eight hours afterwards, this small spot is seen to have a smaller central spot of a rather deeper colour; this is the nucleolus. On the fourth day the spot or nucleus may be observed to have changed its position, and enlarged to double the size: a magnified view is shown at *b*; upon viewing it closely, a transverse fissure or depression may be seen, which on the eighth day most distinctly divides the small mass into shell and soft part of the future animal, as at *c*. It then becomes detached from the side of the cell, and moves with a rotatory motion around the whole of the cell-interior; the direction of this motion is from the right to the left, and is always increased when sunlight, and consequently heat, is thrown upon it. The increase is gradual up to the sixteenth day, when the greater half appears to be the shell portion, as seen magnified at *d*. The spiral axis can now be traced and seen by oblique light from its darker colour; offering a striking difference in appearance to the soft parts. On the eighteenth day, these changes are more distinctly visible, and the ova crowd down to the mouth of the ova-sac; when, by using a higher magnifier, a minute black speck, the future eye, may be seen protruded with the tentacles, as at *e*. Upon closely observing it, a fringe of cilia will be seen in motion near the edge of the shell: it now became apparent that the rotatory motion first observed must have been in a great measure due to this; a current, no doubt, being kept up in the fluid contents of the cell by the ciliary fringes. For days after the young animal has escaped from the egg this ciliary motion is carried on, not alone by the fringe surrounding the mouth, but by cilia entirely surrounding the tentacles themselves, which brings the whole supply of nourishment required; at the same time, and by the same means, the proper aeration of the blood is effected. Whilst in the ova, it is, no doubt, by this motion that the cell-contents are converted into the various tissues of the body and shell. From the twenty-sixth to the twenty-eighth day, it appears

actively engaged near the side of the egg, using all its force to break through the cell-wall, which it at length succeeds in doing ; leaving the shell in the ova-sac, and immediately attaching itself to the side of the glass-vase, to recommence the ciliary motion ; it then appears in the advanced stage of life seen at *f*. It is still some months before it grows to the perfect form represented at *g*, where the animal is drawn with its sucker-like foot adhering closely to the side of the glass-vase. One of these animals will deposit from two to three of these ova-sacs a week ; thus producing, in the course of six weeks or two months, from 900 to 1000 young, upon which the smaller kinds of fish feed.

The shell itself is deposited in minute cells, that take up a circular position around the axis, on the under-surface of which a hyaline membrane is secreted, soon to become permeated with vessels ; at the same time the integument expands, and at various points an internal colouring-matter or pigment is deposited ; the point of one cell being in contact with those of others, thus form the ribs seen in the shell.* The increase of the membrane goes on until the expanded foot is formed, the outer edge of which is rounded off and turned over by a condensed tissue having the form of a twisted wire, enclosing a network of small vessels filled with a fluid in constant and rapid motion. The course of the blood or fluid, as it passes from the heart, may be traced through the large branches to the respiratory organs, consisting of branchial-fringes placed above the mouth ; the blood may also be seen returning through other trunks. The heart itself is a strong muscular apparatus. It is *pear-shaped*, with a pericardium or external wall-enveloping membrane, extremely thin and pellucid. Affixed to the sides of the heart are muscular bands of considerable strength, the action of which appears very like the alternate *to-and-fro* motion occasioned by drawing out bands of India-rubber, they being analogous to the muscular cords of the mammal heart. The heart beats or contracts at the rate of about sixty times a minute ; and it is placed rather far back in the body, towards the terminal portion of the shell.

The nervous system is made up of many ganglia, or nervous centres, distributed through the different portions of the body, but connected with each other by cords of communication ; the nerve-fibres proceeding to the different parts of the body from the ganglia.

The singular arrangement of the eye must not be omitted ; it appears in the early stage to be situated within the tentacle, and con-

* See further researches by the author, published in the *Microscopical Journal* 1854.

sequently capable of being withdrawn with it. In the adult animal, the eye is found to be at the base of the tentacle; and although it can be protruded at pleasure for a short distance, it seems to be dependent upon the tentacle only for an external coverlid—as it invariably draws it down over the eye whenever that organ needs protection. The eye itself is pyriform, somewhat resembling the round figure of the human eye-ball, with its optic-nerve attached. In colour it is very dark, with a single central pupillary-opening for the admission of light. The tentacle, which is rounded in the young animal, becomes flat and triangular in shape in the adult. The young animal is for some time without teeth; consequently it does not very early betake itself to a vegetable sustenance: in place of teeth it has two rows of cilia, as before stated, which drop off when the teeth are fully formed. The lingual band bearing the teeth, or, as it is termed, the “tongue” of the mollusc, consists of several rows of cutting spines, pointed with silica, which, as we have before stated, is a most interesting object seen under the microscope.

It is an interesting physiological fact, to find that if the young animal be kept in fresh water alone, without vegetable matter of any kind, it retains its cilia, and arrest of development follows; it acquires no gastric teeth, and never attains perfection in form or size. If, at the same time, it be confined within a narrow cell, or space, it grows only to such a size as will enable it to move about freely; thus adapting itself to the necessities of its restricted state of existence. Some young animals in a glass-cell were, at the end of six months, alive and well, and the cilia retained around the tentacles in constant activity; whilst other animals of the same brood and age, placed in a situation favourable to growth, attained their full size, and produced young, which grew in three weeks to the size of their elder relations.

Should any injury occur to the shell, or a portion of it become broken off, the calcareous deposit is quickly resumed, in order to replace the lost part; the cells being only half the size of those first deposited in the original formation. This may be cited in proof of what was stated by Professor Paget, in his lectures delivered at the Royal College of Surgeons, 1852,—“that, as a rule, the reparative power in each perfect species, whether it be higher or lower in the scale, is in an inverse proportion to the amount of change through which it has passed in its development from the embryonic to the perfect state. And the deduction to be made from them is, that the powers for development from the embryo are identical with those exercised for the restoration from injuries; in other words, that the

powers are the same by which perfection is first achieved, and by which, when lost, it is recovered. Indeed, it would almost seem as if the species that have the least means of escape or defence from mutilation, were those on which the most ample power of repair has been bestowed,—an admirable instance, if it be only generally true, of the beneficence that has prepared for the welfare of even the least of the living world, with as much care as if they were the sole objects of the Divine regard.”

The primordial cell-wall of each cell does not appear to enter into the formative process of the embryo—the cell-contents alone nourishing the vital blastema of the nucleus. A gradual cycle of progressive development, once set up, goes on until the animal is sufficiently matured to break through the cell-wall, and thus escape from the ova-sac. At the same time, it may be inferred, that all this is in some measure aided by the process of endosmose ; and in this way certain gases or fluids may become drawn into the interior, and thus aid in the supply of nourishment for the growth of the animal.

The cell-wall would appear to bear the same relation to the future perfect animal, that the egg-shell of the chick does to it ; it is, in fact, but an external covering to a certain amount of gaseous and fluid matter, thus placing the germ of life in a more favourable state for development, assisted, as it is known to be, by an increase of temperature, usually the resultant of a chemical action, set up or once begun in an *organism* and a *medium*.

The ovum destined to become a new creature originates from a cell, enclosing gemmules, from which its tissues are formed, and nutriment is assimilated, and which eventually enables the animal to successively renew its organs, through a series of metamorphoses that give it permanent conditions, not only different, but even directly contrary to those which it had primitively.

“ Oh, there are curious things of which men know
 As yet but little ! secrets lying hid
 Within all natural objects. Be they shells,
 Which ocean flingeth forth from off her billows
 On the low sand, or flowers, or trees, or grasses,
 Covering the earth ; rich metals or bright ores,
 Beneath the surface. He who findeth out
 Those secret things hath a fair right to gladness ;
 For he hath well performed, and doth awake
 Another note of praise on Nature's harp
 To hymn her great Creator.”

The Structure of Shells.—We may exhibit the structure of shells by

using an acid solvent in the following manner. If a sufficient quantity of hydrochloric acid, considerably diluted with water (say one part acid to twenty-four of water), be poured upon a shell contained in a glass vessel, it will soon exhibit a soft floating substance, consisting of innumerable membranes, which retain the figure of the shell, and afford a beautiful and popular object for the microscope. In analysing shells of a finer texture than such as are generally submitted to the test of experiment, the greatest circumspection is necessary. So much so, that M. Herissant, whose attention was particularly devoted to the subject, after placing a porcelain shell in spirits of wine, added, from day to day, for the space of two months, a single drop of spirits of nitre, lest the air, generated or let loose, by the action of the hydrochloric acid on the earthy substance, should tear the net-work of the fine membranaceous structure. This gradual operation was attended with complete success, and a delicate and beautifully reticulated film, resembling a spider's web in texture, rewarded the patience of the operator; the organisation of which film, from its extreme fineness, he was not, however, able to delineate. In shells of peculiar delicacy, even five or six months are sometimes necessary for their complete development; but in others of a coarser texture, the process is soon completed.

ON COLLECTING SALT-WATER SPECIMENS.

“Nothing,” as Dr. Harvey says, “can exceed the beauty of a clear rock-pool, seen under strong sunlight, and through a calm surface, tenanted by its various animated tribes all fulfilling the duties allotted to their several kinds. Careful examination with a lens will generally detect a multitude of minute shells, some of very strange shapes, and others possessing structures of great elegance. These are the various species of Foraminifera. We should recommend these species to be studied in a living condition, whenever opportunity presents, as it will prove a study of great interest. The drift-sand will often be found to contain a wonderful variety of minute spiral univalve shells, though these are scarcely of so small a size as to come within the list of microscopic objects. Others may be obtained by the gatherers of sea-weeds, with little trouble, if they will only preserve the sediment that collects in the water in which the sea-weeds are washed. When the sea-weeds are plunged into fresh water, these minute molluscs (*Rissoæ*) are quickly killed, and fall to the bottom, and may then be secured by simply straining the water through a piece of canvas. Many other

minute and curious animals, and sometimes *Diatomaceæ*, may be collected in a similar way.

Having thus surveyed the rocks, sands, and weeds of the shore above low-water mark, if we launch upon the deep itself a similar abundance of minute and interesting forms is still presented to us. A small muslin bag, the mouth of which is kept open by a wire ring about four inches in diameter, towed slowly behind a boat, on a calm and bright day, in any sheltered bay or inlet, will be found to have gathered multitudes of creatures of the most beautiful forms, and occasionally of the most brilliant colours,—creatures whose crystalline substance affords to our wondering gaze a ready insight into many things connected with the structure of the lower animals, which will in vain be sought elsewhere. In this way are collected the numerous species of minute *Naked-eye Medusæ*.

Nothing can be conceived more elegant and graceful than the motions of these minute crystalline bodies in a glass of water. On almost every part of the coast, besides the beautiful *Tunis neglecta* and the allied *Beroes*, the towing-net will gather innumerable specimens of a creature resembling a slender spicula of glass, about an inch in length, but which is so slender and transparent as to be almost invisible except in a particular direction of the light: this is the *Sagitta bipunctata*; and its simple structure affords an excellent subject for microscopic research. When fishing for objects of this kind, it is best to have in the boat a large *white* basin half filled with sea water; and into this the towing-net is to be inverted and gently shaken every now and then. In this way the delicate creatures it contains will come out of it without injury; and though themselves perhaps at first wholly invisible, their shadows will be seen with great distinctness at the bottom of the basin; and thus many forms which might otherwise escape observation be rendered evident.

The microscopic wonders of the sea, however, are still far from being exhausted; it presents as many, if not more, curiosities at the bottom, where its depths are never opened to view, than at the surface. The best and most convenient mode of obtaining these, is by the use of an instrument, with which all perhaps are acquainted in one shape or another,—we mean the *dredge*.

The essential qualities of a microscopist's dredge are, a small and convenient size, with sufficient weight to ensure its sinking to and keeping at, the bottom, even when at a considerable depth and drawn with some velocity through the water. The dredge we should recommend is made of cast iron, which reduces the cost considerably; and it

is, in practice, found to be sufficiently strong. It is about 18 inches in length, and the opening is about 4 inches wide, the two sides diverging outwards at a slight angle, and coming to a sharp edge.

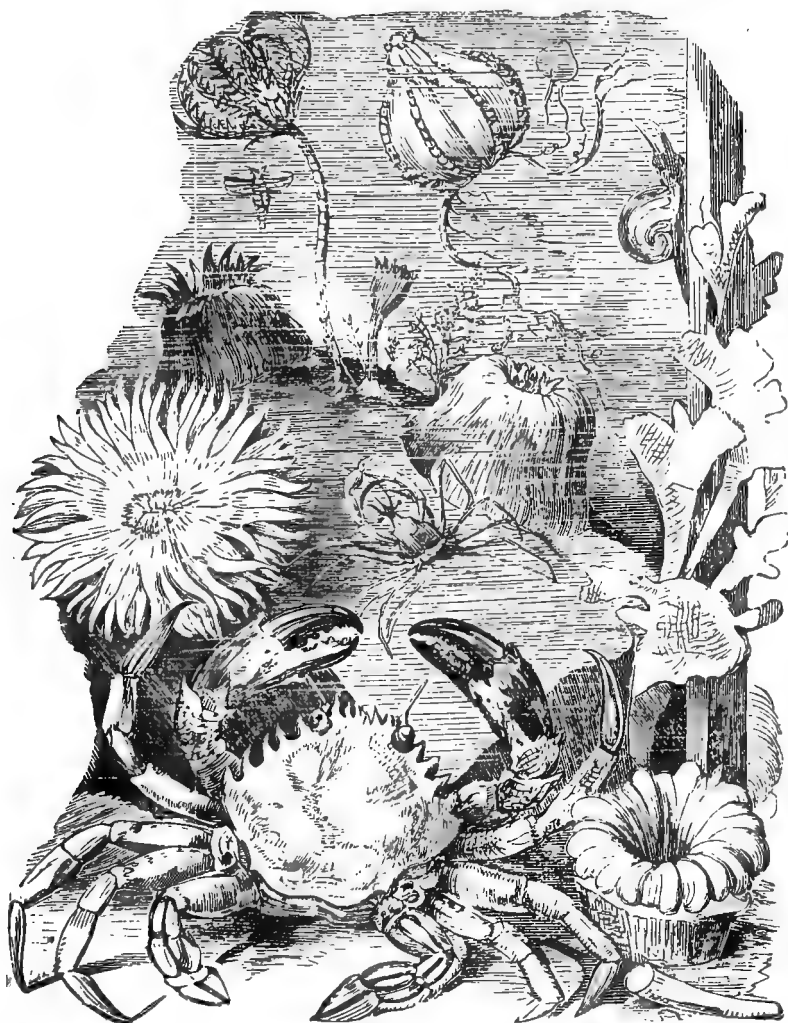
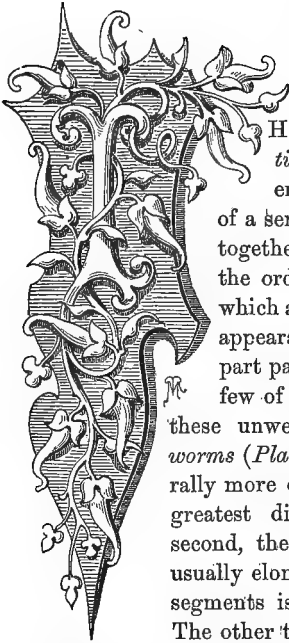

fig. 116.

Young of *Comatula*, usually described as *Pentacrinus Europæus*. *Beroë*. *Actinæ*, closed and expanded specimens. *Caryophyllæ Smithii*. Spider crab, Velvet crab, and *Flustra*.

CHAPTER IV.

ARTICULATA.



THE animals composing the sub-kingdom *Articulata* are characterised by having the body enclosed in a tunic, or integument, consisting of a series of rings, segments, or joints, "articulated" together by a flexible membrane. The lowest of the order, *Vermes*, may be divided into four classes which are generally distinguishable by their external appearance. Of these, the first two are for the most part parasitic, living in the interior of other animals, few of which are, in fact, exempt from the visits of these unwelcome guests. Of these, the first, the *Flat-worms* (*Platyelmia*) have the body flattened, and generally more or less ovate and leaf-like; these present the greatest divergence from the articulate type. In the second, the *Nematelmia*, or *Round-worms*, the body is usually elongated and cylindrical, and the division into segments is often indicated by annulations of the skin.

The other two classes are composed principally of aquatic animals. One of these, the *Rotifera*, or *Wheel Animalcules*, we have already seen, includes a number of minute creatures. The *Annelida*, or *true worms*, have the body distinctly divided into segments, generally furnished with lateral appendages, with a well-developed nervous system. The blood, in this last class, is also generally of a red colour.

We shall first notice the *Entozoa*, or internal parasites; few animals can present a better claim to our notice, from the circumstance that many of them find their natural residence in our own bodies, and in those of our domestic animals, where they often do us a great amount of injury. They have a still stronger claim to the attention of the scientific zoologist, from the number of points connected with their

natural history, which still remain to be cleared up, and from the wonderful nature of those portions of the history of their development which have been revealed by the recent researches of some of our most eminent naturalists.

The two parasitic orders are the *Cestoidea*, or *Tape-worms*, with long jointed bodies ; and the *Frematoda*, with short elliptical or discoid forms.

Two species of Cestoid worms inhabit the human intestines,—the *Tænia solium* and the *Bothriocephalus latus*. The former is the ordinary *Tape-worm*, the second occurs only in particular countries,—in Holland, Poland, and Switzerland. In the Cystic form some of these worms do great injury to domestic animals ; one of the most noxious is the so-called *Cœnurus cerebralis*, inhabiting the brains of sheep. Many interesting facts are connected with the history of these animals ; but our space forbids us from entering into further details.

In the *Distomidæ*, the animals possess two suckers, of which the anterior contains the mouth. Of these the Fluke (*Distoma hepaticum*), which infest the livers of sheep, is a well-known example. Other species live in the intestines, and even the eyes, of other animals.

The *Tristomidæ* are furnished with three suckers ; two small ones at the anterior extremity, between which the mouth is situated, and a larger one at the hinder extremity. These worms principally infest the gills of fishes, as do also *Polystomidæ*, characterised by the presence of several suckers at the hinder extremity of the body, whilst the anterior extremity is either entirely destitute of those organs, or only possesses a small one, in which the mouth is situated. This family includes the singular *Diplozoon paradoxum*,—an animal which appears to be compounded, like the Siamese twins, of two perfect individuals, each containing precisely the same organs.

The *Gordicea*, or *Hair-worms*, are at once distinguishable by the extraordinary length of their bodies, which frequently present a close resemblance to a horse-hair ; so close, indeed, that in former times the popular belief ascribed their origin to the introduction of horse-hairs into the water in which they are found. One of the most singular circumstances connected with their history is, that if by any chance, on breaking out of their insect-home, they find that dry weather has produced a state of things incompatible with their notions of comfort, they quietly allow themselves to be dried up, when they become perfectly hard and brittle ; but, strange to say, the moment a shower of rain comes to refresh the earth with its moisture, the dormant *Gordii* immediately recover their activity, and start off in search of their prey.

With the exception of one family, all the worms included in the order *Nematoidea* are parasitic in the bodies, and principally in the intestines of other animals; they are, in fact, amongst the most common and the most injurious of *Entozoa*.

This order includes the common *Ascaris*, or *Round-worm* of the human subject, as well as the little *Thread-worms* (*Oxyuris*) which are often so troublesome to children; the *Strongylus gigas*, a worm sometimes attaining a length of two or three feet, and the thickness of a garden worm, which usually inhabits the kidneys of swine, but sometimes finds its way into the same organ in man. This tremendous worm, by destroying the organ in which it has taken up its abode, frequently causes the death of its host.

In this order we also place the *Anguillulidæ*, the so-called *Eels* of paste and vinegar. These are minute thread-like worms, exhibiting distinct digestive and generative organs, which occur often in great numbers in putrefying substances.

This order also includes the dreaded *Guinea-worm* (*Filaria medinensis*, fig. 117), which appears to occur in most parts of tropical Africa. This worm lives in the cellular tissue beneath the skin of man, confining its attacks principally, though not exclusively, to the lower extremities, where it often produces considerable pain. It is said occasionally to attain a length of twenty or thirty feet; but its average length is five or six. It is extracted by winding it very slowly upon some object, an operation in which great care is said to be necessary, as if the worm be broken, its fluids produce a very painful effect.

In man, and some of the lower animals also, the muscles are frequently attacked by *Cysticercus cellulosæ*; a well-known disease in the pig is caused by them, it is then called by pork-dealers "measly pork." Recent researches have shown this *Entozoa* is but the *larva* of *Tænia*.

The *Echinococcus*, another *Entozoa*, is found in cysts, both in the body of man and sheep.

Fig. 118 represents a bunch taken from the liver of a boy who died in Charing-cross Hospital from rupture of the liver, occasioned by the wheel of an omnibus passing over him. The simple cysts containing these animals are always situated in cavities in the interior. These cavities may be situated in any part of the tissues or organs of the body; they are more frequently found in the solid viscera, and especially in diseased livers.

Mr. Busk, who has examined several of these cysts, says: "When a large hydatid cyst,—for instance, in the liver of the sheep,—very shortly after the death of the animal, is carefully opened by a very

PLATE VII.

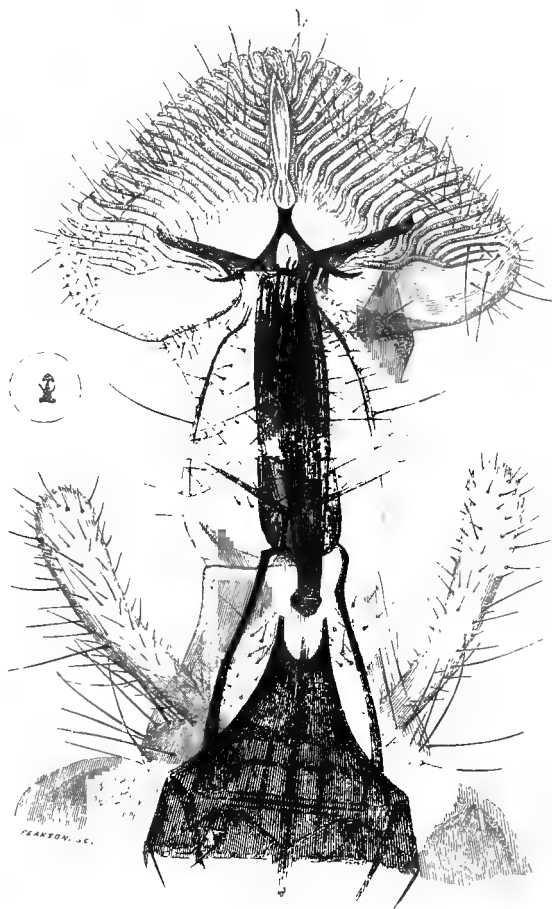

PROBOSCIS OF HOUSE-FLY.

DRAWN FROM A PREPARATION BY TOPPING.

(THE SMALL CIRCLE ENCLOSES THE PROBOSCIS OF THE NATURAL SIZE.)

forms and appearances are to be met with,—differences owing to decomposition or to mechanical injury ; and in many cases no trace of them can be found except the hooklets or spines, which, like the fossil remains of animals in geology, remain as certain indications of their source, and not unfrequently afford the only proof we can obtain of the true nature of the hydatid.

In almost all the aggregations of *Echinococci*, besides the perfect specimens, there are to be seen one or more of a different appearance and of various shapes—round, clavate, or oval—like the others, attached to the common mass by a pedicle : they are composed of granular mat-

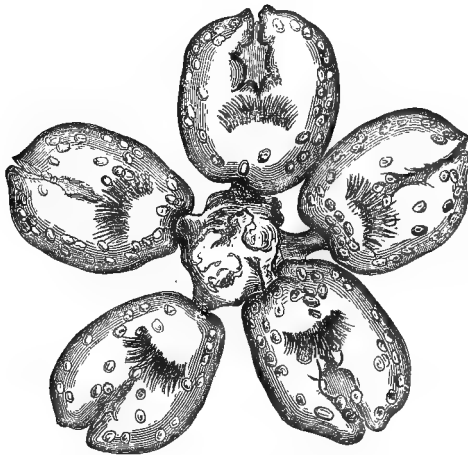

fig. 118. *Echinococci* found in the human liver, magnified 250 diameters.

ter, denser apparently, and of a deeper colour, than that of which the bodies of the perfect animals are composed, and increasing in density towards the free extremity.”

ANNELIDA.

The *Annelida*, in general, present a more complicated organisation than any of the preceding animals ; the division of the body into segments is usually distinctly recognisable, and the segments are almost universally furnished with external appendages, which are sometimes jointed. The majority live in water, or in damp situations ; a very few only are parasitic in their habits.

The head in most of these animals is distinctly marked, and furnished with organs of sense, such as eyes, tentacles, and in some instances auditory vesicles, containing otolithes. The nervous system, in the higher forms, exhibits the articulate type of structure very distinctly ; it usually consists of a series of ganglia running along the ventral portion of the animal, and united by a pair of slender filaments, by which they also communicate with the central mass, or brain, which is enclosed in the head. They are divided into two groups, characterised by the presence or absence of external respiratory organs. The abranchiate *Annelides* include the *Suctorio* or *Leeches*, and the *Scolecina* or *Earthworms*. The branchiferous group are again subdivided into two orders : the *Tubicola*, animals having a tube for their habitation, and the *Errantia*, those having no such protection. Of the animals belonging to the order *Suctorio*, the medicinal leech is a familiar example. Their motions are effected by undulations of the body whilst swimming, or by the alternate attachment of the sucking disks with which the two extremities of their bodies are furnished.

The medicinal leech puts forward strong claims to our attention, on the ground of the services which it renders to mankind. The whole of this family live by sucking the blood of other animals ; and, for this purpose, the mouth of the leech is furnished with an apparatus of horny teeth, by which they bite through the skin. In the common leech, three of these teeth exist, arranged in a triangular, or rather triradiate form, a structure which accounts for the peculiar appearance of leech-bites in the human skin. The most interesting part of the anatomy of the leech to microscopists is the structure of the mouth (fig. 119).

"This piece of mechanism," says Professor Rymer Jones, "is a dilatable orifice, which would seem at first sight to be but a simple hole. It is not so; for we find that just within the margin of this hole three beautiful little semicircular saws are situated, arranged so that their edges meet in the centre. It is by means of these saws that the leech makes the incisions whence blood is to be procured, an operation which is performed in the following manner: No sooner is the sucker firmly fixed to the skin, than the mouth becomes slightly everted, and the edges of the saws are thus made to press upon the tense skin ; a

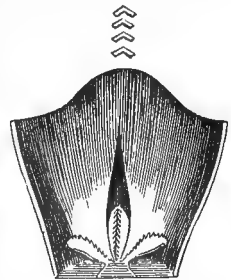

fig. 119.

Mouth of Leech.

sawing movement being at the same time given to each, whereby it is made gradually to pierce the surface, and cut its way to the small

blood-vessels beneath. Nothing could be more admirably adapted to secure the end in view than the shape of the wound thus inflicted, the lips of which must necessarily be drawn asunder by the very contractibility of the skin itself; and that the enormous sacculated stomach, which fills nearly the whole body of the leech, was designed to contain its greedily devoured meal, there can be no reasonable question. The leech, in its native element, could hardly hope for a supply of hot blood as food; and, on the other hand, its habits are most abstemious, and it may be kept alive and healthy for years, with no other apparent nourishment than what is derived from pure water frequently changed; even when at large, minute aquatic insects and their larvæ form its usual diet."

In the *Clepsinidæ*, the body is of a leech-like form, but very much narrowed in front, and the mouth is furnished with a protrusible proboscis. These animals live in fresh water, where they may often be seen creeping upon aquatic plants. They prey upon the water-snails (*Limnææ*).

Some species of this family, forming the genus *Piscicola*, live as parasites upon various fresh-water fishes; whilst those of the genus *Branchiobdella*, which are quite destitute of eyes, inhabit the branchiæ of some *Crustacea*. The *Scolecina*, of this order, the well-known earth-worm so common in our gardens, is an example. *Naiads* are inhabitants of water.

The *Tubicola*.—The worms belonging to this series of branchiferous *Annelida* are all marine, and are distinguished by their invariable habit of forming a tube or case, within which the soft parts of the animal can be entirely retracted. This tube is usually attached to stones or other submarine bodies. It is often composed of various foreign materials, such as sand, small stones, and the *débris* of shells, lined internally with a smooth coating of hardened mucus; in others it is of a leathery or horny consistency; and in some it is composed, like the shells of the *Mollusca*, of calcareous matter secreted by the animal. These animals frequently live together in societies, winding their tubes into a mass which often attains a considerable size; others are more solitary in their habits. They retain their position in their habitations by means of appendages very similar to those of the free worms, and furnished like these with tufts of bristles and spines; the latter, in the tubicular Annelides, are usually hooked; so that, by applying them to the walls of its domicile, the animal is enabled to oppose a considerable resistance to any effort to draw it out of its case.

In the best known family of the order (*Sabellidæ*), the branchiæ

are placed on the head, where they form a circle of plumes or a tuft of branched organs. The *Serpulæ*, which form irregularly twisted calcareous tubes, often grow together in large masses, generally attached to shells and similar objects; whilst those genera which, like *Terebella*, build their residences of sand and stones, appear to prefer a life of solitude. The curious little spiral shells often seen upon the fronds of sea-weeds, are formed by an animal belonging to this family (*Spirorbis*).

If, while the contained animals are alive, these be placed in a vessel of sea-water, a very pleasing spectacle may soon be witnessed.

The mouth of the tube is first seen to open, by the raising of an exquisitely constructed door, and then the creature cautiously protrudes the anterior part of its body, spreading out at the same time two beautiful fan-like expansions of a rich purple or scarlet colour, which float elegantly in the surrounding water, and serve as branchial or breathing organs. The *Serpula*, which fabricates these tubes, when withdrawn from its residence (fig. 120), is seen to have the lower part of its body composed of a series of flattened rings, entirely destitute of limbs or any other appendages. Its food is brought to its mouth by the currents created by the cilia on the branchial tufts. Many very beautiful specimens of this family may be seen alive in the tanks of the Zoological Society.

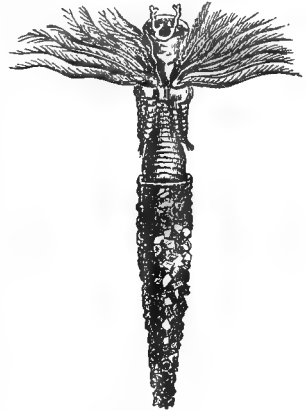

fig. 120.

The Serpula in its calcareous tube.

Of the *Errantia*, the highest of the order, we are unable to notice more than one; that of the family of *Aphroditæ*, some species of which are known as *Sea-mice*. In these worms the body is generally broad, or ovate; the head small, and furnished with very short tentacles; the feet large, with immense tufts of bristles and spines, often of the most remarkable forms, and exhibiting the most brilliant metallic colours. Each of these hairs is retractile within a horny sheath, which serves to protect the soft parts of the animal from injury by its own weapons. Their most remarkable peculiarity is, that the dorsal surface is entirely or partially covered by a double series of large membranous scales attached to the alternate segments, between which the beautiful bristles of the feet make their appearance. These animals generally inhabit deepish water; but numbers of them are often thrown upon our coasts after a storm.

We may here remark, that Dr. Carpenter divides the articulate sub-kingdom into eight classes, viz. *Entozoa*, *Rotifera*, *Annelida*, *Myriapoda*, *Insecta*, *Crustacea*, *Cirrhypoda*, and *Arachnida*. The immense number and variety of this portion of the animal kingdom necessitates a corresponding multiplicity of subordinate divisions, which it would be quite impossible for us to attempt a detailed description of. Our space will only permit of a few remarks upon the *Arthropoda*, or *True Articulata*; the first of which is the *Crustacea*.

The skeletons of *Crustacea** are external to the soft parts; in a great number of species it is thin and membranous, in others it is of a horny material, thickened with calcareous matter, having a distinct series of pigment cells of a stellate figure, all supplying beautiful objects for microscopic examination.

A crustaceous animal consists of three parts: the head, the body, and the carapace, which is covered with one entire shell, and is popularly called the tail, consisting of seven rings, or joints. There are properly fourteen rings in that part of the body which is called the carapace; but they are only used when the animal changes its shell. The joints in the tail are to enable the animal to spring forward, which it does frequently when it wishes to change its position. It can also crawl; but it moves in this manner awkwardly, and in an oblique direction. The river crawfish belongs to the same genus (*Astacus*) as the lobster, and both have long tails, which are spread out when they crawl, and numerous legs and claws, with which they can pinch severely when they wish to defend themselves. The crab has a short tail, and belongs to the genus *Cancer*. The shrimp, though it has no claws, properly so called, has two feet larger than the others, each of which has a hooked jointed nail. The prawn, which is quite different from the shrimp, is nearly allied to the crawfish, or thorny lobster. All the *Crustacea* have the power of renewing their claws if they are torn off at a joint, and they change their shells every year.

Dr. Carpenter describes the shell of the crab and lobster as being composed of three layers, viz. the epidermis or cuticle, the rete-mucosum or pigment, and the corium. The epidermis is of a horny nature, being generally more or less brown in colour, and under the highest magnifying powers presenting no trace of structure (Plate VI. No. 7); it invests all the outer parts of the shell, and has in many instances large cylindrical or feather-like hairs developed from certain portions of its surface. The rete-mucosum, or pigment-cells, consist of either a series of hexagonal cells, forming a distinct stratum, or of pigmental

* *Crustacea* (from *crusta*, a shell).

matter diffused throughout a certain thickness of the calcareous layer. (Plate VI. No. 5.) In the crab and lobster it is very thin, but in the crayfish it occupies in some parts more than one-third of the entire thickness of the shell; when examined by the microscope; this portion appears to be composed of a large number of very thin laminae, which are indicated by fine lines taking the same direction on the surface of the shell, the number of lines being the greatest in the oldest specimens; these layers, even in the crayfish, are covered by a thin stratum of very minute hexagonal cells, without any trace of cell matter in their interior. The corium is the thickest layer of the three, being the one on which the strength of the shell depends, in consequence of the calcareous material deposited in it. (Plate VI. No. 4.) When a vertical section of the shell of the crab is examined, it is found to be traversed by parallel tubes, like those in the *dentine* of the human tooth; these tubes extend from the inner to the outer surface of the shell, and are occasionally covered by wavy lines, probably those of growth, shown in a portion of No. 3, Plate VI. If a horizontal section of the same shell be made, so that the tubes be divided at right angles to their length, the surface will clearly exhibit their open mouths, surrounded by calcareous matter. In shrimps and very small crabs, the deposition of the calcareous matter takes place in concentric rings, like those of agate; and occasionally small centres of ossification somewhat similar to No. 3, with radiating striæ, are to be met with in the former animal. If the calcareous portion of the shell be steeped in hydrochloric acid, a distinct animal structure or basis is left behind, and the characters of the part will be very accurately preserved. The calcareous matter, like that of bone, generally presents a more or less granular appearance as at No. 4, and so angular in figure as to resemble certain forms of rhomboidal crystals, as shown at No. 8, from the outer brown shell of the oyster. The beauty of all these structures is much increased when viewed by polarised light on the selenite stage.

The sub-class *Cirrhypoda* includes only a single order. They are all marine animals, which, when mature, attach themselves to rocks or other submarine objects; the common Barnacle (fig. 121), perhaps the best known example of the order, generally selecting floating objects for this purpose, and frequently covering the bottoms of ships to such an extent as even to impede their progress through the water. The bodies of these animals are soft, and enclosed in a case composed of several calcareous plates; they formed part of the group of *multivalve shells* of the older conchologists. The limbs are converted into a tuft of jointed cirri, which can be protruded through an opening in the

sort of mantle which lines the interior of the shell. The cirri are twelve in number, and beset with bristles. When the animal is alive they may be seen in continual motion, exerted and retracted every moment in search of prey. The intestinal canal is complete, furnished with a mouth and an anal opening; and the nervous system exhibits the usual series of ganglia, which we have seen to be characteristic of the articulate type. The head is marked only by the position of the mouth, which is armed with a pair of jaws; but all traces of any of the organs that we are accustomed to see at this part of the body have completely disappeared.

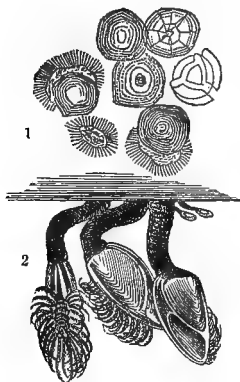

fig. 121.

1. Young fry of the Oyster, a portion of them nearly ready to escape from the shell.
2. Body and shell of Barnacle.

The shell forms a short tube, usually composed of six segments firmly united together. The lower part of this tube is firmly fixed to the object on which the *Balanus* has taken up its abode; whilst the superior orifice is closed by a movable roof, composed of from two to four valves, between which the little tenant of this curious domicile can protrude his delicate cirri in search of nourishment. In their young state the *Balanidæ* resemble the following group, the *Entomostraca*.

These animals occur in countless swarms in all waters, whether salt or fresh; and, minute as they are, one species is said to constitute the principal food of the whale.

The best known form is the genus *Cyclops* (fig. 122), specimens of which may be found in every stagnant pool; it is the type of the family *Cyclopidae*, characterised by the possession of a single eye. In the *Cetochilidæ* there are two of these organs.

The animals comprising the order *Ostracoda* are generally of very minute size; the body, which strongly resembles that of the *Copepoda*, is always enclosed in a little bivalve shell, the feet and antennæ being protruded between the lower edges of the valves. These little shells so closely resemble those of minute bivalve *Mollusca*, that those of some of the larger species have actually been described by conchologists as the coverings of animals belonging to that class. The antennæ

are often curiously branched ; and the hinder extremity is usually produced into a sort of tail, which is seen in constant action when the animal is in motion.

This order divides into two families—the *Cypridæ*, in which the body is entirely enclosed by the shell, of which the genus *Cypris* (fig. 122) is an example ; and the *Daphniadæ*, in which the head is protruded beyond the shell. In the *Polyphemus*, belonging to this group, the head, which is large, is almost entirely occupied by an enormous eye, giving the creature a most singular appearance.

The *Monoculus* is a well-known example of this group. Another family, not provided with a shell or carapace, are called *Branchipodidæ*, from the name of the typical genus, *Branchipus stagnalis* (fig. 122), an animal which is often found after heavy rains in cart-ruts and other small pools. Another species, the *Artemia salina*, inhabits a still more curious situation, namely, the salt-pans at Lymington, where it is usually found in those pans in which the evaporation of the water has proceeded to a considerable extent.

A few years since only a small number of the *Entomostraca* were described. Dr. Baird, of the British Museum, has lately published a valuable volume upon the British species alone.

The *Gammaridæ* are characterised by the large size of the foot-jaws, which cover the whole mouth. The common *Talitrus locusta*, or sand-hopper, which may be met with in thousands upon the sands of our shores, is a well-known example of this family. Although its length is not much more than half an inch, it can leap several inches into the air, and the facility with which it escapes pursuit by burrowing into the soft wet sand is truly wonderful. Another species, *Gammarus pulex*, is found commonly in fresh water, and is scarcely inferior to its marine relative in agility.

The *Coryphium longicorne*, remarkable for its long antennæ, is not less so for its singular habits. It is found at Rochelle, where it burrows in the sand, and wages constant war with all other marine creatures of moderate size that come in its way. To discover their prey they beat about in the mud with their large antennæ.

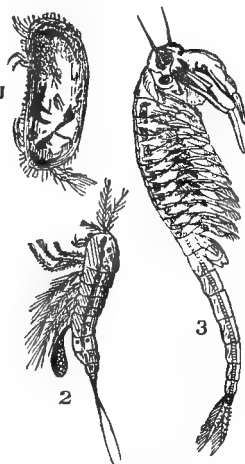

fig. 122.

1. *Cypris*. 2. *Cyclops*.
3. *Branchipus stagnalis*.

In the family *Maiada*, or sea-spiders, the carapace is more or less narrowed in front, forming a projecting beak or rostrum ; the legs are long and hairy ; the back covered with spines and hairs, much resembling some spiders, whence the name of spider-crabs or sea-spiders, by which these animals are known.

Arachnidæ.—The animals forming the class *Arachnida*, which includes the spiders and their allies, are amongst those which are viewed with disgust and aversion by the generality of mankind. Confounded, in the popular mind, with the reptiles, they of course come in for their share of the bad reputation of those creatures, and some of them, no doubt, not without reason ; but on a closer examination we find that, however unattractive they may be in appearance, they present much that is interesting both in their structure and habits.

They are distinguished from the other *Arthropoda* by their aerial respiration, their possession of four pairs of legs attached to the anterior division of the body, and the total absence of antennæ. The body is usually covered with a softish skin, which, however, sometimes attains a horny consistency. In the lower forms, the division of the body into separate regions is quite unrecognisable, and the whole forms a roundish or oval mass, which does not even present traces of segmentation. In the higher groups the body is composed of two principal divisions, of which the anterior, as in the *Crustacea*, consists of the thoracic segments, amalgamated with those of the head, and forming together a mass called the cephalothorax. In the highest forms the division of the thorax into separate segments becomes apparent ; but the anterior segment is still amalgamated with the head. The structure of the abdomen varies greatly. In some cases it forms a soft round mass, without any traces of segmentation ; whilst in others, as the scorpions, it is produced into a long flexible jointed tail.

The *Arachnida* are divided into two orders : *Trachearia* and *Pulmonaria*. The first includes the *Acaridæ* or Mites, in which there are tracheæ, as in insects, but no distinct vascular apparatus : in the second, which includes spiders and scorpions, there are pulmonary cavities, and a well-developed circulating system.

Of spiders, the diadem (*Epeira diadema*) is one of the largest of the British species ; it is a garden spider, and is easily recognised by the beautiful little gem-like marks on its body and legs. Spiders abound on every shrub ; and when we consider that the spider is destitute of a distinct head, without horns, one-half of its body attached to the other by a very slender connection, and so soft as not to bear the least pressure,—its limbs so slightly attached to its body that they fall off at a

PLATE VIII.

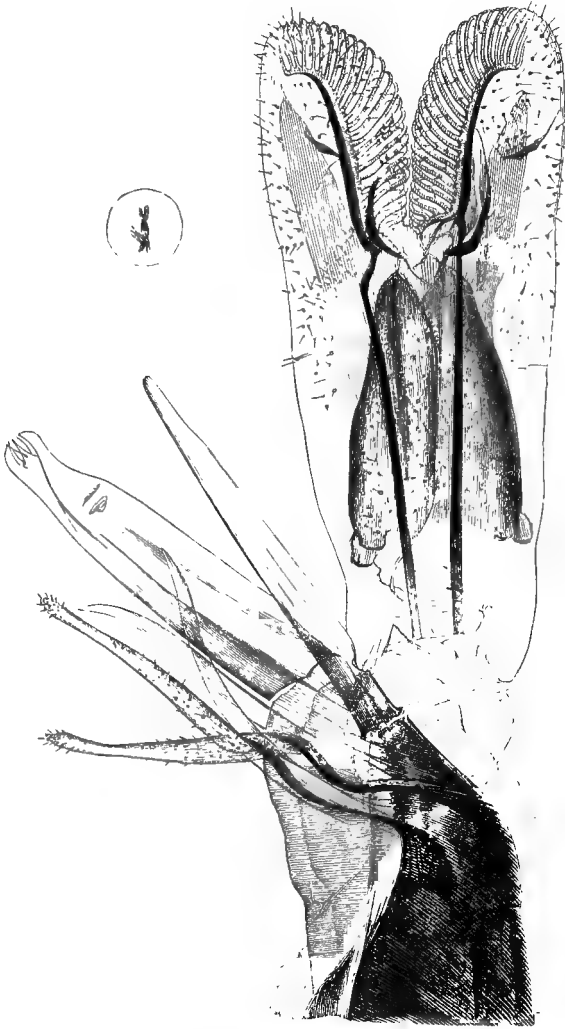

TONGUE AND PIERCING-APPARATUS OF THE DRONE-FLY.

(THE SMALL CIRCLE ENCLOSES THE TONGUE, ETC. OF THE NATURAL SIZE.)

very slight touch,—it appears ill adapted either to escape from danger which threatens it on all sides, or to supply itself with food : the economy of such an animal deserves our notice.

The several small appendages, represented in fig. 124, it is important not to confound with each other. Of these the two longest, No.

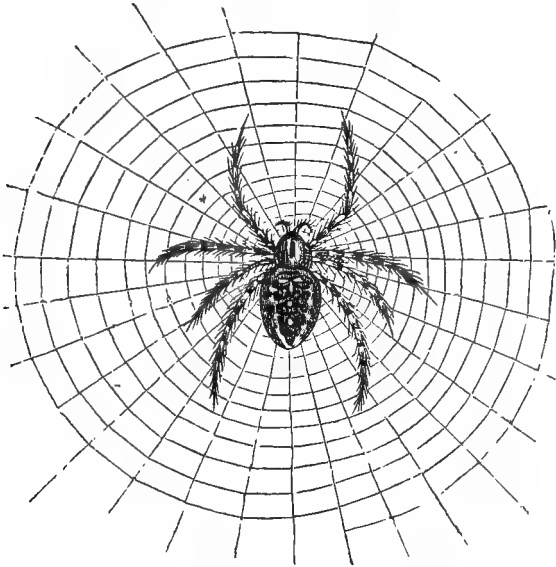

Fig. 123. *Epeira diadema*, or Garden Spider.

1, having articulated processes, seem to be *feelers* ; the others, being the organs by which their silky threads are emitted, are four in number. Their structure is very remarkable ; the surface of each of the spinnarets is pierced by an infinite number of minute holes, as seen in No. 2, from each of which there escape as many little drops of a liquid, which, drying the moment they come in contact with the air, form so many delicate threads. Immediately after the filaments have passed out of the pores, they unite first together, and then with those of the next, to form one common thread ; so that the thread of the spider is composed of a large number of minute filaments, perhaps many thousands, of such extreme tenuity, that the eye cannot detect them until they are twisted together into the working thread. In the two pairs of spinnarets a different anatomical structure is to be detected ; the pair above, which are a little longer than the lower, show a multitude of

small perforations, the edges of which do not project, and which therefore resemble a sieve. The other shorter pair have projecting tubes independent of the perforations which also exist (No. 3). The tubes are hollow, and perforated at their extremities; and it is supposed that the agglutinating threads issue from these tubes, while those emitted from the perforations do not possess that property. It may be observed, by throwing a little dust on a circular spider's web, that it adheres to the threads which are spirally disposed, but not to those that radiate from the centre to the circumference; the latter are also stronger than the others. The rapidity with which these webs are constructed is astonishing, as is also the accuracy with which the webs are formed. There are many different kinds of spiders; but nearly all of them envelop their eggs in a covering of silk, forming a round ball, which the spider takes care to hang up in some sheltered place till the spring. The mode in which the ball is formed is very curious: the mother spider uses her own body as a gauge to measure her work, in the same way as a bird uses its body to gauge the size and form of its nest. The spider first spreads a thin coating of silk as a foundation, taking care to have this circular by turning round its body during the

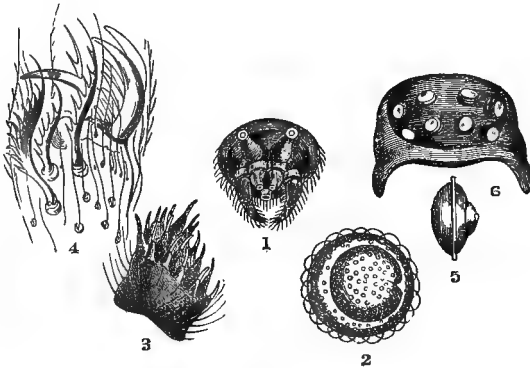

fig. 124.

1. Spinnarets of the spider. 2. Extreme end of one of the upper pair of spinnarets. 3. End of under pair of spinnarets. 4. Foot of the spider, 5. Side view of eye of spider. 6. The arrangement of the eight eyes.

process. It then, in the same manner, spins a raised border round this till it takes the form of a cup, and at this stage of the work it begins to lay its eggs in the cup, not only filling it with these up to the brim, but piling them up above it into a rounded heap, as high as the cup is

deep. Here, then, is a cup full of eggs, the under half covered and protected by the silken sides of the cup, but the upper still bare and exposed to the air and the cold. It is now the spider's task to cover these, and the process is similar to the preceding, that is, she weaves a thick web of silk all round them, and, instead of a cup-shaped nest like some birds, the whole eggs are enclosed in a ball much larger than the body of the spider that constructed it.

The feet of the spider, one of which is represented at No. 4, are curiously constructed. Each foot, when magnified, is seen to be armed with strong, horny claws, furnished with bent teeth on the under-surface, which gradually diminish towards the extremity of the claw. By this apparatus the spider is enabled to regulate the issue of its rope from the spinnarets, and also to suspend itself with the greatest ease by the larger central claw. Some have, in addition, a remarkable comb-like claw, for the purpose of separating certain fibrous bands that enter into the composition of their delicate webs.

One of the most remarkable members of this family is the *Argyroneta aquatica*, or *Diving Spider*, which weaves itself a curious little bell-shaped dwelling at the bottom of the water, whither it retires to devour its prey. As, notwithstanding its aquatic habits, this animal, like the rest of its order, is fitted only for aerial respiration, it takes care to fill its miniature dome with air, which it carries down with it from the surface amongst the hairs with which its body is thickly clothed; a process very closely resembling that by which the earliest diving-bells were supplied with air.

The *Lycosidæ* agree in the structure of their jaws and palpi, and in the number of their spinnarets, with the *Araneidæ*; but the eyes are arranged in three rows. Unlike the *Araneidæ*, the animals of this family never construct regular webs for the capture of prey; their utmost exertion of instinct in this direction consisting in laying a few threads in the neighbourhood of their dwelling-places. They generally live under stones, in holes in the earth, or in old walls, sometimes lining their habitations with a silken tapestry; and some, which live upon trees, weave themselves a silken nest amongst the leaves or on the branches. A common example is the *Salticus scenicus*, a small species banded with black and white, which may frequently be met with on garden-walls.

steps by which that despised and almost unnoticed larvâ, that but a few days before was grovelling in the earth, with its internal organisation fitted only for the reception of, and assimilation of, the grossest vegetable matter, has had the whole of its internal form so completely changed, as now to have become an object of admiration and delight, and able to 'spurn the dull earth,' and wing its way into the open atmosphere, with its internal parts adapted only for the reception of the purest and most concentrated aliment, now rendered absolutely necessary for the support and renovation of its redoubled energies.

Our space will not admit of an examination of every part of the insect; we therefore content ourselves with noticing only such as pre-

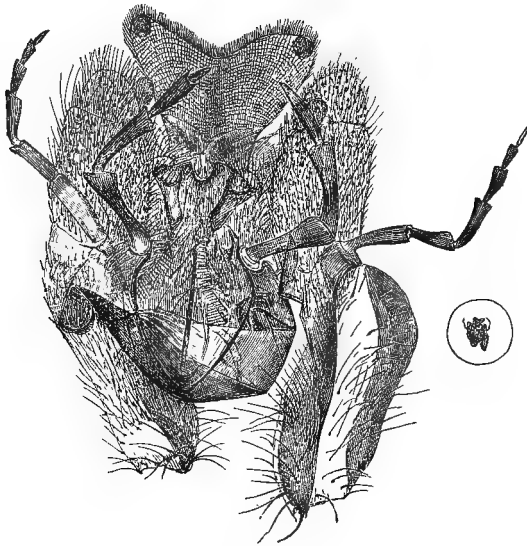

fig. 126.

Under-surface of a Wasp's Tongue, Feelers, &c. Within the circle is represented the life-size of same.

sent some point of interest to the microscopist. The various parts will be easily recognised by referring to the illustration of the common Crane-fly (fig. 125). The insect has its body constructed with a view to its being furnished with wings for the purpose of poising itself in the air. The number of segments of which the body is normally composed is thirteen; but some of them are so joined together, or concealed, as to make it appear that fewer segments are present.

The heads of all kinds of insects are good objects for the microscope. This will be seen by reference to fig. 135, which shows the head of a gnat, detached from the thorax, and drawn under a magnifying power of 50 diameters, by the aid of the camera lucida ; the eyes cover nearly two-thirds of the head ; and from the fore part are projected the proboscis, lancets, antennæ, &c.

In the mouths and tongues of insects, the most admirable art and wisdom are displayed ; and their diversity of form is almost as great as the variety of species. The mouth is usually placed in the fore part of the head, extending somewhat downwards. Many have their mouths armed with strong jaws or mandibles, provided with muscles of great power, with which they bruise and tear their food, answering to the teeth of the higher animals ; and in their various shapes and modifications serving as knives, scissors, augurs, files, saws, trowels, pincers, or other tools, according to the requirements of the insect.

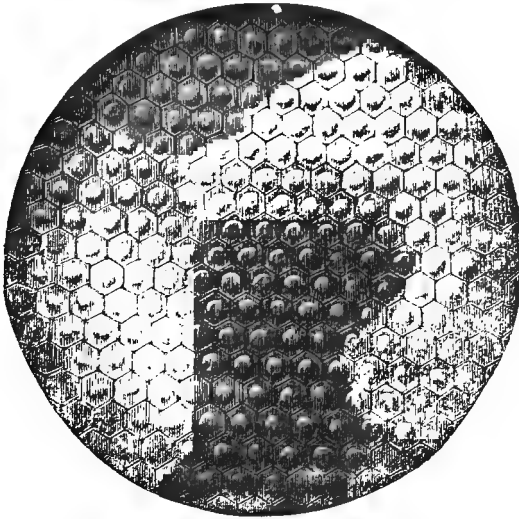

fig. 127. Eye of Fly, magnified 100 diameters.

The tongue is generally a compact instrument, used principally to extract the juices on which the insect feeds, varying greatly in its length in different species. It is capable of being extended or contracted at the insect's pleasure ; sometimes dexterously rolled up ; taper and spiral, as in the butterfly ; tubular and fleshy, as in the wasp. In fig. 126 the under-lip of the wasp is shown, with its brush

on either side; above which are two jointed feelers (*palpi labiales*), the use of which is probably for the purpose of examining the food before it is taken into the mouth, and afterwards to clean the tongue. Near these feelers the antennæ or horns are placed, curious in form as they are delicate in structure. The antennæ of the male generally differ from those of the female: some writers have believed them to be the organs of smell or hearing; others that they are solely intended to add to the perfection of their touch or feeling, being sensible to the least motion or disturbance of the air. They are amongst the most interesting and distinguishing characteristics of insects; and appear to be always employed for the purpose of examining every object they alight upon.

The structure of the eye is in all creatures a most admirable piece of mechanism: in none more so than in those of the insect tribe. The eyes differ in each species; varying in number, situation, figure, simplicity of construction, and in colour.

Fig. 127 represents a portion of the eye of the common fly, drawn by the light of the sun upon a prepared photographic surface of wood ready for the engraver, not a line being added by the hand of the draughtsman.

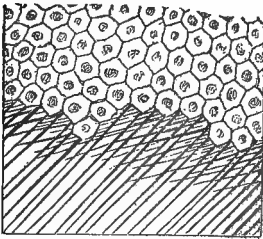

fig. 128.

Fig. 128 represents a side view of the eye when thrown down, and showing the compound eye to be made up of a large number of cylindrical tubes.

“On examining the head of an insect, we shall find a couple of protuberances, more or less prominent, and situated symmetrically one on each side. Their outline at the base is for the most part oval, elliptical, circular, or truncated; while their curved surfaces are spherical, spheroidal, or pyriform. These horny, round, and naked parts, seem to be the corneæ of the eyes of insects; at least they are with propriety so termed, from the analogy they bear to those transparent tunics in the higher classes of animals. They differ, however, from these; for when viewed by the microscope, they display a large number of hexagonal facets, which constitute the medium for the admission of light to as many simple eyes. Under an ordinary lens, and by reflected light, the entire surface of one of these corneæ presents a beautiful reticulation, like very fine wire gauze, with a minute papilla, or at least a slight elevation, in the centre of each mesh. These are resolved, however, by the aid of a compound microscope, and with a power of from 80 to 100 diameters, into an almost incredible number (when

compared with the space they occupy) of minute, regular, geometrical hexagons, well defined, and capable of being computed with tolerable ease, their exceeding minuteness being taken into consideration. When viewed in this way, the entire surface bears a resemblance to that which might easily and artificially be produced by straining a portion of Brussels lace with hexagonal meshes over a small hemisphere of ground glass. That this gives a tolerably fair idea of the intricate carving on the exterior, may be further shown from the fact, that delicate and beautiful casts in collodion may be procured from the surface, by giving this three or four coats with a camel-hair pencil. When dry, it is peeled off in thin flakes, upon which the impressions are left so distinct, that their hexagonal form can be discovered with a Coddington lens. This experiment will be found useful in examining the configuration of the facets of the hard and unyielding eyes of many of the Coleoptera, in which the reticulations become either distorted by corrugation, or broken by the pressure required to flatten them. It will be observed also, that by this method perfect casts can be obtained without any dissection whatever; and that these *artificial exuviae*—for such they really are—become available for microscopic investigations, obviating the necessity for a more lengthened or laborious preparation. The dissection of the cornea of an insect's eye is by no means easy. I have used generally a small pair of scissors, with well-adjusted and pointed extremities, and a camel-hair pencil, having a portion of the hairs cut off at the end, which is thereby flattened. The extremity of the cedar handle should be cut to a fine point, so that the brush may be the more easily revolved between the finger and thumb; and the coloured pigment on the interior may be scrubbed off by this simple process. A brush thus prepared, and slightly moistened, forms, as far as my experience goes, by far the best forceps for manipulating these objects preparatory to mounting; as, if only touched with any hard-pointed substance, they will often spring from the table from mere elasticity, and thus the labour of hours be lost in a moment. It does not appear to me desirable to attempt to flatten an entire cornea by pressure and maceration, although this is generally recommended, as it does not either aid in developing the beauty, or counting the number of its lenses. On the contrary, the rounded membrane becomes, if the margin remains intact, corrugated; and so one hexagon overlaps the other. It will be useful, therefore, to make two preparations of the eyes of one insect: the one entire, retaining its natural curved form, not having been subjected to pressure; the other nicked at its margin, or cut into small fragments, and pressed between two slides.

Each hexagon forms the slightly horny case of an eye. Their margins of separation are often thickly set with hair, as in the bee; in other instances naked, as in the dragon-fly, house-fly, &c. The number of these lenses has been calculated by various authors, and their multitude cannot fail to excite astonishment. Hooke counted 7000 in the eye of a house-fly; Leeuwenhoek more than 12,000 in that of a dragon-fly; and Geoffry cites a calculation, according to which there are 34,650 of such facets in the eye of a butterfly.”*

The trunk is situated between the head and the abdomen; the legs and wings are inserted into it. The thorax is the upper part of the trunk; the sides and back of which are usually armed with points or hairs. The abdomen

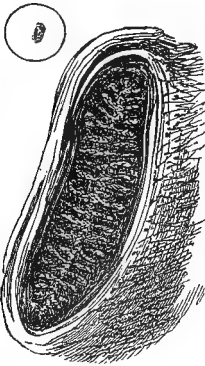

fig. 129.

Breathing-aperture or spiracle of Silkworm. The circle encloses the object of the natural size.

forms the posterior part of the body, and is generally made up of rings or segments, by means of which the insect can lengthen or shorten itself. Running along the sides of the abdomen are the spiracles, or breathing apertures, fig. 129, communicating directly with the internal respiratory organs. Pure air being thus freely admitted to every part, and the circulating fluids kept exposed to the vivifying influence of the atmosphere, the necessity for more complicated and cumbersome breathing organs is at once obviated; and thus the whole body is at the same time rendered lighter. They are usually nine or ten in number, and consist of a horny ring, generally of an oval form. The air-tubes are exquisitely composed of two thin membranes,

between which a delicate elastic thread, or *spiral fibre*, is interposed, forming a cylindrical pipe, and keeping the tube always in a distended condition; thus wonderfully preserving the sides from collapse or pressure in their passage through the air, which would occasion suffocation. No. 4, Plate IX. represents the beautiful mechanism of a portion of the tracheæ of the silk-worm moth. Fig. ~~129~~ is a small portion of a tracheæ, highly magnified, and showing the peculiar arrangement of the spiral tubes, giving elasticity and strength to the air-tubes of the *Hydrophilus*.

The legs of insects are extremely curious and interesting, each leg consisting of several horny cylinders, connected by joints and liga-

* John Gorham, Esq., *Microscopical Journal*, 1853.

ments ; enclosing within them sets of powerful muscles, whereby their movements are effected. The first is called the hip ; it is short, and is connected by a ball-and-socket joint to the thorax ; the second, called the *trochanter*, is connected with the former by a tough membrane, fitting to a corresponding socket ; the third, the *femur*, or thigh, is the largest and strongest, serving as a fulcrum, upon which the leg depends for strength and motion ; the fourth is named the *tibia*, or shank ; this is connected to the thigh by a beautiful hinge-joint, which permits of both bending and extension ; to the end of this is attached the *tarsus*, or foot, generally terminated by two horny hooks or claws, whereby the insect holds to the object upon which it moves ; between these hooks, in most species, is situated a cushion, sucker, or broad flaps (*pulvilli*), wherewith to take hold of a smooth surface. In fig. 132 the lower joints, with the feet of flies, are beautifully represented, marking peculiarities of structure in each ; and in fig. 131, we have a sucker somewhat resembling the admirably-constructed *sucker* attached to the under-surface of the feet of house-flies, by means of which "they tread the ceiling or inverted floor, and from its precipice depend secure." It was formerly supposed, from the experiments of Sir Everard Home, that flies were enabled to walk against glass, and with the back downwards in various situations, solely by the formation of a vacuum under the soles of their feet, if they may be so termed ; as it was observed that the margins of the feet were closely applied to the glass, while the central part was drawn up. It has, however, now been discovered that this hypothesis was not cor-

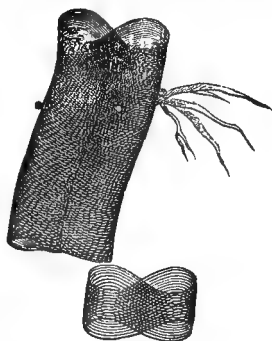

fig. 130.

Highly magnified portions of the trachea of the *Hydrophilus*, showing the spiral tubes, and their arrangement.

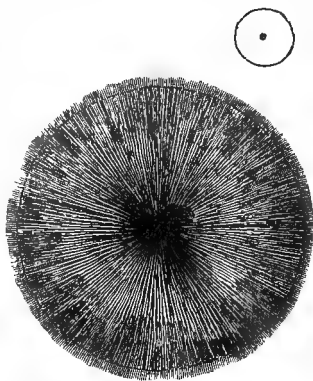

fig. 131.

Sucker on the foot of Water-beetle. The circle encloses the object of the natural size.

rect, as Mr. Blackwell (a gentleman residing in Manchester, and an acute observer of nature) noticed that flies remained attached to the

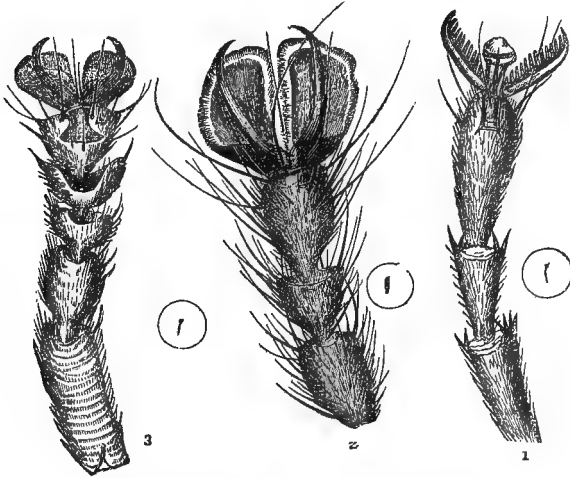
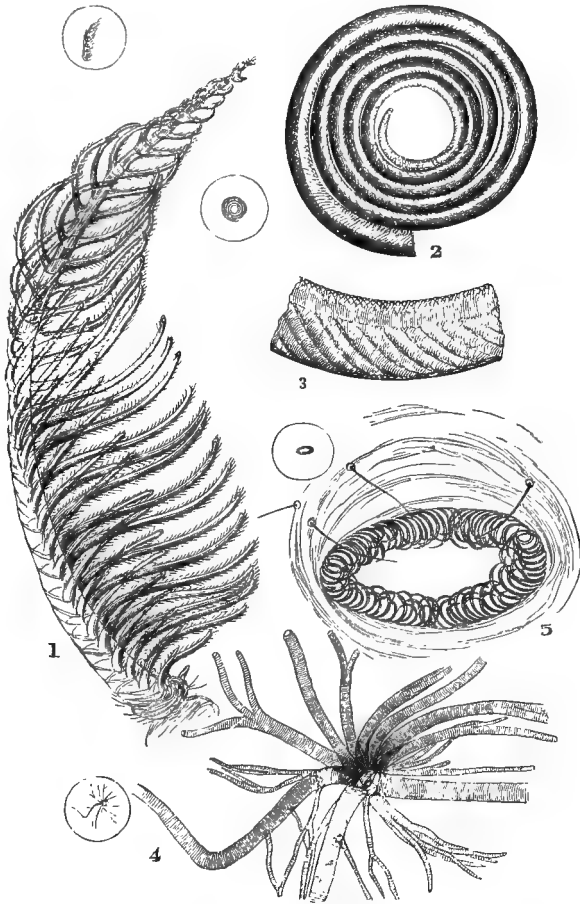

fig. 132. Feet and Legs, magnified 150 diameters.

1. Foot and leg of Ophion. 2. Foot and leg of Blow-fly. 3. Foot and leg of Drone-fly. The small circle encloses each object of about the natural size.

sides of an exhausted glass receiver of an air-pump, even after they had entirely lost the power of locomotion, and an evident distension of the body had been occasioned by the exhaustion of the air. To detach them from these stations, Mr. Westwood adds, the employment of a small degree of force was found requisite. In prosecuting this subject, clean phials of transparent glass, containing spiders and various insects in the larva and imago (perfect) states, capable of walking on their upright sides, were breathed into, till the aqueous vapour expelled from the lungs was copiously condensed on their inner surface. The result was remarkable; the moisture totally prevented those animals from obtaining any effectual hold on the glass, and the event was equally decisive if a small quantity of oil was substituted for the aqueous vapour. In fact, it was found that powder, or any substance on the inside of the phials, prevented the flies from climbing; and the idea naturally suggested itself that some glutinous substance was emitted by the feet of the flies, which enabled them to adhere to the glass. The next point to be determined, therefore, was, whether spiders and

PLATE IX.



MOTH, SILKWORM.

1. Antenna of Moth. 2. Tongue of Moth. 3. A portion of the Tongue highly magnified, showing circular muscular fibre. 4. Tracheæ of Silkworm. 5. Foot of Silkworm.

(THE SMALL CIRCLES ENCLOSE THE OBJECTS OF THE NATURAL SIZE.)

insects in the larva and perfect states were found to leave any visible track behind them when they crawled over glass ; and, by the aid of powerful magnifying-glasses, it was found that traces were left of an exceedingly minute quantity of glutinous matter, which appeared to have been emitted by the feet of these creatures ; and subsequent experiments proved that the hair-like appendages which form the brushes of spiders and flies are all tubular.

Plate VIII. represents the tongue and piercing apparatus of the *Drone Fly*. This remarkable compound structure, together with the admirable form and exquisite beauty of the apparatus, must strike the mind with wonder and delight, and lead the observer to reflect on the weakness and impotence of all human mechanism, when compared with the skill and inimitable finish displayed in the object before us. The fleshy outer case which encloses it has been removed for the purpose of viewing the several parts, which consist of two spongy guards or feelers, covered with short hairs, united to the head by muscles ; these feelers appear to be merely used as a preservative apparatus, in guarding the organs from external injury. The two lancets seen above them are formed somewhat like a cutlass, or the dissecting knife of the anatomist, and purposely intended for making a deep and sharp cut, and also for cutting vertically with a sweeping stroke. The other and larger cutting instrument appears to be intended to enlarge the wound, if necessary ; or it may be for the purpose of irritating and exciting the part around, thereby increasing the flow of blood to the part, being jagged or toothed at the extremity. The larger apparatus, with its three peculiar prongs or teeth, is tubular, to permit the drawing up of the blood and conveying it to the stomach ; it is enclosed in a case which entirely covers it. The spongy tongue itself projects some distance beyond this apparatus, and is composed of a beautiful network of soft muscular spiral fibres, forming a series of absorbent tubes ; and these are moved by powerful muscles and ligaments, the retractile character of which may be there seen in the drawing of the proboscis of the fly, Plate VII. : by the aid of these hooklets he is enabled to draw in and dart out the tongue with wonderful rapidity. The striated appearance of another set of muscles may be seen at the root of the whole.

“In the organisation of the mouth of various insects we have a modification of form, to adapt them to a different mode of use ; as in the *Muscidae*, or common house-flies. When the food is easily accessible, and almost entirely liquid, the parts of the mouth are soft and fleshy, and simply adapted to form a sucking tube, which in a state of

rest is closely folded up in a deep fissure, on the under-surface of the head. The proboscis at its base appears to be formed by the union of the *lacinia* above, and the *labium* below, the latter forming the chief portion of the organ, which is tenanted by dilated muscular lips. In the *Tabanus* these are exceedingly large and broad, and are widely expanded, to encompass the wound made by the insect with its lancet-shaped mandibles in the skin of the animal it attacks. On their outer surface they are fleshy and muscular, to fit them to be employed as prehensile organs; while on their inner they are more soft and delicate, but thickly covered with rows of very minute stiff hairs, directed a little backwards, and arranged closely together. There are very many rows of these hairs on each of the lips; and from their being arranged in a similar direction, they are easily employed by the insect in scraping or tearing delicate surfaces. It is by means of this curious structure that the busy house-fly often occasions much mischief to the covers of our books, by scraping off the white of egg and sugar varnish used to give them the polish, leaving traces of its depredations in the soiled and spotted appearance which it occasions on them. It is by means of these also that it teases us in the heat of summer, when it alights on the hand or face, to sip the perspiration as it exudes from and is condensed upon the skin. The fluid ascends the proboscis, partly by a sucking action, assisted by the muscles of the lips themselves, which are of a spiral form, arranged around a highly elastic, tendinous, and ligamentous structure, with other retractile additions for rapidity and facility of motion.* The beautiful form of the spiral will be best seen under a magnifying power of 250 diameters, or quarter-inch object-glass.

These insects are of great service in the economy of nature, their province being the consumption of decaying animal matter, given out in such small quantities, that they are not perceptible to common observers, neither removable by the ordinary means of cleanliness, even in the best-kept apartments, in hot weather. It was asserted by Linnæus, that three of these flies would consume a dead horse as quickly as a lion. This was, of course, said with reference to the offspring of such three flies; and it is possible the assertion may be correct, since the young begin to eat as soon as they are born. A single blow-fly has been known to produce twenty thousand living maggots; and each of these continues eating so voraciously, that in twenty-four hours it has increased its own weight above two hundred

* Mr. G. Newport, *Cyclopædia of Anatomy and Physiology*.

times ; and in five days it has attained its full size. When the maggots attain their full size, they change into the pupa state, and remain in that only a few days ; they then become flies, ready to produce thousands more maggots, and afterwards flies, till the whole brood is destroyed by cold.

We cannot resist an apt quotation on this wonderful little insect : " A fly on the wing is no less curious an object than one on foot ; yet, when do we trouble our heads about it, except as a thing which troubles us ? The most obvious wonder of its flight is its variety of direction, most usually forwards, with its back upwards like a bird, but on occasions backwards, with its back downwards, as when starting from the window and alighting on the ceiling. Marvellous velocity is another of its characteristics. By fair comparison of sizes, what is the swiftness of a race-horse clearing his mile a minute to the speed of the fly cutting through her third of the same distance in the same time ? And what the speed of our steaming giants, the grand puffers of the age, compared with the swiftness of our tiny buzzers ; of whom a monster train, scenting their game afar, may even follow partridges and pheasants on the wings of steam in their last flight as friendly offerings ? But, however, with their game the flies themselves would be most in 'keeping' on the atmospheric line,—a principal agent in their flight, as well as in that of other insects, being the air. This enters from the breathing organs of their bodies, in the nerves and muscles of their wings, from which arrangement their velocity depends, not alone on muscular power, but also on the state of the atmosphere. 'How does a fly buz?' is another question more easily asked than answered. 'With its wings, to be sure,' hastily replies one of our readers. 'With its wings as they vibrate upon the air,' responds another, with a smile, half of contempt, half of complacency, at his own more than common measurement of natural philosophy. But how, then, let us ask, can the great dragon-fly, and other similar broad-pinioned, rapid-flying insects, cut through the air with silent swiftness, while others go on buzzing when not upon the wing at all ? Rennie, who has already put this posing query, himself ascribes the sound partially to air ; but to air as it plays on the 'edges of their wings at their origin, as with an Eolian harp-string,' or to the friction of some internal organ on the root of the wing nervures. Lastly, how does the fly feed ? The busy, curious, thirsty fly, that 'drinks with me,' but does 'not drink as I,' his sole instrument for eating or drinking being his trunk or suck ; the narrow pipe by means of which, when let down upon his dainties, he is enabled to imbibe as much as suits his



fig. 133.

Calepteryx Virgo, Dragon-fly. *Melitæa Euphrosyne*, Pearl-bordered fritillary butterfly. *Cerambyx Moschata*, Musk-beetle. *Polyommatis Argiolus*, Azure-blue butterfly. *Lycæna phlæas*, Small copper butterfly; found throughout the month of July.

PLATE X.

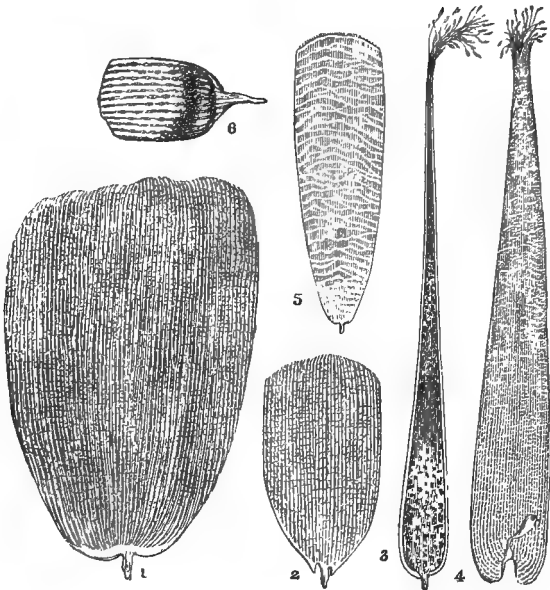
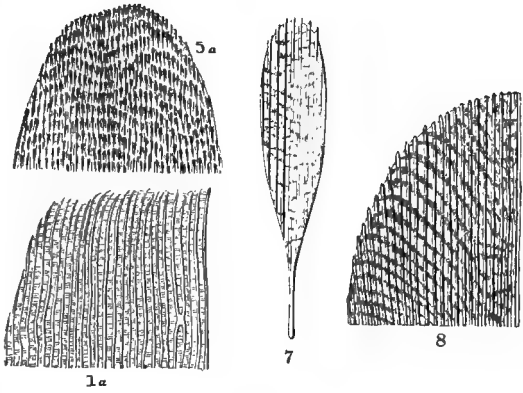

SCALES FROM BUTTERFLIES' WINGS, ETC.

1. Scale of *Morpho Menelaus*, magnified 250 diameters. 1a. Portion of Scale of *Morpho Menelaus*, magnified 500 diameters. 2. Large Scale of *Polyommatus Argiolus*, azure blue, magnified 250 diameters. 3. *Hipparchia Janira*, magnified 250 diameters. 4. *Pontia Brassica*, magnified 250 diameters. 5. *Podura Plumbea*, magnified 250 diameters. 5a. Portion of Large Scale of *Podura Plumbea*, magnified 500 diameters. 6. Small Scale of Azure Blue, magnified 250 diameters. 7. Scale from the Wing of Gnat, magnified 500 diameters. 8. Portion of a Large Scale of *Lepisma Saccharina*, magnified 500 diameters.

capacity. This trunk might seem an instrument convenient enough when inserted into a saucer of syrup, or applied to the broken surface of an over-ripe blackberry, but we often see our sipper of sweets quite as busy on a solid lump of sugar, which we shall find on close inspection growing 'small by degrees' under his attack. How, without grinders, does he accomplish the consumption of such crystal condiment? A magnifier will solve the difficulty, and show how the fly dissolves his rock, Hannibal fashion, by a diluent, a salivary fluid passing down through the same pipe, which returns the sugar melted into syrup."*

The wings are of great variety in form and structure; the beauty of their colouring, the art with which they are connected to the body, the curious manner in which some are folded up, the fine articulations provided for this purpose, with the various ramifications by which the nourishing fluids are circulated and the wing strengthened, all afford a fund of rational investigation highly entertaining, and exhibiting, when examined under the microscope, beautiful and wonderful design in their formation. Take the *Libellulidæ*, dragon-flies, as an example, whose wings, with their horny framework, are as elegant, delicate, and as transparent as gauze, often ornamented with coloured spots, which, at different inclinations of the sun's rays, show all the tints of the rainbow. One species (*Calepteryx virgo*, fig. 133) may be seen sailing for hours over a piece of water, all the while chasing, capturing, and devouring the various insects that come athwart its course, or driving away its competitors, without ever seeming tired or inclined to alight.

In fine weather, the female dragon-flies deposit their eggs, which they lay in water, making a strange noise, as though they were beating the water; and the eggs themselves look like a floating bunch of small grapes. The larvæ, when hatched, live in the water; and it is scarcely possible to fancy more strange-looking creatures. They are short, comparatively thick, and their motions are heavy and clumsy. They shed their skins and become pupæ; still continuing to live in the water. The pupa differs from the larva principally in having four small scales on its sides, which conceal the future wings. While the dragon-fly continues in its aquatic state, both as larva and pupa, it devours all the insects it can catch; but as it can only move slowly, it is furnished with a very curious apparatus to its head, which it can project at pleasure, and use as a trap. This apparatus consists of a pair of very large, jointed, movable jaws, which the insect keeps

* *Episodes of Insect Life*, a charming book, published by Reeve, 1851.

closely folded over its head, like a kind of mask, till it sees its prey. When it does, it creeps softly along till it is sufficiently near, and then darts out those long, arm-like jaws, and seizing the insect it had marked, conveys it to its mouth. When the dragon-fly emerges from

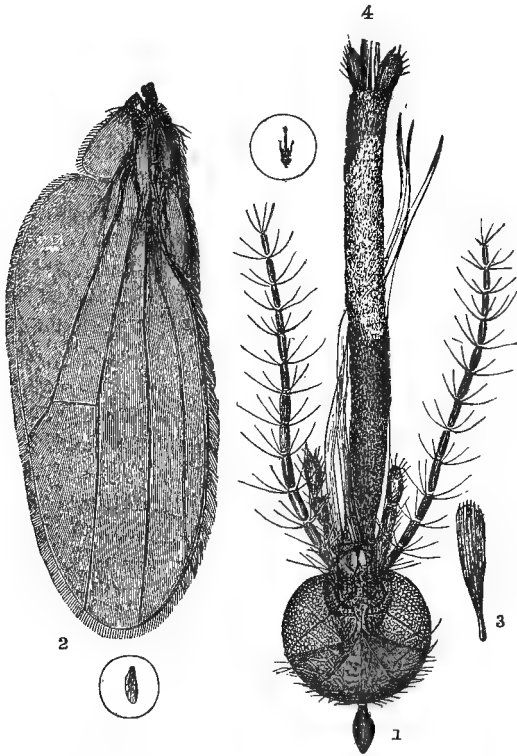

fig. 134. Head and Wing of *Culex pipiens*, Female Gnat.

1. Head of Female Gnat, detached from the body. 2. Wing. 3. A Scale from the Proboscis. 4. The Proboscis and Lancets. The reticulation on each side of the head shows the space occupied by the eyes. The small circles enclose the objects of natural size. The feather or scale from proboscis 250 diameters.

its pupa-case, it places itself on the brink of the pond, or on the leaf of some water-plant which is sufficiently strong to bear its weight, and there it divests itself of its pupa-case. When the insect first appears, it has two very small wings; these gradually swell out, the veins fill

with coloured liquid globules, and then two other wings gradually appear. As soon as the wings are fully expanded, and have attained their beautiful gauze-like texture, the dragon-fly begins to dart about, and to catch any insect that may fall in its way.

Equally rapid, exactly steered, and unwearied in its flight, is the gnat. The wing of a gnat has been calculated, during its flight, to vibrate 3000 times in a minute : these wonderful wings are covered on surface and edge with a fine down or hair.

The alternations of bright sunshine and rain which are common in March, are extremely favourable to the appearance of gnats. The first that appear are called the winter midges (*Trichocera hyemalis*). As the spring advances, these midges are succeeded by others of a different species ; and as the weather becomes warmer, the true gnats appear. The sting of the gnat (*Culex pipiens*) is well known ; though gnats themselves are generally so rapid in their movements, and so much dreaded, that very few people care to examine the delicacy and elegance of their forms. The sting is very curiously formed (see fig. 134). The sucker is enclosed in a sheath, which folds up after one or more of the six lancets have pierced the flesh ; it thus inflicts a severe though minute wound, the pain of which is increased by an acrid liquor injected into it through the curiously-formed proboscis, which is covered with feathers or scales. A magnified view of one of these feathers is seen at No. 3, fig. 134. A scale from a gnat's wing is seen magnified 600 diameters in Plate X. No. 7. The proboscis is protected on either side by antennæ, or feelers. Those who will take the trouble to watch the operations of the female (fig. 135), when she is about to make her nest, will be very much struck with the ingenuity and admirable instinct which this little creature displays.



fig. 135. Female Gnat depositing her eggs.

The bodies of insects are covered with a hard skin ; this answers the purpose of an internal skeleton, and is one of their chief characteristics. All animals, and most fishes, have an internal skeleton of bones, to which the muscles are fixed ; but the interior of an insect is composed of a soft mass, and the muscles are affixed to the exterior casing or horny skin, which answers all the purposes of bone, connecting the various parts, and maintaining them in their proper places ; at the same time it is a perfect covering to the body. In some insects this horny skin is remarkable for its strength, as in the beetle tribe, many of which are exceedingly curious objects.



fig. 136.

Caddis-worm cases and Fly. *Phryganea grandis*—*Coccinella septem punctata*, Seven-spot Lady Bird. *Miklia Aprilina*, Marvel-du-jour Moth. *Euchloe Cardamines*, Orange-tip Butterfly; all to be met with during the month of April.

The family of *Phryganeidæ*, the larvæ of which are aquatic, present almost as little resemblance to the imago as those of some metabolous insects. They are long, softish grubs, furnished with six feet, and with a horny head armed with jaws, generally fitted for biting vegetable matters, although some appear to be carnivorous. To protect their soft bodies, which constitute a very favourite food with fishes, these larvæ always enclose themselves in cases formed of various materials; bits of straw and sticks, pebbles, and even small shells, being commonly employed in this manner. The materials of these curious cases are united by means of fine silken threads, spun like those of the caterpillars of the *Lepidoptera*, from a spinnaret situated on the labium. In increasing the size of its case to suit its growth, the larva is said to add only to the anterior end, cutting off a portion of the opposite extremity. When in motion, the larva pushes its head and the three thoracic segments, which are of a harder consistence than the rest of the body, out of its case; and as the latter is but little, if at all, heavier than the water, the creature can readily drag it along behind it, thus keeping its abdomen always sheltered. It adheres stoutly to the inside of its dwelling by means of a pair of articulated caudal appendages, generally assisted by three tubercles on the first abdominal segment.

Before passing to the pupa state, the larva fixes his case to some object in the water, and then closes up the two extremities with a silken grating, through which the water necessary for the respiration of the pupa can easily pass. The pupa is furnished with a large pair of hooked jaws, by means of which, when about to assume the perfect state, it bites through the grating of its prison, and thus sets itself free in the water. In this form the pupæ of some species swim freely through the water by means of their long hind legs, also creeping upon the other four limbs; these frequently rise to the surface of the water, and there undergo their final change, using their deserted skin as a sort of raft, from which to rise into the air, whilst others generally creep up the stems of aquatic plants for the same purpose.

The perfect insect (*Phryganea grandis*, shown in fig. 136, near its larva-case), has four wings, with branched nervures, of which the anterior pair are clothed with hairs; the posterior are folded in repose. The organs of the mouth, except the palpi, are rudimentary, and apparently quite unfit for use. The head is furnished with a pair of large eyes, and with three ocelli, and the antennæ are generally very long. Some species are so exactly like Moths, that they have often been supposed to belong to the Lepidopterous order; and, in fact, these insects

may be considered to form a connecting link between the *Neuroptera* and the *Lepidoptera*. The females have been observed to descend to the depth of a foot or more in water, in order to deposit their eggs.

Many species of these insects are found in Britain. The larvæ are well known to anglers under the names of Caddis-worms and Straw-worms. They are said to be excellent baits.

LEPIDOPTERA. BUTTERFLIES AND MOTHS.

In this, the highest order of the suctorial insects, with a complete metamorphosis, we meet with creatures which must be ranked with the most elegant denizens of the air.

Who has not seen and admired the elegant butterfly, fluttering over flowers, which they frequently excel in splendour of colour, and at length resting on them with a touch so light as not to appear to be resting there? Who has not seen them, whilst reposing on the flower, opening and shutting their beautiful wings, alternately erecting and depressing their long and slender antennæ, popularly called horns? and who has not seen the beautiful apparatus by which they extract the nectar from the flowers?

All butterflies and moths proceed from caterpillars, which afterwards change into chrysalides; out of which, after a certain time, proceed the perfect insects. The female butterfly deposits her eggs upon such substances as are proper to nourish the caterpillars which proceed from them: thus, the common cabbage-butterfly places them on cabbage; the peacock-butterfly on nettles; the swallow-tailed butterfly on fennel or rue; the atalanta-butterfly on nettles, &c. These eggs are simply attached by some glutinous secretion to leaves or stems; in the same way are the eggs of moths placed, a few of the latter are enclosed in down. The *Lepidoptera* are divided into two great groups, the *Heteroscera* and the *Rhopalocera*.



fig. 137.

Eggs of the Lackey Moth.

The distinguishing characteristics of butterflies are, that the horns terminate in small knobs; and the wings, when the insects are at rest, are so placed that they meet upwards. Moths, on the contrary, have sharp-pointed horns, which in many are simple, in others beautifully feathered along the sides; while the wings, when at rest, lie in a horizontal position.

Moths and butterflies supply the microscopist with some of the most beautiful objects for examination. What can be more wonderful in

their adaptation than the antennæ of the moth, represented in Plate IX., No. 1, with thin finger-like extremities almost supplying the insect with a perfect and useful hand, moved throughout its extent by a muscular apparatus, the whole being of a feathery construction ! The tongue, No. 2, for the purpose of dipping into the interior of the flower and extracting the honey, is endowed with a series of muscles : an enlarged view of a portion of the same is seen at No. 3.

The inconceivably delicate structure of the maxillæ or tongues (for there are two) of the butterfly, rolled up like the trunk of an elephant, and capable like it of every variety of movement, has been carefully examined and described by Mr. Newport. "Each maxilla is convex on its outer surface, but concave on its inner; so that when the two are approximated, they form a tube by their union, through which fluids may be drawn into the mouth. The inner or concave surface, which forms the tube, is lined with a very smooth membrane, and extends throughout the whole length of the organ; but that each maxilla is hollow in its interior, forming a tube 'in itself,' as is generally described, is a mistake; which has doubtless arisen from the existence of large trachæ, or breathing-tubes, in the interior of each portion of the proboscis. In some species, the extremity of each maxilla is studded externally with a great number of minute papillæ, or fringes—as in the *Vanessa Atalanta*—in which they are little elongated barrel-shaped bodies, terminated by smaller papillæ at their extremities." Mr. Newport supposes that the way in which the insect is enabled to pump up the fluid nourishment into its mouth is this: "on alighting on a flower, the insect makes a powerful expiratory effort, by which the air is expelled from the interior air-tubes, and from those with which they are connected in the head and body; and at the moment of applying its proboscis to the food, it makes an inspiratory effort, by which the central canal in the proboscis is dilated, and the food ascends it at the same instant to supply the vacuum produced; and thus it passes into the mouth and stomach: the constant ascent of the fluid being assisted by the action of the muscles of the proboscis, which continues during the whole time that the insect is feeding. By this combined agency of the acts of respiration and the muscles of the proboscis, we are also enabled to understand the manner in which the humming-bird sphinx extracts in an instant the honey from a flower while hovering over it, without alighting; and which it certainly would be unable to do, were the ascent of the fluid entirely dependent upon the action of the muscles of the organ."*

* *Cyclop. Anat. and Physiol.*, article "Insecta."

In the wings of moths and butterflies we have them also covered with scales or feathers, carefully overlapping each other, as the tiles cover the tops of our houses. The irridescent variety of colouring on the wings arises from the peculiar wavy arrangement of these scales. In Plate X. are seen magnified representations of a few of them. No. 1 is a scale of the *Morpho-Menelaus*, taken from the side of the wing, of a pale-blue colour : it measures about 1-120th of an inch in length, and exhibits a series of longitudinal stripes or lines, between which are disposed cross-lines or striæ, giving it the appearance of brick-work. The microscope should be enabled to make out these markings with the spaces between them clear and distinct, as shown at No. 1 *a*.

Polyommatus Argiolus, or *Azure-blue*, Nos. 2 and 6, are large and small scales taken from the under-side of the wing of this beautiful blue butterfly ; the small scale is covered with a series of spots, and exhibits both longitudinal and transverse striæ, which should be most clearly defined, and the spots separated : it is a very good test of the defining power of a quarter-inch object-glass.

No. 3. *Hipparchia Janira*, or *Common Meadow Brown Butterfly* : on this may be seen a number of brown spots of irregular shape and longitudinal striæ. Arnici used this as a test-object.

No. 4. *Pontia Brassica*, or *Cabbage-butterfly*, affords an excellent criterion of the penetration and definition of a microscope : it is provided at its free extremity with a brush-like appendage. With a high power, the longitudinal markings appear to be rows of little beads.

The *Tinea Vestianella*, or *Clothes-moth*, possesses very delicate and unique scales : two of these are imperfectly represented near the *Acarus* found on one of these moths, at page 334. The feathers from the under-side of the wing are the best, requiring some management of illumination to bring out the lines sharp and clear.

The common clothes-moth generally lays its eggs on the woollen or fur articles it intends to destroy ; and when its larva appears, it begins to eat immediately ; with the hairs or wool it has gnawed off, it forms a silken case or tube, under the protection of which it devours the substance of the article on which it has fixed its abode. This tube is of parchment-like consistence, and quite white ; it is cylindrical in its shape, and furnished at both ends with a kind of flap, which the insect can raise at pleasure, and crawl out ; or it can project the front part of its body with its fore-feet through the opening, so as to crawl about without removing the rest of its body from the tube, which it drags after it. There are several kinds of clothes-moths ; and the

caterpillars of some of them bury themselves in the article on which they feed, instead of making the silken tube spoken of. The moths also differ very much in appearance: the commonest kind is of a light buff; one species, *Tinea Tapetzella*, fig. 138, is nearly black, with the tips of its larger wings white, or pale grey.

Mr. Topping, the careful preparer of microscopic objects, generally furnishes three kinds of *test-objects*, which he covers with the thinnest glass, in order that object-glasses of the highest powers may be used in the examination of them. The following are arranged according to their difficulty as test-objects:



fig. 138.
The Black Clothes-moth.

Fos. *N. gracilis*.
Amician test.
Grammatophora.
Ceretonis faschiota.
Navicula cuspidata.
— *angulata*.
— *strigosa*.
— *lineata*.
— *Spencerii*.

N. baltica.
— *hippocampus*.
— *strigitate*.
— *formosum*.

SCALES.

Meadow Brown.
Pontia Brassica.
Azure Blue.
From Gnat's Wing.
Tinea Vestianella.
Amathusia Horsefieldii.
Morpho Menelaus.
Podura plumbea.
Lepisma saccharina.

HAIRS.

Indian Bat.
,, Mouse.
,, Mole.
Larva of *Dermistes*:

Mr. J. T. Norman, preparer of specimens for the microscope, 10 Fountain Place, City Road, furnished the author with a similar list for publication.

The caterpillar's foot is made up of a series of hooklets, which enable him to cling with ease to the surface of a leaf or stalk of a plant. A magnified view of one is given at No. 5, Plate IX.

The *Homoptera* form three great groups or tribes. The first, the *Coccinea*, is composed of numerous minute insects, of which the history is still very imperfectly known. Of these the tarsi have only one joint. The males are furnished with two wings, with a few straight nervures; they are destitute of a rostrum, and pass their pupa stage in a state of repose. The females are destitute of wings, possess a rostrum, and appear to undergo no metamorphosis whatever. These curious little creatures, whose history is so singular that some authors have proposed the formation of a separate order for their reception, are principally inhabitants of the warmer regions of the earth, although many species are found in our own country, where some of them are well

known to gardeners under the name of "the bug," from the injury they do to many plants, especially in hothouses.

Nothing can be more dissimilar in appearance than the two sexes of the singular insects *Homoptera* (fig. 139). The females usually form a mere fleshy mass, often nearly destitute of limbs, and remaining attached to one spot upon the branches of the plant infested by them, from which they continue to suck nutriment, by the agency of their

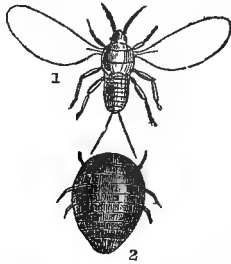

fig. 139. *Cochineal Insect*.
1. Male. 2. Female.

rostrum, until they attain a considerable size. The males, on the contrary, are generally very minute and really elegant creatures, furnished with a single pair of filmy wings; the only representatives of the hinder wings being a pair of organs somewhat similar to the *halteres* of the *Diptera*. Hence some etymologists have put forward the opinion that the males of the *Coccina* are, in reality, dipterous parasites. The abdomen of the male is generally furnished with a pair of long filaments. In some instances the females retain their limbs and power of motion through life.

In one genus of *Coccina* (*Dorthisia*), several species of which are found in this country, the female—which, although apterous, is active in all stages—is completely covered with a snow-white secretion, which gives it more the appearance of a little plaster-cast than any thing else.

In a second tribe, the *Phytophthiria*, or *Plant-lice*, both sexes are either wingless or furnished with four distinctly veined wings. The rostrum springs apparently from the breast, and the tarsi are two-jointed and furnished with two claws.

The greater part of this tribe is composed of the *Aphides*, or *Plant-lice*, whose extraordinary history renders them one of the most interesting groups of insects. These creatures must be well-known to every one. They are all small animals, with a more or less flask-shaped body, furnished with six feet and a pair of antennæ, and usually with a pair of short tubes close to the extremity of the abdomen, from which a clear sweet secretion exudes. Both sexes are sometimes winged, sometimes apterous; and the individuals of the same species are often winged and apterous at different periods of the year. They all live upon plants, the juices of which they suck; and when they occur in great numbers, often cause great damage to vegetation. Gardeners and farmers are well aware of this. Many plants are liable to be

attacked by vast swarms of *Aphides*, when their leaves curl up, they grow sickly, and their produce is certain to be greatly reduced. One striking instance is presented by the Hop-fly (*Aphis Humuli*).

The *Cicadellina* or Cercopidæ, of which the *Aphrophora bifasciata*, or common Frog-hopper, have the antennæ placed between the eyes, and the scutellum visible—that is to say, not covered by a process of the prothorax. The ocelli, which are sometimes wanting, are never more than two in number. These little creatures are always furnished with long hind legs, which assist them in performing most extraordinary leaps.

The best-known British species, so very abundant in gardens, is the *Cuckoo-spit*, or *Froth-fly*. The names of cuckoo-spit and froth-fly both allude to the peculiar habit of the insect, when in the larva state, of enveloping itself in a kind of frothy secretion, somewhat resembling saliva; and which, indeed, was formerly supposed to be the saliva of the cuckoo, it being found on the young shoots of plants just about the time that the cuckoo is heard in the woods. The frothy secretion is supposed to be intended to preserve the tender body of the insect from the overpowering effects of the sun, as it has been observed to be produced in exact proportion to the heat of the weather. It is not known exactly how the froth is produced. When by any chance it becomes



Aphrophora spumaria, Cuckoo-spit.
a. The frothy substance. b. The pupa.



Perfect Insect of
the Cuckoo-spit.

fig. 140.

condensed, it drops like rain from the trees on which the insect is found. It is only in its larva or infant state that it produces the froth. The larva and the pupa resemble the perfect insect, except that the larva has no wings, and the pupa has very small ones. The perfect insect, however, has both wings and wing-cases; and it has the power of flying to a considerable distance. Sometimes, indeed, these insects are seen in vast multitudes on the wing. One of the peculiarities of this insect is its power of leaping, which is so great, that, being assisted by its wings, it will sometimes leap a distance of five or six feet; which is more than two hundred and fifty times its own length, or as

much as if a man were to take a leap a quarter of a mile high. This extraordinary activity appears to be principally occasioned by the great length of the thighs of the insect, which are also furnished on their outer margin with a fringe of stiff hairs or strong spines, which are of great use to the insect in leaping.

The *Hymenoptera* are distinguished from the other insects with membranous wings, by the presence of an ovipositor of peculiar construction at the extremity of the abdomen in the females, which not only serves for placing the eggs in the required position, but also in many species (Bees, Wasps, &c.) constitutes a most formidable offensive weapon. As the structure of this organ, which is rarely absent, is essentially the same throughout the order, the form of its component parts being merely modified to suit the exigences of the different insects, a short description of its general construction will not be out of place here. The ovipositor, or sting, generally consists of five pieces : a pair of horny valves (fig. 144), which form a sheath for the true sting or ovipositor ; these are jointed at the point where they issue from the cavity of the last abdominal segment, and the last joint is usually as long as the sting itself. The latter consists of three bristles, of which the superior is channelled along its lower surface, for the reception of a pair of finer bristles, which are toothed at the tip. These three pieces, when fitted together, form a narrow tube, through which the egg passes to its destination ; and through this also the poisonous fluid, which renders the sting of the bee so painful, is injected into the wound. In the saw-fly one of these parts remains rudimentary ; but in other respects the organ is the same.

The larvæ of most of the *Hymenoptera* are footless grubs, usually furnished with a soft head, exhibiting but little, if any advance upon the maggots of the *Diptera*. In the saw-flies, however, the larva, instead of being, as above described, a mere footless maggot, presents the closest resemblance to the caterpillars of the *Lepidoptera*, being provided with a distinct horny head, and not only with six thoracic legs, but also, in most cases, with from twelve to sixteen pro-legs, situated upon the abdominal segments.

The *Saw-fly*, fig. 141, so destructive to gooseberry-bushes, is remarkable for the manner in which the female provides for the safety of her eggs. This fly has a flat yellow body, and four transparent wings, the outer two of which are marked with brown on the edge. The female lays her eggs on the under-side of the leaf, on the projecting veins ; and these are so firmly attached, that they cannot be removed without crushing them. The instrument which the little insect uses for the

purpose of cutting the leaf, is one of the most remarkable pieces of perfect mechanism : it is securely lodged, when not in use, in a long narrow slit beneath the hinder part of the abdomen, bounded by two horny



fig. 141. *The Saw-fly of the Gooseberry.*

plates. At first these appear to consist of a single piece ; but upon closer inspection four plates are found to enter into their construction : namely, two saws, placed side by side, as in fig. 142 ; and two supports, very like the saws in shape. A deep groove runs along the thick edge

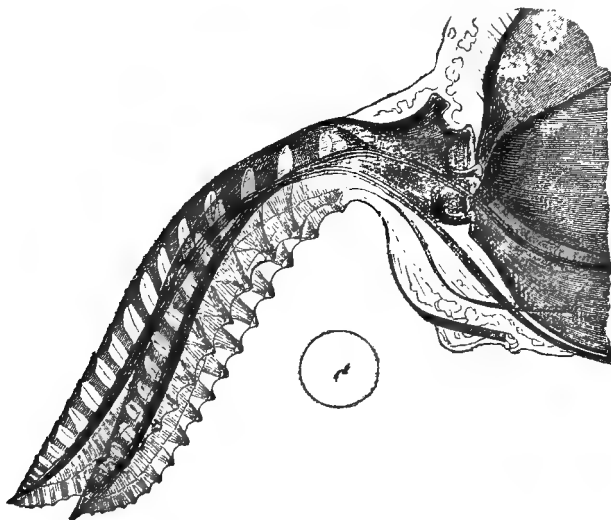

fig. 142. *Saws of Saw-fly.*

In the small circle is represented the comparative size of these instruments ; they are drawn rather too small.

of the latter, which is so arranged that the saws run backwards or forwards, without the possibility of getting out of the groove. When the cut is made, the four are drawn together ; and through the central canal, which is now formed by combining the whole, an egg is protruded into the fissure made by the saws in the leaf. The cutting edges of the saws are provided with about eighteen or twenty teeth,

having sharp points of extreme delicacy ; together forming a good serrated edge of exactly the form given to the finest and best-made surgical saws. In the summer-time the proceedings of this little insect may be watched, and the mode of using this curious instrument seen, by the aid of a hand magnifying-glass ; as they are not easily alarmed when busy at this work.

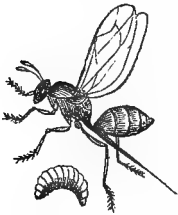

fig. 143.

Female Eglantine
Gall-fly and Larva.

Many other insects are provided with instruments for boring into the bark or solid wood itself. The *Cynip* bores a hole into the side of the oak-apple, for the purpose of depositing its larva, whence, as well as being comfortably lodged, it receives its early food. When full grown, it eats its way out of the nut ; and dropping to the ground, it assumes its *pupa* form, which in a short time is exchanged for that of the perfect fly. The most important of these insects is the *Cynip gallæ tinctorice*, fig. 143, which causes the formation of the gall-nut, so extensively employed in the manufacture of ink and for dyeing purposes.

Some of the wasp tribe are very peculiar in their habits, and are active agents in the economy of nature. The solitary, or mason wasps, curiously construct their nests, forming cells, in which they most carefully rear their young. The social wasps, like the bees, live in communities, and have nearly the same divisions of labour and regulations for the government of their colony. The structure and mechanical contrivance of their stings can only be seen under the microscope. The stings consist of two *barbed darts*, which penetrate the flesh deeply ; and from the peculiar arrangement of their serrated edges, their immediate withdrawal is prevented ; while, by the muscular effort required for this purpose, a small sack or bag near the root is pressed upon, and its irritating contents squeezed into the wound. After the fluid is injected, the insect possesses the power of contracting the barbed points ; it then withdraws the sting from the flesh. In fig. 144 the sting of the wasp is shown, with its attachments and muscular arrangements ; and it can be seen that the sting is most wonderfully adapted to become an instrument of a very effective and deadly construction. The brushes near it are evidently placed there for the purpose of cleaning or wiping it. At all events this appears to be one of the uses they are put to.

The proboscis or trunk of the honey-bee next demands our attention ; this it uses, with its accessories, to collect the honey for its food

PLATE XI.

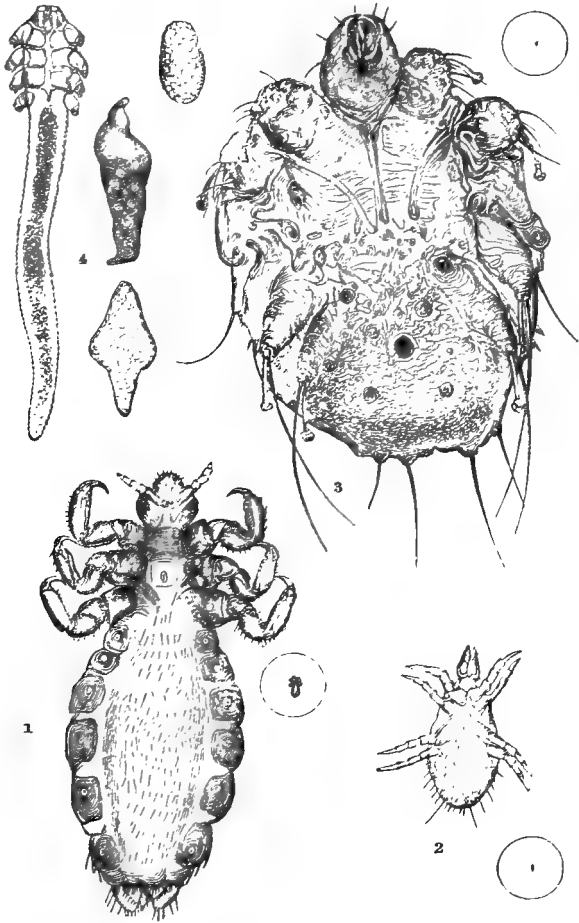

PARASITES.

1. LOUSE, HUMAN; magnified 50 diameters.
2. ACARUS DOMESTICUS, Cheese-Mite; magnified 50 diameters.
3. SARCOPTES SCABIEI, Itch-Insect; magnified 350 diameters.
4. DEMODEX FOLLICULORUM, or Grub from Human Skin, in its various stages of existence, from the Egg upwards; magnified 250 diameters.

(THE SMALL CIRCLES ENCLOSE THE OBJECTS OF THE NATURAL SIZE.)

when roving about from flower to flower. The proboscis itself (fig. 145) is very curiously divided ; the divisions are elegant and regular, beset with triangular hairs ; and being numerous, appear at first sight



fig. 144.

1. Sting of Wasp. 2. Sting of Bee.

The small circle encloses the object of the natural size.

as a number of different articulations. The two exterior lancets are spear-shaped, and of a membranaceous or horny substance set on one side with short hairs, and having their interior hollow ; at the base of each is a hinge-articulation, permitting considerable motion in several directions ; evidently used by the little busy insect for the purpose of distending the internal parts of flowers, and thus facilitating the intro-

duction of the proboscis. The two shorter feelers are closely connected to the proboscis, and terminate in three jointed articulations. Swammerdam thought these were used as fingers in assisting the removal of obstructions ; but it is more probable that they are used by the insect for the purpose of storing and removing the bee-bread to the pocket-receptacle in the legs. The lower part of the proboscis is so formed that it may be considerably enlarged at its base, and thus made to con-

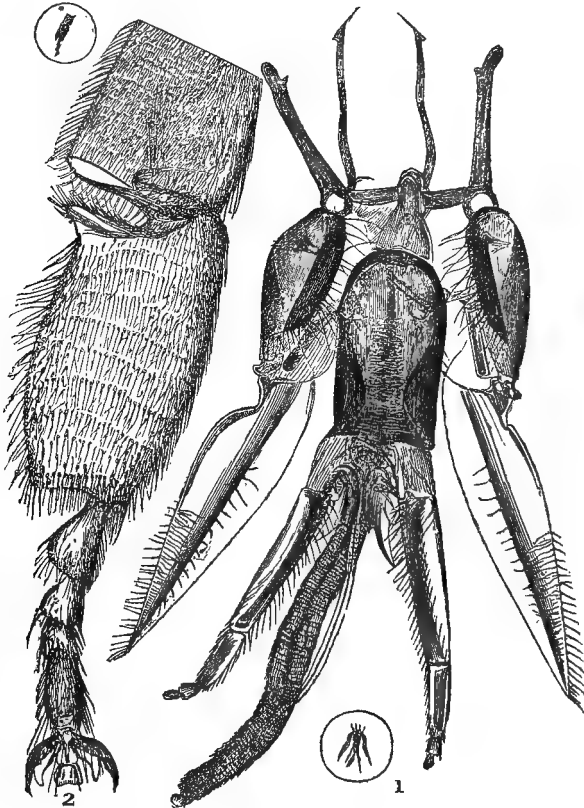

fig. 145.

1. Honey-bee's tongue. 2. Leg, showing pocket for carrying the Bee-bread.
The small circles enclose the objects of their natural size.

tain a larger quantity of the collected juice of flowers ; while, at the same time, in this cavity the nectar is soon transformed into pure honey

by some peculiar chemical process of its own ; the proboscis tapers off to a little nipple-like extremity. At its base may be seen two shorter and stronger mandibles, serving the little insects for tools in constructing their cells ; from between these is protruded a long and narrow tongue or lance ; the whole most ingeniously connected to the head by a cartilaginous structure, with a series of muscles and ligaments. The proboscis being cylindrical, extracts the juice of the flower in a somewhat similar way to that of the butterfly ; when loaded with honey, the next care is to fill the very ingenious pockets situated in its hind-legs (one of which is shown at No. 2) with bee-bread ; when these little pockets are filled with as much pollen as the bee can conveniently carry, it flies back to the hive with its valuable load, where the bee is speedily assisted to unload by its fellow-workers ; and the pollen is at once kneaded and packed close in the cells provided for its preservation. The quantity of this collected in one day by a single hive during favourable weather is said to be at least a pound ; this seems to constitute the food of the working-bees in the hive. The wax is another secretion exuding from the skin of the insect, and is found in little pouches in the under-part of the body ; it is not collected and brought home ready for use, as has been generally supposed. The waxen walls of the cells are, when completed, strengthened by a varnish, called *propolis*, collected from the buds of the poplar and other trees, and besmeared over them by the wonderful apparatus we have shown in the engraving. If a bee is attentively observed when it has placed itself upon a flower, the activity and promptitude with which it uses this apparatus is truly surprising. It lengthens it, applies it to the bottom of the petals, then shortens it, bending and turning it in all possible directions, for the purpose of exploring the interior, and removing the whole of the pollen. In the words of Brook :

“The dainty suckle and the fragrant thyme,
By chemical reduction they sublime ;
Their sweets with bland attempering suction strain,
And curious through their neat alembics drain ;
Imbib'd recluse, the pure secretions glide,
And vital warmth concocts th' ambrosial tide.”

BEETLES.

The leading characteristic of the vast order of *Coleoptera*, or Beetles, consists in the leathery or horny texture of the anterior wings (*elytra*), which serve as sheaths for the posterior wings in repose, and generally meet in a straight line down the back.

The common *Black-beetle* (*Blatta orientalis*, fig. 146) is not, strictly speaking, one of the beetle tribe, but more nearly allied to the cricket and grasshopper. All the insects belonging to this class are very destructive, as they continue eating through all their transformations. The female black-beetle does not lay her eggs singly, but always sixteen at a time ; and these eggs are enclosed in a capsule, which resembles a small oblong box (see upper part of cut). The mother carries this capsule about with her, until the sides of it have attained a proper firmness, and become changed from white to brown. If this receptacle for the eggs is more closely examined, it will be seen that one of the two longer margins is very finely toothed, and is composed of two

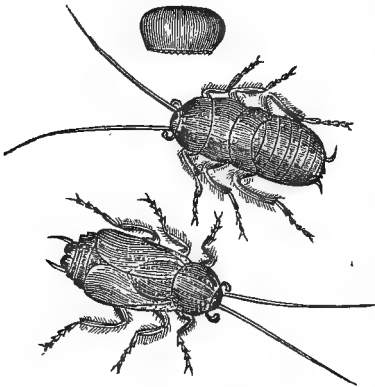

fig. 146.

Male and female Blatta orientalis.

layers, and so constructed that the teeth of one of the layers easily go into the spaces between the teeth of the other. This margin is also so firmly united by means of a gummy substance, that it might be easier opened at any other part than at the toothed edge. As soon as the young are hatched, and have quitted the egg, they emit a fluid from their mouths, by which they soften the cement that united the two layers of the capsule together, and thus contrive to open the door of their prison-house.

Melolontha Vulgaris, or *Cockchafer*, is very abundant in our island, and it has a variety of names,—the brown tree-beetle, blind-beetle, May-bug, chaffer, May-bob, or oak-web, jack-horner, geffry-cock, acre-bob, as it is termed in different parts of the country. The larva is soft and grey, with the head and legs protected by a shelly covering of a yellow-brown colour. While in the larva state, which continues for a space of two or three years, it devours the roots of corn, grass, and other vegetables.

The eggs are laid in small detached heaps, beneath the surface of some clod ; and the young, when first hatched, are scarcely more than one-eighth of an inch in length, gradually increasing in their growth, occasionally changing their skins, until they are of the size of two inches or more. At this time they descend to the depth of two feet, where they construct an oval cell, very smooth in the inside ; and after



fig. 147.

Geotrupes stercorarius, Dor beetle. *Bombus terrestris*, Humble bee. *Vanessa urticae*, Small tortoiseshell butterfly. *Apis mellifera*, Honey-bee. *Arum*, *Narcissus*, &c, frequently found during the month of March.

a certain time, divest themselves of their last skin, and appear in the chrysalis form, in which they continue till the succeeding spring, when they assume the perfect beetle ; but remain for a considerable time in a weak state, not venturing out till the fine days of May or the beginning of June, at which time the beetle emerges from its retirement, and commits its depredations on the leaves of trees, &c. The antennæ have a remarkable comb-shaped appearance, and, with other parts of this insect, generally find a place in the microscopist's cabinet.

The elytra or wing-cases of the diamond beetles are amongst the

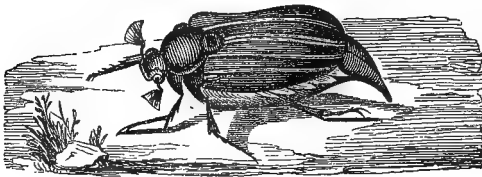

fig. 148. *Melolontha Vulgaris*, or Cockchafer.

most brilliant of opaque objects. Some are improved by being mounted in Canada balsam, whilst others are more or less injured by it : a trial of a small portion, by

first touching it with turpentine, will decide this point.

To the genus *Ptinus* belongs a small beetle, known as the *Death-watch*, fig. 149. This and the species *Anobium* are found in our houses, doing much injury whilst in the larva state. The eggs are often deposited near some crack in a piece of furniture, or on the binding of an old book. As the larvæ are hatched, they begin to eat their way into the furniture on which they have been deposited ; and when they have attained a sufficient depth, they undergo their transformations, and return, by another passage, as beetles. In furniture attacked by them, little round holes, about the size of the head of a pin, may be seen ; and these are the holes that have been made by the beetles. The noise, which has given rise to the name of death-watch, is made by the insect striking its head against the wood. The larva is called a book-worm when it attacks books ; and old books when seldom used



fig. 149.

The Death-watch
(*Atropus*),
magnified.

are often found bored through by it. Kirby and Spence mention, that in one case twenty-seven folio volumes were eaten through, in a straight line, by this insect. The beetle is very small, and almost black. The head is particularly small ; and from the prominence of the thorax, looks as if it were covered with a hood. The *Anobium puniceum*, fig. 150, attacks dried objects of natural history, and all kinds of bread and biscuits, particularly sailors' biscuits, in which its maggots frequently abound. In collections of insects, it

first consumes the interior ; when the larva assails birds, it is generally the feet that it devours first ; and in plants, the stem or ligneous part. The larva is a small white maggot, the body of which is wrinkled, consisting of several segments covered with fine hairs ; its jaws are strong and horny, and of a dark brown. The pupa is white, but so transparent, that every part of the perfect insect may be seen through it. The beetle itself is of a reddish-brown colour, and covered with fine hairs.



fig. 150.

Anobium puniceum,
magnified.

The *Bacon-beetle* (*Dermestes lardarius*) is one whose ravages are very extensive. The larva of this insect is particularly partial to the skin of any animal that falls in its way ; and consequently it destroys stuffed animals and birds in collections of natural history, whenever it can gain access to them. It attacks hams and bacon for their skin ; but as it is very gluttonous, it extends its ravages to the flesh. The larva is long and slender ; its body, being nearly round, consists of thirteen segments, blackish-brown in the middle, and white at the edge. The whole body is furnished with bristle-shaped reddish-brown hairs. The beetle is black at the head and tail, with an ash-grey band across the back, having three black spots on each wing-case. Sometimes this band takes a yellowish tinge ; and the whole beetle is furnished here and there with tufts of ash-grey or yellowish-grey hairs. The beetle is most destructive in spring. Their larvæ are very seldom seen, as they conceal themselves in the bodies they attack ; and their presence can only be guessed by finding occasionally their cast-off skins, as they change their skins several times while in their larva state. Whenever, therefore, little rolls of black skin are found near where ham or bacon is kept, or in cases containing objects of natural history, it is probable this beetle has attacked them. The small scales covering many species of *Dermestes*, as well as their hairs, are very beautiful microscopic objects.

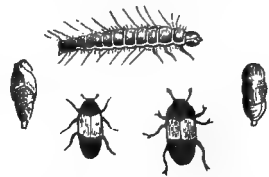

fig. 151. *Dermestes lardarius*.
Larva, pupa, and imago.

The *Heteroptera*, or *Bugs*, form two principal groups, distinguished by their structure and habits,—the *Hydrocores*, or *Water-bugs*, and the *Geocores*, or *Land-bugs*. The latter never possess wings : the disagreeable *Bed-bug* (*Cimex lectularius*) and its allies belong to this group. The former are at once recognisable by the small size of their antennæ, which are composed of three or four short joints,

and are concealed beneath the eyes. Of these, the *Notonectida* are distinguished by their broad, rounded head, which occupies the whole width of the front of the body. They swim rapidly about in the water, with their bellies directed upwards, rowing themselves along by means of their flattened hinder legs, which are extended on each side of them like oars. Hence the *Notonecta* is generally known as the *boat-fly*. They carry the air required for their respiration in a space left for this purpose between the wings and the back. They are very active and predaceous animals, and when captured some of them often inflict a painful wound with their powerful rostrum. Several species may be met with in almost any piece of water. In the second group, the *Nepina*, the head is small and triangular, and generally considerably narrower than the thorax. Their legs are generally less distinctly formed for swimming than in the preceding group; but the anterior pair are converted into powerful raptorial organs.

The *Nepa cinerea* is a British example of this group, to be met with in every pond. These insects respire by means of the filaments of the caudal extremity, which they place at the surface of the water, the only available stigmata being situated at the base of these filaments.

The *Dytiscus*, the principal genus of this tribe, is common in fresh and placid waters. Its larva, represented in fig. 92, feeds upon other aquatic larvæ, such as those of gnats, dragon-flies, &c.

In the *Gyrinus*, *Whirligigs*, we have combined contrivances to facilitate the creature's movements in the element it frequents. The hinder legs are converted into a pair of oars of remarkable efficiency, the point of their connection with the body being adapted with great precision to insure the most effectual application of the propelling power; and as they are struck out behind in the act of swimming, there is a membranous expansion, which enables the insect to move about with great rapidity; while, on their being drawn back towards the body, the membrane closes up again, and thus offers but a small resistance to the water (fig. 152). If the insect wishes to remain below the surface of the water, he employs the small hooks at the extremity of the leg, for the purpose of adhering to the roots or stem of some aquatic plant. The eyes are not the least curious part of the merry little creature; the upper portions of them, being fitted for seeing in the air, are placed on the upper part of the head; whilst the other portions, fitted for seeing in water, are placed in the lower part, a thin division separating the two.

To the *Orthoptera* belong the *Locustina*, *Gryllina*, and the *Achetina*, all herbivorous insects. The first is represented by our well-known grass-

hopper: the second, the *Gryllina*, appear to frequent trees and shrubs more than the other tribes, the members of which generally keep among herbage; and, in accordance with this habit, many of the

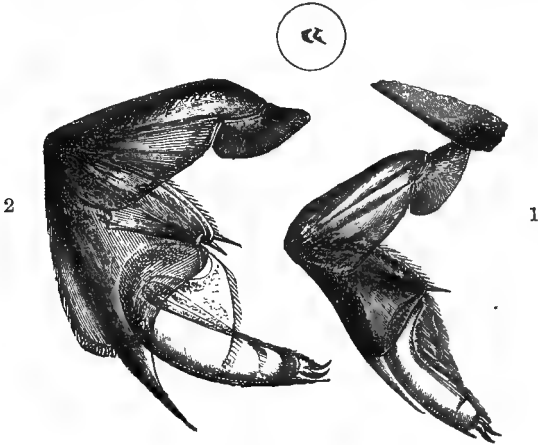

fig. 152.

1. Leg of *Gryllus*. 2 Leg with paddle expanded.

In the small circle the object is represented of the natural size.

exotic species have wing-cases, which present the most perfect resemblance to leaves both in colour and veining. There are several British species, one of which (the *Gryllus viridissimus*, Grasshopper,) is very common in marshy situations.

Of the tribe *Achetina*, the common *Cricket* (*Acheta domestica*), fig. 154, the noisy little denizen of our kitchen-hearths, serves as an example. These insects have the antennæ slender and tapering, and often considerably longer than the body. They agree with the *Gryllina* in the structure of the singing apparatus; but the wings, instead of being arranged in the form of a high pitched roof, are laid flat upon the back. Some of them possess ocelli, whilst others are destitute of those organs. The hinder wings are very long, and folded up in such a manner that they project beyond the wing-cases in the form of a pair of tapering tails; the abdomen is also furnished, in both sexes, with a pair of pilose, bristle-shaped, caudal appendages, and in the female with a long, slender ovipositor, composed of two filaments, laid side by side, and somewhat thickened at the tip. The tarsi are three-jointed.

The horny covering and muscular apparatus under the wing-case



fig. 153.

Lizard. "Sillereups," *Polyommatus carydon*, Chalk-hill blue butterfly. *Gryllus viridissimus*, Grasshopper. *Polyommatus Adonis*, Clifden blue butterfly; and flowering plants found during the month of July.

of the cricket offer many curious points for microscopic examination. The cricket has two wings, which are covered with wing-cases of a leathery consistency, near the base of which is a horny ridge having transverse furrows, exactly resembling a rasp or file; this the cricket rubs against its body with

fig. 154. *The Cricket.*

a very brisk motion, whereby it produces its sound. It has been remarked that the chirp becomes louder in proportion as the heat increases; and it is extremely difficult to silence the cricket in any way but by putting out the fire near which the little animal is chirping.

In the order *Thysanoura* there is a remarkable diversity of structure. They undergo no metamorphosis, and have no wings. The

order contains two families, the *Poduridæ*, or *Spring-tails*, and the *Lepismidæ*.

In the former, the caudal appendage has the form of a forked tail (*Podura*, fig. 155), which is bent under the animal

fig. 155. *Podura plumbea.*

when not in use, and by its sudden extension causes the animal to spring, often to a great distance in comparison with

its size. The body is covered with numerous minute scales, often of a beautiful silvery or pearly lustre, and curiously striated. Some species may be found jumping about on the surface of the water, whilst others are met with in profusion upon snow and ice.

The *Lepismidæ* have a spindle-shaped body, usually covered with silvery scales, and furnished along the sides of the abdomen with a series of appendages or false feet, besides several long-jointed, bristle-like organs at its extremity. The head is concealed under the prothorax; the eyes are usually compound, and frequently occupy the whole of the head. The antennæ are very long, and composed of numerous joints; and the maxillary palpi, which consist of from five to seven joints, are very conspicuous. These insects generally inhabit moist places. The most common species, *Lepisma saccharina*, is frequently found about houses, especially in sash-frames, or old sugar-casks, from which it derives its name. The scales from these little insects have always been favourite objects with microscopists, and are generally used to test the power of *penetration* and *definition* of the instrument itself.

Podura plumbea, or *Lead-colour Springtail*, are usually found in wine-cellars, amongst the sawdust, leaping about like fleas, and are

therefore difficult to take. The following is generally the plan resorted to : sprinkle a little oatmeal on a piece of black paper near their haunts ; after a few hours, remove it carefully to a large glazed basin, so that when they leap from the paper, as they will when brought to the light, they may fall into the basin, and thus become separated from the meal. The best way of separating the very fine scales from their bodies has been previously explained (See page 44). The markings cannot be seen with a lower power than a quarter-inch object-glass. Under a power of 500 diameters, the surface appears to be covered with extremely delicate wedge-shaped dots or scales, as seen at No. 5 a, Plate X. The smaller scales are much more difficult to resolve than the larger ; and they form a good test of the defining power of a 1-8th or 1-12th object-glass, No 8, a portion of a large scale of *Lepisma saccharina*, showing the longitudinal markings.

The family *Aphaniptera*, in which the metamorphosis is what is termed complete—the larva, pupa, and imago being very distinct in their appearance : the well-known flea is the best example of this small group. By many recent authors these insects have been arranged with the *Diptera*, which would appear to be incorrect, as they differ in many particulars. The external covering of the flea (fig. 156) is a horny case, formed of very distinct segments ; those of the thorax being always disunited. Although apparently apterous, the flea has the rudiments of four wings, in the form of horny plates on the sides of the thoracic segments. Its mouth consists of a pair of sword-shaped, finely-serrated mandibles, which, with a sharp, needle-like organ, appears to constitute the formidable weapon with which it pierces the skin of its victim.

The neck is long, the body covered over with scales, the edges of which are set with short spikes or hairs ; from its head project a pair of antennæ, or horns, its proboscis, and a pair of sharp lancets, with which it penetrates the skin. On each side of the head a large sharp eye is placed. It has six many-jointed powerful legs, terminating in two sharp-hooked claws, which are so constructed, that they can be folded up, as it were, and when it leaps it springs them out ; so that its whole strength is excited at the same moment. The female flea, fig. 156, lays a great number of eggs, sticking them together with a glutinous matter ; those of fleas infesting the dog or cat are made fast to the roots of the hairs ; in four days' time the eggs are hatched, and a small white worm or grub is seen crawling about, and feeding most actively. No. 4, fig. 157, is a magnified view of one ; it is covered with short hairs, which prevent its being easily dislodged. After remaining in this state about nine or ten days, it assumes the

pupa form, which it retains for four days ; and in nine days more it becomes a perfect flea. The head of the flea found in the cat (No. 3, fig. 157) is seen to be very different in its form from that of the

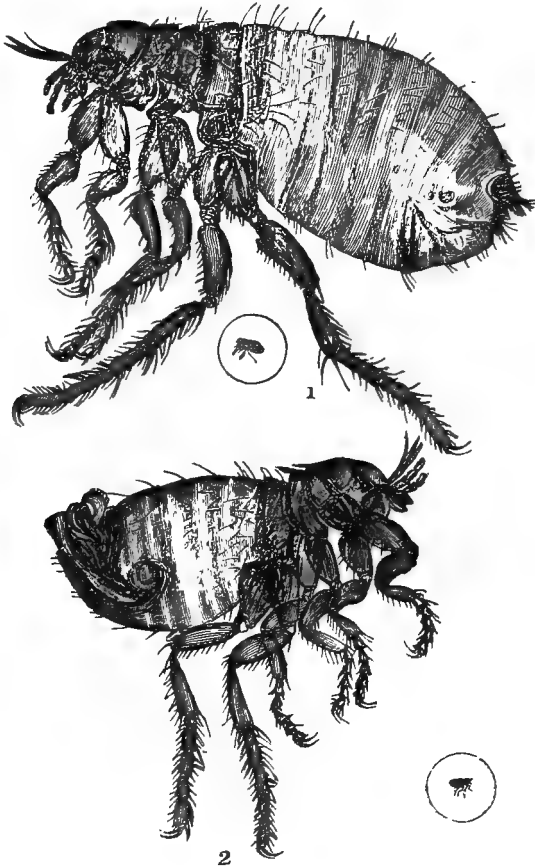

fig. 156.

1. Female Flea. 2. Male Flea.

The small circles enclose the little animals of the natural size.

human flea (fig. 156). Its jaws are supplied with formidable hooklets, and from the first and second joints behind the head project short and strong spines ; these are, no doubt, for the purpose of enabling it to maintain a firmer and better hold on the animal.

ACARINA—PARASITES.

Nearly all the animals that we include in this order, of which the common Mites are the best known examples, are recognisable at the first glance by the form of the body, which usually constitutes a roundish or oval mass, without any trace of segmentation. They are mostly parasitic animals, furnished with a proboscis containing a pair of sharp spines, which serve for wounding their prey, and bearing a palpus on each side. The proboscis is jointed and retractile. Sometimes it is furnished with a swollen base, which has been taken for a head. The eyes, which are often wanting in the parasitic forms, are two in number when present, and are placed on each side of the anterior portion of the body.

The *Acarina* are generally oviparous; a few bear living young. The young generally possess only three pairs of feet; the fourth pair not making their appearance until after the first moult.

Parasites infest the skin, lurk among the hairs and feathers of quadrupeds and birds, and even of other insect races, whence they draw an abundant supply of support for their singular mode of existence. Mr. Henry Denny has figured and described a greater number of parasitic insects in his *Monographia Anoplurorum* than any previous observer. He says, "that the opinion entertained of each animal having its peculiar parasite, is not entirely borne out by facts; nevertheless, that those infesting the quadruped will not be found in the bird, being almost always confined to animals of the same species, or of similar habits. For instance, the *Docophorus icteroides* is to be found on nearly every species of duck. The *Neimus obscurus* infests several species of sandpipers, godwits, &c.; the *Neimus rufus*, the hawks and falcons; the *Docophorus lari*, all the gulls. In quadrupeds it is rather more doubtful, as they are frequently transferred by association; for instance, the *Trichodectes scalaris* has been found upon both the ox and the ass feeding in the same stall. The *Hæmatopinus piliferus*, infesting dogs, have been found in swarms upon the ferret. The *Pediculus*, besides being found on man, is also found on the *Quadrumania*, *Rodentia*, *Carnivora*, *Pachydermata*, and the *Ruminantia*. We include in this group both *Acari* and *Parasites*; though from the former having eight legs, and the latter six only, they are not generally admitted as belonging to the same class of insect life.

Respiration goes on simply through the skin in *Acarus* and *Sarcoptes*; while in *Gamasus*, *Cheyletus*, and various kinds with pincer-

shaped mandibles, there is a complete system of tracheæ with spiracles, as in true insects. Besides these two there is an intermediate plan of respiration not known before, combining both the other modes, in which inspiration takes place through the skin, and expiration through a system of tracheæ, which have their outlet above the insertion of the mandibles. *Trombidium* is an example in which a latticed aperture at the root of the mandibles forms the anterior outlet of two large air-pipes running from the hinder end to the front, each subdivided into a tuft of numerous unbranched simple tracheæ. Besides these, there is under the skin a round meshed network of a transparent and seemingly homogeneous substance, resembling the respiratory network under the skin of certain *Trematoda*.

“The importance of a thorough examination of these microscopic pests is at once evident, in the fact that the type of the family to which the whole of them belong is the noisome parasite of the human subject; that another, as yet undetermined form of the same tribe, is thought by some to be connected with one of the most fatal ailments of our frame—dysentery; that two distinct *Sarcoptes*, yet undescribed, affect the horse and sheep; and that even the common sparrow, our little pet canary-bird, and even the useful bee, do not escape the ravages of one of the family.

When, therefore, we reflect on the ailments which these produce, and on the diminutive size of the creature which in its effects is so destructive to other tribes; and bear in mind that this mere speck, this particle of dust, is organised for all its purposes as completely as the most perfect of any of the whole sub-kingdom to which it belongs, even to the flexor, the extensor, and the rotator muscles of its truly atomic limbs; while the entire body of the creature, when first produced, measures scarcely more than the sixteen-thousandth of an inch in length; and then call to mind that the mere foot of the *Dinornis*, or of the *Palapteryx*, the ancient colossal bird of the antipodes, measures, as shown by Professor Owen, more than seven hundred and fifty times the whole size of this little body,—who can but feel astonished at this range of creation? Who can but feel that the study of natural history, not as the amusement of an hour, but as a sober contemplation, must tend to exalt as well as to extend the human intellect, and that the most microscopic atom of organised life, considered as part of the world, is as deserving of our fullest attention as the most gigantic?***

The *Louse* (Plate XI. No. 1). Whenever wretchedness, disease, and

* George Newport, Esq., F.R.S., “On a new genus of the family *Chalcididæ*, found in the nest of the bee.”—*Linnean Society’s Transactions*, 1853,

hunger seize upon mankind, this horrid parasite seldom fails to appear in the train of such calamities, and to increase in proportion as neglect of personal cleanliness engenders loathsome disease. When examined under the microscope, our disgust of it is in no way diminished. In the

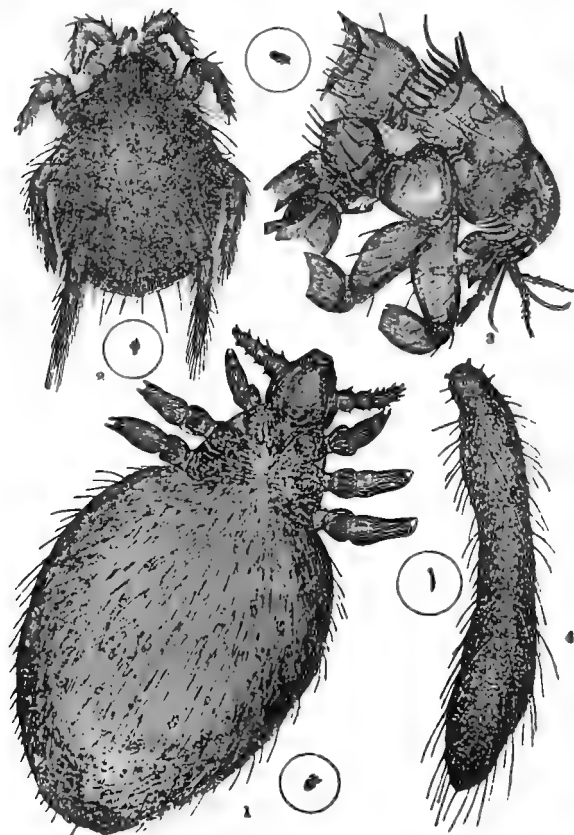

fig. 157.

1. Dog's Parasite. 2. Rat Acarus. 3. Head of Cat-Flea. 4. Larva or grub of Flea.
The life size of each is shown within the small circles.

head may be distinguished two large eyes, near to which are situated the antennæ; the front of the head is long, and somewhat tapering off to form a snout, which serves as a sheath to the proboscis and the instrument of torture with which it pierces the flesh and draws the blood. To the fore part of its body six legs are affixed, having each

five joints, terminated by two unequal hooks ; these, with the other portions, are covered with short hairs. Around the outer margin of the body may be seen small circular dots, the breathing apertures, with which all this class of animals are provided, rendering them very tenacious of life, and difficult to kill. There is another louse, rather differing in its characteristics from this, formed about the body of the very poor and dirty, called the body or crab-louse. Leeuwenhoek carried his researches on the habits of these insects further than most investigators, even allowing his zeal to overcome his disgust for such creatures as the louse. In describing its mode of taking food, &c., he observes : “ In my experiments, although I had at one time several on my hand drawing blood, yet I very rarely felt any pain from their punctures ; which is not to be wondered at, when we consider the excessive slenderness of the piercer ; for, upon comparing this with a hair taken from the back of my hand, I judged, from the most accurate computation I could form by the microscope, that the hair was seven hundred times the size of this incredible slender piercer, which consequently by its punctures must excite little or no pain, unless it happens to touch a nerve. Hence I have been induced to think that the pain or uneasiness those persons suffer who are infested by these creatures, is not so much produced from the piercer as from a real sting, which the male louse carries in the hind part of his body, and uses as a weapon of defence.” He found from experiments made to ascertain the increase of these vermin, that from two females he obtained in eight weeks the incredible number of 10,000 eggs.

The *Itch-insect*, *Sarcoptes scabiei* (Plate XI. No. 3, magnified 350 diameters). Dr. Bononio made out the true character of the very troublesome disease known as the itch. Upon examining one of the pustules, or little bladders, from between the fingers, with the points of very fine needles, under the microscope, he perceived a very small animal, very nimble in its motion, covered with short hairs, having a formidable head with a pair of strong mandibles or cutting jaws, and eight legs, from the extremities of which are appended remarkable feet, each provided with a sucker, by means of which it no doubt sucks or draws its way beneath the skin, having first cut out a small section with its mandibles ; here the insects form a nest, lay eggs, and multiply rapidly, being most difficult to dislodge.

To find the itch-insect, the operator must examine carefully the parts surrounding each pustule, and he will see a red line or spot communicating with it ; this part, and not the pustule, must be probed with a fine-pointed instrument ; the operator must not be disappointed

by repeated failures. As it is often very difficult to detect the haunts of the insect, an eye-magnifier will greatly assist.

Dr. Bourguignon has of late bestowed much time in studying the habits of this troublesome parasite. To arrive at this knowledge, the Doctor had recourse to a peculiar kind of movable microscope, which enabled him to observe it under the skin of the diseased person. The microscope is composed of the frame of an ordinary instrument, the optical and essential parts of which have been raised from the socket that supported it, and articulated to a movable knee at the extremity of a lever. The rays of light from a lamp or candle are brought to a brilliant focus by means of the condensing or bull's-eye lens; which focus is directed upon the chosen point of observation.

He then saw that the feet were armed with suckers, which enabled it to fasten itself in the furrows under the skin, aided by the small bristles; and being likewise covered by the same in various parts of the body, it more firmly fixes itself there; and with its terrible mandibles it accomplishes its destructive mission. It has no eyes; but in the moment of danger it quickly draws in its head and feet, somewhat resembling the tortoise; its march is precisely that of the tortoise. It usually lays sixteen eggs, which are carefully deposited in furrows under the skin, and ranged in pairs; these are hatched in about ten days.

No. 4, Plate XI., *Demodex folliculorum*, is another very remarkable parasite found beneath the skin of man: it may be obtained from a spot where the sebaceous follicles, or fat glands, are very abundant; such as the forehead, the side of the nose, and the angles between the nose and lip; if the part where a little black spot or a pustule is seen be squeezed rather hard, the oily matter accumulated will be forced out in the globular form and various stages of growth, as represented in the drawing; if this be laid on a glass-slide, and a small quantity of oil be added to it, so as to separate the harder portions, the little insect in all probability will be floated out; after the addition of more oil, it may be taken away from the oily matter by means of a fine-pointed sable pencil-brush, and transferred to a clean slide, where it may be covered over with thin glass, and mounted in the usual way.

The *Cheese-mite*, *Acarus domesticus* (Plate XI. No. 2), has a peculiar elongation of its snout, forming strong, cutting, dart-shaped mandibles, which can be advanced separately or together. Their legs are brown. All indeed present a great diversity of form, size, and colour; and in the cheese-mite we observe the peculiar adaptation of form and apparatus necessary for cutting its way into or through the food on which it is destined

to exist. Mites multiply very rapidly; they are hatched from eggs in about eight days; and if deprived of food, will kill and eat each other very greedily. They infest almost the whole of our dried articles of food. The parts of the mouth and legs of these acari can be best made out by crushing the animal upon a glass slide, with a thin glass cover; then washing away the exuded substance with water—sometimes a hot solution of potash is requisite, with the subsequent addition of acetic acid and washing; after drying, mount them in Canada balsam.

The *Acarus sacchari*, or *Sugar Insect*.—There is very commonly present in the more impure kinds of sugar a beetle-like animalcule of the genus *Acarus*. The discovery of the very general presence of this acarus rests, we believe, entirely with Dr. Hassall.

The sugar acarus approaches somewhat, in organisation and habits, the louse and the itch-insect; it is in size so considerable, that it is plainly visible to the unaided sight. When present in sugar, it may always be detected by the following proceeding: two or three drachms or teaspoonfuls of sugar should be dissolved in a large wine-glass of tepid water, and the solution allowed to remain at rest for an hour or so; at the end of that time the animalcules will be found, some on the surface of the liquid, some adhering to the sides of the glass, and



fig. 158.

Ova and young of the *Acarus sacchari*, or *Sugar-insect*, after Hassall, magnified 200 diameters.

others at the bottom, mixed up with the copious and dark sediment, formed of fragments of cane, woody fibre, grit, dirt, and starch granules, which usually subsides on the solution of even a small quantity of sugar in water.

We will now proceed to give a description of the acarus in question,

and observe, in the first place, that the whole of its development may be clearly traced out in almost every sample of brown sugar. The

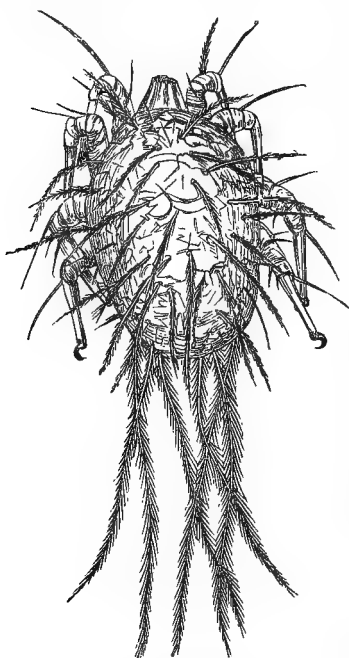

fig. 159. *Acarus farinae*, or *Meal-mite*, magnified 250 diameters.

Acarus sacchari is first visible as a rounded body, or egg; this gradually enlarges, and becomes elongated and cylindrical, until it is about twice as long as broad; after a time, from the sides and one extremity of this ovum the legs and proboscis begin to protrude. These stages of the development of the acarus are exhibited in fig. 158.

The Acarus farinae, or *Flour-mite*.—This is of occasional occurrence in flour, but is never present unless it has become damaged. Any flour, therefore, containing the insect in question is in a state unfit for consumption. We believe that it is found, more frequently in the flour of the *Leguminosae* than that of the *Gramineae*.

This acarus differs considerably in structure from the sugar-mite, and particularly in its pennate setae.

Dr. Burnett established to his satisfaction the following facts: "1.

That although there are single species of parasites peculiar to particular



fig. 160.

Larva of Parasite of Hornbill.



fig. 161.

1. *Hippobosca Hirundinis*.

2. *Nirmis*, parasites infesting the Swallow.

animals, there are others which are found on different species of the same genus ; as is the case in the parasites living on birds of the genus *Larus* (gulls), and the diurnal birds of prey. 2. The parasites of the human body confine themselves strictly to particular regions ; when they are found elsewhere, it is the result of accident. Thus, the *Pedi-*

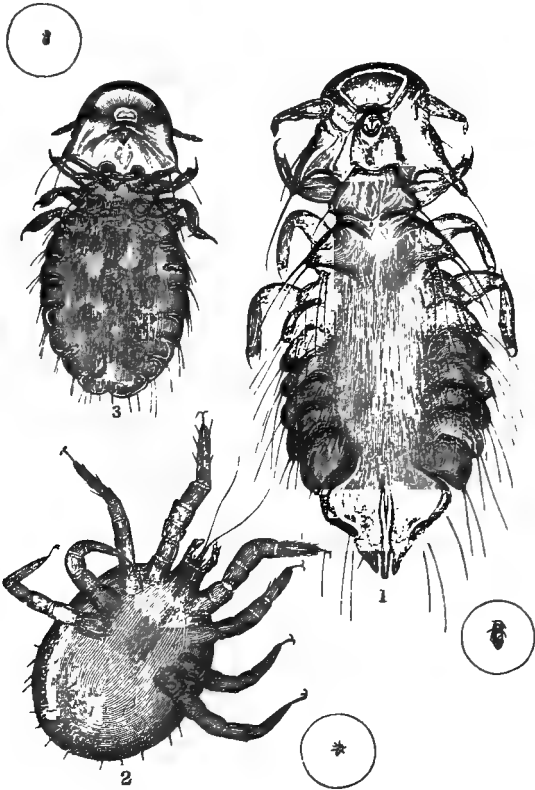

fig. 162.

1. Parasite of Turkey. 2. *Acarus* of common Fowl, under surface. 3. Parasite of Pheasant. The small circles enclose each object about life size.

culi capitis live in the head ; *P. vestimenti* upon the surface of the body ; the *P. tabescentium* on the bodies of those dying of marasmus ; and the *P. inguinalis* about the groins, armpits, mouth, and eyes." From an examination of the structure of these animals, Dr. Burnett is of opinion that they should be placed in an order by themselves, closely allied to *Insecta* ; the mandibulate parasites occupying the highest, and

the haustellate the lowest position in the order : thus confirming to some extent the observations made by Mr. Denny.

There is a remarkable species of acarus described by Dr. Robins, found spinning a white silky web on the base of the sparrow's thigh, or on the fore-part of its body ; on raising this delicate web, you perceive that it is filled with minute eggs, from which the young issue, being in due time hatched by the warmth of the body it is destined to

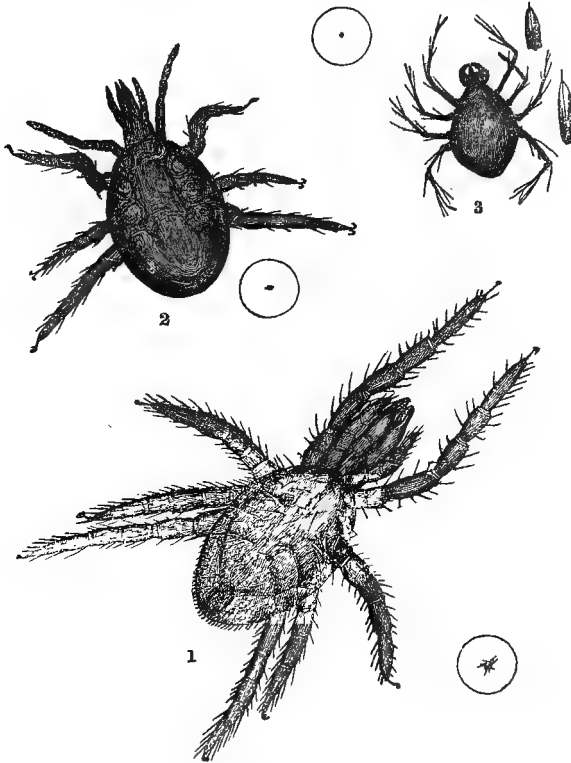

fig. 163.

1. Acarus of Beetle. 2. Acarus of Fly. 3. Acarus of Clothes-Moth.
The circles enclose the objects about life size.

annoy. In fig. 160 are seen some eggs of a parasite infesting the horn-bill ; they were glued to the feathers near the head of the bird. The insect is nearly ready to leave the egg. Another, curiously enough, selects the pulmonic orifice of the snail : when the animal dilates this orifice, for the purpose of allowing the air to penetrate its respiratory ca-

vity, the female acarus slips through it, lays her eggs in the folds of the mucous membrane, where they are gradually developed ; issuing forth from the egg, they select some portion of the snail's body upon which to feed and perfect their growth.

The *Ixodidae* are furnished with a powerful rostrum, armed with recurved spines, with which they pierce the skin of the unfortunate

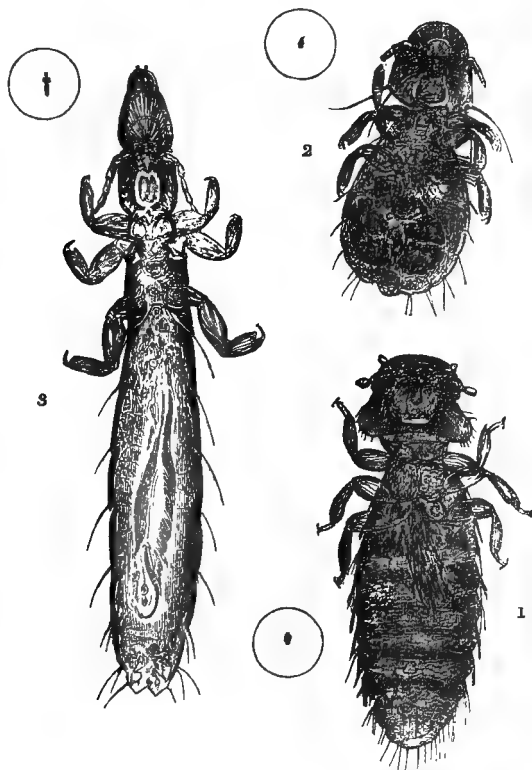

fig. 164.

1. Parasite of Eagle. 2. Parasite of Vulture. 3. Parasite of Pigeon.

The circles enclose the objects of about life size.

animals upon whose blood they live. So firmly does this anchor-like organ retain its hold, that if the parasite be pulled away it usually carries a portion of the skin of its victim with it. These creatures live upon a great variety of animals. The dog is very liable to their attacks, and many species attach themselves exclusively to serpents and

other reptiles. The animal known as the Harvest-bug, which is often so troublesome in summer and autumn, also belongs to this group. The *Gamaside*, which are furnished with a sucking apparatus very similar to that of the *Ixodidae*, usually attach themselves to the bodies of beetles; the common Dung-beetles (*Geotrupes*) may often be found with the lower surface nearly covered with them.

The remainder generally lead a more active life, and are always furnished with eyes. One family, the *Hydrachnidae*, or *Water-mites*, inhabit the water, where they swim about with considerable rapidity by means of their fringed legs. In their young state, they attach themselves parasitically to aquatic insects; they then possess only six legs, and pass through a quiescent or pupa state before acquiring the

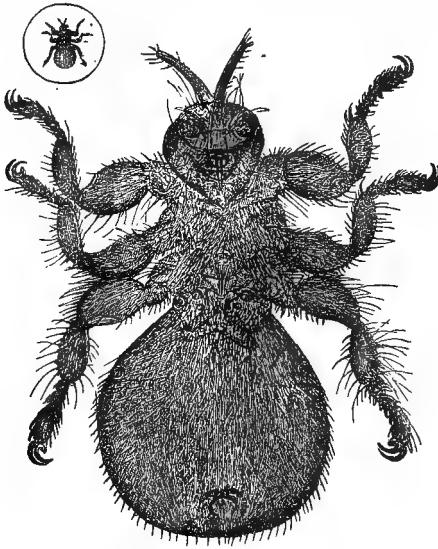

fig. 165. The *Sheep-tick*. The small circle shows one of life size.

fourth pair. The *Oribatidae*—which, unlike the other *Acarina*, live upon vegetable matter, principally the leaves of mosses,—are covered with a hard and very brittle skin, and have the mouth adapted for biting. The *Bdellidae*, which live amongst damp moss, have the body divided apparently into two parts by a constriction, and the rostrum and palpi very long; whilst the *Trombididae*, of which the little Scarlet Mite so often seen in gardens is an example, have the palpi converted into little raptorial organs.

Another family of parasites are commonly met with in the bodies of fishes, attaching themselves to the branchia, to the soft skin under the fins, or to the eyes, much to the annoyance of the unfortunate victim. Some of those found on fresh-water fish are sufficiently transparent to show the circulation of their fluids—a most interesting sight.

The water-snail, *Limneus*, is infested with a parasite of the family *Clepsinidae*, which attaches itself by a series of hooklets and bristles to such parts of the body and mantle as give a secure lodgment to it; they look like little tufts of thread hanging from the sides of the animal, without its having the power to dislodge them.*

We have before referred to Swammerdam's careful dissections under the microscope. In no department of nature did he bestow more care than in his many examinations of insects. He first killed them by immersion in spirits of wine and water, or in spirits of turpentine; preserving them for some time in the same fluid, to give firmness, and render his dissections more easy. When he had divided the insect transversely with his fine scissors, he particularly noted the relative position of the various parts, and then proceeded to remove the viscera very cautiously with fine-pointed instruments, carefully washing away all the fat and other matters with fine camels'-hair pencils; or, by putting the whole into water and then shaking them gently, he separated the air-vessels, or trachæa, in a perfect state from the other parts. At other times he made use of a very fine syringe to inject water into and thoroughly cleanse them; after which they were distended by blowing in air, and hung up to dry. He is said to have often succeeded by immersing insects in balsam. Again, he frequently made punctures in some insects with a fine needle, and after squeezing out all their moisture through the holes made in this manner, he filled them with air by means of very slender glass tubes, then dried them in the shade, and afterwards anointed them with oil of spike in which a little resin had been dissolved: those prepared in this way retained their forms and kept well for years. Swammerdam discovered that the fat of all insects was perfectly soluble in spirit of turpentine; after steeping them in it, he washed them well in water, and was thus enabled to show the viscera plainly. He frequently spent whole days in thus cleansing a single caterpillar of its fat, in order to discover the structure of its heart. His singular mode of stripping off the skin of the caterpillar, just as it was on the point of spinning its cone, was

* A very interesting account of the parasite tribes is given in Rhedi's *Treatise de Generatione Insectorum*, and in H. Denny's *Monographia Anoplurorum Britannicæ*, Bohn, London, 1842.

effected by taking hold of its thread and letting it drop into scalding-water, and then suddenly withdrawing it: the skin easily peels off. After this it was put into distilled vinegar and spirits of wine mixed in equal proportions; this gave a firmness to the parts, and the exuvia or skin readily separated; the pupa is then seen to be enclosed, and the butterfly traced in the pupa.

Parasites may be quickly killed by immersing them in spirits of wine or spirits of turpentine; in a short time take them out, and dry them; if transparent, they may be at once mounted in glycerine or Goadby's solution: if opaque, they must be mounted in Canada balsam.

TRANSFORMATION OF INSECTS.

The metamorphoses of the insect race offer some of the most curious and wonderful of nature's phenomena for contemplation. "We see," says an old author, "some of these creatures crawl for a time as helpless worms upon the earth, like ourselves; they then retire into a covering, which answers the end of a coffin or a sepulchre, wherein they are invisibly transformed, and come forth in glorious array, with wings and painted plumes, more like the inhabitants of the heavens than such worms as they were in their former state. This transformation is so striking and pleasant an emblem of the present, intermediate, and glorified state of man, that people of the most remote antiquity, when they buried their dead, embalmed and enclosed them in an artificial covering, so figured and painted as to resemble the caterpillar in the intermediate state; and as Joseph was the first we read of that was embalmed in Egypt, where this custom prevailed, it was probably of Hebrew original."

Faint and imperfect symbol though it be, yet it may perchance offer a glimpse of the metamorphosis awaiting our own frail bodies. Between the highest and lowest degree of corporeal and spiritual perfection, that there are many intermediate degrees, the result of which is one universal chain of being, no one can for a moment gainsay. Thus the angel Raphael is made to say in Milton's *Paradise Lost*:

———"What surmounts the reach
Of human sense, I shall delineate so,
By likening spiritual to corporeal forms,
As may express them best: though *what if earth*
Be but the shadow of heaven, and things therein
Each to other like, more than on earth is thought!"

The great class of insects, which furnishes four-fifths of the existing

PLATE XII.

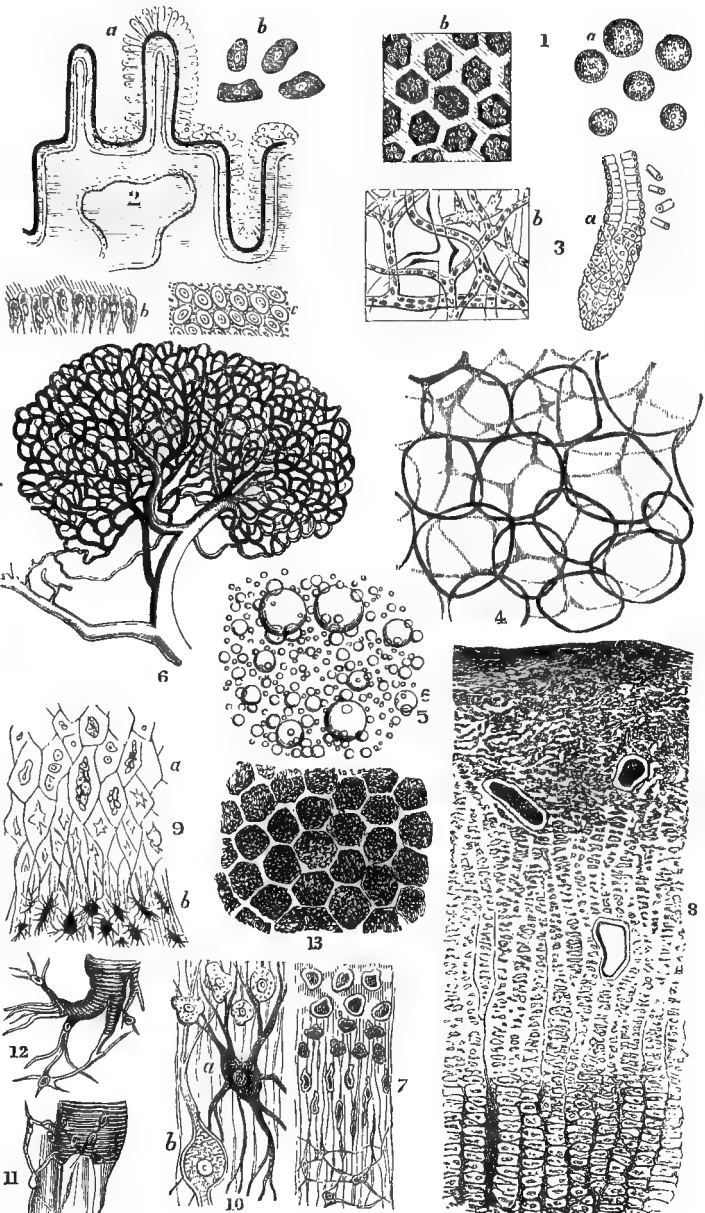

ANIMAL STRUCTURES.

species of the animal kingdom, has two chief divisions. In the one, the Ametabola, we have an imperfect, in the other, the Metabola, a perfect metamorphosis; that is, in the former there is no quiescent pupa state, and the metamorphosis is accompanied by no striking change of form; in the latter there is an inactive pupa that takes no nourishment, and so great a change of form, that only by watching the progress of the metamorphosis can we recognise the pupa and the imago as belonging to the same animal. The Metabola correspond, as it were, to the flowering plants; the Ametabola to the Cryptogamia. It is well worthy of remark, that among plants the Cryptogamia, and among insects the Ametabola, first appeared on our earth. The most ancient forests, composed of tree-ferns, club-mosses, and equisetæ, were inhabited by *Locustæ* and *Blattæ*, the first insects. "There have not yet been found," says Professor Heer, in his *History of Insects*, "in the carboniferous and triassic rocks any traces of insects that can be with certainty referred to any of the other insect orders."

The degree of this metamorphosis is, however, very different in different groups of insects. In its most *complete* form, as exemplified in the butterflies, moths, beetles, and many other insects, the metamorphosis takes place in three very distinct stages. In the first, which is called the *larva* state, the insect has the form of a grub, sometimes furnished with feet, sometimes destitute of those organs. Different forms of insects in this state are popularly known as caterpillars, grubs, and maggots. During this period of its existence the whole business of the insect is eating, which it usually does most voraciously, changing its skin repeatedly to allow for the rapid increase in its bulk; and after remaining in this form for a certain time, which varies greatly in different species, it passes to the second period of its existence, in which it is denominated a *pupa*. In this condition the insect is perfectly quiescent, neither eating nor moving. It is sometimes completely enclosed in a horny case, in which the position of the limbs of the future insect is indicated by ridges and prominences; sometimes covered with a case of a softer consistence, which fits closely round the limbs, as well as the body, thus leaving the former a certain amount of freedom. Pupæ of this description are sometimes enclosed within the dried larva skin, which then forms a horny case for the protection of its tender and helpless inmate. After lying in this manner, with scarcely a sign of life, for a longer or shorter period, the insect, arrived at maturity, bursts from its prison in the full enjoyment of all its faculties. It is then said to be in the *imago* or perfect state. This metamorphosis is one of the most remarkable phenomena in the history of insects, and was long

regarded as perhaps the most marvellous thing in nature ; although recent researches have shown that the history of many of the lower animals presents us with circumstances equally if not more wonderful, nevertheless the metamorphosis of the higher insects is a phenomenon which cannot fail to arrest our attention. To see the same animal appearing first as a soft worm-like creature, crawling slowly along, and devouring every thing that comes in its way, and then, after an intermediate period of death-like repose, emerging from its quiescent state, furnished with wings, adorned with brilliant colours, and confined in its choice of food to the most delicate fluids of the vegetable kingdom, is a spectacle that must be regarded with the highest interest ; especially when we remember that these dissimilar creatures are all composed of the same elements, and that the principal organs of the adult animal were in a manner shadowed out in all its previous stages.

Nor is the singularity of their natural history the only claim that these insects have upon our attention. Lowly as they may be, in point of organisation, there are few insects that exceed them in commercial importance. The finest red dyes known to our manufacturers are derived from these creatures. The *Lecanium Ilicis*, which inhabits the *Ilex* or evergreen oak of the countries round the Mediterranean, was employed for this purpose by the ancient Greeks and Romans, as it is still by the Arabs ; and until the introduction of the Mexican cochineal, another species, the *Porphyrophora polonica*, which lives on the roots of the *Scleranthus perennis* in Central Europe, was much used for the same purpose. The Mexican cochineal, which has driven the others out of the field, is also a species belonging to this group, the *Coccus cacti* (fig. 139), which lives as a parasite upon the Nopal, or *Cactus opuntia*—a plant very common in Central America. The commercial importance of this insect is shown by the fact, that in 1850 no less than 2,514,512 lbs. of cochineal were imported into Great Britain alone (value about 7s. per lb.) ; and as about 70,000 insects are supposed to be contained in a pound of this substance, we may form some idea of the numbers annually destroyed. For many years the cultivation of cochineal was entirely confined to Mexico ; but the insect has lately been introduced into Spain and the French possessions in Africa, with some prospect of success. A fourth species, of great importance, is the lac insect (*Coccus lacca*), an inhabitant of the East Indies, where it feeds upon the Banian-tree (*Ficus religiosa*), and some other trees. To this insect we are indebted, not only for the dye-stuffs known as *lac-dye* and *lac-lake*, of which upwards of 18,000 cwts. were imported in 1850, but also for the well-known substance called *shell-lac*, so

much used in the preparation of sealing-wax and varnishes. In all these cases it is only the female insects that yield the colouring matter.

Of the secretions peculiar to insects *silk* may well be regarded as the most valuable, since it has become nearly as essential to our own purposes as it is to the economy of the producers of it. The vessels which secrete it consist of two tubes; these unite at the extremity, and open into a small perforated filiform organ, placed between the palpi on the under lip; this is termed the *spinnaret*, and the size of its aperture determines the thickness of the thread. The fluid, before it comes in contact with the air, is viscous and transparent in the young larva, but thick and opaque in the mature ones. It is found, by chemical analysis, to be chiefly composed of Bombic acid, a gummy matter, a portion of a substance resembling wax, and a little colouring-matter. It may be placed in boiling water without undergoing any change; the strongest acids are required to dissolve it; and it has never yet been imitated artificially. More than 500,000 of human beings derive their sole support from the culture and manufacture of silk; and upwards of 200,000*l.* may be said to be annually circulated by the silk-worm. Then we have large sums of money changing hands from the labours of the useful little bee; tons weight of honey and wax are yearly consumed; England pays more than 50,000*l.* for foreign honey and wax, besides her own produce. A great variety of *scents*, which from their agreeable odour are much used in perfumery, are manufactures from insects. The Spanish Fly is absolutely indispensable in the treatment of certain forms of disease; and that invaluable agent, chloroform, was first produced from Formic acid; this acid was discovered in the *Formic-ant*, from which it derives its name. Then there are the Gall-nuts, produced by a small fly, so useful in dyeing, ink-making, &c.

“Much more extensive and important than any of the foregoing, but, as less palpable, even more disregarded, are the general uses of insect existence. Disease, engendered of corruption in substances animal and vegetable, would defy all the precautions of man, unless these were aided by scavenger-insects, those myriads of flies and carrion beetles, whose perpetual labours, even in our tempered climate—but infinitely more so in warmer regions—are essentially important to cleanliness and health.

A use of this nature, and one performed perhaps to an extent we little think of, is the purification of standing waters by the innumerable insects which usually inhabit them. We have witnessed ample

proof of the efficacy in this respect of gnat larvæ, when keeping them to observe their transformations. Water swarming with these 'lives of buoyancy,' has been perfectly sweet at the end of ten days ; while that from the same pond, containing only vegetable matter, has become speedily offensive.

We have already pointed out the utility of insects in affording ever-new subjects of interesting inquiry. And let those who will look scorn upon our pursuit ; but few are more adapted to improve the mind. In its minute details, it is well calculated to give habits of observation and of accurate perception ; while, as a whole, the study of this department of nature, so intimately linked with others above and below it, has no common tendency to lift our thoughts to the great Creative Source of Being, to Him who has not designed the minutest part of the minutest object without reference to some use connected with the whole." *Episodes of Insect Life.*

"The shapely limb and lubricated joint
 Within the small dimensions of a point,
 Muscle and nerve miraculously spun,
 HIS mighty work, who speaks, and it is done ;
 The invisible in things scarce seen revealed,
 To whom an atom is an ample field."

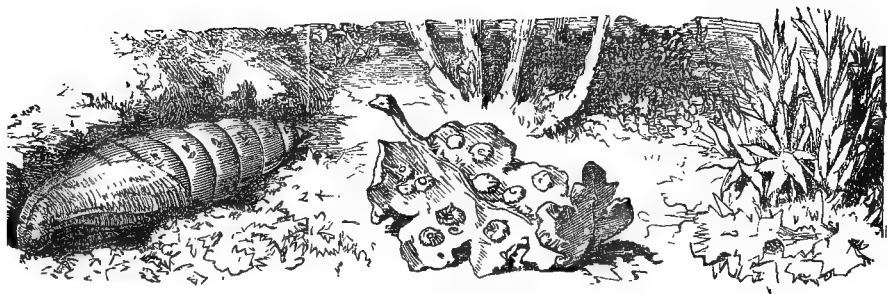

fig. 166.

Pupa of Hawk-Moth. Excrescences on oak-leaf produced by an insect.

CHAPTER VI.

ANIMAL STRUCTURE.

PHYSIOLOGY—HISTOLOGY—CELL THEORY—GROWTH OF TISSUES—
SPECIAL TISSUES—SKIN, CARTILAGE, TEETH, BONE, ETC.



THE most complicated state in which matter exists, is where, under the influence of life, it forms bodies with a curious internal structure of tubes and cavities, in which fluids are moving and producing incessant internal change," says the philosophic Dr. Arnott. These are called *organised bodies*, because of the various *organs* which they contain; and they form two remarkable classes; the individuals of one of which are fixed to the soil, and are called *vegetables*,—of these we shall consider the structure at a future stage; the individuals of the other are endowed with power of locomotion, and are called *animals*: it is some of the peculiarities and minute structure of this latter class that we are now about to examine. The phenomena of growth, decay, death, sensation, self-motion, and many others, belong to life; but, from occurring all in material structures, which subsist in obedience to the laws of physics and chemistry, the life is truly a superstructure on the other two, and cannot be studied independently of them. Indeed, the greater part of the phenomena of life are merely chemical and physical phenomena, modified by an additional principle. The phenomena of life, from thus involving generally the agency of all the sets of laws, are by far the most complex of any; and the discovery or detection of the peculiar *laws of life*, although they are fixed as the laws of chemistry or physics, has been very slow, and is as yet far from being completed.

The study of the Science of Life, or the building up of the living

our acquaintance with the true composition of every organ in the body, have been arrived at by means of the microscope, and could never have been known without it.

In addition to this, and what is of greater importance, after having studied the healthy structure of the body, most beneficial aid is afforded in the diagnosis of diseases, which in many cases were overlooked or undistinguishable without the assistance of this instrument. It is on this account constantly resorted to by the medical profession for the benefit of their fellow-creatures.

The space allotted to this division of our subject enables us to give only a short and imperfect sketch of a few of the fundamental tissues of the animal body. First, enumerating merely the elementary substances recognised by chemistry as entering into the formative processes, we shall proceed to inquire into that most interesting and wonderful starting-point of life, the *cell*; now admitted to be, and indeed demonstrable as, the *common centre* alike of the animal and vegetable organism.

THE HUMAN BODY, ITS PHYSIOLOGICAL COMPOSITION AND CHARACTER.

The elementary substances found in the human body are oxygen, hydrogen, carbon, azote, phosphorus, sulphur, chlorine, fluorine, iron, manganese, titanium, and lime. Silinium is found in the hair, and flourine in combination with lime forms the enamel of the teeth. Iron is the colouring-matter of the blood, the black pigment of the choroid of the eye, and in the skin.

Manganese is found in the bones, hair, blood; titanium in the salts from the supra-renal capsule. Other substances and gases are found distributed throughout the body.

Azotised and *non-azotised* substances constitute the proximate organic principles. The azotised are, protein and its compounds, albumen, fibrin, casein, and pepsin; extractive matters, gelatin, hæmatin, coestrin or bile matters, urea, and uric acid. The *non-azotised* are, lactine, or sugar of milk, and fatty matters.

Cells.—All animal and vegetable structures, it has been found by microscopists, are developed from cells; the materials for these in animals are furnished from the yolk and the blood.

A nucleated cell, 1 *a*, Plate XII., is a delicate membrane of a globular form, enclosing a granulous fluid; in the wall on one side is a dark oval body—this is the nucleus: there are one or two, seldom

more ; these enclose what are termed the nucleoli. The size of a cell may be 1-300th part of an inch in diameter ; some are larger, some smaller ; the nucleus may be 1-3000th of an inch in diameter ; the nucleoli are 1-10,000th of an inch in diameter, more or less.

The wall of a cell is chemically different from the nucleus ; for if treated with dilute nitric acid, the wall is dissolved, and the nucleus unaffected, so that we can in this manner isolate the nucleus. It is not known whether there exists any chemical difference between the latter and the nucleolus ; and it is probable that the nucleolus is a space in the nucleus containing a fluid.

The elementary cell is imbedded in an amorphous matter, which is termed cytoblastema, and is a fluid of greater or less consistence ; so that in one case the cell may float, and in the other it may be imbedded. The matter between the cells is called intercellular substance. Cells differ in their contents, which implies a difference in their walls, inasmuch as they secrete the interior.

The nucleolus was first discovered by Robert Brown in plants, and its use made out by Schleiden. He discovered that the nucleus was formed before the cell, and the latter was formed around it. After this cells of different kinds were found in animals ; and Schwann collected many instances, showing that animal and vegetable tissues were developed from cells : this was an important generalisation.

The mode of origin of the nucleated cell is this : cytoblastema first exists ; in it is developed the nucleus, and around the latter is formed the membrane of the cell from matters drawn from the cytoblastema. The way in which the cell itself is formed is this : around a granule we have a deposit forming a nucleolus ; round it again is formed the nucleus ; a swelling of this membrane takes place, and is situated over the others like a watch-glass, and thus the exterior cell is formed. Coalescence of the granules forms a nucleus, and in the interstices between these we find a fluid which is thought by Henle to form the nucleoli. It has been observed, that a globule of oil in contact with a small quantity of albumen drew from it a thin coating, which enveloped the globule of oil ; and this albumen became coagulated, forming a cell. When this globule was so surrounded, the coating became wrinkled ; but when placed in contact with water it became distended, thus proving it to be capable of endosmosis, or more probably an absorption of water by the wall of the cell, which consequently became distended or swollen up, as there is no attraction between oil and water. Nevertheless, elementary granules appear to be granules of oil, surrounded by a covering of a protein compound. Milk globules,

being composed of oil, surrounded by a covering of casein and dissolved fibrin, have been shown to attract a covering of albumen.

In this way the chyle, for instance, is taken as food into the body. The chyle is composed of protein compounds and fatty matters, which are reduced to a pulp by the digestive process; the protein compounds being converted into albuminous matters. The villi throughout the intestinal canal are permeable to these fluids; the oily particles meeting with a protein compound, are attracted to them, forming a covering; and so an elementary granule is formed. In their subsequent development, cells, when fully formed, never lose their character as cells while they exist; but they may dissolve other cells before they are changed into certain tissues. Cells may receive additional parts, which may remain as such, or form tissues; such are termed complicated cells: nerves and muscular fibre are formed from these. Examples of cells that undergo no further metamorphosis after full development are found in the cells of the epithelium, epidermis, and in the corpuscles of the blood. The elementary constituents of glands are cells, and the fluids are absorbed by them: cells are the great agents of absorption and secretion.

Change of Cells into Tissues.—This may take place by a joining together or coalescence of cells in a rudimentary state. Cells may meet, and at the point of contact coalesce and run into each other, thus forming a tube; indeed in this manner minute tubular structures are formed. Another mode is: cells aggregate into a mass, and at the point of contact run into each other, thus producing a multilocular cavity. Glandular structures are formed in this way. Membrane is formed of a deposit from the cytoblastema; before the cell-membrane is formed, the substance from the cytoblastema coalesces with those particles close at hand, thus forming a delicate film-like membrane. This membrane Wharton Jones calls endosmotic, or retentive membrane. We may have the cells coalesce to form a filament or fibre. The nucleus may disappear, or form another structure. Where regeneration of tissue is proceeding, there is found a larger number of granules.

Multiplication of Cells.—Cells may be formed in cytoblastema independent of any pre-existing cells: this is indeed an instance of that mysterious agency designated *spontaneous generation*. As an example of independent formation, we may instance the epithelium and epidermoid cells, corpuscles of the blood, and other juices of the body. Cells are formed from cells in three ways. First, there is gemmiparous generation, that is to say, sprouts occur from previous cells and be-

come detached, forming in their turn cells; this is also termed exogenous generation, inasmuch as the process takes place from the exterior. Endogenous generation is the second mode, and by it is meant that one cell is formed within the body, as it were, of the parent cell. The third manner is denominated fissiparous generation, and is where one cell becomes constricted, and eventually, at the point of constriction, divides into two. Of these three kinds or modes of multiplication, one only is found to occur in animals—it is the endogenous. The exogenous is only seen in the lowest plants. Fissiparous generation occurs in vegetables, and has been supposed by some to occur in animals also. The most striking example of endogenous generation that can be adduced, is that which takes place in the ovum of animals or birds. The first part formed of the ovum is the germinal cell, in the centre of the yolk; this approaches the surface, is dissolved, and there is then developed a new cell, which is called the embryo cell, from which is generated a numerous progeny; the contents of these cells are the cytotlastema to other nucleated cells.

As an instance where cells are not directly derived from cells, but previously-existing cells exert an influence on those to be formed, we may instance a fractured bone, between the ends of which osseous matter is deposited. We infer from this, that the substance of the bone determines, as it were, the formation of other cells, first into cartilage, and then into bone. This change is shown at figs. 8 and 9, Plate XII. Generally, however, where a part has to be repaired, it does not seem to determine the generation of a texture similar to itself—muscle and skin, for examples. We have an exception to the last observation in the case of nerves, which, if cut across, a substance is formed between the ends which can transmit the nervous influence; but the ends must not be separated to any great distance, or this will not occur. The same remark applies to bone. Cells may retain an independent existence, although changes may take place in their walls and contents, or they may become eventually dissolved and be succeeded by new ones. They may change their form, that is, a globular cell may pass to the compressed form; and this may arise from the difference of the contents to the material outside it, as in the corpuscles of the blood. Flattening of cells may arise from the pressure they exert upon each other, as, for example, in the cells of the epidermis and the epithelium. In some cases the cells become so thin, that their thickness cannot be measured. Sometimes, where there is but a single layer of cells, flattened, the hexagonal form of cell is assumed; at other times the polygonal. When a mass of cells compress each other,

they take the polygonal form, and have length, breadth, and thickness, as in the fat-cells of ruminating animals; this is readily seen in the fat of beef, but in human fat the round form is maintained. There may be a single layer of cells so arranged side by side, and presenting a columnar or basaltic form; this arrangement is seen in the cells of the intestinal tract, fig. 2 *a*, Plate XII. Another change of cell is this: they shoot out processes from certain parts of them, as may be seen at fig. 10 *a*, Plate XII.; this may be found also in the choroid plexus, on the inner surface of the sclerotic coat of the eye, or *lamina fusca*, as it is called. The cylindrical form of cell is found with delicate processes shooting out from the broad end; these are called ciliated, seen at fig. 2 *b*, Plate XII., and the cilia are endowed with the power to move spontaneously, having a vibratile motion, intended to urge on the secretions of the part in a particular direction.

Change of the Nucleus.—The nucleus may undergo a change; it may be smooth, round, compressed, like the cell to which it belongs; it may disappear altogether, and the cell which contained it remain. The corpuscles of the blood and the epidermic scales in the last stage of development are examples. The contents may change with the membrane itself. Some cells are filled with a granulous matter, others with pigment, or colouring-matter, as the cells of the choroid of the eye. Others, again, become filled with matters which form the secretions; the cell-membrane breaking, and pouring out its contents. The cell-membrane may become so changed, as to be of a horny consistence, not capable of being acted on by acetic acid, as it could have been before; this is well seen in the last changes of the epidermoid and epithelium cells.

In some cases the walls of the cell increase in thickness. Under the microscope, some cells appear to be composed of concentric laminae. In plants this is the common mode of increase in the thickness of the cell, but the deposit does not take place entirely around, but only here and there, so that vacant spaces are left which form canals, and may become branched, and these canals are named pore-canals. They do not perforate the outer layers, consequently the blind ends are seen through the outer membrane, and were supposed, indeed, to be apertures; but they are not so. Henle thinks he has found canals in such cells in animals, similar to those in vegetables—in the cartilage of the epiglottis, for instance. Another mode of development is, that the cells may not remain free and independent, but may coalesce with each other. Of this there are two modes: the first is, before coalescence the cell may have attained its full development as a cell; or secondly,

when this occurs, the cell may be simply solid plates or cells in a rudimentary state. The first kind is seen in cartilage; here the walls of the cell become increased in thickness and coalesce with each other, mixing at the same time with the intercellular substance, while the cavities or *vacuolæ* remain distinct, but are rendered smaller by this process of deposition. In the second kind, cells coalesce, but their cavities or *vacuolæ* run into each other: the tubules of some glands are thus formed. Where the cells touch they coalesce, and the thin walls dissolving, a single elongated cavity is formed.

Another mode is, the cells may be aggregated, like a bunch of raisins, and the parts in contact with each other disappear, so constituting a multilocular cavity: examples of this are seen in the racemose glands. Schwann conjectures another mode of coalescence. From cells formed as usual, processes sprout out; but this change takes place at the expense of the cell-membrane itself, and when it has gone on to some extent, we have the appearance of a network formed. Capillary vessels are in this way formed, as shown at fig. 3 *b* and fig. 6, Plate XII. Cells, we thus perceive, coalesce to form tissues, when they have not attained their full growth as such; or when they have been fully formed they become flattened, and assume the solid form. Deposits of matter may take place from the cyto-blastema with similar adjoining substance, constituting a delicate membrane, with here and there nuclei, as in the capsule of the lens, the membrane of the aqueous humour of the eye, or sheath of the primitive fasciculus of muscle; or the cells may coalesce in the linear series, to form fibre.

Development of Complicated Cells.—Here the nucleated cell is surrounded by a deposit, and that again surrounded so as to constitute a membrane; so that the nucleated cell may be looked upon as the nucleus to the cell so formed. Sometimes the nucleus undergoes important changes in the development of tissues, as well as the cell itself. In some cases, where the cells have joined in the linear series, the nucleus becomes oval, elongated, so that the nucleus of one cell tends to meet the nucleus of another cell; they subsequently coalesce, and thus fibre is formed. That so-constituted filament differs from that formed by the coalescence of the cells themselves, which is acted upon by nitric acid, whilst that formed from the nucleus resists it. The nucleus may be on the exterior of the cell, and sometimes imbedded in the wall. As an example of the first, may be instanced the nucleus of the pigment-cell of the eye, fig. 13, Plate XII. If, instead of the fibre being flat, it is cylindrical, it is formed by the nucleus. When

the nucleus is outside, the fibres of the cell and those of the nucleus unite, fibre by the side of fibre. As an example, we have the bone of the tooth; in this the fibres of the cell and nucleus alternate. Again, if the nucleus be arranged externally, it unites across either behind or in front, and thus a spiral filament is formed: this is seen in cellular tissue and tendon. The last-described form may alternate with that described before it, and there are all intermediate shades of difference. Nuclei sometimes disappear when they are very nearly developed, as in the cornea of the eye.

Action of Cells.—The subsequent changes of these depend in a great degree on endosmosis. The nature of the membrane is a necessary condition, for it determines the way in which the stream should pass; and we find in general that the current is from the rarer to the denser fluid. If we take common salt and fill a tube with it, and put the latter in water, we find that the salt rises, from the water having passed into the tube, and at the same time the water outside is saltish to the taste. It is not a constant circumstance that the stream is from the rarer to the denser fluid; with alcohol and water, for instance, the stream is from the latter to the former. Mineral substances permit of endosmosis, as pipeclay and chalk, in a low degree; but sandstone does not allow of endosmosis at all; thus proving that there must be something in the nature of the material to be permeated.

As to the processes of secretion, these depend in a great degree on endosmosis, inasmuch as the materials are drawn from the blood, and so thrown off.

Intercellular Substance.—In certain tissues the basis is made up of a homogeneous matter, granular or fibrous, or of a tissue composed of cells. The intercellular tissue must be the cytoblastema after the cells have been formed from it, and differs in quantity in different tissues; in some it is very slight in quantity, so that it has been overlooked; but still the parts are held together, and this must be by cytoblastema, which is proved by chemical action. In epithelium and other parts, on the contrary, it is in great quantity. This intercellular substance is sometimes formed into fibre, whether it be constituted of cytoblastema or of cells, and may exist in three conditions: 1st, as a homogeneous substance; 2d, as granular matter; 3d, as fibre. As an example of the first kind we have the epidermis, and of the second the cellular tissue. As hyaline membrane it exists in cartilage. In some cartilages it is by age developed into fibre, called cartilage fibre—an example is that between the vertebra; for the part in immediate connection with the bone, Wharton Jones has shown to be true cartilage.

PLATE XIII.

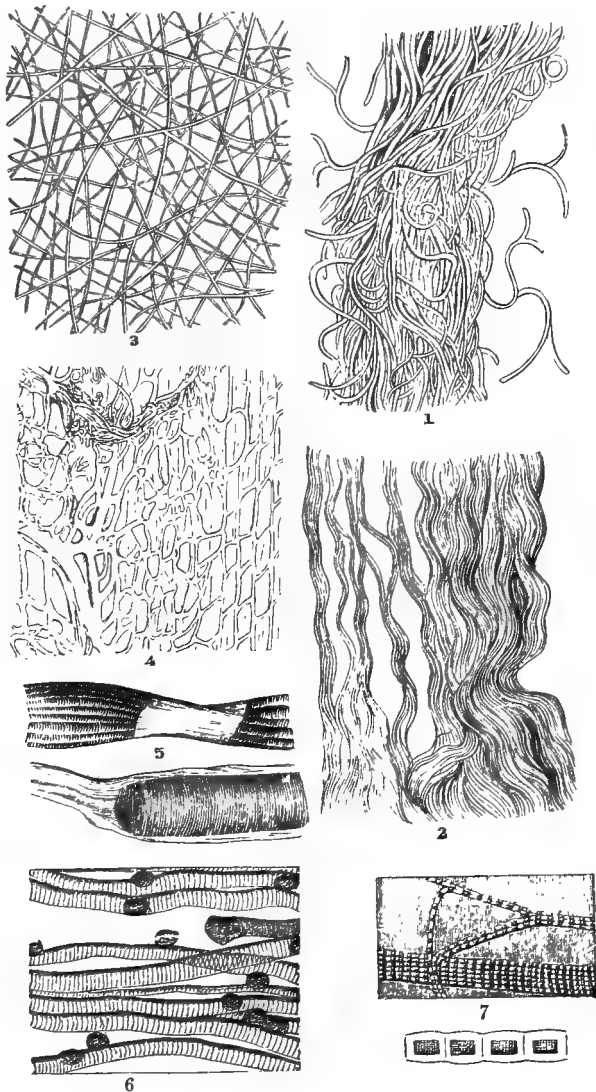

ANIMAL TISSUES.

1. Yellow-fibrous, or elastic tissue, taken near a ligament.
2. White-fibrous, or non-elastic tissue.
3. Fibrous tissue, lining the interior of the egg-shell, the lime having been removed by diluted hydrochloric acid.
4. White-fibrous tissue connecting the Tendons.
5. Muscular fibre, broken across, the fragments connected by the untorn structureless membrane, or Myolemma, magnified 100 diameters.
6. Muscular fibre, broken up into irregular and distinct bands, with a few blood-globules distributed about, magnified 200 diameters.
7. Muscular fibre, or a fasciculus of muscle taken from a young pig, magnified 600 diameters.

Sometimes the spaces between cells have no intercellular substance, there may be instead fluid or air; such cavities may present different forms—they are termed intercellular passages, and are for the conveyance of fluid or the passage of secretions: they exist in animals and vegetables, but are more highly developed in animals. In vegetables there are other cells lining these intercellular passages, so as to form a regular tube, with walls consisting of different coats. Cells exist in the neighbourhood of these passages, and have shot out processes and coalesced to form vessels with similar offsets from other cells: ultimately these are seen to join the intercellular passages, and become continuous with them. In glands, the cells being filled with their peculiar fluid, are conveyed to the wall of the intercellular passage, and through this the secretion arrives at the surface of the body.

The Epithelium.—If we cut very thin slices from the superficial portions of the skin, we can raise from it a delicate membrane; or what is better, by using chemical or mechanical irritation, we obtain what is ordinarily called a blister: to it we give the name of *epidermis*. The microscope has shown this to be a tissue of high and remarkable organisation, being, in point of fact, an aggregation of laminated cells, differing, in different situations, in regard to form, colour, and composition. This investment serves to protect the delicate structures beneath, and is likewise a bad conductor of heat,—thus tending to maintain the temperature of the body; besides these uses, it answers the purposes of excretion, and is sometimes an agent of motion. These laminated elementary cells, found on the surfaces, have generally nuclei. The nucleus is rounded or of oval form, and is the 1-3000 to 1-5000 of an inch in diameter. Each nucleus has two or three nucleoli, with outlines more or less irregular; a cell surrounds the whole, which has transparent walls. The cell varies in this latter arrangement: it may be flattened, and the nucleus may be attached to one side of it; or again, the nucleus may be in the centre, and the cell prolonged at either end. The cells of the epithelium may be divided into three kinds: the 1st is termed the tessellated or pavement; 2d, the columnar or basaltic; 3d, the ciliated or vibratile epithelium. Some make a 4th, combining the tessellated and columnar: this may be considered as transition epithelium, and is found only in certain mucous passages. These cells are represented in Plate XII., figs. 1, 2, and 3.

Tessellated epithelium is the simplest form, and, as its name implies, resembles flags of pavement, overlapping each other at their edges. They assume more or less the polygonal form, and their size varies in the different serous membranes. The cells of the

pericardium, or covering membrane of the heart, are much smaller than those of the covering membrane of the lungs, or the serous surface of the cornea, &c. On some surfaces we have many layers; in the skin it will be found of comparatively great consistence. If a vertical section of such be made, and viewed under the microscope, it will be seen to be composed of numberless layers, as shown in fig. 167. The

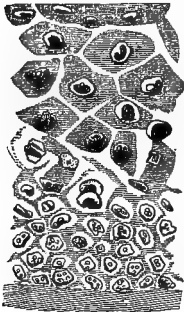

fig. 167.

skin taken from the sole of the foot, in consequence of the continued pressure there experienced, presents this distinctly stratified appearance. These layers of cells are held together by intercellular substance, which exists in quantities in the epithelium of the mucous membranes; if the epithelium is taken from these membranes, it is more easily seen, because the cells are not so closely aggregated together as in the skin; therefore a piece of epithelium from the mouth is recommended for display under the microscope, and by the addition of a drop of the solution of iodine the cells are still better seen. The cells from serous

and mucous membranes are acted upon by acetic acid, and dissolved if the acid be of considerable strength; but if the acid be weaker the cells swell up. Cells are not affected by alcohol, æther, ammonia or its salts, but they are dissolved by caustic potash, which dissolves the intercellular substance also.

Columnar or cylindrical epithelium, No. 2, α , Plate XII.—The nucleus is generally better seen than in the former kind of cells, although formed from them. If we examine a portion sideways it appears as at a , the upper being broader, and the nucleus being midway between the two extremities. When the cells of the cylindrical epithelium are closely aggregated together, they become compressed into the prismatic form; when they are less so, the rounded shape prevails. Consequently, when we take a bird's-eye view of them, from above or below, they appear like the pavement epithelium, as at c ; and thus error would creep in; but we must satisfy ourselves by examining them sideways, and in various modes. Their chemical composition is the same, and the cells dissolve in strong acetic acid. As examples of the situations in which this form of epithelium may be found, we may instance the intestinal tract, along the ducts of the glands, as the liver, &c.

In no situations do we find these two kinds of epithelium terminating abruptly the one in the other; but there is a gradual change of the one kind into that of the adjoining; as, for example, where the tesse-

lated epithelium is gradually supplanted by the cylindrical, as it passes from the œsophagus to line the interior of the stomach. This is termed *transition epithelium*.

Ciliated epithelium, No. 2, b, Plate XII.—The cells of this do not differ materially from those of the cylindrical; the great distinction between the two is, that in the former there are *cilia* attached to the broad end. Examples of the situations in which these are found are, investing membrane of the respiratory passages, upper part of the pharynx, larynx, and bronchi, the lateral ventricles of the brain, &c.

Epithelium is found to grow from the surface of the cutis outwards, in most places it is constantly growing outwards, and as continually being thrown off from the surface; it must at the same time be remembered, that though the epithelium is in close connection with the cutis, or true skin, it is not a deposit from it, but derives only its materials of formation and nourishment from it. Cytoblastema is given out from the blood; the nucleus is first formed by granules, and around the nucleus is established the cell-membrane, taking, at the same time, the particular form of the epithelium to be developed; and this development is dependent upon the individual energies of the cell itself, and not the cutis, whence it derives its nourishing materials. Its uses would seem to be to protect the delicate cutis from friction and external agents.

The epidermis is destitute of sensibility, yet it invests very sensitive parts. It is not vascular, but invests very vascular parts. Its exfoliation takes place regularly, as may be exemplified in reptiles and the batrachia, who throw off their skin: the moulting of birds is analogous. In the early periods of life in the human subject, exfoliation takes place from the surface of the skin; from the mouth the morsel of food is always mixed with detached cells. In the process of digestion the same thing occurs—in fact, it is only when the epithelium cells are thrown off that the gastric juice is secreted by the tubes of the stomach.

Cilia.—The most remarkable circumstance in connection with cells is the movement of the cilia: these are delicate processes, microscopically thin, and square at the end in man generally, but tapering in animals. These cilia are in constant motion, by them fluids and particles suspended in fluids are carried along, and in this manner reach the surface. There are three ways in which the cilia ordinarily move: the rotatory, the undulatory, and the waving, like a field of wheat set in motion by a steady breeze. No satisfactory explanation has been given of the cause of this vibratile motion. The current produced by them is from within outwards, in most places; in the respiratory passages, on the contrary, it is from without inwards. In the frog's mouth

it takes the same course. The ciliary motion may be seen in the kidney of the frog or newt; the cilia in the latter continue in active motion for some minutes after the animal is dead. A thin section must be made, with a very sharp knife and care taken to disturb the structure as little as possible. The section should be moistened with a little of the serum of the animal, and examined in a glass cell, covered with thin glass.

Pigment.—Pigment granules are found in greater or less quantities in the skin and bodies of white and dark races.

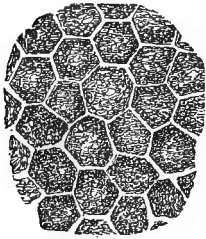

fig. 168.

In the eye there is pigment, and it affords a good example of nucleated cells, in which are contained the pigment particles, fig. 168. These are placed there for an optical purpose, that of absorbing the rays of light. In the peculiar colouration found in the eyes of some animals, called *Tapetum lucidum*, the colour is not owing to the pigment particles, but to the interference of the light: it is reflected from it, as in mother-of-

pearl, coloured feathers, scales of fishes, &c. The colour of the skin is owing to the granulous contents of the pigment cells; these are like ordinary elementary granules, with the addition of colour; and this latter may be removed by the action of chlorine.

The Nails are appendages to the epidermis, and present a mould of the cutis beneath; from the cutis the materials are furnished for the formation and growth of the nail. Like the epidermis, the nail is stratified; the markings are parallel to the surface, and the appearance is produced by the coalescence of the cells and their lying over each other. This arrangement causes an iridescent appearance of the section, when viewed with polarised light under the microscope.

Hairs.—The form of these differs in different parts of the body: some are cylindrical, others flattened. A hair is divided into a body or shaft, and a root which is in the skin (Plate XIV., No. 2). The shaft is again divided into two parts: the external is termed the cortical portion, and the internal the medullary portion; the latter does not usually exist in the whole length of the shaft. The cortical part consists of fibres, arranged parallel to each other: besides these there are, on the exterior, minute scales, like an epithelium; which are arranged like the tiles of a house, and produce the appearance of transverse markings. The fibres gradually expand out, forming a wall to the bulb enclosed in its capsule. The development of a hair commences at the bottom of the follicle, and by the aggregation of successive cytoblasts or new cells is gradually protruded from the follicle,

both by the elongation of its constituent cells, and by the addition of new layers of these to its base ; the apex and shaft of hair being formed before the bulb, just as the crown of a tooth is before its fang. The cytoblasts are round and loose at the base of the hair, but are more compressed and elongated in the shaft ; and by this rectilinear arrangement the hair assumes a fibrous character (see Plate XIV., No. 2). Of sixteen species of the Bat tribe, the hairs of which have been examined by Professor Quekett, all were analogous in structure to fig.

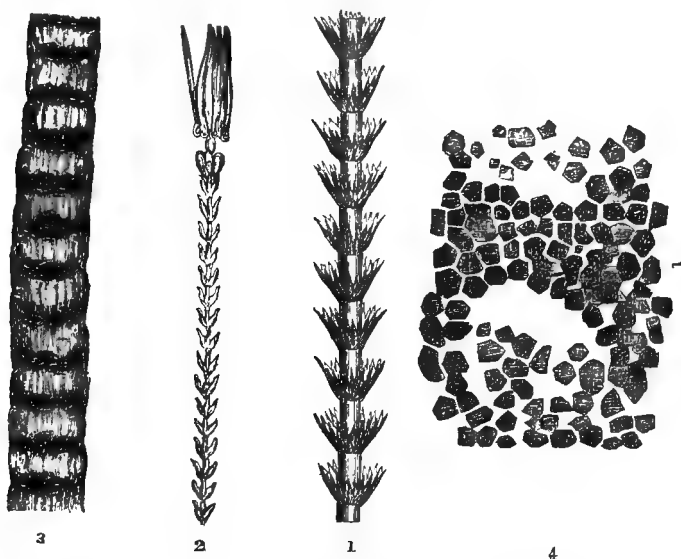

fig. 169.

1. Hair from the Indian Bat, magnified 500 diameters. 2. Hair from the Dermestes, magnified 250 diameters. 3. Hair from the Mouse, magnified 250 diameters. 4. Pigment cells giving colour to the skin.

169, No. 1 ; and the curious surfaces which these hairs present, are in reality owing to the development of scales on their exterior. By submitting hairs to a scraping process, these minute scale-like bodies, tolerably constant as regards their size and figure, can be procured ; so that Bat's hair may be said to consist of a shaft invested with scales, which are developed to a greater or less degree, and vary in the mode of their arrangement in different species of the animal ; that part of the hair nearest the bulb is nearly free from scales, but as we proceed toward the apex the scaly character becomes evident. Many of the scales are not unlike in shape those from the wings of butterflies, but are much

more minute, and exhibit no trace of striæ on their surfaces ; but those taken from dark-coloured hairs have colouring-matter deposited on them in small patches. In some cases they appear to terminate in a pointed process, like the quill part of butterflies' scales; and in others the free margin is serrated. By scraping, many of them will be detached separately ; but in some few cases as many as four or five will be found joined together : in the larger hairs the cellular structure of the interior, as well as the fibrous character of the shaft, are better seen after the scales have been removed.

The hair owes the greater part of its colour to *pigment-cells* : as these decay, and become gradually divested of their colouring-matter, they appear whitened, or "turn grey." These hexagonal cells also give colour to the skin of the negro, and are situated immediately beneath the transparent coat. A small portion is shown in fig. 169, No. 4, the vacant space denoting the situation of a lost hair.

Certain parts of the skin and mucous membranes are especially sup-

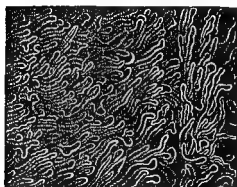

1

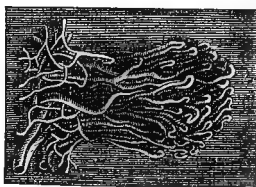

2

fig. 170.

No. 1. A section of the skin of finger, showing the vascular network of *papillæ* at the surface of the *cutis*. No. 2. Capillary network and distribution of *papillæ* of the tongue.

plied with *papillæ*, which serve as organs of touch ; nevertheless, throughout the skin there are *papillæ* more or less sensitive ; but it is only at the extremities of the fingers, lips, and in a few other situations, that these are highly developed, as in fig. 170. *Papillæ* are either filiform or tubiform, and have entering into them nerves and blood-vessels ; the former supplying the sensibility of the skin, and terminating in loops, as shown in fig 171.

In Plate XIV., No. 1, we have represented a vertical section of the skin, drawn under a $\frac{1}{4}$ -inch object-glass.

The skin is the seat of two processes in particular ; one of which is destined to free the blood from a large quantity of fluid, and the other to draw off a considerable amount of solid matter. To effect these processes, we meet with two distinct classes of glandulæ in its substance : the sudoriferous, or sweat glands ; and the sebaceous, or oil-glands. They are both formed, however, upon the same simple plan, and can frequently be distinguished only by the nature of their secreted product.

The sudoriferous or perspiratory glands form small oval or globular

masses, situated just beneath the cutis, in almost every part of the surface of the body. Each is formed by the convolution of a single tube, which thence runs towards the surface, as the efferent duct, making numerous spiral turns in its passage through the skin, and penetrating the epidermis rather obliquely ; so that its orifice is covered by a

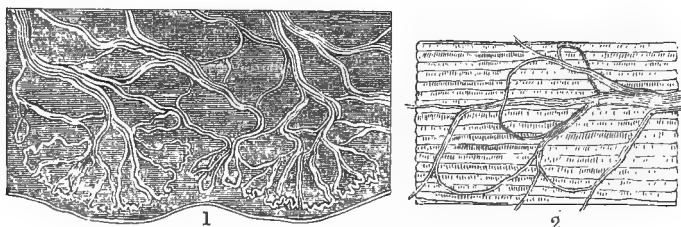

fig. 171.

No. 1. Distribution of the tactile nerves at the extremity of the fingers, as seen in a thin perpendicular section of the skin. No. 2. Termination of loops of nerve in the muscles.

sort of little valve of scarf-skin, which is lifted up as the fluid issues from it. Mr. Erasmus Wilson says : “To arrive at something like an estimate of the value of the perspiratory system, in relation to the rest of the organism, I counted the perspiratory pores on the palm of the hand, and found 3528 in a square inch. Now, each of these pores being the aperture of a little tube of about a quarter of an inch long, it follows that in a square inch of skin on the palm of the hand there exists a length of tube equal to 882 inches, or $73\frac{1}{2}$ feet. Surely such an amount of drainage as 73 feet in every square inch of skin—assuming this to be the average for the whole body—is something wonderful ; and the thought naturally intrudes itself, What if this drainage were obstructed ?”^{*} Could we furnish a stronger illustration of the necessity for maintaining the skin in a healthy state ?

The oil-glands of the skin are similar in structure to the perspiratory ducts, being composed of three layers derived respectively from the scarf-skin, which lines their interior ; the sensitive skin, which is the medium of distribution for the vessels and nerves ; and the corium, with its fibres, giving them strength and support. Like the perspiratory tubes, they are in some situations spiral ; but this is not a constant feature ; more frequently they pass directly to their destination ; they are also larger, as shown in the drawing, proceeding from the oil or fat vesicle situated at its lower extremity. Oil-glands are freely distributed to some parts, whilst in others they are entirely

^{*} Wilson on the *Management of the Skin*.

absent : in a few situations they are worthy of particular notice ; as in the eyelids, where they possess great elegance of distribution and form, and open by minute pores along the edges of the lids ; in the ear-passages, where they produce that amber-coloured substance known as the wax of the ears ; and in the scalp, where they resemble small clusters of grapes, and open in pairs into the sheath of the hair, supplying it with a pomade of Nature's own preparing.

INTERNAL PARTS OF THE BODY.

We have now to consider a cell of a much higher order than any before referred to ; it is found floating in the animal fluids, and is known as the blood-cell ; this requires a vascular system of its own for distribution over the whole of the animal body. The red blood corpuscles have a rounded form, somewhat flattened ; and under the microscope it is clearly seen that the central portion is hollowed out. Their size is about 1-3200th of an inch in diameter ; but in consequence of the form of the corpuscle, the thickness is different at the circumference to what it is at the centre ; in the former situation, it is about the 1-12,000th of an inch in thickness. It is a cell, possessing a biconcave form in consequence of being empty or collapsed. This we can readily understand ; for when the thick walls of a cell are collapsed, the central portion, in consequence of the approximation of the sides, appears thin, whilst the circumference, presenting an edge formed by a fold, must be thicker. This structure of the corpuscle is further proved to be its condition from the changes which it is made to assume by the action of re-agents ; these in some cases produce endosmosis, causing the corpuscle to become distended, and of a globular form like a cell. Again, re-agents may cause exosmosis, or a drawing out the fluid from the interior, and thus render the corpuscle again biconcave.

The wall of the cell is a transparent structureless membrane, and is of greater thickness than we find the analogous membrane of cells to be generally. The contents, being thicker than the outer membrane, and composed of a protein compound, are the colouring-matter constituting the redness of the corpuscles. The red corpuscles of birds, reptiles, &c., possess a distinct nucleus ; but on examining those of the human subject and other mammifera, no distinct nucleus can be made out. By applying dilute acetic acid, the red corpuscle becomes bleached, and its walls distended ; but no nucleus appears. If a red corpuscle from the frog be treated in the same manner, we see a nucleus, and the red colouring-matter is drawn out by exosmosis.

Water causes the corpuscle to swell up, and the colouring-matter

PLATE XIV.

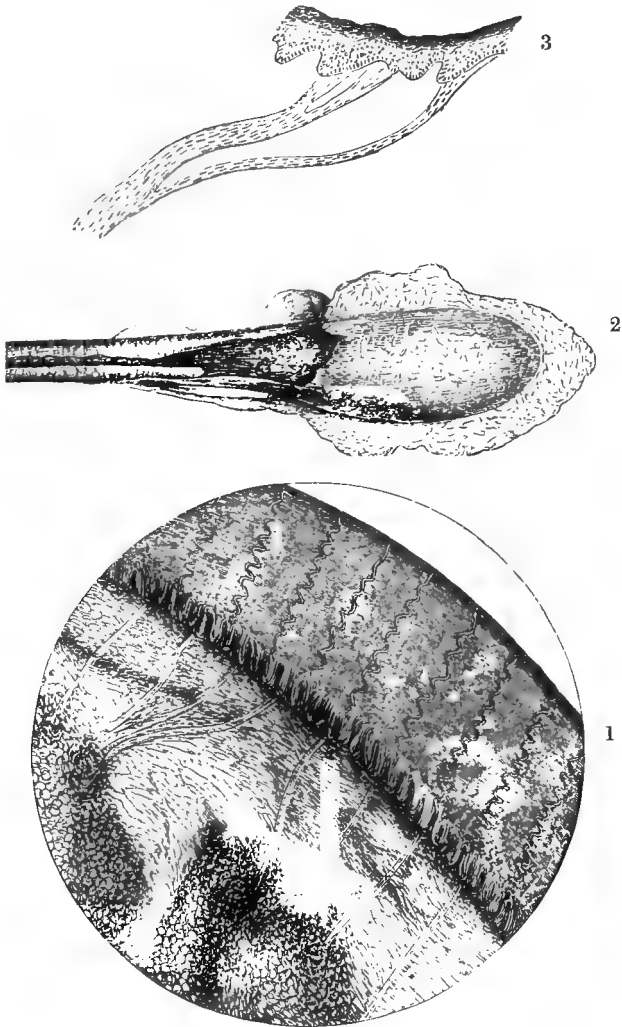

HUMAN SKIN AND HAIR.

1. A vertical section of *Epidermis*, Human Skin, showing the sweat-glands, surrounded by the fat-globules, the ducts passing upwards through the epithelial layer to the external cuticle, magnified 250 diameters.
2. A single Hair, seen near its bulbous extremity, and surrounded by involuntary muscular fibre.
3. A portion of involuntary muscular fibre isolated, and magnified 350 diameters.

disappears ; but its real nature is masked ; upon employing a drop of solution of iodine the wall becomes tinged, and is made distinct.

The cells themselves have a tendency to undergo spontaneously certain changes : one of the most common is a wrinkling up of the walls, with a surface somewhat like that of a mulberry ; this may also be produced by mechanical pressure, oil, &c.

There is another set of corpuscles, slightly larger than the red set ; these are termed *colourless corpuscles*, which, when distended by the action of water, are seen as nucleated cells, whose diameter is about the 1-2500th of an inch ; and a double contour of the walls is observed ; sometimes there is a slight tinge of colour to be seen in the nucleus. There is a third kind of corpuscles in the blood, more numerous than those above referred to, but of about the same diameter. When distended, they are seen to be cells filled with granular matter ; sometimes a clear spot is seen on one side : very dilute acetic acid being applied, the granules are dissolved out, and a clear central nucleus remains ; if the acid be used stronger, an appearance is seen as if there were several nuclei aggregated together. This latter appearance used to be considered the natural state of the nucleus, the particles of which were either tending to unite with one another, or there was a separation of the nucleus into several smaller portions. Wharton Jones, however, says there is no subdivision of the nucleus.

If we examine a drop of blood under the microscope, the corpuscles aggregate themselves together like rolls of coins, fig. 172, No. 3, which present a kind of network so long as they remain suspended in their *liquor sanguinis*. After the lapse of a few minutes, the fibrin, from its elasticity, contracts more and more, and a yellow fluid called serum is pressed out,—or, in other words, the components of the *liquor sanguinis*, with the exception of the fibrin ; and only a shrunken, jelly-like mass remains.

The blood corpuscles of the lower animals were formerly much studied. In the blood corpuscles of birds, and animals below them, there are nuclei ; but the cells, instead of being round, as in the human subject, are elliptical and larger. The corpuscles in mammifera in general are like those of man in form and size, being a little larger or smaller. The most marked exception is in the blood of the musk-deer, in which the corpuscles are of extreme smallness, about the 1-12,000th of an inch in diameter. The elephant has the largest, which are about the 1-2000th of an inch in diameter. The goat, of all common animals, has very small corpuscles ; but they are, withal, twice as large as those of the musk-deer. Another exception in regard

to form is in the camel-tribe, where they are oval, and resemble those of the oviparous vertebrata ; those of the frog are shown in fig. 172, No. 2. In the proteus, they are of a much larger size than in any animal, being the 1-400th of an inch in the longest diameter ; in the salamander, or water-newt, 1-600th ; in the frog, 1-900th ; lizards, 1-1400th ; in birds, 1-1700th ; and in man, the 1-3200th of an inch. Of fishes, the cartilaginous have the largest corpuscles ; in the gold-fish, they are about the 1-1700th of an inch in their longest diameter.

The large size of the blood-disks in reptiles, especially in the *Batrachia*, has been of great service to the physiologist, by enabling him to ascertain many particulars regarding their structure which could not have been otherwise determined with certainty. Among

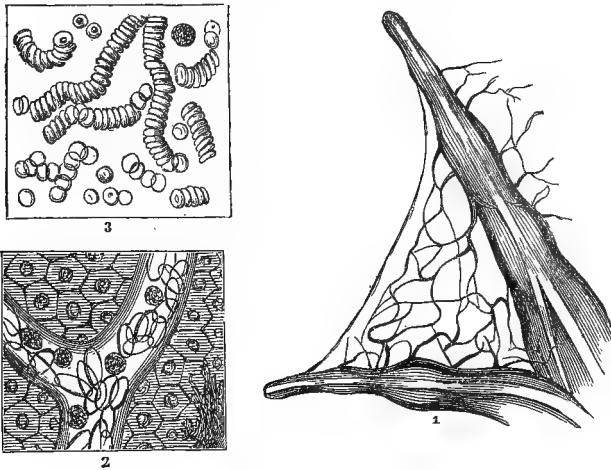

fig. 172.

1. A portion of the web of a frog's foot, spread out and slightly magnified to show the distribution of the blood-vessels. 2. A portion of same highly magnified, showing the ovoid form of the blood disks in the vessel, beneath which a layer of hexagonal nucleated epithelium-cells appear. 3. Human blood-disks, magnified 200 diameters, as they appear when fresh drawn.

other facilities which this occasions, is that of procuring their separation from the other constituents of the blood ; for they are too large to pass through the pores of ordinary filtering-paper, and are therefore retained upon it after the fluid part of the blood has flowed through.

A new and very interesting subject has lately been noticed—the production from the blood, under certain circumstances, of red albumi-

nous crystals,—which, though formed of animal matter, and sometimes, in all probability, during life, have forms as regular as any inorganic crystals.

Various authors, Sir E. Home, Scherer, and others, described reddish crystals in blood which had been effused into tissues or organs ; but Virchow was the first who paid particular attention to their actual nature, and proved them to differ from saline or earthy crystals. If we add water to a drop of blood spread out under the object-glass of the microscope, as the drop is beginning to dry up the edges of the heaps of blood corpuscles are seen to undergo a sudden change : a few corpuscles disappear, others have dark thick edges, become angular and elongated, and are extended into small well-defined rodlets. In this manner an enormous quantity of crystals are formed, which are too small to enable us to determine their shape ; they rapidly move lengthways, the entire field of vision being gradually covered by a dense network of acicular crystals, crossing one another in every direction, with other crystals presenting the form of rhombic plates.

Dr. Garrod discovered, that by a slow evaporation of portions of the serum of blood taken from patients labouring under gout, he could obtain strings of crystals of uric acid : this may prove of great value as a diagnostic sign of this disease. His mode of proceeding is to pour a little serum into a watch-glass, and add a few drops of acetic acid ; place in this mixture a few very fine filaments of silk or tow, and stand it by for twenty-four hours under a glass-shade. Upon removing and submitting the filaments to microscopical examination, they will be seen to be studded with minute crystals of uric acid.

No. 1, fig. 172, the foot of the frog is stretched out, to show the distribution of the blood-vessels in the web : the two sets of vessels—the arteries and veins—are very readily made out when kept steadily on the stage of the microscope ; the rhythm and valvular action of the latter may be observed, although they are much better seen in the ear or wing of the *long-eared bat*, as first pointed out by Wharton Jones.

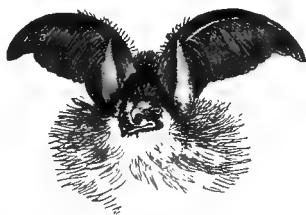

fig. 173.
Head of Long-eared Bat. Plecotus Auritus.

The circulation in the foot of the frog and the tail of the newt is, for the most part, the capillary circulation. The ramifications of the minute arteries form a continuous network, from which the small branches of the veins take their rise. The point at which the arteries

terminate and the minute veins commence cannot be exactly defined: the transition is gradual; but the intermediate network is so far peculiar, that the small vessels which compose it maintain nearly the same size throughout; they do not diminish in diameter in one direction, like arteries and veins; hence the term capillary, from *capillus*, a hair. (Fig. 175.) The size of the capillaries is proportioned in all animals to that of the blood corpuscles; thus, amongst the reptilia, where the blood corpuscles are the largest, the capillaries are also the largest: but it does not follow that they should be always of the same size in all

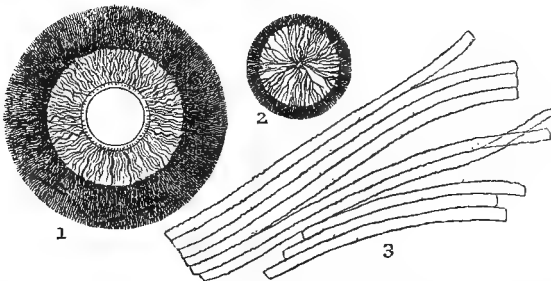

fig. 174.

1. Blood-vessels of the Eye; back view of the *Iris* and ciliary processes. 2. Vessels of the *membrana pupillaris* from the eye of a Kitten. 3. Fibres or tubes from the lens of the Ox.

the tissues of one and the same animal; for if we examine and carefully measure in the human subject their sizes in different tissues, we shall find that they vary greatly even in individual tissues; and, at a rough estimate, examples may occur as large as a thousandth, whilst others are so small as the four or five-thousandth of an inch. They should be measured, if possible, in their natural state; when injected, their size is slightly increased; but when dried, they diminish so considerably, that in some specimens vessels imperfectly filled with injection have been known to shrink from the three to the twenty-thousandth of an inch.

We here digress for the purpose of saying a word or two on a popular belief, that the precious organ of vision is liable to injury from using the microscope. We have taken some trouble to look through the records of a large hospital devoted to diseases of the eye, and have likewise made many inquiries amongst microscopists, and can come to no other conclusion, than that such a belief is without foundation; the eye, on the contrary, which may be most used in making microscopic examinations, becomes the strongest and best.

It is perfectly natural to believe that this would be the result ; knowing, as we do, that every organ of the human body is both improved and strengthened by careful cultivation. With our many excellent contrivances for moderating the intensity of artificial light, when employed, there is, indeed, but small risk of injury to the eye.

Capillaries are, with very few exceptions, always supported by an areolar network, which serves not only as an investment to them, but connects them intimately with the tissues they are destined to supply.

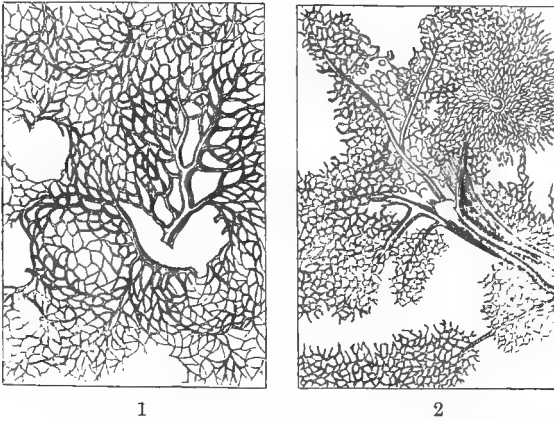

fig. 175.

No. 1 represents the fine network of air-tubes that supply the lungs with air.
 No. 2 the network of capillaries for conveying blood to the lungs.

There is a possibility, in first examinations, of mistaking or confounding capillaries with nerves, especially if the part under observation should have been left for some time in the strong preserving or alkaline solutions in the act of cleansing. A weak solution of caustic soda, and also another of acetic acid, are both made use of : the first is more generally available for the purpose of discovering nerves ; the latter in tracing out vessels, structure of papillæ, unstriped muscle, &c. ; inasmuch as it renders their nuclei more obvious, while soda makes them less so. It is very useful sometimes to use these re-agents alternately ; and the rule is, to apply them to the object while under the microscope, so as to watch their gradual operation.

It is not in the blood alone that cells float in a fluid ; the chyle and lymph are but colourless corpuscles, flowing along their especially-adapted ducts and tubes, and carrying the nutritive particles gathered

from the food to the blood-vessels, for the reparation of the framework or growth that so incessantly goes on in the animal body. In Plate XII. No. 3 *b* is shown the arrangement of the chyloferous tubes, with their corpuscles enclosed in a structureless membrane.

And thus we shall find that all the tissues most actively engaged in the maintenance of the vital functions of the human body are performed by these cells or globules, varying in size from infinite minuteness to forms visible to the unassisted eye; that one system of cells secretes the bile, another the fat, another the nerve-matter, and so forth. But how these special products are formed by cells apparently of similar organisation, we know not. Whether the special endowment belonging to the system of cells of a particular organ depends on the intimate structure of the wall or tissue of such cells, and this structure be so attenuated and infinitesimal as to elude our observation, or whether it results from the transmission of some peculiar modification of that mysterious vital force we term nervous influence, are questions to which no satisfactory reply can be given.

Mr. Huxley has ascertained, that in all the animal tissues the so-called nucleus (endoplast) is the homologue of the primordial utricle, with nucleus and contents (endoplast) of the plant, the other histological elements being invariably modifications of the periplastic substance. Upon this view, we find that all the discrepancies which had appeared to exist between the animal and vegetable structure disappear; and it becomes easy to trace the *absolute identity* of plan in the two, the differences between them being produced merely by the nature and form of the deposits in, or modifications of, the periplastic substance. In both plants and animals there is but one histological element—the endoplast—which does nothing but grow and vegetatively repeat itself; the other element—the periplastic substance—being the subject of all the chemical and morphological metamorphoses in consequence of which specific tissues arise. The differences between the two kingdoms are mainly, firstly, That in the plant the endoplast grows, and, as the primordial utricle, attains a large comparative size, while in the animal the endoplast remains small, the principal bulk of its tissues being formed by the periplastic substance; and secondly, In the nature of the chemical changes which take place in the periplastic substance in each case.

A CLASSIFICATION OF THE ANIMAL TISSUES.

Professor Schwann's classification of the fundamental tissues of the human body is that generally adopted, more than half of which tissues are formed out of the cellular or simple membranes.

1. Simple membrane : employed alone in the formation of compound membranes	}	Examples : Walls of cells, capsule of lens of the eye, sarcolemma of muscle, &c.
2. Fibrous tissues		Examples : White and yellow fibrous tissue, areolar tissue, elastic tissue, &c.
3. Cellular tissues	}	Examples : Cartilage, fat, pigment, grey nervous matter, &c.
4. Sclerous or hard tissues		Examples : Rudimentary skeleton of invertebrata, bone, teeth, &c.
5. Compound membranes : composed of simple membrane and a layer of cells of various forms (epithelium or epidermis), or of areolar tissue and epithelium	}	Examples : Mucous membrane, skin, true or secreting glands, serous and synovial membranes.
6. Compound tissues ; <i>a</i> , those composed of tubes of homogeneous membrane, containing a peculiar substance		}
<i>b</i> , those composed of white fibrous tissues and cartilage		

Cellular Membrane, or Tissue.—Cellular or areolar tissue is generally distributed throughout the body, and various forms of this cell-fibre are found ; it is seen uniting together component parts, filling up interstices between them, and affording a support to the blood-vessels and nerves, before they are distributed to the various organs. This fibre is soft, clear, smooth, and extremely minute, being the 1-12,000th of an inch in diameter, sometimes less. The fibre is usually found united together in bundles, the 1-2000th of an inch broad : if these be acted upon by dilute acetic acid they swell up, become transparent, and the appearance of fibrous structure is no longer seen, although some fibres that were not previously observed may become more distinct. The first kind does not refract the light strongly ; the second kind does, showing some chemical difference in their composition.

Cellular tissue, if dried, becomes a yellowish, brittle, transparent mass ; but regains its former state if placed in water. The fibres have a remarkable arrangement and disposition. They are often deposited in a spiral manner. At other times they are regularly undulating. In fibres taken from some parts of the body, we find that a fasciculus is

wound round in a spiral form. As a consequence, when acetic acid is applied, we perceive projections of swollen cellular fibre; and in the depressions the spiral fibre, which, from not having been acted on, has formed the constriction, and with the acid has given rise to the appearance. This forms a striking instance of the constancy of the spiral, which perhaps will be seen to take on a definite course, as observed by M. Wichura in many other departments of nature. He says, "that the circularly or heliacally acting forces of nature follow an unchanging, definite, lateral direction in their course. The planets describe heliacal lines, winding to the right in space by virtue of their circulation from west to east, since this is combined with the advance in company with the sun towards a point in the northern hemisphere. In the department of physics we meet with allied phenomena in the circular polarisation of light, and in the course of electro-magnetic spirals. Organic life exhibits similar laws in the circulation of the blood, in all cases starting from the left side of the animal's body; and in the heliacal windings of the shells of molluscs, which follow a direction determinate for every species. But plants, above all, give evidence of a wonderful obedience to such laws, in the direction of the spiral vessels, the heliacally winding trunks of trees, winding stems and leaves; and probably, also, in the circulation of their saps." In the lowest forms of animal life, and in those of insects, the spiral form will be seen to be most extensively distributed throughout; as may be observed by referring to our woodcuts.

Sometimes fat is found in the cellular tissue; it is not secreted from it, but is contained in its proper cells, and termed *adipose* tissue, the elementary cells of which are from the 1-300th to the 1-600th of an inch in diameter, Plate XII., No. 4. The cell-wall is very delicate and transparent: sometimes there are one or two nuclei enclosed. Æther dissolves out the fat-cells from the tissues. Acetic acid acts upon the cell-wall, and causes the contents to pass from within outwards.

Fibrous tissue, elastic and non-elastic, is usually divided into *white* and *yellow* fibrous tissue. The yellow is elastic and of great strength, consisting of bundles of fibres which are highly elastic (Plate XIII., No. 2). The white, No. 1, though non-elastic, is of great strength, and of a shining silvery appearance. These two kinds of fibrous tissue differ from each other in many respects, but chiefly in their ultimate structure, their physical properties, and their colour: both are largely employed in those parts subservient to the organs of locomotion.

The white fibrous tissue is (when perfectly cleared of the areolar) of a silvery lustre, and is composed of bundles of fibres running for the most part in a parallel direction; but if there be more than one plane of fibres, they often cross or interlace with each other: in some specimens it is difficult to make out the fibres distinctly, except in certain lights; and in these cases it appears that this tissue may be composed of a longitudinally striated membrane, which may be now and then split up into fibres. The white fibrous tissue is principally employed in the formation of ligaments and tendons,—a purpose for which it is admirably fitted on account of its inelasticity; it also is concerned in the formation of fibrous membranes, viz. the pericardium, dura mater, periosteum, perichondrium, the sclerotic coat of the eye, and all the different fasciæ. It is sparingly supplied with blood-vessels and nerves: the former always run in the areolar tissue, connecting the bundles of fibres together; but in the generality of the fibrous tissues the blood-vessels are not well seen, except in the dura mater and in the periosteum.

The yellow fibrous tissue is highly elastic; it consists of bundles of fibres covered with, and connected together by, areolar tissue: the fibres are of a yellow colour, in some cases round, in others flattened; they are not always parallel, but frequently bifurcate and anastomose with other neighbouring fibres. It is always rather difficult to separate the fibres from each other; and when they are separated, the elasticity of each individual fibre is shown by its tendency to curl up at the end. The fibres in the human subject vary in diameter from the 1-5000th to 1-10,000th of an inch. The acetic acid of ordinary strength does not act on the yellow fibrous tissue; nor after maceration in water or spirit for a very long time does its elasticity diminish. Very long boiling is said to extract from it a minute quantity of a substance allied to gelatine; neither nuclei nor a trace of cells can be seen in it after the addition of acetic acid: these are readily seen when white fibrous element is treated with this acid.

Muscular Fibre.—There are three different kinds of muscular fibre found in the animal body: 1st, muscle of the skeleton; 2d, muscle of the heart; and 3d, muscle of the stomach, intestines, &c. The functions of muscular substance may be referred to two kinds—voluntary and involuntary. The muscles endowed with voluntary power are those of the skeleton; the involuntary are those of the heart, stomach, &c.

Muscular fibre is held together by a very delicate tubular sheath, nearly resembling simple structureless membrane. It cannot always be discerned; but when the two ends are drawn asunder it will be

perceived to rise up in wrinkles, or the fragments of the torn muscle will be seen to be connected by the untorn membrane, as at No. 5, Plate XIII. This membrane is termed *Myolemma*. It is best seen when a piece of muscle is subjected to the action of fluids, as diluted acetic or citric acid, or the fluid alkalies; which occasion it to swell and become easy of separation. It has no share in the contraction of the muscle itself, which is made up of a series of bundles of highly elastic fibres: portions of a separated bundle are shown at No. 6; and the ultimate structure of a fibre, under a magnifying power of 600 diameters, at No. 7, Plate XIII.

Dr. Hyde Salter pointed out, that in the tongue, the muscles pass directly into the bundles of the submucous connective tissue, which serve as their tendons. We have figured such a transition at Plate XII., No. 11: the tendon, the lower part of which may be seen passing insensibly into the striped muscle, the glandular sarcoous elements of the latter appearing, as it were, to be deposited in the substance of the tendon (just as the calcareous particles are deposited in bone), at first leaving the tissue about the walls of the cavities of the endoplasts, and that in some other directions, unaltered. These portions, which would have represented the elastic element in ordinary connective tissue, disappear in the centre of the muscular bundle, and the endoplasts are immediately surrounded by muscle; just as in many specimens of bone (see figs. of bone), the lacunæ have no distinguishable walls. On the other hand, at the surface of the bundle the representative of the elastic element remains, and often becomes as much developed as the sarcolemma. There is no question here of muscle resulting from the contents of fused cells, &c. It is obviously and readily seen to be nothing but a metamorphosis of the periplastic substance, in all respects comparable to that which occurs in ossification, or in the development of tendon. In this case we might expect, that as there is an areolar form of connective tissue, so we should find some similar arrangement of muscle; and such may indeed be seen very beautifully in the termination of the branched muscles, as they are called. In Plate XII., No. 12, the termination of such a muscle from the lip of a rat, is shown; and the stellate "cells" of areolated connective tissue are seen passing into the divided extremities of the muscular bundle, becoming gradually striated as they do so. In the muscle it is obvious enough, that whatever *homology* there may be between the stellate "cells" and the muscular bundles with which they are continuous, there is no *functional analogy*, the stellate bodies having no contractile faculty. But the nervous tubule is developed in essentially the same manner as a

muscular fasciculus, the only difference being, that fatty matters take the place of syntonin. Now it commonly happens, that the nerve-tubules terminate in stellate bodies (Plate XII., No. 10) of a precisely similar nature; and these, in this case, are supposed to possess important nervous functions, and go by the name of "ganglionic cells."

The muscular fibre, known as the *non-striated*, or involuntary, consists of a series of tubes presenting a flattened appearance, without the transverse striæ so characteristic of the former: elongated nuclei are developed immediately upon the application of a little diluted acetic acid. Wharton Jones, F.R.S., first demonstrated this structure in his lectures at Charing-Cross Hospital about 1843: he was led to infer from appearances in very young fibre, that the striped muscular fibre is originally composed of similar elements to the *unstriated*, or plain muscular tissue; which, in the process of development, become enclosed in a sarcolemma (simple membrane) common to many of them: the fibres then split into smaller fibres (*fibrillæ*). Thus accounting for the nuclei of striped muscular fibre; which, according to his views, are the persistent nuclei of the primitive muscular-fibre cells.

The non-striated fibre is beautifully seen in connection with the skin surrounding the hair, a few fibres of which are separately shown at No. 3, Plate XIV. Professor Kölliker originally described these muscles of the skin, of which there appear to be one or two in connection with each hair-follicle, arising from the more superficial parts of the outer skin, then passing down to the root of the hair, close behind the fat-gland, and there embracing it.

It is indeed remarkable that the skin, where covered with hair, should alone be provided with these muscular fibres; the effect of the contraction of which must be to thrust up the hair-follicles and depress the intermediate portions of the skin, and thus produce that peculiar state of the surface well known as *goose-skin*, a condition of the skin before unaccounted for.

Nerves.—The nervous system consists of brain, spinal marrow, and nerves. There are two sets of nerves in the body; in the one set the nerves are white, firm, shining, more or less rounded, with transverse markings; in the other, they are softer, not so consistent, of a reddish-grey colour, and generally flat.

Under the microscope, nerves are seen to be composed of minute fibres or tubules, full of nervous matter, arranged in bundles, connected by intervening fibro-cellular tissue, in which blood-vessels ramify. A layer of the same, or of a delicate, transparent, structureless tissue, also surrounds the whole nerve, and forms a sheath for it. The slight

pressure of the thin glass, when placed on the nerve-fibre, causes nearly the whole of the contents to flow out in the form of a granular material ; it therefore becomes requisite to exercise more care in the breaking up of structures to view these tubules, which should be immersed in a very weak solution of spirit and water. Mr. Clarke, in his very important investigations on the structure of the spinal cord, placed the cord, immediately after removal from the animal, into strong spirits of wine. This hardened it, and enabled him to make very thin sections of the spine. As nerves approach the brain or spinal cord, they gradually become smaller, and do not measure more than from 1-10,000th to 1-14,000th of an inch in diameter. The difference in the nervous substances is not an affair of colour only ; it refers also to their intimate structure and organisation : the white matter is made up of bundles of tubular fibres ; whilst the grey is composed of aggregated cells, and is often denominated the vesicular neurine. To collections of this vesicular substance the term "ganglion" is applied ; because the knots of nervous matter, which were formerly supposed to give origin to the nerves, and which are distributed so largely throughout the body, are vesicular in their composition. And thus the identity in structural constitution has led to the employment of the word ganglion as a common term ; although the ganglionic or spheroidal form is not at all essential, as was at one time supposed, to the constitution of what is now called ganglionic substance. Physiological and pathological researches have rendered it more than probable that the vesicular and the fibrous substances have universally separate and distinct offices in the animal economy ; the ganglionic structures being the source of *functional change*, and the fibrous matter being simply for the *conduction* of impressions originating in the former. This theory, in the promulgation of which Mr. Solly shares probably in the most eminent degree, is now received very generally as a scientific truth. The nerve-corpuscles and stellate nerve-fibres are represented in Plate XII. No. 10.

All the sensory ganglia, it may here be noticed, besides their instrumentality in inducing the simpler forms of consciousness, react upon the muscular system, when stimulated from without ; and that, too, in apparent independence of thought or volition. The movements thus arising Dr. Carpenter very aptly designates *consensual* : they are seen when the dazzled eye withdraws instinctively from the light, or when the startle follows upon a loud and unexpected sound.

Consolidated Tissues.—These tissues are formed by a chemical combination with the gelatine of the fibre, which in cartilaginous forma-

tions is termed *chondrine*; the cells of which become consolidated by calcareous deposits, and a gradual transition results therefrom. Cartilage is the firmest structure next to bone; it is very elastic, and is converted by the intercellular substance into two kinds. In a rib we find that this substance is uniform, and has a bluish appearance, or is slightly granulous; this is termed true, or white cartilage. The other form of intercellular substance is developed in fibrous substances; and in this peculiarly-formed felt-work, cells and nuclei are imbedded. It is termed yellow, fibrous, or spongy cartilage; the yellow colour depends on the mode of fibrous arrangement of the intercellular substance: it is found in the ear, &c.

Cartilage forms the entire skeleton in some kinds of fishes, as the skate, lamprey, &c. It is nourished without coming into direct contact with the blood-vessels, and is therefore said to be *non-vascular*, deriving nourishment by imbibition from the *surrounding* blood-vessels. When examined microscopically, the simplest form of cartilage is found to resemble in a striking manner the cellular tissue of vegetables; it consists of an aggregation of cells of a spherical or oval figure, capable in some cases of being separated from each other, but every cell having a nucleus, with a nucleolus in its interior. In figs. 176 and 177 we have given varieties of this structure. In the more highly advanced scale of animals a strong fibrous capsule or sheath surrounds the cartilage-cells, and some of the fibres dip in amongst the cells, and bind them firmly together. In those of the Ray and Shark kind, where the entire

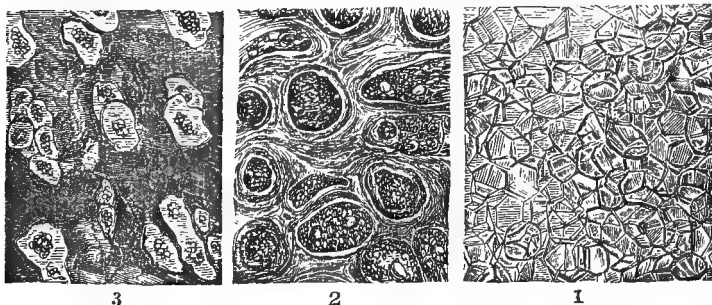

fig. 176.

1. Cartilage from ear of mouse, resembling a section of vegetable tissue, with several superimposed layers. 2. Cartilage from rabbit's ear, showing large cells imbedded in a fibrous matrix. 3. Cartilage from human ribs, with cells in groups, each having a granular nucleus: magnified 200 diameters.

skeleton is cartilaginous, the cell is imbedded in a matrix, which may

be strictly termed *intercellular*. The cells are frequently or entirely isolated, as seen in the section from the ear of a mouse (Fig. 176, No. 1), and it then rarely becomes converted into bone. In the higher animals it is generally invested by a fine and delicate membrane, termed *perichondrium*, which brings blood-vessels into close

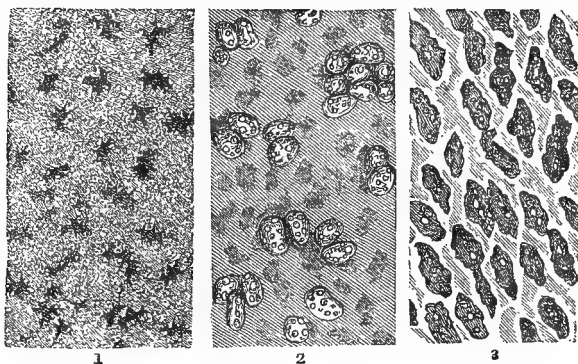

fig. 177.

1. Cartilage from the cuttle-fish, showing a peculiar form of cell.
2. Cartilage from the head of skate, with nucleated cells in clusters, and nucleoli in their interior.
3. Cartilage from the frog, and cells having nucleoli: magnified 200 diameters.

contact with the cartilage; and when in actual contact with the extremities of bones, it is covered by a fringed membrane having a large number of vessels terminating in it, for the purpose of supplying a lubricating fluid to the end of the bones: this is the *synovial membrane*, a very beautiful structure when injected and viewed with the 1 or 2 inch object-glass.

In the early stages of existence, the framework,—or a very large proportion of it,—is composed of cartilage, which, by the gradual addition of earthy matter, becomes consolidated into bone. The mode of development, and the change from one to the other, is represented in the section, Plate XII. No. 8; it will there be seen that the calcareous matter is deposited in nearly straight lines, which stretch from the ossified surface into the substance of the matrix of the cartilage, the amount of calcareous matter in which gradually diminishes as we recede from the ossified part. If the deposit has taken place to any great extent, the calcareous matter becomes crowded and consolidated; as the process advances, the bone thickens, and a series of grooves, of a stellate figure, No. 9, are found upon its surface, which are gradually converted into canals for the passage of blood-vessels.

In certain forms of disease many of the soft parts of the human body become converted into cartilaginous and bony masses, which have received the name of *Enchondroma*. The microscopical characteristics of this change have been described by the author, in the *Transactions of the Pathological Society of London*, vol. iv.

Teeth.—The teeth are nearly allied to bone in structure ; and in some of the lower vertebrata there is an actual continuity between the bone of the jaw and the teeth. It is desirable to become acquainted with the structure of teeth under the microscope : they are always intimately related to the food and habits of the animal, and are therefore highly interesting to the physiologist ; they form for the same reason important guides to the naturalist in the classification of animals ; and their value as zoological characters is enhanced by the facility with which, from their position, they can be examined in living or recent animals.

Professor Owen has said, “ If the microscope be essential to the full and true interpretation of the vegetable remains of a former world, it is not less indispensable to the investigator of the fossilised parts of animals. It has sometimes happened that a few scattered teeth have been the only indications of animal life throughout an extensive stratum ; and when these teeth happened not to be characterised by any well-marked peculiarity of external form, there remained no other test by which their nature could be ascertained than that of the microscopic examination of their intimate tissue. By the microscope alone could the existence of Keuper-reptiles in the lower sandstones of the new red system, in Warwickshire, have been placed beyond a doubt. By the microscope, the supposed monarch of the Saurian tribes—the so-called *Basilosaurus*—has been deposed, and removed from the head of the reptilium to the bottom of the mammiferous class. The microscope has degraded the *Saurocephalus* from the class of reptiles to that of fishes. It has settled the doubts entertained by some of the highest authorities in palæontology as to the true affinities of the gigantic Megatherium ; and by demonstrating the identity of its dental structure with that of the Sloth, has yielded us an unerring indication of the true nature of its food.”

The teeth of man and of most of the higher animals are composed of three different substances, *Dentine* (known as *ivory* in the tusk of the elephant), *Enamel*, and *Cementum*, or *crusta-petrosa*. These are variously disposed, according to the purpose which the tooth is to serve : in man the whole crown of the tooth is covered with enamel, shown in the dark marginal part of fig. 178 ; its root or fang is covered with

cementum, whilst the substance or body of the tooth is composed of dentine. The enamel is composed of solid prisms or fibres, of about 1-5500th of an inch in diameter, arranged side by side, and closely adherent to each other.



1



2

fig. 178.

Sections of Human Teeth.

1. Vertical Section. 2. Horizontal Section.

responds in all essential particulars with bone, preserving its characteristic lacunæ, traversed by vascular medullary canals.

The very interesting structural characters of teeth in some of the lower animals, called forth an able work from the pen of Professor Simonds, of the Royal Veterinary College: to his book upon this subject we beg to refer the reader.

Czermak discovered that the curious appearances of globular conglomerate formations in the substance of dentine, are entirely dependent on its mode of *calcification*; and he attributes the contour lines to the same cause. Contour markings vary in intensity and number; they are most abundant in the root, and most marked in the crown. Vertical sections exhibit them the best. In preparing the specimen, first make the section accurately, then decalcify it by submersion in dilute muriatic acid. It should then be dried and mounted in Canada balsam, with continued heat, so as to allow the specimen to soak in the fluid resin for some time before it cools. It is the white opacity of the extremity of the contour markings that produces the appearance of rings on a tooth-fang.

“The tooth-substance appears,” says Czermak, “on its inner surface, not as a symmetrical whole, but consisting of balls of various diameter, which are fused together into a mass with one another in different degrees, and on which the denterial tubes in contact with the

The dentine consists of a fine substance in which mineral matter largely predominates, though to a less degree than in the enamel. It is traversed by a vast number of very fine cylindrical, branching, wavy tubuli, which commence at the pulp cavity and radiate towards the surface. The cementum cor-

germ cavity are terminated. By reflected light, *back-ground* illumination, one perceives this stalactite-like condition of the inner surface of the tooth-substance very distinctly, by means of the varied illumination of the globular elevations, and by the shadows which they cast. Here one has evidently to do with a stage of development of the tooth-substance ; for the older the tooth is, the less striking in general are these conditions, and the more even is the surface of the wall of the germ-cavity. In very old teeth considerable unevenness again makes its appearance ; these, however, are not globular, but have a cicatrised, distorted appearance. It is best to make the preparation from a tooth of which the root is not perfectly completed. With such preparations, one is readily convinced that the ground-substance of the last-formed layer of the tooth-substance appears, at least partly, in the form of balls, which are fused among one another, and with the balls of the penultimate layers ; and one also perceives that in general their diameter becomes less and less, somewhat in the form of a point, towards the periphery of the tooth-substance. The majority of these balls are pierced through by one or more tubes, crosswise, passing from within outwards. Very frequently, however, they appear homogeneous, and contain no tubes." To obtain specimens, procure a tooth of which the fang is half-grown ; then introduce the point of a penknife into its open extremity, and scraping the inner surface, detach small portions, which exhibit the globules admirably.

"Another method of obtaining specimens which further illustrate the internal surface of the dentine is the following : In rubbing down a section of a tooth, as the operator approaches the pulp-cavity the last fibre of dentine frequently bulges into the unresisting cavity ; and instead of grinding up into particles, comes away in a small sheet,—a little film of dentine parallel with the pulp-cavity's surface, the innermost layer, and the one last formed. This should be carefully preserved and mounted. On viewing such a specimen by transmitted light, one sees the globules scattered about—some isolated, others more or less confluent ; and between them a pale, rather indefinite structure, uniting the whole into a sheet.

But the most instructive specimens are to be obtained from the very thin cap of dentine found upon the foetal pulp. The thin edge should be cut off, and examined on the inner surface ; it should be moist, and never allowed to get dry. In such specimens the globules are very apparent ; but, as Czermak observes, they do not appear superficial, but in the substance of the dentine. It is here, in the moist specimens, that the focus reaches the globules ; and, consequently,

there is no superficial stalactite-like bulging of globules, it is only in dry specimens that that is seen. *Now, if such a specimen be steeped in dilute hydrochloric acid, so as to remove all the earthy matters, the globules instantly vanish, and the dentine where they were seen assumes the same aspect as that where they were not seen.* No other change is produced. The existence of the globules, therefore, seems dependent upon the presence of earthy material.”*

BONE.

The elements of bone are lamellæ and small corpuscles ; the latter are possibly merely spaces between the former, in which is deposited the earthy substance. The lamellæ have for their basis cartilaginous substance combined with earthy matter, or salts. These salts are chemically combined with the organic basis. Acid dissolves only the earthy salts, and leaves the organic basis of the same form as the bone itself. The lamellæ are homogeneous throughout like the intercellular substance of cartilage, but chemically it is different, being resolved by boiling in water into *colla*, whereas cartilage is resolved into *chondrin*.

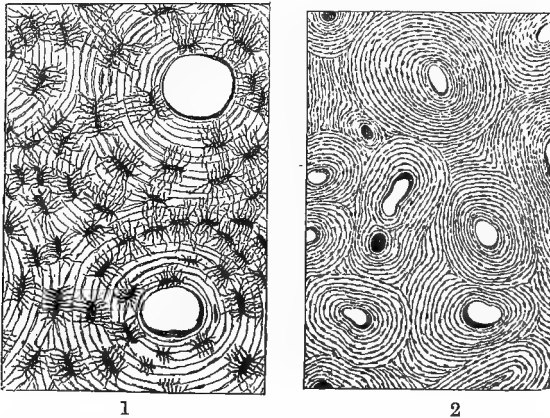

fig. 179.

1. A transverse section of the human clavicle, or collar-bone, magnified 95 diameters ; which exhibits the Haversian canals, the concentric laminae, and the concentric arrangement of bone-cells around them. Some of the Haversian canals are white, others black : the latter are filled with a deposit of opaque matter, used in the grinding and polishing the section. When viewed under a lower power, they appear to be only a series of small black dots, as shown in No. 2.

Professor Quekett has given, in the *Microscopical Society's Trans-*

* James A. Salter, M.B., *Quarterly Journal of Microscopical Science*, July 1853.

actions, a most excellent account of the "Intimate Structure of Bone." From this paper we propose to show the valuable results to be obtained by a microscopic investigation of bone.

"Bone consists of a hard and soft part; the hard is composed of carbonate, phosphate, and fluuate of lime, and of carbonate and phosphate of magnesia, deposited in a cartilaginous or other matrix; whilst the soft consists of that matrix, and of the periosteum which invests the outer surface of the bone, and of the medullary membrane which lines its interior or medullary cavity, and is continued into the minutest pores. If we take for examination a long bone of one of the extremities of the human subject, or of any mammalian animal, we shall find that it consists of a body or shaft and two extremities; if a vertical section of such a bone be made, we shall also find that the middle of the shaft contains a central cavity termed the medullary cavity, which extends as a canal throughout the whole of it, or else is entirely or partially filled up with a cellular bony structure, which cells are termed cancelli, and the structure a cancellated structure. On

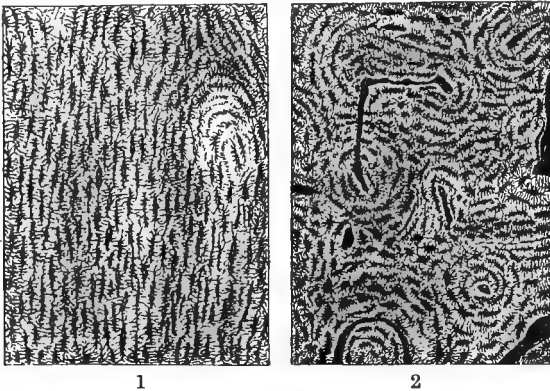

fig. 180.

1. A transverse section of the humerus, or fore-arm bone, of a Turtle (*Chelonia mydas*). It exhibits traces of Haversian canals, with a slight tendency to a concentric arrangement of bone-cells around them. The bone-cells are large and very numerous, but occur for the most part in parallel rows.
2. A transverse section of the femur, or leg-bone, of an Ostrich, magnified 95 diameters. When contrasted with the preceding figure, it will be noticed that the Haversian canals are much smaller and more numerous, and many of them run in a transverse direction.

a more careful examination of the bony substance, or shaft, we shall find it to be slightly porous, or rather occupied, both on its external and internal surfaces, by a series of very minute canals, which, from

their having been first described by our countryman Clopton Havers, are termed to this day the Haversian canals, and serve for the transmission of blood-vessels into the interior of the bone. Further than this we cannot proceed without optical assistance; but if now a thin transverse section of the same bone be made, and be examined by the microscope with a power of 200 linear, we shall see the Haversian canals very plainly, and around them a series of concentric bony laminae, from three to ten or twelve in number. If the section should consist of the entire circle of the shaft, we shall notice, besides the concentric laminae round the Haversian canals, two other series of laminae, the one around the outer margin of the section, the other round the inner or medullary cavity. Between the laminae is situated a concentric arrangement of spider-like looking bodies, which have, by different authors, received the name of osseous corpuscles, lacunae, or bone-cells, according as to whether they were ascertained to be solid or hollow: these bone-cells have little tubes or canals radiating from

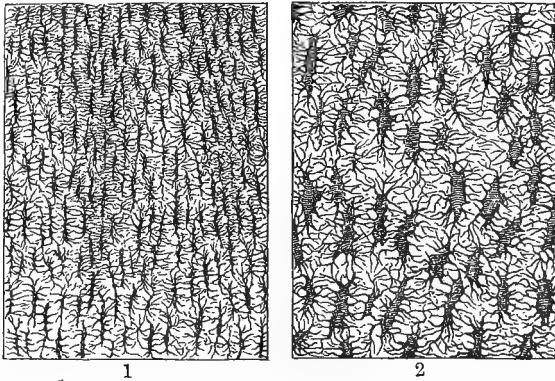

fig. 181.

1. A horizontal section of the lower jaw-bone of a Conger eel, which exhibits a single plane of bone-cells arranged in parallel lines. There are no Haversian canals present; and when this specimen is contrasted with that of fig. 180, No. 1, it will be noticed that the canaliculi given off from each of the bone-cells of this fish are very few in number in comparison with that of the reptile.
2. A portion of the cranium of a Siren (*Siren lacertina*), which is remarkable for the large size of the bone-cells and of the canaliculi, they being larger in this animal than in any other yet examined. As in the preceding specimen, no Haversian canals are present.

them, which are termed canaliculi by some authors, and tubes and pores by others: those bone-cells which are nearest the Haversian canals have the canaliculi of that side radiating towards the opening

into the Haversian canals ; whilst the canaliculi of the opposite side communicate with those of the layer of canaliculi more external to them ; and those in the outer row have most of their canaliculi given off from that side of the bone-cell which is nearest its own Haversian canal : hence arises the transparent white line which often may be noticed as surrounding each concentric system of laminæ and bone-cells : in some cases, however, part of the bone-cells of the external row anastomose with another series of bone-cells, which are situated between the concentric laminæ. The average length of the lacunæ, or bone-cells, in the human subject is the 1-2000th of an inch ; they are of an oval figure, and somewhat flattened on their opposite surfaces, and are usually about one-third greater in thickness than they are in breadth ; hence, as will be presently shown, it will become necessary to know in what direction a specimen is cut, in order to judge of their comparative size. The older anatomists supposed them, from their opacity, to be little solid masses of bone ; but if the section be treated with spirits of turpentine coloured with alkanet-root, or if it have been soaked in very liquid Canada balsam for any great length of time, it can then be unequivocally demonstrated that both these substances will gain entrance into the bone-cells through the canaliculi. The bone-cells, when viewed by transmitted light, for the most part appear perfectly opaque ; and they will appear the more opaque the nearer the section of them approaches to a transverse one : for when the cells are cut through their short diameter, they are often of such a depth that the rays of light interfere with each other in their passage through them, and darkness results ; whereas, if the section be made in the long diameter of the cells, they will appear transparent. When viewed as an opaque object, with a dark ground at the back and condensed light, the bone-cells and canaliculi will appear quite white ; and the intercellular substance, which was transparent when viewed by transmitted light, is now perfectly dark.

Thus much may be said to compose the hard part of the bone ; we must now turn our attention to the soft part. This, as has been before stated, consists of the periosteum, which invests the outer, and of the medullary membrane, which invests the inner surface, lines the Haversian canals, and is continued from them, through the canaliculi, into the interior of the bone-cells ; and of the cartilaginous or other matrix, which forms the investment of the minute ossific granules. The earthy matter of the bone may be readily shown by macerating the section for a short time in a dilute solution of caustic potash.

The animal matter may be procured by using dilute hydrochloric

acid instead of caustic potash, when the earthy matter will be removed, and the section will exhibit nearly the same form as when the earthy constituent was present; and when viewed microscopically, it will be noticed that all the parts characterising the section previous to its maceration in the acid will be still visible, but not so distinct as when both constituents were in combination. When, however, the animal matter is removed, the bone will not exhibit the cells and the canaliculi, but will be opaque and very brittle, and exhibit nothing but the Haversian canals and a granular structure.

If we consider what has been already mentioned as entering into the composition of a bone, viz. the medullary cavity, the Haversian canals, the canaliculi, and the bone-cells, we shall find that every part thus described has been more or less hollow; where, then, is the true

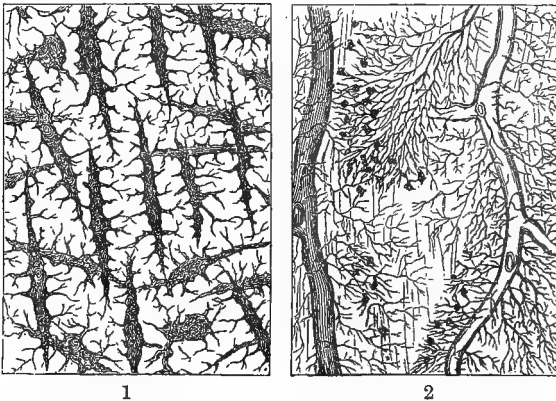

fig. 182.

1. A small portion of bone, taken from the exterior of the shaft of the humerus of a Pterodactyle, which exhibits the elongated bone-cells characteristic of the orders of Reptilia.
2. A horizontal section of a scale, or flattened spine, from the skin of a Trygon, or Sting Ray, which exhibits large Haversian canals, with numerous wavy parallel tubes, like those of dentine, communicating with them. It will be noticed that this specimen shows, besides these wavy tubes, numerous bone-cells, whose canaliculi communicate with the tubes, as in many specimens of dentine.

bony substance? This is no other than the small granules of ossific matter, which are situated between the canaliculi of the bone-cells, each granule having an investment of soft animal matter, by which the whole mass of granules is kept in firm apposition.

The parts, then, which a transverse or a longitudinal section of a long bone of a mammalian animal will exhibit, will be the Haversian

canals, the concentric bony laminæ, the bone-cells and their canaliculi ; although all these parts, except the bony laminæ, may be seen in all mammalian bones. Whether long or otherwise, they are, nevertheless, so differently arranged in the flat bones, such as those of the skull, and in the irregular bones, such as the vertebræ, as to require a short description at this stage of our inquiry.

The bones of the cranium are in all cases composed of two thin layers of compact texture, which enclose another layer of variable thickness, which is cellular or cancellated. The two outer layers are called tables,—the one being the outer, the other the inner table ; and the middle or cancellated layer is termed the diploe : in this last the principal blood-vessels ramify. The outer table of the skull is less dense than the inner ; the latter, from its brittleness, is termed by anatomists the vitreous table. When a vertical section of a bone of the skull is made so as to include the three layers above mentioned, bone-cells may be seen in all ; but each of the three layers will differ in structure : the middle or cancellated structure will be found to resemble the cancellated structure in the long bones, viz. thin plates of bone, with one layer of bone-cells without Haversian canals ; the outer layer will exhibit Haversian canals of large size, with bone-cells of large size, and a slightly laminated arrangement ; but the inner or vitreous layer will be found to resemble the densest bone, as the outer part of the shaft of a long bone for instance, and will exhibit both smaller Haversian canals, and more numerous bone-cells of ordinary shape around them.

A transverse section of the long bone of a bird, when contrasted with that of a mammal, will exhibit the following peculiarities ; the Haversian canals are much more abundant, and much smaller ; and they often run in a direction at right angles to that of the shaft, by which means the concentric laminated arrangement is in some cases lost ; the direction of the canals often follows the curve of the bone ; the bone-cells also are much smaller and much more numerous ; but the number of canaliculi given off from each of the cells is much less than from those of mammals : the average length of a bone-cell of the ostrich is 1-2000th of an inch, the breadth 1-6000th.

In the Reptilia, the bones may be either hollow, cancellated, or solid ; and, generally speaking, whichever form prevails, the bone may be said to be very compact and heavy, but the specific gravity not so great as that of birds or mammals.

The short bones of most of the Chelonian reptiles are solid, but the long bones of the extremities are either hollow or cancellated ; the ribs of the serpent tribe are hollow, the medullary cavity performing the

dom happens that the bone-cells are visible in it ; but by a fragment from about the middle of the laminae of the shaft the characteristic bone-cells can at once be recognised. But in the comparison of the bone of a mammal with that of a bird, from the peculiarity in the arrangement of the Haversian canals in the latter class, it is highly important always to bear in mind that the specimens used for comparison should be cut in one and the same direction ; for as it has been stated that the bone-cells, on which we are to rely for our determination, are always longest in the direction of the shaft of the bone, it would follow, that if one section were transverse and the other longitudinal, there might be a vast difference in the measurement of the bone-cells, in consequence of their long diameter being seen in the one case, and their short diameter in the other : hence the caution of having all the sections made in one direction. In all doubtful cases, the better plan is to examine a number of fragments, both transverse and longitudinal, taken from the same bone, and to form an opinion from the shape of bone-cell which most commonly prevails.

Preparing Sections of Bone.—Sections of bone or teeth may be cut with a fine saw, such as is used for cutting metal ; then filed down with a flat *safe-edged* fine file, and afterwards polished between two hones of the Water of Ayr stone, or two pieces of very smooth boxwood ; finally polish off on a strop of buff-leather charged with putty powder.

Should the specimen be small or brittle, after it has been filed and rubbed down on the hone, and polished on one side, dry it, and cement it—polished side downwards—with Canada balsam to a slip of glass ; when the balsam is dry and hard, proceed to file and polish the other side ; the section must be examined from time to time under the microscope, and when found to be thin enough, it can be easily removed from the glass by steeping it for a short time in ether. After the section has been dried, it is ready for permanent mounting : this may be done by immersing it in a thin cell of fluid, or in Canada balsam ; if in the latter, it should be imbedded in it, and heat employed to expel all air-bubbles, and fill up the lacunæ and canals in the bone.

When we wish to examine the bone-cells of fossil bone, chippings only are required ; these may be procured by striking the bone with the sharp edge of a small hammer used by mineralogists : carefully select the thinnest of the chips, and mount them at once without grinding in Canada balsam.

All sections of recent and greasy bones should be soaked in ether for some time, and afterwards dried in the air, before they are fit for the

PLATE XV.

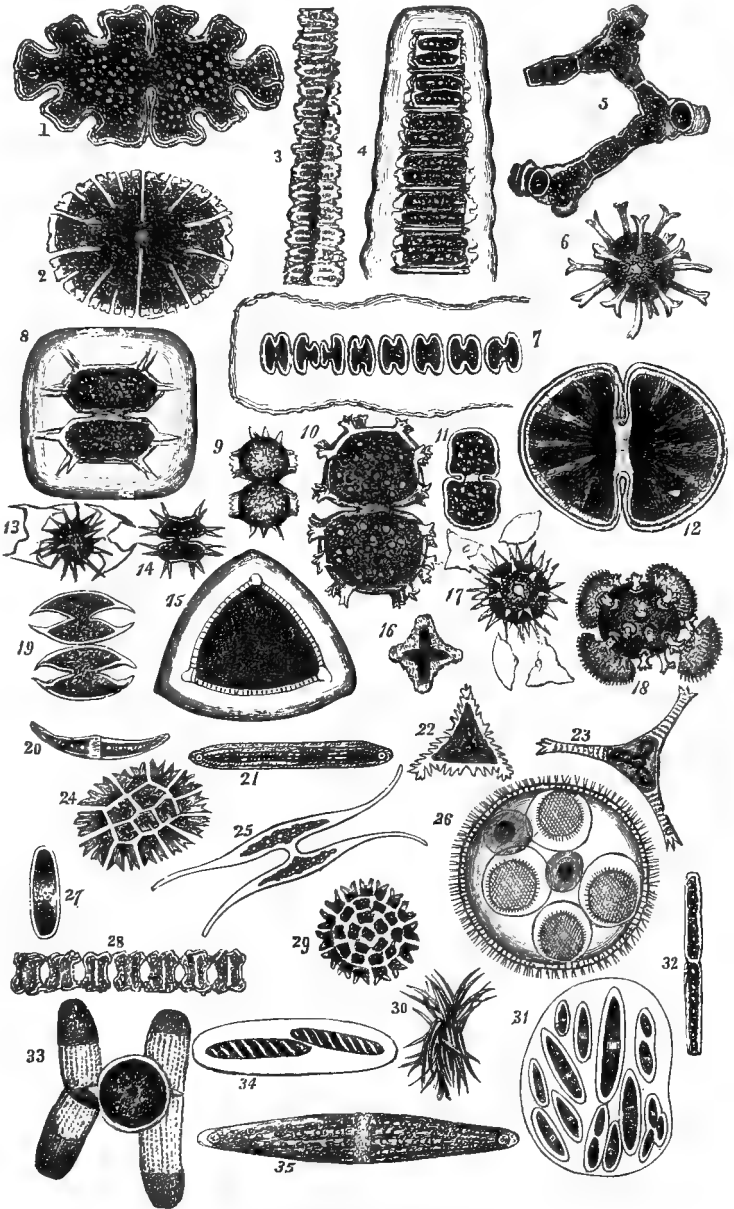

VEGETABLE CELLS, DESMIDACEÆ.

saw, file, and hone ; by dissolving out the grease, the lacunæ and canaliculi show up very much better. A lapidary's wheel will be a most useful article for grinding and polishing sections of bone or teeth.

Having thus briefly examined a few of the more important structures of the animal economy, and imperfect in a detailed point of view though that examination be, we trust it may be found to smooth the way, or in some degree assist the investigations of the student to a better and more general survey of the whole fabric. Such a survey will not be unattended with its difficulties and disappointments ; nevertheless, it will fully reward him for any amount of labour he may bestow.

The importance of being thoroughly familiar with the structure and microscopical characters of any particular organ in a healthy condition, cannot be too strongly urged upon the attention of the student ; as to a want of this knowledge must be attributed many erroneous descriptions of morbid appearances. All who wish to use the microscope successfully, with reference to the examinations of organs in disease, will do well to become acquainted with minute anatomy generally, not only of the human subject, but of the lower animals ; without such knowledge it will be found impossible to prosecute pathological inquiries with any degree of success.

To the medical student, desirous of obtaining farther information in this especial department of microscopy, we can recommend a very valuable little book by Dr. Beale, on *The Microscope, and its Application to Clinical Medicine*. Also Dr. Bennett's *Lectures on the Study of Clinical Medicine*, where some excellent hints will be found on the proper mode of investigating animal structures.

The principal physical characters to be regarded in microscopic examinations may be summed up as follows :

1. *Shape*.—Accurate observation of the shape of bodies is very necessary, as many are distinguished by this physical property. Thus the human blood-globules presenting a round biconcave disk, and are in this respect different from the oval corpuscles of birds, reptiles, and fishes. The distinction between round and globular is very requisite. Human blood corpuscles are round and flat ; but they become globular on the addition of water. Minute structures seen under the microscope may also be likened to the shape of well-known objects, such as that of a pear, balloon, kidney, heart, &c.

2. *Colour*.—The colour of structures varies greatly, and often differs under the microscope from what was previously conceived regarding them. Thus the coloured corpuscles of the blood, though commonly called red, are, in fact, yellow. Many objects present different colours,

according to the mode of illumination ; that is, as the light is reflected from or transmitted through their substance, as in the case of certain scales of insects, feathers of birds, &c. Colour is often produced, modified, or lost, by re-agents ; as when iodine comes in contact with starch-granules, when nitric acid is added to chlorophyle, or chlorine-water to the pigment-cells of the choroid, and so on.

3. *Edge or border.*—This may present peculiarities worthy of notice. Thus, it may be dark and abrupt on the field of the microscope ; so fine as to be scarcely visible ; or it may be smooth, irregular, serrated, beaded, &c.

4. *Size.*—The size of the minute bodies, fibres, or tubes, which are found in the various textures of animals, can only be determined with exactitude by actual measurement. It will be observed, for the most part, that these minute structures vary in diameter ; so that when their medium size cannot be determined, the variations in size from the smaller to the larger should be stated. Human blood-globules in a state of health have a pretty general medium size ; and these may consequently be taken as a standard with advantage, and bodies may be described as being two, three, or more times larger than this structure.

5. *Transparency.*—This physical property varies greatly in the ultimate elements of numerous textures. Some corpuscles are quite diaphanous ; others are more or less opaque. The opacity may depend upon corrugation or irregularities on the external surface, or upon contents of different kinds. Some bodies are so opaque as to prevent the transmission of the rays of light ; in this case they look black when seen by transmitted light, though white if viewed by reflected light : others, such as fatty particles and oil-globules, refract the rays of light strongly, and present a peculiar luminous appearance.

6. *Surface.*—Many textures, especially laminated ones, present a different structure on the surface from that which exists below. If, then, in the demonstration, these have not been separated, the focal point must be changed by means of the fine adjustment. In this way the capillaries in the web of the frog's foot may be seen to be covered with an epidermic layer, and the cuticle of certain minute fungi or infusoria to possess peculiar markings. Not unfrequently the fracture of such structures enables us, on examining the broken edge, to distinguish the difference in structure between the surface and the deeper layers of the tissue under examination.

7. *Contents.*—The contents of those structures which consist of envelopes, as cells, or of various kinds of tubes, are very important. These may consist of included cells or nuclei, granules of different kinds,

pigment matter, or crystals : occasionally their contents present definite moving currents, as in the cells of some vegetables ; or trembling rotatory molecular movements, as in the ordinary globules of saliva in the mouth.

8. *Effects of Re-agents.*—These are most important in determining the structure and chemical composition of numerous tissues. Thus water generally causes cell-formations to swell out from endosmosis ; while syrup, gum-water, and concentrated saline solutions cause them to collapse from exosmosis. Acetic acid possesses the valuable property of dissolving coagulated albumen, and in consequence renders the whole class of albuminous tissues more transparent. Thus it operates on cell-walls, causing them either to dissolve, or become so thin as to display their contents more clearly. Ether, on the other hand, and the alkalis, operate on fatty compounds, causing their solution and disappearance. The mineral acids dissolve most of the mineral constituents that are met with ; so that in this way we are enabled to tell with tolerable certainty, at all events, the group of chemical compounds to which any particular structure may be referred.

Should it be desirable to make an examination of the vital fluid, *blood*, the smallest drop, caused by the prick of a fine needle, may be placed on a strip of glass, and waved backwards and forwards, that the blood may dry as quickly as possible ; in this way the corpuscles or blood-disks will retain their form ; and if the preservation of the specimen is wished, a thin glass-cover must be placed over it, and cemented down in the way directed at page 77.

To the advanced observer, the examination of the mucous membrane will afford some instruction. Should the specimen be small, it will be better to pin it to a piece of cork ; then well wash it by means of a small syringe. If the investing epithelium be required for examination, a portion may be detached from the surface by a knife, placed on a glass slide, and viewed as a transparent object with a $\frac{1}{4}$ -inch power. Villi and papillæ are best seen upon injected specimens.

TO VIEW THE CIRCULATION OF BLOOD IN THE FROG.

The part most commonly employed for this purpose is the transparent web of the hind foot ; and in order to secure the animal, and keep its web open, various contrivances have been had recourse to. The older microscopists, Baker, Adams, and others, were in the habit of tying the frog to a frame of brass with some fine cord ; in the present day the entire body of the animal, with the exception of the foot to be

examined, is secured in a black silk bag ; and this is fastened to a plate of brass, termed the frog-plate, shown at *a a a* in fig. 183 : this should be contrived so as to be held firmly by some part of the stage of the microscope, and permit of its being moved about with it. Although the shape of the plate differs with every maker, the mode of using it, nevertheless, is nearly the same in all. The bag provided should be about three or four inches in length, and two and a half inches broad, as shown at *b b*, having a piece of tape, *c c*, sewn to each side, about midway between the mouth and the bottom ; and the mouth itself capable of being closed by a drawing-in string, *d d*. Into this bag the frog is placed, and only the leg which is about to be examined kept out of the mouth ; the string *d d* is then to be drawn so tight around the small part of the leg, as to prevent the foot from being pulled into

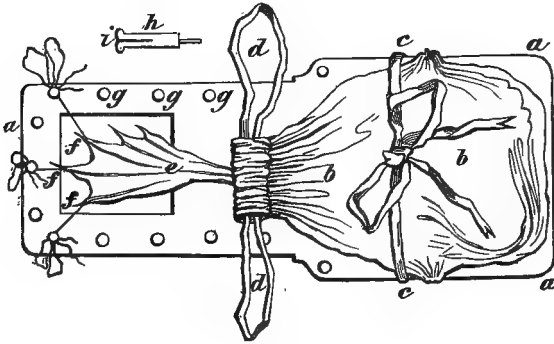

fig. 183.

the bag, but not to stop the circulation ; three short pieces of thread, *fff*, are now to be passed around the three principal toes ; and the bag with the frog is to be fastened to the plate *a a* by means of the tapes *c c*. When this is accomplished, the threads *fff* are to be passed either through some of the holes in the edge of the plate, three of which are shown at *g g g*, in order to keep the web open ; or what answers better is a series of pegs of the shape represented by *h*, each having a slit *i* extending more than half-way down it ; the threads are wound round these two or three times, and then the end is secured by putting it into the slit *i*. The plate is now ready to be adapted to the stage of the microscope : the square hole over which the foot is placed must be brought over the aperture in the stage through which the light passes to the object-glass, so that the web may be strongly illuminated by the mirror. The power required to view the circulation will be a one-inch

or half-inch object-glass ; a higher power will be needed to show the rhythm of the veins.

In the common newt, as well as the frog, the circulation may be viewed : the tail of the young animal being much used for this purpose, and showing other interesting points of structure.



fig. 184. *The common smooth Newt : male.*

The warty newt is in a state of great activity early in spring. It is common in ponds and large ditches, where it feeds upon the tadpole of the common frog. The male and female newt are nearly the same in appearance during winter ; but in spring a beautifully-cut crest rises from the back of the male, which is highly ornamental.

The manner in which the eggs are deposited is very interesting. The female, selecting the leaf of some aquatic plant, sits, as it were, upon its edge ; and folding it by means of her two binder feet, deposits a single egg in the duplicature of the folded part of the leaf, which is thereby glued most securely together, and the egg is thus effectually protected from injury. As soon as the female has in this way deposited an egg, she seeks another leaf, on which she deposits another egg in the same manner ; and in this way she proceeds till she has deposited as many eggs as she requires. The egg is very slightly tinged with buff, and is surrounded by a substance resembling the white of a common egg, in which it keeps continually whirling round. It now goes through nine changes from the egg till it becomes a perfect animal ; and for a considerable time it remains in a tadpole state, almost like the common frog.

Newts are readily found in many of the ponds around London. The watercress-gatherers meet with them in large numbers.

FISH.

It has often been observed, that we are surrounded by wonders which we do not notice because they are of daily occurrence, but which

excite the greatest surprise when they are pointed out to us. The truth of this observation is forcibly exemplified as regards fish. We see them every day exposed for sale on stalls, and we eat them frequently at our tables, without once considering by what a curious and delicate organisation these creatures are enabled to see and breathe in an element that carries death to us and to quadrupeds. The sight of fishes appears to be remarkably strong, as it is by sight chiefly that they discover their prey. Hence a fish is easily deceived by an artificial fly, or the imitation of a frog or other small aquatic or amphibious animal ; which, if it were guided by the smell, or any other sense than the sight, could not happen. The mode in which fishes breathe is, however, the most curious. They have no lungs ; but, instead of them, they have gills, carefully covered with a lid and a flap, both of which the fish can open or keep closed at pleasure. The gills are composed of arches bordered by a kind of fringe, which, when examined through the microscope, is seen to be covered with a velvet-like membrane, over which myriads of wonderfully minute blood-vessels are spread, like a delicate network. There are commonly four of these fringed arches : they are movable, and allow the currents of water driven down by the action of the mouth to flow freely through them, so as to lave every fibril. It is absolutely necessary that this should be the case, since the gills lose their power of acting as soon as they become dry ; and hence a fish cannot live long after it is taken out of the water. As there is danger, however, of the food taken by the fish being carried through the gills by the stream of water constantly flowing through them, the minor curve of the arch formed by the gills is studded with spines, which prevent any thing but air or water passing through them.

A knowledge of the form and structure of scales of fishes, like that of teeth, has been shown by M. Agassiz to afford an unerring indication of the particular class to which the fish may belong : in the examination of fossil remains, the application of this knowledge has been attended with extraordinary results. As a class of objects for the microscope, the scales of fishes are exceedingly curious and beautiful, especially when mounted in fluid or Canada balsam, and viewed by polarised light. Many are seen best as opaque objects, and are then mounted dry between glasses. M. Agassiz divided the scale into four orders, which he named *Placoid*, *Ganoid*, *Ctenoid*, and *Cycloid* ; in the first two the scales are more or less coated with enamel, in the others they are of a horny nature. To the *Placoid* order belong the skates, dog-fish, ray, and sharks ; cartilaginous fishes, having skins covered with

small prickly or flattened spines. To the *Ganoid* belong the sturgeon, lepidosteus, hassar-fish, and polypterus ; the fish of this order are more generally found in a fossil state, and their scales are of a bony structure. To the *Ctenoid* belong the pike, perch, pope, basse, weaver-fish, &c. ; their scales are notched like the teeth of a comb. To the *Cycloid* belong the salmon, herring, eel, carp, blenny, and the majority of our edible fishes ; their scales are circular and laminated. The scales of the eel tribe are of an oval figure, and are amongst the most remarkable that can be selected for microscopic examination. To procure them, a sharp knife must be passed underneath the epidermal layer, and a portion of this raised, in the same manner as described for tearing off the cuticle of plants : after some trials a few will be detached. They are of an oval figure, rather softer than the scales of other fishes, and in some parts of the skin do not form a continuous layer. When the skin has been stripped off, previous to the fish being cooked, the scales may be obtained from the under surface by tearing them away either with a knife or pair of forceps. The scales of the viviparous blenny are of a circular figure, and situated under the epidermal layer ; they have been described by Mr. Yarrell as mucous glands, in consequence of their figure and the smallness of their numbers. The surface of the skin of this fish, when fresh, appears to be covered with follicles ; if, however, a portion be scraped off, it will be seen to be a mass of delicate circular scales. A piece of the skin, when dried, will exhibit the scales to great advantage, and, like those of the eel, is a beautiful object for polarised

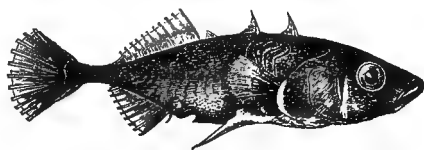

fig. 185. *The Stickleback.*

light. The colours of fishes are said to be due to the presence of fatty matter in the skin ; but the beautiful metallic tints displayed by so many of them are produced by the numerous microscopic plates, or scales, which are distributed over the surface of the true skin.

It will interest our readers to know, that Mr. Lloyd, of 164 St. John Street Road, has taken steps to fit-up and stock marine and fresh-water *aquaria* with fish and appropriate plants, at very moderate prices.

CHAPTER VII.

VEGETABLE STRUCTURE—VITAL AND CHEMICAL CHARACTERISTICS—THE
 VEGETABLE CELL—FUNGI—ALGÆ—MOSESSES—VOLVOX—DESMIDACEÆ
 —STRUCTURE OF PLANTS—FUNGOID DISEASES—ADULTERATION OF
 ARTICLES USED FOR FOOD—PREPARATION FOR MICROSCOPIC EXAMI-
 NATION—CUTTING SECTIONS—WARINGTON'S MICROSCOPE—MAGNIFY-
 ING POWER OF THE EYE—CONCLUSION.*



SINCE the introduction of the achromatic microscope, we have obtained nearly the whole of the valuable information which we now possess relative to the minute structure of vegetables. Before that time, although some progress had been made in vegetable physiology, yet the means of distinguishing one structure from another, with their several external characters, comprehended the amount of our botanical knowledge. "The vegetation which every where adorns the surface of the globe, from the moss that covers the weather-worn stone, to the cedar that crowns the mountain, is replete with matter for reflection. Not a tree that lifts its branches aloft, not a flower or leaf that expands beneath the sunlight, but has something of habit, of structure, or of form, to arrest the atten-

* DESCRIPTION OF PLATE XV.—DESMIDACEÆ, AFTER RALFS.

	No.		No.
<i>Euastrum oblongum</i>	1	<i>Penium</i>	21
<i>Micrasterias rotata</i>	2	<i>Staurastrum</i>	22
<i>denticulata</i>	6	<i>gracilis</i>	23
<i>Desmidium quadrangulatum</i>	3	<i>Pediastrum biradiatum</i>	24
<i>Didymoprium Grevillii</i>	4	<i>pecticum</i>	29
<i>Borreri</i>	5	<i>Volvox globator</i>	26
<i>Sphærozozma vertebratum</i>	7	<i>Penium Jenneri</i>	27
<i>Xanthidia</i> 9, 8, 10, 13, 14, 17, 19	15	<i>margaritaceum</i>	33
<i>Staurastrum, tumidum</i>	15	<i>Aptogonum desmidium</i>	28
<i>dilatatum</i>	16	<i>Ankistrodesmus falcatus</i>	30
<i>hirsutum</i>	18	<i>Spirotænia</i>	34
<i>Cosmarium Ralfsii</i>	11, 12	<i>Docidium clavatum</i>	32
<i>Closteria</i>	20, 25, 31, 35		

tion." The microscopist sees proof of a higher life in plants than he before conceived ; and he becomes convinced, after examining the functions which their organs are destined to perform, that animals and plants are only separate links in the great chain of organic nature.

Plants are organised beings ; that is, individuals composed of a number of essential and mutually dependent parts : in common, therefore, with animals, they possess a principle which is in continued action ; and which operates in such a manner, that the individual parts which it forms in the body are adapted to the designs of the whole. Or, in more intelligible language, plants are *living bodies*. Like animals, they are the offspring of other beings similar to themselves ; they grow, are endowed with *excitability*, have their periods of *infancy, adult age, decay, and death*. Their affinity to animals is much closer than is commonly supposed. The vital or creative power exists already in the germ, in plants as well as in animals ; and by its influence the essential parts of the future plant are formed. It might be supposed that the lateral generation of plants—namely, that renewal of the individual which is the result of budding or *gemination*—is sufficient to distinguish them from animals ; but this opinion is erroneous, as we find that the formation of gems or buds is common in animals belonging to the *Protozoa*. In the hydra, we perceive the germs developed as small ovoid elevations upon the cylindrical body of the animal, and when examined in this state, they are, like the first formation of the buds in plants, mere masses of cells ; but as their growth proceeds, these cells undergo a special arrangement, so as to produce the different tissues of the body, and acquire the proper form of the polyp : on the same principle, the bud in the plant is gradually developed, until it terminates, and becomes a branch.

Plants, like animals, possess excitability, or the faculty of being acted upon by external stimuli, impelling them to the exertion of their vegetable powers. Light acts on plants, directing the growth of the stem, vigour, and colour, the direction of the branches, position of leaves, the opening and shutting of flowers. Heat influences the protrusion of buds, and other stimulants affect the vegetable irritability ; as an instance of this, cut plants, when fading, revive if placed in water impregnated with certain chemicals.

Besides the physical and physiological distinctions generally pointed out as marking the line between animals and plants, chemistry furnishes many others. Thus, one of the great functions of a plant is to decompose water, and assimilate its components to the vegetable tissues ; whilst it is a property of animal life constantly to reform it from its

elements. The oxygen derived from the atmosphere, by whatever means it is introduced into the animal system, is expended in the production of carbonic acid and water, both of which are thrown off as excretions. It is true that water is exhaled in great quantities from the surfaces of plants; but it is that fluid which has been taken into the system of the plant, and has not undergone decomposition; it is, therefore, not actually found in the body of the vegetable, as it is in that of the animal. During the process of vegetation, *protein* is formed from the constituents of water with carbonic acid and ammonia; *protein* is formed in the animal body, and enters largely into the blood and muscle.

There is the closest affinity in the chemical nature of the products between plants and animals. Vegetable *albumen* is identical in composition with that in blood and in eggs; *casein* does not materially differ in milk and the juices of some plants: we have many other equally striking characteristics, which modern chemical investigations have unfolded. Plants in some characteristics differ most strikingly, in being almost destitute of voluntary sensation and motion: here we would not have *sensibility* confounded with *irritability*, a principle which plants, in common with animals, possess. The simplest forms of animal life manifest both sensation and volition, even those that are fixed to rocks and other bodies presenting a ramified and vegetative form; for instance, in the compound polyps, each individual polyp displays both sensation and voluntary motion. It is, nevertheless, difficult to attribute satisfactorily the movement of some plants to irritability alone. Thus we find plants, in an apartment with light admitted on one side, not only turn the upper surface of their leaves to the light, but bend their stems and branches towards it. Many other instances might be cited; but none of them, excepting the movements of the *Oscillatoria*, more closely resemble volition. Plants, again, differ from animals in having no nervous system. All animals, without distinction, have a nervous system. Ehrenberg traced and described "vessels and nerves in the *Rotatoria* and some *Infusoria*."

Another great distinction is connected with the function of digestion, which the simplest form of animals possess: those even which turn inside out, the hydra, &c. have an internal cavity, into which their food is taken at intervals; but vegetables are nourished from the surface, and by continual imbibition.

It has been supposed, because the sap rises in plants, and in the interior of some *internodia* and cells of some simple plants a rotatory motion of fluid can be perceived, that plants, like animals, have a cir-

ulation of fluids. This opinion is at least disputable, the sap of plants ascending only once,—for that which is termed the descending sap of the plant is the proper juice prepared in the leaf; and the fact of currents being observed in opposite directions, is no proof of the existence of a circulation. But it may be asked, is the motion in the *Chara* or the cells of the *Vallisneria spiralis*, or in the hairs of the radicle fibres of *frog's-bit*, any proof of a circulation? It is certainly a proof of the motion of a fluid in the cells of a plant, and is very different from a general circulation of the sap; which is the only answer that can be made to such an inquiry: and the true circulation in animals is derived from an internal impelling power, and not from external influences.

A more distinctive character is obtained in the products of the respiratory function in plants: respiration is performed by the entire surface in most animals, as it is by all plants; but the products are different. In plants, the process consists chiefly in the conversion of carbonic acid and water into vegetable matter; hence oxygen is exhaled from the leaves, and carbonic acid absorbed by them from the atmosphere; and it is by the decomposition of that acid in the leaf, that the greater part of the oxygen is restored to the air. And although plants exhale carbonic acid during the night and in the shade, yet the quantity is small; and plants are, in reference to their respiration, a balance in the opposite scale to animals; they remove from the air the carbonic acid exhaled from the lungs and spiracles of animals, and re-supply the oxygen requisite for their respiration. Without the vegetable tribes, the atmosphere would soon cease to be fitted for the present race of animals; without the carbonic acid formed by animal respiration, plants would lose the greater part of their nutriment; and by their reciprocal action the atmosphere is preserved very nearly unchanged. Therefore the most important difference between the two may be said to be essentially that pointed out by Dr. Lankaster, *in the nature of the distinctive character of the gases inhaled and exhaled* by animals and by plants. With this brief survey, we may conclude our comparative view of plants and animals by stating, that whilst they are endued with many properties and functions common to both, they possess others sufficiently distinctive, which prevent them from being regarded as parts of the *same link* in the chain of vital existence.

As we pass on to a more intimate examination of the various structures entering into a plant, it will be seen that we have objects of the deepest interest presented to our notice; and strikingly differing as we find plants and animals in some essentials, we shall here, at our

starting-point, find them gradually coalescing, until they meet in a common granule—"that of the simple and individual cell."

Mülder, in describing this starting-point of life, says: "The cell is a concave globule. This concave globule is an individual; in the most simple form in which it can possibly exist (in the lowest moulds), it possesses all the powers of the molecules united into one whole, and thus reduced to a state of equilibrium. This state depends, not only on the nature of the substances and of their elements, carbon, hydrogen, oxygen, and nitrogen, but also on their form. The state of equilibrium, therefore, could not exist, unless this concave globular form existed. Moreover, this hollow globule possesses the whole of these forces in a state of mutual combination, co-operating for one end; this being a peculiarity which also apparently depends on the globular form."

Cells from which plants are formed are very small delicate closed sacs, partaking of many forms, and enclosed in a perfectly transparent membrane, so excessively thin, that it is with difficulty detected, unless iodine or some colouring-matter be previously added. Dead and old cells form an exception, as they become thickened, and the broken surfaces are then readily detected. At one time the cells were said to be developed by an extrication of gaseous matter among mucus; but the double walls which separate cells are irreconcilable with such an origin. Mr. Thwaites regards the original wall of the cell as a mere shell, having quite a subordinate office to perform in the growth of plants; and he ascribes all the vital powers of growth to the cytoblast and colouring-matter of the central nucleolus. He supposes the cell-membrane to arise from the action of electrical currents upon mucus, and that fissiparous division is caused by the presence of two centres of electrical force, each giving rise to a set of currents, and producing two cell-membranes instead of the original one. For further information on this very interesting subject, see Henfrey's translation of Mohl's *Vegetable Cell*; and Dr. J. B. Sanderson, on "Vegetable Reproduction," *Cyclopaedia of Anatomy and Physiology*.

The first and most curious exemplification of the simple cell is the fungi known as the *Yeast Plant*: it consists of two parts, the *cell-wall*, composed of a matter termed *cellulose*, and the contents of the cells, resembling fat or oil. The notion that yeast was an organised being, in fact a living plant, was at first strongly opposed by even Berzelius and Liebig; but by the microscope they have been convinced both of its organisation and vitality. The scientific name by which it is known is *Fermentum cervisia*, or *Torula cervisia*; it consists of globular or

ovoidal transparent nucleated cells, represented in the accompanying fig. 186, and showing its stages of growth as first observed by Turpin,

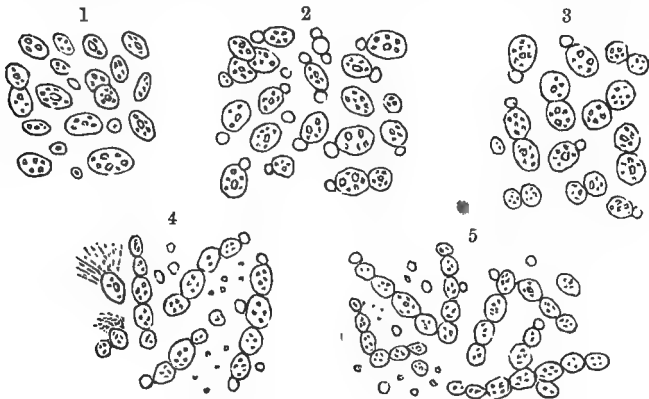

fig. 186. *The growth of the Yeast Plant.*

who carefully watched the changes after mixing it with some newly-made beer. Fresh yeast has the appearance seen at No. 1; one hour after it had been added to the wort, germination commenced, and produced two buds or cells, as at No. 2. In three hours they were doubled, as at No. 3, and attained the size of the maternal cell. In eight hours the plants began to ramify, as at No. 4, and some to explode, emitting a fine powder; and in three days jointed filaments with lateral branches were produced, as at No. 5.

Yeast-cells occasionally form in the human body under certain states of disease, principally occurring in the urine of patients; hence the cell has been named *Torula diabetica*: for the sake of comparison a few of those cells, highly magnified, are represented at No. 9, fig. 187. Mr. Busk met with a peculiar disease of the stomach, in some patients under his care vomiting another form of this remarkable fungi, named by Professor Goodsir *Sarcina ventriculi*; this presented under the microscope an appearance very nearly resembling the *Gonium pectorale* represented in fig. 95. Dr. John Ogle tells us that he has met with *Sarcina* where disease was never previously suspected to exist, averaging one out of every five or six stomachs examined. Are not these *Sarcina* taken into the stomach with impure water?

The *Mycoderma cervisia* of Desmazières is another stage of growth of the same plant deposited in porter-vats. Its various stages are shown in fig. 187, Nos. 6, 7, and at 8; the perfect plant is seen, with

its granular contents in the stem. One of the most remarkable of this tribe has been committing great devastation among our grape crops

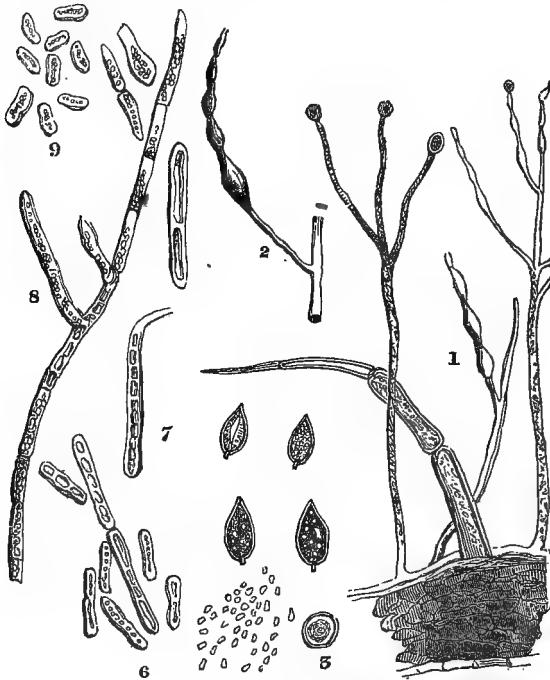

fig. 187. *Fungoid disease.*

1. A section of the Tomata, showing the sporangiæ growing from the spawn or root (*mycelium*). 2 shows a budding from the upper part of a branch. 3. Vertical and lateral view of sporangiæ, with their granular contents turned out. 6, 7, and 8 show different stages of growth of *Mycoderma cervisia*. 9. *Torula diabetica*.

during the past two years. A section of the grape, magnified 75 diameters, is seen in fig. 188 ; the fungi or mildew is growing from a section of the skin of the grape.

“Grapes,” says Mr. Harris, “when blighted, are covered with what appears to be a white powder, like lime, a little darkened with brown or yellow. These fungi send forth laterally, in all directions, thread-like filaments, which become so completely interwoven with one another as entirely to cover and enclose the skin of the grape in a compact and firm network, and on each is seen the egg-shaped capsule or seed-pod.”

Fungoid diseases among our growing crops attracted but little attention until the mischief produced by them became serious ; and the microscope has enabled us to determine and grapple with the destroyer in its variety of forms ; thus, we have our corn-crops withering under the blighting influence of the *Uredos* and *Puceinias*, our vines, &c.,

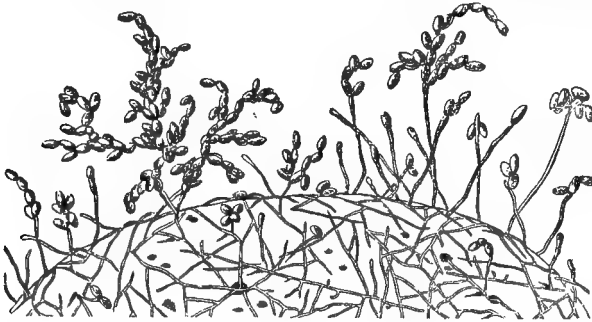

fig. 188. Section of a Grape.

under that of the *Oidium*, our esculents under the *Botrytis infestans* (potato-blight): the same disease is seen to infect the tomata, fig. 187.

The microscope has revealed to us that many of the skin diseases attacking the human frame are but other forms of the same growth of parasitic fungi, or cryptogamia, another low form of plant, presenting at first filaments simple, then ramified, and formed by a single elongated cell, or several cells placed end to end, as in those of the yeast-plant. The disease known as *Ringworm*, infesting the heads of children, is one out of forty-eight different species of *Cryptogamia*. The conditions of growth of this low form of vegetable life on the human body are the same as in other situations. Dr. Gudden, who has lately published a work upon *Cutaneous Diseases caused by "Parasitic Growths,"* describes Ringworm under the name of *Porri-go-fungus*; the spores of which are round on the upper, and filamentous on the under surface. Whenever the healthy chemical processes of nutrition are impaired, and the incessant changes between the solids and the fluids slacken, then the skin may furnish a proper soil for the fungi to take root in, should the sporules come in contact with it. That dreadful disease known as cancer will no doubt ultimately prove of vegetable growth, or a conversion of the nutritive animal cell into that of a fungoid vegetable cell.

The Rev. S. G. Osborne, during the cholera visitation of 1854, endeavoured to direct public attention to the very general distribution of fungi. He says, "Only those who have closely studied these fungi can

be aware how very minute and yet how systematically formed they are. Preparations of a dozen different species, taken from the grape, potato, parsnip, bean, cucumber, cineraria, veronica, &c., many of which have been in fluid for more than a year, retain their form as perfectly as if only taken from the plant a day. No two are alike in form; but all are alike in this—under the very high powers of the microscope, they show an external hyaline case, with a second utricle, or inner case, full of minute spores.

If a few leaves of the infected haulm of the potato are taken and gently shaken over a piece of black paper, a quantity of very fine white powder is obtained: place a little of this in fluid, under a power of 500 linear; every atom of this powder will resolve itself into a distinct cell, somewhat of the form of an ace of spades, varying more or less in size from about 3-5000ths of an inch in length. There will be seen a well-defined outline of an inner cell, in which are many hundred greenish-looking spores; some of the cells will burst, and by using a still higher power it will be seen that these have all the shape and characteristics of the parent cell. Several of them lie easily between the lines on a micrometer, which lines are just 1-5000th of an inch apart. In Plate XV. the destructive effects upon the tuber are shown.

There can scarcely be one spot of earth on which these fungi do not fall in their thousands. Insoluble in nature, they wait where they fall the growth of the particular plant for which each has its own affinity, that if that plant grows on that spot, its enemy is near, on the very soil from which it is to draw life. But I further believe that there must be some peculiar disposition yet to be developed in the plant before the fungus will act upon it, to its own rapid development, and the destruction of the said plant."

Fig. 189, 4 and 6, represents forms of fungi taken in London by the author during the cholera visitation, September 1854.

Our limited knowledge of the matter does not forbid the supposition that there may be some, even among the purely vegetable fungi, which might, in certain conditions of the human body, when taken into the frame, produce immediate severe constitutional disturbance. The *Sarcina* may be cited as an instance of this fact. It strikes us, however, as far more probable, that from drains and cesspools—reservoirs as they are for excrementitious animal matter—may emanate certain specific fungi, the spores of which, under certain conditions of atmosphere, would be given out in such quantities, and in such minute particles, as easily to be carried about by every current of air. Persons in health may inhale and swallow these spores, and escape injury from them. Other

persons, depressed physically from local or accidental causes, may afford to them just the *pabulum* which will develop their poisonous quality.

Many animal organisms, such as infusorial animalcules and their ova, are frequently found floating about in the air, as well as the fungi spoken of.

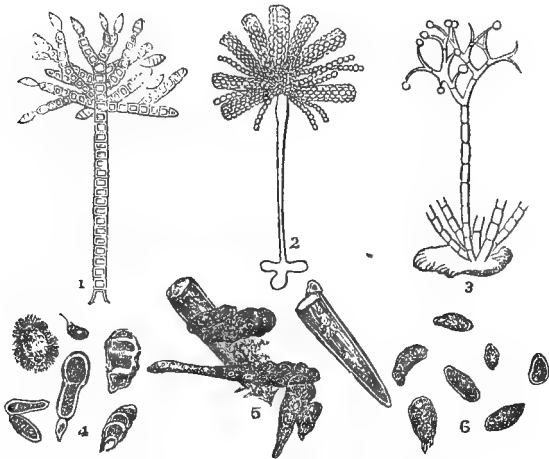

fig. 189. *Fungi*. Magnified 200 diameters.

1. *Brachycladium penicilatum*, found on the stem of plant. 2. *Aspergillus glaucus*, found on cheese, &c. 3. *Botrytis*: the common form of mould on decaying vegetable substances. 4. Fungi caught over a sewer (*foul air*). 5. Fungi growing from a pumpkin. 6. Fungi caught in the air at the time of the cholera. (*Aerozoa*?)

Animals, birds, insects, and fishes, alike suffer from the ravages of fungi. One of the most prevalent of these observed among our domestic pets is the fungi growing over the upper surface of the gold-fish; death is almost certain when this white fungoid disease once commences its ravages. Great devastation is at times committed amongst silkworms by the *Botrytis*, causing a disease called *Muscardine*, just as they are about to enter the chrysalis state.

We must range by the side of these the fungi known as mushrooms, toadstools, puff-balls; and also a large number of microscopic plants forming those appearances which are referred to generally under the terms of mouldiness, mildew, blight, smut, dry-rot, &c. It is well known that fruit-preserves are very liable to be attacked by the common *bead-mould* (No. 3, fig. 189); which no care employed in completely closing the mouths of the jars can prevent. We may remark, however, that they are much less liable to suffer in this way,

if not left open for a night before they are tied down : it is therefore probable that the germs of the mould sow themselves before the jar is covered. Some particular kinds of cheese derive their flavour from the quantity of a fungous growth which spreads through the mass whilst it is yet soft.

The power of reproduction of the vegetable *mould-plant*, or *mucor*, is so great, that extensive tracts of snow are *suddenly* reddened by the *Gory-dew*, *Protococcus nivalis* (red-snow) of the northern regions. That the Red-snow plant consists of a cellular or filamentous tissue, may be easily ascertained by means of a microscope of even moderate powers ; and one of a higher power demonstrates that the filaments are nothing more than *cells drawn out*. Sometimes, as in the genus *Uredo*, the cells are spheroidal, having little connection with each other ; each cell containing propagating matter, and all separating from each other in the form of a fine powder when ripe. In plants of a more advanced organisation, as the genus *Monilia*, the constituent cells are connected in series which preserve their spherical, and also contain their own re-

productive matter ; while in such plants as *Aspergillus* (No. 2), the cells partly combine into threads forming a stem, and partly preserve their spheroidal form for fructification. It is probable, however, that in all fungi, and certain that in most of them, the first development of the plant consists in what we here call a filamentous matter, which radiates from the centre formed by the space or seeds ; and that all the cellular spheroidal appearances are subsequently developed, more especially with a view to the dispersion of the species.



fig. 190.

Sillier-cups (*Nidularia campanulata*).

That very curious fungus, known in Scotland as Sillier-cups (*Nidularia campanulata*), fig. 190, consists

of a curious leathery cup, in which are a number of small thecæ, which contain the sporules ; and each plant looks like a bird's nest with several eggs in it. It generally grows on a twig, or a bit of rotten wood, and one has been found growing on a wooden tally, fixed in a pot containing a green-house plant. Several kinds of *Agaricus* have

blue stems, others orange, yellow, and green, with caps of various colours, some of which are scarlet or crimson, and others have beautiful shades of purple or violet.

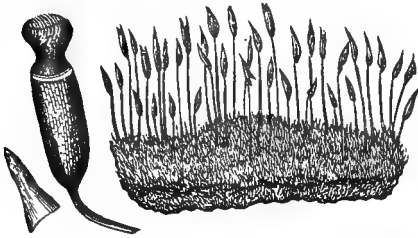

fig. 191. *Screw Moss.*



fig. 192. *Scale Moss.*

The mosses are another low form of vegetable life ; and Linnaeus called them *servi*,—servants, or workmen,—as they seem to labour to produce vegetation in newly-formed countries, where soil is not yet formed. They also fill and consolidate bogs, and form rich mould for the growth of larger plants, which they protect from the winter's cold. The common or Wall Screw-moss, fig. 191, which grows almost every where on old walls and other brick-work, if examined closely, will be found to have springing from its base numerous very slender stems, each of which terminates in a dark brown case, which is, in fact, its fruit. As the fruit ripens, a little cap, which covers it like an extinguisher, rises gradually, and is at last thrown off ; and when the lid of the fruit, which is also conical, falls off, a curious tuft of twisted hairs appears, forming a kind of fringe ; and it is from these twisted hairs that the plant takes its popular name of Screw-moss. If a patch of the moss is gathered when in this state, and the green part at the base is put into water, the threads of the fringe will uncoil and disentangle themselves in a most curious and beautiful manner, and thus afford an opening to the seeds, which are exceedingly small, and are contained within a thin bag, attached to the central column of the case. It may here be mentioned, that all mosses and lichens are more easily detached from the rocks and walls on which they grow in frosty weather than at any other season, and consequently they are best studied in winter. One of the commonest, Scale-moss, fig. 192 (*Jungermannia bidentata*), grows in patches, in moist, shady situations, near the roots of trees, upon commons, and on hedge-banks. The seed-vessels are little oval bodies, which, if gathered when unexpanded, and brought into a warm room, burst under the eye with violence the moment a drop of water is applied to them, the valves of the vessel taking

the shape of a cross, and the seeds distending in a cloud of brown dust. If this dust be examined by the microscope, a number of curious little chains, looking something like the spring of a watch, will be found among it, their use being to scatter the seeds; and if the seed-vessel be examined while in the act of bursting, these little springs will be found twisting and writhing about like a nest of serpents. The undulated Hair-moss (*Polytrichum undulatum*), fig. 194, is found on moist shady banks, and in woods and thickets. The seed-vessel has a curious shaggy cap; but in its construction it is very similar to that of the Screw-moss, except that the fringe round its opening is not twisted. The *Funaria hygrometrica* is a remarkable moss, differing widely in its powers of adaptation, and, consequently, in its greater geographical range, from most of its congeners. The *Funaria* is found in fruit, not only in London, but in every brick-field around it. The peristome of this moss is one of our most beautiful microscopic objects.

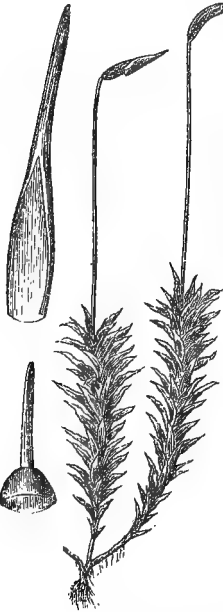

fig. 193.
Undulated Hair Moss.

CONFERVOIDÆ. ALGÆ.

The jointed confervæ and some algæ are met with in the smallest accumulations of fresh water standing for any length of time in the open air. They present the appearance of thread-like tubes, having joints differing in length, and the manner in which their contents are arranged. They multiply by means of little granules contained in their tubes, which are enclosed in tube after tube gradually added to the end of the previous one. Among these confervæ, the most remarkable are the *Zognema* and *Oscillatoria*, both of which evince certain degrees of approach to the animal kingdom. The species of the latter genus form dark green and purple slimy patches in damp places, or in water, and are exceedingly remarkable for the power they possess of moving spontaneously. When in an active state, their tubes are seen to unite and twist about, just as if they were vegetable worms; but they grow like plants, and their manner of increase is also vegetable. Disjointed algæ are extremely curious; they are characterised by their original or final spontaneous separa-

tion into distinct fragments, which have a common origin, but an individual life. They multiply by spontaneous division, as represented in fig. 194, Nos. 6 and 7; and are generally found attached to the stems of other plants immersed in water, or floating in pools or ditches.

In the algæ, the seeds are imbedded either in the frond itself or

in some especial receptacle; the fronds develop cellules, in which the reproductive nucleolus is enclosed; and acquiring a deeper colour with age, becomes finally a separate plant. The higher kinds of algæ inhabit sea-water only; they then assume the forms of more perfect plants, forming vast submarine forests of the most luxuriant vegetation. A few species are represented in our frontispiece. Many kinds furnish to man a wholesome and palatable food: the Laver of our seashores, the Carrageen, or Irish Moss, with others, belonging to this group; and from them are formed the edible birds'-nests, which are considered so great a delicacy by the Chinese. That valuable medicinal substance, Iodine, is also procured from certain algæ.*

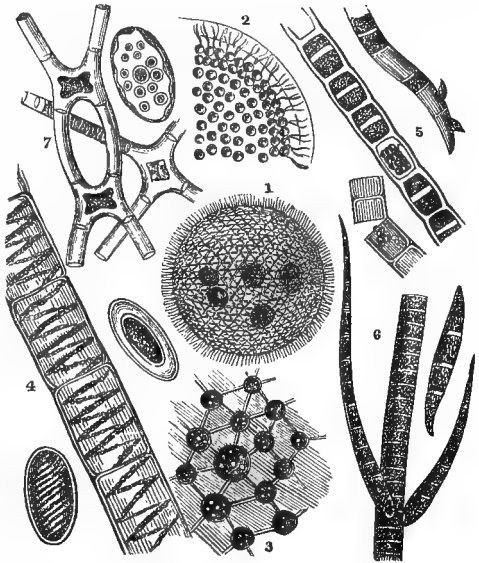

fig. 194.

1. *Volvox globator*. 2. A section of volvox, showing the ciliated margin of the cell. 3. A portion more highly magnified, to show the young *Volvicinæ*, with their nuclei and filamentary attachments. 4, 5, 6, and 7. *Confervoideæ*, showing their modes of growth.

We now arrive at a more complex form of cell, one that has attracted the attention of all microscopists from its earliest discovery to the present day. It was for a very long time classed with the lower forms of animal life; and there it remained, for the micro-chemical investigators of the present time to settle the perplexing question, and by truly assigning to it a place amongst vegetables. The cell referred to is recognised as the *Volvox globator*, or revolving-cell, represented

* For further information see Dr. Hassall on the *Fresh-Water Algæ*.

in fig. 194, Nos. 1, 2, and 3. These revolving globular bodies are found of various sizes, some large enough to be discernable by the naked eye.

Leeuwenhoek first perceived the motion of what he termed *globes*, "not more than the 30th of an inch in diameter, through water; and judged them to be animated." These *globes* are studded with innumerable minute green spots at their surface, each of which is a cell about the 3500th part of an inch in size, with a vivid nucleus having many ever-active cilia, that bristle over their spherical home and are bound to each other by bands forming a beautiful network. Within this globe, busy active nature is at work carefully providing a continuance of the species; and from six to twenty little bright-green spheres have been found enclosed in the larger transparent case. As one of these arrives at maturity, the parent cell enlarges; then bursts asunder to launch forth its offspring into a watery world. Both the older and younger spheres possess openings through which the water freely flows, affording food and air to the little organised beings.

Dr. Carpenter says, "The *Volvocinæ*, whose vegetable nature has been made known to us by observation of certain stages in the history of their lives, are but the *motile forms* (*Zoospores*) of some other plants, whose relation to them is at present unknown."

Professor Williamson, having carefully examined the *Volvox globator*, has shown that the increase of internal cells is carried on in a manner precisely analogous to that of the algæ; that between the outer integument and the primordial cell-wall of each cell a hyaline membrane is secreted, causing the outer integument to expand; and as the primordial cell-wall is attached to it at various points, it causes the internal colouring-matter, or endochrome, to assume a stellate form (see fig. 194, No. 3), the points of one cell being in contact with those of the neighbouring cell, these points forming at a subsequent period the lines of communication between the green spots generally seen within the full-grown *Volvox*. Cilia can be distinctly seen on the outer edge of the adult *Volvox*; by compressing and rupturing one, they may even be counted. Mr. Busk has been able to satisfy himself, by the addition of the chemical test *iodine*, of the presence of a very minute quantity of starch in the interior of the *Volvox*, which he considers as conclusive of their vegetable character. A singular provision is made in the structure of the gemmules, consisting of a slender elastic filament, by which it is attached to the parent cell-wall: at times it appears to thrust itself out, as if in search of food; it is then seen quickly to recover its former nestling-place by contracting the tether.

“Wonderful as it may appear, we have here an example of all the functions of vegetable life—namely, absorption, assimilation, exhalation, secretion, reproduction, &c.—effected by a single cell. This is ever continued in the highest and most complicated orders of vegetable life, in which there is a variety of organs adapted for the performance of different offices, the functions of which are effected by the agency of cells, obtaining materials of formation and support from the ordinary chemical agents around them. Thus the more man gains a knowledge of the wonders displayed in these minute objects of creation, the more is the mind humbled and inspired with reverence for the First Great Cause.”*

DESMIDACEÆ.

The disputed question of the animal or vegetable nature of these cells has received much valuable elucidation from Mr. Ralfs, who has given to the world the results of his laborious researches in his excellent work on *The British Desmidiæ*, published in 1848; and the conclusions of this painstaking author have been generally accepted by men of science. The interest which has so long attached to this topic will warrant us in devoting some space to its consideration; and we avail ourselves for that purpose of Mr. Ralfs' labours, with a recommendation to those of our readers who would wish to familiarise themselves more completely with this peculiar species, to consult the pages of the book above referred to.

Desmidiaceæ are grass-green in colour, surrounded by a transparent structureless membrane, a few only having their integuments coloured; they are all inhabitants of fresh water. Their most obvious peculiarities are the beauty and variety of their forms and their external markings and appendages; but their most distinctive character is their evident division into two or more segments. Each cell or joint, in the *Desmidiaceæ* generally consists of two symmetrical valves or segments; and the suture or line of junction is in general well marked. The multiplication of the cells by repeated transverse division is full of interest, both on account of the remarkable manner in which it takes place, and because it unfolds the nature of the process in other families, and furnishes a valuable addition to our knowledge of their structure and physiology.

The compressed and deeply-constricted cells of *Euastrum* offer most favourable opportunities for ascertaining the manner of their division; for although the frond is really a single cell, yet this cell in all its stages

* Dr. Mantell's *Wonders of Geology*.

appears like two, the segments being always distinct, even from the commencement. As the connecting portion is so small, and necessarily produces the new segments, which cannot arise from a broader base than its opening, these are at first very minute; though they rapidly increase in size. The segments are separated by the elongation of the connecting tube, which is converted into two roundish hyaline lobules. These lobules increase in size, acquire colour, and gradually put on the appearance of the old portions. Of course, as they increase, the original segments are pushed further asunder, and at length are disconnected, each taking with it a new segment to supply the place of that from which it has separated.

It is curious to trace the progressive development of the new portions. At first they are devoid of colour, and have much the appearance of condensed gelatine; but as they increase in size, the internal fluid acquires a green tint, which is at first very faint, but soon becomes darker; at length it assumes a granular state. At the same time the new segments increase in size, and obtain their normal figure; the covering in some species shows the presence of puncta or granules. And lastly, in *Xanthidium* and *Staurastrum* the spines and processes make their appearance, beginning as mere tubercles, and then lengthening until they attain their perfect form and size, and armed with setæ; but complete separation frequently occurs before the whole process is completed. This singular process is repeated again and again, so that the older segments are united successively, as it were, with many generations. When the cells approach maturity, molecular movements may be at times noticed in their contents, precisely similar to what has been described by Agardh and others as occurring in the *Confervæ*. This movement has been aptly termed a swarming. All the *Desmidiaceæ* are gelatinous. In some the mucus is condensed into a distinct and well-defined hyaline sheath or covering, as in *Didymoprium Grevillii* and *Staurastrum tumidum*; in others it is more attenuated, and the fact that it forms a covering is discerned only by its preventing the contact of the coloured cells. In general its quantity is merely sufficient to hold the fronds together in a kind of filmy cloud, which is dispersed by the slightest touch. When they are left exposed by the evaporation of the water, this mucus becomes denser, and is apparently secreted in larger quantities, to protect them from the effects of drought. Meyen states he has "distinctly seen that the large and small granules contain starch, and were sometimes even entirely composed of it;" and that "in the month of May he had observed many specimens of *Closterium* in which the whole interior sub-

stance was granulated, and all the grains gave with iodine a beautiful blue colour, as is the case with starch.*

Did we trust solely to the eye, we should indeed be very liable to pronounce these variable and beautiful forms to far more closely resemble animals than vegetables in their appearance. All favours this supposition. Their symmetrical division into parts; the exquisite disk-form, finely cut and toothed *Micrasterias*; the lobed *Euastrum*; the *Cosmarium*, glittering as it were with gems; the *Xanthidium*, armed with spines; the scimitar-shaped *Closterium*, embellished with striæ; the *Desmidium*, resembling a tape-worm; and the strangely insect-like *Staurostrum*, sometimes furnished with arms, as if for the purpose of seizing its prey;—all these characteristics appear to a superficial observer to belong rather to the lowest forms of animal, than vegetable life. Another indication may be adduced by rendering apparent their power of motion, as Dr. Bailey did: taking a portion of mud covered with *Closteria*, and placing it in water exposed to light; after a time, it will be seen that if the *Closteria* are buried in the mud, they will work their way to the surface, and cover it with a green stratum: this is no doubt owing to the stimulus of the light exerted upon all matter, although at first appearing very like a voluntary effort. Another is afforded by their retiring beneath the surface when the pools dry up. Mr. Ralfs states, that he has taken advantage of this circumstance to obtain specimens less mingled with foreign matter than they would otherwise have been.

During the summer of 1854, the Rev. S. G. Osborne drew our attention to the economy of an interesting specimen of this family, the *Closterium Lunula*. After many careful investigations, we have been enabled to satisfy ourselves that the membrane of the endochrome, both on its inner and outer surface, is ciliated.

In the *Closterium Lunula*, we have ascertained that the best view of its circulation, and the *cilia* which give to it its impulse, are obtained by the use of sunlight, transmitted through the combination of coloured glass proposed by Mr. Rainey, and adapted to a 1-4th achromatic condenser; with which must be used a 1-6th objective of Ross's.

* The test for starch can be easily applied, and so remove any doubt that may exist. It is only necessary to bear in mind that unless granular matter be seen in the interior of the cell, starch cannot be present. A small quantity of diluted tincture of iodine may be applied, removing the free iodine by the aid of heat, occasionally adding a little water to facilitate its removal. This also will assist in the removal of the *brownish stain* which at first obscures the characteristic *purple tint*; and then, by applying the highest power of the microscope, the peculiar colour of the purple iodide of starch can in general be easily perceived.

The Gillet's condenser, or parabolic reflector, will do equally well with a 1-8th objective. In diagram A, fig. 195, is given a sketch of a specimen of the *C. Lunula*; with the above arrangement of microscopic

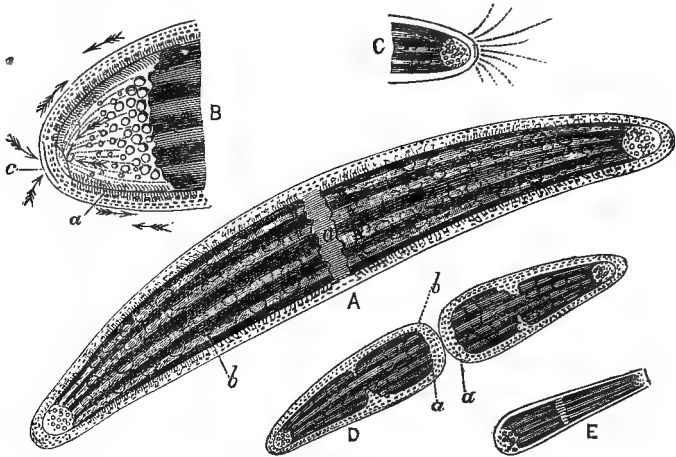

fig. 195.

power, and a deep eye-piece, the cilia will be seen in full action along the edge of the membrane which encloses the endochrome; and also, but not so distinctly, along the inside of the edges of the frond itself. Their action is precisely the same as that in the branchiæ of the mussel: there is the same wavy motion; and as the water dries up between the glasses in which the specimen is enclosed, the circulation becomes fainter, and the *cilia* are seen with more distinctness.

In diagram A, a line is drawn at *b* to a small oval mark; these exist at intervals, and more or less in number over the surface of the endochrome itself, beneath the membrane which invests it. These seem to be attached by small pedicles, and are usually seen in motion on the spot to which they are thus fastened; from time to time they break away, and are carried by the circulation of the fluid, which works all over the endochrome, to the chambers at the extremities; there they join a crowd of similar bodies, each in action within those chambers when the specimen is a healthy one.

The circulation, when made out over the centre of the frond, for instance at *a*, is in appearance of a wholly different nature from that

seen at the edges. In the latter, the matter circulated is in globules, passing each other, in distinct lines, in opposite directions; in the circulation as seen at *a*, the streams are broad, tortuous, of far greater body, and passing with much less rapidity. To see the centre circulation, use a Gillet illuminator and the 1-8th power: work the fine adjustment so as to bring the centre of the frond into focus, then almost lose it by raising the objective; after this, with great care, work the milled head till the dark body of the endochrome is made out; a hair's-breadth more adjustment gives this circulation with the utmost distinctness, if it is a good specimen. It will be clearly seen, by the same means, at all the points where the spaces are put; and from them may be traced, with care, down to both extremities.

The endochrome itself is evidently so constructed as to admit of contraction and expansion in every direction. At times the edges are in semi-lunar curves, leaving uninterrupted clear spaces visible between the green matter and the investing membrane; at other times the endochrome is seen with a straight margin, but so contracted as to leave a well-defined transparent space along its whole edge, between itself and the exterior case. It is interesting to keep changing the focus, that at one moment we may see the globular circulation between the outer and inner case, and again the mere sluggish movement between the inner case and the endochrome.

At B is given an enlarged sketch of one extremity of a *C. Lunula*. The arrows within the chamber pointing to *b* denote the direction of a very strong current of fluid, which can be detected, and occasionally traced, most distinctly; it is acted upon by cilia at the edges of the chamber, but its chief force appears to come from some impulse given from the very centre of the endochrome. The fluid is here acting in positive jets, that is, with an almost arterial action; and according to the strength with which it is acting at the time, the loose floating bodies are propelled to a greater or less distance from the end of the endochrome; the fluid thus impelled from a centre, and kept in activity by the lateral *cilia*, causes strong *eddies*, which give a twisting motion to the free bodies. The line — *a*, in this diagram, denotes the outline of the membrane which encloses the endochrome; on both sides of this *cilia* may be detected. The circulation exterior to it passes and repasses it in opposite directions, in three or four distinct courses of globules; these, when they arrive at — *c*, seem to encounter the fluid *jettted* through an aperture at the apex of the chamber; which disperses them so much, that they appear to be driven, for the most part, back again on the precise course by which they had arrived. Some,

however, do enter the chamber ; occasionally, but very rarely, one of the loose bodies may be seen to escape from within, and get into the outer current, it is then carried about until it becomes adherent to the side of the frond.

With regard to the propagation of the *C. Lunula*, we have never seen any thing like *conjugation* ; but we have repeatedly seen what we shall now describe—*increase by self-division*.

Observe the diagram D ; but for the moment suppose the two halves of the frond, represented as separate, to just overlap each other. Having watched for some time, the one half may be seen to remain passive ; the other has a motion from side to side, as if moving on an axis at the point of juncture : the separation then becomes more and more evident, the motion more active, until at last with a jerk one segment leaves the other, and they are seen as drawn. It will be observed, that in each segment the endochrome has already a *waist* ; but there is only one chamber, which is the one belonging to the one extremity of the original entire frond. The globular circulation, for some hours previous to subdivision, and for some *few* hours afterwards, runs quite round the obtuse end of the endochrome — *a*, by almost imperceptible degrees ; from the end of the endochrome symptoms of an elongation of the membranous sac appear, giving a semi-lunar sort of chamber ; this, as the endochrome elongates, becomes more defined, until it has the form and outline of the chamber at the perfect extremity. The obtuse end — *b* of the frond is at the same time elongating and contracting : these processes go on ; in about five hours from the division of the one segment from the other, the appearance of each half is that of a nearly perfect specimen, the chamber at the new end is complete, *the globular circulation exterior to it becomes affected by the circulation from within the said chamber* ; and, in a few hours more, some of the free bodies descend, become exposed to, and tossed about in the eddies of the chamber, and the frond, under a 1-6th power, shows itself in all its full beautiful construction. E is a diagram of one end of a *C. didymotocum*, in which the same process was noticed.

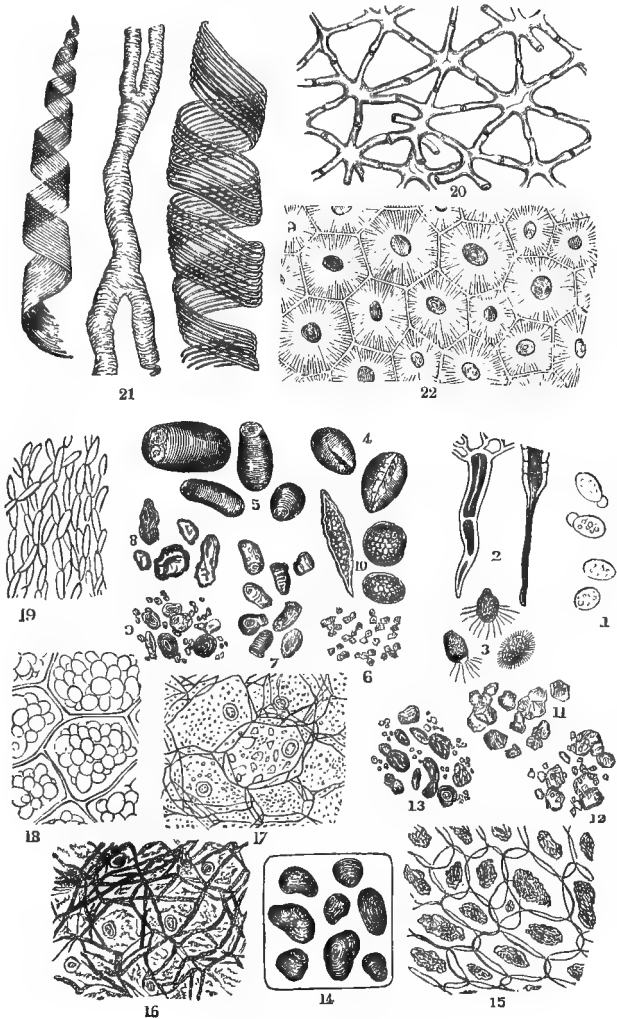

fig. 196.

The *Euastrum Didelta* is well worthy of attention, as well as many other species, the *Xanthidium Penium*, *Docidium*, &c. The *Arthrodesmus Incus* has a very beautiful hyaline membrane stretching from point to point, cut at the edges, something like the *Micrasteria*. This is imperfectly shown in fig. 196.

The Mode of Finding and Taking Desmidiaceæ.—As the difficulty of

PLATE XVI.



VEGETABLE STRUCTURES.

1. Cells of *Torula Cerevisia*, or Yeast Plant. 2. Hairs of *Urtica Dioica*, or Stinging-Nettle. 3. Ciliated spores of *Conferva*. 4. Starch-grains broken by applying heat. 5. Starch from *Tous-les-mois*. 6. Starch from Rice. 7. Starch from Sago. 8. Imitation-Sago Starch. 9. Wheat Starch. 10. Rhubarb Starch retained in their cells. 11. Maize Starch. 12. Oat Starch. 13. Barley Starch. 14. Potato Starch. 16. Section of Potato attacked by fungoid disease. 17. Section of Potato, showing total absence of Starch grains. 18. Section of Potato, cells filled with healthy Starch grains. 15. Section of a ripe Strawberry, cells ovoid, and containing a brown nucleus. 19. Mushroom Spawn, elongated cells. 20. Simple stellate tissue from the stem of a Rush. 21. Spiral vessels from the Leek and Rhubarb. 22. Radiating cells or pores from the outer shell of the Ivory-Nut.

obtaining specimens is very great, it will materially assist the efforts of the microscopist to learn the method adopted by Mr. Ralfs, Mr. Jenner, and Mr. Thwaites. "In the water the filamentous species resemble the Zygnemata; but their green colour is generally paler and more opaque. When they are much diffused in the water, take a piece of linen, about the size of a pocket handkerchief, lay it on the ground in the form of a bag, and then, by the aid of a tin box, scoop up the water and strain it through the bag, repeating the process as often as may be required. The larger species of *Euastrum*, *Micrasterias*, *Closterium*, &c., are generally situated at the bottom of the pool, either spread out as a thin gelatinous stratum, or collected into finger-like tufts. If the finger be gently passed beneath them, they will rise to the surface in little masses, and with care may be removed and strained through the linen as above described. At first nothing appears on the linen except a mere stain or a little dirt; but by repeated fillings-up and strainings a considerable quantity will be obtained. If not very gelatinous, the water passes freely through the linen, from which the specimen can be scraped with a knife, and transferred to a smaller piece; but in many species the fluid at length does not admit of being strained off without the employment of such force as would cause the fronds also to pass through, and in this case it should be poured into bottles until they are quite full. But many species of *Staurastrum*, *Pediastrum*, &c., usually form a greenish or dirty cloud upon the stems and leaves of the filiform aquatic plants; and to collect them requires more care than is necessary in the former instances. In this state the slightest touch will break up the whole mass, and disperse it through the water. I would recommend the following method as the best adapted for securing them:—Let the hand be passed very gently into the water and beneath the cloud, the palm upwards and the fingers apart, so that the leaves or stem of the inverted plant may lie between them, and as near the palm as possible; then close the fingers, and keeping the hand in the same position, but concave, draw it cautiously towards the surface; when, if the plant has been allowed to slip easily and equably through the fingers, the Desmidaceæ, in this way brushed off, will be found lying in the palm. The greatest difficulty is in withdrawing the hand from the surface of the water, and probably but little will be retained at first; practice, however, will soon render the operation easy and successful. The contents of the hand should be at once transferred either to a bottle, or in case much water has been taken up, into the box, which must be close at hand; and when this is full, it can be emptied on the linen as before.

But in this case the linen should be pressed gently, and a portion only of the water expelled, the remainder being poured into the bottle, and the process repeated as often as necessary.

Sporangia are collected more frequently by the last than the preceding methods. When carried home, the bottles will apparently contain only foul water ; but if it remain undisturbed for a few hours, the Desmidaceæ will sink to the bottom, and most of the water may then be poured off. If a little filtered rain-water be added occasionally, to replace what has been drawn off, and the bottle be exposed to the light of the sun, the Desmidaceæ will remain unaltered for a long time."

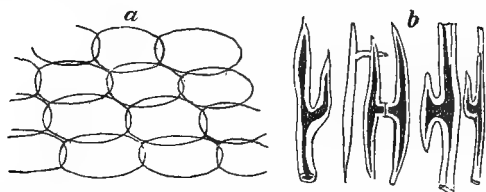

fig. 197. *a*, elementary cells. *b*, branched cellular tissue.

The Desmidaceæ prefer an open country. They abound on moors and in exposed places, but are rarely found in shady woods or in deep ditches. To search for them in turbid waters is useless ; such situations are the haunts of animals, not the habitats of the Desmidaceæ ; and the waters in which the latter are present are always clear to the very bottom.

To proceed in our inquiry : we now find the cell converted into other forms, and the transparent membranous cell-wall becoming thickened ; spontaneous fissure then takes place ; and thus is formed a series of connected cells variously modified and arranged, according to the conditions under which they are developed and the functions which they are destined to exercise. The typical form, as we have before observed, of the vegetable cell is spheroidal ; but when developed under pressure within walls, or denser tissues, they take other shapes, as the *oblong*, *lobed*, *square*, *prismatical*, *cylindrical*, *fusiform*, *muriform*, *stellate*, *filamentous*, &c. : it is then termed *Parenchym* ; and the cells woven together are called cellular tissue. In pulpy fruits the cells may be easily separated one from the other : a thin transverse section of a strawberry is represented at No. 15, Plate XVI. : within the cells are smaller cells, commonly known as pulp. Fig. 197, *a*, is the elementary form of oval cells or vesicles, passing on to form branched cellular tissue, *b*. Remarkable specimens of the

filamentous tissue may be seen in No. 19, Plate XVI., the fungiform elongated cells from the *Mushroom*; only another and more closely

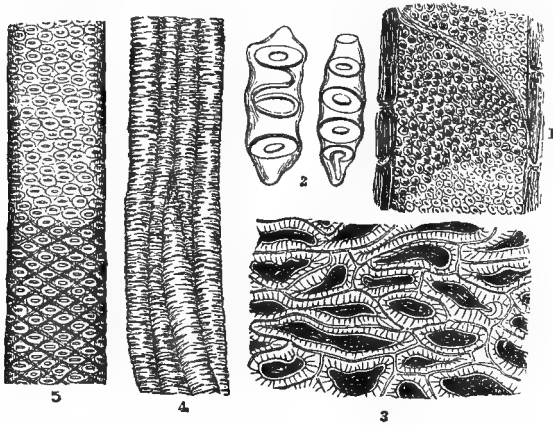

fig. 198.

1. Vertical section of root of Alder, with outer wall. 2. Spiral vessels from the *Opuntia vulgaris*. 3. Section of a Nut, showing cells with small radiating pores.
4. Interior cast of the siliceous portion of spiral tubes of the *Opuntia*. 5. Vertical section of Elm; in the lower portion small spiral fibres are seen between the pores.

connected growth of the mucedinous fungi, or, as it is commonly called, the spawn of the mushroom.

No. 20, Plate XVI., is stellate tissue cut from the stem of a *rush*; here we have the formative network dividing into ducts for the purpose of conveying the juices to the leaves of the plant. These ducts undergo other transformations; and the cell itself may become gradually changed into a spiral continuous tube or duct, as seen in No. 21, Plate XVI.; these are sometimes formed by the breaking down of the partitions, as shown in the previous figure—in the centre we have a compound spiral duct, much resembling a portion of tracheæ from the silkworm. Another important change occurring in the original cell is that of its conversion into *woody fibre*, so largely entering into the texture of *vegetables*. These fibres are elongated cells of a spindle shape, or tubes drawn out to a point at each end, whose internal cavities become gradually filled up, as represented occurring at *b*, fig. 197. The spiral thread may be either free, or adhering to the side of the tube. In the first case it forms the so-called *sperm animalcules* of the antheridæ of mosses; its elastic and hygrometric properties giving some resemblance to motion, fig. 198, No. 2. Nägeli believes this to

arise from the terminal enlargement of each fibre being its free nucleolus; and he also assumed that the motile threads, or vibratory cilia, found

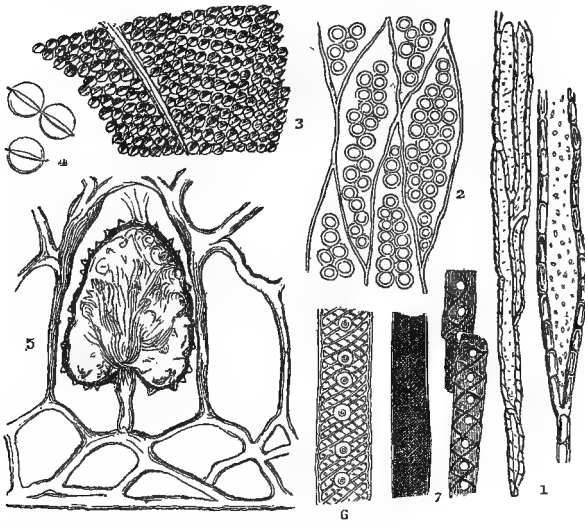

fig. 199.

1. Woody fibre from the root of the Elder, exhibiting small pores.
2. Woody fibre of fossil wood, showing large pores.
3. A section of stem of Clematis, with pores. At 4 the pores are highly magnified, to show the line which passes round them.
5. A vertical section of a leaf of the India-rubber tree, exhibiting a central gland.
6. Woody fibre, bordered with pores and spiral fibres.
7. Portions of fossil wood taken from coal.

on the spores of some algæ, &c., are of an analogous nature, each spore being a nucleolus.

In fig. 199, No. 1, we have a modification of the cellular tissue, with its sides marked by *pits* or *dots*, produced in consequence of the cell contents being unequally deposited over the inside of the cell-wall or membrane. The office of this peculiar tissue is said to be for the purpose of conveying fluids with rapidity in the direction of the woody tissues that surround it, or from the lower to the upper limbs: it is commonly recognised as the porosity of wood. Common woody fibre (*Pluerenchyma*) has its sides free from definite markings. In the *coniferous* plants, the tubes are furnished with circular disks, shown at No. 6, fig. 199. These disks are thought to be contrivances to enable the tubules of the woody tissue to discharge their contents from one to the other, or into the cellular spaces. Such as have aromatic

secretions are furnished with glands, a circumstance which has led to the division of woody tissue into simple and glandular. A large central gland is seen in a section of a leaf from the *Ficus elastica*, India-rubber-tree, No. 5, fig. 199. Professor Quekett says, "The nature of the pores, or disks, in *conifers*, has long been a subject for controversy; it is now certain that the bordered pores are not peculiar to one fibre, but are formed between two contiguous to each other, and always exist in greatest numbers on those sides of the woody fibres parallel to the medullary rays. They are hollow; their shape biconvex, Nos. 3, 4; and in their centre is a small circular or oval spot, No. 6, fig. 199, and Nos. 1 and 5, fig. 198: the latter may occur singly, or be crossed by another at right angles, which gives the appearance of a cross. No. 2, fig. 199, is a vertical section of fossil wood, remarkable for having three or four rows of woody tissue occupied by large pores without central markings."

At No. 7, fig. 199, we have represented fragments of Durham coal, composed almost entirely of woody cells, in which are two flattened spiral bands interlacing each other at regular distances, and having small central spaces between them.*

Plants are likewise furnished with *lactiferous* ducts or tissue, the *proper vessels* of the old writers. These ducts convey a peculiar fluid,

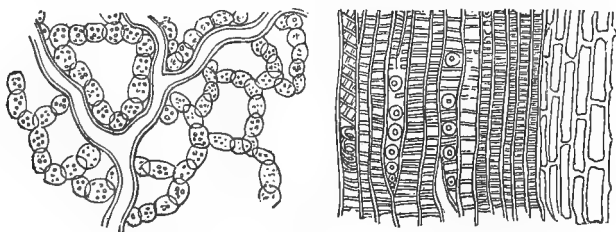

Lactiferous tissue.

fig. 200.

Reticulated ducts.

called *latex*, usually turbid, and coloured red, white, or yellow; often, however, colourless. It is supposed they carry latex to all the newly-formed organs, which are nourished by it. The fluid becomes darker after being mounted for specimens to be viewed under the microscope. This tissue is remarkable from its resemblance to the earliest aggregation of cells, the *yeast-plant*, and therefore has some claim to being considered the stage of development preceding that of the reticulated

* In the January number, 1854, of the *Microscopical Journal* will be found a most interesting account of the microscopical characters of coal, by Professor Quekett.

ducts seen near it in fig. 200. In the section from the India-rubber tree, fig. 199, a network of these lactiferous tubes may be found filled with a brownish or granular matter; that in fig. 200 is an enlarged view of this tissue from the liber of an exogen, taken near the root.

Among the cell-contents of some plants we have beautiful crystals known as *Raphides*: the term is derived from $\rho\alpha\phi\iota\varsigma$, a *needle*; the crystals, when first noticed, were of this shape. They are composed of the phosphate and oxalate of lime; their use in the economy of the plant is unknown. "Whether the result of chemical affinity, or of a vital process, cannot be decided; but it is certain that they can be produced artificially in the tissue of plants."

The French philosopher, Geoffrey St. Hilaire, has endeavoured to prove that crystals are the possible transition of the *inorganic* to *organic matter*. Crystals have naturally been supposed to conceal the first beginnings of the phase named *organic*, because in crystals we first meet with determinate *form* as a constituent element. The matter named *inorganic* has no determinate form; but a crystal is matter arranged in a particular and essential form. The differences, however, between the highest form of crystal and the lowest form of organic life known—a simple reproductive cell—are so manifold and striking, that the attempt to make crystals the bridge over which inorganic matter passes into the organic is almost universally regarded as futile.

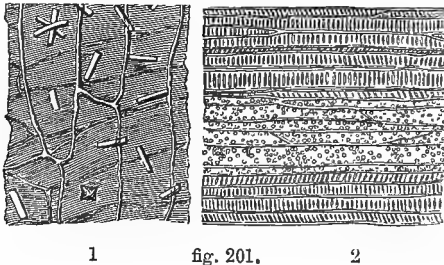

1. A Section from the outer layer of the bulb of an Onion, showing a crystal of oxalate of lime, with raphides. 2. A vertical section of root of a Fern.

If we examine a portion of the layers of an onion, fig. 201, or take a thin section of the stem or root of the garden rhubarb, fig. 202, No. 4, we shall observe many cells in which either bundles of needle-shaped crystals or masses of a stellate form occur.

Raphides were first noticed by Malpighi in *Opuntia*, and were subsequently described by Jurine and Raspail. According to the

latter observer, the needle-shaped or acicular are composed of phosphate, and the stellate of oxalate of lime. There are others having lime as a basis, combined with tartaric, malic, or citric acid. These are easily destroyed by acetic acid ; they are also very soluble in many of the fluids employed in the conservation of objects ; some of them are as large as the 1-40th of an inch, others are as small as the 1-1000th. They occur in all parts of the plant ; in the stem, bark, leaves, stipules, sepals, petals, fruit, root, and even in the pollen, with few exceptions. They are always situated in the interior of cells, and not, as has been stated by Raspail and others, in the intercellular passages.* Some of the containing cells become much elongated ; but still the cell-wall can be readily traced. In some species of Aloe, as, for instance, *Aloe verrucosa*, with the naked eye you will be able to discern small silky filaments. When these are magnified, they are found to be bundles of the acicular form of raphides.

In portions of the cuticle of the medicinal squill—*Scilla maritima*—several large cells may be observed, full of bundles of needle-shaped crystal. These cells, however, do not lie in the same plane as the smaller ones belonging to the cuticle. In the cuticle of an *onion* every

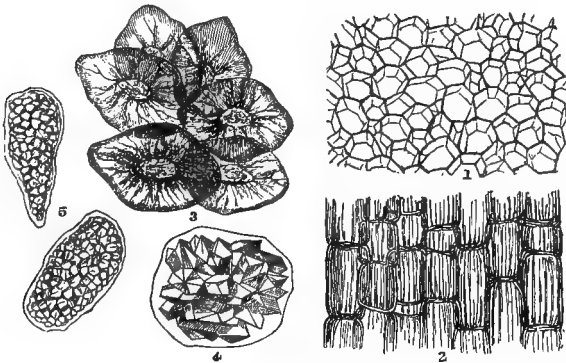

fig. 202.

1. A Transverse section of stem of *Equisetum*, showing the hexagonal shape of cells.
2. A vertical section, showing the elongated cell.
3. Cells of the Pear, showing *Sclerogen*, or gritty tissue.
4. Cells of garden Rhubarb, filled with raphides.
5. Cells from same, filled with starch-grains.

cell is occupied either by an octahedral or a prismatic crystal of oxalate of lime : in some specimens the octahedral form predominates ; but in

* As an exception, many years ago they were discovered in the interior of the spiral vessels in the stem of the grape-vine ; but with some botanists this would not be considered as an exceptional case, the vessels being regarded as elongated cells.

others from the same plant the crystals may be principally prismatic, and are arranged as if they were beginning to assume a stellate form. Some plants, as many of the *cactus* tribe, are made up almost entirely of raphides. In some instances every cell of the cuticle contains a stellate mass of crystals; in others the whole interior is full of them, rendering the plant so exceedingly brittle, that the least touch will occasion a fracture; so much so, that some specimens of *Cactus senilis*, said to be one thousand years old, which were sent a few years since to Kew from South America, were obliged to be packed in cotton, with all the care of the most delicate jewellery, to preserve them during transport.

Raphides, of peculiar figure, are common in the bark of many trees. In the hiccory (*Carya alba*) may be observed masses of flattened prisms having both extremities pointed. In vertical sections of the stem of *Elæagnus angustifolia*, numerous raphides of large size may be seen in the pith. Raphides are also found in the bark of the apple-tree, and in the testa of the seeds of the elm; each cell contains two or more very minute crystals.

In fig. 203 we have other representations of the crystalline structure of plants, in sections taken from wheat, grass, and the leaf of *Deutzia scabia*. This insoluble material is called silica, and is abundantly distributed throughout certain orders of plants, forming a skeleton after the soft vegetable matters have been destroyed: masses of it, having the appearance of irregularly-formed blackened glass, may always be found after the burning of hay or straw; it is caused by the fusion of the silica contained in the cuticle combining with the potash in the vegetable tissue, thus forming a silicate of potash (glass). To display this siliceous structure, it is necessary to dissolve the tissue by boiling it in nitric acid for several hours; the organic portion is thus destroyed, and the siliceous matter remains a perfect cast of the original structure.

In the *Graminaceæ*, especially the canes; in the *Equisetum hyemale*, or Dutch rush; in the husk of the rice, wheat, and other grains,—silica is abundantly found. In the *Pharus cristatus*, an exotic grass, fig. 203, No. 2, we have beautifully-arranged masses of silica with raphides. The leaves of the *Deutzia*, No. 3, are remarkable for their stellate hairs, developed from the cuticle of both their upper and under surfaces; forming most interesting and attractive objects when examined under the microscope, either by polarised or condensed light.

The most generally-distributed and conspicuous of the cell-contents is *Starch*; at the same time it is one of great value and interest, per-

forming a similar office in the economy of plants as that of fat in animals. It occurs in all plants at some period of their existence, and is the chief and great mark of distinction between the vegetable and animal kingdoms. Its presence is detected by testing with a solution of

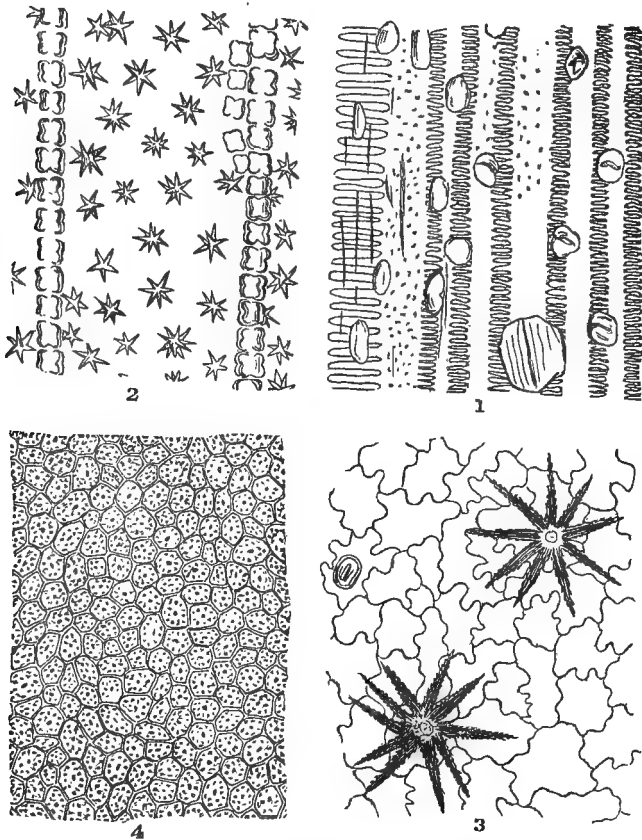

fig. 203.

1. Portion of the husk of Wheat, showing siliceous crystals. 2. Siliceous cuticle of blade of Grass (*Pharus cristatus*). 3. Siliceous cuticle from under surface of leaf of *Deutzia scabra*. 4. Section of a Cane; the cell-walls of silica, and internal pores filled with granular matter.

iodine, which changes it to a characteristic blue or violet colour. Being insoluble in cold water, it can be readily washed away and separated from other matters contained in the cellular parts of full-grown plants. It is often found in small granular masses in the interior of cells,

as shown in fig. 202, and Plate XVI. from the garden rhubarb. Starch-grains are variable in size : the *tous-les-mois*, No. 5, are very large ; in the *potato*, No. 14, they are smaller ; and in *rice*, No. 6, they are very small indeed. Nearly all present the appearance of concentric irregular circles ; and most of the granules have a circular spot termed the *hilum*, around which a large number of curved lines are arranged : seen best by polarised light.

Leeuwenhoek, to whom we are indebted for the earliest notice of starch-granules, enters with considerable minuteness into a description of those of several plants—such as wheat, barley, rye, oats, peas, beans, kidney-beans, buckwheat, maize, and rice ; and very distinctly describes experiments made by him in order to investigate *the structure of their starch-granules*. Dr. Reissek regards the granule as a perfect cell, from the phenomena presented during its decay or dissolution, when left for some time in water. Schleiden and others, after examining its expansion and alteration under the influence of heat and of sulphuric acid, considered it to be of a solid homogeneous structure.

Mr. Busk, after devoting considerable attention to the subject, agrees with M. Martin in believing the primary form of the starch-granule to be “a spherical or ovate vesicle, the appearance of which under the microscope, when submitted to the action of strong sulphuric acid, conveys the idea of an unfolding of plaits or rugæ, which have, as it were, been tucked in towards the centre of the starch-grain.”* The mode of applying the concentrated sulphuric acid is thus described by Mr. Busk :—“A small quantity of the starch to be examined is placed upon a slip of glass, and covered with five or six drops of water, in which it is well stirred about ; then with the point of a slender glass-rod the smallest possible quantity of solution of iodine is applied, which requires to be quickly and well mixed with the starch and water ; as much of the latter as will must be allowed to drain off, leaving the moistened starch behind, or a portion of it may be removed by an inclination of the glass, before it is covered with a piece of thin glass. The object must be placed on the field of the microscope, and the $\frac{1}{4}$ -inch object-glass brought to a focus close to the upper edge of the thin glass. With a slender glass-rod a small drop of *strong* sulphuric acid must be carefully placed immediately upon, or rather above the edge of the cover, great care being necessary to prevent its running over. The acid quickly insinuates itself between the glasses, and its course may be traced by the rapid change in the appearance of the starch-

* G. Busk, F.R.S., on the Structure of the Starch-granule ; *Quarterly Journal of Microscopical Science*, April 1853.

granules as it comes in contact with them. The course of the acid is to be followed by moving the object gently upwards ; and when, from its diffusion, the re-agent begins to act slowly, the peculiar changes in the starch-granules can be more readily witnessed. In pressing or moving the glasses, the starch disk becomes torn, and is then distinctly seen, especially in those coloured blue, to consist of two layers, an upper and a lower one ; and the collapsed vesicular bodies of an extremely fine but strong and elastic membrane." Mr. Busk believes the hilum to be the central opening into the interior of the ovate vesicle.

Nitric acid communicates to wheat-starch a fine orange-yellow colour ; and recently-prepared tincture of guaiacum gives a blue colour to the starch of good wheat-flour.

Pure wheat-flour is almost entirely dissolved in a strong solution of potash, containing twelve per cent of the alkali ; but mineral substances used for the purpose of adulteration remain undissolved.

Wheat-flour is frequently adulterated with various substances ; and in the detection of these adulterations, the microscope, together with a slight knowledge of the action of chemical re-agents, lends important

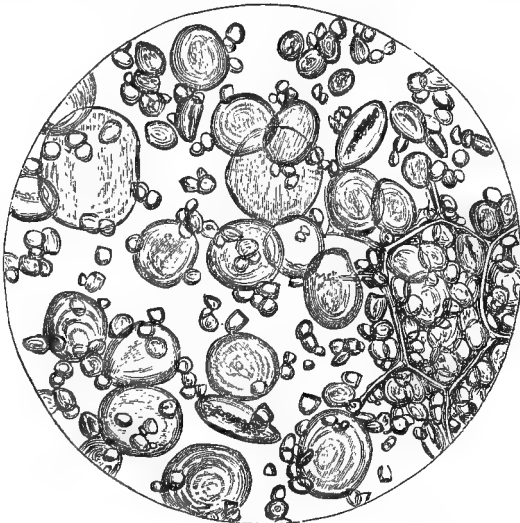

fig. 204.

Wheat-Flour Starch-granules, with a small portion of its cellulose. Magnified 420 diameters.

assistance. It enables us to judge of the size, shape, and markings on the starch-grains, and thereby to distinguish the granules of one meal

from that of another. In some cases the microscopic examination is aided by an application of the solution of potash. Thus we may readily detect the mixture of wheat-flour with either potato-starch, meal of the pea, and bean, by the addition of a little water to a small quantity of the flour; then, by adding a few drops of a solution of potash (made of the strength one part *liquid potash* to three parts of water), the granules of the potato-starch will immediately swell up, and acquire three or four times their natural size; while those of the wheat-starch are scarcely affected by it: if adulterated with pea or bean meal, the hexagonal tissue of the seed is at the same time rendered very obvious under the microscope. Polarised light may be used as an additional aid in this detection; wheat-starch presents a beautiful black cross proceeding from the central hilum, whereas the starch of the oat shows nothing of the kind.

The diseases of wheat and corn are most readily detected under the microscope; these will be seen to be produced by a parasitic fungus, as well as the animalcule represented in a previous chapter: all of which are more or less dangerous if used as articles of food when in this state.

Adulteration of bread with boiled and mashed potatoes, next to that by alum, is, perhaps, the one which is most commonly resorted to. The great objection to the use of potatoes in bread is, that they are made to take the place of an article very much more nutritious.

This adulteration may be readily detected by means of the microscope. The cells which contain the starch-corpuscles are in the potato very large, fig. 205; in the raw potato they are adherent to each other, and form a reticulated structure, in the meshes of which the well-defined starch-granules are clearly seen; in the boiled potato, however, the cells separate readily from each other, each forming a distinct article: the starch-corpuscles are much less distinct and much altered in their form.

Adulteration with alum and "stuff".—This adulteration is practised with a twofold object: first to render flour of a bad colour and inferior quality white and equal, in appearance only, to flour of superior quality; and secondly, to enable the flour to retain a larger proportion of water, by which the loaf is made to weigh heavier.

Before leaving the subject of starch, allusion may be made to the prevalent and destructive epidemic among potatoes, which is a disease of the tuber, not of the haulm or leaves.

“Examined in an early stage, such potatoes are found to be composed of cells of the usual size; but they contain little or no starch: this will be seen upon reference to Nos. 16 and 17, Plate XVI. Hence it may

be inferred, that the natural nutriment of the plant being deficient, the haulm dies, the cells of the tuber soon turn black and decompose, and fungi are developed as in most other decaying vegetable substances.

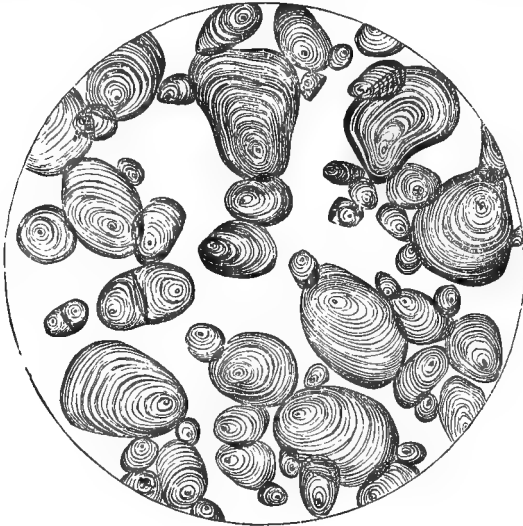

fig. 205.

Potato Starch-granules, sold under the name of British Arrow-root, and used to adulterate flour and bread. Magnified 240 diameters.

This will undoubtedly explain the most prominent symptom of the potato-disease, the tendency to decomposition ; and is a point in which the microscope confirms the result of chemical experiment : for it has been found that the diseased potatoes contain a larger proportion of water than those that are healthy. A want of organising power is evidently the cause of this deficiency of starch ; but we fear the microscope will never tell us in what the want of this organising force consists.*

The adulteration of articles of food and drink has long been a matter of uneasy interest, and of strong, though vague misgiving. Accum's *Death in the Pot*, between thirty and forty years ago, awoke attention to the subject ; which has since been more or less accurately explored by Mitchell, Normandy, Chevalier, Jules Garnier, and Harel ; and has now at length derived a singularly lucid exposition from the researches—so far as they have extended, and their extent has been

* Professor Quekett's *Histology of Vegetables*. We would also refer the reader to an admirable work on *Fungi*, by Arimini, an Italian botanist, 1759.

very large—of Dr. Hassall.* The report of these inquiries fills between 600 and 700 closely printed pages of a large octavo, replete with details of the fraudulent contaminations commonly practised by the people's purveyors, at the people's expense of health and pocket.

By the help of modern chemistry, a wonderfully small fractional part of many substances contained in, or mingled with some other substance, may be discovered. The grave gives up its secret to the chemist, who detects the minutest particle of arsenic in the body of the victim long murdered. But every body who is poisoned is not poisoned by an agent so responsive as arsenic to chemical tests. Most poisons of the vegetable class soon decompose, and cannot be recomposed or reproduced. If they contained permanent active principles, the quantity of these is commonly too small to admit of any demonstration which is practically trustworthy. Much of the vegetable rubbish with which articles of food are poisoned, in a comparatively mild degree, by adulteration, is undiscoverable by chemical science. Sloe-leaves among tea defy the examination of the detective chemist. He may demonstrate the tea not to contain as much of its active principle "thein," as it ought; he may prove that its quality is bad,—but he cannot show why, he cannot elicit from the fragments of the Chinese leaf the produce of the British blackthorn. But the problem that baffles chemistry, is solved by vegetable anatomy. The microscope supplies the shortcomings of the crucible and the test-tube. The root, leaf, stalk, bark, flower, fruit of each plant, herb, or tree, has its peculiar structure, discernible by microscopical examination in the minutest portion of each of those parts. The fragment of tea presents a different arrangement of cells, vessels, and other parts, from that exhibited by the piece of sloe-leaf; and the difference is distinguished with certainty by the aid of the microscope.

If gratitude is due to those who discover antidotes to disease, or invent appliances for relieving pain, the same obligation must undoubtedly be admitted to the man whose researches, by detecting the hidden seeds of sickness, must directly tend to prolong life and increase its comforts. The facts of the case, though already more or less known to the public, are really startling when presented in so large a mass and on such formal authority. "In *nearly all* articles," said Dr. Hassall, before a committee appointed by the House of Commons to inquire into these adulterations, "whether food, drink, or drugs, my opinion is

* *Food and its Adulterations*; comprising the Reports of the Analytical Sanitary Commission of the *Lancet*, for the years 1851 to 1854 inclusive. By Arthur Hill Hassall, M.D.

that adulteration prevails." And many of the substances, he added, employed in the adulterating process, were not only injurious to health, but even poisonous. The investigations were conducted in the most practical and business-like manner. Samples of the articles to be analysed were purchased to the number of twenty or forty specimens from different classes of traders; the powers of the microscope, as well as other tests, were then brought to bear upon them, and a report was drawn up embodying the general conclusions. The microscope seems to have been the more effective instrument in the work. Less than

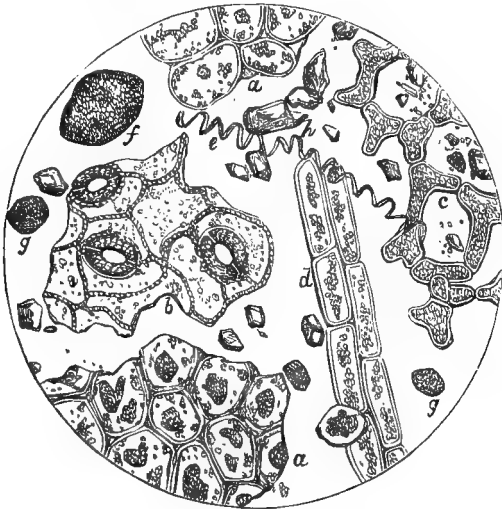

fig. 206.

Tea adulterated with foreign leaves.

a, upper surface of leaf; *b*, lower surface, showing cells; *c*, chlorophylle cells; *d*, elongated cells found on the upper surface of the leaf in the course of the veins; *e*, spiral vessel; *f*, cell of turmeric; *g*, fragment of Prussian blue; *h*, particles of white powder, probably China clay: after Hassall,

five years ago, for instance, it would, we are told, have been impossible to detect the presence of chicory in coffee: in fact, the opinion of three distinguished chemists was actually quoted in the House of Commons to that effect; whereas by the use of the microscope the differences of structure in these two substances, as in many other cases, can be promptly discerned. Out of thirty-four samples of coffee purchased at the outset of the investigation, chicory was discovered in thirty-one; chicory itself being also adulterated with all manner of compounds.

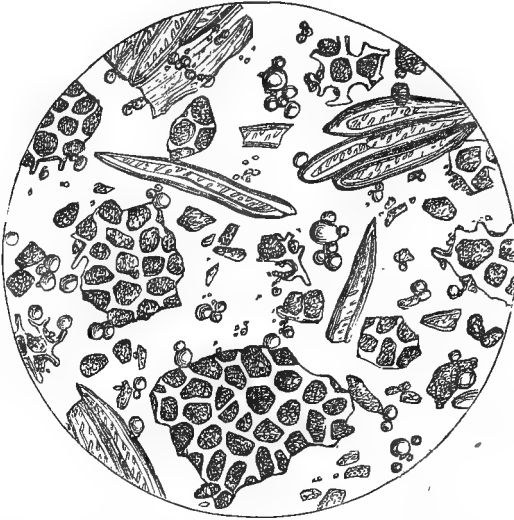

fig. 207.

Structure and character of genuine ground Coffee : after Hassall.

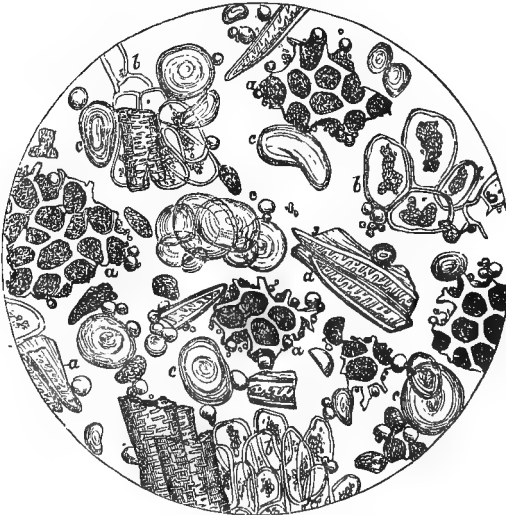

fig. 208.

Sample of Coffee adulterated with both Chicory and Roasted Wheat : after Hassall.
a a a, small fragments of coffee ; *b b b*, portions of chicory ; *c c c*, starch-granules of wheat.

There is no falling back either upon tea or chocolate; for these seem rather worse used than coffee. Tea is adulterated, not only here, but still more in China; while as to chocolate, the processes employed in corrupting the manufacture are described as "diabolical." "It is often mixed with brick-dust to the amount of ten per cent, ochre twelve per cent, and peroxide of iron twenty-two per cent, and animal fats of the worst description."

In this country cocoa is sold under the names of flake, rock, granulated, soluble, dietetic, homœopathic cocoa, &c., fig. 209. Now these names are merely employed to show that they are compounds of sugar, starch, and often other substances. Unfortunately, however, many of

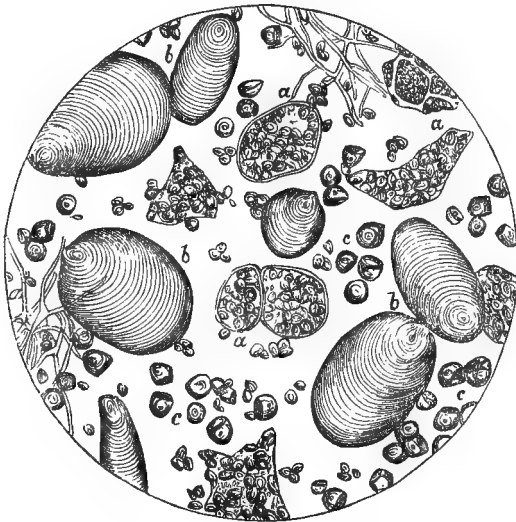

fig. 209.

Adulterated Cocoa, sold under the name of Homœopathic Cocoa. a a a, granules and cells of cocoa; b b b, granules of Canna-starch, or *Tous-les-mois*; c, granules of *tapioca starch*: after Hassall.

the preparations of the cocoa-nut sold under the names of chocolate and of cocoa-flakes, consist of a most disgusting mixture of bad or musty cocoa-nuts, with their shells, coarse sugar of the very lowest quality, ground with potato-starch, old sea-biscuits, coarse branny flour, animal fat (generally tallow, or even greaves), &c.

Were we to extend our inquiries to drugs and pharmaceutical preparations, the immense importance of the question would become still

more strikingly manifest. Nearly all the most useful and important articles of the *Materia Medica* are grossly and systematically adulterated, often to an enormous extent; so that it is impossible to estimate the strength of the different remedies administered, or the extent and character of the effects produced. The greatest confusion and uncertainty are thus introduced into the practice of medicine, and, no doubt, many valuable lives are annually sacrificed. For confirmation of this statement, see Reports of the Analytical Sanitary Commission, in the *Lancet*, 1853 and 1854, on the Adulteration of Jalap, Scammony, Opium, &c.

We nevertheless believe that the growing intelligence and inquiring spirit of the masses, with the greatly increased facilities of detection so ably pointed out by Dr. Hassall, and afforded by modern science, will tend not merely to check the evil for the time being, but ultimately suppress such dangerous practices. A remedy is in the hands of the people; let them only interest themselves in that which so nearly concerns their health—nay, lives. Every man should be able to ascertain the quality and general purity of the substances that form his daily food: this he may do by acquiring a knowledge of the microscope; and by taking such a book as Dr. Hassall's for his guide, he will soon learn *where to look for adulterations, what to look for, and how to find them out easily for himself.*

All plants are provided with hairs; and a few, like insects, with weapons of a defensive character. Those in the *Urtica dioica*, commonly called the *Stinging-nettle*, are elongated hairs, developed from the cuticle, usually of a conical figure, and containing an irritating fluid; in some of them a circulation is visible: when examined under the microscope, with a power of 100 diameters, they present the appearance seen at No. 2, Plate XVI. At No. 3, same plate, we have represented a few of the interesting ciliated spores from *Confervæ*.

The next of the cell-contents falling under our notice is that to which leaves owe their green colour, and is known as *Chlorophyl*. It is of a resinous nature, containing nitrogen formed under the action of light, and not otherwise. In the autumn its colour changes to red or yellow. It is soluble in spirits of wine or ether, but not in water; and is usually contained in cells lying below the surface. The astonishing circulation of the fluid-contents of vegetable cells may be examined at the same time as the Chlorophyl granules, by selecting for the purpose the transparent water-plants *Chara*, *Nitella*, *Anacharis*, and *Valisneria*, or the hairs of *Groundsel*, and *Tradescantia*. The circulation of the sap in plants growing in water is now termed by botanists *Cyclosis*,

It is necessary to take a thin section or strip from the flattened leaf of *Vallisneria*, which will exhibit a series of oblong cells, as seen in fig. 210, No. 4. Among the granules a few of a larger and more

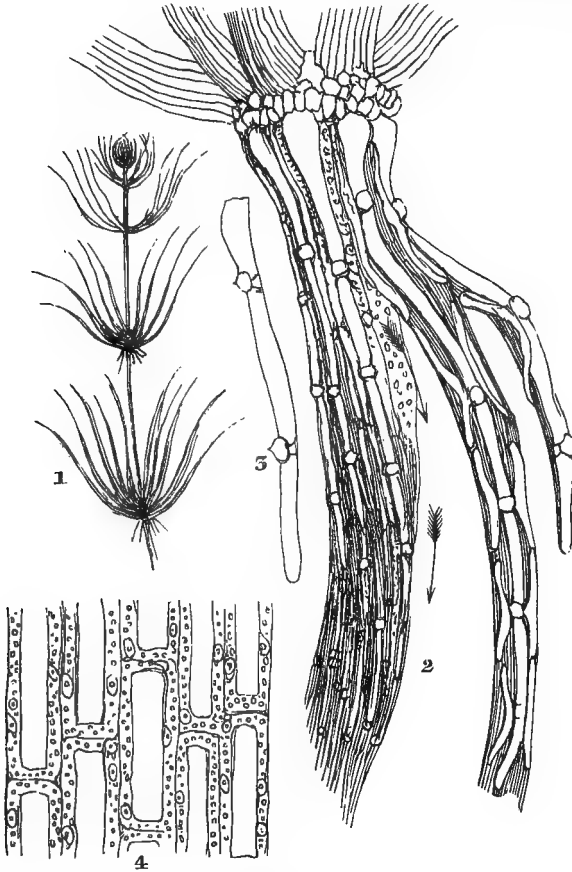

fig. 210.

1. Branch of *Chara vulgaris*. 2. Magnified view: the arrows indicate the course taken by the granules in the tubes. 3. A limb of ditto, showing the budding at joints. 4. Portion of a leaf of *Vallisneria spiralis*, with its cells and granules.

transparent character than the rest may be seen, having the nucleolus of the cell within them.

Chara vulgaris is the plant in which the important fact of vegetable circulation was discovered, and in which, from the extreme simplicity

of its structure, much more is possibly observable, and with lower magnifying powers than other plants require. Fig. 210, No. 1, is a portion of the plant of the natural size. Every knot may produce roots ; but it is remarkable, that they always proceed from the upper surface of the knot, and then turn downwards ; so that it is not peculiar that the first roots also should rise upwards with the plant, and come out of the seed-skin, and then turn downwards.

The stems and arms are tubular, and entirely covered with smaller tubes ; the circulation can mostly be observed in these : see No. 2. Any ordinary cutting to obtain sections would squeeze the tube flat, and spoil it and the lining ; it is therefore better to avoid this, by laying the Chara on smooth wood, just covered with water ; then, with a sharp knife, make suddenly a number of quick cuts across it, and so obtain the various sections required. Wet a slip of glass, and turn the wood over so as just to touch the water, and the sections will fall from the wood on to the glass, ready for the microscope.

Mr. Varley gives the following directions for cultivating these plants. He says :

“ The Chara tribe is most abundant in still waters or ponds that never become quite dry ; if found in running water, it is mostly met with out of the current, in holes or side bays, where the stream has little effect, and never on any prominence exposed to the current. If the Chara could bear a current, its fruit would mostly be carried on and be deposited in whorls ; but it sends out from its various joints very long roots into the water, and these would by agitation be destroyed, and then the plant decays ; for although it may grow long before roots are formed, yet when they are produced their destruction involves the death of the plant. In order, therefore, to preserve Chara, every care must be taken to imitate the stillness of the water by never shaking or suddenly turning the vessel. It is also important that the Chara should be disturbed as little as possible ; and if requisite, it must be done in the most gentle manner, as, for instance, in cutting off a specimen, or causing it to descend in order to keep the summit of the plant below the surface of the water.

Imitate the freshness of the water by having an extent of the surface, which it is requisite to skim frequently, or suffer to overflow by the addition of more water. These precautions being attended to, a clear bright surface is kept. It is also desirable to change a small portion of the water ; but this should be done without agitation. The best vessels for cultivating this plant are either wide pans holding three or four gallons, or glass jars a foot or more high ; into these the

Chara may be placed, either with clean water alone, or a little earth may be sprinkled over it, so as to keep it at the bottom ; or the bottom may be covered one inch with closely-pressed mould, in order that the water may be put in without disturbing it. On this lay the Chara, with a little earth over the lower ends to fix it. The vessels kept indoors have a film which is always forming on the water, and which requires to be frequently removed. By letting the water overflow the surface becomes skimmed, though dipping out gently will do ; but in all cases of pouring in water, hold something, such as a saucer or flat piece of wood, to receive the pouring, and make it spread, instead of allowing it to descend at once on the surface. Pans in the open air nearly full of water will be kept in order by the wind and rain ; only take care to supply the deficiency (the effect of evaporation), and to change some of the water if it is considered necessary.

Imitate the equal temperature of its native holes, by sinking the pan a short way in the earth ; but during frosty weather keep the pan within-doors, and at the lower part of the house, as this situation is generally the most uniform in its temperature.

The Chara will live in any temperature above freezing, and grows quicker as the warmth increases ; but above the earth, as outside of a first-floor window, it will not bear the daily difference between the mid-day sun and the cold of sun-rising. The glass jars I keep within the house as nearly uniform in warmth as convenient. Similar care is requisite for Vallisneria ; but the warmest and most equal temperature is better suited to this plant. It should be planted in the middle of the jar in about two inches deep of mould, which has been closely pressed ; over this place two or three handfuls of leaves, then gently fill the jar with water. When the water requires to be changed, a small portion is sufficient to change at a time. It appears to thrive in proportion to the frequency of the changing of the water, taking care that the water added rather increases the temperature than lowers it."

The natural habitat of the Frog-bit is on the surface of ponds and ditches ; in the autumn its seeds fall, and become buried in the mud at the bottom during the winter ; in the spring these plants rise to the surface, produce flowers, and grow to their full size during summer. Chara may be found in many places around London, the Isle of Dogs, and in ditches near the Thames bank.

The New Water-weed (Anacharis alsinastrum).—This remarkable plant has recently made its appearance in the rivers Ouse and Cam. It is so unlike any other water-plant, that it may be at once recognised

by its leaves growing *in threes* round a slender stringy stem. The watermen on the river have already named it "Water-thyme," from a faint general resemblance which it bears to that plant.

In 1851 the *Anacharis* was noticed by Mr. Marshall and others in the river at Ely, but not in great quantities. Next year it had increased so much, that the river might be said to be full of it.

The colour of the plant is deep green; the leaves are nearly half an inch long, by an eighth wide, egg-shaped at the point, and beset with minute teeth, which cause them to cling. The stems are very brittle, so that whenever the plant is disturbed fragments are broken off. Its powers of increase are prodigious, as every fragment is capable of becoming an independent plant, producing roots and stems, and extending itself indefinitely in every direction. Most of our water-plants require, in order to their increase, to be rooted in the bottom or sides of the river or drain in which they are found; but this is independent altogether of that condition, and actually grows as it travels slowly down the stream after being cut. The specific gravity of it is so nearly that of water, that it is more disposed to sink than float. A small branch of the plant is represented, with a Hydra attached to it, at page 196.

Mr. Lawson has pointed out the particular cells in which the current or circulation may most readily be seen—viz. the elongated cells around the margin of the leaf and those of the midrib. On examining the leaf with polarised light, these cells, and these alone, are found to contain a large proportion of silica, and present a very interesting appearance. A bright band of light encircles the leaf, and traverses its centre. In fact, the leaf is set, as it were, in a framework of silica. By boiling the leaf for a short time in equal parts of nitric acid and water, a portion of the vegetable tissue is destroyed, and the silica rendered more distinct, without changing the form of the leaf.

VASCULAR TISSUE.

This tissue in plants is somewhat analogous to the vascular system of animals; for this reason, and also for that of its tubular appearance, it was called by the older botanists *tracheæ*. It consists of rounded, square, columnar, and elongated tubes or cells, with membranous walls, having spiral fibre within. In some cases many fibres are seen running in the same direction, forming a band, when they are termed *compound-spiral*. Spiral fibres are represented in Plate XVI., No. 21. Under this head other membranous tubes are included, in which the

arrangement of the fibre has been considerably modified in its deposition. Elongated tubes or ducts, with porous walls, come under the head of vascular tissue ; they somewhat differ from the spiral varieties, inasmuch as they cannot be unrolled without breaking. It is a curious fact, that mostly the spiral coils from right to left ; and it has been suggested that the direction of the fibre may determine that in which the plant coils round an upright pole. The Hop has *left-handed spirals*, and is a left-handed climber, which would therefore appear to support this theory. The nature of the fibre, and the development of the tissue, have been frequently the subject of dispute between botanists. The late Mr. Edwin Quekett gave much attention to the subject ; and in an excellent paper published in the *Microscopical Society's Transactions*, 1840, gave the result of his observations.

In order to watch the development of the membranous tube of a vessel, no better example can be chosen than the young flower-stalk of the long-leek (*Allium porrum*), in the state in which this vegetable is usually sent to market ; it is then most frequently found to be about an inch or more in length, and from a quarter to half an inch in diameter. This organ occurs very low down amidst the sheathing bases of the leaves ; and from having to lengthen to two or three feet, and containing large vessels, forms a very fit subject for ascertaining the early appearances of the vascular tissue.

To examine the development of vessels, it is necessary to be very careful in making dissections of the recent part ; and it will be found useful to macerate the specimen for a time in boiling water, which will render the tissues more easily separable. When the examination is directed in search of the larger vessels, it will be found that at this early stage they present merely the form of very elongated cells, arranged in distinct lines ; amongst which some vessels, especially the annular, will be found matured, even before the cytoblasts have disappeared from the cells of the surrounding tissue.

As development proceeds, the vessels rapidly increase in length, till they arrive at perfection. No increase in diameter is perceptible after their first formation. At this period, in the living plant the young vessels appear full of fluid, which is apparently, as remarked by Schleiden, of a thick character, and which he has designated vegetable jelly ; by boiling which, or by the addition of alcohol, the contents, or at least the albuminous portion, become coagulated. From this circumstance, every cell appears to enclose another in a shrivelled condition ; this state is sometimes so far extended, that a thick granular cord is all that can be seen of the contents. When the granules have arranged

themselves throughout the entire length of the tube, those which were first deposited, and had then some slightly visible space between them, become reinforced by others, or nourished by the contents of the vessel ; so that space becomes obliterated, the fibre assuming a thread-like shape with defined borders, and sufficiently large to allow of the transmission of white light. When this action has progressed throughout the entire vessel, the transparency is restored, and the entire mass of granules disappears. The vessel having arrived at maturity, the liquid contents are absorbed, as happens in the cells of the pith ; the vessel is then empty. Probably its being seen in these different states, at one time

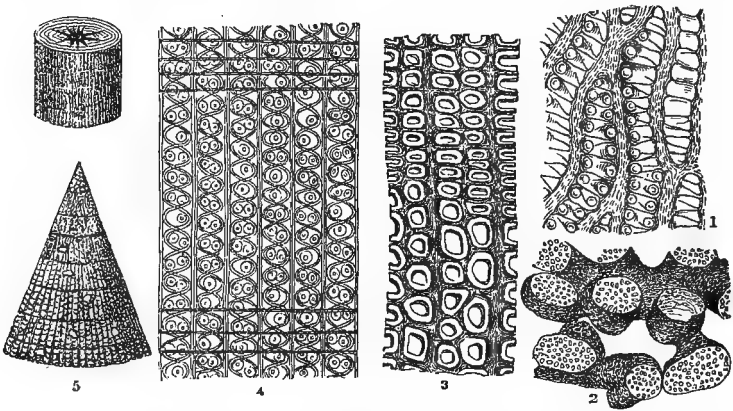

fig. 211.

- . A portion of the leaf of *Sphagnum*, showing ducts, vascular tissue, and spiral fibre, in the interior of its cells. 2. Porous cells obtained from the testa of Gourd-seed, communicating with each other, and resembling ducts. 3. A transverse section of *Taxus baccata* (Yew), showing the woody fibre. 4. Vertical section of the same, exhibiting pores and spiral fibres. 5. A section from the stem of a coniferous plant, with a transverse cutting magnified, and showing the zones of annual growth, or annual rings.

full and at others empty, may account for the discrepancies existing among botanists as to the functions these vessels perform. The period of growth at which the laying down of fibre commences, determines the distance between the several coils ; for instance, when it is first formed the coils are quite close, scarcely any perceptible trace of membrane existing between them. In the annular vessel, the development of the cell and the adherence of the granules to each other are conducted in the same manner ; the deposit showing a tendency towards the spiral direction, by the presence of a spire connecting two rings, or by a ring

being developed in the middle of a spiral fibre. The annular vessel is the first observed in the youngest parts of plants, and when found alone indicates a low degree of organisation ; as shown by its occurrence in *Sphagnum*, *Equisetum*, and *Lycopodium*, which plants, in the ascending scale of vegetation, are almost the first that possess vascular tissue.

It will be found that spiral fibre occurring with rings marks a higher step in the scale of organising power ; the true spiral more so ; and the reticulated and dotted mark the highest ; this being the order in which these several vessels are placed in herbaceous exogens proceeding from within outwards, the differences of structure of the several vessels being indices of the vital energy of the plant at the several periods of its development. In those vessels in which the annular or spiral character of the fibre is departed from, some curious modifications of the above process are to be observed, as in the reticulated vessels met with in the common balsam (*Balsamina hortensis*). The primary formation of fibre in these vessels is marked by the tendency of the granules to take a spiral course, when it happens that some one of the granules becomes enlarged by the deposition of new matter around it. This becomes a point originating another fibre or branch, which becomes developed by the successive attraction of granules into bead-like strings, taking a contrary direction to the original fibre, forming a cross-bar, or ramifying, thereby causing the appearance by which the vessel is recognised.

In the exogenic vessel, the development of fibre proceeds in the same manner as in the last example ; but the vessels will be seen to be dotted with a central mark, usually of a red colour, which, when viewed under high power, may be thought to resemble a minute garnet set in the centre of each dot. This red colour is owing to the dot being somewhat hollowed or cupped, and the centre only thin membrane. These vessels are best seen in the young shoots of the Willow. In the endo-

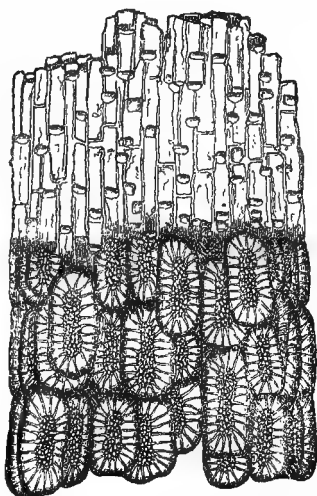

fig. 212.

A portion of the epidermis of the sugarcane, showing the two kinds of cells of which it is composed, magnified 200 diameters.

genic vessel the connecting branches are given off beneath each other, so that the dots, which are rounded, are arranged in longitudinal rows; but in the acrogenic, or scalariform, in which the vessels are generally angular, and present distinct facets, the branches come off in the same line, corresponding generally to the angles of the vessel; the spaces left between are linear instead of round.

Mr. E. Quekett affirms, in opposition to the views entertained by Mirbel, Richard, and Bischoff, "that the dots left in these several vessels are not holes, neither do they consist of broken-up fibre, but are the membranous tubes, unsupported by internal deposit; and on account of the extreme tenuity of the tissue, and the minute space between the fibres, the light in its transmission becomes decomposed, and appears of a greenish-red hue. The structure of the dot is best seen by examining the broken edge of any such vessels, when it will be found that the fracture has been caused by the vessel giving way from one dot to another, so that the torn edge of the membrane can be observed in each dot."

PREPARATION OF VEGETABLE TISSUES.

The proper mode of preparing and preserving vegetable tissues is a matter of some importance to the microscopist; we therefore propose to add a few general directions for the student's guidance.

Vegetable tissues are best prepared for the microscope by making thin sections, either by maceration, by tearing between the thumb and the blade of a knife, or by dissection.

The spiral and other vessels of plants require to be dissected out under a simple magnifying-glass. Take, for instance, a piece of asparagus, and separate with the needle-points the vessels, which require to be finished under a magnifying-glass, in a single drop of distilled water. When properly done, keep in spirits of wine and water until mounted.

Vascular tissue requires both maceration and dissection to its separation. The cuticle or external covering of plants assumes various attractive forms, best seen in the pelargonium, oleander, &c.; it may be mounted either dry, or in Canada balsam.

Cellular tissue is best seen in fine sections from the pith of elder, pulp of peach, pear, &c. The petals of flowers are mostly composed of cellular tissue, and their brilliant colours arise from the fluid contained within the cells. In the petal of the anagallis, or scarlet chickweed, the spiral vessels diverging from the base, and the singular cellules which fringe the edge, are very interesting. The petal of the geranium is one of the most beautiful objects for microscopic examination. The usual

way of preparing it is by immersing the leaf in sulphuric ether for a few seconds, allowing the fluid to evaporate, and then putting it up dry. Dr. Inman of Liverpool suggests the following method: first peel off the epidermis from the petal, which may be readily done by making an incision through it at the end of the leaf, and then tearing it forwards by the forceps. This is then arranged on a slip of glass, and allowed to dry; when dry, it adheres to the glass. Place on it a little Canada balsam diluted with turpentine, and boil it for an instant over the spirit-lamp; this blisters it, but does not remove the colour; then cover it with a thin slip of glass, to preserve it. Many cells will be found showing the mamilla very distinctly, and the hairs surrounding its base, each being slightly curved and pointed towards the apex of the mamilla. It is these hairs and the mamilla which give the velvety appearance to the petal.

Fibro-cellular tissue is found readily in *Sphagnum* or bog-moss, and in the elegant creeper *Cobæa scandens*. In some orchidaceous plants the leaves are almost entirely composed of it. A modification of this form of tissue is found in the testa of some seeds, as in those of *Salvia*, *Collomia grandiflora*, &c.

The curious and interesting sporules of ferns, when ripe, burst, and are dispersed to a distance; so that they should be gathered before they come to maturity, and mounted as opaque objects. The develop-



fig. 213. *Male Fern.*

ment of ferns may be observed by placing the seeds in moistened flannel, and keeping them at a warm temperature. At first a single cellule is produced, then a second; after this the first divides into two, and then others follow; by which a lateral increase takes place. It must be

observed, that ferns do not form buds like other plants ; but that their leaves, or fronds as they are properly called, when they first appear, are rolled up in a circular form, and gradually unfold, as in fig. 213. Ferns have no visible flowers ; and their seeds are produced in clusters, called *sori*, on the backs of the leaves. Each sorus contains numerous thecæ, and each theca encloses almost innumerable spores, and these again the seeds. There are numerous kinds of fern, all remarkable for some interesting peculiarity ; but which from want of space we cannot here enumerate.

The first account of the true mode of development of Ferns from their spores was published in 1844, by Nagéli, in a memoir entitled *Moving Spiral Filaments (spermatic filaments) in Ferns*, wherein he announced the existence of the bodies now called *antheridia* ; but, mistaking the *archegonia* for modified forms of the *antheridia*, he was led away from a minute investigation of them. If he had followed the development of the *prothallia* further, he would have detected the relations of the nascent embryo, which would probably have put him on the right track. As it was, the remarkable discovery of the moving spiral filaments occupied all his attention, and caused him to fall into an error in certain important respects ; for example, he has represented what is undoubtedly an *archegonium* filled with cellules, *sperm-cells*, which, he states, "emerged from it as from the *antheridia*." This is undoubtedly incorrect.

With regard to the *spermatozoids*, his description is imperfect, the only indication of the existence of cilia being a statement that he occasionally saw a long filiform appendage, like that represented by Meyen in the *spermatozoids* of *Chara*. On the other hand, the mathematical definition of the movements of the *spermatozoids* is surely misplaced, since nothing can be more arbitrary or irregular than their course.

These observations on the Ferns have acquired vastly-increased interest from the subsequent investigations of Hofmeister, Mettenius, and Suminski, on the allied Cryptogams, and above all, from Hofmeister's observations on the processes occurring in the impregnation of the Conifers. Not only have these investigations given us a satisfactory interpretation of the *archegonia* and *antheridia* of the Mosses and Liverworts, but they have made known and co-ordinated the existence of analogous phenomena in the Equisetaceæ, Lycopodiaceæ, and Rhizocarpeæ, and shown, moreover, that the bodies described by Mr. Brown in the Conifers, under the name of "corpuscles," are analogous to the *archegonia* of the Cryptogams ; so that a link is hereby formed between these groups and the higher flowering plants.

For a detailed examination of these very interesting discoveries, we must refer the reader to excellent papers, published by Mr. Henfrey, in the *Annals of Natural History*, and in the *Transactions of the Linnean Society of London*, vol. xxi., part 2, 1853.

To return from this digression upon ferns. The siliceous cuticle from the stems of grasses exhibits the beautiful arrangement of silica so constant in exogenous plants, all of which are very interesting objects for polarised light: Equisetum, wheat, barley, oat or rye straw, Malacca cane, bamboo, &c. Hairs are found principally upon the under surface of leaves; they are best seen when viewed as opaque objects. Good specimens may be obtained from leaves of *Deutzia*, *Anchusa tinctoria*, *Borago officinalis*, *Dolichos pruriens*, &c. Pollen should be viewed by the dark-ground illuminator, and with a magnifying power of 100 diameters. That of the Passion-flower is curious, and if immersed in dilute sulphuric acid is seen to open and disperse the grains. The pollen of the *Datura Stramonium*, if placed on a slide, and a few drops of dilute acid added, will send forth a tube of some length; the granular matter in the pollen may be seen to pass along the tube until it is emptied. For these observations a half-inch power is required. Remarkable forms of pollen are found in the following plants: *Anagallis arvensis*, *Fuchsia globosa*, *Convolvulus*, *Jasmine*, *Lychnis*, *Penstemon*, *Polygonum orientale*, *Tulip*, *Marvel of Peru*, &c.

The following are amongst the most characteristic examples of woody fibre: flax, hemp, China-grass, section of pine, yew, date-palm, cedar-wood, cork, oak, mahogany, root of gooseberry, sycamore, furze, apple, vine, cotton, lace-tree bark, &c. In the cotton-plant, the hairs are attached to and envelop the seeds; their fibres are readily distinguished from those of linen, wool, &c.: being tubular fibres of cellular tissue, these tubes, from the thinness of their sides, collapse, and appear like flat ribbons or bands, woven or interlaced together; which is a reason for cotton being preferred to linen (flax) in making lint for surgical purposes.

Thin sections of charred wood sometimes show structures not seen in any other way. In fossil woods, after making thin sections, it is necessary to grind them on a lapidary's wheel, and afterwards polish them. In the ashes of coal a variety of vegetable structures may be discovered; which must be rendered transparent by immersion in Canada balsam. Stones and shells of nuts are prepared in the same way; or we may grind them between a piece of cork and boxwood, with fine emery-powder, as we should sections of bone.

Sections of woods, if cut from hard woods, containing gum, resin,

&c., should be soaked in essential oil, alcohol, or ether, before they are mounted as transparent objects. A razor may be fixed to the bench for the purpose of cutting these fine sections, or a fine plane will answer very well. The best instrument is the one used by Mr. Topping, fig. 214. *a b* is a flat piece of mahogany, seven inches long and four wide, to the under surface of which is attached, at right angles, a piece *g* of same size as *a b*. *d* represents a flat plate of brass, four inches long and three wide, screwed to the upper surface of *a b*; to the middle of this plate is attached a tube of the same metal *e i*, three inches long and half an inch in diameter, and provided at its lower end with a screw *f*, working in a nut, and having a disk *k* exactly adapted to the bore of the

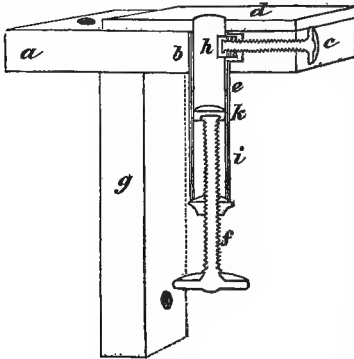

fig. 214. *Cutting Machine.*

tube; this disk is connected with the upper-end of the screw, and is moved up or down by it. *c* is another screw connected with a curved piece of brass *h*, which is capable of being carried to the opposite side of the tube by it. The piece of wood about to be cut is put into the tube *e*, and is raised or depressed by the screw *f*; whilst, before cutting, the curved piece of metal *h* should be firmly pressed against it by the screw *c*. This instrument is to be fastened to the edge of a bench or table, where it may be always kept ready for use. The knife to be employed may be one constructed for the purpose; or a razor ground flat on one side will be found to answer very well.

Method of making Sections.—If the wood be green, it should be cut to the required length, and be immersed for a few days in strong alcohol, to get rid of all resinous matters. When this is accomplished, it may be soaked in water for a week or ten days; it will then be ready for cutting. If the wood be dry, it should be first soaked in water and afterwards immersed in spirit, and before cutting placed in water again, as in the case of the green wood. If the machine to be employed be such as described, the wood (if sufficiently large) should be cut so as to fit tightly into the square hole, and be driven into it by a wooden mallet; if, on the contrary, it be round, and at the same time too small for the hole, wedges of deal or other soft wood may be employed to fix it firmly: these will have the advantage of affording support, and if necessary, may be cut with the specimen, from which they may after-

wards be easily separated. The process of cutting consists in raising the wood by the micrometer screw, so that the thinnest possible slice may be taken off by the knife; after a few thick slices have been removed to make the surface level, a small quantity of water or spirit may be placed upon it; the screw is then to be turned one or more divisions, and the knife passed over the wood until a slice is removed; this, if well wetted, will not curl up, but will adhere to the knife, from which it may be removed by pressing blotting-paper upon it, or by sliding it off upon a piece of glass by means of a wetted finger. The plan generally adopted is to have a vessel of water by the side of the machine, and to place every section in it: those that are thin can then be easily separated from the thick by their floating more readily in the water; and all that are good, and not immediately wanted, may be put away in bottles with spirit and water, and preserved for future examination. If the entire structure of any exogenous wood is required to be examined, the sections must be made in at least three different ways; these may be termed the transverse, the longitudinal, and the oblique, or, as they are sometimes called, the horizontal (seen at No. 5, fig. 211), vertical, and tangential: each of these will exhibit different appearances, as may be seen upon reference to fig. 215. *b* is a vertical

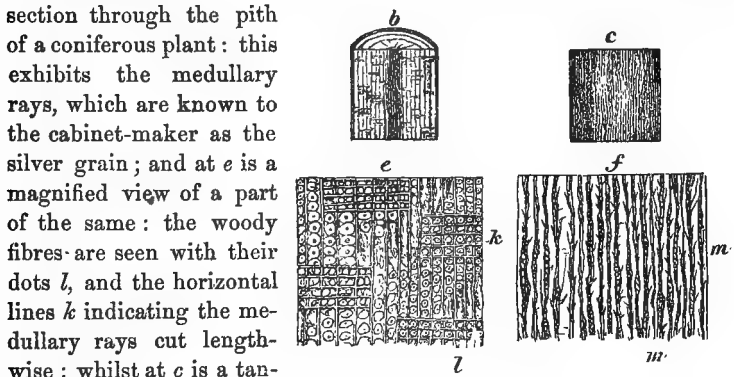

fig. 215.

section through the pith of a coniferous plant: this exhibits the medullary rays, which are known to the cabinet-maker as the silver grain; and at *e* is a magnified view of a part of the same: the woody fibres are seen with their dots *l*, and the horizontal lines *k* indicating the medullary rays cut lengthwise; whilst at *c* is a tangential section, and *f* a portion of the same magnified: the openings of the medullary rays *m m*, and the woody fibres with vertical slices of the dots, are to be seen. Very instructive preparations may be made by cutting oblique sections of the stem, especially when large vessels are present, as then the internal structure of the walls of some of them may oftentimes be examined. The diagram above given refers only to sections of a pine; all exogenous stems, however, will exhibit three different appearances, according

to the direction in which the cut is made; but in order to arrive at a true understanding of the arrangement of the woody and vascular bundles in endogens, horizontal and vertical sections only will be required. Many specimens of wood that are very hard and brittle may be much softened by boiling in water; and as the cutting-machine will answer other structures besides wood, it may here be stated, that all horny tissues may also be considerably softened by boiling, and can then be cut very easily.*

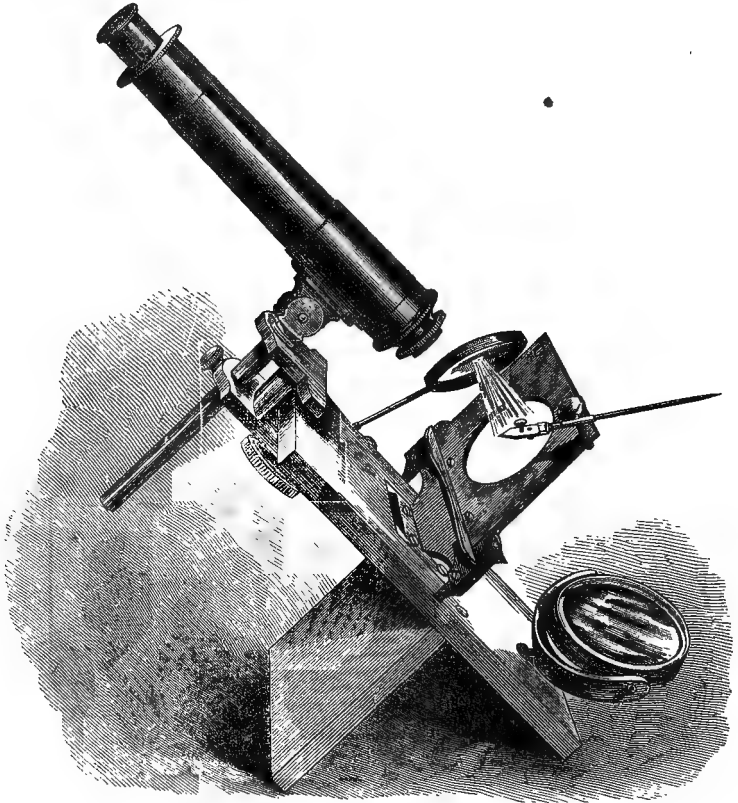

fig. 216.

Mr. Warington's Microscope.—The maker of this instrument, Mr. Salmon, 100 Fenchurch Street, has enabled us to give a drawing of

* Professor Quekett on the *Microscope*.

this useful and ingenious microscope, referred to at page 51 of our book. Fig. 216 is a representation of it as it appears when put together ready for use ; and fig. 217 shows it taken to pieces, and ready for packing in a leather case. The simplicity of arrangement here exhibited must commend itself to every microscopist. It is unnecessary to give a lengthy description of it : and we content ourselves by observing, that it is firmly clamped to the stand or wood bottom, and by means of this same clamp it can be fixed to the side of a vivarium or table. The draw-tube itself is the coarse adjustment, whilst a finer is secured by a well-made union-joint, into which the object-glass is screwed. With an additional arm for the reception of a single lens, it can be converted into a dissecting microscope. It is a cheap and useful form of instrument, either for the student or sea-side purposes.

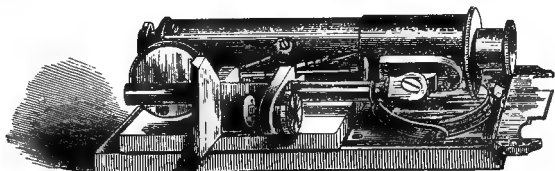

fig. 217.

Other makers have turned their attention to the manufacture of cheap instruments to meet the requirements of students; among whom we may mention Messrs. Smith and Beck, and Messrs. Field and Son of Birmingham.

M. Dujardin found that, to produce the best effects, a prism of glass should be used instead of a mirror. The prism should be so arranged as to slide upon the end of the condenser, and turn upon it in such a manner, that in whatever position the lamp or light may be, the prism may be adjusted to it. The quantity of light passing through it is greater than with the mirror ; and those test objects in which delicate markings exist, are seen to much greater advantage in consequence of all the rays being reflected from the same surface, which is not so with a silvered *glass mirror*.

Mr. John Furze has lately directed the attention of microscopists to a beautiful arrangement for the "illumination of objects by polarised light on a dark field, in such a manner as to give the object a stereoscopic effect by a due contrast of light and shade." To obtain this result, he uses a plano-convex lens, three-fourths of an inch in diameter. This, when fitted, is of so small a size, that it can be adapted to any

instrument. Such an illuminating lens should be arranged with a system of both central and external stops, each revolving on a separate axis; and an adjustable cap to slide over the top of the lens, containing a crystal of herapathite mounted between thin glass; also a plate of selenite mounted in the same way, to use on the stage above it. Objects of too great density for transmitted light will appear under this mode of illumination as if in relief; and the definition of the various parts will be so accurately displayed as to constitute a most perfect method of viewing them.

Before we conclude, we beg to direct the attention of the reader to the beautiful experiments of Mr. John Gorham,* as illustrating the wonderful magnifying power of the human eye. The fact itself is one of great interest to the microscopist, who has hitherto almost exclusively availed himself of the optician's aid in his examination of minute bodies.

We are only able to notice the results arrived at by this able investigator, which are as follows: "That when small bodies are brought very near to the eye, their images are magnified, just as images of larger objects, when seen at a distance, are diminished, and by the same law. The apparent magnitude of objects depends on their visual angle. The visual angle, for short distances, may be well illustrated by employing a small circular disk of light. This minute circular disk of light is procured by perforating a card with a needle. A sewing-needle, of the size marked No. 7, produces an aperture about the one-fortieth of an inch in diameter. In order to examine the light which is transmitted through such an aperture, all extraneous rays should be excluded; hence the plane in which the opening is made should be placed at the end of a tube. The pencil of light admitted through an opening of this kind, held within an inch or so of the eye, consists of rapidly-diverging rays falling upon the cornea. Some of these are entirely lost, others are intercepted by the iris, while the remainder pass on through the pupil, which communicates to the image formed on the retina its circular form.

For the purpose of presenting very small objects mounted on microscopic slides in the usual way before the eye, and to exclude the surrounding rays of light, take an upright box of pasteboard about one inch and a half deep, and an inch and a quarter in diameter (two pill-boxes joined will do very well); cut a couple of slits through one of its sides, sufficiently large to admit of the slips of glass sliding to and fro. Make two apertures (perforations with a needle) opposite to each

* Published in the *Quarterly Journal of Microscopical Science*, October 1845.

other—the first the 1-30th of an inch, and the second the 1-40th of an inch in diameter;* let these be so disposed, that when the glass slip, with a small object mounted on its centre, is introduced through the slits, the two apertures and the object shall all correspond, and be in one straight line, while the slide is about a quarter of an inch behind the smaller opening, as in fig. 218.

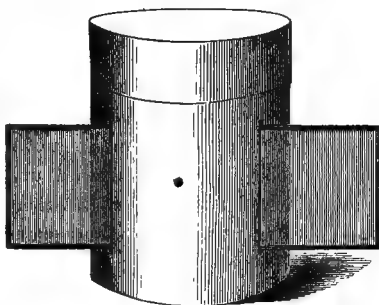

fig. 218.

The image becomes more distinct when more than one aperture is used; for the intensity of light by which it is illuminated is thereby increased, being almost in a direct ratio with the number of the openings which are employed.

It is found that the magnifying power of the eye is limited by the magnitude of the visual angle on the one hand, and by the intensity of light on the other. If the visual angle be too large, the rays are not sufficiently refracted by the humours of the eye to converge to a focus and form an image on the retina; and if too small, the image is reduced to a mere point. The exact amount of divergence of the rays, therefore, for any individual eye, lies somewhere between these two extremes. Again, however accurately adjusted the visual angle may be to the refractive powers of the eye, if the light be too strong the pupil becomes so contracted that only the innermost rays are admitted; while if it be of small intensity, the object is so dimly illuminated as to be scarcely visible. If, then, whilst a small object is held very near to the eye, so as to ensure a rapid divergence of the rays proceeding from it, the pupil can be dilated by the small quantity of light which is used, and to which, like a photometer, it immediately responds, so as to admit as large an angle as the lens and humours of the eye are capable of refracting, at the same time that the object is rendered distinctly visible, then, under such circumstances, we have arrived at the utmost limit to the available magnifying power of the eye."

Well may we inquire with the immortal Newton: "Was the eye

* Sewing-needles are ordinarily sold in papers, numbered from 1 to 12, according to their thickness. The diameters of apertures made with needles from the papers marked Nos. 6, 7, 8, 9, and 10, when measured with the micrometer, are equal to the 1-36th, the 1-38th, the 1-44th, the 1-50th, and the 1-70th of an inch.

contrived without skill in optics?" or with the divine Psalmist: "He that formed the eye, shall He not see?"

By vision, aided by knowledge, we pierce into the heavens and the interior of bodies, examine the minutest fragments of matter, and the universe of stars; by our motion on the surface of the globe, and by its motion, we measure space, and are at once convinced that the infinitely small, and the infinitely great, of which we get an idea by vision, have for us no bounds—nothing that we can reach and measure. Infinity is every where around us, and the evidences of this revealed by the microscope carry with them convictions that are not to be surpassed for their solemnity and grandeur.

The restless curiosity of the human intellect led to the invention of the telescope, by which man daringly pierced the mysterious and illimitable space above us; revealing to his understanding a great and wonderful series of worlds lost to his unaided powers of vision; while, by the microscope, he has discovered an animal, vegetable, and mineral kingdom, of which he was previously ignorant, on account of its minuteness placing it beyond the keenest observation of the naked eye. In this last-named, new, and amazing world there is displayed a beauty, a perfection, adaptation, and reproduction, surprisingly surpassing those objects with which we are familiar in every-day life. With the microscope we search into the mysteries of creation, and detect many of the secret workings of nature. We see the utility of a busy, multitudinous, invisible world of animal life, to the health, comfort, and preservation of human-kind; and the unbounded love of God in the admirable secret provisions for the unceasing changes in the form of matter. The more powerful the instrument, the more astounding its revelations; until we marvel in what sized atom organic matter ceases; and our facts become stranger than fiction, and far beyond the imaginings of the most poetic brain.

How vast, indeed, is the variety of forms under which organised nature exists! How endless the number of animals and plants that people and adorn the globe! Day after day brings us acquainted with species hitherto unknown; and it seems as if the door of discovery is never to be closed. Whenever a new country is visited, animals and plants, different from what had before either been known or imagined, are discovered; but how many regions will remain to be explored in that, as yet almost unknown country, which belongs to the microscope, after every spot of the earth shall have been described and laid down accurately in the map?

What we know at present, even of things the most near and

familiar to us, is so little in comparison of what we know not, that there remains an illimitable scope for our inquiries and discoveries ; and every step we take serves to enlarge our capacities, and give us still more noble and just ideas of the power, wisdom, and goodness of God. This marvellous universe is so full of wonders, so teems with objects of latent beauty, that perhaps eternity alone will open up and develop sufficient opportunities to enable us to survey and admire and appreciate them all.

“ And lives the man, whose universal eye
 Has swept at once th' unbounded scheme of things ;
 Mark'd their dependence so, and firm accord,
 As with unfaltering accent to conclude
 That this availeth nought ? Has any seen
 The mighty chain of beings, lessening down
 From infinite perfection to the brink
 Of dreary nothing, desolate abyss !
 From which astonish'd thought, recoiling, turns ?
 Till then, alone let zealous praise ascend,
 And hymns of holy wonder, to that Power,
 Whose wisdom shines as lovely on our minds,
 As on our smiling eyes his servant sun.”—THOMSON.



INDEX.

- ACALEPHÆ**, 24.
Acarina, 326.
Acarus of beetle, 334.
 — of cloth moth, 334.
 — farinæ, 332.
 — of fly, 334.
 — of fowl, 333.
 — of rat, 328.
 — sacchari, 331.
 — scabiei, 329.
Achetina, 321.
Achnanthes, 159.
Achromatic illuminator, 60.
 — object-glasses, 34.
Acinetinæ, 147.
Actiniæ gemmacea, 218.
 — maculata, 222.
 — mesembryanthemum, 220.
 — rubra, 220.
 — Tuediæ, 222.
Actinocyclus, 161.
Adams' microscope, 8.
Alcyonella, 181.
Alcyonidæ, 215.
Alcyonium, digitatum of, 87.
Algæ, 406.
Air-pump for removing air-bubbles, 79.
Amæba, 131.
Amici's microscopes, 10.
Anacharis alsinastrum, 435.
Angle of aperture, 34.
Anguinaria, 228.
Animalcules, cilia of, 138.
 —, collecting, 69.
 — history of, 138.
 — infusorial, 136.
 — marine, 141.
 — polygastric, 136.
 — rotating, 167.
Animal cell, 346.
 — action of cells, 352.
 — action of cilia, 355.
 — articulata, 286.
 — cell, history of, 346.
 — cells, change of into tissues, 348.
Animal cells, change of into intercellular substance, 352.
 — connective tissue, 367.
 — elementary tissue, 367.
 — epithelium, 353.
 — fibrous membrane, 368.
 — membrane, 367.
 — multiplication of cells, 348.
 — structure, 343.
 — structure, mode of investigating, 379.
 — tissue consolidated, 372.
Annelida, 274.
Anthea, 222.
Aquarium for fish and plants, 245.
Arachnidæ, 282.
Arachnoidiscus, 162.
Aristophanes, microscope known to, 2.
Articulata, 270.
Artists, designs for, 162.
Astasiæa, varieties of, 146.
Asteroidæ, 211.
BAKER ON THE MICROSCOPE, 8.
Balanidæ, 280.
Barnacle, 280.
Bee's tongue, leg, &c., 314.
Beetles, description of, 315.
Bennett, Dr., on investigating animal structure, 387.
Berg-mehl, 163.
Binocularity, applied to microscope, 121.
Binocular microscope, Wenham's, 122.
Blackwell, Mr., on flies, 294.
Blood corpuscles, 360.
 — crystallization of, 363.
Blow-fly, 296.
Bone, birds', 383.
 — cutting sections of, 386.
 — fishes', 384.
 — human, 379.
 — reptiles', 383.
Bonnani's microscope, 7.
Boys, Mr. Thomas, on mounting objects, 80.

- Brachionæ, 169.
 Brewster, Sir David, on viewing objects, 54.
 Brooke, Mr., on viewing opaque objects, 64.
 — on test objects, 44.
 Bryozoa, 236.
 — Bowerbankia, 238.
 Burnett, Dr., on parasites, 332.
 Busk, Mr., on *Anguinaria spatulata*, 228.
 — on Hydatids, 274.
 — on Notamia, 238.
 — on starch granules, 424.
 Butterflies and moths, 304.

 CALEPTERYX VIRGO, 299.
 Camera-lucida, 101.
 — Quekett, Professor, on the use of the, 101.
 Campanularia, 207.
 — volubilis, 207.
 Campylodiscus clypeus, 161.
 Capillaries, 363.
 Cartilage, 373.
 Caryophyllia, 224.
 Celleporidæ, 225.
 Cells of glass for dissections, 77.
 Cellulariæ, 226.
 Cellular tissue of plants, 419.
 — in animals, 368.
 Cementing pencil, 78.
 Cements, 77.
 Chara vulgaris, 433.
 Cheese-mite, 330.
 Chemical re-agents, 90.
 Circulation of blood in frog, how to view, 389.
 Cirrhipoda, 279.
 Clepsinidæ, 276.
 Clionæ, 186.
 Cocconeis, 161.
 Cocconimo Bœeckii, 159.
 Cochineal insect, 308.
 Cockchafer, 316.
 Collecting objects, 95.
 — animalcules, 69.
 — stick, Mr. Williamson's, 70.
 Collodion for multiplying objects, 291.
 Comatulidæ, 251.
 Confervoidæ, 406.

 Consolidated tissues, 272.
 Corallines, 233.
 Coral reefs, Captain Basil Hall on, 235.
 — Dr. Macculloch on, 234.
 Coryne-stauridia, 210.
 Coscinodiscus, 162.
 Crane-fly, 288.
 Cricket, 323.
 Crinoidea, 250.
 Crisiadæ, 227.
 Crustacea, 278.
 Crystals of snow, 118.
 — quinine, 116.
 — urinary salts, 115.
 Cutting machine, 444.
 Cyclops, 280.
 Cypridæ, 281.
 Czermak upon tooth substance, 376.

 DAPHINADÆ, 281.
 Deane, Mr., on mounting objects, 80.
 Death-watch beetle, 318.
 Delabarre's microscope, 8.
 Demodex folliculorum, 330.
 Denny, Mr., on parasites, 326.
 Desmidaceæ, 409.
 Deutzia scabia, 422.
 Diaphragm, description of, 56.
 Diatomaceæ, 148.
 — Kützing on, 149.
 — Rev. W. Smith on collecting and preserving, 153.
 Dipping-tube for animalcules, 68.
 Disk, circular, 76.
 Dissecting knives and needles, 72.
 Divini's microscope, 6.
 Dragon-fly, description of, 299.
 Drone-fly, 295.

 ECHINIDÆ, 248.
 Echinococci, 274.
 Egg of bed-bug, 122.
 Eggs of insects, 304.
 Ehrenberg on infusoria, 143.
 Enchelia, 147.
 Encrinidæ, 251.
 Entomostraca, 281.
 Entozoa, 270.
 Epizoa, 270.
 Errantia, 277.

- Escharidæ, 229.
 Eye, magnifying power of, 448.
 Eye-pieces, value of, 43.
 Eyes of insects, 290.
 Eucratiadæ, 228.

FEET of insects, 293.
 Ferns, 441.
 Fibre, muscular, 369.
 Fibrous tissue, 368.
 Fish, 391.
 Fishes' scales, 392.
 Flea, 324.
 — cat's, 325.
 — larva of, 325.
 Floscularidæ, 172.
 — Gosse's description of, 174.
 — Stephanoceros, 172.
 Flustræ, 231.
 — carbacea, 231.
 — chartacea, 231.
 — foliacea, 231.
 — Lamouroux on, 230.
 Fly, foot and leg of, 293.
 Foraminifera, 133.
 Forceps for holding objects, 67.
 — Varley's, 68.
 Fossil Infusoria, 155.
 Frauenhofer's glasses, 8.
 Frog-plate, 390.
 — circulation, 363.
 Fungoid growths, 401.
 Furze, Mr. J., on illumination, 447.

GALLIONELLA Sulcata, 160.
 Gammaridæ, 281.
 Garrod's, Dr., crystals in blood, 363.
 Gas-lamp, Highley's, 66.
 Gasteropoda, 261.
 Gillett's Illuminator, 57.
 Glycerine for mounting objects, 81.
 Gnat, description of, 301.
 Goadby's fluids, 83.
 Gorgoniadæ, 212.
 — spiculæ of, 188.
 Gorham's, Mr., holder, 78.
 — on eyes of insects, 291.
 — on the magnifying power of the eye, 448.
 Gosse, Mr., on marine animalcules, 141.
 Gosse, Mr., on marine vivaria, 243.
 Grant, Dr., on Flustra, 230.
 Grape blight, 400.
 — section of, 401.
 Guinea worm, 273.
 Gyrimus, 320.

HAIR, 356.
 Harris, Mr., on the grape-blight, 400.
 Hassall, Dr., on the adulteration of food, 428.
 Herapath on the uses of polarised light, 111.
 — iodo-quinine, 114.
 Highley's photographic camera for microscope objects, 127.
 — gas-lamp, 66.
 Hill's treatise on the microscope, 8.
 History of animalcules, 155.
 Holland's eye-piece, 25.
 Holothuridæ, 252.
 Homoptera, 306.
 Hooke's microscope, 6.
 Human body, 346.
 Huxley, T. H., Mr., on the cell theory, 366.
 Huyghenian eye-piece, 36.
 Hydatids, 272.
 Hydra, 197.
 Hydrachnidæ, 336.
 Hydrophilus, 292.
 Hymenoptera, 310.

ICELAND spar, 107.
 Importance of insects, 341.
 Improvements in microscope, 8.
 Infusoria, Ehrenberg's account of, 143.
 — fossil, 155.
 — history of, 136.
 Infusorial animalcules, 129.
 Injecting, mode of, 84.
 Insects, 286.
 — changes of, 338.
 — commercial importance of, 340.
 — dissection of, by Swammerdam, 337.
 — distribution of, 339.
 — eggs, 304.
 — feet, 293.
 — itch, 329.
 — mouths, 295.

- Insects**, parts of, for examination, 288.
 — proboscis, 301.
 — stings, 312.
 — tongues, 275, 383.
 — uses of, 296.
 — wings, 299.
- Internal parts of the body**, 360.
- Isis hippuris**, 169.
- Isthmia enervis**, 161.
- Ixodidæ**, 333.
- JACKSON'S MR.**, micrometer, 39.
- Johnston, Dr.**, on sponges, 178.
- Jones Mr. Wharton**, on non-striated muscular fibre, 371.
 — on the circulation in frog's foot, 363.
- KING, Mr.**, on polarised light, 110.
- Knives**, Quekett's and Valentin's, 75.
- Kölliker** on the muscles of the skin, 371.
- LANKESTER, Dr.**, on sponges, 179.
 — on the distinction between plants and animals, 179.
- Leech**, medicinal, 275.
- Leeuwenhoek's microscope**, 5.
- Lenses**, achromatic, 21.
 — chromatic aberration of, 21.
 — Coddington, 26.
 — concavo-convex, 19.
 — condensing, 64.
 — different forms of, 14.
 — double convex, 20.
 — meniscus, 20.
 — method of tracing progress of rays through, 14.
 — periscopic, 26.
 — plano-convex, 18.
 — refraction of light through, 14.
 — spherical aberration of, 17.
 — Stanhope, 27.
- Lepidoptera**, 304.
- Lepismidæ**, 323.
- Lepralia**, 226.
- Libellulidæ**, 299.
- Lieberkhun's microscope**, 4.
 — specula, 65.
- Life**, theory of animal, 344.
- Limneus stagnalis**, 263.
- Linnaeus** on drone-fly, 296.
- Lister's lenses**, 10.
- Louse**, 327.
- Lucernaridæ**, 222.
 — campanulata, 222.
- Lycosidæ**, 285.
- MADREPORIDÆ**, 224.
- Marine vivaria**, 243.
- Micrometers**, 38.
- Microscope**, Baker on the, 8.
 — Baker's student's, 50.
 — Bonnani's, 7.
 — compound, 29.
 — Huyghenian eye-piece of, 36.
 — Lieberkhun's, 4.
 — Powell and Leland's, 51.
 — Ross's, body of, 35.
 — Ross's large compound, 47.
 — Ross's small compound, 50.
 — simple, 27.
 — simple for dissections, 27.
 — Warrington's, 446.
- Mollusca**, 253.
- Monads**, 142.
- Mosses**, 405.
- Moths and butterflies**, 304.
- Mülder** on the vegetable cell, 398.
- Muscular fibre**, 369.
- NAVICULÆ**, 151.
 — Quekett on, 234.
- Nerves**, 371.
- Newport** on Moths, 305.
- Newt**, 391.
- Nicols' prism**, 107.
- Nitella**, 432.
- Noctiluca miliaris**, 141.
- Notamia**, 238.
- OBJECT-GLASSES**, 32.
 — Ross's, 42.
- Objects**, Shadbolt on collecting, 95.
 — mounting and preserving, 77.
 — Boys on mounting, 80.
- On collecting salt-water specimens**, 267.
- Ophiuridæ**, 251.
- Osborne, Rev. S. G.**, on fungi in the air, 401.
- Owen, Professor**, on animalcules, 176.

- Owen, Professor, on microscopic investigation, 375.
- Oyster, 255.
- Oyster Fry, 280.
- PARABOLIC reflectors, 62.
- Parasites, 326.
- of cat, 328.
- of dog, 328.
- of eagle, 335.
- of fowl, 333.
- of hornbill, 332.
- human, 327.
- of pheasant, 333.
- of pigeon, 335.
- of sheep, 336.
- of swallow, 332.
- of turkey, 333.
- of vulture, 335.
- Parkes', Dr., caution on using re-agents, 92.
- Pearls, 256.
- artificial, 257.
- Pediculi, 333.
- Pennatulidæ, 213.
- Photography applied to microscope, 126.
- Phryganeidæ, 303.
- Pigment cells, 356.
- Plants, chorophyl in, 432.
- cellular tissue of, 419.
- circulation in, 433.
- crystals in, 420.
- lactiferous tissue of, 419.
- lice, 308.
- preparation of tissues, 440.
- raphides in, 420.
- sections of, 443.
- siliceous cuticle of, 443.
- starch in, 422.
- starch of potato, 426.
- structure of, 394.
- vascular tissue of, 436.
- vital characteristics, 395.
- Podura plumbea, 323.
- Polarisation of light as applied to the microscope, 103.
- Polygastria of Ehrenberg, 136.
- Polypifera, 195.
- Polythalamia, 133.
- Porifera, 177.
- Potato, disease of, 426.
- Preparation of insects, 337.
- Preparing sections of bone, 386.
- Preservation of algæ, 92.
- zoophytes, 241.
- Prism, Dujardin's, 447.
- Proteus, the, 131.
- Protozoa, 130.
- QUEKETT, Edwin, Mr., on the vascular tissue of plants, 437.
- Professor, on advantages of polarised light, 121.
- on raphides in plants, 420.
- on the structure of bone, 378.
- RALFS, Mr., on Desmidiaceæ, 409.
- Read, Rev. J. B., on the background illuminator, 64.
- Reflector, parabolic, 62.
- Shadbolt's, Mr., 64.
- Rhizopoda, 133.
- Ross, Mr., on illumination, 55.
- Rotatoria, 167.
- SALTER, Dr., on dentine, 376.
- Dr. Hyde, on muscle, 370.
- Salt water, artificial, 245.
- Sarcina ventriculi, 399.
- Sarcoptes scabiei, 329.
- Saw-fly, 310.
- Schacht's, Dr., preservative fluid for microscopic uses, 90.
- Scissors for dissecting, 75.
- Sea-mice, 277.
- Section cutting-machine, 444.
- Selenite, 110.
- Serpula, 277.
- Sertularia filicula, 242.
- Sertularidæ, 202.
- Shadbolt, Mr., on collecting objects, 95.
- Silkworm's breathing-aperture, 292.
- Siller-cups, 404.
- Single microscope, 3.
- Skeletons of zoophytes, 241.
- Skin, fungoid diseases of, 401.
- section of, 358.
- Smith's and Beck's troughs, 72.
- Smith, James, Mr., on management of light in viewing objects, 54.

- Snow, crystals of, 118.
 — red, 404.
 Sphagnum, leaf of, 438.
 Spider tribes, 282.
 — diving, 285.
 Sponges, 177.
 — skeletons of, 186.
 Starch in plants, 422.
 — tests for, 411, 424.
 Stentor, 165.
 Stinging-nettle, leaves of, 432.
 Structure of shells, 266.
 Sugar insect, 331.
 — cane, 439.
 Swammerdam's dissection of insects, 286.
 Synaptidæ, 252.

TEETH, 375.
 Test objects, 44, 306.
 Tissues, consolidated animal, 372.
 — elastic and non-elastic, 368.
 Tomata, diseased, 400.
 Topping's, Mr., fluid for mounting, 95.
 — test-objects, 307.
 Torula cerevisia, 398.
 — diabetica, 399.
 Tourmaline, 109.
 Transformation of insects, 338.
 Trichocera hyemalis, 301.
 Troughs for animalcules, 72.
 Tubicola, 276.
 Tubularidæ, 208.

 WARD, N. B., Mr., on aquaria, 245.
 Warington's, Mr., microscope, 447.
 — preservative fluid, 81.
 Wasp's tongue, 289.
 Water-beetle, sucker of, 292.
 Water microscope, 3.

 Water-mites, 336.
 Wenham, Mr., binocular microscope, 121.
 — illuminator, 62.
 Westwood on insects, 294.
 Wheat-flour, adulterations of, 425.
 — portions of husk, 423.
 Wichura, M., on the spiral forces of nature, 368.
 Wollaston's and Coddington's lenses, 26.
 Wonders of microscope, 155.
 Wood, cutting sections of, 444.
 Woodward, Mr., on polarised light, 108.

VALLISNERIA, 433.
 Varley, Mr., on the culture of water-plants, 434.
 Vegetables, structure of, 394.
 — cellular tissue of, 419.
 — fungi, 401.
 — hairs in, 432.
 — preparation of tissues, 440.
 — raphides in, 420.
 — starch in, 424.
 — vascular tissue in, 436.
 Vibrio spirilla, 145.
 Virgularia mirabilis, 214.
 Vivaria, the mode of forming, 244.
 — by Mr. Gosse, 243.
 — by Mr. Lloyd, 393.
 Volvox, 407.
 Vorticellidæ, 163.

XANTHIDIA, 192.

YEAST-PLANT, 399.

ZOOLOGICAL Society's marine vivaria, 243.
 Zoophytes, 195.
 — preservation of polypidoms of, 241.
 Zygodon rhombus, 162.

LONDON :

 PRINTED BY ROBSON, LEVEY, AND FRANKLYN,
 Great New Street and Fetter Lane.

LIST OF BOOKS

PUBLISHED AT THE

OFFICE OF THE NATIONAL ILLUSTRATED LIBRARY,
198 STRAND, LONDON.

Fifth Edition.

WEBSTER'S DICTIONARY

OF THE

ENGLISH LANGUAGE;

Exhibiting the Origin, Orthography, Pronunciation, and Definition of Words; comprising also a Synopsis of Words variously pronounced by different Orthoepists, and Walker's Key to the Classical Pronunciation of Greek, Latin, and Scripture Proper Names. A New Edition, revised and enlarged, by C. A. Goodrich, Professor in Yale College. With the addition of a Vocabulary of Modern Geographical Names, and their Pronunciation. The new words that have been added amount to several thousands, and the Dictionary now contains 27,000 words more than "Todd's Edition of Johnson." The work is handsomely printed upon a fine paper, in a clear readable type, in double columns.

	£	s.	d.
Royal 8vo, extra cloth, 1265 pages	0	16	0
Ditto, ditto, half-calf, ditto	0	18	0
Ditto, ditto, calf gilt, ditto	1	0	0
Ditto, ditto, half-russia, marbled edges	1	0	0
Strongly bound in russia, marbled edges	1	4	0

TESTIMONIALS.

"We can have no hesitation in giving it as our decided opinion, that this is the most elaborate and successful undertaking of the kind which has ever appeared."—*Times*.

"The present edition is in a handsome portable form—imperial octavo; it is clearly and correctly printed, upon moderately thick paper; and it is sold at a price proportioned rather to the wants of the public than to its intrinsic cost—so cheap is it compared with other similar publications."—*Observer*.

"A mine of philological wealth."—*Wm. Russell, Esq.*

"Best Dictionary of the English Language."—*Morning Chronicle*.

"A noble monument of erudition."—*Literary Gazette*.

"Most complete, accurate, and reliable Dictionary of the Language."—*Thirty Members of United States Senate*.

"It is acknowledged, both in this country and in America, to be the most copious and most excellent at present in circulation."—*Editor of the London Imperial Dictionary, 1849*.

"We rejoice that it bids fair to become the standard Dictionary to be used by the numerous millions of people who are to inhabit the United States."—*Signed by 104 Members of Congress*.

"I possess many Dictionaries, and of most of the learned and cultivated languages, ancient and modern; but I never feel that I am entirely armed and equipped in this respect, without Dr. Webster at command."—*Daniel Webster*.

"This edition of Webster's unrivalled work gives us an opportunity of recording our judgment in its favour, and in harmony with authorities who have described it as the standard of our language. Dr. Johnson places the writer of dictionaries among the unhappy mortals who are exposed to censure, without the hope of praise; one whom mankind have considered not as the pupil but as the slave of science, the prisoner of literature, and its humble drudge where toils are not cheered by a smile from learning and genius as they press forward to conquest and glory. If this be the rule, Dr. Webster is the exception. There is, we suppose, no scholar or writer in this country who does not give the greatest honour to the man whose lengthened labours, aided by his very able associates, have compiled this vast treasure of learning. Great indeed was the work of Dr. Johnson, but it has necessarily ceased to be a dictionary of a language which has been growing and enriching itself ever since he laid down his pen, and of which period we have the benefit in the 27,000 words more than are contained in Todd's Johnson. The book is essential to every one who wishes to know the words that are now in our tongue, their definition given with severe simplicity and beauty, their correct pronunciation, and their classification in synonymses."—*Leeds Times*.

LONDON: H. INGRAM AND CO., 198 STRAND.

ILLUSTRATED EDUCATIONAL WORKS.

TWO HUNDREDTH THOUSAND.

The Illustrated London Spelling-Book; illustrated by upwards of One Hundred and Seventy beautiful Woodcuts of Objects and Scenes described; forming by far the most alluring Introduction to Learning ever published. 144 pages, cloth, 1s.; with coloured Plates, 2s.

FIFTY-FIRST THOUSAND.

The Illustrated London Reading-Book; containing a Series of Lessons on the most amusing and instructive subjects, selected with great care from the best English Authors in prose and verse. The whole beautifully illustrated with above Two Hundred and Fifty Engravings. Cloth, 2s.

THIRTY-FIRST THOUSAND.

The Illustrated London Instructor; being a Companion to the Reading-Book; consisting of Extracts from English Classical Authors, from the earliest periods of English literature to the present day. With One Hundred and Twenty fine Engravings. Cloth, 2s.

Second Edition.

The Illustrated London Geography. By Joseph Guy, jun., of Magdalen Hall, Oxford, Author of numerous popular Educational Works. Demy 8vo, with about One Hundred Engravings of Cities, Customs, and Wonders of the World, &c. The Drawings are made with great care from truthful sources. Nine Maps have been engraved by a patent process expressly for this work, and are corrected to the present period. Cloth, 2s.; coloured plates, 3s.

"The present volume is beautifully 'got up,' and, being carefully compiled, presents a complete epitome of geographical knowledge."—*Tail's Magazine*.

"The Government press has produced no such elementary works as those of Ingram, Cooke, and Co., and other publishers—no such spelling-books, reading-books, and treatises on Geography, Optics, and Astronomy."—*Morning Advertiser*, September 28th, 1853.

The Illustrated London Astronomy, for the Use of Schools and Students. By J. R. HIND, F.R.A.S. (of Mr. Bishop's Observatory, Regent's Park). With numerous illustrative Drawings and Diagrams. Demy 8vo, cloth, 2s.

"Mr. Hind has certainly managed to simplify his sublime subject, and give a great amount of information in a few words."—*Art Journal*.

"Mr. J. R. Hind is so well known in connection with planetary researches, that his appearance in an educational library is as surprising as it is gratifying."—*Sherborne and Dorchester Journal*.

The Elements of Natural Philosophy (double volume). By JABEZ HOGG, M.R.C.S. Illustrated by upwards of 300 Woodcuts. Demy 8vo, cloth, 4s.

"Remarkable for its completeness, the number of admirable illustrations, and its cheapness. It will be extensively useful to schools and private students."—*Daily News*.

"It is completed in a style exceedingly creditable both to its editor and publishers; and we know of no work we can so strongly recommend as an interesting and useful introduction to the physical sciences."—*Medical Times and Gazette*.

The Illustrated London Architectural, Engineering, and Mechanical Drawing-Book. By R. S. BURN. With numerous Engravings. Demy 8vo, cloth, 2s.

"This book should be given to every youth, for amusement as well as for instruction."—*Taunton Journal*.

The Illustrated Practical Geometry. Edited by Robert Scott BURN, Editor of "The Illustrated London Drawing-Book." Demy 8vo, cloth, 2s. (Second Edition.)

"Suited to the youthful mind, and calculated to assist instructors, filled as it is with really good diagrams and drawings, elucidatory of the text."—*Globe*.

Electric Science: its History, Phenomena, and Applications.

By F. BAKEWELL, Author of "Evidences of Christianity," &c. Copiously illustrated. Demy 8vo, cloth, 2s.

"So much attention is drawn to this subject; its powers, though coeval with the creation, have been only so recently applied to facilitate communication; and we look to it so confidently for farther assistance,—that there is no compendium of recent date of such value to ourselves or to our children: the explanations are singularly clear, even to the non-scientific; and the volume, dealing as it does in miracles of facts, possesses all the interest of a novel."—*Art Journal*.

First Lessons in Arithmetic, on a New Plan. By Hugo Reid, late Principal of the People's College, Nottingham, and Author of numerous Educational Works. Demy 8vo, cloth, 2s.

"The First Lessons in Arithmetic are calculated to awaken the dullest intellect."—*Stamford Merc.*
 "The book is capitally adapted for the use of schools and for private tuition; and is remarkable for the beauty of its typography."—*Derby Mercury*.

The First Six Books of Euclid, with numerous Exercises.

Printed on a New Plan, with accurately executed Diagrams. Demy 8vo, cloth, 2s.

The present work, containing the First Six Books of the Elements of Euclid, that is, the foundation of Plane Geometry, is intended as a companion volume to that issued with it on Practical Geometry; the one embracing the theory, the other the application.

A New and greatly improved Elementary Grammar of the ENGLISH LANGUAGE, uniform with the "Illustrated London Spelling-Book." Strongly bound in cloth, 1s.

Mechanics and Mechanism. By Robert Scott Burn. With about 250 Illustrations. Demy 8vo, cloth, 2s. (Second Edition.)

The Illustrated London Drawing-Book: comprising a Complete Introduction to Drawing and Perspective; with Instructions for Etching on Copper or Steel, &c. &c. Illustrated with above Three Hundred Subjects for Study in every branch of Art. By ROBERT SCOTT BURN. Demy 8vo, cloth, 2s. (Second Edition.)

Geology for Schools and Students; or, Former Worlds, their Structure, Condition, and Inhabitants. By F. C. BAKEWELL, Author of "Electric Science," &c. With copious Illustrations. Price 2s., cloth, gilt.

Chemical Analysis for the Young; being a Series of Progressive Lessons illustrative of the Properties of Common Chemical Substances, and of the means of separating them from each other. By J. SCOFFERN, M.B. Cloth, gilt, price 2s.

The Steam-Engine; its History and Mechanism; being Descriptions and Illustrations of the Stationary, Locomotive, and Marine Engine. Forming a companion to "Mechanics and Mechanism." By R. S. BURN.

Algebra.—A Treatise on the Elements of Algebra, for the Use of Schools and Private Students. By G. AINSWORTH, B.A., and J. YEATS, F.R.G.S. Cloth, gilt, price 4s.

Handbook of Foliage and Foreground Plants. By George BARNARD, Esq., Author of "Sketches of Switzerland," "Drawing Book of Trees," &c Post 8vo, cloth, 6s.

The Illustrated New Testament (Authorised Version); with upwards of One Hundred and Twenty Engravings, beautifully bound in cloth, embossed gilt sides, and gilt edges. The Illustrations are from drawings executed by eminent Artists expressly for this edition; with Notes historical, explanatory, and descriptive; and embellished by a novel Panoramic Picture of the Holy Land, and a View of Lower Egypt. 4to, cloth gilt, 5s.

SENT TO ANY PART OF ENGLAND POSTAGE FREE.

BOOKS PUBLISHED BY H. INGRAM AND CO.
198 STRAND, LONDON.

THE NATIONAL ILLUSTRATED LIBRARY.

In handsome Volumes, containing about 300 pages and numerous Engravings, Crown 8vo, neatly bound in cloth, gilt, 2s. 6d.; cloth extra, gilt edges, 3s. 6d.; morocco gilt edges, 7s. 6d.; morocco antique, 10s. 6d.; 2 vols. in 1, calf, marbled edges, 9s.; morocco, gilt edges, 10s. 6d.

ADAPTED FOR PRESENTS OR SCHOOL PRIZES.

BOSWELL'S LIFE OF DR. JOHNSON. Complete in Four Volumes.

THE ILLUSTRATED BOOK OF BRITISH SONGS, from the Sixteenth to the Nineteenth Century. With Fifty Engravings.

THE MORMONS, OR LATTER-DAY SAINTS. An Account of the Rise and Progress of this new Religious Sect.

THE ORBS OF HEAVEN; or the Planetary and Stellar Worlds. A Popular Exposition of the Great Discoveries and Theories of Modern Astronomy.

PICTURES OF TRAVEL IN THE SOUTH OF FRANCE. From the French of ALEXANDRE DUMAS.

HUC'S TRAVELS IN TARTARY, THIBET, AND CHINA, in 1844, 5, and 6. Unabridged Edition. Two Volumes. With numerous Daguerreotypic Illustrations, and a Map of the Countries.

A WOMAN'S JOURNEY ROUND THE WORLD. Unabridged. From the German of IDA PFEIFFER.

MEMOIRS OF EXTRAORDINARY POPULAR DELUSIONS. Two Volumes. By CHARLES MACKAY, LL.D. Illustrated with One Hundred and Twenty Engravings from Authentic Sources.

BOSWELL'S JOURNAL OF A TOUR TO THE HEBRIDES. Companion Volume to "Boswell's Life of Johnson," with the Index to the "Life." By R. CARRUTHERS, Esq., of Inverness.

THE ILLUSTRATED BOOK OF SCOTTISH SONGS, from the Sixteenth to the Nineteenth Century.

PICTURESQUE SKETCHES OF LONDON, PAST AND PRESENT. By THOMAS MILLER.

MADAME PFEIFFER'S VISIT TO ICELAND AND THE SCANDINAVIAN NORTH. Companion Volume to "A Woman's Journey Round the World."

THE ISRAEL OF THE ALPS. A History of the Persecutions of the Waldensers. By the Rev. Dr. ALEXIS MURON.

A NARRATIVE OF THE UNITED STATES EXPLORING EXPEDITION. Two Volumes. With numerous Drawings, illustrative of the Manners, Customs, and Personal Appearance of the Inhabitants, and Views of the Scenery of the Countries Visited.

THE ILIAD OF HOMER. Translated into English Verse by ALEXANDER POPE. A New Edition, with Notes, Illustrations, and Introduction. By the Rev. THEODORE ALOIS BUCKLEY, M.A., Chaplain of Christ's Church, Oxford. Two Volumes.

THE ODYSSEY OF HOMER. With FLAXMAN'S Illustrations, &c. One Volume. Edited by the Rev. THEODORE ALOIS BUCKLEY.

MADAME PFEIFFER'S VISIT TO THE HOLY LAND, EGYPT, AND ITALY. Uniform with "A Woman's Journey Round the World."

THE COMPLETE ANGLER OF IZAAK WALTON AND CHARLES COTTON. New Edition, superbly Illustrated with Fifty Engravings of Fishes, Fishing Tackle, Flies, and Portraits and Landscapes. Edited by ЕРHEМЕРА, of "Bell's Life in London."

EXTRAORDINARY MEN; THEIR BOYHOOD AND EARLY LIFE. By W. RUSSELL, Esq.

THE PILGRIM'S PROGRESS FROM THIS WORLD TO THAT WHICH IS TO COME. By JOHN BUNYAN. A New Edition, with a Memoir by J. M. HARE. The Allegory illustrated with Thirty Outline Drawings by CLAYTON, and the Biographical Sketch with Interesting Relics and Recollections of the Author, by J. L. WILLIAMS.

TRAVELS IN SPAIN. From the French of THEOPHILE GAUTIER.

THE LIFE, PUBLIC AND DOMESTIC, OF THE RIGHT HON. EDMUND BURKE. By PETER BURKE, Esq., of the Inner Temple.

THE NATURAL HISTORY AND ANTIQUITIES OF SELBORNE. By the Rev. GILBERT WHITE, M.A. Edited, with Notes and Additions, by Sir WILLIAM JARDINE, Bart., F.R.S.E., F.L.S., M.W.S. Fully Illustrated.

THE LIFE AND POETICAL WORKS OF ALEXANDER POPE, with Extracts from his Correspondence. Four Volumes. The "Life" by R. CARRUTHERS, Esq., of Inverness; and the "Works" edited by the same Gentleman.

THE LIFE AND TIMES OF SIR WALTER RALEIGH, with copious Extracts from his "History of the World." By C. WHITEHEAD.

JOHNSON'S LIVES OF THE POETS. Completed by WILLIAM HAZLITT. In Four Volumes.

THE HISTORY OF RUSSIA, from the Foundation of the Monarchy by Rourick to the close of the Hungarian War. To which are added Dissertations on Serfdom, Landed Tenure, the Nobility, the Church, Trade, &c. By ALPHONSE RABBE and JONATHAN DUNCAN, B.A. With Tinted Illustrations by S. READ, of the principal Cities, Ports, and Harbours; and Maps of the Russian Empire. In Two Volumes.

THE ILLUSTRATED BOOK OF FRENCH SONGS. (In French and English.) Being a careful collection of the most popular Military, Patriotic, Satirical, Sporting, and Romantic effusions of the best French writers, from the Sixteenth to the Nineteenth Century. Illustrated with numerous highly-finished and original Engravings. Translated and edited by JOHN OXENFORD, Esq.

THE SHILLING
ILLUSTRATED LONDON ALMANAC

FOR

1856.

Containing Twelve Splendid Engravings Emblematical of the Months; Twelve Beautiful Botanical Engravings, by W. S. COLEMAN, Esq.; and Notes of the Months, by JOHN TIMBS, Esq. The Astronomical Department by J. GLAISHER, Esq., F.R.S., of the Royal Observatory, Greenwich.

The whole of the back Almanacs are now Reprinted, and may be obtained by order of the local Booksellers, price ONE SHILLING EACH, or the Set from 1845 to 1852 inclusive, in One Handsome Volume, cloth, price SIX SHILLINGS.

OFFICE, 198 STRAND.

W. J. SALMON,

100 FENCHURCH STREET,

AND SOUTH-WEST GALLERY, CRYSTAL PALACE, SYDENHAM.

W. J. S. would call the attention of his Friends and the Public to his new and much improved Microscopes, adapted for all purposes, and suited to all classes—the Drawing-room, Cottage, and School-room, and for Medical and other Students.

A superior Microscope, with Rack, Stage, coarse and fine Adjustment, two Achromatics ($\frac{1}{2}$ and 1 inch), two Eye-pieces, packed in Mahogany case, 1*l.* 13*s.*

Salmon's best Student's Microscope, with two Achromatics, coarse and fine Adjustment, in case, 6*l.* 10*s.*

Salmon's small Student's or School Microscope, with two Eye-pieces, and two Achromatics, in case, 4*l.* 12*s.*

Mr. Warington's Travelling Microscope, 2*l.* 10*s.*

A large assortment of Telescopes, Spectacles, Opera, Race, Field, and Marine Glasses of the best make, Barometers, Thermometers, &c.

AQUARIUMS,

MANUFACTURED BY

WILLIAM THOMAS SALTMARSH,

Carpenter,

4 SALISBURY COURT, FLEET STREET.

Area.	Depth.	£	s.	d.
14 inches by 10 inches . . .	12 inches . . .	0	19	0
18 " 12 " . . .	14 " . . .	1	5	0
22 " 14 " . . .	16 " . . .	1	12	0
26 " 16 " . . .	18 " . . .	1	16	0

N.B. *Larger Sizes at proportionate Prices.*

Warranted thoroughly Waterproof.

DISSOLVING VIEWS.

AMUSEMENT and INSTRUCTION by means of

CARPENTER and WESTLEY'S

Improved Phantasmagoria Lanterns with the Chromatope and Dissolving Views,
and every possible variety of Sliders, including
Natural History, Comic, Lever, Movable, and Plain,
Astronomical, Views in the Holy Land, Scriptural Portraits, &c.

No. 1. Lantern, with Argand Lamp, in a box, 2*l.* 12*s.* 6*d.*

No. 2. ditto, of a larger size, 4*l.* 14*s.* 6*d.*

A pair of **Dissolving-View Lanterns**, No. 2, with Apparatus, 11*l.* 11*s.*

The above are supplied with a Lucernal Microscope and 7 Sliders at 31*s.* 6*d.* extra.

The Lamp for the No. 2 Lanterns is very superior.

(The price of the Lanterns, is without Sliders.)

Lists of the Sliders and prices upon application to the Manufacturers,

MESSRS. CARPENTER AND WESTLEY, OPTICIANS,

24 REGENT STREET, WATERLOO PLACE, LONDON.

W. ALFORD LLOYD,

164 ST. JOHN STREET ROAD, LONDON.

Dealer in **Marine Living Animals, Sea-Weed, Artificial Sea-Water,**
and Marine and Fresh-water Aquaria.

A stock of small Aquaria, ready fitted up with Weed, Shells, Rockwork, and Marine Life, always on hand, at very moderate prices.

Valisneria, Chara, Nitella, Anacharis, and other living fresh-water Plants, Insects, Mollusks, Fish, &c.

SOCIETY OF ARTS PRIZE MICROSCOPES.

R. FIELD & SON, NEW STREET, BIRMINGHAM, have had awarded to them both of the Special Prizes of the Society of Arts for the best Students' and School Microscopes.

Student's Achromatic Microscope, with two Eye-pieces and two Objectives, in Mahogany Cabinet, 3*l.* 3*s.*

Ditto, superior and more complete, 4*l.* 10*s.*

Ditto, 6*l.* 6*s.* and 12*l.*

Movable Stages, from 1*l.* 15*s.* to 4*l.* extra.

School Microscope, Rack Adjustment, three Powers, and Instruments, 10*s.* 6*d.*

Superior ditto, upwards to 50*s.*

MICROSCOPIC OBJECTS FOR SALE.

MR. SAMUEL STEVENS,

NATURAL HISTORY AGENT, &c.,

24 BLOOMSBURY STREET, LONDON.

HAS on sale the following objects, neatly mounted, for microscopic examination. The price is 10s. 6d. per dozen, packed in racked boxes containing one or two dozen. It is sufficient if gentlemen favouring him with their orders indicate the number prefixed to each specimen.

(b.) Mounted in balsam.	(f.) in fluid.	(d.) dry.
1. Trans. Sect. of Cherry Stone (f.)	48. Femur of <i>Polioccephalus Edwardsii</i> (b.)	99. Mylobates Jaw (Trans. sect.) (t.)
2. Palate of <i>Lymnæus Stagnalis</i> (f.)	49. Sponge Spicules, Thames (d.)	100. Whalebone (Trans. sect.) (b.)
3. Cells contg. Starch from Peony (f.)	50. Hair of Bat, <i>Cynopterus Breviceaudatus</i> (b.)	101. Cuticle of <i>Oncidium</i> (f.)
4. Scales of <i>Ouraapteryx Machaonaria</i> (d.)	51. Thecae and Sporules of <i>Pteris Crenata</i> (b.)	102. Rib of <i>Porpessa</i> (Tr. sect.) (b.)
5. Parietal of Foetus, 3 months (b.)	52. Scales of <i>Nodura Nigra</i> (d.)	103. Trifid Spicules of Sponge (b.)
6. Cocoa-nut Shell (Trans. sect.) (b.)	53. Humming Bird Feather (d.)	104. Battledore Scales, <i>Polyommatus Arion</i> (d.)
7. <i>Coconeis Scutellum</i> (b.)	54. Cuticle of Indian Corn (f.)	105. Testa of <i>Illicium anisatum</i> (b.)
8. Palate of Whelk (f.)	55. Infusorial Earth, Italy (b.)	106. Spicules of <i>Gorgonia miniata</i> (b.)
9. Infusorial Earth from Obero in Germany (b.)	56. Femur of Eagle (Tr. sect.) (b.)	107. Hair of <i>Taphozous metanopogeu</i> (b.)
10. Trans. Sect. of Lebanon Cedar (b.)	57. Hair of Bat, <i>Taphozous Phillippensis</i> (b.)	108. Scales <i>Lepisma Saccharina</i> (d.)
11. Tusk of <i>Sus Indicus</i> (b.)	58. Spicules of <i>Gorgonia tricolor</i> (b.)	109. Fibro cellular tissue, <i>Cobæa Scandeus</i> (f.)
12. Foot of the Hive Bee (b.)	59. Infusorial Earth, Barbadoes (b.)	110. Palate, <i>Helix caperata</i> (f.)
13. Cuticle of <i>Yucca Gloriosa</i> (f.)	60. Scales of <i>Vanessa Erythya</i> (d.)	111. Cuticle, <i>Saccolabium guttatum</i> (f.)
14. Infusorial Earth from West Point, New York (b.)	61. Polishing Slate <i>Bilin</i> (b.)	112. Parallel spined Sponge Spicules (b.)
15. Hair of Bat, <i>Taphozous perforatus</i> (b.)	62. Bird Cherry (Trans. sect.) (b.)	113. Starch of Sago (f.)
16. Humerus of <i>Opossum</i> (Tr. s.) (b.)	63. Infusorial Earth, Mull (b.)	114. Claws of <i>Astrophyton Linckii</i> (b.)
17. Starch from Arrowroot (f.)	64. <i>Coquilla Nut</i> (Trans. sect.) (f.)	115. Starch, Sweet Casava (f.)
18. <i>Xanthidia</i> in Flint (b.)	65. Ulna of Australian Cat (b.)	116. Scale of <i>Lepidosteos</i> (Tr. sec.) (b.)
19. Mouse Hair (b.)	66. Infusorial Earth, Algiers (b.)	117. Porcupine Quill (Tr. sect.) (b.)
20. Ditto, Albino variety (b.)	67. Wing of <i>Morpho Menelaus</i> (b.)	118. Anchor-shaped Sponge Spic. (b.)
21. Pollen of Hollyhock (f.)	68. Spine of <i>Echinus</i> (b.)	119. Bone of <i>Antelope</i> (Tr. sec.) (b.)
22. Infu. Earth, Wreatham, Mass. (b.)	69. Infu. Earth, Virginia, U. S. (b.)	120. Yew (Tr. sec.) (b.)
23. Palate of <i>Lymnæus Palustris</i> (f.)	70. Palate of <i>Helix Aspersa</i> (f.)	121. Infu. Earth, <i>Slico Moc. Hill</i> (b.)
24. Infu. Earth, Manchester, U.S. (b.)	71. Infu. Earth, Bangor, U. S. (b.)	122. Cuticle, <i>Agave Americana</i> (f.)
25. Hair of Albino Rat (b.)	72. Elytron Diamond Beetle (d.)	123. Spicules, <i>Muricæ elongata</i> (b.)
26. Spiral Vessels from Testa of <i>Colomnna</i> (f.)	73. Foot of Wasp (b.)	124. Carapace of Turtle (b.)
27. Femur of Emu (b.)	74. Scales of <i>Cyphus Germari</i> (b.)	125. Palate of <i>Helix Hortensis</i> (f.)
28. Infusorial Earth, Rappannahannah Cliff, U.S. (b.)	75. Bone of Alligator (b.)	126. Palate of <i>Helix Nemoralis</i> (f.)
29. Sporules of <i>Anemodectyon Fraxinifolium</i> (b.)	76. Scales of <i>Morpho Menelaus</i> (d.)	127. Spicules of <i>Gorgonia plicata</i> (b.)
30. Starch from Rice (f.)	77. Sponge Spicules from Sark (b.)	128. Portland Meal, <i>Arum Maculatum</i> (f.)
31. Scales of <i>Podura Plumbea</i> (d.)	78. Metacarpal Bone, Man (b.)	129. Femur of <i>Tetrao Urogallus</i> (b.)
32. Palate of <i>Planorbis Corneus</i> (f.)	79. Pin-shaped Spicules of Sponge (b.)	130. Raphides, <i>Agave Americana</i> (b.)
33. Tooth of Sawfish (Tr. sect.) (b.)	80. Bone of Turtle (Trans. sect.) (b.)	131. Palate of <i>Helix Rufescens</i> (f.)
34. Ducts and Spiral Vessels from Carrot (f.)	81. Ivory (Trans. sect.) (b.)	132. Gemmules of Sponge (b.)
35. I. Earth, Schockhoe Hill, U.S. (b.)	82. Vegetable Ivory (f.)	133. Cuticle of <i>Aloe Spicata</i> (f.)
36. Hair of Bat, <i>Dysopes Nasutus</i> (b.)	83. Palate of <i>Trochus Umbilicatus</i> (f.)	134. Fibres, Fos. <i>Coniferous Wood</i> (b.)
37. Starch of Maple (f.)	84. Pith of Elder (f.)	135. Spicules of <i>Gorgonia Gelata</i> (b.)
38. Trans. Sect. Elephant's Hair (b.)	85. Cuticle of Iris (f.)	136. Hair of <i>Ornithorynchus paradoxus</i> (b.)
39. Palate of Winkle (f.)	86. Palate of <i>Nassa Reticulata</i> (f.)	137. Spic. <i>Alcyonium digitatum</i> (b.)
40. Raphides of <i>Rhubarb</i> (b.)	87. Star-shaped Spicules, Sponge (b.)	138. Cuticle <i>Opuntia Vulgaris</i> (f.)
41. Infusorial Earth, <i>Piscataway</i> (b.)	88. Apricot Stone, &c., sect. (f.)	139. Truncated Sponge Spicules (b.)
42. Femur of <i>Dinornis Mantelli</i> (Trans. sect.) (b.)	89. Thecae and Sporules of <i>Blechnum occidentale</i> (b.)	140. Scales of <i>Polyommatus Acis</i> (d.)
43. Hair of Bat, <i>Megaderma Lyra</i> (b.)	90. Polishing Slate, <i>Habichtswald</i> (b.)	141. Fin Bone of <i>Lepidosteos</i> (Trans. sect.) (b.)
44. The Blight Wheat (b.)	91. Rhinoceros Horn (Trans. sect.)	142. Gemmules of <i>Pachymatisma</i> (b.)
45. Starch from Potato (f.)	92. Spicules of <i>Malatea ochracea</i> (b.)	143. Testa of <i>Bignonia</i> (f.)
46. Infusorial Earth, <i>Lunenberg</i> (b.)	93. Spicules of <i>Gorgonia Zingiber</i> (b.)	144. Spicules, <i>Gorgonia Guttata</i> (b.)
47. Elytron of <i>Cyphus Germari</i> (d.)	94. Monkey Femur (Trans. sect.) (b.)	
	95. Beech Wood (Trans. sect.) (b.)	
	96. Rib of Python (b.)	
	97. Spicules of <i>Gorgonia rugosa</i> (b.)	
	98. Gemmules of <i>Geodia</i> (b.)	

Mr. S. STEVENS has also on Sale—

A Collection of INFUSORIAL EARTHS, from twenty-four different localities	24 Spicules of <i>Gorgonia</i>	per Set, mounted	20s.
price per Set, mounted . 20s.	12 Hairs, various	" "	10s.
12 Palates of Mollusca " " . 10s.	12 Scales of <i>Lepidoptera</i>	" "	10s.
	24 Sections of Bones and Teeth	" "	20s.

