



CORNELL  
UNIVERSITY  
LIBRARY



BOUGHT WITH THE INCOME  
OF THE SAGE ENDOWMENT  
FUND GIVEN IN 1891 BY  
HENRY WILLIAMS SAGE

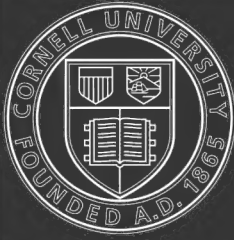
Cornell University Library  
QL 47.G17 1922

Zoology:



3 1924 024 761 045

o1n



# Cornell University Library

The original of this book is in  
the Cornell University Library.

There are no known copyright restrictions in  
the United States on the use of the text.

<http://www.archive.org/details/cu31924024761045>



ZOOLOGY



GALLOWAY



# ZOOLOGY

A TEXT-BOOK FOR  
UNIVERSITIES, COLLEGES  
AND NORMAL SCHOOLS

BY

THOMAS WALTON GALLOWAY, PH. D., LITT. D.

FORMERLY PROFESSOR OF ZOOLOGY, BELOIT COLLEGE, BELOIT, WISCONSIN; AND OF BIOLOGY IN THE  
JAMES MILLIKIN UNIVERSITY, DECATUR, ILLINOIS; ASSOCIATE DIRECTOR EDUCATIONAL  
ACTIVITIES, AMERICAN SOCIAL HYGIENE ASSOCIATION, NEW YORK

CO-REVISER

PAUL S. WELCH, PH. D.

ASSOCIATE PROFESSOR OF ZOOLOGY, UNIVERSITY OF MICHIGAN, ANN ARBOR, MICHIGAN

FOURTH EDITION, REVISED  
WITH 255 ILLUSTRATIONS

PHILADELPHIA  
P. BLAKISTON'S SON & CO.  
1012 WALNUT STREET

COPYRIGHT, 1922, BY P. BLAKISTON'S SON & Co.

PRINTED IN U. S. A.  
BY THE MAPLE PRESS YORK PA

## PREFACE TO THE FOURTH EDITION

---

The present revision is made in the interest of accuracy of details and to record and interpret such progress in the *Science* as bears most directly upon the instruction of beginners. In attempting these ends the author is greatly indebted to the painstaking work of the co-reviser, Professor Paul S. Welch, who is entirely innocent of any responsibility for the general plan of the book, which is unchanged from former editions.

T. W. GALLOWAY.

NEW YORK CITY.



## PREFACE TO THE THIRD EDITION

---

The last thirty years have been very productive of text-books of Zoology, both for secondary schools and for colleges. Many of these are admirable from the point of view of the science itself. It has become increasingly apparent, however, that the right text-book of Zoology, as of every other subject, is primarily a matter of psychology. The prime object of all teaching is so to use the subject as to produce the best possible result in the personality of the pupil. This means that the mental structure and functioning of the pupils are even more important than the subject matter in conditioning the presentation of any subject. Teachableness is the first prerequisite in any text-book in any subject whatsoever. During the last ten years the writers of our text-books have shown an increasing appreciation of this. Nevertheless it is still true that some of the best zoologies we have from the point of view of the science of Zoology are pedagogically impracticable.

It is the purpose of the present book, however much it may fall short of its aim, to subordinate certain zoological prepossessions to the mental requirements of freshmen. The method here adopted has been used successfully by the writer in a first course, for more than twenty years. It has secured good interest and fine spirit. The following are some of the principles that have guided him in the selection and arrangement of the material in the present volume:

1. The work done in a first course is primarily for pupils who do not take a second course. This first course should be handled, therefore, as a life-training rather than as satisfying a college requirement. It should seek to accomplish these, among other, things:

The production and conservation of a vital interest in animals; an appreciation of the human values of animals; the encouragement of the attitude of raising and solving problems concerning animals; some ability to use the library, the field, and the laboratory in individual pursuit of these interests; the ability to sustain interest in these

problems through considerable periods; a sense of the way in which organisms respond to the environing conditions; an elementary conception of development and of the evolutionary series of animals; some experience in classification of organisms—theoretical and practical; a conception of the place of man in the biological series, along with the conviction that this does not invalidate, but rather heightens, the meaning of all the higher human qualities.

2. The first thing to be sought therefore is a thorough-going appreciation on the part of the student of the attractiveness, the scope, and importance of animals and their activities.

3. A first course should really be a *foundation* course, and as such should give the student a broad and catholic view of the whole subject. It should utilize all the main departments of Zoology, because each department contains matter which should be familiar to all persons of ordinary education. Furthermore, the departments of morphology, physiology, ecology, distribution, and classification furnish exercises which have *distinct*, and yet *complementary*, pedagogical value. Any single phase of the subject, however important or interesting, gives a false and therefore an unscientific view of the wonderful science of Zoology, unless it is supplemented by the others. Therefore a book, if it is to serve the pedagogical needs of beginners, should contain fairly representative matter from all the main departments of the science; and it should at the same time provide both for the descriptive work and for the practical work in the field and laboratory.

4. Laboratory work and field work are essential, both to proper interest and to proper results, and should not be merely illustrative of text or lecture work, but as far as possible should be the foundation and point of departure of the lectures and the text. No instrumentality open to the teacher is better than the laboratory as a means of securing real interest and mental growth for the pupils. However, in order to attain this end it is essential that this work shall really be vitally done. It is not enough that a pupil be induced to observe and to record his observations. The pupil's mind should always be encouraged to "follow through" to whatever response in the way of conclusion or explanation seems sound in the light of his knowledge at the time. It is much more important that these



inner reactions be allowed, be complete, and be the student's own, than that they be rigorously right. It is easy enough to add new facts in order both to teach the pupil that conclusions are liable to be wrong, and to force his conclusion closer to that moving equilibrium which we call truth. This process is much more easy than to re-galvanize the soul whose interest and ability to reach conclusions have been aborted by a continual denial of the right. Much of the failure in our laboratory work is due to this "taxation without representation" in respect to personality.

5. On the other hand it is equally important that the work shall not be confined to the field and the laboratory. "There are many things in the infinite concourse of particulars which we cannot afford to verify by experiment." The chief end of laboratory work is gained for the elementary student when he comes to appreciate the method and spirit by which sound investigation proceeds, has acquired enough technical skill to follow elementary investigation on his own behalf, and has learned how to appreciate, and if necessary to verify, the statements of others. It is as easy to waste time in the laboratory as in reading textbooks.

6. The time in an elementary course should be about equally apportioned (1) to laboratory work (chiefly in physiology and in the larger problems of morphology rather than in minute dissection); (2) to field observation on physiology, life histories, and the simpler problems of distribution, classification, and life relations; (3) to the body of the descriptive text; and (4) to classes of questions demanding reference to classical zoological authorities.

It is a great mistake not to impress upon the student the immense amount of work already done and to heighten his respect for the library as one of his sources of information and interest.

7. The matter of greater native interest should underlie and sustain that of less. It should not, however, exclude or efface the latter. The most interesting is often the least important.

8. Certain of the general facts and principles which the beginner cannot be expected to discover for himself should be

presented early, in order to give the student a skeleton—or dimensions, so to speak—in which he shall later insert the particulars which he discovers. He must have this in order to unify his own results in the brief time at his disposal. The lack of this unifying result is the ground of the just complaint concerning much of the unorganized and unrelated laboratory instruction in the secondary schools and early college classes.

9. While it is necessary to bring our materials from various departments of Zoology and is desirable that the student should be able to recognize whether a given problem is primarily one of structure or function or relation, the total result of an elementary course of Zoology should be a sense of unity, of continuity, and of interdependence. The final view of the student should be of *life* and *organic progress*, and not of a disjointed science, dissected in the house of its friends.

10. The teacher should have some latitude in the choice of matter and emphasis, in order that both may be properly suited to his equipment and locality. It should be impossible for the teacher or the class to use a text-book in a slavish, or parasitic fashion. Therefore a text-book should contain and suggest much more than one teacher or one class can use in the time allowed. This not only gives the teacher a chance (and makes it necessary for him) to mould his own course, but causes the student to realize that he is a mere beginner when he has completed his first course.

In attempting to apply these principles to the present book the author has made use of the following devices:

1. The book is divided into three portions:—(1) a *general part* dealing largely with broad biological problems and principles, which constitute the foundations of the science and are felt to be for the most part, beyond even the verification of the elementary student (Chapters I–VIII); (2) a *special part* (Chapters IX–XXV), in which the various principal phyla of animals are taken up in succession, beginning with the lowest. The purpose has been to make *this part particularly illustrative of the principles laid down in the general portion*; and (3) a *group of synthetic chapters* (XXVI–XXIX) to induce the student to gather up certain of the more important details of his course by a new reorganization of the materials.

2. Each chapter of the general part contains the following elements:—(1) the general statement of principles or facts; (2) interspersed with this are such practical exercises for laboratory, field, or library, as have been found practicable for elementary classes. These are intended to compensate for the enforced brevity and abstractness of definitions and description, by causing the student to find concrete illustration of the principles; (3) an analytic summary of the most important general truths of the chapter in outline, at the close of the chapter; and finally (4), a list of supplementary topics for individual laboratory or library investigation and report. These topics supplement and illustrate the text, and enrich the review by introducing a new viewpoint and new matter. It is not intended that all of these topics shall be demanded of the whole class. The writer has got best results in interest and knowledge by allowing each member of the class to select some topic in which he is interested and to make a brief report of his investigation before the whole group.

3. In the chapters of the special part each phylum is introduced by field and laboratory work on some representatives taken as types. This is purposely made brief and suggestive in order that the teacher and class may build up their own detailed program. This is followed, corrected, and enlarged by a brief discussion of the typical condition of the organs and functions in the group as a whole. This serves to unify the isolated and local observations of the student. Next follows a brief statement of the most important facts of classification, together with ecological and economic suggestions. Finally, each chapter concludes with a list of supplementary questions calling for field, laboratory, and library work in review, and as a brief view of new material.

4. The figures are carefully selected,—the majority of them being specially made for this book. With each figure of special moment is a brief list of queries designed to assist the student in the study of the figure. It is a common complaint among teachers that it is difficult to get students to appreciate and to use illustrations intelligently, and to relate them to the text. A sane emphasis on these questions will solve this problem.

5. The concluding chapter consists of practical questions and special exercises which necessitate a review by the student of all that is essential in the book, from a new point of view. It is intended to do for the whole book what the suggestive topics at the end of each chapter may do for the chapters.

6. The headings of paragraphs are printed in black-faced type, in order to emphasize the analysis of subject matter. Technical terms are in italics the first time they appear. The author does not agree that all technical language should be omitted from even an elementary course.

The author extends most cordial thanks to the many publishers and authors whose courtesy enables him to reproduce classic illustrations from their copyrighted works. Recognition is given to the sources in immediate connection with the figures. The thanks of the author are also due to many fellow teachers for suggestions and criticisms during the progress of the work, and since the appearance of the earlier editions.

T. W. GALLOWAY.

JAMES MILLIKIN UNIVERSITY.

# CONTENTS

---

## CHAPTER I

	PAGE
INTRODUCTION. . . . .	I

## CHAPTER II

PROTOPLASM: ITS MORPHOLOGY AND PHYSIOLOGY . . . . .	8
---	---

## CHAPTER III

THE ANIMAL CELL: ITS MORPHOLOGY AND PHYSIOLOGY . . . . .	19
--	----

## CHAPTER IV

FROM THE SIMPLE CELL TO THE COMPLEX ANIMAL . . . . .	29
--	----

## CHAPTER V

CELLULAR DIFFERENTIATION.—TISSUES . . . . .	48
---	----

## CHAPTER VI

THE GENERAL ANIMAL FUNCTIONS AND THEIR APPROPRIATE ORGANS . . . . .	66
---	----

## CHAPTER VII

PROMORPHOLOGY . . . . .	92
-------------------------	----

## CHAPTER VIII

DIFFERENTIATION OF INDIVIDUALS AND ADAPTATION . . . . .	100
---	-----

## CHAPTER IX

A GENERAL REVIEW OF THE ANIMAL KINGDOM . . . . .	144
--	-----

## CHAPTER X

PHYLUM—PROTOZOA . . . . .	150
---------------------------	-----

## CHAPTER XI

PHYLUM—PORIFERA (Sponges) . . . . .	165
-------------------------------------	-----

## CHAPTER XII

	PAGE
PHYLUM—CŒLENTERATA (Hydroids, Corals, Jelly-fishes, Etc.). . . . .	174

## CHAPTER XIII

UNSEGMENTED WORMS at least four Phyla, including Flat-worms, Thread-worms, Rotifers, Polyzoa, Etc.) . . . . .	191
---	-----

## CHAPTER XIV

PHYLUM—ECHINODERMATA (Starfish, Sea-urchins, Sand-dollars, Sea-lilies). . . . .	208
---	-----

## CHAPTER XV

PHYLUM—ANNELIDA (Segmented Worms) . . . . .	223
---	-----

## CHAPTER XVI

PHYLUM—MOLLUSCA . . . . .	240
---------------------------	-----

## CHAPTER XVII

PHYLUM—ARTHROPODA . . . . .	266
-----------------------------	-----

## CHAPTER XVIII

PHYLUM—CHORDATA . . . . .	312
---------------------------	-----

## CHAPTER XIX

CHORDATA (CONT.): SUB-PHYLUM VERTEBRATA (Fishes, Amphibians, Reptiles, Birds, and Mammals) . . . . .	316
--	-----

## CHAPTER XX

CLASS—PISCES (Fishes) . . . . .	359
---------------------------------	-----

## CHAPTER XXI

CLASS—AMPHIBIA (Frogs, Toads, Salamanders). . . . .	376
---	-----

## CHAPTER XXII

CLASS—REPTILIA (Lizards, Crocodiles, Tortoises, Snakes) . . . . .	385
---	-----

## CHAPTER XXIII

CLASS—AVES (Birds) . . . . .	399
------------------------------	-----

## CHAPTER XXIV

CONTENTS

XV

CHAPTER XXV

	PAGE
CLASS—MAMMALIA (CONT.): Man. . . . .	466

CHAPTER XXVI

THE DOCTRINE OF EVOLUTION AND RELATED IDEAS . . . . .	482
---	-----

CHAPTER XXVII

ECONOMIC ZOOLOGY . . . . .	508
----------------------------	-----

CHAPTER XXVIII

DEVELOPMENT OF ZOOLOGY . . . . .	518
----------------------------------	-----

CHAPTER XXIX

EXERCISES IN COMPARATIVE PHYSIOLOGY, MORPHOLOGY, AND ECOLOGY . . .	530
--	-----

APPENDIX

LABORATORY SUGGESTIONS . . . . .	533
----------------------------------	-----

INDEX . . . . .	545
-----------------	-----





# A TEXT-BOOK OF ZOOLOGY

---

## CHAPTER I

### INTRODUCTION

1. Nature presents to man, as he looks upon it, a great and interesting variety of material objects. Each member of the race gathers in his lifetime, by means of experience and inference, a certain limited knowledge of these objects and of the changes which they undergo. The knowledge, thus collected and systematized in the course of the history of the human race, constitutes the so-called *Natural Sciences*. Every one of us, whether he deliberately chooses or not, must be in some degree a natural scientist. The beauty and interest of the work has attracted and charmed thousands of people of all conditions, in all parts of the world.

We commonly speak of material objects as either living or non-living—as organic and inorganic. The study of living things in all their relations we call *Biology*. Physics and Chemistry are often considered as dealing exclusively with inorganic matter, and are therefore placed in contrast with Biology. Their principles apply, however, in the realm of living things just as truly as in the non-living, and one must not imagine because of this antithesis that the phenomena of life can be explained apart from chemical and physical laws. The term Biology was first introduced about the beginning of the nineteenth century, and is intended to express the fact that plants and animals are similar in their most essential structure and activities. The term *Natural History* is sometimes used synonymous with Biology.

2. **Zoology.**—Owing to the fundamental likeness of all living matter, there is great theoretical difficulty in distinguishing between the plant and animal kingdoms. The practical

difficulty however is confined to the very lowest and simplest forms of life. The plants and animals which come under the common observation of the student are readily distinguished. It is only the deeper study which reveals the underlying similarity of all living objects. The branch of Biology which treats of plants is called *Botany*; that which deals with animals, *Zoology*.

3. **The Value of the Study of Zoology.**—The student, on taking up a new subject has a perfect right to ask whether that subject is worth while. A subject may have a great deal of value in practical ways and not mean much in education; or it may have high value in educating human beings and have very little of practical worth. Zoology is strong in both particulars. Animals constitute one of the most interesting and important features in the surroundings of man. They arouse our interest, they appeal to our sense of beauty, they furnish us with food and clothing, they attack our crops, they produce diseases in us and in those animals we most use. In the second place, Zoology adds to our knowledge of the structure and activities of man himself since we are enabled through it to study ourselves in proper relation to the other animals. We may gain much light on the means of preserving human health and making right adjustments by the study of animals. Finally, the very method by which we study zoology is of the greatest value in our mental growth. The scientific method demands that we observe at first hand as many facts as possible; that we compare and contrast these facts with one another and with those which other people have observed; that we discriminate between important and unimportant facts; that we learn to draw right conclusions from our facts; and that we always hold our minds open for new facts even after we have reached our conclusions. It is worth while to get these ideals and form these habits.

To the investigator, the ultimate object of zoological study is to find the real nature of animal life as it exists, the mode of its development, and the causes which have brought it to its present exquisite variety and adjustment. These larger and

more general questions constitute what may be called *theoretical Zoology*, or the *principles of Zoology*.

4. **Practical Exercises.**—The student may select ten or more kinds of animals with which he is partially acquainted, and, from his observation and experience, enumerate the points at which they touch human welfare. Are they, in each instance, to be classed as helpful? as harmful? or merely as apparently indifferent? Is their influence upon man's interest direct or indirect?

What animals have, in the past, most appealed to your interest? Select that particular quality in which you have been most interested (structure, beauty, powers, instincts, habits) and show how the attempt to study or explain any one takes you at once into all the others.

5. **Divisions of the Science.**—The facts and principles which have been, and are yet to be, discovered concerning animals are so numerous and various in their bearings, and investigators approach the subject from such different points of view that it is necessary, in order to express these results, to divide zoology into several branches or departments. It must be held in mind, however, that these divisions are more or less artificial, and that the facts of each department are to be considered in connection with those of all the others, if they are really to be understood. With all its departments, animal life is to be thought of as a whole. Structures exist for the performance of function, and the activities are valuable as they adjust the animal to its whole life-relation.

6. **Morphology** is the branch of the science which deals with form or structure in its broadest sense, whether internal or external, partial or total. In its most general meaning it embraces the study of animals from the standpoint of *symmetry*,—that is, the form of the organism with reference to certain planes passing through the body. For example, the human body may be so divided by a single plane that two essentially similar parts result,—the right and the left. Again similar parts may succeed each other in a linear series, as in the segments of the earth-worm; or they may radiate from a central point, as in the arms of the star-fish. This is the most fundamental kind of morphology. It relates the organism to position and motion in space. It is called *Promorphology*, and is related to Zoology somewhat as the study of crystals is to Mineralogy.

*Anatomy* is that department of morphology which treats

of the structure of parts of the individual,—as the organs and systems of organs, the tissues, the cells. This is known as *gross anatomy* if the study pertains to the larger units,—as organs; it is called *Histology*, if the constituent elements of these organs, as tissues and cells, are to be considered.

Thus far we have thought of structure as stationary or permanent. As a matter of fact we know that each organism begins life in a very modest way, as a single "cell," and grows more complex by fairly well-defined stages until the adult condition is reached. This is development. The science of *Embryology* is the record of this history of the successive stages which the individual animal assumes in becoming adult, or at least until its organs are essentially formed.

7. **In Physiology** are considered the facts and laws relating to the activities or functions of the organism and of its separate parts. It includes the tracing back of the adult activities to their lowest form, as found in the simplest animals or the youngest stages of the higher animals. It includes the powers of the single cell; the chemical and physical processes which seem to underlie all the functional activities; the division and more perfect performance of the primitive functions as the various organs arise and come to do their special work. Finally it includes the relation of the animal as a whole to other animals of the same or of different species, to plants, and to the inanimate surroundings. The term *Ecology* is applied to this branch of physiology which treats of the relation of the organism to the complex and wonderful conditions in which it finds itself. Of recent years much emphasis is being given to this branch of zoology.

8. Animals may be studied as to their distribution or occurrence in the world. For example, we find lions in Africa and Asia only and the African and Asiatic lions are of different varieties; the giraffe is found only in Africa; man is found over the most of the habitable globe, but before the era of easy communication between distant countries the men of different regions were conspicuously different. Again we can easily see that the animals which live in the various bodies of water are

very different from those living on the land; those in the frigid zones are different from those in the temperate and torrid. All such topics are treated under the head of *Zoogeography*, or *geographical distribution*. This is distribution in *space*.

The hard parts of animals are found as fossils in many of the surface rocks of the earth. The various systems of rock-strata are characterized by more or less different fossil remains, indicating a variation in the animal life during the successive periods of the earth's history. This distribution of animals in *time* is the subject-matter of *Palæozoology*. The facts of palæozoology and the conclusions resting thereon are among the most important in the whole realm of Zoology, inasmuch as they supplement the facts gained from the study of embryology and morphology of living species, thus enabling the investigator to trace the history of the various races of animals into the remote past. In this way we also learn much of the history of the earth itself.

9. **Practical Exercises.**—The student may submit a written report on the distribution of the animals in his immediate neighborhood, based on his own observations. The report need not be exhaustive in order to convince the student of the effect of the environment, which includes everything in the surroundings, on the distribution of animals. Some classification should be made of the varieties of territory included;—as river, pond, lowland, woodland, prairie, mountain, and the like. Determine, by reference to the authorities available, the geographical distribution of the following: the elephant, the camel, the kangaroo, the horse, the white bear, the seal, the salmon, the crocodile, the reef-forming coral, the sponge of commerce. Select and find the distribution of five other species having a personal interest to you.

10. **Classification.**—In studying animals and plants one is soon impressed with the fact that among the thousands of individuals, even of the same general kind, there are no two exactly alike; and yet among them all, with their manifest differences, there are numerous points of similarity. These two facts make it possible to group those most alike into more or less coherent classes, separating them at the same time from other classes. The forming, naming, and defining of these groups and subgroups we call *Taxonomy* or *Classification*. Manifestly, true classification must depend upon the facts derived from the completest possible study of the structure and relations of organisms, and can only be perfect when we know

all that is to be known about them. In addition to displaying our present knowledge of the relationship of animals, classification serves a most important end in giving us more rapid power of using that knowledge in getting further knowledge that is needed.

11. **Historical.**—Zoology as a science can scarcely be said to be more than three hundred years old, although Aristotle, more than three hundred years before Christ, wrote much of value concerning animals. Later many facts of general anatomy were discovered in connection with the study of medicine, and about 1600 the invention of the microscope opened up the field of micro-organisms and of histology. Toward the end of the seventeenth century an effort was made to establish a scientific classification of animals. Since that time very much of the attention of students of zoology has been turned in this direction. During the last century however there has been a constantly increasing interest in the study of embryology, of histology, and in the general theoretical questions, the answers to which depend on the bringing together of the results of studies in all departments. Such are the problems of race development or evolution, of heredity, of man's place in nature, and the like. The most notable development of the subject in recent years has been in connection with the study of the finer structure of the cell, in more exact methods of studying physiology, in extending its scope to take in the lower organisms as well as the higher and the single cell as well as the organs, and in inheritance. It is important to add that all this work is now being done in a *comparative* way. The necessity of comparing the histology, the embryology, and the physiology of one animal with that of another arises from the belief in the unity of animal life, and that all animals are really akin. If animals of different kinds are really related, their likenesses and differences take on a new meaning to the student, and classification comes to express the degree of kinship, as well as to serve the convenience of the investigator.

12. **Summary.**

I. Natural Science embraces:

A. The sciences of inanimate things—  
 Astronomy,  
 Geography,  
 Meteorology, Mineralogy, Lithology, etc.

B. The sciences of animate things—  
 Botany,  
 Zoology.

(Physics and Chemistry are fundamental to both groups of sciences; Geology embraces portions of the subject-matter of both groups.)

## II. Subdivisions of Zoology.

### A. Morphology:

1. Promorphology, which treats of general form;
2. Anatomy; = the structure of parts;  
 Gross = structure of organs and systems of organs;  
 Microscopic = (Histology, Cytology); structure of tissues and cells;
3. History of Development (structural stages):  
 Individual = (Embryology, Ontogeny);  
 Racial = (Phylogeny).

### B. Physiology:

1. Physiology proper; = the functional relation of part to part and to the whole;
2. Ecology; = relations of the individual to its surroundings, whole or in part.

### C. Distribution:

1. In space = (Zoogeography);
2. In time = (Palæozoology, as revealed by fossils).

D. Classification, or the grouping of animals according to their likeness or kinship.

E. Economic zoology considers all the points at which animals touch human welfare.

[All of these subjects may be considered historically and comparatively.]

## CHAPTER II

### PROTOPLASM: ITS MORPHOLOGY AND PHYSIOLOGY

13. **Life.**—Life may be thought of in two somewhat distinct ways. It may be considered, first, merely as an expression for all the various activities of the organism,—the sum of all the phenomena of its existence; or, second, as a *force* or *form of energy* from which the special modes of activity, as feeding, growth, motion, and thinking, arise. The latter is the more common use of the term, and yet the former is the only use of it which can be completely justified. Much of the activity of living things may be explained by reference to the ordinary physical and chemical laws. What we mean by this is that all the so-called vital activities depend on such *physical* facts as cohesion and adhesion, on the laws of fluids and of solution of solids in fluids; and on such *chemical* facts as the building up and tearing down of chemical compounds composed of just the same elements that we find about us everywhere in the world. There are a great many biologists who think that there is nothing more in life than these physical and chemical processes and effects, and that we should be able to explain life and its activities if we knew all about the physics and chemistry of living matter. It is sure, however, that there are many vital phenomena which are not now to be explained by what we now know of chemistry. Possibly this will always be so.

14. **Living and Non-living Objects.**—Any one of us could, almost at a glance, tell whether an object is, or has been, alive; and yet it is not easy to describe just what it is that convinces us. There are two classes of differences between living things and things that have never been associated with life: differences (1) in make-up or *organization*, and (2) in *powers*.



Organization includes form, size, organs or parts, as well as minute structure and chemical composition. While no two organisms are of exactly the same form, there are certain features that are very common. Living bodies are usually bounded by curved surfaces. They tend to be elongated in one axis more than in others; they tend to repeat certain of their parts; and they incline to be symmetrical. They are limited in size,—although some are very small and some are very large. They are differentiated,—that is, they have organs, different kinds of structures at different parts of the body. As we shall see later they are made up of a substance called *protoplasm*, which is arranged in one or more *cells*.

Among the powers and activities of a living object may be mentioned (1) the power of changing food into its own substance, and thus of growth and repair; (2) the power of using this growth to separate off a portion and thus make a new individual like itself (reproduction); (3) the power to use some of the material of growth to develop energy of motion, heat, light, electricity, or thought, as the case may be; and (4) the ability by means of sensitiveness and the use of these various powers to adjust itself to very considerable changes in the environment. Every organism has all these qualities in some measure. No inorganic object has them.

**15. The Relation of Protoplasm to Life.**—Whatever life may be, in the last analysis, we never observe its manifestations except in connection with a substance called *protoplasm*, which is found both in plants and animals. Protoplasm does not contain any chemical elements which are not found in other than living materials. Notwithstanding this fact, protoplasm is different from any other known substance. It is more complex and more highly organized, as to its machinery, than any other chemical or physical compound whatsoever. Protoplasm has the power of growing by taking into itself and changing non-living substances; but, so far as we know, it is never produced except as the result of the growth and division of antecedent protoplasm. The protoplasmic or living material in an organism is normally composed of a number of unit-

masses called *cells* (see Chapter III). These unit-masses of protoplasm are in some degree independent of one another, because normally each tends to form a wall about itself; and yet it is highly probable that the whole protoplasm of an animal is physically continuous by means of delicate connections between the units. The life of the cells is not quite the same thing as the life of the organism to which they belong, for in animals composed of more than one cell a cell may die without involving the death of the animal. The protoplasm of the cell may also retain life for a time after separation from the living animal or after the animal as a whole has ceased to live. This is shown by the fact that cells may be taken from the body of young organisms and, if kept nourished under conditions similar those to of the body from which they are taken, will not merely live but will continue to grow and divide almost indefinitely. This has been shown to be true of several classes of cells.

16. **Protoplasm.**—While we describe protoplasm as the “physical basis of life” (Huxley), we no longer think of it as a constant or definite material with an exact composition. It is rather a complex mixture of substances, some of which are themselves very complex compounds. These substances in the mixture are continually bringing about changes in one another. It is inevitable that such a mixture of changeable substances should itself be most unstable and variable. It is agreed that there is much in common in all protoplasm,—even in protoplasm as far apart as that of plants and animals; and yet it is also true that the protoplasts of different animals and of different parts of the same animal are definitely different. This difference is shown by the difference in the work they can perform,—as in muscles and nerve cells. Indeed different species of animals and their organs and cells are different just because the protoplasts which form them are different.

Perhaps this is the most wonderful thing in life: that a substance, so complex and so variable that it is not exactly the same any two moments in succession, should still be so constant that a small amount of it split off generation after generation should transmit all the essential qualities of the species to which it belongs,—whether a paramecium or an oak or a man.

**17. Chemical Composition of Protoplasm.**—It is impossible to make a satisfactory chemical analysis of living protoplasm, as it loses its characteristic powers and probably undergoes important chemical and physical changes in the act of analysis. The dead material thus obtained is no longer the substance with which we started, either as to its power or its structure. The experiment shows, however, that the substance is both chemically and physically unstable. By an analysis of the dead protoplasm, we find present several complex organic compounds, known as *proteins*, *carbohydrates* (starches and sugars), *fats*, *enzymes*, *pigments*, etc. In addition to these are simpler inorganic compounds, as water and various salts. Doubtless some of these materials are food-substances on their way to form protoplasm, and others are the waste-products of protoplasmic disruption, ready to be cast out of the cell. The proteins are the most complex of all these substances and it is believed that protoplasm finds its real basis in them.

The proteins, which are about 40% of the dry protoplasm, are various in composition and properties, but agree in that their molecules contain carbon, hydrogen, oxygen, nitrogen, and sulphur, in proportion roughly as follows: C 53%, O 22%, N 17%, H 7%, S 1%. Carbon is thus the most abundant single constituent element. The white of egg, the fibrin of the blood, and casein in milk are examples of protein.

Carbohydrates (about 12% of the dry protoplasm) consist of C, H, and O. The latter elements are always present in the ratio in which they are represented in water ( $H_2O$ ), e.g.  $C_6H_{10}O_5$ . The starches, sugars, and cellulose (such as is found in cotton fibres) are illustrations.

The fats contain the same elements as starch, but the percentage of oxygen in terms of the hydrogen is much smaller than in the starches. These fats comprise some 12% of the dry protoplasm.

The enzymes are complex organic substances which have the power of producing important chemical changes in other substances without being themselves consumed. They play an important, but not thoroughly understood, rôle in the activities of the organisms, both within and outside the cells which produce them. The active principle of the digestive juices, as ptyalin and pepsin, are examples of ferments which have been extruded from the cells.

Water ( $H_2O$ ) is very important in both the chemical and physical structure of protoplasm. It is very variable in amount, and the degree of activity of the protoplasm is roughly proportional to the amount of water present. Something like 5-7% of the dry weight of protoplasm is made up of inorganic salts,—compounds of chlorine, potassium, sodium, calcium, phosphorus, iron, etc., found largely in solution in the water.

Most of these substances cannot be considered as "living." The water and inorganic salts and starch cannot be. The starches and fats and urea are organic but not living. If any particular substances are alive it would seem to be the *proteins*. It may be, however, that life is the result of the intimate relations and interactions of all these various non-living substances rather than a property of any one of them.

**18. The Physical Structure of Protoplasm.**—This varies much from time to time. On account of differences in the amount of water present, the consistency of protoplasm may vary from the quite fluid condition found in actively growing

parts, to the very much more solid condition apparent in dry seeds and in the resting or encysted stage of some animals. In these latter instances the protoplasm eliminates a large per cent. of its water, forms a thick wall, and thereby becomes enabled to resist drouth and heat and cold as it could not possibly do otherwise. Under ordinary circumstances protoplasm appears as a semi-fluid or gelatinous material.

Concerning the architecture of protoplasm there is much diversity of opinion. It seems probable that this, like the chemical composition, is subject to considerable variation. It is certainly very complicated and represents several physically distinct substances mingled in a very effectual and wonderful way. Protoplasm is a *colloid*. This means that the supporting fluid carries in *suspension* various large molecules or molecular groups. It is not therefore a true *solution*, and does not pass readily by osmosis as solutions do. In some cases at least it takes take on the appearance of a foam structure such as is obtained in an emulsion of oil in water, or of air and water in a soapy lather. Whatever its form may be, it seems that there must be a close relation between the architecture and the great activity which protoplasm shows. It is physically as well as chemically unstable.

**19. Physiology of Protoplasm.**—The mass of protoplasm which we have called a cell, or unit, is able to perform practically all the functions shown by the more complex organism. It has the power of feeding, of growth, of reproduction, of motion in response to stimuli, and of waste and repair. Even in the higher animals, made up of many of these units, the processes are performed, on last analysis, by the individual protoplasmic units of which the body is composed.

**20. Irritability.**—Owing to its chemical and physical instability, living protoplasm is constantly changing. These changes may be the direct result of internal or external conditions to whose influence the protoplasm may respond by a manifestation of energy greater than that involved in the stimulus. This quality is called *irritability*. It further seems that changes may originate within the protoplasm itself,

though this is much more difficult to demonstrate and may merely represent our ignorance of the processes occurring in the protoplasm. This power is called *automatism*. These two are the most fundamental qualities belonging to protoplasm, and serve to make possible those which follow: viz., motion, assimilation, growth, etc. Protoplasm varies in the degree of irritability. In general it responds to stimuli most normally under those conditions which are most favorable to the ordinary vital processes.

**21. Stimuli.**—All the disturbing forces or conditions, external or internal, which tend to cause response in living protoplasm, are called *stimuli*. The principal stimuli are,—chemically active substances, moisture, contacts, heat, light, electricity, and gravity. Inasmuch as irritability lies at the foundation of the various protoplasmic activities mentioned below, all the natural causes which modify irritability, also modify, through it, the vital processes, such as motion, growth, etc.

Light affects protoplasm profoundly. The direction of motion in protoplasm is largely determined by light. Light may either attract or repel protoplasm. Excess of light retards growth. Heat strongly modifies the rate of all the vital processes. There is an *optimum* temperature at which the protoplasm best performs its work. An excessive increase or decrease of this temperature causes a cessation of activity, a condition of rigor, and death. The fatal *maximum* temperature for ordinary animal protoplasm may be said to be about 45° or 50° C.; the *minimum*, 0°, or below. Chemical agents may stimulate protoplasm in such a way as to attract or repel organisms. *Paramecia*, which are single-celled animals, may be seen to gather about an air-bubble, or at the margin of the cover-glass. They will retreat before an encroaching solution of certain salts.

It is a most significant fact in this connection that protoplasm may become, so to speak, *accustomed* to a stimulus which has been long continued, so that it ceases to respond in the way it did when the stimulus was novel. Protoplasm may *gradually* be brought, for example, to endure and thrive at a temperature which would have produced death if suddenly applied. It is almost impossible to overstate the importance of this faculty in enabling organisms to survive changing conditions. Stimuli, then, may be said to be powerful in proportion to their suddenness and intensity.

**22. Assimilation.**—The process of changing food substances into protoplasm is called *assimilation*. It can be effected only by protoplasm. Such foods may be relatively simple substances or may be the complex protoplasm of other organisms. The protoplasm of the green leaves of plants has

the power of utilizing the simple inorganic compounds, as oxygen, water, and carbon dioxide, in a larger measure than that of animals. Plants may build these up into foods, whereas animals must have the complex organised foods to start with.

23. **Growth and Reproduction.**—The result of assimilation is the addition of new molecules of complex organic

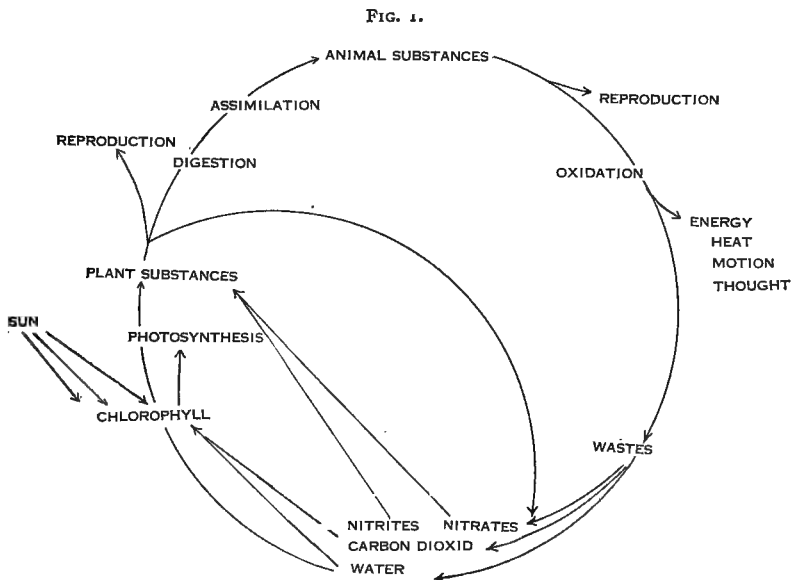


FIG. 1. A diagram indicating the general cycle of events in the building up of inorganic substances into living matter. Sunlight enables the chlorophyll of plants to build up water and carbon-dioxide (*photosynthesis*) into carbohydrates. Plants may use these together with nitrogenous compounds to form plant protoplasm and other proteins. Animals may by assimilation utilize these for growth, reproduction, and in doing work of various kinds. Work results in waste. Plants may again use these wastes.

**Questions on the figure.**—What are the three main courses open to plant substances? In what sense are animals dependent on plants? For what? How important is photosynthesis in life? What is the real source of the energy of organisms? In what sense is the term cycle appropriate here?

matter among the molecules of the old. This produces *growth*. It is to be defined as increase in mass. If this continues indefinitely in excess of whatever may tend to destroy the protoplasm, the increase in size may lead to the division of the protoplasm. The parts may separate and lead an independent existence. Such is *reproduction*. In its simplest form it is

merely growth beyond the limits of the individual. The cell cannot continue to grow indefinitely. Its size is limited by the necessity of physical support on the part of the soft protoplasm, and by the relation between the outer surface, through which the food must be taken, and the volume, which represents the mass to be fed. As a cell grows its surface increases as the square of the diameter, whereas the volume increases as the cube of the diameter. It is apparent that the nourishing surface does not increase as rapidly as the mass to be nourished, and in consequence the time will come when the nourishment possible to be absorbed will *just* nourish the volume, and growth must cease. This condition is in some way related to the immediate causes of division. At any rate division furnishes a way out of the dilemma and allows a renewal of growth of the daughter units.

FIG. 2.

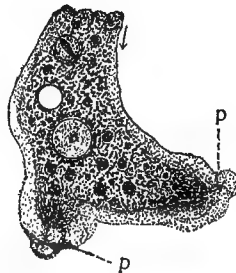


FIG. 2. Streaming of Protoplasm in the Amœba. The forward motion of the granules takes place more rapidly in the centre of the pseudopodium (p). Those at the margin fall behind those in the centre as the pseudopodium advances.

**Questions on the figure.**—Why may the amœba readily change its form? Do its internal parts preserve a constant relation to each other?

24. **Contractility.**—A body of living protoplasm seems always to possess the ability to change its form in greater or less degree. This results in motion of parts or of the whole, and is called *contractility*. Movement or contractility is closely related to irritability, and results from the action of stimuli, external and internal, upon the complex protoplasm. It is made possible by the assimilation of food substances. These, in being broken down, furnish the energy shown in motion. The nature of the motion resulting from contraction differs somewhat, depending upon whether the protoplasm is en-

veloped by a cell-wall or is naked. If without a wall, it may send out foot-like projections into which there passes a stream of granules, as in the *Amæba* (see Fig. 2); if enclosed, the protoplasmic mass may *rotate* within the cell wall, or there may be narrow channels in which the currents move between banks of more stationary material. The latter motion is described as *circulation*. (Fig. 3.)

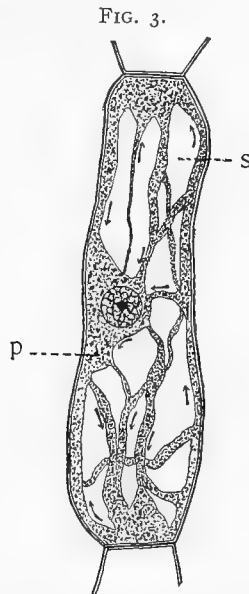


FIG. 3. The circulation of protoplasm (*p*) in a cell of a stamen-hair of *Tradescantia*. In the channels the granules move back and forth to the various parts of the cell. The remainder of the cell is filled with cell-sap (*s*) which in these cells is colored.

**Questions on the figure.**—In what respects are the activities of the protoplasm necessarily limited in this cell as compared with the condition in *Amœba*? Why is circulation an appropriate term?

25. **Demonstrations.**—It is very desirable that the student actually see protoplasmic motion with a compound microscope of good magnification. The *Amœba* will serve to illustrate the naked streaming motion; *Paramecium*, rotation; the hairs from the stamens of *Tradescantia* beautifully illustrate circulation. (There is a cultivated species which may be kept blooming in greenhouses at all seasons of the year.) Ciliary motion may be shown in several of the large Infusoria, as *Stentor*, *Paramecium*, or *Vorticella*, or by living cells on the gills of clams and mussels.

26. **Dissimilation.**—Motion and the other responses which protoplasm makes to stimuli necessarily represent chemical or



physical changes, or both, in the protoplasm. It is well known that complex chemical substances, such as are found in protoplasm, can be made to yield energy when they are torn down into simpler ones by some element which has an affinity for some of the elements constituting the substance. The result of this action is, always, simpler and more stable compounds than the original, and therefore of less use in the further freeing of energy. This tearing-down process is the opposite of assimilation and is sometimes called *dissimilation* or *katabolism*. Oxygen is one of the most important agents in nature for the freeing of energy by breaking down the complex chemical substances. It unites with the carbon and hydrogen particularly, and these unions are among the principal sources of energy which animals show. The process is called *oxidation* and is essentially the same thing that occurs when wood or coal is burned. The energy belonging to the wood by virtue of its chemical constitution is partly freed by the action of the oxygen in uniting with the carbon and hydrogen, reducing the wood to ashes, water, and carbon dioxid. In the stove the principal form of energy secured is heat; but in appropriate engines, locomotion and other forms of mechanical work, or light, or electrical energy may be secured by the oxidation. So in protoplasm, various types of energy may result from the tearing down of the complex substances. Among these are animal heat, motion, nervous energy and electrical energy. The living body with its protoplasm is really a mechanism,—an engine.

27. **Secretion and Excretion.**—As a result of the constructive and destructive work already mentioned as characteristic of protoplasm certain substances, not themselves protoplasm, may be produced. If these products are of further use in the animal economy, they are usually described as *secretions*; if they represent the final reduction in the process of tearing down, they are called *excretions*. Such materials may be deposited either within the protoplasm or at its surface. In the latter case it may be deposited in a uniform sheet and produce a protective membrane (*cell wall*). The presence of such a covering to the protoplasm very materially modifies all the elementary activities which have been described.

28. **Demonstrations.**—It is easy to make microscopic demonstration of secretions and excretions:—as starch grains formed in the leaves of plants; fat in adipose tissue; cell-walls in plants; crystals in plant cells (see Botany); intercellular substance in cartilage or bone.

29. **Supplementary Topics for Library Work.**—Find and examine some of the classic definitions of *life*. Examine more completely the theories of protoplasmic

architecture. What is meant by saying that protoplasm is *colloidal* in nature? What are the properties of colloids? In what ways would the presence of the cell-wall bring about modifications of the protoplasmic activities? Give an account of experiments showing the effect of some of the more important stimuli on protoplasm (as light, heat, electricity). What of the external conditions are so important as to merit the term "primary conditions of life"? Why may protoplasm be described as chemically *unstable*? Compare oxidation in the protoplasm with oxidation in ordinary combustion.

30. **Summary.**—1. Scientists are not wholly agreed whether life is merely the action of the ordinary chemical and physical forces in connection with a peculiar substance, or represents these, guided by a type of energy of a higher order.

2. Protoplasm, a chemical mixture of exceeding complexity and instability, is the "physical basis of life." Differences in various living things are probably due to differences in the chemical and physical structure of the protoplasm of which they are composed.

3. Owing to the unstable character of the protoplasm it is readily acted upon and changed by external forces; and the various parts of the protoplasm act on each other in such a way as to produce a display of energy. The agents are called *stimuli*. Protoplasm responds to stimuli because of its irritability and contractility. These latter powers belong natively to protoplasm because of its physical and chemical composition.

4. Protoplasmic matter and the materials which are to be destroyed in the production of energy are alike produced by the assimilation of food substances into new protoplasm. This is a most fundamental quality.

5. Growth is increase of mass, following the formation of new substance by assimilation. The mere absorption of water also results in growth. Growth leads naturally to reproduction.

6. Oxygen is one of the chief agents by which the unstable compounds in the protoplasm are made to release their energy. The breaking down of these compounds leaves unused materials which must be excreted. *Respiration*, which is a term applied to the using of oxygen and the elimination of carbon dioxide, and *excretion* are thus seen to be protoplasmic functions immediately connected with its general activity.

## CHAPTER III

### THE ANIMAL CELL; ITS MORPHOLOGY AND PHYSIOLOGY

31. **Introduction.**—In studying the structure of organisms two methods are open to the student of to-day. He may begin with the whole adult individual and by dissection he may reach a knowledge of the constituent parts,—organs, tissues, cells. This, the analytic method, is the method of history by which we have learned the mass of facts which we have at present. On the other hand, it is possible to avail one's self of the results of such studies, to start with the unit of structure which is uniformly found, and, by a synthetic process, trace the building up of an organism from its elementary parts. This is the process which the development of every individual illustrates. It has the special advantage of emphasizing the fundamental unity of origin of the organs, and the likenesses of organisms, and gives, as no dissection can, the true significance of differentiation and development.

32. **The Cell.**—Having discussed in Chapter II the substance in connection with which life manifests itself, it is necessary to recall the fact that the protoplasm of an organism, while connected in various ways, is separated by boundaries into unit-masses, each mass having the essential qualities of the whole. Each unit mass of protoplasm is called a *cell*. The cell is not to be considered as the ultimate unit of structure; it is itself, as we shall see, a group of bodies all of which are in turn highly complex. It is thus to be looked upon as an *organized* structure.

33. **Cell Form.**—Cells, unhampered or not specially stimulated as to the direction of their growth, tend to assume a spherical form. Agencies, both internal and external, as nutritive processes, differences in tension, pressure, etc., may modify this in such a way that almost any form may be found: polygonal, flattened, elongated, filamentous, branched, etc.

34. **Size.**—While ordinary tissue cells are minute, there is great variation in the size of cells. Many single-celled individuals are visible to the naked eye, and egg-cells may be several centimetres in diameter; yet many tissue cells are less than .005 millimetre in diameter. Cells may be very much

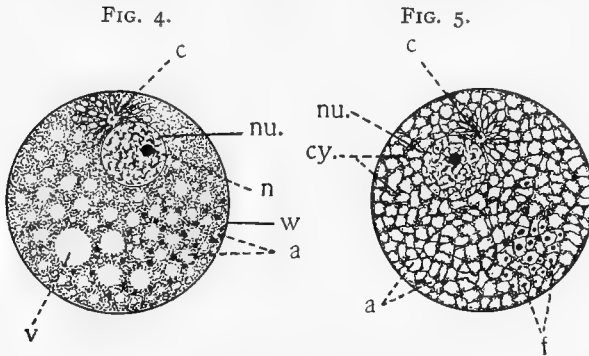


FIG. 4. Diagram showing the principal parts of the cell and something of the protoplasmic architecture as it might appear while living. *a*, alveoli or spheres in the foam-work (see §18); *c*, centrosome; *cy*, cytoplasmic meshwork, containing granules; *nu.*, nucleus; *n*, nucleolus; *v*, vacuole; *w*, cell wall.

FIG. 5. Diagram showing principal parts of the cell as it appears when killed and stained. The protoplasm shows more of a meshwork (*cy*), the spaces representing the alveoli. *f*, formed substances in alveoli. Other letters as in Fig. 4.

**Questions on figures 4 and 5.**—If these cells are in reality  $25 \mu$  in diameter, how much are they enlarged in the drawing? ( $\mu$  is .001 mm.). Identify the various structures referred to in section 35.

extended in one or more directions without possessing great bulk. The outgrowths of nerve cells for example may attain a length of several feet, as when the nerve fibres extend from the trunk to the tips of the toes.

35. **Structure.**—The following parts are to be distinguished in the typical cell:—(1) a general cell substance, partly living protoplasm, partly non-active matter either organic or inorganic; (2) usually a single highly differentiated *nucleus* which contains living protoplasm and is clearly demarcated from the protoplasm about it; (3) one or more specialized bodies known as *centrosomes*; (4) a cell wall or membrane (Figs. 4 and 5).

The cell-substance or *cytoplasm* embraces that portion of the protoplasm outside the nucleus. This is apparently made

up of a more dense colloidal portion which coagulates readily with certain reagents, and the more fluid cell sap which is composed of water with sugar, inorganic matter, and other substances dissolved in it. Suspended in the protoplasm as a part of its formed substance may be starch grains, fats, crystals, and certain distinct, active bodies known as *plastids*, *mitochondria*, etc.

**36. The Nucleus.**—The usually single nucleus lies imbedded in the cytoplasm and is ordinarily separated from it by a thin membrane. Nuclei vary greatly in shape, size, and degree of differentiation. While it is not always possible to find definite nuclei in all cells, it seems probable that all cells have nuclear material in one form or another at some stage of their history. The internal structure of the nucleus is equally as complex as that of the cytoplasm, having both living and non-living portions. It usually consists of a network of threads (*chromatin*) readily stained by certain dyes. In the meshes of this a less easily stainable material occurs (*achromatin*), a portion at least of which is active. One or more deeply stainable bodies, called *nucleoli* and containing accumulations of chromatin, usually occur, the real significance of which is difficult to estimate.

**37. Centrosomes or Centrospheres.**—These bodies when present lie in the cytoplasm but are closely related to the nucleus, and are associated with certain phases of cell activity (see "cell division," §41). The centrosphere is a somewhat clear mass about the centrosomes.

At certain times the cytoplasmic elements radiate from the centrosomes in a very characteristic way (Fig. 8, *c*). These extend even into the nucleus and are associated with a rearrangement of the chromatic elements. Because of this the centrosphere is often spoken of as an *attraction sphere*. The origin of the centrosomes is still a matter of disagreement.

**38. Cell Wall.**—A cell wall usually surrounds the protoplasm. It may be a non-living organic secretion, or may consist of metamorphosed or altered protoplasm in connection with such secretion. The wall is protective and supportive in function, and varies much in thickness, resistance, etc.

Animal cells as a rule are not provided with such well developed and resistant walls as are plant cells.

39. **Cell Functions.**—Since the cell is only a definite unit mass of protoplasm, its functions are in general those which have already been described as protoplasmic functions. They

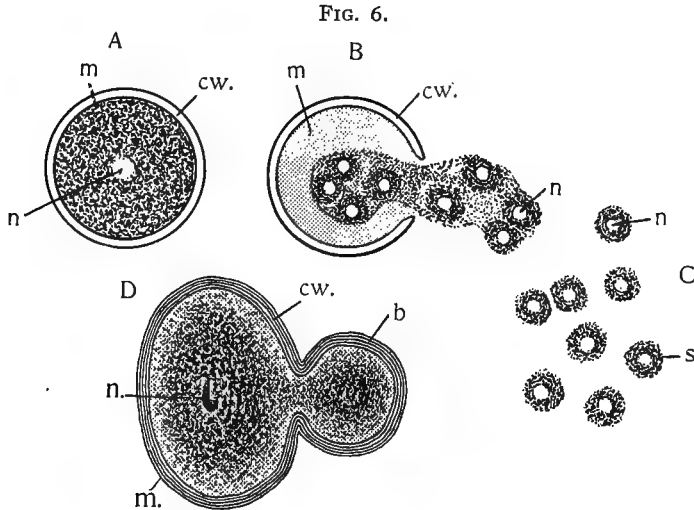


FIG. 6. Modes of cell reproduction. A, B, and C, stages in the reproduction of the Infusorian, *Colpoda*, by the breaking up of the protoplasm to form numerous cells. A, encysted stage; B, protoplasm escaping, spores partly formed; C, spores completely separated (adapted from Rhumbler); D, budding in *Chlamydomyxa*, a lowly Rhizopod. The bud is finally constricted off from the mother cell. b, bud; cw., cell wall; m, mother cell; n, nuclear matter; s, spores.

**Questions on the figure.**—Compare the process and the results of the two modes of cell reproduction shown in this figure. Can you describe the fate of the “mother” cell in the two cases?

are merely localized within the cell. The cell wall when present would naturally modify and limit in important ways, the more active protoplasmic functions, especially motion. In such cases the independent motion characteristic of so many cells must be accomplished by special devices. These frequently take the form of *cilia* or *flagella*, which are thin protoplasmic fibres projecting beyond the cell surface and used after the manner of oars. Locomotion of cells is not confined to single-celled organisms, but is found in many cells of the higher animals and plants—as colorless blood cells, sexual cells, etc., which have a dis-

tinct motion of their own. The muscle cells of higher animals possess the power of contraction and motion in a high degree.

**40. Reproduction.**—The cell grows as a result of the nutritive processes and reaches the limits of size determined by its special conditions. The internal and external conditions together constitute a stimulus to the breaking up or division of the protoplasmic unit. This may occur (1) by spore formation, breaking up of the protoplasm into numerous masses, each of which has the essential qualities of the whole (Fig. 6, A, and B); (2) by *budding*, in which a process, or several processes, appears on the cell, develops into a body like the original cell, and finally becomes separate from it (Fig. 6, D); (3) by *division*, in which there is a division of the original protoplasm into two essentially equal parts. In the last case neither of the cells can be considered the parent of the other.

**41. Cell Division.**—Cell division may be effected in either of two ways, (a) by *direct* or *amitotic* division, in which the

FIG. 7.

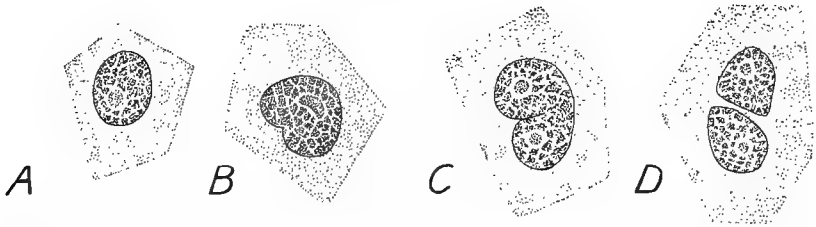


FIG. 7. Direct nuclear division (*amitosis*), in the egg-follicle of a cricket.—(Reproduced by courtesy of The Macmillan Company from Dahlgren & Kepner's "Textbook of the Principles of Animal Histology.")

**Questions on the figure.**—Why is this appropriately called direct division? How does it compare with the process pictured in Fig. 8, in method and in results?

nucleus and cell merely constrict into two nearly equal parts without any elaborate preliminary rearrangement of the nuclear material (Fig. 7); and (b) *indirect* or *mitotic* division. The latter is the usual method and is very complicated. By means of it a very even division of the substances and structures of the nucleus, especially, seems to be secured.

The more striking stages in the process as it usually occurs are outlined in the text and figures which follow. The centrosomes and nucleus will be seen to be especially active. Such a description is only typical of the remarkable series of events. There are numerous variations from this in different organisms.

1. In the quiescent or resting stage the structural elements are distributed in the way which is characteristic of the particular cell under examination (Fig. 8, *A*). The majority of cells are found to be in this stage when examined.

2. When division is about to take place, the chromatin elements in the network of the nucleus assume the appearance of a *coil* or tangle of thread (Fig. 8, *B*). The nuclear membrane often breaks up at this time.

3. The centrosome divides and the halves migrate toward opposite poles of the nucleus, and from them as centres radiations pass into the cell body in all directions. Across the nucleus, from one centrosphere to the other, thread-like lines ultimately extend, producing the appearance of a spindle (Fig. 8, *C*, *sp*). In the meantime the coil of chromatin has been unraveled and has separated into a number of pieces (*chromosomes*), which is definite for a given species. These often form into V-shaped loops. After certain evolutions, these loops come to lie in the equatorial plane of the spindle, the apices of the loops pointing toward the centre of the nucleus and the threads of the spindle attached to the chromosomes. This is called the *astroid* stage (Fig. 8, *C*). The process up to this point is known as the *prophase* or preparation stages.

4. Each of the chromatin loops next splits longitudinally into two. This is the *metaphase* or middle stage (Fig. 8, *D*).

5. Each of these halves now begins to move toward its appropriate pole or centrosome (Fig. 8, *E*). As these half-loops leave the equator and collect about the poles they give rise to a double-star appearance or *diastroid* stage (Fig. 8, *F*). This is the *anaphase*.

6. The loops of chromatin collected at each pole are re-constructed into a coil which then passes gradually into the resting stage at the new position, a membrane is formed, and the daughter nucleus is complete. The spindle disappears, the



radial appearance about the centrosomes, and even the centrosome itself, may disappear or become inconspicuous.

FIG. 8.

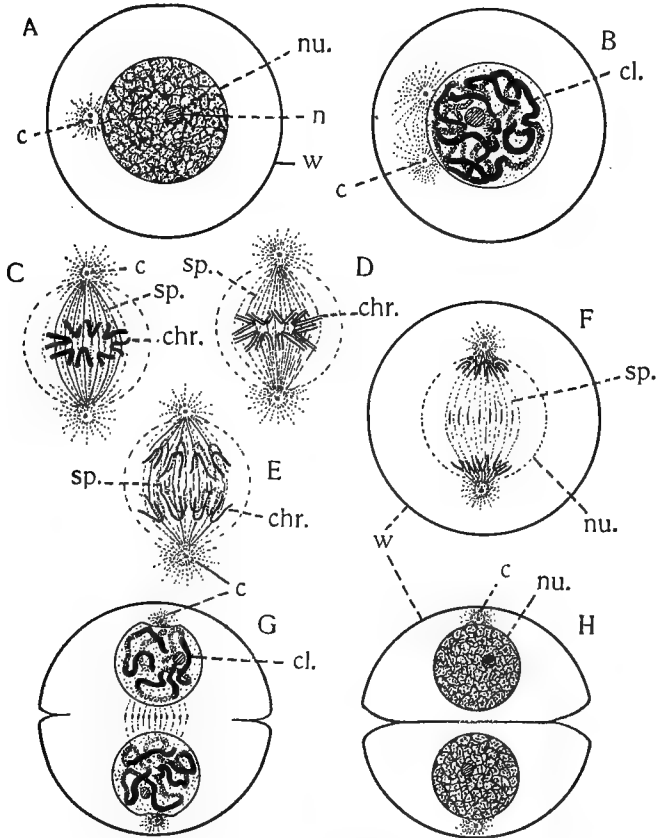


FIG. 8. Indirect or mitotic division (diagrammatic); *A*, resting mother nucleus; *B*, spireme stage, with the centrosomes separating; *C*, *D* (metaphase), and *E*, stages in the division of the chromosomes (the cell wall is not shown in these three drawings); *F*, diastroid (anaphase) stage; *G* and *H* show the return of the daughter nuclei to the coil and to the resting condition, and division of the cytoplasm by the formation of the dividing wall: *c*, centrospheres; *cl.*, chromatin coil; *chr.*, chromosomes; *nu.*, nucleus; *n.*, nucleolus; *sp.*, spindle; *w.*, cell wall.

**Questions on the figure.**—What structures possessed by the original cell are divided in this process? In what order? Why is this termed “indirect” division? Which is the more common, the direct or the indirect? Can you see any special gain secured by this method? Describe the behavior of the nucleolus and the nuclear membrane by comparing this with other figures in reference books.

7. Accompanying or following the last nuclear changes the cytoplasm may have become constricted into two masses, or separated by the formation of a wall perpendicular to the axis of the spindle (Fig. 8, *G*, *H*). The daughter cells may separate or remain united. These final stages are known as the *telophase*. There are other protoplasmic bodies in the cytoplasm which seem to divide, though not so accurately as the nucleus, into two sub-equal portions. Some observers claim, on the contrary, that these bodies arise anew in the cytoplasm or nucleus. These are variously named plastids, mitochondria, etc. The important point is that there seems to be a definite tendency to get equal division of the cell materials.

Cell division is at the beginning of all the complexities of structure found in the higher forms of animals. Each sexually produced organism commences life as a single cell, from which the adult is formed by cell-division, and the clinging together of the daughter cells.

42. **Functions of the Nucleus and Centrosomes.**—While we can follow some of the externals of the various cell activities, the manner of their occurrence and their causes are in the greatest obscurity. We are not able to say just what part is performed by the different structures involved. It is hazardous to say that one structure is more important than another; yet it seems to be proven that the nucleus is quite essential in cells which possess nuclei, for the proper performance of even the ordinary nutritive functions. Some of the unicellular animals may be artificially mutilated in such a way that the lost parts may be regenerated and the normal form restored. A relatively small piece of the Protozoan, *Stentor*, for example, can reproduce the whole, if a portion of the nucleus be present. A much larger piece without nuclear material is wholly unable to regenerate lost parts, and even seems unable to control or exercise the ordinary assimilative functions. The phenomena of indirect cell division suggest that activity on the part of the centrosomes and nucleus precedes that of the cytoplasm. Experiments also show that the division of the cytoplasm may be checked or interrupted by external influences without interfering with the division of the nucleus. On the other hand

nuclei separated from cytoplasm are incapable of continuing their functions. We are at least safe in saying that these three bodies, the centrosome, the nucleus, and the cytoplasm act as *intracellular* stimuli upon each other, and that all are important in the work of the highly-developed cell. During nuclear division there is probably increased interchange between the cytoplasm and nucleoplasm. The breaking down of the nuclear membrane facilitates this.

**43. Exercises for Library and Laboratory.**—It is very helpful for the student actually to study preparations of properly stained cells showing the principal structures; also some of the stages of cell division (see Appendix: Laboratory Suggestions). If no earlier studies have been made of cells and cell division, the growing root tip of *Tradescantia*, or similar plant, is most satisfactory for gaining first impressions of structure, shape, variation, arrangement, differentiation, and stages of division in cells.

What are chromosomes? In what respects and to what extent do nuclei differ? What is meant by the "cell-doctrine"? Give an outline of its history. What are mitochondria? Compare the various series of figures in your library illustrating the stages of cell division.

#### 44. Summary.

1. The cell may be considered as the unit of structure, and is to be defined as a "nucleated mass of protoplasm with or without a cell wall."

2. The cell may also be considered the unit of function, in the sense that it embodies all vital functions in epitome.

3. The structure of the typical cell may be outlined as follows:

(a) Cell body

Cytoplasm—living.

Cytolymph—non-living, fluid.

Metaplasm—non-living, solid.

(b) Nucleus:

Nucleoplasm—living.

Chromatin.

Achromatin.

Nucleolymph—non-living, fluid.

Metaplasm—non-living, solid.

[Protoplasm = Cytoplasm + nucleoplasm.]

(c) Centrosphere.

(d) Cell wall.

(Instead of regarding any particular part of the protoplasm as "living" many investigators prefer to consider the life activities of the cell as merely the interaction of the various parts, no one of which is more alive than another.)

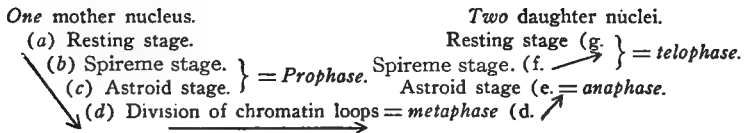
4. In addition to the general functions of protoplasm which cells possess we need to consider in connection with cells the additional functions:

(a) Locomotion.

(b) Reproduction.

5. Reproduction of cells occurs by spore formation, by budding, and by division. Division of the nucleus may be either direct or indirect.

6. The following diagram, adapted from Flemming will serve to represent the stages in indirect division of the nucleus:



7. The important effect of this complicated process is, apparently, to secure an equal division qualitatively and quantitatively of the nuclear elements for the daughter cells. The cytoplasmic elements in the daughter cells may be strikingly unequal.

8. The exact relations of the various structures in the cell are not known. They cannot be fully understood until the chemical and physical nature and interaction of living protoplasm are known. The cytoplasm, the centrosomes, and the nucleus are specialized protoplasmic organs which seem to act as stimuli to one another, in assimilation, growth, and division.

## CHAPTER IV

### FROM THE SIMPLE CELL TO THE COMPLEX ANIMAL

45. **The Individual as a Cell-composite.**—In the simplest animals, as the Protozoa, the individual consists of a single cell, and the life history of the individual animal is such as has already been seen to belong to the cell (Chapter III). In such an individual one cannot speak of organs in the ordinary sense, for organs as we shall see are made up of cells bound together in the doing of certain work. Yet it is important to remember that there are none of the necessary duties of life, such as getting food, digesting it, breathing, moving, reproducing, and the like, which are not well done by these simple one-celled animals. The many-celled animals agree with the simpler ones in that they too start life as single cells apparently quite as simple as the one-celled animals themselves. When the cells divide, however, the daughter cells do not separate as in the Protozoa, but form a mass of cells by remaining together. Owing both to internal and external forces the cells in the mass do not long remain alike, but soon show differences among themselves which serve as the basis for the great variety of structures found in the bodies of the higher animals. The change from the simple cell to the complex condition in the adult animals is not a sudden one, but takes place very gradually and the work which was at first done by the single cell is divided up among the groups of different cells composing the body. The division of the work to be done makes possible and necessary the specializing of certain cells to do each part of it, and the differentiation of structures makes it possible to do each separate task better than before. Thus *differentiation of parts* and *division of labor* go hand in hand as we pass from the simple to the complex animals.

46. **The Fertilized Ovum as a Starting Point.**—In speaking of the development of the adult animal from the simpler condition of the single cell it is necessary to remember that this cell, which has the power of giving rise to a complex individual and is called a fertilized *ovum*, has a history of its own that is very important. The fertilized ovum represents the union of two distinct cells, known as *germ* or *sexual* cells, which are ordinarily quite different in appearance and produced by different kinds of individuals, males and females. Both classes of cells may be produced by the same individual. This union does not produce a double cell, but the parts of each seem to fuse with those of the other in a very complete way.

47. **The Ovum.**—The germ cell produced by the female is known as the ovum, and is typically a spherical cell with

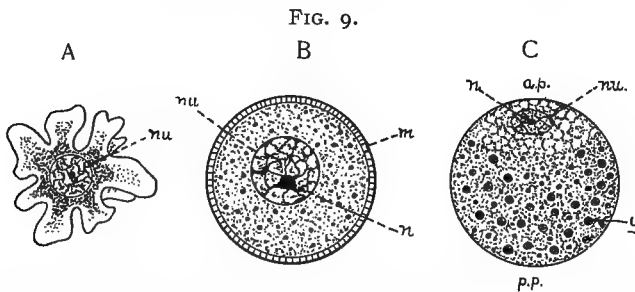


FIG. 9. Types of ova. A, primitive amoeboid ovum of Sponge; B, semi-diagrammatic figure of spherical ovum of *Sea-urchin* in which the yolk is uniformly distributed; C, figure of a spherical ovum (such as may be found in some Worms or in the Frog) in which the yolk tends to collect at one pole, *p.p.*, and the nucleus and protoplasm at the other, *a.p.*; *m*, micropyle; *nu*, germinal vesicle (nucleus); *n*, germinal spot (nucleolus); *y*, yolk spheres.

**Questions on the figure.**—What are the points of agreement in these three ova? The chief points of contrast? What is the function of the micropyle? Is a micropyle always present in ova? Why are the poles of the ovum appropriately called active and passive?

abundant nourishment and inactive as compared with the male cell. It often has an especially well-developed cell-covering. Its nucleus is sometimes called the *germinal vesicle* (Fig. 9). The ovum must be distinguished from what is popularly known as an *egg*. The latter term is loosely used to describe the fertilized ovum more or less developed, together with its nutritive and protective coats such as occur

around the eggs of birds and reptiles. Ova differ very greatly in size. The largest are found among the birds. The "yellow" of these eggs represents the real size of the ovum. Variations in size are due not so much to a difference in the amount of protoplasm as to a varying amount of food or yolk stored in the cell. The food may be uniformly distributed throughout the ovum, mingled with the protoplasm, or it may collect at one pole, forcing the active protoplasm to occupy the other pole (Fig. 9, C). The yolk furnishes food to the young individual or *embryo* in its early development, that is, during cell-division, before it can get food for itself.

48. The **spermatozoon** or male element is ordinarily in striking contrast to the ovum. It is typically very small,

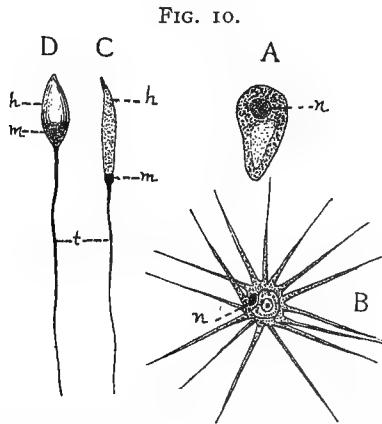


FIG. 10. Types of spermatozoa. A, from the round worm (*Ascaris*), with a cap, somewhat amoeboid; B, from the Crayfish, with numerous projections; C, from Frog; D, from Sea-urchin. h, head; m, middle piece; n, nucleus; t, tail or flagellum. The head is chiefly nucleus.

**Questions on the figure.**—What are the chief points of similarity and dissimilarity in these spermatozoa? How do they agree with, and how differ from, the ova in Fig. 9? How do they differ from the average cell? What parts of the structure of typical cells are believed to be represented in the sperm cells? Which are more like typical cells, the ovum or the sperm cell? Which is more highly specialized?

active, and with thin protoplasmic projections (Fig. 10). Structurally, the typical spermatozoon consists of a "head" piece, a middle piece, and a "tail" or flagellum. The head is composed chiefly of the chromatin material of the nucleus. A delicate

covering of cytoplasm envelops the head and is drawn out into the projection known as the tail (Fig. 10, *D*). The middle piece contains the centrosome of the male cell when this is present.

49. **Early History of Ova and Sperm.**—We formerly thought of ova and sperm as actually formed by the body of the parent. We now know that these germ cells are set apart early in the history of each individual, before the “parent” body is developed. They of all the cells retain their primitive undifferentiated nature. The body cells become different in appearance and powers,—as nerve cells, muscle cells, bone cells, and the like. The body does not *produce* the germ cells; it merely houses and nourishes them during their development. The body cells and the germ cells develop side by side, each influencing the others in their development.

After the first putting aside of the *primordial germ cells* in the early life of the individual, the body cells have a period of rapid division and growth. During this time the germ cells are relatively quiet. As the parent animal becomes mature the primordial germ cells enter upon a period of activity by which they produce such ova and sperm as are described in the preceding sections. This period of activity of the germ cells shows three stages: (1) a period of increase of the primordial germ cells (*oögonia* and *spermatogonia*) by division; (2) a period in which the last descendants of these divisions enlarge (becoming *primary oöcytes* and *spermatocytes*); and (3) a period of maturing or perfecting these (into *ova* and *spermatozoa*). These stages are suggested in Fig. 11.

50. **Maturation of Ova and Sperm.**—This third stage, the maturation or ripening of the germ cells, shows us some of the most remarkable happenings to be found in all biology. Both ova and sperm when ripe contain, as a rule, just one-half as many chromosomes in their nuclei as are found in the primordial germ cells, or in the body cells, of the species to which they belong. Somewhere in the history of the egg and sperm there is therefore a *reduction division* of chromatic material in the nucleus. It does not always take place in just the same way, but the following will illustrate the process. The student should



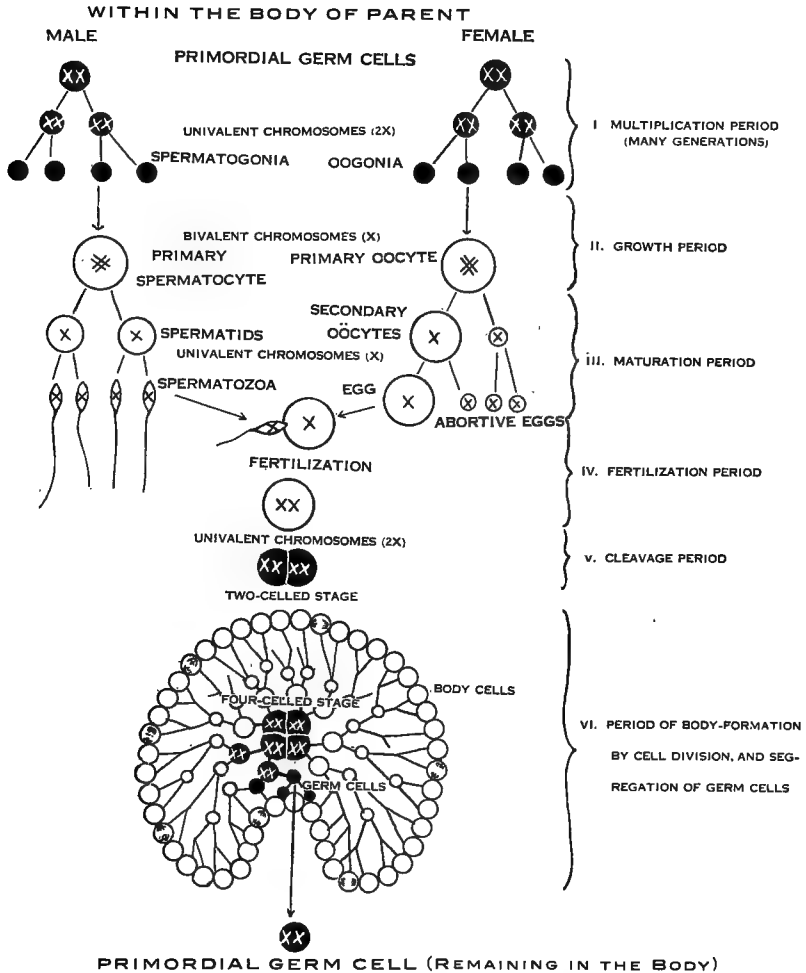


FIG. 11. A diagram of the germ cell cycle, suggesting the changes by which the primordial germ cells in the body give rise to the mature eggs and sperm; fertilization; cleavage; and the segregation of new primordial germ cells as the new body is developed. (See §§49-52, 60.) The full number of chromosomes in the cells of the body is 2x. The half number found at certain stages is indicated by x. The large gastrula at the bottom of the figure is to illustrate the early differentiation and segregation of germ and body cells.

**Questions on the figure.**—Trace the changes of the chromosomes through the whole series of stages. The solid black is intended to emphasize the potential germ cells. Why are all the cells of the two and four-celled stages represented in black? Why are the chromosomes in the primary oöcyte and spermatocyte said to be *bivalent*? What is meant by *univalent*? What does “continuity of germ-plasm” mean?

FIG. 12.

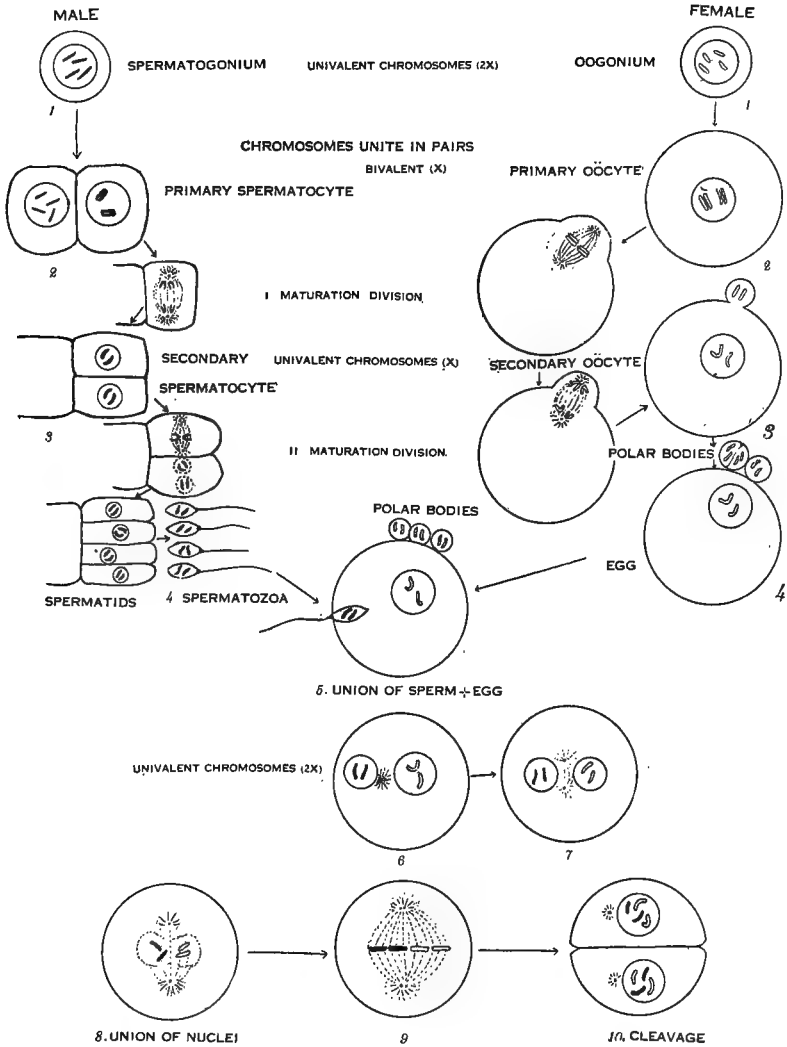


FIG. 12. A diagram to show the central place of the fertilized ovum, and the important stages leading up to it together with those following it. Compare with Fig. 11. The male chromosome are figured black and the female light, throughout. Compare descriptive matter in text.

**Questions on the figure.**—In what respects is the maturation of the ovum and of the sperm similar? In what, different? What is the probable meaning of the pairing of the chromosomes (*synapsis*) in the early maturation stages. How does this first division of chromosomes differ from the ordinary divisions. Why may the polar bodies be called abortive eggs? What is accomplished by the union of the sperm and ovum nuclei? In cleavage the chromosomes from both parents seem to be distributed equally to all the cells of the body. What is the significance of this? How much of Fig. 11 does Fig. 12 cover?

follow closely the figures 11 and 12, in order to get the steps described.

When the full-grown primary oöcyte and spermatocyte are ready to divide at the beginning of the third stage, the chromosomes in a given nucleus unite closely in pairs. Thus when division begins there is only one-half the usual number, but each chromosome is of double value (*bivalent*). As the primary cells divide into the secondary oöcytes and spermatocytes, the bivalent chromosomes behave as single chromosomes in ordinary nuclear division and split, and one-half of each bivalent chromosome passes to each daughter nucleus. In this way each secondary oöcyte or spermatocyte contains one-half the usual number of single (or *univalent*) chromosomes. By this device of first *uniting* and then *separating* whole chromosomes, instead of *splitting* the single chromosomes into halves, as occurs in ordinary nuclear divisions, an actual reduction of the number of chromosomes is secured. Furthermore there may be, while these chromosomes are associated, an actual interchange and modification of the substance of each.

The secondary cells divide once more in forming the mature eggs and sperm. In this last division the chromosomes simply split as they do in ordinary indirect nuclear divisions.

In all these steps in the division of nuclear material the history of ova and sperm is essentially the same. There are, however, very striking differences in the way the cytoplasm, and the cell as a whole, behaves. In the formation of the sperm cells the protoplasm divides equally in both divisions, and thus each primary spermatocyte produces four small *spermatids*. Each spermatid gradually changes, without further division, into a *spermatozoön*.

In the divisions of the primary oocyte, on the contrary, one of the daughter nuclei enters a kind of bud in the wall of the cell and carries very little cytoplasm with it. It is clearly an abortive cell, and is called a *polar body*. The second nuclear division results in another abortive egg-cell or polar body. The first polar body sometimes divides into two. All the polar bodies finally disintegrate. Thus, since one of the nuclei has almost all the cytoplasm and the others almost none at all, there is only one

mature well-nourished egg as the result of the two divisions. In the formation of the sperm there are usually four perfect cells arising from each spermatocyte.

In the above discussion no account is taken of the fact that the male and the female of a species may differ in the number of chromosomes found both in body cells and in germ cells. Frequently, for example, the oögonia have an even number ( $2x$ ) and the spermatogonia one fewer, an odd number ( $2x - 1$ ). In such cases all the eggs will receive the same number of chromosomes ( $x$ ). The odd, unpaired chromosome in the spermatocyte does not split, but goes undivided to one pole. This results in two kinds of spermatozoa, equal in numbers, one having  $x$  chromosomes and the other with  $x - 1$ . When these sperm cells unite with ova there arise two kinds of individuals, one with  $2x$  chromosomes in the body cells and germ cells, and the other having  $2x - 1$ . This is the condition that obtained in the original female and male parents.

51. **Fertilization.**—The union of a sperm cell with an ovum constitutes the act of fertilization. Often there is one (or more) special aperture (*micropyle*) in the outer egg-membrane through which the spermatozoön finds entrance. Usually only one sperm cell gains admission to the interior of the ovum, whether by way of the micropyle or through the unmodified membrane. Changes normally occur in the membrane as soon as one sperm enters, by which all others are excluded. In eggs which have been kept too long or subjected to unfavorable conditions, the response of the membrane may not be so quickly effected and several spermatozoa may enter. Such polyspermy occurs normally in some species. Multiple fertilizations may produce monstrosities. The sperm cell may enter the egg even before the polar bodies are formed; or it may enter after maturation is completed. It brings into the egg the nucleus, the centrosome and a very small amount of cytoplasm. It at once organizes itself as a second nucleus of the egg and is nourished by its substance. The sperm nucleus and the egg nucleus, each carrying one-half the full number of chromosomes of the species, now typically draw together and organize into a new nucleus.

Thus is formed the *first segmentation nucleus*, and the egg is *fertilized*. With the addition of the chromosomes in the male nucleus the fertilized ovum contains the same number of chromosomes as before maturation, which in each species of animals is a constant number, except for the differences between the sexes. It appears that fertilization restores to the female cell essentially what is lost in the process of maturation, and in addition serves to stimulate it to active nuclear and cytoplasmic division as indicated in the next paragraph.

**52. Segmentation or Cleavage.**—Following shortly upon fertilization, if conditions are favorable, ordinary mitotic nuclear division begins and the ovum divides promptly into 2, 4, 8, 16, etc., cells (*blastomeres*). In the first division the chromosomes split, and one-half of each chromosome brought in by the sperm nucleus and one-half of each furnished by the egg-nucleus go to each daughter nucleus. This is continued in later divisions, and in this way every cell of the body gets its chromatic material equally from the father and the mother. The resulting cells become smaller and smaller with each division, since the whole egg-mass does not increase appreciably in size meanwhile.

The first three cleavage planes are usually perpendicular to each other. Their position is much modified, however, by the presence of food or yolk substance in the egg. The yolk in general retards cleavage. If the yolk is in small quantity and is uniformly distributed through the egg, the blastomeres will be about equal in size (Fig. 13, *A*), and will continue to divide with practically equal promptness. If there is much of the yolk it is not likely to be uniformly distributed. Under the influence of gravity and internal forces, the yolk is likely to collect at the lower, and the protoplasm and nucleus at the upper, pole of the ovum (Fig. 13, *B, C*). The protoplasmic pole is known as the *active* or *formative pole*, and the lower as the *passive* or *nutritive pole*. The polar bodies are normally freed at the formative pole. Under these circumstances the blastomeres at the nutritive pole are larger and divide less rapidly than those in which the protoplasm is in excess. If the yolk is excessive in amount that portion of the ovum in which it collects may be totally prohibited from dividing as will be seen in Fig. 13, *C, D*.

FIG. 13.

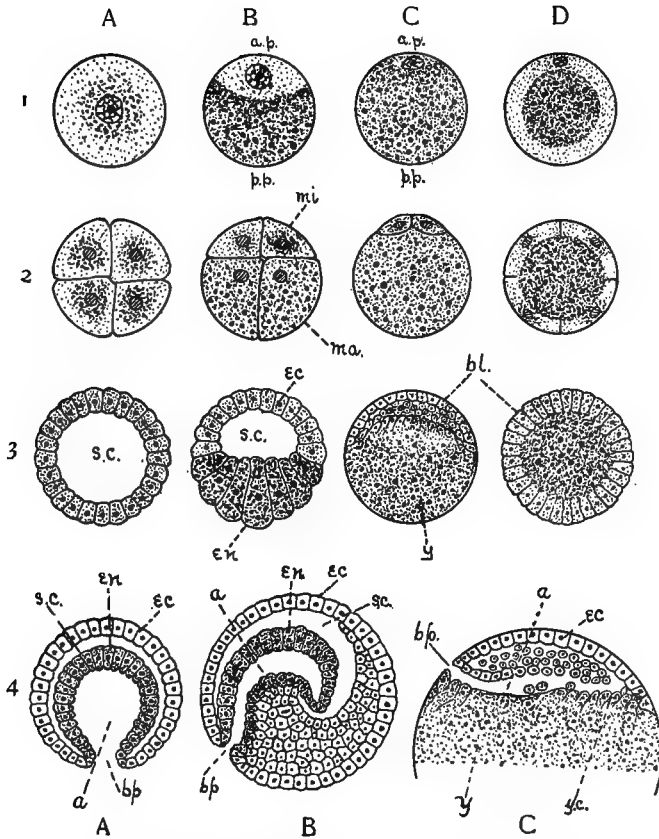


FIG. 13. Cleavage and gastrulation as affected by yolk (not drawn to scale). The vertical rows A, B, C, and D represent different classes of ova. A, an ovum with little yolk; B, one with considerable yolk collected at the lower pole (*p.p.*); C, one with a large amount of dense yolk crowding the protoplasm to one side (*a.p.*); D, ovum with dense yolk collected at centre. The numerals (1-4) indicate stages in cleavage and gastrulation: 1, ova; 2, 4-celled stages of segmentation; 3, blastomeres, blastula stage; 4, gastrula stage. *a*, archenteron; *a.p.*, active pole; *bl*, blastoderm; *b.p.*, blastopore; *ec*, ectoderm; *en*, entoderm; *ma*, macromeres; *mi*, micromeres; *p.p.*, passive pole; *s.c.*, segmentation cavity; *y*, yolk; *y.c.*, yolk nuclei.

**Questions on the figures.**—What constitutes the difference between the active and the passive pole? Judging from the drawings and from your references to texts does gravity have any influence in determining the position of these? Your evidences? Which pole gives rise to ectoderm? Why does the food substance interfere with segmentation? What is the difference between the segmentation cavity and the archenteron? How does the presence of food substance modify the formation of an archenteron?

53. **Forms of Segmentation.**—The conditions suggested above give rise to the following classes of segmentation.

- A. Total segmentation (in which the planes of cleavage pass through the egg).
  - I. Equal: in which there is little yolk material, and that is well distributed. (Illustrated in most of the lower invertebrates and mammals.) Fig. 13, A.
  - II. Unequal: in which there is a moderate amount of yolk which accumulates at the passive pole. The cells at the active pole are more numerous and smaller than at the passive. (Illustrated in many mollusks and in the Amphibia.) Fig. 13, B.
- B. Partial segmentation (in which a portion of the egg does not divide).
  - I. Discoidal: in which there is an excessive amount of yolk, with the nucleus and a small mass of protoplasm occupying a disc at the active pole. This disc alone segments, and the embryo lies upon the yolk. (Illustrated in the eggs of fishes, birds and reptiles.) Fig. 13, C.
  - II. Peripheral: in which an excess of yolk collects at the centre of the ovum, with the protoplasm at the periphery. The dividing nuclei assume a superficial position and surround the unsegmented yolk. (Illustrated in the eggs of insects and other arthropods.) Fig. 13, D.

54. **Blastula and Morula.**—As cleavage continues the blastomeres remain associated in a spherical mass. The individual cells project beyond the general surface not unlike the lobes of a mulberry, and for this reason this stage is called the *morula* or mulberry stage (Fig. 13, 2). By the growth of the cells and by the imbibition of water the morula may become a hollow sphere of cells (*blastula*) the central cavity of which is filled with fluid. The cavity is termed the *segmentation cavity* (Fig. 13, s.c.). Some animals, such as Volvox, never develop beyond the morula or the blastula stage.

55. **Gastrula.**—In those eggs in which the segmentation is total, a next important step is the pushing in of that side of the blastula which corresponds to the original nutritive pole. The process is known as *invagination*, and the product as a *gastrula* (Fig. 13, 4). It takes place much as one might suppose one side of a hollow rubber ball to be dimpled or infolded by the exhaustion of the air within. The gastrula is to be described as made up essentially of two layers of cells, one external and called *ectoderm*, and one within called *entoderm* (Fig. 13, 4). The segmentation cavity may be wholly obliterated; in that case the entoderm and ectoderm come to lie in contact. The cavity of the invagination of the gastrula is the *archenteron* or embryonic

digestive tract; the opening into it, that is, the mouth of the gastrula, is the *blastopore* (Fig. 13, *bp*). Such an organism as Hydra (see Fig. 81) may be looked upon as a permanent gastrula, somewhat modified in form. In morulas in which the segmentation cavity is small and the cells at the nutritive pole are large (Fig. 13, C, 4) this simple condition is much obscured, and invagination as described above becomes impossible. Nevertheless early in development the cells which produce the two primitive layers are to be distinguished, and their relations are usually substantially as detailed. If the term gastrula is applied to these we have to say that they are formed in some other way than by ordinary invagination.

56. **Library Reference.**—By reference to books on embryology the students may report briefly on gastrulation by overgrowth (*epibole*), and by *delamination*. Compare the results attained by the various methods. Note what is *constant* in the methods and in the results.

57. **Germinal Layers.**—The ectoderm and entoderm have thus far been mentioned as the primary germinal layers of cells. Some of the Invertebrates have only these two layers, but in

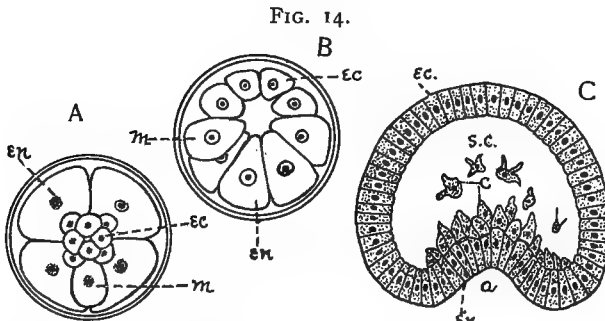


FIG. 14. Modes of forming mesoderm (diagrams modified from Whitman and Selenka). A and B, special mesoblasts distinguishable early in segmentation (Annelid): A, surface view from active pole; B, sectional view of same. *ec*, micromeres destined to form ectoderm; *en*, macromeres destined to form entoderm; *m*, primitive mesoblast which produces the mesoderm. C, amœboid mesodermal cells (*c*) budding from entoderm into the segmentation cavity (*s.c.*), in an Echinoderm. *a*, archenteron.

most cases a third mass of cells comes to be situated between the ectoderm and entoderm, from which important organs are derived. The third or middle layer (*mesoderm*) differs somewhat in its origin in the different groups of animals. It may originate



(1) from the multiplication of a few special cells which, before invagination, in early cleavage stages, become distinct from those that are to form ectoderm and entoderm (Fig. 14, *A* and *B*, *m*); (2) by means of isolated, wandering cells budded from the other two layers, particularly the entoderm (Fig. 14, *C*, *c*); or (3) from entoderm, in the form of pouches or of solid buds of cells which arise from the walls of the archenteron and extend into the segmentation cavity (Fig. 15, *m*). In some instances there may occur a combination of these methods.

FIG. 15.

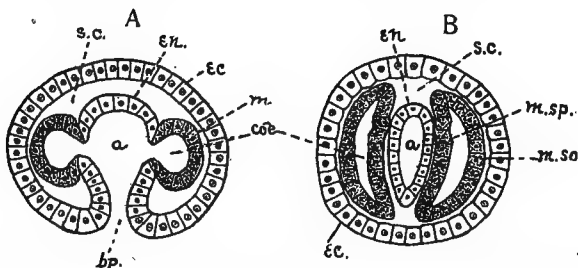


FIG. 15. Mesoderm formed by pouches from entoderm after gastrulation. *A* and *B*, early and later stages in formation of mesoderm and coelom. *a*, primitive gut; *bp.*, blastopore; *ca.*, body cavity, formed from pockets of the archenteron; *ec.*, ectoderm; *en.*, entoderm; *m.*, mesoderm; *m.sp.*, body-wall mesoderm; *m.so.*, visceral mesoderm; *s.c.*, segmentation cavity.

**Questions on figures 14 and 15.**—Enumerate the three modes of mesoderm formation figured here. In which type may the mesoderm be identified most early in the embryonic development? By comparing with other texts determine in what groups of animals the mesoderm is formed as in Fig. 15.

**58. Coelom, or Body Cavity.**—When the mesoderm develops by the last mentioned method, *i. e.*, by the evagination of the wall of the primitive gut (Fig. 15, *m*), we see a pair of folds, or a series of pockets, the cavities of which are at first continuous with the archenteron, but later become separate from it and entirely surrounded by the mesodermic layers. The outer wall of the mesodermic pouches joins the ectoderm and forms a body wall, and the inner applies itself to the entodermal wall of the gut. The space between is the *coelom* or *body cavity*. When the mesoderm arises as a solid mass, instead of a pocket, the body cavity is formed by the splitting of the mass into an inner and an outer portion. When the coelom is formed by several pockets the cavities of these may ultimately coalesce,

forming a single body cavity. Such a cavity is found in all the vertebrates and in the higher invertebrates, although it may become more or less obscured and modified in the adult.

**59. Differentiation of Organs and Tissues.**—We have already in these three layers and their foldings the fundamental outline of that differentiation which is to give us the complex animal form found in the adult. From these layers, singly or in combination, all the tissues and organs of the body arise. The various layers become locally thickened, folded, or otherwise modified in form by rapid cell division, thus producing the beginnings of organs. At a later date differentiation takes place among the cells, and tissues arise (see next chapter). In general each layer gives rise to such structures as its position and relation to the other layers would suggest. This is especially noticeable in the ectoderm and entoderm. The *ectoderm* is more closely related to the outside world, and from it are produced the protective and sensory structures. These include the outer portion of the skin and the hard parts often associated with it, and the whole nervous system together with the sensitive portions of the organs of special sense, as the retina of the eye. The *entoderm* is derived from the cells which contain, or at least are closely related to, the food originally stored in the ovum (Fig. 13), and it comes to lie in the interior of the embryo. It furnishes the lining of the adult digestive tract as well as the essential parts of the glands and other outgrowths arising from it. The *mesoderm* gives origin to the muscles and to the supportive tissues, to the blood vessels and blood. Many of the organs are made up of contributions from two or all of these germinal layers. Students must be referred to special textbooks on embryology for a more extended account of the manner in which the germinal layers give rise to adult organs.

**60. Summary of the Life-cycle and the Meaning of the Steps.**—It is important that the student bring together the essential points in the cycle of events that occur in the life history of an organism from one generation to the next.

1. *Fertilization.*—If we start with the mature egg and sperm ready to unite, we must recall (§50) that each of these has lost,

by the reduction division, one-half of the natural number of chromosomes in the species. There is an increasing body of evidence for the belief that the chromosomes chiefly bear the hereditary characters from one cell to another and hence from one generation to another. When the nucleus of the sperm unites with the nucleus of the egg in fertilization one-half of the chromosomes in the new nucleus thus comes from each of the parents. Fertilization may be said then to do two things: (a) it unites the substances carrying hereditary qualities from two parents (usually); and (b) starts the development of the egg (Figs. 11, 12).

2. *Cleavage, and the Segregation of Germ Cells.*—The fertilized egg soon begins to divide (*cleavage*). The resulting cells may be much alike or may be very different in size and contents, from the very beginning. (See Fig. 13.) Most of these cells enter directly into the making of the adult body by the differentiation into entoderm and ectoderm, and later into nerve cells, muscle cells, gland cells, and the like. It has been clearly shown, however, for some species, that certain undifferentiated cells are very early put aside, which do not take direct part in the development of the tissues of the body. By tracing the history of these cells through the various stages of embryonic development it is found that these are primordial or ancestral germ cells and that they ultimately produce the sperm and egg cells with which we are familiar. (See Figs. 11 and 12.) It is probable that something similar will be found to be true of animals generally.

3. *The Parallel Development of the Body and the Germ Cells.*—From this time on two quite different things are happening in every normal body as it develops: (a) the body cells are multiplying, growing, and because of the hereditary qualities which they carry are differentiating to form the tissues and organs of the animal; and (b) the primordial germ cells, which have come from the same egg, and are cousins—not descendants of the body cells—are dividing and growing, *but not differentiating*. During whatever time is necessary for the organism to develop its body tissues and organs, the primordial germ cells are finding the permanent place they are to occupy in the body and are,

in cooperation with certain of the body cells, forming the inner sex glands,—*testes* and *ovaries*.

4. *Sexual Maturity and the Perfection of the Ova and Sperm.*—In this parallel development of the germ cells and the body cells it is certain that they modify each other profoundly. The germ cells depend for their supply of food and oxygen, etc., upon the activities of the body cells. Undoubtedly the wastes of the body cells also influence the germ cells. However, it seems that the presence and products of the germ cells even more modify the growth of the body. This is especially true as the germ cells and glands approach maturity. In a number of species it has been shown that the development of certain parts of the body is very much changed if the maturing sex glands are removed early in life. In general it is believed that the special (*i. e.*, *secondary sexual*) differences in the bodies and the instincts of the males and females of a species are largely due to the effect of the development of sperm and ova within the bodies. That is to say, the sex qualities in the bodies and instincts are directly produced by secretions (*hormones*) manufactured by the inner sex organs (*testes* and *ovaries*).

In the last steps whereby the spermatogonia produce sperm and the oogonia produce eggs, there are two happenings very important in development: (*a*) the union of the simple chromosomes of a nucleus, originally derived from the two parents, to form the *bivalent* chromosomes; and (*b*) the separation of these at the next division in such a way as to reduce the simple chromosomes to one-half the number usually found in the cells of the species (Figs. 12, 13).

It will be recalled that the chromosomes found in any primordial germ or body cell are descendants of chromosomes that came in equal numbers from the egg and sperm nuclei when these first united. We have seen that every cell gets its part of every one of these chromosomes. It is believed, when these chromosomes unite in pairs in the act of maturing, that they do not unite in a chance manner, but that those pairing are *corresponding* chromosomes coming originally from the mother and father. By “corresponding” we mean in general the chromosomes that tend to determine the same traits. In other words this union is the

final scene in the mixing of male and female qualities which began when the egg and sperm united in fertilization. The *protoplast* of ovum and sperm unite at fertilization; but the final union of the chromosomes of the ovum and sperm is delayed until near the time of the formation of the next generation of sperm and ova. It is possible that these bivalent chromosomes may exchange material before their final separation.

The reduction of the chromosomes to one-half their typical number is clearly a device which maintains the standard number when the ovum and sperm unite. If they were not reduced the number of the chromosomes, and the accompanying hereditary effects, would be doubled at every fertilization.

### 61. Summary.

1. All the higher animals begin life as a single cell and reach their adult condition by a continuous series of divisions. By the growth and specialization of the cells arising from these divisions the great complexity of the adult body is produced.

2. This initial cell—the fertilized ovum—represents the fusion of two independent and unlike cells: the ovum (female) and the spermatozoön (male).

3. Before the union (*fertilization*) occurs, the ovum reduces its nuclear material, by two successive divisions, to one-fourth its original amount and the chromosomes to one-half their original number, without a corresponding reduction of the cytoplasm. The spermatozoön in its development undergoes a similar reduction of chromosomes and a great reduction of protoplasm. When fertilization occurs the full number of chromosomes is restored to the new organism. This reduction and restoration of chromatin is believed to play a large part in inheritance.

4. After the union of the male and female cells the fertilized ovum divides rapidly (*segmentation* or *cleavage*) forming a mass of cohering cells. The nature of these cells and of the mass depends much on the amount of yolk in the ovum and on its distribution.

5. By processes which differ in different animals according to the nature of the segmentation, the cells become arranged

with a layer outside (*ectoderm*), a layer within (*entoderm*), and from these a third layer or mass of cells lying between the other two (*mesoderm*). The entoderm bounds a cavity (*archenteron*) which communicates by a pore (*blastopore*) with the outside world. Within the mesoderm may be found a cavity (*cœlom*).

6. The ectoderm gives rise to the outer portions of the skin, its protective and sensory structures, to the nervous system, and frequently to the lining of the openings into the body. The entoderm lines the principal part of the digestive tract. The mesoderm gives rise to most of the other structures of the body.

### 62. Suggestive Topics for Library Work.

1. What suggestions have been offered as to the advantage of the addition of the male nucleus to that of the female in fertilization? Has a similar result ever been attained artificially by means of chemical or other stimuli?

2. What explanations have been offered as to the significance of the process of maturation? Trace the maturation of the sperm cells more fully.

3. What classification of ova do the text-books make? What is the basis of the classification? To what extent do eggs of different animals vary in size, shape, envelopes, etc.? Give examples.

4. Is there any explanation of the fact that there is such a difference in the amount of food substance in the eggs of different animals?

5. Trace out by reference to a text-book of embryology the principal changes by which the adult digestive tract is derived from the simple condition found in the gastrula (*archenteron*). What is the fate of the blastopore? How does the permanent mouth originate?

6. How do males and females compare as to the number of chromosomes in their sex or tissue cells? Where the male has (as is frequently the case) an odd number of chromosomes, what happens in the reduction division during sperm-formation? Explain the condition indicated by the terms "*x*" and "*y*" chromosomes.

7. When there are two kinds of sperm, differing in the num-

ber of chromosomes, formed by an animal, what is believed to be the difference in result when eggs (which have a uniform number) are fertilized by the two kinds?

### 63. Exercises for the Laboratory.

Specimens of some of the smaller ova (as of the snail, fish, sea-urchin) may be secured for examination with the microscope. Compare the ovum taken from the ovary of a hen with a new laid egg, noting especially the structure of the latter. Obtain spermatozoa from the testis of a recently killed animal (as mouse, fowl, etc.), and examine with highest powers of the microscope. If possible secure permanent mounts of segmenting eggs of sea-urchins, showing the 2-, 4-, 8-celled stages,—up to the gastrula.

## CHAPTER V

### CELLULAR DIFFERENTIATION.—TISSUES

64. Two things of importance happen to the body as the organism develops from the simple condition of the ovum to the great complexity of structure in the adult: (1) the increase in the number of cells, which is quantitative in nature, and (2) the differentiation of cells, whereby the cells of the various parts become very diverse in shape, composition, and powers. This is a qualitative change. It is not yet fully known how much of the difference in the cells of the various tissues is due to *qualitative* differences in the daughter cells of a given division, and how much is due to external influences and the interrelations of the cells after division. We know, for example, that gravity acting on the food substance of the ovum before division does produce such differences among the daughter cells of the early cleavage stages as lead to results as diverse as ectoderm and entoderm. Doubtless there are also internal processes that tend to give rise to similar differences. On the other hand, it has been shown by experiment that, even as high up in the animal scale as the lowest vertebrates, the blastomeres of the two- or four-celled stage may be shaken apart and *each* develop into a small but perfect embryo. If these cells had been left together, each would have produced a definite portion of a single animal. This experiment shows that up to this stage no specialization has taken place which limits the products that come from these cells. The blastomeres do not thus develop after the 8- or 16-celled stage is reached, so far as is known. We are ignorant of the causes which determine that one cell shall develop into a muscle cell and its neighbor into a bone cell.

65. **Tissues.**—A tissue is to be defined as a group of similar cells suited by their differentiation to the performance of a definite function. This differentiation affects the size, shape, and the interrelations of cells, and likewise the chemical and



physical structure of the protoplasm, in such a manner as to cause great variation in their powers and activities. The chemical differences are especially shown in excretion and secretion, whereby various sorts of materials are deposited within and between the cells of the different tissues. The material deposited between the cells is known as *intercellular substance*. The intercellular substance differs much in character and amount. Both the cells and the intercellular substance are important in enabling the tissue to perform its work. In general if the tissue is active (as muscle) the cellular differentiation is the important point; if, however, the function is a more passive one, as support or protection, the nature of the intercellular substance rather than the cells determines its character (bone, connective tissue).

**66. Classification of Tissues.**—From a physiological point of view tissues may be classed in one of two groups: *vegetative*, and *active*. The vegetative tissues are those which perform the more passive functions, as nutrition, protection, support, etc. They resemble the plant tissues in their functions. The two chief classes of vegetative tissues are: *epithelial* or bounding tissues, and *supportive* or *connective* tissues. The active tissues may be looked upon as the characteristic tissues of animals. The *muscular* and *nervous* tissues belong to this group.

**67. Epithelial Tissues.**—This tissue is characterized by its primitive form, *i.e.*, by its relative lack of differentiation, by the fact that it is the first to appear in individual development (ectoderm and entoderm in the gastrula), and by the very small amount of intercellular substance. It is a bounding tissue and consists typically of a single layer of cells, although several layers may occur. Epithelium bounds, by its own cells or their products, the outside of the body, the lumen of the digestive tract and its outgrowths, as well as the body cavity and the structures contained in it.

**68. Kinds of Epithelial Tissue.**—Located in a position superficial to the other tissues, epithelium is subject to a wide range of variation both as to form and function. Besides its

primary work as a protective layer, the epithelium may have a glandular function, being favorably situated for the final

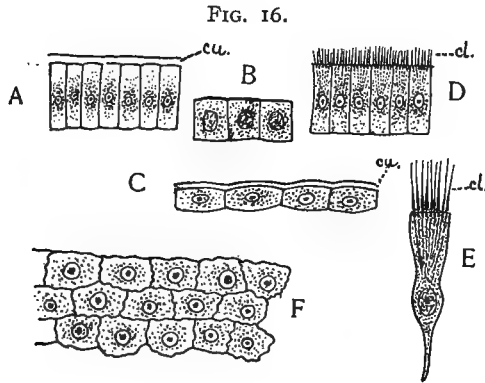


FIG. 16. Various kinds of epithelial cells (semi-diagrammatic). A, columnar; B, cuboidal; C, pavement; D and E, ciliate (sectional views). In F is shown the surface view of pavement epithelium. *cl.*, cilia; *cu.*, cuticula.

**Questions on the figures.**—For what different uses would you judge these variously shaped epithelial cells to be suited? Under what circumstances and on what surfaces would you expect to find each type? Compare with your reference texts and see if they are so found. Under what circumstances is a cuticula to be expected? Where would it be a disadvantage? What are cilia?

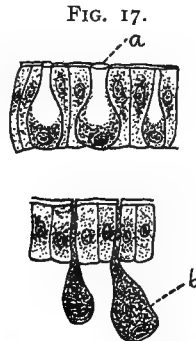


FIG. 17. Glandular epithelium. *a*, goblet or slime cells,—unicellular glands; *b*, similar cells which have become depressed below the surface, and empty their secretion through a duct.

**Questions on the figures.**—Are the glandular cells *modified epithelial cells*? In what respects do they differ from the cells about them?

elimination of products from the body. Since it is especially exposed it is the layer best adapted by position to receive those external stimuli which we know to play such an important rôle

in the life of all organisms. The position of the epithelium also renders it specially liable to destruction. To compensate for this its primitive or undifferentiated character makes it particularly capable of regenerating portions of itself which may have been lost. Epithelium is often especially active also in the regeneration of other than simple epithelial structures, as, for example, the regeneration of nervous cells in a cut earthworm. In close connection with this latter regenerative quality

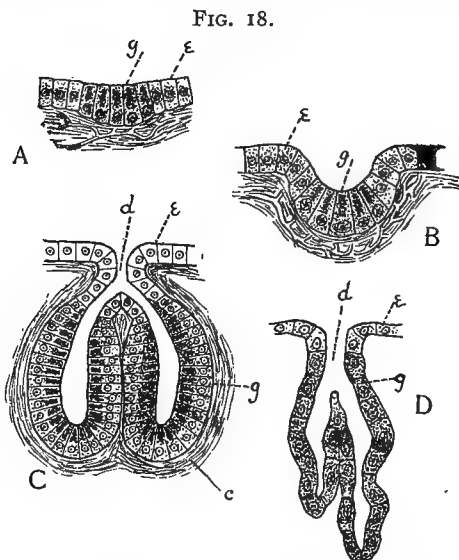


FIG. 18. A series of diagrams showing progressive stages in the development of a multicellular gland from an area of glandular epithelial cells. C and D show two somewhat different types of gland,—the cup-shaped and the tubular. *ε*, bounding epithelium; *g*, gland cells; *d*, duct; *c*, connective tissue.

**Questions on the figures.**—How do the compound glands seem to arise from the simpler condition? What is the evidence that glands are lined throughout with epithelium? What is gained in the sinking of the glands below the surface?

is to be considered the fact that the reproductive or sexual cells, by which new individuals are produced arise from an epithelium. The foregoing enumeration of functions suggests the physiological classification of epithelia:—bounding, glandular, sensory, and reproductive epithelia. The same layer may fulfill several of these functions at once.

69. **Bounding Epithelium.**—The ordinary protective epithelium may be made up of cells cuboidal in shape (Fig. 16, *B*), or columnar (Fig. 16, *A*), or much flattened (Fig. 16, *C*). In extreme cases of flattening and hardening we have *squamous epithelium*, *e.g.*, the outer cells of the human epidermis. Motile proto-

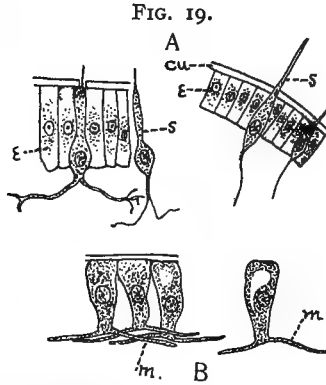


FIG. 19. Sensory and muscular epithelium. *A*, sensory epithelium, from Worm, showing some of the epithelial cells ( $\epsilon$ ) modified into sensory cells (*s*). *B*, epithelial cells from Hydra showing contractile or muscular processes at base (*m*).

**Questions on the figures.**—Is there anything to suggest that the sensory cells are modified epithelial cells? What are the principal changes which they have undergone as compared with the unmodified epithelium?

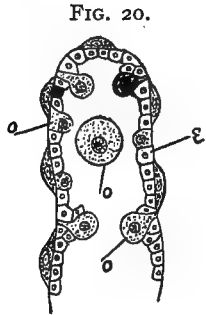


FIG. 20. Diagram of a portion of the ovary of Sea-urchin showing the eggs arising from the epithelium (reproductive epithelium) by constriction.  $\epsilon$ , epithelium; *o*, ova in different stages of growth.

**Questions on the figure.**—What is an ovary in its simplest form? Is the reproductive epithelium ectodermal, endodermal, or mesodermal in origin, as a rule?

plasmic projections often extend from the free surface of the epithelium. *Flagellate epithelium* (Fig. 79, *D*) has one such projection from each cell, whereas *ciliate epithelium* (Fig. 16 *D, E*) has numerous small ones. Cilia are more common in the lower groups of animals, but are found even in mammals, in the moist internal passages, as in the nose, trachea, etc.

Membranes bounding the body cavity are called *serous membranes (endothelium)*. The lining of the digestive tract is described as a *mucous membrane*.

Epithelial cells often secrete upon their outer surface a layer of material (*cuticula*), which serves to protect the cells beneath and the organism as a whole from external influences (as the covering of the cray-fish). From the epithelium arise various outgrowths, as scales, hair, feathers, and the like.

**70. Glandular Epithelium.**—The ordinary columnar or pavement epithelium may here and there present cells or areas of cells which are specially active in producing and pouring out on their free surface certain materials, called *secretions*. In its simplest form the *gland* or secreting surface may consist of a single cell, as the *goblet* or *slime cells* (Fig. 17, *a*).

Such a cell may become much enlarged and sink below the general level of the epithelium, retaining in the meantime a narrow connection with the exterior (Fig. 17, *b*). Multicellular glands represent areas of such cells which have sunk below

FIG. 21.

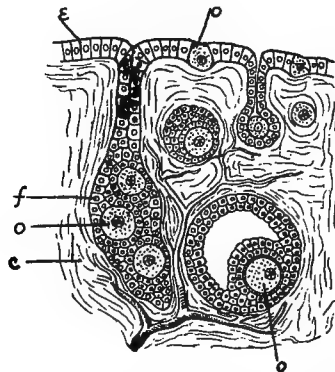


FIG. 21. Section through ovary of a young Mammal (modified from Wiedersheim). The eggs (*o*) are seen to be formed from the epithelium by a process somewhat more complex than in Fig. 18. *c*, connective tissue of ovary; *e*, epithelium; *f*, follicle of epithelial cells in which the ova ripen; *o*, ova in different stages of ripeness.

**Questions on the figure.**—In the ovary of the mammal what additional service does the epithelial layer render the ovum after its formation? Is it apparent that there is anything gained by the sinking of the ovarian follicles into the tissue of the ovary, instead of escaping immediately, as in Fig. 20?

the surrounding surface, forming a tube- or flask-shaped cavity, which may become very much branched. Glands with such branched *ducts* are described as *compound*. They consist of numerous final secretory sacs communicating by *ductules* with a common duct or outlet to the surface. Transitional conditions between the simple secretory epithelium and the compound gland may be seen in Fig. 18.

**71. Sensory Epithelium.**—In the lower animals there may be found here and there over the surface of the body modified epithelial cells, which are specially capable of being stimulated by contact or other stimuli to which the organism may be exposed. Likewise in higher forms we find highly specialized areas of sensitive

cells, which can be shown to belong primarily to the epithelium. These are the end organs of special sense, as touch, sight, and the like, and they get their special value from their connection with what will be described presently as the nervous tissues of the central nervous system. The sensory cells are typically spindle-like or even hair-like in form, often extended as fine fibres at the inner end, whereby connection is established with the nerves (Fig. 19, A).

**72. Reproductive Epithelium.**—The sexual cells, both male and female, arise from epithelium, ectodermal, entodermal, or, as is usually the case, mesodermal. The budding of the sexual epithelium, in the development of the germ cells, suggests the formation of glands (Figs. 20, 21). The sexual cells often develop at the expense of the epithelial and other cells about them. It will be recalled that the primordial sex cells, from which the reproductive epithelium and other essential parts of the reproductive organs are derived, were set apart in the early life of the individual (see §49).

**73. Supportive or Connective Tissues.**—This class of tissues embraces the bulk of the non-active tissues in animals. They vary much in appearance and structure, agreeing in little except in their mesodermic origin, their passivity, and in the preva-

FIG. 22.

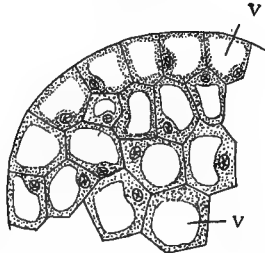


FIG. 22. Cellular Connective Tissue, showing large vacuoles, *v*, in the protoplasm.

**Questions on the figure.**—Would you say that these cells are of a high or a low order of differentiation? Why? Is there any intercellular substance? Where is tissue of this kind found? (See reference texts.)

lence of intercellular substance. The intercellular substance gives the distinctive character to the connective tissues, the cells having a relatively unimportant place after the production of the intercellular substance. The general function of the supportive tissues is to bind and sustain the more active tissues in their relations to the body as a whole. The classification of supportive tissues is based on differences in the intercellular substance. This may be fluid (as in blood) or solid (as in bone); it may be homogeneous (as in some forms of cartilage), or

fibrous; it may be almost wholly organic, or very largely inorganic. The principal classes are *cellular connective* tissues, *gelatinous connective* tissue, *fibrous connective* tissue, *cartilaginous* tissue, and *osseous* tissue.

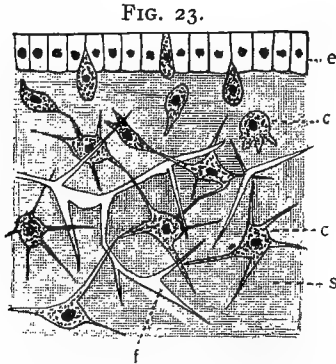


FIG. 23. Gelatinous connective tissue, showing stellate cells (*c*), epithelium (*e*), the gelatinous intercellular substance (*s*), and the intercellular fibres (*f*).

**Questions on the figure.**—What seems to be the relation of the epithelial layer to the tissue below it? What classes of cells are found in the gelatinous tissue? What is their origin? What is the nature of the intercellular substance? Are the fibres cellular or intercellular?

74. **Cellular or Vesicular Tissue** forms an exception to the general rule of abundant intercellular substance. It is an embryonic tissue,—a forerunner of the more permanent tissues,—and is chiefly interesting from that fact. The cells have large vacuoles or vesicles which are enveloped by a thin layer of protoplasm (Fig. 22). It is found in the notochord of vertebrates.

75. **Gelatinous tissue** has a matrix of intercellular substance enveloping stellate cells, the radiating projections of which serve to connect them. Fibres are often developed in the matrix. This tissue is abundantly found in the jelly-fish (see Fig. 23).

76. **Fibrous connective tissue** has in its ground substance a rich supply of fibrils variously arranged. The cells or corpuscles are often elongated and branched. If the intercellular fibres cross, running in various directions, a loose yielding tissue results, as in the ordinary connective tissue about the muscles and nerves (Fig. 24, *A*); if the fibres are parallel the tissue naturally becomes more compact. There are two types of the more compact sort differing in the quality of the fibres. The latter may be *white* and *inelastic*, as in tendons, or *yellow* and *elastic*. Fat is frequently deposited as spherical drops of oil (Fig. 24, *B*) in the cells of connective tissue.

77. **Cartilage.**—In cartilage the intercellular matrix is much firmer than in those tissues already described. It may appear homogeneous as in rib cartilage

(Fig. 25, A); or it may contain numerous fibres which give coherence and elasticity. The cells are usually rounded except where they have been flattened by mutual

FIG. 24.

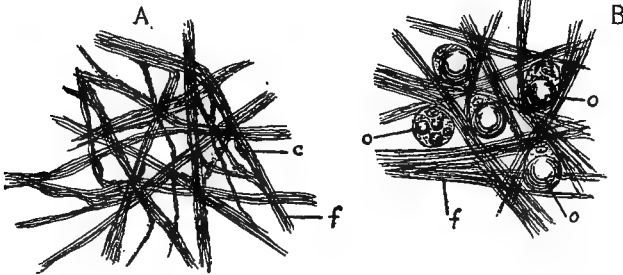


FIG. 24 Fibrous connective tissues. A, ordinary connective tissue found binding muscle and nerve fibres, showing the fibrous intercellular substance. The cells (*c*) are never conspicuous in this tissue. B, adipose connective tissue showing fat-laden cells among the fibres (*f*). *o*, oil droplets in the cells.

**Questions on the figures.**—In these two types of tissue which element gives special character to the tissue, the cells or the intercellular substance? How would the deposition of large drops of oil in the cell affect the activity of the cell? Why? Why are fatty deposits less hurtful amid connective tissue than elsewhere in the body?

FIG. 25.

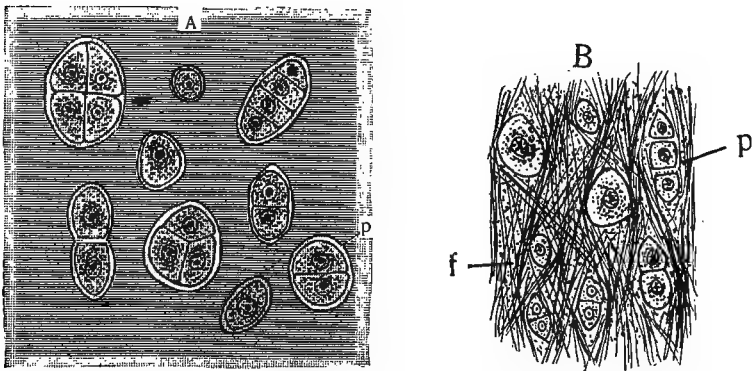


FIG. 25. Cartilage. A, Hyaline cartilage; B, fibrous cartilage. In the latter a large portion of the intercellular substance is conspicuously fibrous. The cells occur in pockets (*p*) in the matrix; *f*, intercellular fibres.

**Questions on the figures.**—What are the points of similarity and of difference in the two types of cartilage? In what manner do the multicellular pockets arise? What is the nature and origin of the intercellular substance in each case?

pressure, and usually occur in pockets in the matrix. Cartilage is bounded on its free surfaces by a fibrous membrane, the *perichondrium*. This membrane assists in the growth of the cartilage. There are no blood capillaries in cartilage.



Salts of lime may be deposited in the intercellular substance, giving it some of the qualities of bone.

**78. Osseous or Bony Tissue.**—These tissues are found only in vertebrates, and are the most complicated of the supportive tissues. The firm matrix which is secreted by the bone cells consists of a mixture of organic substance and inorganic matter, especially the salts of lime. The cells with their fine filamentous branches occur more or less regularly between thin plates or *lamellæ* of the bony material. A cross-section of one of the long bones shows the typical condition. The *periosteum* is a superficial fibrous membrane about the bone, well supplied with blood vessels. Its inner layer of cells is capable of producing bone. Within this is a region of firm bone, in which a series of lamellæ are parallel with the surface of the periosteum. Between the lamellæ occur the spaces (*lacunæ*) occupied by the bone-cells which have been left behind as the matrix was deposited. Deeper in

FIG. 26.

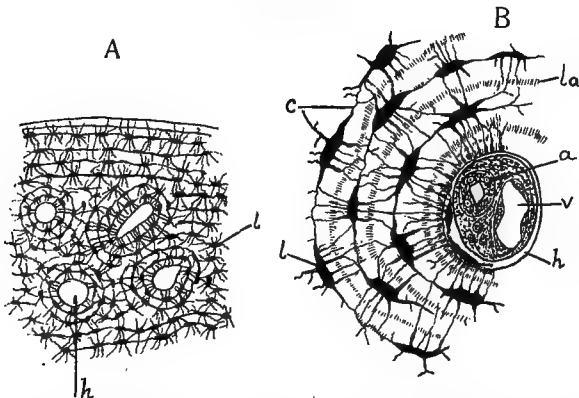


FIG. 26. *Bony Tissue.* A, portion of cross-section of a bone, the upper portion of the figure representing the outer surface of the bone, just beneath the *periosteum*. The open spaces, *h*, are *Haversian canals*; *l*, *lacunæ*, occupied in life by bone cells. The minute canals through the bone connecting the lacunæ are *canaliculi*. B, a portion of one *Haversian system* much magnified. *h*, *Haversian canal*, containing artery (*a*), vein (*v*), lymphatic spaces, nutritive cells; *c*, *canaliculi*; *l*, *lacunæ*; *la*, plate of bony intercellular substance.

**Questions on the figures.**—How does bone compare in appearance and structure with the other supportive tissues? What is the really living part of bone? How is its intercellular substance laid down? How are the cells in the bone nourished? How do they come to lie in the solid bone? What changes occur in this type of tissue with age? What is the function of the *Haversian canal*?

the bone the lamellæ and cells are in concentric layers about the numerous blood vessels (occupying spaces known as *Haversian canals*) which penetrate the bone, chiefly in a longitudinal direction. The included bone-cells communicate with each other and with the blood vessels by processes which occupy minute canals (*canaliculi*) in the intercellular substance (Fig. 26). Within this region and immediately surrounding the central cavity of the bone is often a mass of spongy bone in which the regularity of arrangement of the cells is lost. Bone may be formed by replacing cartilage, or wholly independent of it.

FIG. 27.

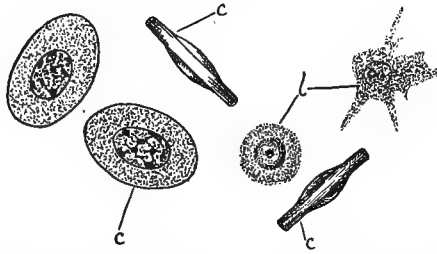


FIG. 27. Blood corpuscles (amphibian). *c*, colored corpuscles, flatwise and in profile; *l*, colorless corpuscles (*leucocytes*).

FIG. 28.

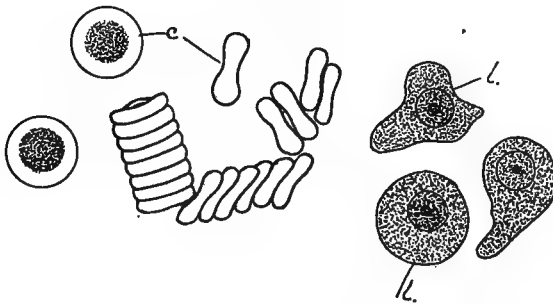


FIG. 28. Blood corpuscles (human). *c*, colored; *l*, leucocytes. The red cells tend to collect in rows with the sides in contact.

**Questions on figures 27 and 28.**—Compare—by means of the figures, the text and reference books—the colored and colorless corpuscles of these two types of vertebrates and note the differences. In what other respects do the colored cells differ from the white? Which are the less highly differentiated? Reasons for your view? Why are the colorless corpuscles also called *phagocytes*?

Dentine and enamel, though differing in structure from bone, are to be looked upon as belonging to the same class of tissues. They differ chiefly in the fact that no cellular elements are included in the secretion. They are thus harder and denser than bone.

79. We find all stages of transition between the more simple and more complex supportive tissues, and it may be seen furthermore that there is a fundamental embryological sequence. In the development of the organism the simpler connective tissues give place, by transformation or substitution, to the more complex. The cellular connective tissue of early life is replaced, for example, by cartilage, and this may be transformed into bone in adult life.

80. **Nutritive Fluids.**—The body fluids known as *blood* and *lymph* are frequently classed among the supporting tissues, the fluid portion being regarded as the intercellular substance and the corpuscles as the cells. They differ however from the ordinary tissues in the important fact that the intercellular substance is not produced by the cells. In the vertebrates these cells are of two kinds, the *amaboid* or *colorless* and the *colored*. Both kinds occur in the blood; the colorless alone are found in the lymph. The colored corpuscles are relatively numerous and are disc shaped. Regarded as cells they present a series of degenerative changes which results in a loss of the distinctively protoplasmic character, by the substitution of certain proteid substances, one of which—hæmoglobin—is notable for its affinity for oxygen. The degeneracy may go to the extent of the entire loss of the nucleus, as in the mammals. The colorless cells have the power of independent motion such as is found in the amœba, and may ingest solid particles of food. The body-fluids of the invertebrates contain as a rule only colorless corpuscles, and are therefore more like the lymph of the vertebrates. When their blood is colored it is usually from pigment in the *plasma* or fluid portion of the blood. In addition to the cells the blood carries a rich supply of proteid and other substances for use in the tissues, of secretions from the various ductless glands, and of waste products in process of removal from the body.

81. **Muscular Tissue.**—The remaining tissues are characteristically active. Muscular tissue by its contractility has the power of producing movements of the parts to which it is attached. This contractility of muscle may be looked upon as a specialization, and a limitation *in direction*, of the power of contraction which we have seen to be resident in all living protoplasm. Muscular tissue differs somewhat in structure and degree of differentiation in various animals, but in general agrees in the presence of elongated fibres which are to be considered as modified cells or parts of cells. The contractile muscle substance is, in part at least, a plasmic product rather than mere protoplasm; yet it differs from the intercellular substance of the tissues already described in that it is deposited within rather than among the cells.

Two stages in the differentiation of muscular substance are to be noted: (1) the fibres may be *plain*, in which case we find elongated, contractile single cells without conspicuous external differentiation (Fig. 29); (2) *cross-striate* fibres, which always show conspicuous differentiation of parts in each fibre as seen under the microscope. The plain fibres are characteristic of sluggish animals, and those parts of animals whose muscular action is least prompt in response to the nervous stimuli (*e. g.*, digestive tract in vertebrates). The cross-striated fibre usually

represents several incompletely separated cells, or a multinucleate condition of a much-grown and metamorphosed single cell. In both classes the fibres are made up of numerous minute strands or *fibrillæ* which in the plain muscle are homogeneous throughout, but in the cross-striated are made up of alternating segments of lighter and darker optical appearance (Fig. 30, *B*).

FIG. 29.

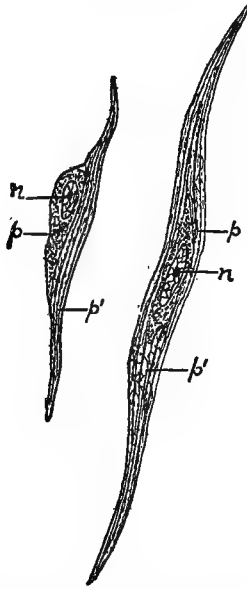


FIG. 29. *Plain muscle fibres.* *n*, nucleus of muscle cell; *p*, undifferentiated cell protoplasm; *p'*, the differentiated contractile portion of the cell.

**Questions on the figure.**—What are the two principal portions of these cells? How do very young muscle cells compare with older ones in the relative amount of these portions in the cell? Which is the more highly differentiated portion? Where are such tissues found in the animal body? Why are muscle fibres elongated?

The undifferentiated protoplasmic remnant is often very small in amount, and is collected about the nucleus (Figs. 29, 30). It may be at the surface of the fibre or in the center, enveloped by the contractile matter. A thin membrane (*sarcolemma*) binds the fibrillæ into fibres. The fibres are bound together by strands of connective tissue into bundles, and of these bundles the muscle is made up.

FIG. 30.

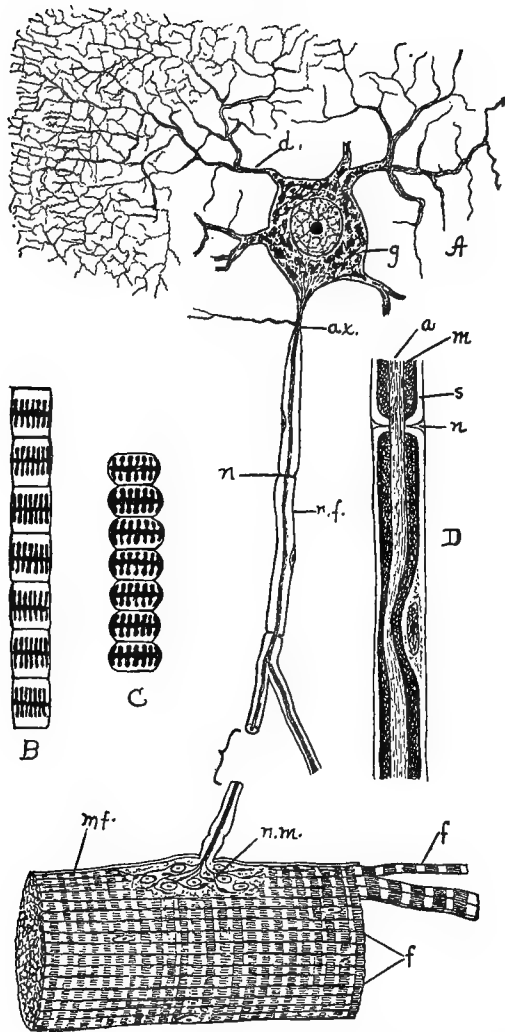


FIG. 30. Diagram of nervous and cross-striate muscular tissue, showing the mode of connection between nerve fibres and muscle fibres. *A*, nerve cell (*g*) connected with muscle fibre (*m.f.*) by nerve fibre (*n.f.*). The muscle fibre (*m.f.*) is composed of numerous fibrils (*f*) which are made up lengthwise of alternating discs of lighter and darker substance. These fibrils are shown more highly magnified in *B* and *C*. In *B* the fibril is uncontracted; in *C* it is contracted. *D*, nerve fibre more highly magnified showing *a*, axis; *m*, medullary sheath; and *s*, Schwann's sheath; *ax.*, axon; *d*, dendron; *n*, node; *n.m.*, nerve-muscle plate.

82. **Origin of Muscle Tissue.**—In those animals in which a true mesoderm is wanting, the epithelial cells may develop, at their inner extremity, contractile roots, either plain or striate (Hydra, Fig. 19, *B*). These cells may wholly lose their epithelial quality and position and become entirely muscular. In the higher animals this is very much modified by the early appearance of separate mesoderm from which the whole muscular system is derived.

83. **Nervous Tissue: its Functions.**—The nervous tissues are in close relation on the one hand to the sensory epithelium and on the other to the muscular tissue. Through the former they receive the stimuli from the outside world; by means of their connection with the latter they are enabled to effect responses. The reception of stimuli, the transmission of the results of stimulation, and the initiation of appropriate responses constitute the fundamental work of nervous tissue (Fig. 30, *A, D*). In some of the lower Metazoa the same cell may do all these tasks.

84. **Structure.**—The principal elements of nervous tissue are the *nerve-cells* (*ganglion-cells*) and *nerve-fibres*. The cells, which are the centres of nervous activity, are usually large with conspicuous nuclei. The fibres are, in their essential parts merely outgrowths of the ganglion-cells. These outgrowths are of two sorts: the *dendron*, which is a much, and irregularly, branched structure; and the *axon*, or nervous fibre proper. The ganglion cell with its dendrons and axons make up a *neuron*. It is believed that the whole nervous system even in the higher animals is merely a system of neurons in connection. The impulses can go in only one way: into a cell by way of dendrons and out of it by way of axons. From the axon of one cell they may pass to the dendron of the next; but not in the opposite direction. Each cell may have one or more processes arising from it. These fibres may pass just as they arise from the cells, without special structural modification, to their connections. Such are called *non-medullated* or gray fibres. There are usually however one or more protective sheaths formed about this essential *axis*: (1)

**Questions on Fig. 30.**—What are the principal points of contrast between the plain and the cross-striate muscular fibres? Enumerate the principal regions of the nerve cell figured. How does it differ from a typical cell in form? What are the principal parts of the nerve-fibre (*D*)? What are the supposed functions of these various portions? Why is it necessary for nerve cells to be in connection with other kinds of cells? What are the differences between the contracted and uncontracted muscle fibre (*B* and *C*)? What is meant by a *neuron*?

the *medullary* sheath, consisting of a framework filled with a fatty material, surrounded by (2) Schwann's sheath, a homogeneous sheath with occasional nuclei along its course (Fig. 30, *D*). Fibres possessing the medullary sheath are called *medullated* or white fibres.

A nerve cell together with its processes is called a *neuron*. The whole nervous system may be considered as made up of such units, which connect with each other by the delicate terminal branches of the outgrowths. See Fig. 36.

**85. Origin of Nervous Tissue.**—Nervous tissue always arises from the ectoderm of the embryo, so far as we know. In some of the lower forms of animals, as the Coelenterata, the nervous cells may be derived individually from the epithelium. In such instances they have a close connection with those muscle elements which are also of epithelial origin (see § 82). In the higher forms the origin of the nervous matter from the ectoderm is somewhat less direct but essentially similar. The connection of the nervous centres with the muscles and glands, etc., in the higher animals is a secondary condition and is the result of the growth of the nerve fibres from the centres toward such organs. What directs their growth to the right place when the fibres begin to grow, we do not know.

### 86. Summary.

1. The individual becomes complex by the increase of the number of cells, and by their differentiation.

2. A tissue consists of a group of similar cells with their products, which are adapted to the performance of special work or function.

3. Tissues differ morphologically in respect to the form, arrangement, and structure of the cells, and in the amount, arrangement and consistency of the intercellular substance.

4. Physiological differentiation accompanies the morphological, the division of labor becoming very complete in the higher forms. The physiological value of a tissue may depend either upon the cells or the intercellular substance.

5. Tissues may be classified as follows:

A. The vegetative or passive tissues.

I. Epithelial:—

function:—protection, absorption, secretion, sensation, reproduction, etc.

kind:—pavement, columnar, ciliate, glandular, sensory, muscular, reproductive, etc.

II. Supportive or connective:—

function:—binding, support, protection.

character:—abundant intercellular substance.

form:—vesicular, gelatinous, fibrous, cartilaginous, osseous, nutritive (blood and lymph), etc.

B. The active tissues.

III. Muscular:—

function:—irritability, especially to nervous stimuli; contraction in a definite direction.

form:—plain and cross-striate (depending on the differentiation of the contractile substance.)

IV Nervous:—

function:—reception of general stimuli, transmission of impulses, interpretation, and the initiation of appropriate responses.

form:—central cells (ganglion) with fibrous branches (axon, dendron).

6. The epithelial tissues arise from ectoderm, entoderm and mesoderm; the connective tissue, from mesoderm; the muscular, chiefly from mesoderm; and the nervous tissue, from ectoderm.

**87. Exercises for the Laboratory** (these may be made as extensive as time and facilities will allow).

1. Temporary demonstrations of the simpler tissues may be made by teasing out with needles small portions of the appropriate material in a drop of water on the slide.

(a) *Blood*.—Compare that of earth-worm or insect, frog, man. Place a drop of fresh blood on the slide, and cover. Examine at once. Permanent preparation of the blood of the frog, stained to show nucleus of corpuscles are valuable.

(b) *Epithelium*.—Mesentery of cat; film shed from skin of frog kept a few days in captivity; cells scraped from the esophagus of a recently killed frog.

(c) *Connective Tissue*.—Found surrounding muscle, *i.e.*, lean meat. Compare tendon.



(d) *Muscle*.—From wall of stomach, from heart, from skeletal muscles.

(e) *Nerve Fibres*.—Small portion of nerve of frog or cat.

2. Permanent mounts of sections of cartilage, bone, and tooth showing dentine and enamel are essential. Properly stained preparations of glandular tissue, of nerve cells and their branches, and of reproductive epithelium (see appendix), will greatly assist the pupils in securing an accurate idea of these tissues and their work.

## CHAPTER VI

### THE GENERAL ANIMAL FUNCTIONS, AND THEIR APPROPRIATE ORGANS

88. **Protoplasmic Functions.**—It has already been stated that in protoplasm reside the fundamental powers belonging to living things. Through its agency all the vital processes are performed. Through the activity of its ferments, foods undergo changes that prepare them to be used in the manufacture of protoplasm and other complex cell-substances. It alone has the power to assimilate or build up these foods into the living state. In protoplasm occur the oxidation and other chemical changes which result in the manifestation of energy, as heat, motion, light, etc., accompanied by the formation of waste products which are to be eliminated. The power of receiving and responding to surrounding influences, which we have called irritability and contractility, is likewise a power of protoplasm. Out of these powers arises the possibility of organisms becoming adapted to their surroundings. It is not yet possible certainly to localize all these functions within the individual cell, although it seems probable that in some degree even such protoplasm as is found in the *Amoeba* has localized functions. In many single-celled animals there is a considerable localization.

89. **Division of Labor.**—As the protoplasmic units, *i.e.*, the cells, increase in number by cell division and form large masses, the different cells are no longer subjected to the same influences, and are not equally favorably situated for the performance of all the original functions. The protoplasm of *all* cells retains the power of using food and of building up their own substance, but we find certain activities largely given over to special groups of cells; *e. g.*, secretion is specially noticeable in some, contractility in some, and irritability in others. This division of labor, is accompanied by a corresponding differentiation of structure which constitutes an adaptation to the special work to be done,

and is of great advantage. We have described these structure-groups as *tissues* (see Chapter V).

90. **Organs.**—The tissues which have been described are never independent, but are associated with each other in the performance of a common function, to form an *organ*. In each organ there is usually a principal tissue which determines its function (as muscular tissue in muscle, or the glandular tissue in glands), and one or more accessory tissues for support or control (as connective or nervous tissue in the organs mentioned). To accomplish some of the activities, in the higher animals especially, several organs of a similar kind must work together. These are sometimes spoken of collectively as *systems of organs*, e.g., digestive system, circulatory system, and the like.

91. **Classification of the Systems of Organs and Functions.**—The work that needs to be done by an organism may be considered under the following heads: (1) metabolism—including digestion, circulation, respiration, assimilation, and excretion; (2) protection and physical support; (3) growth; (4) reproduction; (5) movement; (6) sensation. Eight systems of organs may be distinguished by which this work is done. They are (1) the digestive; (2) circulatory; (3) respiratory; (4) excretory; (5) skeletal and integumentary; (6) reproductive; (7) muscular, and (8) nervous.

92. **Metabolism (Nutrition).**—Metabolism embraces two sets of processes, (1) constructive or *anabolic*, known as assimilation, and (2) destructive or *katabolic*. By constructive we mean all the building-up processes in the organism which result in the storing of food and energy, in growth, repair, and reproduction. We class as destructive all those processes by which the complex cell substances are broken down or rearranged, and energy set free, leading to change of temperature, to nervous or muscular action, to secretion and excretion. In the higher animals the nutritive process is a very complicated one and demands the coöperation of numerous organs. It embraces the *ingestion* or taking in of food; the *digestion* of food; its *absorption* from the digestive tract into the body fluids—blood

and lymph; and its *transportation* in these systems, which is made necessary by the fact that digestion is confined to a special region. It likewise includes the further absorption of these materials from the blood and lymph by the cells for whose benefit all the preceding work has been done; the assimilative process within the cell whereby the food material is made into protoplasm or other complex cell-products; the reception and transmission of oxygen, by the combining power of which (*oxidation*; see §26) these complex substances are broken down into simpler ones—useful, useless, or hurtful to the animal economy. Finally, the elimination of the products of this oxidation or burning is a necessary part of the nutritive process. If the material eliminated from the cell is of further use the process is known as *secretion*; if not, *excretion*. It is undesirable to attempt to make a sharp distinction between excretion and secretion. Most so-called secretions are really excretions from the point of view of the protoplasm which produces them.

93. **The Digestive System.**—The simplest condition of the digestive tract is found in the gastrula (*archenteron*, Fig. 13, 4) or in Hydra (Fig. 81). Here there is only one cavity in the body and the food is taken up immediately by the cells needing it. A simple modification of this condition is seen in Fig. 31. A still more complicated condition is shown in Fig. 95. In this form which we may take as the type, the digestive tract is a tube, running through the body, lined with its own epithelium and is separated from the body wall by the *calom* or body cavity. The tube itself may have any degree of complexity, but consists essentially of (1) an anterior portion (*stomodæum*) lined with ectoderm, (2) a posterior portion (*proctodæum*) also lined with ectoderm, and (3) a middle portion (*mesenteron*) lined with entoderm. The stomodæum or mouth region is usually supplied with devices for the capture and ingestion of the food. The mesenteron is the true digestive region. It is supplied with cells which secrete materials that act upon foods in such a way as to render them capable of being absorbed through the entodermic cells into the body cavity, or into that special portion of it known

as the circulatory system. Pouches and outgrowths from the wall of the mesenteron are of common occurrence. These serve to increase the glandular or secreting surface and the absorbent surface, and also to retain the food longer in contact therewith by retarding its passage through the canal. The removal of the digested food from the canal may be effected by absorption or by the active engulfing of food by the entodermal cells, much as is done by the amoeba.

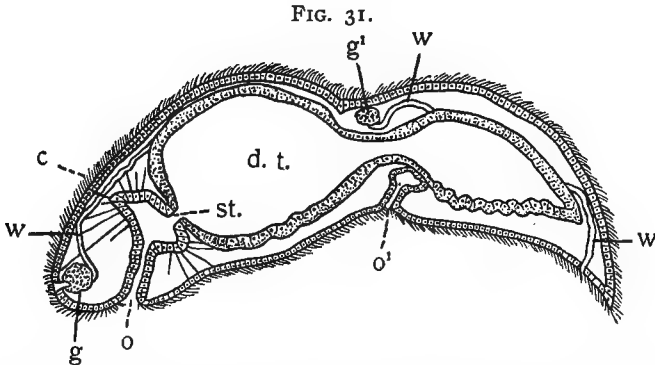


FIG. 31. *Stenostoma* (after Hertwig). In this Turbellarian the digestive tract (*d.t.*) is a blind sac. *st.*, boundary of stomodæum and mesenteron; *c*, cilia; *g*, ganglion (brain); *g'*, ganglion of a new individual which is being formed by fission; *o*, mouth; *o'*, mouth of new individual in process of formation; *w*, excretory system.

**Questions on the figure.**—How much of this digestive tract is lined with ectoderm? Which portion with entoderm? Is there a proctodæum? What are the evidences that the worm is in process of division? Compare this digestive tract with those in Figs. 81, 87, 95, 101.

94. **The Respiratory System and Function.**—In addition to its other food requirements, all protoplasm, in proportion to its activity, must have free oxygen. This is obtainable from the air or from the oxygen dissolved in water. Oxygen, being a gas, must enter the system in a somewhat different way from that by which liquids and solids are ingested. It is best obtained by absorption through moist, thin-walled membranes. Such surfaces, in connection with which blood vessels are usually found, constitute the *respiratory organs*. Any exposed surface meeting these requirements may serve as such. The general surface of all animals is respiratory in some degree. In the more complex animals, however, special additional

organs must be provided. This may be effected by thin *out-growths* of the body surfaces, which are especially adapted to water forms and are called *gills* or *branchiæ* (Fig. 32); or a similar increase may be attained by pits or *ingrowths* of the body surface, suited to get oxygen from the air. Such are called *lungs* or *tracheæ* (Fig. 33). Carbon dioxide, a gaseous waste product resulting from the union of oxygen with carbon

FIG. 32.

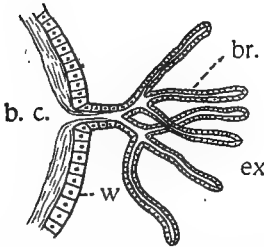


FIG. 32. Diagram illustrating gills or branchiæ. *b. c.*, cavity in which the body fluids circulate; *br.*, branchial filaments which are merely much thinned out-pocketings of the body wall (*w*); *ex.*, the external medium—water—in which the oxygen is dissolved.

**Questions on the figure.**—What are the essential features of gills as suggested by this figure? Why are they better suited to water than to air?

FIG. 33. Diagram illustrating lungs or tracheæ. *b. c.*, the cavity in which the body fluids circulate; *l.*, the walls of the lung, which are much thinned in-pocketings of the body wall (*w*); *ex.*, the external medium—usually the atmosphere—in which the oxygen is found.

**Questions on the figure.**—What are the essential features of lungs as suggested by the figure? Why are such organs better suited to aerial than to aquatic life? In what respects are gills and lungs better than the mere body-wall for the exchange of the gases?

which takes place in the tissues, is economically eliminated by the same organ which admits the oxygen, inasmuch as the entrance of one gas is not retarded by the outward passage of the other. This double process constitutes *respiration*, although the latter half is also appropriately described as *excretory*. The surface devoted to the exchange of the gases and the special devices necessary to renew the air or water make up the *respiratory system*. The respiratory organs are frequently associated with the anterior or posterior end of the digestive tract. As in

the case of other necessary substances, the blood is the usual vehicle by which oxygen is distributed from the gills or lungs to the parts of the body needing it. The student will realize that this is only the first step in respiration. The real respiration takes place in the protoplasm of the individual cells.

**95. The Circulatory System and Function.**—In such conditions as are shown in Fig. 81, there is no circulatory system. The digested food is merely distributed from cell to cell. In animals in which the digestive apparatus is well developed,

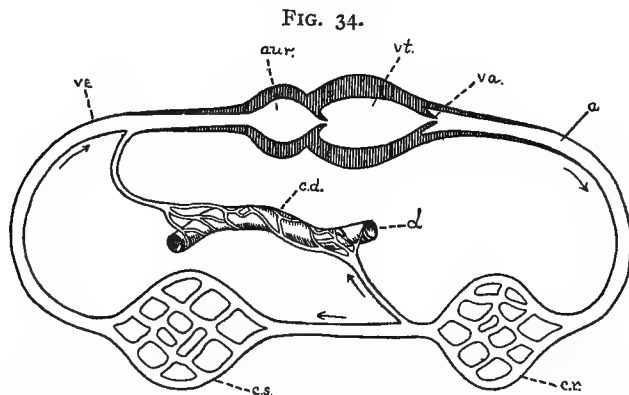


FIG. 34. A scheme to represent the circulation of the blood, in its essential features. The arrows indicate the course of the blood. *a.*, arteries; *aur.*, auricle or receiving portion of the heart; *d.*, digestive tract; *c. d.*, capillaries of the digestive tract; *c. r.*, capillaries of the respiratory organs; *c. s.*, capillaries of the system; *va.*, valves; *ve.*, veins; *vt.*, ventricle.

**Questions on the figure.**—What portions of the apparatus are necessary to secure circulation? Which secure the real objects for which the circulation exists? Why are valves essential? What common work occurs in the three classes of capillaries figured above? What special type of work is characteristic of each of the three?

some device becomes necessary for the distribution of the food. The body cavity with its contained fluids may do this work as in Fig. 31. Usually, however, when the mesodermal layers become well developed, there arises in connection with it a series of branching tubes containing special fluids, blood or lymph. These tubes by their ramifications connect the digestive surfaces with the various parts of the body. Some branches likewise extend to those special surfaces where the oxygen of the external medium may be had. Naturally then the complexity

and the special structure of the circulatory system depend largely upon the position and degree of development of the digestive and respiratory organs. In order to secure the necessary motion of the fluids contained in the tubes, the walls of the latter are supplied with muscular fibres, and contract more or less rhythmically. If the motion is to have a definitely continuous direction, as is ordinarily the case, valves are usually so placed that motion in the opposite direction will be impossible. The (one or more) contractile regions are called *hearts*; vessels conducting blood from the heart are *arteries*, those carrying blood toward the heart, *veins*. In the region where the vessels are smallest and have very thin walls, the exchanges between the blood and the other tissues occur. This is the region of *capillaries*. The blood system has capillaries in the walls of the digestive tract, in the respiratory organs, in the kidneys, in the liver, and in and about all the tissues receiving a direct blood supply. The capillary region is that for which the rest exists; it is the physiologically important part of the system. Fig. 34 illustrates the arrangement of parts found in a common type of circulatory apparatus.

96. **Demonstration.**—Circulation of blood in tail of tadpole; in the web of the foot of a frog; or in the fin of small fish. Distinguish veins and arteries. Notice behavior of corpuscles in passing through small capillaries. Compare rate of flow in vessels of different size.

97. **The Excretory System and Function.**—Beside the carbon dioxide eliminated from the blood in the lungs or gills, other waste products of oxidation are to be removed from the tissues where they are produced. Important among these are the nitrogenous wastes, *urea* and *uric acid*. In organisms in which there is no regular blood system, these waste products may be carried directly from the tissues to the surface by a system of tubes beginning as capillaries. In the majority of animals the canals (*nephridia*) pass from the body cavity to the exterior. These are seen in a simple condition (Fig. 35) in the segmented worms. For a more unified condition see unsegmented worms (Figs. 88, 89). The kidneys of higher forms are considered to be derived from these. In the higher animals the kidneys



have a special blood supply and the waste products are extracted from the blood while it is in the kidney.

98. **The Skeletal System and its Functions.**—The cells of the body frequently excrete from themselves materials which, while no longer of use to the protoplasm, are not entirely removed from the body by the blood and serve important passive functions. These excretions or secretions may surround and protect and give rigidity to the cell itself (*e.g.*, cell-walls; shells in the single-celled animals), may bind the softer cells to-

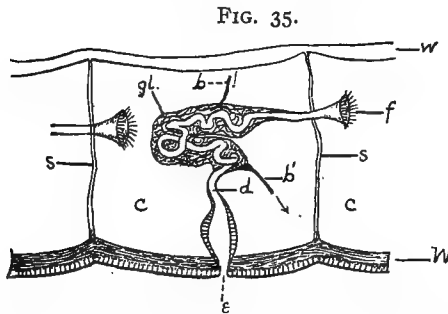


FIG. 35. Diagram of a *nephridium* (simple kidney tubule) of a Segmented Worm. *b.*, *b'*., blood vessels; *c.*, coelom; *d.*, duct of the nephridium; *e.*, external opening; *cf.*, ciliated funnel opening into coelom; *gl.*, glandular or secreting portion; *s.*, septum; *W.*, body wall composed of longitudinal muscle fibres, circular fibres, and epithelial layer; *w.*, wall of gut.

**Question on the figure.**—Judging from its relation to the coelom, to the blood vessels, and to the outside world what would seem a reasonable function for the nephridium?

gether into a resistant tissue (intercellular substance in bone, etc.), or may be secreted at the surface of the organism as a whole (cuticula in insects and shell in mollusks). The hard parts serve primarily for the support and protection of the softer tissues. Incidentally they come to serve a very important use as points of attachment for muscles. The skeleton may be external (the *integumentary* skeleton, or *exoskeleton*) as in crayfish, or internal, as the *endoskeleton* of vertebrates. In many instances both kinds of skeletal structures may occur simultaneously, yet it is usually true that if the exoskeleton is well developed the endoskeleton will be poorly represented. Each has important advantages and limitations. To allow motion as the result of muscular action the skeleton, if rigid,

evidently must be in segments and jointed. The articulation, or joint, is as important for motion as the harder parts. Clearly the muscles, to do any work on the skeleton, must attach on opposite sides of the joint.

99. **Growth.**—There are no special organs of growth, yet growth is one of the most immediate and important manifestations of the nutritive process. Growth is to be defined as increase in volume or mass and may result from either or all of three processes: viz. (1) absorption of water, (2) formation of new protoplasm and the multiplication of cells, and (3) formation of non-protoplasmic cell-products, either within or among the cells.

The rate and character of growth are modified by such external conditions as temperature, light, quantity and quality of the food supply, etc. Growth does not continue indefinitely. Its continuance is determined by the relation of the anabolic to the katabolic processes in the body. The time comes in the life of every complex organism where the income no longer exceeds the outgo, and growth must cease. Later still the wear is not made good by the income, and death results. Just what causes organisms to cease growing we do not know.

100. **Reproduction and the Reproductive Organs.**—Since individual organisms are limited both with regard to growth and length of life, it is apparent that a given species of animals cannot continue, unless some method of originating new individuals be found. This production of new individuals by the instrumentality of the old is *reproduction*. In many of the lower animals this is merely a growth process,—“growth beyond the limits of the individual.” In the single-celled animals reproduction means the separation of the protoplasm into two or more masses, by dividing into two equal parts (fission), by breaking into a large number of sub-equal portions (spore formation), or by *budding* (Chapter III, §40). In budding there is the formation of a local outgrowth which ultimately attains the size and character of the parent. In division the resulting individuals cannot be distinguished as parent and offspring. They are both offspring. Such reproduction, in-

volving only one parent is *asexual*. It usually occurs when the adult size of the animal is attained. It is not confined to the Protozoa or single-celled animals, but may occur in several Invertebrate groups in which (Hydra, Fig. 81) there is not a high degree of specialization. The budded individual or offspring may consist of one cell or of many. In addition to the internal stimulus afforded by the attainment of normal size, external conditions such as diminished food supply, temperature changes, etc., influence the process of non-sexual reproduction.

101. **Sexual Reproduction.**—There are some evidences that even in the one-celled animals the method of reproduction by division cannot be continued indefinitely without some ill effects to the organism. After a long series of divisions, a period of rest or a change of living conditions, or some other stimulus seems to be necessary to restore reproduction. In many Protozoa there is at certain times a union of two individuals, either temporarily or permanently, accompanied by exchange of nuclear material or by a fusion of the whole protoplasm. After a period of rest and the coming of favorable conditions of life, this union seems to renew activity of division. Something similar is seen in the more complex animals—the Metazoa. After a period of cell divisions, by which the individual body is built up, the majority of cells, as muscle or nerve cells, appear to lose their power of dividing, and even the less differentiated cells which we have described as the *ova* and *sperm*, which arise from the primordial germ cells (§49), are ordinarily incapable of continuing the division necessary to produce a new individual until they have been stimulated by union with each other (or by some artificial means). Such unions of cells, to form by later divisions a new individual, are called *conjugation* or *fertilization*, and the new individual which results is said to arise by *sexual reproduction*. The uniting cells may be similar (as in *Pandorina*), in which case the union is *isogamous*. More usually the cells are different, and the union is *heterogamous*. In the latter case the cells are called ovum and sperm (Chapter IV) and are usually formed in different individuals, though both classes of cells may arise (*hermaphroditism*) from different

regions of the germinative epithelium in one individual, or even in the same organ at different times. The special organs in which the ova are produced are called *ovaries*. The sperm cells are formed in *testes*. The individuals (that is, the *male* and *female*) producing the different classes of cells are often very different in other respects also. This is known as *sexual dimorphism* (Chapter VII, §149).

In many species of invertebrates, ova are capable of development without fertilization. This is known as *parthenogenesis*.

**102. Practical Exercises.**—Compare the males and females of the various animal types with which you are familiar. In what groups of animals does non-sexual reproduction occur? Give the gist of Geddes and Thompson's theory as to the origin of sexuality. What is the view based on the discoveries of Mendel? Compare any other theories available to you. What are the conceivable advantages and disadvantages of the asexual method? of the sexual? of hermaphroditism? of sexual dimorphism? Find illustrations of parthenogenesis. Why is it to be considered sexual?

**103. Movement and the Muscular System.**—The desirability of motion in animals arises from the necessity of seeking food and of escaping unfavorable influences. These conditions constitute the most imperious stimuli to which the organism is subject. We have already seen (§§20, 24) that the fundamental irritability and contractility of protoplasm make this response possible in the simplest conditions. In somewhat higher forms, specially developed protoplasmic fibrils appear, such as cilia, or the fibrils in the stalk of *Vorticella*, in which the power of contracting is strikingly manifest (see Figs. 68 and 70). While this is found in Protozoa, it is much more clearly shown in the muscular tissue (Fig. 30) of still higher animals. *Locomotion* varies in efficiency in different animals not merely on account of varying muscular structure but in accordance with the arrangement of the hard parts to which the muscle fibres are attached, and the nature of the medium which must be penetrated. Many aquatic forms, though free-swimming in their early stages, may become attached and give up the power of locomotion in the adult condition. Such attached or poorly moving forms ordinarily secrete an external shell or covering into which they can withdraw for protection (e.g., barnacles, many polyyps). They must depend upon cur-

rents in the water to supply them with food. They are frequently able to produce the currents by the motion of parts of the body. The majority of active movers have hard parts which serve as levers to which the muscles are attached. The parts of the skeleton, which may be either external to the muscles or surrounded by them, articulate with one another by a hinge or movable joint, as illustrated by vertebrates or insects. In some forms without a conspicuous skeleton, as the earthworm, there is a *dermo-muscular wall* surrounding a fluid-filled cavity. Locomotion is effected in these by the alternate use of the longitudinal and circular fibres, changing the relative position of the parts of the body. The special appendages, particularly the paired appendages, are important motor organs in nearly all actively moving animals.

104. **Sensation and Sensory Structures.**—In a simple bit of protoplasm it is manifest that the differences between the living matter and the outside world are greater than the structural differences between the parts of the protoplasm itself. Thus we would expect the stimuli arising from the action of environment upon the living material to be among the most vivid experienced by the organism, and that the superficial protoplasm by virtue of its *irritability* (see also §20) would most promptly feel and respond to such stimuli. The changes thus instituted will be felt sooner or later to the remotest parts of the cell mass. This transfer of the effects of a stimulus through a longer or shorter distance introduces us to a second nervous function,—*internal irritability* of protoplasm or *conductivity*.

105. As an organism increases in the number and variety of its cells, the specialized structures need to be more completely bound to one another. It becomes necessary not only that the animal receive impulses from such parts as are favorably situated for the reception of stimuli, but that a degree of *coordination* of the interrelated parts be secured, in order that just such response shall be made as will best meet the needs of the organism. This power of coordinated response to external stimuli makes it possible for an organism to become suited to its environment.

106. In the higher forms, the work above described depends on five classes of structures (see Fig. 36):—(1) *end* or *sensory organs*, which are specially sensitive to stimuli of different orders, as mechanical (touch), chemical, ethereal (light), etc.; (2) *conductive tracts* (*afferent nerves*), which connect (1) with (3) *central nervous structures* (*ganglion-cells*) where the impulse is received and suitable responsive impulses are originated; (4) *conductive tracts* (*efferent nerves*), which make the work of the central organs of value by carrying an impulse which produces

FIG. 36.

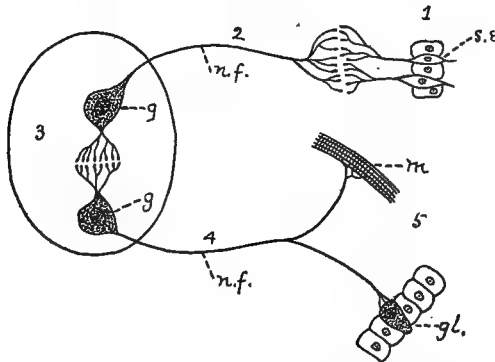


FIG. 36. Scheme showing the essential relations of the parts of a nervous system: 1, the sensory end organ (epithelial); 2, afferent nerve tract; 3, central nervous cells (ganglia); 4, efferent nerves leading to 5, muscle, gland, etc. *g*, ganglion cells; *gl.*, gland; *m*, muscle fibre; *n.f.*, nerve fibre; *s.e.*, sensory epithelium.

**Questions on the figure.**—What seems to be the function of the various parts or elements in this scheme? Your reasons for your view?

corresponding activities in (5), some form of actively related cells,—muscular, glandular, or nervous. It is readily apparent how increase of volume and differentiation of the other parts will make necessary a more complicated nervous system. The special arrangement of these parts of a complete system differs very much in various animal groups, yet it may be said that there is a progressive accumulation of the central nervous matter at the anterior end of the body as we ascend the scale of animal life. When this concentration is well advanced the mass of nervous matter is called the *central nervous system* which always includes the *brain*. The nerves passing to and from the central part and their endings, taken collectively, are described as the *peripheral nervous system*.

FIG. 37.

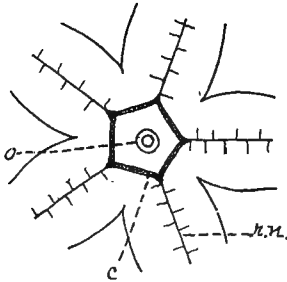


FIG. 38.

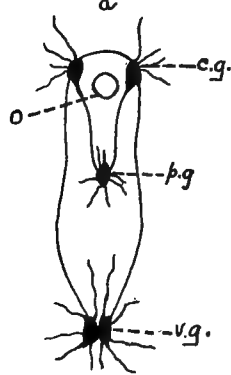


FIG. 37. Diagram showing arrangement of the nervous matter in Starfish. *c*, ganglionated ring about the mouth; *o*, mouth; *r.n.*, radial nerve in each arm.

FIG. 38. The nervous system of the Clam,—from the dorsal aspect. *a*, anterior; *o*, mouth; *c.g.*, cerebral ganglia (brain); *p.g.*, pedal ganglia; *v.g.*, visceral ganglia.

Questions on Fig. 37.—Describe in your own terms the way in which the principal nerve elements are arranged in the starfish? Compare it with those which follow. In what respects similar? In what unlike them?

FIG. 39.

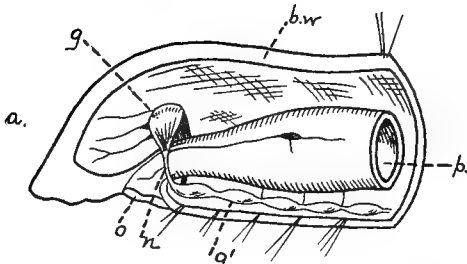


FIG. 40.

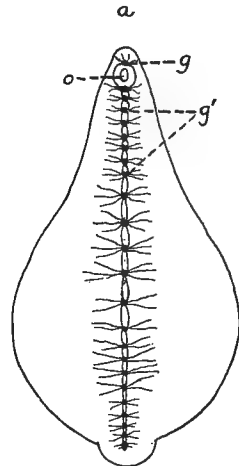


FIG. 39. Arrangement of the nervous material in the anterior end of an Oligochete Worm, seen in profile. That part of the body wall nearest the observer is supposed to be removed. *a*, anterior; *b.w.*, body wall; *g*, dorsal ganglia (brain); *g'*, ventral chain of ganglia; *n*, nerve ring around the pharynx; *o*, mouth; *p*, pharynx.

FIG. 40. The central nervous system in a Leech. Lettering as in Fig. 39.

Questions on figures 38, 39, and 40.—How is the nervous matter related to the digestive tract and to the animal as a whole in all of these figures? Compare with figures in other texts. Is there any apparent correlation between the form, symmetry or segmentation of the animal and the arrangement of the nervous material? Can you state your conclusion as a law?

107. **Arrangement of the Central Nervous System.**—The ganglion cells composing the nervous system may be so scattered through the superficial layers as scarcely to deserve the name “central” (*Hydra*). The nerve cells may be arranged in a ring about the mouth, or gullet, with or without additional bands of nervous tissue, containing cells, passing radially from it (as in echinoderms and some coelenterates; see Fig. 37). In the higher invertebrates this process of concentration continues and the ganglionic cells are collected into two or more *ganglia* connected by nerve fibres (*commissures*). Usually a pair of ganglia occurs in the region of the mouth, and dorsal to it (*e.g.*, clam, Fig. 38). In segmented forms, as the earthworm and crayfish, there is also a series of ganglia connected by fibres, ventral to the digestive tract. This chain is in turn connected with the dorsal ganglia by a loop of fibres passing round the esophagus (Figs. 39 and 40). In vertebrates the central nervous system consists primarily of a tube with thick nervous walls—the spinal cord—which may be specially enlarged and thickened at the anterior end to produce the brain (Fig. 172). From the various parts of this cord the nerves take their origin, and run to all parts of the body.

108. **The Peripheral Nervous System: Sense Organs.**—We know by experimentation that in the lowest animals even, or for that matter, in protoplasm, certain external conditions produce definite responses or changes. We also know that these external happenings and their responses, in our own case, are accompanied by certain sensations, as touch or taste. By inference, both from the nature of the response and from the structure of organs, we reach the conclusion that the lower vertebrates and higher invertebrates experience sensations in some degree similar to our own. The classes of possible stimuli have already been mentioned (§21). Those producing in us definite sensations are: simple contact stimuli, producing the sensation of touch and pressure; vibratory contacts, giving rise to hearing and temperature sensations; gravity, giving us our sense of position in respect to the pull of gravity; chemical actions, making possible sensations of taste and smell; ethereal vibrations, producing the sensation of light. In the lowest



forms of animals there are no specialized organs for the reception of particular stimuli, and in such cases it is reasonable to infer that the distinctness of the sensation cannot be very great. In almost all animals, however, certain areas are specially suited to be stimulated by special stimuli.

109. **Touch.**—There are two principal ways by which contact stimuli are received among animals. Fibres of the central nervous system may pass to the skin and end among its outer layers as free nerve terminations, or these fibres may become intimately united with one or more of the cells of the epithelium. The most common of the tactile organs in vertebrates are of the first class. Where the stimulus reaches the nerve through a nervous epithelium, the epithelial cells often have special developments such as hairs, bristles, and the like, whereby the possibility of contact with external objects is increased (Fig. 19, *A, s*). The appreciation of changes in temperature is also associated with the general skin surface.

110. **Chemical Sense** (including taste and smell).—It is impossible for us to distinguish between taste and smell in the lower animals. Indeed it is with difficulty, in some instances, that we separate the sensations obtained from the two sources even in our own case. Almost all animals seem to have some power of

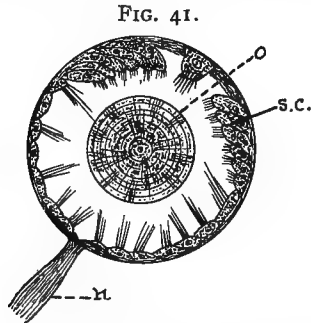


FIG. 41. Statocyst in a Mollusk. *n*, nerve; *o*, statolith; *s.c.*, sensory cells in wall of statocyst. (After Claus.)

**Questions on the figure.**—What immediately stimulates the sensory epithelium in this case? What kinds of general agencies might be supposed to produce the necessary motion for this purpose? What is the present view of the function of statocysts?

appreciating the chemical condition of the medium in which they live. In aquatic animals the chemical sense organs may be distributed over the surface of the body. In the higher animals they collect more and more at the anterior or mouth-end of the animal, with manifest advantage to the animal. In the higher land forms, especially the vertebrates, the organs of the chemical sense come to lie in or about the mouth and nose,—the beginnings of the digestive and respiratory tracts respectively. These senses are specially related to the testing of food and the medium in which the animal lives. For this purpose their position in the mouth

and nose is especially favorable. While both smell and taste are aroused by chemical stimuli, very much less of the substance is necessary to arouse smell than is required for taste. Thus smell serves to make the organism aware of slight changes in the medium and of distant objects, while taste is a sense of near-by objects only. The senses thus far enumerated seem among the earliest developed in the animal kingdom.

**III. Hearing and Equilibrium Sense.**—It is by no means certain that the lower animals possess the ability to appreciate those vibrations in matter (air, water, etc.), which arouse in us the sensation of sound. There are in several groups of such animals organs, the structure of which would suggest that they might receive vibrations of the medium in which they live. In their simplest condition they consist of a sac (*otocyst* or *statocyst*) derived from the ectoderm and lined by an epithelium containing sensory cells. From these cells sensory hairs extend into

FIG. 42.

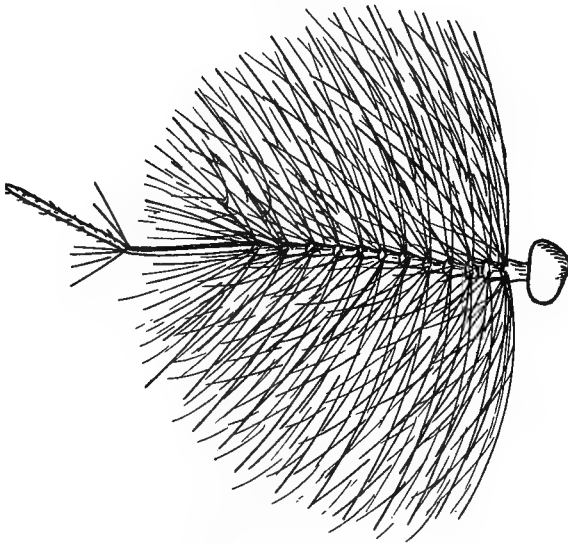


FIG. 42. Antenna of Male Mosquito (*Culex pipiens*). By J. W. Folsom.

**Questions on the figure.**—Compare with the antennæ of a female (see Fig. 65). What are the differences between the head of the male and female mosquitoes? What is believed to be the function of these plumose antennæ? What are the evidences for this view?

the cavity (Fig. 41). The cavity contains a fluid which may support one or more solid particles (*statoliths*). With the vibration of the medium the whole would be put into vibration, but the inertia of the contained fluid and statoliths would cause the latter to strike against the hairs and thus serve as stimuli to the sensory cells. Late researches prove, however, that these structures are organs enabling the organism to appreciate the pull of gravity and movements in the water rather than to hear. In higher forms the ear becomes immensely more complex, but

the general conditions both of origin and structure appear to be much as described for the statocysts. That is to say, the final sensory cells are ectodermal in origin, but now line a sac deeply imbedded in the tissues of the skull. In some of the lower animals, as insects, there are also external vibratile hairs and vibrating membranes which are auditory (Fig. 42).

112. **Sight.**—There are three distinct facts to be noted with respect to visual sensation in the higher forms of animals: the perception of light, the perception of color (*i.e.*, light of different wave-frequency) and the formation of images of external objects. It has already been seen (§ 21) that protoplasm is sensitive and responsive to light *without* any special organs. The simplest visual organs found in multicellular animals consist merely of epithelial cells containing pigment in

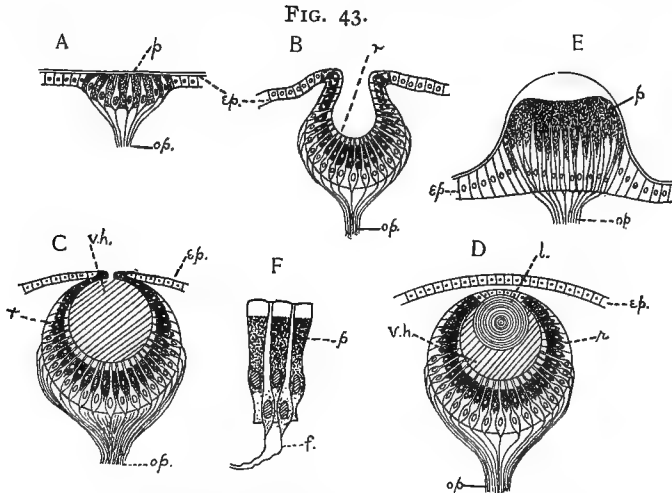


FIG. 43. Diagrams showing some of the stages in the increasing complexity of the simple eye in Invertebrates. *A*, simple pigment spot in epithelium having nerve-endings associated with pigment cells (as in some medusæ); *B*, pigment cells in a pit-like depression (as in *Patella*); *C*, with pin-hole opening and vitreous humor in cavity (as in *Trochus*); *D*, completely closed pit, with lens and cornea (as in *Triton* and many other Mollusks); *E*, pigment area elevated instead of depressed, lens of thickened cuticula (as in the Medusa, *Lizzia*); *F*, retinal cells more highly magnified. *ep.*, epidermis; *f.*, nerve fibre; *l.*, lens; *op.*, optic nerve; *p.*, pigment cells; *r.*, retina; *v.h.*, vitreous humor.

**Questions on the figures.**—What changes take place in the sensory epithelium in this series of figures? What is gained by such a depression as occurs in *B*? What purpose is served by the pinhole and the vitreous humor of *C*? Describe the change from *C* to *D*. What is gained? What may be the function of the pigment? Compare texts. In what respects does *E* differ from the other types? What two types of cells are figured as belonging to each retina? What constitutes the retina?

which changes are wrought apparently by the action of light (Fig. 43, *a*). These changes affect the nerve fibres associated with the pigment cells and thus the central nervous organ. Such eyes are capable only of giving knowledge of the intensity or, if properly constructed, of intensity and direction of the light and do not form an image of external objects. There are several types of image-forming

eyes in the animal kingdom. The most familiar of these is the "camera eye" of vertebrates, so called because it illustrates the principles made use of in the construction of the photographic camera. In this there is a lens or body which refracts the rays of light in such a way that all the rays passing from a point of the object are brought to a focus at a point on the retina (Fig. 43, D). Another type of image-forming eye is the *compound* eye of insects and crustacea (Fig. 44). These are made up of a large number of eye elements—each structurally complete in itself—whose separately formed images must nevertheless be joined in order to form a picture.

FIG. 44.

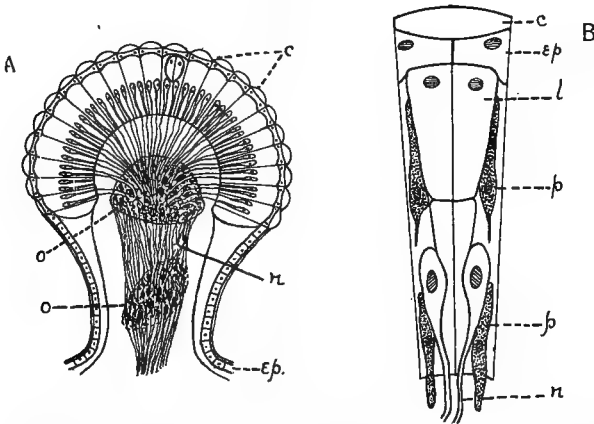


FIG. 44. Diagram illustrating the compound eye of arthropods. A, the whole eye shown in section; B, one of the eye-elements (*ommatidium*) more highly magnified. *c*, cuticular facets; *ep*, epidermis; *l*, group of cells forming lens-like body; *n*, optic nerve fibres; *o*, optic ganglia; *p*, pigment cells.

**Questions on the figures.**—In what way is the independence of each ommatidium secured? In other words what is to prevent the light which comes in obliquely from passing from one ommatidium to another? In what conceivable way is a general image obtained from these various partial views? What groups of animals possess eyes of this sort? Compare the diagram B with the figure of the complete ommatidium of the lobster (Fig. 127).

The degree to which the color-sense is developed among lower animals is very uncertain. The simplest animals may respond differently to light of different colors, but this is a very different thing from saying that they possess the color-sense in the meaning that we give to the word.

To summarize,—the essential part of the eye is the sensitive layer known as the *retina*. The other parts of the complex eye-structure serve the purposes of shutting out the light except from certain directions; of focusing the light admitted in such a way as to increase its intensity and form an image on the retina; of adjusting this apparatus to objects at different distances; of nourishing and supporting the more important portions of the apparatus; and of moving the eye so as to take into view different portions of the surroundings. Some of the various grades of complexity of eye-structure in the invertebrate series beginning with a pigment spot and ending with a complete lens-eye, are shown in Fig. 43.

113. **Analogy and Homology.**—In comparing various animals we find that they may do the same work with organs that arise in very different ways, which, however, because they are adapted to perform similar tasks, look somewhat alike. Such structures are said to be *analogous* (as the wing of a bird and the wing of a butterfly). In other cases organs that originate in the same way may have been used so differently as to have a very different appearance, as the various “legs” of the crayfish, or the wing of a bird and the arm of man. These, notwithstanding their superficial differences, are said to be *homologous* because of the fundamental equivalency of origin and structure.

FIG. 45.

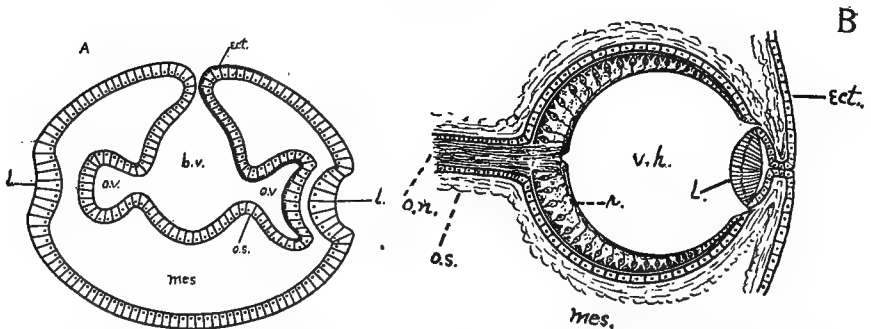


FIG. 45. Diagrams illustrating two stages in the development of the vertebrate eye. *A*, showing the relation of the ectoderm, the brain vesicle, and the optic vesicle. The right side of the figure shows a later stage than the left. *B*, later stage, showing the lens, eye-ball and retina in position. *b.v.*, brain vesicle formed by the invagination of the ectoderm (*ect.*); *l.*, lens; *mes.*, mesodermal tissue; *o.n.*, optic nerve; *o.s.*, optic stalk; *o.v.*, optic vesicle, a portion of the brain vesicle; *r.*, retinal layer; *v.h.*, interior of eye-ball which comes to contain the vitreous humor.

**Questions on the figures.**—Which portions of the eye are derived *directly* from the ectoderm? Which *indirectly*, *i.e.*, from the brain? Which portions seem of mesodermal origin? By following the invagination by which the retina is formed do you find any suggestion of an explanation of the fact that the sensitive portion of the retina (*rods* and *cones*, Fig. 175) is directed away from the light? Refer to some work on the embryology of the vertebrates for more complete series of figures.

114. **Differentiation and Reintegration of Parts.**—The chapter thus far should have given the student a fair appreciation of the degree to which the work of a complex organism is divided up among the organs and of the differences found in the organs themselves because of this. We all know that this differentiation makes for efficiency. There are two sides to this, however.

In becoming suited to doing one kind of work the cells cease to be able to do other kinds. The various cells thus become mutually dependent. Unless they can be brought to work together suitably there will not be efficiency. Division of labor is only one-half of efficiency. There must also be a *reintegration* of these special parts into a higher kind of oneness. It is this that determines the state of the individual made up of these specialized parts. There are three phases of this reintegration.

*a. Physical Reintegration.*—This is done by the cement between cells, by the connective tissues, the skin, the skeleton, and similar tissues. When the fertilized egg first divided, this cement held the cells together. It is only in this way that a multicellular animal could arise. In the mature body the billions of cells are further bound together by these connecting tissues into a physical unity that makes it possible that they work together as they could not do if they were not united into one body.

*b. Nutritive Reintegration.*—This physical bond would mean little but for a deeper one. In the differentiation of the cells, while all must have food and oxygen and all produce wastes which they must get rid of, the various cells of the body do different things. They have somewhat different needs and produce different kinds of waste products. Some cells absorb the foods for all; others absorb oxygen. Some eliminate carbon dioxide from the system; others eliminate the urea and other wastes for all the cells; still others manufacture substances which are of further use in the general work of the body. It follows therefore that all these cells must be connected in a chemical or nutritive way. This is done by the body fluids, including chiefly the blood and lymph.

In addition to the work of lungs, digestive epithelium, the skin, and the kidneys referred to above, with which all the active cells of the body must be connected in this chemical interchange—the liver, the spleen, the sex glands, the thyroid, the adrenals and other groups of cells take from or add to the blood substances that vitally change it. Very often these special substances poured into the blood by particular organs, as the testes or the thyroid, will be carried all over the body by the blood and

will produce profound effects on the well-being of other groups of cells far removed from them. For example, products of the sex and other glands get into the blood and produce growth in the voice box and vocal cords in man and in fact all the outward differences in the bodies of males and females. If the thyroid is diseased or removed, so that its product is no longer poured into the blood, profound changes take place in certain other structures in wholly different parts of the body. If the healthy thyroid tissue of another individual is grafted at any point in the body of such a diseased individual the latter will become normal again. These various organs secrete substances (*hormones* or *endocrines*) into the blood which control activity elsewhere. The proper balance of these chemical substances goes far to coordinate and make normal the various human functions and development.

Indeed we are coming more and more to understand that *every* cell in the body changes the blood in some degree for all the other cells of the body. It takes from the blood as it passes, and at the same time pours out into the blood the by-products of its own living. For example, we know that overwork causes fatigue products to be poured into the blood with profound effects upon the animal. These substances may even be injected into the blood of a rested animal and bring about symptoms of fatigue. We must think of the blood as more than just a means of connecting lungs and intestine and kidneys with one another and with the general system. The life of every cell in the body is conditioned by the make-up of this medium whose composition is determined by every cell in the body. We are just beginning to appreciate its full meaning; but we know that this chemical integration of the body is profoundly important.

*c. The Coordinating Reintegration.*—In addition to the physical and chemical unity, the parts of the body must *work* in harmony and instantly. When food is eaten the digestive glands must become active. When the body exercises the oxygen supply must become more rapid. When an organ acts it must have an increased blood supply. When we undertake to walk, scores of muscles must contract just enough and in the right relation to other muscles. When external conditions

stimulate we must be able to do the right thing. This harmony of operation among the parts is *coordination*. Harmony between the action of the organism and the outside conditions is *adaptation*. The nervous system reintegrates these numerous diverse units of which we are made, and makes them work together. All the active cells of the body are connected by way of the nervous elements. A part of the work of the hormones is also of this higher coordinating value. It has been found by experiment that the pancreas, for example, is brought to secrete at the proper time by substances in the blood absorbed from the digestive tract rather than through nervous action purely, as we formerly thought. The hormones and the nervous system thus work together for active integration; but in general the nervous system operates more immediately than the chemical system.

#### 115. Summary.

1. Division of labor and differentiation of structure proceed together as the individual develops. *All* tissues retain the power of using food, of oxidation, of eliminating useless products. Other functions incidental to these may be relegated to special cells or tissues.

2. Associations of tissues to accomplish a more or less definite work are called organs. Organs of a similar kind are collectively known as systems of organs.

3. The principal functions of animals and the organs or systems performing the work may be classed as follows:

Function	System
(a) Metabolism.....	Nutritive.
(b) Support and protection...	Skeletal, and integumentary.
(c) Growth	
(d) Reproduction.....	Reproductive.
(e) Motion.....	Muscular, in connection with skeletal.
(f) Sensation.....	Nervous, including sensory epithelium.

4. Metabolism or nutrition embraces the following processes:

(a) Ingestion of food (including oxygen),



- (b) Digestion,
- (c) Absorption (from the digestive tract, and at every other cell wall),
- (d) Circulation,
- (e) Assimilation = anabolism,
- (f) Dissimilation = katabolism (including respiration),
- (g) Secretion and excretion (of waste matter including carbon dioxid).

The processes in (a), (b), (c), and (e) are anabolic, *i.e.*, add to the resources of the body. Those in (f) and (g) are katabolic, *i.e.*, tend to destroy the materials, develop energy, and eliminate waste. Circulation contributes to the accomplishment of both purposes.

5. The supportive skeletal structures may be internal, or external, or both. They may arise as a secretion of the superficial cells of the body, or consist of a mixture of cells and inter-cellular substance. Their nature and arrangement are profoundly important in determining the distribution of the other more active organs.

6. Growth and reproduction are the outcome of the nutritive processes. Growth is increase in mass; reproduction is the production of new individuals from old. Reproduction always involves division of a cell (or an organism) and may be asexual or sexual. The latter typically involves two parents. In it two cells, which may be either similar or dissimilar, must unite before development will proceed. In parthenogenesis, only the female parent is necessary.

7. The nervous and muscular systems are closely related in function. Their united work is to receive, coordinate and respond to the external or internal stimuli affecting the animal. The structures to receive stimuli (end organs) are largely superficial; the coordinating and controlling parts (central organ) are deep-seated, thereby securing protection and a central position; the muscular system must have definite relations with the hard parts upon which it acts. Thus arises the necessity of connectives or nerves between the various portions.

8. The sense organs represent areas of the epithelium which are peculiarly adapted to the reception of some one of the forms

of stimulus to which animals are subject, supplemented by a more or less complex apparatus which serves to intensify or modify the original stimulus. The sense organ determines the *kind* of stimulus which may be *received*, but the central nervous organ determines the nature of the *sensation* which results, and the response.

9. If cells and organs become differentiated, and specialized in the division of labor, it becomes doubly essential that they be brought together again in a complete unity if there is to be an efficient individual. This reintegration of diverse parts is (1) physical, by means of connective and supportive tissues; (2) chemical and nutritive, by means of secretions into the blood and lymph; and (3) cooperative, by means of the nervous system.

10. Organs with different origin which by reason of similar function have come to look alike are said to be analogous. Organs with similar origin and structure are homologous. They are so called even though, because of their differing functions, they are very different in appearance.

#### 116. Topics for Investigation, in Library and Field.

1. What are the advantages and the disadvantages of division of labor and differentiation? Illustrate your views very fully.

2. Illustrate the variety of foods used by different animals with which you are acquainted. Classify the animals you know on the basis of their food preferences.

3. Compare the ways in which animals known to you capture and prepare their food for swallowing. What special structures arise in connection with this function?

4. Do animals have any power of storing food within the body for future use? Compare with plants.

5. Compare gills and lungs as to general form and arrangement and see in what ways they appear to you to be suited to their particular media, *i.e.*, gills to water and lungs to the air. Why might not the conditions be reversed?

6. What seem to you to be the comparative advantages and disadvantages of the exoskeleton and endoskeleton.

7. Devices to accomplish locomotion in animals known to the student. Find as many variations as possible.

8. Select four animals, as diverse as possible, representing *each* of the following conditions of locomotion:—through the air, through the water, on the earth, and through the soil. Compare the problems which each must solve, and the organs by which the work is accomplished.

9. Compare known animals as to rate of locomotion. Do you find a satisfactory explanation in any case?

10. Let the student attempt to prove that the dog experiences the same sensations which we have. Hold yourself rigidly to your evidence.

11. Report on the general differences between the eyes of insects and of vertebrates, with a statement of their structure and the work done by each.

12. In what way could the statocysts possibly act as organs to enable the animal to appreciate its position in space, and thus maintain its equilibrium?

13. What are the simpler facts connected with the process of absorption or osmosis of dissolved substances in the body?

14. Find in text-books of chemistry a fuller account of the process of oxidation and why it results in a liberation of energy.

15. Demonstrate how a biconvex lens forms an image of objects. Why inverted?

16. Discover what glands are known to produce internal secretions (hormones). Where are these located? What, in general, are the effects of each of these secretions?

## CHAPTER VII

### PROMORPHOLOGY

117. We have seen in the preceding chapters how the work which an organism must do is divided among its parts, and that the parts become specialized in connection with this division of labor. This complexity which is known as *organization* is, in any animal, the result of forces both within and without the animal, and expresses the adaptation of the internal structures to each other and to external conditions. The simplest organism known is thus organized. Organization is merely more evident in the more complex organism. In addition to the fact of the organization and heterogeneity of structure it is easy to see, after examining a number of animals, that these different parts are not thrown together without some definite order. For example, most vertebrates move with their long axis horizontal, and possess certain organs that we always expect to see at the anterior end; their appendages are arranged in a definite way in relation to the long axis. The parts of the starfish are arranged according to a different but equally definite plan. All consideration of the general plan according to which animals are constructed may be called *Promorphology*. The fundamental plan may be similar in groups of animals which are otherwise very different, because of similar external conditions and similar modes of life.

118. **Definition of Sections.**—In trying to express the plan of structure in animals it is convenient to have in mind certain planes to which we can refer the parts. A section perpendicular to the main axis of an organism or of an organ is called a *transverse* or *cross* section. The longitudinal median section separating the body into right and left halves is a *sagittal* section. A longitudinal section, perpendicular to the sagittal and separating the *dorsal* (or back) and *ventral* (or belly) *portions* of the body is described as a *frontal* section. An animal is said to be symmetrical with regard to any of these planes when the parts severed by the plane are essentially similar.

119. **Axiality.**—As an organism grows from its small beginnings in the fertilized ovum, or from a spore in the simpler forms, the new materials may be added more or less uniformly so that a mere increase in size results; or growth may take place more rapidly along some radii than along others, making the organism depart from its original spherical form; or materials or organs of one kind may occur along one radius and different ones on another (as in Fig. 48). These lines of special growth and development are called *axes*. We may investigate them as to their number, their space-relations to each other, and the likeness or unlikeness of the two ends or *poles* of each axis.

120. **Types of Symmetry.**—It is desirable to distinguish the following types:  
1. In a spherical organism in which no differentiation is apparent (as in a simple spherical cell, or blastula, Figs. 13 A, 3; 46) any plane passing through the centre divides it into symmetrical parts and all the axes or diameters, are

essentially equal. In such a case there may be said to be an infinite number of similar axes, and the poles of each axis are similar. This may be described as universal symmetry.

FIG. 46.

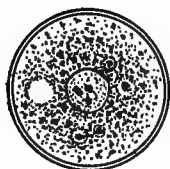


FIG. 47.

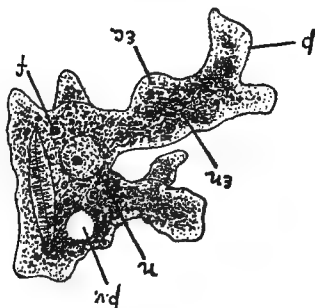


FIG. 46. Spherical cell (resting stage of Amoeba) illustrating general or universal symmetry. Any plane passing through the centre will divide it into two essentially equal portions.

FIG. 47. Amoeba in active condition. Entirely unsymmetrical.

**Question on the figure.**—What prevents this animal being a *perfect* illustration of universal symmetry?

FIG. 48.

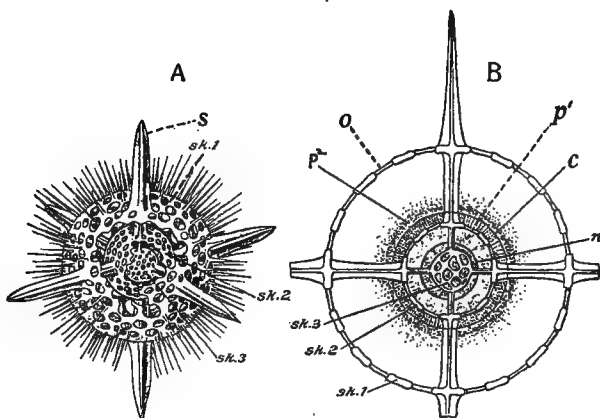


FIG. 48. *Actinomma asteracanthion*, a Radiolarian with a limited number of specialized radii (axes), symmetrically arranged about the centre. A, whole animal with portion of two spheres of shell removed. B, section, showing relation of the protoplasm to the skeleton. n, nucleus; p, protoplasm; sk., skeleton. From Parker and Haswell.

**Questions on the figures.**—In what way does this species differ in symmetry from Fig. 46? How many specially developed axes appear to be present? By how many planes may the organism be divided into essentially equal portions?

2. An organism may be wholly asymmetrical, without any definite form, the axes being without regular arrangement. (*Amoeba* in its active stages, Fig. 47; some Sponges.) In other instances the form may be definite and axes developed;

but the structure is such that no plane will separate the animal into symmetrical parts (*Paramecium* and many other active Protozoa; see Figs. 68-71).

3. As a variation of the universally symmetrical condition seen in 1, a *limited* number of axes may become distinguishable from the others by some specialization of structure (Fig. 48). These special axes are similar and their two poles are alike.

4. Starting again from the undifferentiated spherical form, one of its numerous similar axes may come to differ from all those perpendicular to it by increased or diminished length, or by a difference in construction. This special axis is to be known as the *principal* axis. The poles of the principal axis do not usually remain alike. Perpendicular to this principal axis one may select an indefinite number of *subordinate* axes which are essentially similar to one another. The poles of each subordinate axis are alike. Such a condition is realized in the simplest gastrulæ (Fig. 13; A 4, B 3, C 2). Any plane which includes the principal axis will divide such an organism into two equal halves. In general external appearance a hen's egg would illustrate the type. This is the least differentiated form of what is known as *radial symmetry*.

Two important variations from this simple condition of radial symmetry are found among animals.

FIG. 49.

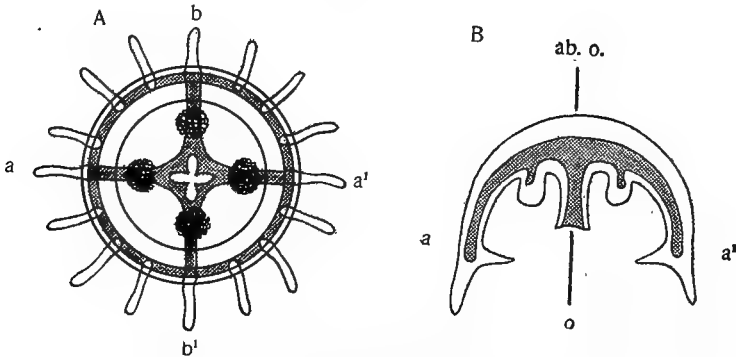


FIG. 49. Diagram of *Medusa*, illustrating radial symmetry. A, viewed from the oral end of the principal axis; B, a section along the principal axis and through one of the subordinate axes  $aa'$ : o,  $ab. o.$ , the oral and aboral poles of the principal axis; a,  $a'$ , and b,  $b'$ , the similar poles of the two chief subordinate axes.

**Questions on the figures.**—Are the poles of the oral-aboral axis alike or unlike? How many clearly differentiated secondary axes are there? What would be the appearance of a section midway between  $aa'$  and  $bb'$ ? Would the resulting halves be symmetrical? Compare this condition with the definition of radial symmetry in the text. Find other illustrations of radial symmetry in the figures of this book.

(a) Special organs, such as those of locomotion and the like, may be developed about the principal axis. These usually come to be arranged in a limited number of the planes which may be passed through the principal axis. Considered from the point of view of the subordinate axes this means that there are a limited number of special axes (Fig. 49,  $aa'$  and  $bb'$ ) perpendicular to the principal axis (Fig. 49,

*o-ab.o*) instead of an indefinite number as in the former case. These special subordinate axes are usually 3, 4, or 5, or some multiple of these numbers. The number however may be reduced to two in which the four poles are all alike. Many of the medusæ, coral polyps, and some echinoderms illustrate this type of symmetry.

(*b*) A further variation of (*a*) is seen in the fact that in some animals, otherwise similar to those described in (*a*), one of these special axes perpendicular to the principal axis comes to differ from the other. The two poles of each of the subordinate axes are essentially alike, but are unlike the poles of the *other* subordinate

FIG. 50.

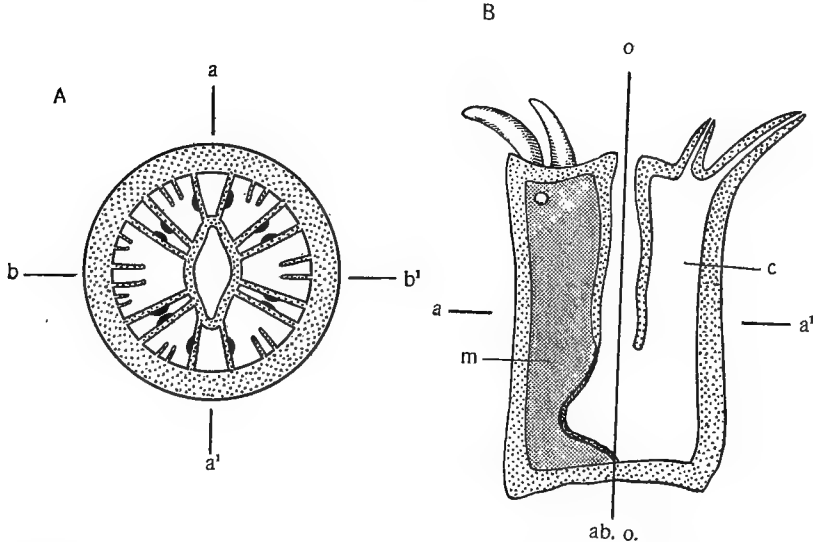


FIG. 50. Diagram of the sea-anemone, illustrating another type of radial symmetry. *A*, cross section; *B*, longitudinal section. Lettering as in Fig. 49. *c*, the chamber between the mesenteries (*m*).

**Questions on the figures.**—How does the symmetry of the anemone compare with that of the Medusa? Express the difference clearly in terms of the axes and their poles. Are *aa'* and *bb'* strictly similar axes? Do their planes divide the animal into halves? Are the four halves thus obtained equivalent? In *B* what difference in the position of the section will account for the differences on the right and left side of the figure?

axis. This arrangement is found in the sea-anemone (Fig. 50). The differences between *aa'* and *bb'* are not usually so great that we cease to speak of the form as radially symmetrical. It is of importance to know that in the radially symmetrical animals the principal axis, whether longer or shorter than the subordinate axes, is normally perpendicular to the substratum on which the animal rests, or to which it is attached.

5. If such an animal as was last described were to have its principal axis horizontally placed, with one of its two subordinate axes vertical and the other

horizontal, and were maintained in this position, it would likely happen that the formerly similar poles of the new vertical axis would become unlike, because subjected to different influences. These poles are known as the *dorsal* and *ventral* poles. The poles (*right* and *left*) of the other transverse or subordinate axis would remain similar, as they are subjected in the long run to similar conditions. This gives us the condition, found in all the higher, free-moving animals, known as *bilateral symmetry*. It consists, to recapitulate, of (1) a main axis (*antero-posterior*

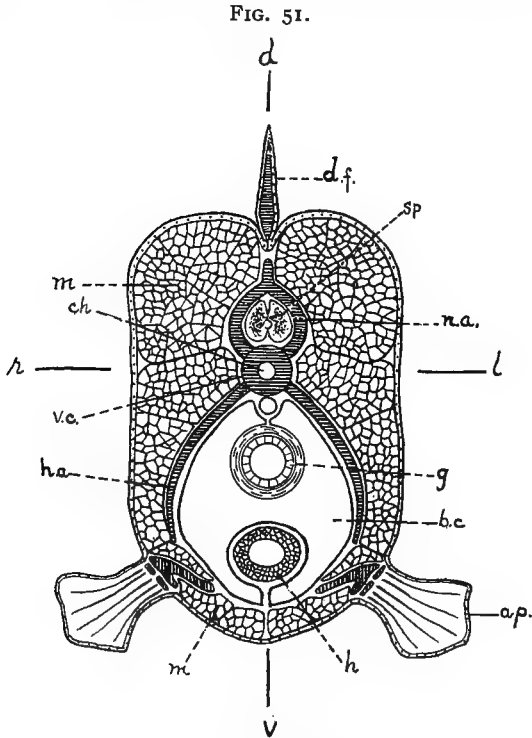


FIG. 51. Diagram of the cross section of a fish, showing the bilateral symmetry of the parts: *dv*, dorsoventral axis; *rl*, right-left axis. *a.p.*, paired appendage; *b.c.*, body cavity; *ch*, notochord; *d.f.*, dorsal fin; *g*, gut; *h*, heart; *h.a.*, hæmal arch; *m*, muscles; *n.a.*, neural arch; *sp*, spinal cord; *s.c.*, vertebral column.

**Questions on the figure.**—In what respects is the symmetry as shown in this cross section different from that shown in the cross section of sea-anemone? Compare carefully, and express your conclusions in terms of the axes and their poles. Find other figures in this book illustrating bilateral symmetry.

*axis*) usually horizontal and with dissimilar poles; (2) a transverse axis, usually vertical (*dorso-ventral axis*) with dissimilar poles; and (3) a transverse axis perpendicular to the other two, horizontally placed, with poles alike (*right-left axis*). Such an animal has only one plane (the *sagittal*) by which it may be divided into symmetrical halves (Figs. 51, 31, 101).



121. **Antimeres.**—There is a striking tendency among organisms to repeat or duplicate organs or parts. This we have seen in the occurrence of similar rays about the main axis, in radially symmetrical animals like the starfish. Parts thus repeated are known as *antimeres*. The term is also applied to the right and left or paired halves of bilaterally symmetrical animals.

122. **Metamerer.**—When the parts or organs are repeated in a linear sequence along the main axis, as the segments or rings of the Earthworm, the arrangement is described as *segmental* or *metameric*. Metamerism may be shown both by the internal and external structures. The vast majority of the elongated, bilaterally symmetrical animals are segmented. In the higher Vertebrates it is not manifest externally, but is shown in the vertebræ, the nerves, etc.

123. **Appendages.**—Nearly all the animals, whatever the fundamental symmetry may be, have appendages of one kind or another for locomotion, capture of food, protection, respiration, and the like. These outgrowths from the body may be generally distributed over the body surface (as cilia in some Protozoa and free-swimming larvæ); or radially arranged,—often about the mouth, as in many radially symmetrical animals (Figs. 49, 50, 81); or in a right and left series in bilaterally symmetrical animals (Figs. 131, 137, 191). The paired appendages of bilateral animals may be attached dorsally, laterally, or ventrally, as determined by the uses they serve. They may be uniformly distributed along the axis, one or more pairs to each metamere, as in some arthropods, or be confined to special segments in certain regions of the body, as in the higher arthropods and the vertebrates.

124. **Practical Exercises.**—Let the student find illustrations, from the animals with which he is acquainted, of paired appendages with dorsal attachment; with lateral; with ventral. What is the work to be done by each? Does their position appear to be of advantage in the performance of it? Find likewise animals in which the appendages are clustered at the anterior portion of the body; some in which only posterior appendages are found, or at least are better developed than the anterior. Does the arrangement seem in any way related to the habits and surroundings of the animal?

125. **Specialization of Metamerer.**—In the lowest segmented animals, as the simpler worms, the metameres are much alike in external form, in their appendages, and in the contained structures. In the adult insects this becomes less true, and the various segments are specialized for particular duties. The segments in the head region become very different from the body segments. The same is even more true of the higher vertebrates. This progressive differentiation of a distinct head is one of the most remarkable facts to be noted in animal development. Accompanying the specialization of groups of segments in various parts of the body we often see the complete fusion of such similar segments for the better performance of their common work (as in the head of insects and vertebrates and in the thorax of insects and crustacea).

126. **Formation of New Segments and Regeneration.**—In many of the animals in which the segments seem of nearly equal value there is a more or less continuous formation of new segments. By this process the organism increases in length and in the number of its segments, and frequently, with the aid of a somewhat similar process, produces two individuals by division, as in many worms. Such a proceeding necessitates the formation of a new head or tail in each of the daughters,

by a segment which, in the mother, was a body segment. When such an animal is artificially cut in two, each half may reproduce segments like those which have been removed from it. This is known as *regeneration*. Naturally this ceases to be possible in animals in which the segments become more highly specialized; yet even in the highest animals some power of replacing lost tissue or even lost organs remains (as in healing of wounds, formation of a new tail by lizards, etc.). It is recognized as a general law that in making these repairs or healings the newly formed material tends to restore the symmetry possessed at the outset.

#### 127. Summary.—

1. Promorphology treats of the ground plan in accordance with which the parts of animals are combined.

2. Symmetry relates to the possibility of passing one or more planes through the animal and obtaining similar portions on either side of these planes.

3. If no such division is possible the organism is described as without symmetry. If each of three mutually perpendicular planes separates the animal into equivalent portions, it may be described as *universally* symmetrical. If no plane transverse to the main axis can divide the animal into symmetrical parts, and two or more, which split the animal along the main axis, are capable of doing so, we describe the form as *radially symmetrical*. When there is only one such plane capable of separating the body into equal parts we have the condition of *bilateral symmetry*, which represents the highest condition of development, that of active animals.

4. Antimeres are parts of animals repeated on different sides (two or more) of the main axis of the body.

5. Metameres are parts repeated *in* the main axis, *i.e.*, one behind another. The successive metameres may be almost entirely alike (*homonomous*), or they may become much differentiated in the performance of diverse functions (*heteronomous*).

6. From the main trunk of animals special appendages often appear. They usually adapt themselves to, and accentuate, the fundamental symmetry of the organism. They may therefore be asymmetrically placed, or uniformly distributed over the entire surface, or along the radii, or in pairs as in the bilaterally symmetrical forms. There are typically one or more pairs to each metamere, though this number may be much reduced. Paired appendages, in series, are regarded as homologous.

7. Many animals have the power of restoring by growth parts or segments which have been lost (regeneration). In the lower segmented forms this power is closely associated with the power of increasing the number of new segments in an uninjured animal. In heteronomously segmented animals both these powers are less manifest.

#### 128. Topics for Investigation.

1. Determine the nature and degree of symmetry in (1) the sponge of commerce; (2) skeleton of starfish; (3) crayfish or grasshopper.

2. What is the final criterion by which you determine which is the anterior and which the posterior end of an animal? Justify.

3. Find among animals of your acquaintance instances of difference between the dorsal and ventral surfaces as to color, form, etc., and see if you can discover any possible advantage resulting therefrom.

4. What degree of difference have you ever noticed between the right and left halves of the body in various animals. Is *perfect* bilateral symmetry ever found?

5. Can you assign any reason for the location of the sense organs at the anterior end of the body? In a given individual? In the race to which the individual belongs? (Distinguish between *cause* and *advantage*). Do you think they occur here because it is anterior, or is it anterior because they occur here?

6. Why are vehicles (made by man) bilaterally symmetrical?

7. Express in tabular form the differences between the poles of the three axes of bilateral animals, and what you can gather as to the causes of the differences.

8. For what kind of life does bilateral symmetry fit the animal?

9. For what kind of life does radial symmetry seem suited? Verify by illustrations.

10. To what extent do animals seem able to regenerate lost parts? Trace out the conditions in various groups, as far as your reference library will allow.

11. Is there any apparent limits to the numbers of metameres which animals may possess? What degree of constancy or variability in this particular can you discover in various individuals of the same species?

## CHAPTER VIII

### DIFFERENTIATION OF INDIVIDUALS AND ADAPTATION

129. **The Individual and its Environment.**—We have thus far considered the mature individual as the end for which the various developmental processes exist. It has been seen that the individual becomes complex as its parts grow and become differentiated to do the work necessary to the well-being of the animal. In this differentiation the parts become dependent upon each other, and in the healthy state they work harmoniously among themselves. It is now necessary to pass from the consideration of these internal structures and relations in order to consider the individual animal as a unit in its relations to everything about it, that is, to its environment. This term includes not merely the inanimate materials and conditions surrounding an organism, but in addition all living things both plant and animal which directly or indirectly influence it. The environment of no two animals is the same, nor is it the same for any given animal for two moments in succession. This continual change in the environment leaves its impress on the structure and habits of all organisms. Every individual is thus related to its own environment from day to day; in addition to this, all the individuals of any generation, owing to the facts of reproduction and inheritance, are also to be considered in the light of the conditions to which their parents have been subjected from the remotest time. The study of the individual in its relations to its environment (*ecology*) brings the student face to face with many very important problems. No department of zoology is more interesting.

130. **Heredity.**—One does not study organisms very long without being impressed with two things: first, that there are remarkable similarities among them, even among those little related; and second, that there are interesting differences among

even those whose kinship would entitle them to be much alike. There is always a disposition among students to feel that the likenesses are due to internal causes and that the unlikenesses are due in some way to the varying external influences. In other words the former are thought to be due to heredity and the latter to the environment.

Characteristics which animals receive from the reproductive cells from which they arise are described as hereditary. This is equally true whether the reproduction is sexual or asexual, by means of one cell or two. We ascribe the fact that the fertilized hen's egg produces a fowl and a frog's egg a frog to the action of heredity. No less is the repetition in the child of minute parental peculiarities of feature and form a fact of inheritance. While these likenesses are due to the action of the internal forces of heredity, it must not be deemed that heredity is a purely conservative influence in the life of the organism. The offspring of two parents may inherit from their parents very different qualities and thus present striking variations among themselves due solely to inheritance. The offspring may also present such a mingling of the qualities inherited by way of their ancestors as to possess characteristics decidedly new to any of them. Indeed offspring may inherit features which neither of their parents shows. Thus likeness to parents and unlikeness to parents may equally be due to heredity. It at once perpetuates old qualities and introduces variations from these.

It was formerly considered that all the characteristics which parents possess are equally subject to inheritance, but it is now denied by many biologists that the qualities which a parent acquires in its own lifetime, as the result of its own actions or of the environment, are capable of being transmitted. In the light of what was said about the parallel development of primordial germ cells and body cells (§49), this is just another way of saying that changes that come to the body cells may not be passed on specifically to the germ cells so that these will later give rise to the same sort of new qualities in the body cells which in turn arise from them. These statements do not mean that the condition of the body may not modify the character

of the germ cells which are housed in that body. Nor do they mean that the environment may not operate to change germ plasm. They only mean that we have no sufficient evidence for believing that we can change germ plasm in a specific way by changing the body of the parent in that particular way. For example, training parents in speaking English or in playing the piano apparently does not in any degree make either of these performances easier for their children. It is unquestioned, however, that qualities received by inheritance from the preceding generations are, under favoring circumstances, capable of being transmitted to the following generations. Whether they are actually so transmitted depends upon the circumstances. Chapter XXVI discusses some of these circumstances.

131. **The Bearers of Heredity.**—It follows from the fact that the adult organism is produced from one or more reproductive cells that these cells are in some way endowed to carry the hereditary qualities. These cells are all that pass from the old generation to the new. There are strong evidences that the chromatin elements, or chromosomes, in the nuclei of the sperm cells and ova are the most important material structures by means of which transmission is effected. The chromosomes of the fertilized ovum are contributed equally by the male and female cells, and they are the only structures in the sperm and ovum which are apparently equal in amount. This, taken in connection with the fact that one parent does not seem, on the average, to have any more power than the other to influence offspring, furnishes a basis for the belief that the chromosomes are the physical basis of heredity.

Some students of the subject believe that the cytoplasm is, equally with the chromosomes, a carrier of hereditary qualities. They think that cytoplasm is responsible for those qualities that both sexes have in common. That is, the cytoplasm conserves the common characters of the species. The chromosomes are held to be more responsible for those qualities in which the individuals of a species differ, as sex, size, color, vitality, etc. Recent investigations show that the paternal and maternal chromosomes tend to retain their distinctness and to be equally distributed to all the nuclei of the developing embryo.

132. **Library Exercises.**—The student may increase his knowledge of the facts of heredity by endeavoring to find answers to the following questions. What is *atavism*, and what explanations have been offered for it? Do the male and female seem, as a rule, to have equal power of transmitting their individual characteristics? Cite some facts tending to show that the nucleus is especially concerned in transmitting parental qualities; that the chromosomes are instrumental therein. What are the essential features of the old "performation" hypothesis to account for the fact that an adult similar to the parent springs from an egg? Examine some of the principal theories of inheritance: Darwin's "pangeneses;" Brooks' modification of it; Weismann's "continuity of germ-plasm," etc. State Mendel's laws of inheritance? What did Galton, De Vries, and Johanssen contribute to the subject?

133. **Variability.**—Notwithstanding the fundamental likeness existing between parent and offspring, and among the offspring of common parents, no two individuals even among the lowest animals are exactly alike. While members of the same species agree more than they differ, the fact of variation is less fundamental only than the fact of likeness. Variation among animals appears to depend upon two sets of considerations: (1) the physical and chemical instability and changeableness of the protoplasm of which animals are so largely composed, and (2) the diversity and stimulating effect of the environment in the broadest sense. Through the interaction of these two influences, even if all individuals were alike at the start, it would only be a question of time until the offspring derived from them would present noteworthy differences. Such differences would tend to increase with the lapse of time. This is the more true in proportion to the degree in which variations are capable of being transmitted under the influence of heredity. So far as we can tell organisms may vary to any amount if we give time enough.

134. **The Part Played by the Environment in Producing Variation** while not completely understood must be recognized as very real. Even though much stress must be put upon the hereditary complexity and instability of protoplasm as the source of variations, it is evident that the external conditions serve as stimuli to produce the changes on the inside. For example, it is a matter of common observation that the quantity and quality of food greatly influence not merely the rate of

growth of the body but the size and quality of the adult organism as well. Life would be impossible without food, oxygen, water and suitable temperature. Any variation in these conditions at once has its effect upon the organism. Experiment shows that the varying degrees of salinity of the water may be accompanied by striking individual differences of form in certain marine animals. Caterpillars of certain butterflies placed in boxes lined with differently colored papers develop pupæ with colors harmonizing with those of the boxes containing them. Colors in various animals are intensified or changed by special foods or by changed temperature. In general it may be said that changes in *any* of the conditions important to animal life produce some change or variation in the body of those animals subjected thereto. Since this is true, it becomes inevitable that the various individual animals on the earth are differentiated from each other somewhat as was seen to be the case with the cells and tissue of which the individual itself is composed. The following paragraphs trace out some of the ways in which this differentiation of individuals takes place, the relations of the various organisms to each other and to the environment. Variations in organisms, which are due to use and disuse or to the action of the environment, are known as *fluctuations*. As we have seen, these fluctuations do not seem to be inherited. On the other hand new qualities in organisms, which arise in the germ plasm, are known as *mutations* and are transmissible.

135. **The Struggle for Existence.**—All animals (with a few possible exceptions in those which possess chlorophyll) depend ultimately upon green plants for food, those which live on other animals no less than those which use plant food directly. Only a limited amount of vegetation can be supported by the earth without cultivation. The number of animals therefore which can find a livelihood on the earth is in turn restricted. There is, however, no such limit of the powers of reproduction, either among plants or animals. Any pair of organisms if unchecked could in a very few years supply descendants enough to populate the earth up to its full powers of support. That they do not thus multiply at a geometric ratio is due solely to the influences at work to destroy these descendants. Any group of organisms



will hold its own when, on an average, a pair of individuals can in a lifetime bring to maturity another pair to take their place. More than this means conquest of new territory; less than this, the extinction of the group. When we recall that all organisms have power of reproduction in a geometric ratio, it is easy to see that a time must soon come when a struggle for food and a foothold on the earth is inevitable. The struggle would be more intense between those organisms which demand the same kind of food, that is, among kindred. This is the fundamental struggle. It would be complicated by the fact that some groups of animals prey upon others, and that the primary conditions of life, as water, temperature, etc., are subject to striking changes. These conditions tend, by just so much as they destroy individuals, to relieve the struggle within the species. The interaction of these processes gives great variety to the life problems of animals and great interest to their study. There is nothing more certain than that this struggle has occupied organisms practically from the beginning, and all our explanations of present conditions must take note of the fact. All the important structures and activities of animals are modified by this competition for a livelihood.

**136. Library Exercises.**—The student is invited to make real to himself the possibilities of a geometrical increase as applied to organisms. Take the known rate of increase (that is, the total number of descendants in an average lifetime) of a number of common animals and determine the possible living descendants in a specified time. Find references concerning infusoria, insects, fish, man. Have you any observations relating to the reality of the struggle for food among animals?

**137. Natural Selection.**—In spite of this power of reproduction we see that, on the average, the mass of individuals does not increase. The earth is no more thickly inhabited by animals today than it has been for countless ages. The proportions of different animals vary now and again, but that is all. Out of a family of one hundred young individuals striving for a foothold, no two of which are alike, ninety-eight on the average will be destroyed in a species which is just holding its own. Which will survive? Barring accidents, specially favoring or beyond the powers of any of the individuals to resist, those will

survive which possess or acquire some quality, structure, or habit, better suited to the struggle in which they find themselves. This may be a matter of strength, of speed in eluding enemies or in capturing prey, of specially acute senses, of a tendency toward concealment, or any one of a thousand things calculated to fit an organism for a special place in life. It is not necessary to suppose that these elements of fitness exist in striking degree at first. The struggle is so intense that even the slightest handicap may mean the destruction of the individual. This elimination of the weaker individuals results in what has been called *natural selection* through the "survival of the fittest." The hereditary qualities (mutations) thus preserved in the individual are subject in their turn to transmission by heredity; and by the continuous action of natural selection and heredity through a long series of generations these elements of fitness are believed to accumulate, and thus animals become better and better adapted to their surroundings.

138. **Artificial Selection.**—Since man has been on the earth he has been a most potent factor in the environment of the other animals. He has helped in the elimination of animals hurtful to his interests; has domesticated others which he has deemed useful, thus rendering their environment highly artificial and removing from them the struggle for existence in certain measure. For natural selection he has substituted a conscious selection of such organisms as are best suited to his needs or fancies, and has allowed these to reproduce, eliminating the others. This artificial process, which obtains results more rapidly than the natural, has given rise to the various breeds, strains, or races of dogs, horses, cattle, fowls, etc. By means of this selection the habits and dispositions of the domestic animals have been improved as surely as their structure. Their power of self-support, however, has been so materially diminished that some of them could not succeed in finding a living in the wild state under ordinary circumstances.

139. **Practical Exercises.**—Are there any domesticated animals whose species is represented in the wild state? Compare the habits and general structure of some of the domesticated animals with that of their nearest kin among wild species.

How many species of domestic animals can you enumerate? From what groups do they come? Trace the history and results of the domestication of some of the common animals, as fowls, pigeons, cats, dogs, etc. Have any strictly American species been domesticated?

#### 140. The Adaptation of Animals to their Environment.—

There are two distinct questions of importance to be considered in connection with this subject: (1) the *necessity* of the adjustment of organisms to their environment, and (2) the *means* by which this adaptation takes place in the individual and becomes fixed in the species. It is clear that the limited food supply and the high powers of animals to reproduce result in a struggle for food among the animals at any time occupying the earth (135). This struggle is not merely among the animals in question, but is in reality between every organism and its whole environment. Extremes of heat and cold, drouth and famine, and numerous changes in the conditions of life make it absolutely necessary that the individual shall have some power of becoming adapted to what is permanent and what is changeable in its environment. What are the means then by which animals that are not completely in accord with their surroundings may become so? There are two possible ways in which this may come about. The animals may migrate to regions where the conditions are naturally more favorable to their well-being, that is, to regions for which they are already adapted. As a matter of fact this is known to be a common occurrence. Animals often disperse from their old centre of multiplication under the influence of hunger or other unfavorable local conditions. They are often assisted in these dispersals by such natural agencies as winds, currents of water, and other animals. If the migrating forms succeed in finding new regions suited to their needs, there results a condition of adaptation between organisms and their respective environments, but without any active change in the characteristics of the organism. The environment itself is subject to continual change and there are too many barriers in the way of universal migration for this to be accepted as a complete explanation of the widely observed adjustment of animals to the conditions which surround them.

Again animals may become suited to their environment by

variation, without migration. There is no question that this also occurs, and it may be the more important factor of the two. It has been shown (133) that all animals are variable. Students of biology have suggested two important ways in which variations may give rise to a harmony between the organism and its surroundings. This result may take place through natural selection, which eliminates the unfit (137). According to this view the organisms naturally tend to vary. The changing environment stimulates this tendency to variation. Out of a thousand individuals of similar parentage there will be numerous slight inherited differences of structure and physiological qualities. Some of these will be more, and some less, favorable to the environment. In the struggle those will be eliminated which for any reason are strikingly unsuited to the environment. On the other hand, those animals whose inherited variations are most in accordance with the local condition will persist and propagate their kind, tending through heredity to pass on to their offspring the native qualities which enabled them to adjust themselves to their surroundings. Thus there will be a gradual, ever-increasing adaptation in the whole species of which they are a part, by natural selection. If, however, only inherited qualities are transmitted, and the fluctuations of body produced by use and environment cannot be transmitted, natural selection could not act, by way of the acquired characters but only through happy mutations, in improving a species.

Occasionally there occurs in offspring, whether from the action of the environment upon the germ plasm or from other inner causes, a sudden and considerable change from the parent type. Such a mutation product is known as a "*sport*." It is quite possible that natural selection may seize on such mutations and, if in a favorable direction, preserve and increase them. In such cases adaptation might take place with great rapidity, instead of in the gradual way described above.

In the second place it has been argued that fortunate mutations are not just happy coincidences, but that organisms are so attuned to conditions that they naturally tend to make definite and suitable variations. In other words this view holds that the majority of the variations brought about by a given

external condition and by use are definite and naturally in the direction to meet the necessities of the case. For example, cold stimulates the surface cells of the body of an animal. The immediate response of the nervous and nutritive processes in the organism are such that the surface cells take on greater activity and produce materials at the surface of the body which tend to protect the animal from the ill effects of the cold. This is an individual variation. To become effective in making the species better adapted to the environment these results must be handed down by inheritance to the next generation. If this can take place this theory would go a long way toward explaining how adaptations arise. There is, however as we have seen, very great doubt whether such adaptations acquired in the life of an individual can be transmitted to offspring. If this cannot occur we are thrown back upon natural selection of mutations as the principal explanation thus far offered to account for the progressive adaptation of animals to the environment. While natural selection does not *cause* variations, there is no reasonable doubt that it is a part of the explanation of progress. So far as we know either small or large variations may be selected and increased by breeding if they are only inherited variations and useful ones. To what extent natural selection is assisted by other factors is at present uncertain. It will be assumed in the following pages that it is one of the most important known factors in producing adaptation.

141. **Classification.**—Since the environment is not the same at any two places on the earth and there is usually an accumulation, from generation to generation, in animals, of those features which tend to bring them into harmony with their different environments, it is inevitable that the animals themselves come to be very diverse, no matter how similar they were at the outset. In the discussion of them it therefore becomes necessary to devise some means of expressing the degree of likeness and unlikeness among the great number of individual animals existing on the earth. This may be done by means of an appropriate *classification*. The differences of structure and function may be superficial or fundamental, but it must be remem-

bered that all these differences are in some way the outcome of the history of the organisms, and that the fundamental likenesses are signs of kinship, or of similar history, or both. The grouping or classifying of organisms has two objects: (1) convenience, that is, to make future work easy; and (2) to express the results of past study. In so far as the first motive predominates the classification may be *artificial*, that is, may bring together animals that are really not closely related, though possessing a superficial resemblance. The grouping together of bats and birds and insects on the ground of their power of flying, or whales with fishes because of their habitat, would illustrate such a classification. In proportion as classification takes in all the facts known with regard to animals and expresses the relationship of forms classed together, it is said to be *natural*. Every classification is in some measure artificial since we do not know all the facts concerning the structure or history of any organism.

142. **Terms Used in Classification.**—From what has been said concerning the power of multiplication in animals, the resulting struggle for existence, the variability, and the elimination of those whose variations are not suited to the various environments into which the offspring migrate, it will be readily understood that even the descendants of a single pair of organisms will come in time to be noticeably different in form, size, color, and the like. The individuals of a given region will usually be more like each other than like their cousins who have been subjected to some other kind of environment. There is thus a need of terms to express the degree of difference which, through these influences, finally characterizes the descendants even of common ancestors. Such groups of forms are usually known as *varieties* or *subspecies* of the original type from which they all sprang. Thus in the human race, while all men are considered as belonging to one common type and possibly derived from the same human ancestors, there is enough difference between the American Indian and the Caucasian to make it necessary to distinguish them as different varieties. Many of our widely distributed animals as the dog, the horse, the common fox have varieties which are readily distinguishable.

When the causes which produce varieties have been at work long enough to eliminate the intermediate forms which are often found connecting the varieties, and to secure a close adaptation of the varieties to the environment, the term *species* is applied to what were formerly called varieties. Species thus merely represent the further progress of individual differentiation and adaptation to the different modes of life which give rise to variation in individuals—that is, to varieties. If a mutation is of sufficient importance to serve as a basis of distinction and breeds true, a new species may be produced in one generation, without any intergrades. A species of animals may again split up by the action of the forces mentioned (and other conditions which have not been mentioned) into new varieties and finally into new species. It is believed that the present diversity of animal and plant life has come about from a much more limited number of kinds of ancestors by a method essentially such as that described above. The student will realize that in nature there are only individuals, no two of which are exactly alike. There is really no such thing in nature as a species. This is purely a mental concept of our own.

Varieties of the same species usually cross freely. Their offspring are usually fertile. The individuals of different species as a rule cross less freely and when they do cross the term *hybrid* has been applied to their offspring. Such hybrids are often sexually infertile. In recent years geneticists class as hybrid the crosses of subspecies as well.

The *genus* is related to species somewhat as the species to the varieties which compose it. A genus embraces those kindred species which show a high degree of relationship among themselves. The characters which serve to distinguish different genera are more fundamental than those by which we recognize varieties or species, and argue a more extended time in the differentiation of genera than is required for species.

Other terms, as *families*, *orders*, *classes*, *phyla*, are used to denote the still more extensive and comprehensive division of the animal kingdom.

143. **Illustration of Classification.**—The domestic cat as a species has many varieties or breeds, as the maltese, manx,

tortoise-shell, etc. On the other hand, the wild-cat, the tiger, the leopard, the lion, are species which have numerous points of structural likeness to the domestic cat, and are said to belong to the same genus (*Felis*). The genus *Felis* and others less common are placed together in the *family Felidæ*. These with the members of the dog family and others constitute the *order Carnivora* (flesh eaters), and similarly for the higher groups in the diagram below.

Kingdom—Animalia (Protozoa, arthropods, chordates).

Phylum—Chordata (fishes, birds, mammals).

Class—Mammalia (carnivora, ruminants, bats, man).

Order—Carnivora (dogs, wolves, cats, etc.).

Family—Felidæ (cat family).

Genus—*Felis* (cat, lion, tiger, etc.).

Species—*Felis domestica* (with its numerous varieties).

The name of an animal is its generic name followed by its specific name as above. The variety name is added when there are distinct varieties.

144. **Relation of the Individual to the Species.**—The various types of animals produce their offspring in numbers proportional to the difficulties encountered in bringing the young to maturity. In the most favorable circumstances many more are produced than can survive. In cases where enemies are numerous millions of eggs may be deposited in order to secure a single adult. Nature is thus said to be lavish in her waste of individuals in order that the species may be continued and improved in its adaptations. These surviving descendants, generation after generation, have become, through natural selection of their variations, more and more suited to their surroundings. This means that the production of many individuals, a large number of which never reach maturity, secures the development of a small aristocracy which propagates the type. The species is related to its individuals something as the individual is to the renewed and changing cells of which it is composed. Species are not constant, but even the most fixed must undergo



change or extinction when confronted by new conditions. Species however are less variable than the individuals composing them because the species represents an average condition of all its individuals. Adaptation to environment is the great problem which every animal must solve. Those which do solve it successfully constitute the species. It is needful then to consider next those characteristics of structure, habit, or instinct whereby a species of organisms becomes successfully adjusted to its surroundings. In a broad sense all the organs which were outlined in the preceding chapters are adaptations: the digestive organ and process, to the nature of food; the nervous system and the special senses, to the external stimuli; the lungs, gills, and skin to the need of oxygen, and the like. In contrast to adaptations of this kind we now consider as adaptations those more special modifications of fundamental structure by which a species becomes more suited to some limited habit or to some special mode of life which is of signal use to it in the struggle for existence.

#### 145. Classification of the Principal Types of Adaptation.

A. Adaptations primarily in relation to the inorganic environment.

II. Adaptations primarily related to other organisms.

Among animals of the same species.

1. Friendly and social.

(a) Mating.

(b) Parental care of young.

(c) Organic colonies.

(d) Social and communal life.

2. Competitive: for food, mates, etc.

II. Among animals of different species, and to plants.

1. Friendly and social.

(a) Commensalism.

(b) Symbiosis.

2. Competitive.

(c) The predaceous habit: adaptations for offense and defense.

(d) Parasitism.

146. **Special Adaptations to the Inorganic Environment.**—These embrace such special structural devices as hair, feathers, the blubber of whales, which enable the body to maintain its temperature despite the condition of the medium. The habits of burrowing and hibernation, the winter migrations of many animals, especially birds, are examples of instinctive adaptation to cold and to food supply. The same end is obtained by man by artificial clothing, by houses, and by the use of fire which has been one of the most important instruments in his progress. Rotifers, infusoria, and some other animals have become capable of retaining life during thorough drying, and of resuming activity on the return of moisture. Adaptations to locomotion in different media, earth, air, and water; to climbing; to stationary life, belong to this group. These are only a few of the many instances of adaptations of organisms to the materials and the forces about them. It is easy to see that some of the adaptations are of life and death importance, and without them the species would become extinct. It has been argued that these qualities of the organism arise in a way something like this: owing to the irritability of all protoplasm, the prevalent external factors as heat, light, gravity, moisture, and chemically active substances must produce some change,—that is, some response on the part of the organism. Through internal, hereditary causes different animals respond with different degrees of suitability to these conditions. Those organisms in which the response is not in accordance with the best adjustment to the special environment are less likely to survive in the struggle for existence. Those which do survive and propagate their kind because they are so endowed as to make favorable responses to these stimuli are, by reason of these facts, more and more likely in succeeding generations to possess and to develop those structures and behavior which suit them to their surroundings.

147. **Practical Exercises.**—Find other instances which seem to indicate adaptation either in structure or habit to special features in the environment: as adaptations to prevent undue evaporation in a dry climate; adaptations to warm conditions; to varying temperature; to drouth; to the use of special plants as food; to light; to gravity. Illustrate from observation and by library reference the types of adaptations cited in the text above. Is the power of sleeping an adaptation of any value? Among what animals is it found? Find instances in which originally

useful adaptations have become useless and even hurtful from changed conditions of life.

FIG. 52.



FIG. 52. Young Opossum (*Didelphys virginiana*) photographed from life by J. W. Folsom.

**Questions on the figure.**—Of what conceivable value to the animal is the prehensile tail? In what other groups of animals is the tail prehensile? What are the habits of the opossum? How is this species distributed on the earth? Where are other marsupials found?

148. The relations of animals of the same species to one another is an interesting mixture of competition and cooperation. In the higher forms the parents instinctively make great personal sacrifices that the offspring may be cared for; the offspring on the other hand struggle with each other for this parental provision. In the classification offered (145) it should be remembered that both friendly and competitive habits and structures are always represented in the same individual.

149. **Mating Adaptations.**—One of the most striking forms of individual variation is seen in the differences between the sexes of higher animals. The male and female are often so widely different in form, size, color, and other qualities, that naturalists have sometimes erroneously classified them as belonging to different species and yet it is very manifest that, though different, the sexes are closely adapted to each other. In the lower types of animals the sexes are frequently represented in the same individual. In such cases the elements often mature at different times. An individual is thus alternately male and female. This is regarded by many as being the primitive condition,—the separation of the sexes being accomplished by the repression, so to speak, of one or the other sex in each individual. Some think that the temperature and the amount and quality of food have something to do with the proportion of males and females which are produced. So sexual dimorphism in some species may be in some measure a response to external conditions and presents every evidence of being an advantageous adaptation to the conditions of life. On the other hand, it is believed by many that the sex of most organisms is determined by conditions in the egg and sperm that unite. In other words it is thought that sex is inherited, and cannot be changed by external conditions.

The very union of the sperm and the ovum, whereby two cells lose their individuality in one, with a renewal of powers and the mingling of the qualities of two parents, must be looked on as an adaptation of the very highest moment to the animals in which it first appeared and to their descendants. So too are the wonderful internal mechanisms and tendencies that cause the definite unions and separations of chromosomes in the sex cells as these prepare for fertilization. The chemical attraction which the female cell exerts on the motile sperm cell is a special adaptation which accomplishes this union. Furthermore it is undoubtedly true that many of the color markings, notes, motions, and the like in which the male and female animals differ are recognition marks whereby the presence of one sex is made known to the other.

Of very first importance as adaptations in reproduction are

the sex attractions and the accompanying emotional states and expressions which are seen in birds, higher mammals, and man. In man these are at the basis of the home and family and the higher personal and social life which arises from the family.

Ova of some species may develop in the absence of sperm. This is known as *parthenogenesis*, and is regarded as having arisen from the more common bi-sexual condition. In some species it is exceptional, in others the predominant method, and in still others in which males are unknown it is the only form of sexual reproduction.

**150. Practical Exercises.**—What is the difference in the notes of the male and female of the American quail which would serve as recognition marks? Mention other cases of sexual dimorphism which appear to you to serve a similar end. What evidences have we that the mingling of sperm and ovum results in a rejuvenescence? in the introduction of variation? Show how these are important as adaptations in the struggle for existence. In what groups is parthenogenesis found? Give details of the facts in several cases.

**151. Reproduction and Care of Young.**—The very rate of reproduction is an adaptation to the severity of the struggle for existence experienced by the animals of a given species. Those forms with few enemies and abundant food usually need to produce only a few young in order to maintain their place. Others less favored in these regards, as many insects, the lobster, the salmon, must reproduce thousands of young in a lifetime. Similarly the length of the reproductive period and of life becomes an adaptation to the same end. It is clear from these facts that any device which the parent may adopt likely to bring a larger percentage of the young to maturity will make for a saving in the necessary birthrate. This husband the parental resources and conduces to the efficiency of the individual and of the species. It must not be supposed that parental care is confined to the higher animals. In its most elementary condition it takes the form of food stored in the egg, and in depositing the egg in a safe place for hatching. After hatching it takes the form of supplying food, or protection, or both. Cephalopods, fishes, and birds have a large amount of food substance stored in the egg. Many animals, as the clam, some fishes, some reptiles, and the mammals, retain the eggs in special portions of the

FIG. 53.

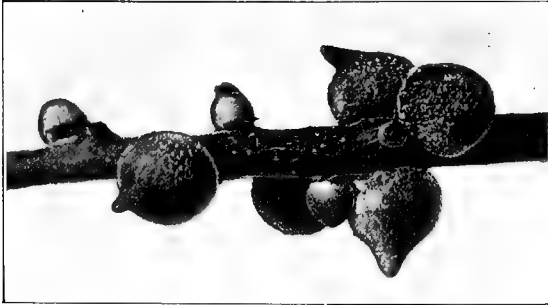


FIG. 53. Galls on oak, cynipid (*Holcaspis duricoria*). Natural size. Photo by Folsom.

FIG. 54.



FIG. 54. Galls on elm, produced by an aphid, *Colopha ulmicola*. Natural size. Photo by J. W. Folsom.

body until development has well begun. The flies lay their eggs in the decaying matter which the young use as food. The solitary wasps seal theirs up in nests with the food (dead or wounded spiders or insects) on which they are to develop. Other insects bore into the tissues of living plants and deposit their eggs, about which "galls" or masses of abnormal vegetable tissue are developed. The ichneumon fly deposits its eggs in the body of some other animal. Thus we see an immense number of adaptations useful to the organism have been developed

FIG. 55.

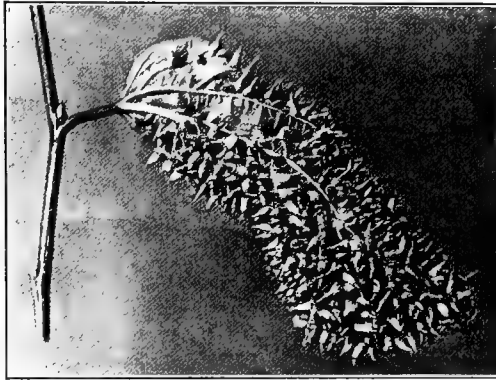


FIG. 55. Galls on hackberry leaf, produced by a fly (*Cecidomyiida*). Natural size.  
Photo by Folsom.

Questions on figures 53, 54, 55.—What does the gall represent from the point of view of the plant? From the point of view of the insect? What seems to cause the undue vegetable growth? Find other galls in nature and try to find what type of insect is responsible for them? In what ways may one hope to determine this fact?

in connection with the egg-laying habit. After such provision the majority of animals leave the young to care for themselves; but many higher forms take further pains to protect and train their offspring during the course of their development. The care which the birds and mammals give their young is a matter of common observation. It takes the form of food, of special homes,—as nests, burrows, dens, etc., and of the personal services of the parents, who will often protect the young from their enemies at the risk of their own life. Similar care is shown by

some insects, especially the social forms, such as bees, ants, and the like. The lobster carries its young on its abdominal appendages for months after hatching. The lower invertebrates are practically destitute of these later care-taking instincts.

It is interesting to notice that animals differ very much in their helplessness at hatching or at birth. The young of the reptiles, or the duck, or the chicken are relatively well developed

FIG. 56



FIG. 56. Nestling Marsh Hawks (*Circus cyaneus hudsonius*). From Year-Book. Department of Agriculture.

**Questions on the figure.**—What are the nesting and breeding habits of the marsh hawk? Are the young precocial or altricial?

at hatching, and are very soon able to run about and feed (*precocial*). The young of the song birds, as the thrushes, swallows, etc., are wholly dependent on the care of the parents for a considerable time (*altricial*). In the herbivorous mammals, as the sheep and cattle, the young have the use of their limbs in a short time after birth. Among the carnivorous forms, as the cat and dog, the young are more helpless. In the human species the period of helplessness is longest and consequently the necessity of parental care greatest. In general, the longer period of



parental protection accompanies the development of more complex and highly organized instincts, and intelligence. The lengthened period of dependence, while a burden to the parent in one sense, is an advantage to it in the saving in number of offspring, and serves to benefit the species, not merely by keeping the offspring alive until they may reproduce, but in the greater development of such parental instincts as gentleness, self-sacrifice, and the like. In the human race it has given rise to the home and family, which we regard as the real basis of modern society; and such social organization in turn has been a most powerful factor in the progress of the human species. Death and the length of life must also be considered as special adaptations. This differs in different species very widely. Life in general, where natural selection acts, will be the period of youth, plus the period of fertility, plus the time necessary to rear the latest offspring. For the species, the life of the individual beyond this period becomes a disadvantage. This disadvantage to the species, in the long run, fixes the normal length of life in the species.

152. **Practical Exercises.**—Add instances of parental care which have fallen under your own observation, and give a statement of the facts in the case. Compare the mammals with which you are acquainted, in this regard. Compare the condition of the young of the robin, the quail, the blue-jay, the pigeon as to maturity at hatching. Do any animals of your acquaintance reproduce more than once in a year? Why is one reproductive period per year a common adaptation. Compile statistics concerning the longevity of various animals, and its relation to size, to reproductive period, and to the time demanded to reach the adult stage.

153. **Colonies.**—In some of the lower groups of animals, as the polyps and jelly-fishes, in which the reproduction by fission or budding is prominent, the newly formed individuals remain for a longer or shorter time in association with the parent or with each other. These units which otherwise might be separate individuals are organically connected and often come, by the continuation of the process, to form immense masses, as in the coral. Such organic associations are called *colonies*. Colonies rarely occur in animals in which the organs are highly specialized. Very often the individuals become specialized for the performance of a special portion of the work, and thus we get several quite differently constructed individuals within the

colony (*polymorphism*, Fig. 87). The whole colony may then behave somewhat as an individual, the polyps taking the place of organs (Siphonophora). Colonial animals are almost always attached to fixed or floating objects. These polymorphic individuals are closely adapted to each other in structure and division of labor; and the colonial habit in general, even where there is no division of labor, is a successful device whereby limited areas are completely occupied by the members of a species (as in the case of the branching corals) where the single polyps would be practically helpless. The arrangement of the polyps on the common skeleton and the rate of growth of the different polyps are beautifully adapted to the best use of the currents of water by which the food and oxygen are conveyed.

154. **Library and Museum Exercise.**—What phyla of the animal kingdom supply instances of colonies? Trace different degrees of polymorphism. In what different ways do the individuals occur on the common stock? Show how the relative rate of growth of the differently placed individuals determines the ultimate form of the colony as a whole very much as bud arrangement determines the character of a tree.

155. **Social and Communal Life.**—Animals of the same species often become associated even when there is no organic connection between the individuals. The association may be temporary or permanent. The bond in these cases is not physical, but instinctive and psychical. In its simplest form this is merely a matter of gregariousness such as is seen in the schools of fishes or flocks of birds, which are apparently brought together at certain periods by a common instinct or by common needs. Undoubtedly sex attraction is an early bond and a powerful one in bringing individuals together in pairs or in small groups. A step more intimate than mere gregariousness is the banding together of predaceous animals as wolves or vultures, or pelicans, for mutual help in finding or capturing the prey. Corresponding to this, on the part of their victims, we find the herding of the bison, of deer, and their allies for protection, whether by fighting together or by the stationing of sentinels to give notice to the feeding herd of the approach of danger. In still other forms, notably among such insects as the bees and ants, there is a very intimate and permanent union in social life. This is

usually associated with the instinct of home building, and thus a high degree of division of labor with its great advantages becomes possible. This is carried to such an extent that often polymorphic individuals, such as queens, drones and workers, result, much as in the organic colonies. In such cases it is clear that the individual life comes to be bound up in the success of the community. Such forms usually exert great care for their young and develop a relatively high order of "intelligence." The principal social forms are the ants, of which there are more than two thousand species; some of the bees and wasps; the termites, or so-called white-ants; beavers; some monkeys and man.

**156. Library Exercise.**—Make a report on the social life of the honey-bee, including the following points: the home; the kinds of individuals, their origin, and their work in the community; their food and its preparation; mode of caring for the young; swarming and its significance. Make a similar report concerning some species of ant. Find facts concerning the following topics: "ants' cows;" slave-making among the ants; army ants; the agricultural ant.

**157. Competition among animals of the same species** is not, for the most part, of a personal character except in the case of the struggles of the males of polygamous animals. The ordinary struggle for existence among them is merely that of food-seeking, where all possess the same organs and habits but in varying degrees of excellence. Those which have the greater strength, hardiness, or intelligence are more likely to get their portion of food at the expense of the weaker, and thus to propagate their qualities. Sometimes, however, animals live directly at the expense of their own species. Young spiders before escaping from the cocoon in which they are hatched devour each other, thus instituting an acute phase of the struggle for existence in the place of the protection prepared by parental care. Many fishes are known to devour their own young. We have all had occasion to wonder what becomes of the small frogs in a box containing large ones.

The struggle between the males for the possession of the females has resulted in the development of many interesting adaptations. The struggle may take the form of actual combat

in connection with which organs of offense and defense are found. Such are the horns, tusks, spurs, manes, and even the excessive size of the males as compared with the females. In a similar way temperament, courage, fierceness and the like play a part. These qualities depend in part upon the glands of internal secretion. Manifestly the same qualities which make a male a formidable rival to another are likely to be of service to himself, his mates, and his young, and thus to the species, in protecting them from the attack of their enemies among other species. The competition between males is not all of this stressful kind, however. It is believed by many naturalists that, in those instances where simple mating rules, those males with the most striking colors, pleasant voices, and winning ways displace their less favored rivals and thus tend to accumulate by natural (sexual) selection the adaptations of this class.

158. The individuals of one species of animals may often be practically indifferent to the presence of those of other species. Their relation is simply that of competing for the general food supply and thus assisting in the elimination of the unfit in all species. They may graze in the same pasture, swim in the same pool, or even be parasitic on the same host, and have no other relation. From this as the simplest relationship we may pass by gradual stages to the most intimate friendships and the most bitter antagonism. Every species is indifferent to some and hostile to other of the species which surround it; and man is no exception to the rule. It is a perversion of manifest fact to pretend that all animals are of some use to man.

159. We have seen that the individuals of a given species are engaged in a struggle among themselves for the means of subsistence, and that in certain cases they form communities or colonies—a kind of organic corporation—by which they meet more successfully the demands made upon them by their environment. Similar partnerships may be formed by animals of different species. The simplest of these associations are known as *commensalism* or "*mess-mateism*," in which the degree of dependence and mutual advantage is perhaps not very great. As instances, may be cited the occupancy of the same burrows

by the prairie dog and a species of owl; the attachment of barnacles to whales and sharks; the hundreds of species of other insects which live in the nests of ants; the lodging of fishes and other animals in the body-cavity of some of the large tropical sea-anemones or among the tentacles of some of the Hydrozoa. Each member of the association can live without the other, but for some reason they often occur together. The way in which species of rats and mice follow man and occupy his habitations perhaps may be considered as illustrating a similar condition.

160. **Symbiosis.**—Under this term are included even closer relationships between members of different species, where there

FIG. 57.

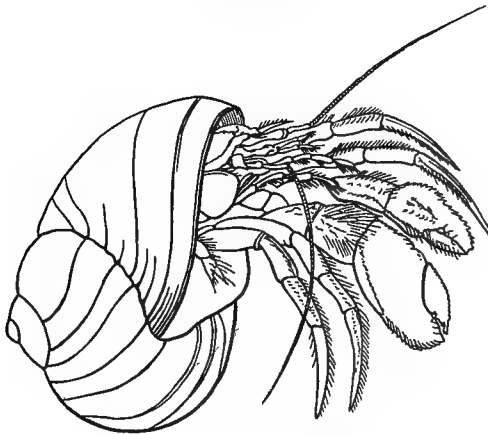


FIG. 57. Hermit-crab in the shell of a Gasteropod. After Morse.

**Questions on the figure.**—What structural adaptations has the hermit-crab to this mode of life? What conceivable gain has such a habit? What animals are cited as symbiotic with the hermit-crab?

seems to be a distinct advantage accruing to both members of the partnership sufficient to account for it. The relation of the ants to the aphids or plant-lice which they capture may be so described. The aphids, although captives, are nourished, often at great expense of labor to the ant, on the food which they most prefer, and in return the ants use the sweet secretions of their bodies as food. Symbiosis is probably more common

between animals and plants than among animals. The most interesting of these latter are seen in the so-called "ant-loving" plants, in which the plant produces special homes or special foods used by the ants, and the ants in return protect the plant from the ravages of other leaf-cutting ants or hurtful insects.

FIG. 58.



FIG. 58. *Argynnis cybele* on thistle. Natural size. Photo by Folsom.

**Questions on the figure.**—For what end does the butter-fly visit the thistle? What special adaptations does the butter-fly possess for this mode of life? What is the gain to the thistle from the visits?

Certain sea-anemones possess unicellular algæ imbedded in the cells of the entoderm. These algæ derive their nourishment from the wastes of the animal tissues and supply oxygen and possible other matter to the cells in which they lie. The close relation between the structure and instincts of insects, on the one hand, and the form of flowers, their products and needs, on the other, illustrates a symbiotic adaptation which has long attracted students both of botany and zoology. See Fig. 58.

**161. Library Studies.**—Make a report concerning the various myrmecophilous plants. Accumulate all the supposed instances of symbiosis which your library records. Lichens, among plants, are considered to illustrate symbiosis. How?

162. **The Preying Habit.**—The effects of this habit are stamped upon the structure and activities of both the pursuer and the pursued. It is in this relation that nature is indeed “red in tooth and claw.” While in general the same organs and habits which are of value in the capture of prey are useful in the defense of the possessor, it is possible to find a series of adaptations of an offensive character and others more specially of defensive value. The curved claws and sharp teeth, the stealthy approach, the sudden spring, and the great agility of the one are met by the timidity, the keen senses, the fleetness of the other. We can see that these defensive adaptations must in the long run keep pace with the offensive, if both types are to survive, else the prey would be exterminated, which would entail no less surely the destruction of their enemies than if these should lose their power of capturing their prey.

163. **Adaptations for Protection.**—In addition to the alternatives of fighting or fleeing, the animals which are preyed upon have very interesting and effective qualities that make for safety. Many forms, as the crustacea, have permanent outer coverings; most mollusks have a box-like shell into which they can retire when threatened by attack; others by burrowing or otherwise come to occupy obscure corners in nature where enemies find it difficult to follow. Forms as widely different as the earth-worm, mole, and the chamois find safety in retirement.

This hiding-theme may be wrought out in ways almost equally effective by what is called *protective resemblance*. By this is meant that the animal becomes less easily distinguished from its environment because of its color, or form, or both. This resemblance may be to some particular object, or merely a general harmony of color with the surroundings. As illustrative of the latter head we may cite the quail among the dead leaves and grasses, the sober-hued lizard on the logs, the green caterpillars or tree-toads among the leaves; the tawny color of desert animals, the white fur of arctic forms, the transparency of many marine animals. Indeed the great majority of animals show some traces of resemblance to the surround-

FIG. 59.



FIG. 59. Nestling Mourning Doves (*Zenaidura macroura*). From U. S. Dept. Agriculture Year-Book, 1900.

Questions on the figure.—Is there anything suggestive of protective markings? What are the nesting habits of the dove? What character of nest is constructed?

FIG. 60.



FIG. 60. A sea-horse,—*Phyllopteryx eques*. From Eckstein.

Questions on the figure.—Compare this figure of sea-horse with figures of other species and note the chief difference between them and the typical fishes in external characteristics. What about the figure suggests protective resemblance? At what point does the tail of the fish end?



ings, since concealment is alike advantageous to the predaceous and to their prey. In some instances there is the ability to change color with changing environment, as in the tree-toads, the chameleon, and in some fishes. This is not chiefly by the direct action of the light on the pigment cells but by reflex action of the nervous system stimulated through the eyes.

Many other animals become inconspicuous by reason of a resemblance to special objects. It is among the insects that the most numerous illustrations of this are found. The walking-stick insect appears as dead twigs when not in motion. Many butterflies resemble leaves when at rest. A noted instance is *Kallima* which is a large species, conspicuous when flying be-

FIG. 61.

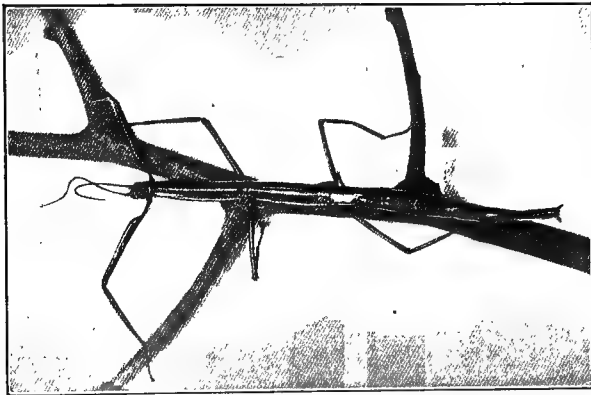


FIG. 61. Walking-stick insect (*Diaperomera veliei*) on twig. Natural size. By J. W. Folsom.

**Questions on the figure.**—To what group of insects does this belong? Do you see any reason to suppose that it illustrates protective resemblance?

cause of blue and orange patches on the upper surface of the wings. The wings are folded when at rest and the lower sides are colored and marked so like a dead leaf that the deception is very complete. The larvæ of some of the geometrid moths, often called "measuring-worms," are remarkably like the twigs on which they crawl, both in color and shape. This is made more striking by the presence of roughnesses on the surface which suggest buds, and by the possession of muscles

which enable them to support themselves rigidly outstretched for hours by means of the posterior legs alone, so that the axis of the body makes an angle with the branch.

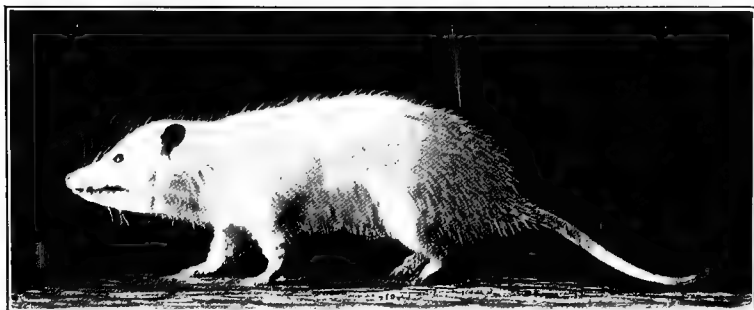
Other instances of special devices whereby animals protect themselves are found in the electric organs of some eels and other fishes, in the poisonous fluids with or without special stinging organs, as in coelenterates, bees, some spiders, a few fishes (spines), and some snakes; also in the repulsive odors of the skunk and many caterpillars.

Caterpillars oftentimes have an acrid or otherwise unpleasant taste, but, unless this is associated with a special odor or color by which its enemies may recognize the fact, it is not likely to prove of any great service to the animal possessing it since a single incision in the soft body made by the bill of a bird is likely to cause death. For similar reasons animals with stings are often highly colored. The colors or other marks are, in these cases, in the nature of warnings. The "monarch," one of our large conspicuous butterflies is an illustration of the association of color and offensive taste; the wasps and the coral-snake, of the association of color with the possession of stinging powers. Thus owing to the power of association in the mind of the enemies, the advantage comes to lie quite as much in the possession of the special color or form as in the presence of the underlying protective powers. These facts give rise to the remarkable phenomena called *mimicry*. This term applies to those instances where an edible or harmless animal, by reason of its similarity to those which are disagreeable, partakes of their immunity from attack. Mimicry must not be considered as in any way a matter of choice with the animal but simply the result of natural selection in preserving and allowing the propagation of favorable variations. The viceroy butterfly, though edible, seems to be protected by its striking likeness to the monarch. The nearest relatives of the viceroy are quite differently marked. Mimicry of bees and wasps is found among many flies and some moths and beetles. Non-venomous snakes occasionally have the marking and the motions of the venomous.

164. **Practical Exercise.**—Try to discover instances of *general* protective resemblance among the animals known to you. Analyze each case and see just

the nature and value of the protection. Treat similarly the subject of *special* protective resemblance. Do you know any really harmless animals which assume apparently dangerous attitudes for protection? Accumulate all the available references on mimicry. Opposing ideas on the subject. What range of color have you seen illustrated among animals? In a single animal? Where, on the earth, are the brightest-hued animals found? What are believed to be the causes of colors among animals? What are the uses of colors? What is *albinism*? Where have you seen instances of it? See Fig. 62.

FIG. 62.

FIG. 62. Albino Opossum (*Didelphys virginiana*). Photo by Folsom.

**Questions on the figure.**—What is albinism? In what structures is it manifest? Among what groups of animals can you find that it occurs? To what is color in hair due? What natural conditions tend to produce color in organisms? What is the chief value of color as an adaptation, individual and social?

165. **Parasitism.**—Of a nature which combines the qualities of commensals and of the preying animals is the association known as *parasitism*. It is an association of individuals of different species in which one member (the *parasite*) gets all the benefits, and the other (the *host*) suffers the loss. It is a case where one species preys on another, but in which it is to the advantage of the parasite, especially if a permanent one, as well as of the host that the life of the latter shall not be suddenly destroyed. It will be readily seen that the parasite increases the work to be done by the host, thus being a handicap in the struggle for existence. This might easily bring about the destruction of these species which serve as host were it not for the fact that nearly or quite all animals support various parasites. Parasites are of two classes,—*external*, as the fleas, lice, and the like; or *internal*, as most of the parasitic

worms. The fleas are transient parasites, as are many other insects which are free in the adult stage but lay their eggs in or on the body of the host where they undergo partial development as parasites. In other instances the parasite must spend its whole life in the body of one or more hosts. These are called *permanent* parasites.

FIG. 63.

FIG. 63.—Caterpillar of *Samia cecropia* parasitized. From Luggen.

**Questions on the figure.**—Seek in your reference literature all figures and references to caterpillars attacked by parasites. Why would caterpillars be rather favorable hosts for parasites? What are a few of the parasitic enemies of caterpillars? What economic importance has this phenomenon?

In addition to the drain on the resources of the host, the presence of the parasite may so irritate the tissues of the host as to produce abnormal growth and disease therein. In many of the transient parasites the life of the individual host is of no consequence after the end of the period of parasitism and hence the entire destruction of the host's body may occur just as truly as in the ordinary preying species. Very profound modifications occur in the structure of the parasite, which are the outcome of, and in part an adaptation to, the special mode of life. There is usually a degeneration of the organs of digestion, of motion, and of sensation, since the parasite de-

depends on the host for the performance of these functions. The explanation of this degeneration of useless or unused organs is not quite certain. It is known that disuse causes structures to deteriorate in the life of the individual, and some naturalists claim that part of this loss is transmitted to the next generation. The claim is denied by many, who are disposed to consider that it is merely a case of natural selection working upon mutations which appear in various ways, all tending toward simplification of organs and the economizing of materials. The reproductive organs on the contrary become much more complicated and the reproductive elements are produced in great

FIG. 64.

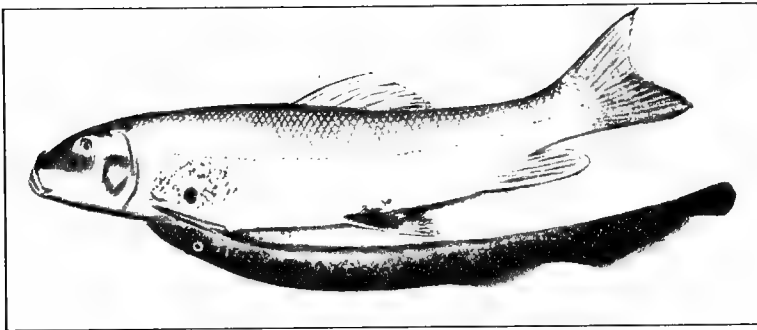


FIG. 64. Lake Lamprey (*Petromyzon marinus*.) clinging to Sucker. (From Bull. U. S. Fish Commission, by Surface.)

**Questions on the figure.**—Does it seem that this is an instance of parasitism or simple preying? What special organs has the lamprey adapting it to this habit? What references can you find to the breeding habits of the lamprey?

abundance. This is an adaptation to the difficulties involved in finding the special host in which development may proceed. This is more striking because many parasites require two different hosts in order to complete the life cycle, and great mortality accompanies the passage from one host to another. A good illustration of such parasites is the tape-worm which infests the trout in Yellowstone Lake. The larvæ enter the tissues of the trout and by their ravages weaken and kill the host. The dead fish are eaten by pelicans. The worms develop to the adult, sexual condition in the digestive canal of

this second host and the eggs or young embryos escape into the water with the excreta and from there are taken up by other trout whose destruction is again wrought by the tissue-infesting larvæ. This passage from one host to another probably arose, and is helped, by the carnivorous habit among animals.

The parasites are almost exclusively invertebrates. The worms and arthropods furnish the most numerous representatives. The gregarines, and some other Protozoa, are internal parasites, often being parasitic *within* the cells. There are only a few parasitic vertebrates, and these are transient. They belong to the lower fishes (lamprey, Fig. 64).

Parasitism is a very successful adaptation to a much limited environment in which the organism has bartered its original powers for a life of comparative ease. The only necessity still resting upon it is in the matter of reproduction, and the success with which this needful function is accomplished shows us that the parasite must be considered well adapted to its conditions, notwithstanding its degeneracy. Its chief hazards are met in the passage from host to host and these are overcome by the carnivorous and omnivorous habits of hosts and the extraordinary powers of multiplication on the part of the parasites.

165<sup>a</sup> **Practical Exercises.**—Enumerate all the parasites, transient and permanent, known to infest man, and find to what groups of animals they belong. Report on the habits of the principal parasites on man: as tape-worm, trichina, hook-worm, etc. What other hosts are demanded to complete the life cycle? What are the principal sanitary conclusions to be reached? Examine the mouth-parts of the mosquito (see Fig. 65). To what kind of feeding are they adapted?

166. **Habits and Instincts in Relation to Adaptation.**—In the study of adaptations there is constant danger lest we come to consider that structures alone are adaptive. In reality, adaptation in the manner of doing things is quite as important as in the structure of the organs by which work is done. When even the simplest organisms are acted on by an external stimulus they respond to it in some way. This response may be either advantageous or disadvantageous to the organism. If unfavorable, the result may be disastrous. If favorable later repe-

titions of the stimulus are all the more likely to be answered by the same kinds of response as in the first instance. This individual acquirement of a special mode of responding to stimuli is known as *habit*. Since responses in higher organisms occur by means of the nervous system we rightly associate habits with the nervous activities. In reality, however, mere protoplasm may acquire these habitual modes of action, and one

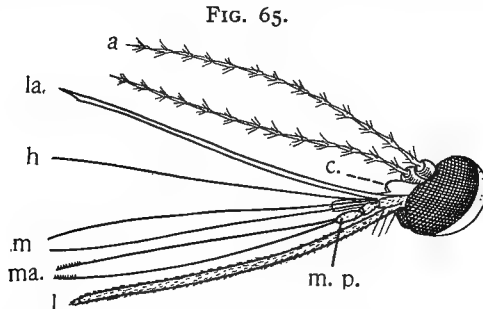


FIG. 65. The head of female Mosquito (*Culex*). After Dimmock. *a*, antennæ; *c*, clypeus; *h*, hypopharynx; *m*, mandibles; *ma.*, maxillae; *m. p.*, maxillary palpus; *l*, labium; *la.*, labrum (epipharynx).

**Questions on the figure.**—In what way and for what purpose are the mouth-parts of the mosquito used? What are the probable functions of the antennæ? Compare the antennæ and the mouth-parts of a male and female mosquito. See also Fig. 42. Mention some respects in which the mosquito is adapted to its mode of life? What extent of horopter do its eyes command? To what degree is the mosquito parasitic?

might say that all such adaptations are dependent on the power of protoplasm to respond to external stimuli. By reason of this power of adaptive responses, organisms may become habituated or acclimatized to changes in their environment, their habits or responses changing according to the necessities of the case. It is a matter of common observation that animals can thus gradually be brought to the endurance of conditions which would originally have killed them. Such must have been true of the animals which have come to live in the waters of hot springs. Such must have been the way in which other animals were changed from the marine to the fresh-water habit, since all fresh-water animals are believed to have been derived from marine forms.

Similarly in the history of any species those individuals which respond in suitable or advantageous ways to the stimuli brought to bear on them are selected from generation to generation in preference to those not so responding, and in the course of time certain modes of action become characteristic of the species, even without the necessity of individual experience. In other words the protoplasm has become so modified in a series of generations that responses of a definite kind may be expected of it, which cannot be looked upon as individually acquired habits. These are *instincts* and embrace many of the most interesting activities which have been mentioned as characteristic of animals. The instincts of feeding, mating, and the like are examples. If instincts are in conflict, that which is momentarily the stronger prevails. In this possibility of situations arising in which the instincts are in conflict, or are unequal to a correct solution, lies the advantage of *intelligence* and choice based upon memory and reason, as adaptations whereby experience may contribute to correct responses to external conditions. Of the utmost importance in the development of intelligence is the introduction of imitation, of training, of experience, of memory, of imagination—factors more or less represented in the activities of all the higher animals. It is necessary to remember that what we call intelligence does not arise suddenly in the animal kingdom and is not confined to the highest animals. Many of the acts usually spoken of as instinctive are not purely so, but are the results, in part of imitation, parental or social training, and individual trial and error, and are therefore to be classed as habitual or intelligent.

**167. The Dispersal of Animals and the Formation of Special Faunas.**—In section 140 we see that every point occupied by the individuals of any species becomes, under natural influences, a centre of distribution from which the species will spread in all directions, unless kept back by adequate barriers. Thus we should expect all animals to be found all over the earth if all the conditions were equally suitable and all animals were equally adaptable to varying conditions. This, however, is not so. Species have unequal powers of adaptation to the different conditions and thus it comes to be that certain groups



of species adapted to some special environment will be found together in certain regions, but will be absent from others. The total animal life of any region is known as its *fauna*.

168. **The Original Home of Animals, and the Sea-faunas.**—There can be no reasonable doubt that animal life began in the sea and close to its surface, and probably not close to the shore. From this region the various nooks and crannies of the earth have been occupied, until now it seems that there is no place which does not have at least a few animals suited to its conditions. The fauna of the surface of the mid-ocean is known as the *pelagic* fauna. It is made up largely of protozoa; certain more or less transparent, free-swimming types of invertebrates, as worms, jelly-fishes, tunicates; many minute crustacea, and fishes. The *abyssal* or deep-sea fauna contains representatives of all types of animals from protozoa to fishes, notwithstanding the darkness and the great pressure of the water. Many of the forms are highly modified, differing markedly from the corresponding species found in other life-regions. The *littoral* or shore fauna is the most varied, abundant, and interesting of the sea-faunas. Indeed there is no place on the earth where life is more abundant. This is true because of the wonderful food supply brought from sea and land and broken up by the waves, and the great variety of physical conditions at the meeting of land and water.

169. **Library Exercises.**—What are the special conditions of each of the regions indicated in the preceding section, which are likely to be favorable or unfavorable to life? Illustrate more fully the typical forms characterizing each region? Find instances of the special adaptations which seem peculiarly advantageous to some of the animals frequenting each region.

170. **Fresh-water Faunas.**—From the littoral regions of the sea, animals doubtless originally migrated into the brackish water of the mouths of rivers. Thus certain types came to inhabit the fresh waters of the streams, and as the result of the adaptations thus made necessary new species arose distinctly different from their relatives which remained in the sea. The most of the branches or phyla of the animal kingdom have their fresh-water representatives, but very few

species of the sponges, the jelly-fish group, and none of the starfish group have left the salt water. Some species of animals, as the salmon and eels, pass back and forth from fresh to salt water in obedience to their spawning or other instincts, but these are not very numerous.

171. From the fresh-water fauna or from the ocean shore fauna have come those species which have acquired the power of breathing by means of the air. These embrace some worms and mollusks, the insects, and the vertebrates above the fishes. This adaptation, which is one of the most important acquired in the history of animal life on the earth, is assumed to have come about through successive mutations making possible the increased use of oxygen from the air as well as from the water. Progressive mutations of this sort were doubtless associated with periodic drying up of fresh-water basins, and gradual migrations to land. Several types of these terrestrial animals have achieved a more or less complete mastery over the air (*aërial fauna*) by means of flight. Chief among these are the insects, the first group to accomplish the task; a group of reptiles in early geological times; the birds; and a few mammals (as the bats). Animals after passing from one region to another may in their descendants re-occupy their old habitat. Thus the whales and seals are air breathing mammals and are probably descended from land forms, but have now become aquatic. The same is true of some reptiles. Some birds have lost all their powers of flight and have become purely terrestrial.

Other divisions of the continental and oceanic faunas into geographical faunas are made, depending on the climatic conditions and the geological history of the regions. The facts governing this division are too complicated for our present purposes.

172. **Distribution of Animals in Time.**—This geographical distribution of animals on the surface of the earth does not come from modern conditions merely. Throughout all the millions of years that the earth has been reaching its present conditions and has been inhabited by living things, forces similar to those we now know have been at work. During all this

time, with geographic and climatic changes, the living things were changing both in their nature and their position on the earth. Thus during the various geologic periods, the distribution and character of the life of one period determines the life of the next.

All our knowledge of the life of the earlier times is gained from fossil remains found in the limestone, sandstone, clay and other strata of rock. Of course only the hard parts can be preserved, and only a small proportion of these are found in a form to give us much information. Notwithstanding, we are able to get from the strata a very fair idea of the progress of life on the globe. In the earliest fossil-bearing strata we find only invertebrate remains. The invertebrates have continued through all the successive strata to the present time, but in doing so they increase in differentiation and become more and more like present invertebrates. Of the vertebrates the fishes appeared first, then the amphibians, reptiles, mammals, and birds. None of these when they first appeared were like their modern successors. As we pass upward through the strata, old species become extinct and new ones, more and more like the species of the present, arise from them, presumably by the changes made necessary in becoming adapted to the changing earth conditions. In a general way the fossils of any age are intermediate—"connecting links"—between those of the ages preceding and following. In other words plants and animals have gradually been making progress toward present forms through all these ages. The study of this department of the adaptation of animals is known as *Palæozoology*.

### 173. Summary.

1. It is necessary to consider the individual not merely as a group of cells and tissues but as a unit acting and being acted upon by all external forces and by other organisms.
2. Characteristics derived from the germ cells of parents, whether resulting in similar qualities or in new ones, are described as hereditary. The reproductive cells are the carriers of ancestral qualities.
3. Individuals vary as the result (1) of internal conditions and changes, the causes of which are obscure, and (2) of differ-

ences in the environment. The environment may produce very important changes during the single life of the individual.

4. The food supply of animals is limited, since all ultimately depend on plants; any species multiplying at its average rate of increase could in a short time, if unchecked, stock the earth up to its limits of support; that this does not occur is due in part to a struggle for food among the excessive numbers which are born, whereby only a small percentage of them reach maturity. In the main, those survive which possess some qualities which tend to fit them for the environment in which they find themselves. These are thus enabled to transmit their inherited qualities to their offspring, the fittest of which are again chosen. The result is adaptation, and the process is known as natural selection.

5. A similar result is effected by man in domestic animals by artificially selecting individuals in accordance with the possession of certain inherited features. The resulting forms are frequently very unsuited to the natural environment, and could not survive if left to themselves.

6. As the result of various causes animals become dispersed from their point of origin, and in becoming adapted to the different regions into which they go, or through variation within a given region, give rise to new varieties. When, by any means, these groups have become perfectly adapted to their new special environment and permanently different from their parent stock and from each other, without intermediate individuals which manifestly connect the varieties, they are recognized as new species. Through the influence of heredity and by natural selection these differences may accumulate, apparently to any amount.

7. The nutritive function relates particularly to the continued existence of the individual; the reproductive function looks to the continuance of the species, and is a tax on the individual. Nature has specially favored those organisms in which an increasing degree of energy is given to the production and care of the young. Both in parenthood and in the struggle among the young nature sacrifices the individual to the welfare of the species.

8. Animals become adapted to all the influences that tend to make or mar their success in life. The more influential upon living things the factor is the more certain the adaptation, whatever may be the actual *cause* and *origin* of the adaptation, because the destruction is the more certain in case of failure. The principal classes of adaptations are,—those relating to the using of the favorable and resisting the unfavorable features of the inanimate environment; those assisting in the obtaining of food whether vegetable or animal; those of mating and care of young; those of offense and defense, in predaceous animals and their prey. The relations and adaptations range all the way from indifference to friendship, and from feeding at the same table on the one hand, to the utmost antagonism on the other.

9. Perhaps the most important and the least understood of the series of adaptations which animals acquire are those connected with the nervous system and its functions:—the instincts, habits, and intelligence of animals. They are inseparable from those already enumerated, and yet in fundamental importance they form a group of their own. They seem primarily to depend upon the irritability of protoplasm which enables it not merely to *respond* but to become *permanently changed* by that response—a kind of organic memory. From this fact acclimatization and adjustment become possible.

10. In being scattered from their starting place, animals with similar powers of response and adaptation come to be located in the same kinds of conditions. This results in faunas more or less characteristic of all the important kinds of environments: as marine, brackish water, fresh water, terrestrial, aerial, cavern faunas, etc.

11. The origin of animal life was in the ocean, and from these marine types it is believed that all other forms of animal life have come, by gradual adaptation to their present mode of life.

12. The various climatic zones of the earth and the principal geographical regions are characterized by distinct forms of life. For example, the lake life of Africa differs from that of North America, and similarly for all the various types of

fauna. An analysis of such facts and an explanation of them belongs to the *geographical distribution* of animals.

13. Fossils are remains of former plant and animal life preserved in the rocks. We read much of the ancient life history by a study of these fossils. We learn chiefly that life started in a more lowly and more simple form than we now find it; that it has been getting more complex and more like the present with each passing age. What we find then at the present moment on the earth is not the result of present forces. It is the result of all the past.

174. **Topics for investigation**, in field, laboratory and library:

1. What constitutes individuality in animals?
2. In what respects (enumerate) and to what degree have you ever noticed variation in a given species? In the offspring of a pair of parents?
3. Have you ever observed any changes in structure in animals which could reasonably be attributed to change in environment? Give evidence.
4. Does use or disuse produce changes in the organs of an individual? Why? Give illustrations.
5. Enumerate some of the most striking facts of your own observation which illustrate heredity.
6. Cite observed instances of groupings among animals of the same species, and determine as well as you can from your observations what ends are gained by the animals from the association.
7. Make an effort to classify a series of objects, noting carefully your basis of classification; that is, the characters which you select in separating and grouping the individuals. The teacher can make this a most instructive exercise. A few objects of considerable diversity may be chosen, as sand, pebbles, shells, crystals, a plant, an animal, and the student may be required to examine each as fully as he can, write out the characters which he discovers as belonging to each, being sure that he uses a *simple* and *observed* feature in each statement. On the basis of these recorded observations let him compare and group the objects. Or take a large number of relatively similar individuals and, without stopping to write their characters, let the student place or distribute them in groups near or remote from each other in proportion to their unlikenesses, allowing intermediate forms to stand between. Afterward he may be caused to determine and justify his classification and to see whether other classification could be made with a different basis. Gasteropod shells, illustrating varieties of the same and different species; beetles; butterflies; grass-hoppers; or even books of diverse shape, binding and contents may be used.
8. Can you suggest any *cause* for the loss of organs of parasites? Any advantage?
9. Cite instances from you own observation in which animals use the leap or spring in capturing prey or escaping enemies. Why is it a peculiarly advantageous adaptation?
10. Cite instances of the food-storing instinct, with all observed details. What is the most remarkable fact about them? How is it useful?

11. From reading and observation would you say that there is any definite relation between the instinct for home-building and parental care?

12. Study sleep among animals. What is its relation to rest? Is it found in the lower animals? To what is sleep an adaptation? When does sleep commonly occur among animals? Why? Do plants show any sleeping qualities?

13. What are the principal geographical faunas recognized by zoologists. Enumerate the more important means by which dispersal of animals from one region to another occurs. What are the chief barriers to the dispersal of land animals? of aquatic animals?

14. Study the different authors to which you have access, as to the significance of the terms *species* and *variety* (or subspecies).

15. What were the older views concerning the "fixity" or invariability of species?

16. What are the different views of the "Origin of Species," as based on the views of the meaning of species?

17. What is the essential difference between the theories of "natural selection" as stated by Darwin, and "definite variation," as explaining adaptation of organisms to their environment.

18. What additional ideas are introduced by the "mutation" theory of De Vries? What reasons does he give for thinking that natural selection is not a very important factor in adaptation? Bearing of Johanssen's discoveries upon the Darwinian theory?

19. The bearing of Mendel's discoveries and the recent additions to these upon such problems as variations; species; mutations; natural selection; adaptation.

## CHAPTER IX

### A GENERAL REVIEW OF THE ANIMAL KINGDOM

Before undertaking the study of the special groups into which animals are arranged because of their apparent kinships, it will be advantageous for the student to look briefly at the whole field of animals,—the “animal kingdom.” See Fig. 66.

175. **Class Mammalia.**—Beginning with man himself it is easy to see that there are numerous animals (as the apes and monkeys; the various quadrupeds, as the horse, ox, dog, cat, bears and squirrels; the whales and seals; and many others) which differ much in general appearance from him but are like him in very many remarkable particulars. For example, they all (with certain exceptions) bring forth their young alive and in a more mature condition than is usual for other types of animals, the young being carried in a special organ of the mother's body, often until development is well advanced. After birth the mother produces milk in special glands for the nourishment of the young to a still more mature stage. This is seen in no other group of animals beside the mammals. The skin produces hair or wool as a covering for the body. Man differs from the other mammals in certain particulars but not nearly so much as he and they differ from other animals.

176. **Class Aves.**—Another well-developed but relatively small group of animals is the class known as birds. There is scarcely another class of animals so easy to distinguish at sight as this. They equal or surpass the mammals in specialization, but are very different from them. They are commonly recognized by the body-covering of feathers, the modification of the front limbs into wings for purposes of flight, and by the fact that the jaws are sheathed in horny matter and, at least in present day types, birds do not possess teeth.

177. **Class Reptilia.**—This is a class recognized by zoologists which is not nearly so easy to define or to identify as either of



the preceding, partly because the animals composing it differ more among themselves than in the other classes. It includes animals as widely different as snakes, lizards, turtles, and croco-

FIG. 66.

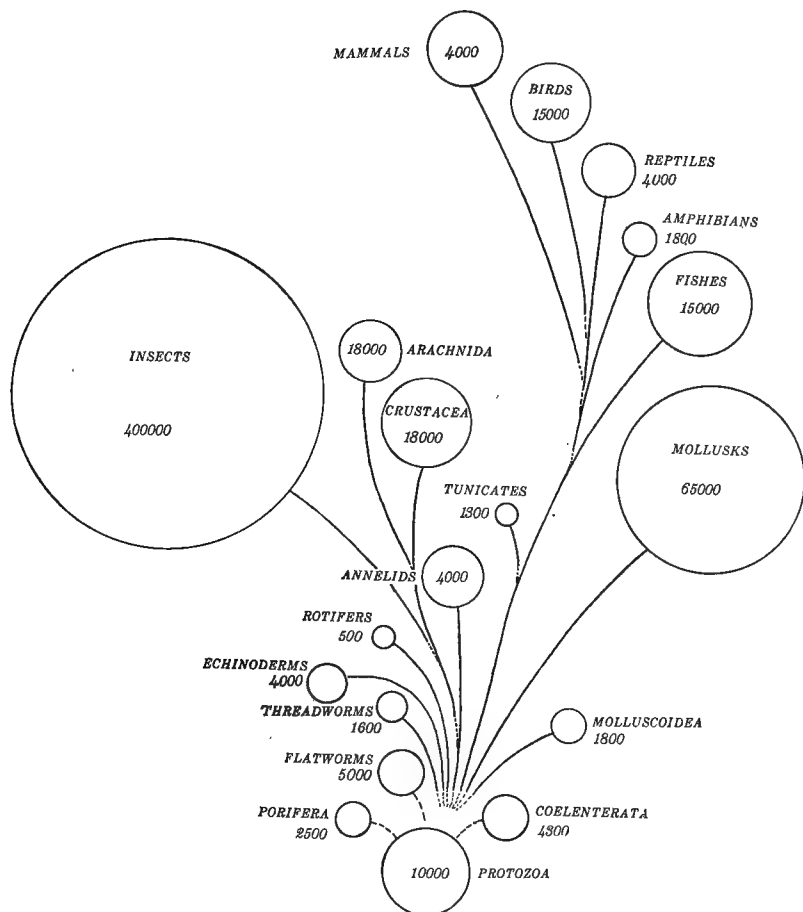


FIG. 66. Diagram showing the general relations of the chief divisions of the animal kingdom. The number of species belonging to each is roughly approximate, only.

diles. The reptiles have some features which indicate that they may be distantly related to both birds and mammals, as well as to the next class. This is an additional reason why the group of reptiles is a difficult one to define. In general they may be recognized by the fact that their bodies are covered by

scales or plates instead of hair or feathers. They always breathe oxygen from the air, as do birds and mammals. They usually have only three chambers to the heart whereas in the former groups there are four. The blood is not constantly warm as in birds and mammals. They lay eggs very much like those of birds.

178. **Class Amphibia.**—In external appearance the members of this class often look somewhat like reptiles, and they have certain possessions in common with them, as the cold bloodedness and the three-chambered heart. They are especially noteworthy from the fact that they begin life usually breathing oxygen from the water as fishes do, and later in life lose their gills, acquire lungs, and get their oxygen from the air, as do the reptiles and higher forms. Amphibians include the frogs, toads and salamanders. This is not a very important group in nature, but is intensely interesting to the student of zoology because it seems to be a connecting link between the air-breathing and the water-breathing forms.

179. **Class Pisces.**—Fishes are cold-blooded animals characterized by the fact that they breathe by means of gills throughout life. The body is often scaly; the appendages are fin-like; and the heart has two chambers. They are beautifully adapted to life in the water and are easily recognized.

180. **Vertebrates and Invertebrates.**—All the animals of which we have thus far spoken agree in certain particulars. They all possess a dorsal rod of supporting matter (*notochord*; see §349), which is often surrounded by cartilage or bone (the *vertebral column*). The nervous system in all of them is dorsal to this rod and to the digestive tract, and is tubular in character. The heart is ventral to the digestive tract and the blood has red corpuscles. They are called *Chordata* (having **notochord**). This is the highest, best developed *phylum* of the animal kingdom. The five *classes* which have been mentioned are included in it. All other animals, with the exception of a few which seem intermediate in some respects, are classed as *Invertebrates*, and agree in general in the following facts:—there

is no notochord or vertebral column; the nervous system is chiefly ventral to the digestive tract; the heart, when present is dorsal; and the blood usually has only colorless cells. The principal phyla of the Invertebrates follow.

181. **Phylum Arthropoda** (*jointed feet*).—This is by far the largest phylum of the animal kingdom. It embraces crayfish, lobsters, crabs (*Crustacea*), which for the most part have gills and live in water; the *Insects*, as bees, flies, beetles, butterflies, etc., which usually live in the air and get their oxygen from it; the *spiders* and *mites* whose habits and appearance are somewhat similar to those of the insects; and the *myriapods*, terrestrial forms easily recognized by their elongated body composed of a distinct head and a uniform segmented trunk bearing numerous pairs of legs. Arthropods are especially to be recognized by the fact that their bodies are segmented, are bilaterally symmetrical, and have paired jointed appendages to many of the segments. In addition to this there is an external covering of resistant substance (*chitin*). This serves for the protection of the animal and for the attachment of the muscles within.

182. **Phylum Mollusca** (*soft*).—This branch of the invertebrates includes the snail, clam and oyster, the squid and devil-fish, and their kind. They differ very much among themselves but agree in the lack of segmentation of their bodies, in the absence of paired appendages,—and in those types most commonly known to the student, in the presence of a shell of one or two valves, which is secreted by a fold of the skin called the *mantle*.

183. **Phylum Echinodermata** (*spiny skin*).—These are easily recognized by the possession of five or more arms or rays in the adult stage. Usually a skeleton is developed in the skin. This is often covered with spines, and from this fact the phylum has its name. They are marine and are slow movers,—a few being fixed by stalks to objects in the ocean. The starfish, sea-urchin and sea-lilies are representatives.

184. **Phylum Annelida** (**Segmented Worms**: *with rings*).—This phylum is similar to the arthropods in that the body is bilaterally symmetrical, is segmented, and sometimes has paired

appendages on many of the segments. The segments are more nearly homonomous than in typical arthropods. The earth-worm, many types of aquatic worms, and leeches are included here.

185. **Unsegmented Worms** (embracing numerous ill-assorted animals of doubtful relationship). Here may be included a number of small groups many of which were once classed with the Annelida and called "worms." They are not sufficiently alike to be regarded as one distinct phylum. Indeed there are probably three or four small phyla included. The majority of them are bilaterally symmetrical, unsegmented and without appendages. They differ from the mollusks in that they do not possess a mantle and usually do not secrete a shell. Many of them are parasitic. Among these animals of doubtful relationship may be included the "flat-worms," "thread-worms," the Nemertinea, rotifers, and others.

186. **Cœlomata** (*with cœlom*) and **Cœlenterata** (*hollow inside*).—All the animals thus far considered possess during some stage of life a more or less developed body cavity or cœlom (see §58) distinct from the digestive tract. For this reason they are sometimes known collectively as Cœlomata. All the remaining many-celled animals have a general cavity which serves both as a body cavity and a digestive tract (*gastrovascular cavity*),—or to speak more exactly, there is no true body cavity. Of these the *phylum Cœlenterata* is the chief illustration. Here belong the jelly-fish, sea-anemone, and corals. They are all aquatic and are more or less tubular, sac-shaped animals often attached by one end, with the mouth, which also functions as the anus, at the other surrounded by clusters of tentacles. Many secrete skeletons, and some form immense attached colonies.

187. **Phylum Porifera** (*pore-bearing*).—This group, to which belong the sponges, is sometimes classed with the Cœlenterata. While similar to them in habit the sponges are much less highly organized and unified. Instead of a single mouth opening into the digestive tract, sponges have many openings or pores (whence the name *Porifera*) which are the beginnings of tubes

entering a central cloaca. This is in reality not a true digestive tract. It communicates with the exterior by one or more large passages. They are attached and often form large colonies by budding.

188. **Phylum Protozoa** (*first animals*).—All the preceding phyla of animals consist, in the adult stage, of many cells among which there is more or less differentiation. In all of them the adult passes through stages in which the cells are arranged in at least two layers (*ectoderm* and *entoderm*; see §55), from which the tissue-masses arise. These animals are known as *Metazoa*. In the remaining phylum—the *Protozoa*—the animals are single cells, or at most, loose aggregations of similar cells. They are the lowest of animals and are for the most part invisible to the naked eye.

189. **An Artificial Key to the Phyla of the Animal Kingdom.**

- Many-celled animals .....METAZOA.
- With true cœlom .....Cœlomata.
- Possessing notochord (and often vertebral column),
  - .....*Phylum Chordata*.
- Possess functional gills.
  - Throughout life.....Class Pisces.
  - In embryonic life only (with a few exceptions),
    - .....Class Amphibia.
- Do not possess functional gills.
  - Epidermal covering of scales .....Class Reptilia.
  - Epidermal covering of feathers .....Class Aves.
  - Epidermal covering of hair.....Class Mammalia.
- Without notochord .....Invertebrata.
- Bilaterally symmetrical (chiefly).
  - Body segmented.
    - Paired jointed appendages present....*Phylum Arthropoda*.
    - Paired, jointed appendages absent.....*Phylum Annelida*.
  - Body unsegmented; without paired appendages.
    - With mantle—often secreting shell,
      - .....*Phylum Mollusca*.
    - No mantle.....Unsegmented Worms.
  - Radially symmetrical in adult.....*Phylum Echinodermata*.
- Without true cœlom.
  - With a single mouth, which also functions as an anus: stinging cells (usually).....*Phylum Cœlenterata*.
  - With numerous incurrent openings or pores, and only one—or few—excurrent. No stinging cells.....*Phylum Porifera*.
- Single-celled animals (chiefly).....*Phylum Protozoa*.

## CHAPTER X

### PHYLUM PROTOZOA (Primitive Animals)

#### LABORATORY EXERCISES

Without compound microscopes representatives of this Phylum cannot be studied with profit in the laboratory. The *Amœba* is one of the most interesting of the Protozoa and serves well to illustrate the simplest forms of animal life, but large specimens in sufficient numbers for profitable study in an elementary class are usually so difficult to secure at the right time that it becomes a question whether they should be depended upon. *Paramecium* is much more available. Perhaps one of the surest methods for securing *Amœba* is to chop up the soft parts of three or four fresh-water mussels, placing the pieces, together with the shells, in a large shallow basin. Allow a gentle stream of water to drip into it. This keeps the water slightly agitated, causes it to run over, and prevents an undue accumulation of bacteria. The addition of a little of the surface mud secured from the bottom of several streams or ponds will make the success of the preparation all the surer. Amœbæ should appear at the surface of the mud, about the shells, or at the margins of the vessel near the surface of the water. Test all these places every day, and sooner or later the amœbæ are practically sure to be found. Paramecia will probably occur in the same preparation. Any abundant Protozoan which may appear may be studied instead of *Paramecium* or in addition to it, by means of the outline below. In order to make clearer the habits of these organisms the class may well take part in preparing cultures.

190. **Paramecium.**—This protozoan may be obtained readily by allowing fresh-water algæ, with hay or leaves, to

decay in water. This infusion should be examined every day. If the bacteria become too abundant some of the surface water may be poured off and fresh water added. The paramecia, which are just visible to the naked eye, appear as a whitish cloud in the water or may accumulate as a film at the surface. Often a sufficient number for study may be secured by scraping with a scalpel the matter which accumulates on the sides of the vessel just beneath the water surface, even when they are not sufficiently numerous to cloud the infusion. The cover-glass should be supported by sediment or by bits of cover-glass. Make outline sketches of everything which can be shown in that way. (See page 538 for statement of laboratory records.)

I. With the low power of the microscope study the following points:

1. *Activities*.—Describe, and figure as well as possible, the nature of all the movements of which the animal seems capable, using arrows to indicate directions. Can you distinguish an anterior from a posterior end? By what characteristics?

Do you find any reasons for believing that the paramecia are sensitive to external influences? What evidences? To what sorts of influences do they respond? Do they avoid objects? Do they collide with each other in motion? Do they tend to collect? Where? Are they as active at the end of the hour as at the beginning?

Make a new preparation in which the paramecia are uniformly distributed in a drop of water. Place a very small grain of common salt at the edge of the drop. What is the result? Watch the individuals under the microscope as they come into the salt solution. On a new preparation, try similarly a minute amount of acetic acid ( $\frac{1}{10}$  to  $\frac{1}{2}$  per cent. solution) applied with a capillary tube. Compare results. Try sugar; quinine.

Do you discover any instances of division or conjugation? If so, describe.

2. General form of the body. How would you describe its shape? To what degree is it capable of change? Is the body symmetrical? Give evidences. Make diagrams showing your idea of a cross-section through the middle; also of one, one-third way from each end.

II. With the high power, study,—

3. Cilia: where found? Are they uniform in length? How do they act? What results do they produce? (Place a small amount of water containing finely powdered indigo or carmine at edge of cover-glass. If the movements are too rapid a little gelatine added to the water will be of advantage.)

4. Find the mouth, with the oral groove leading to it. Position and shape? How are food particles captured? Can you find them within the body (*food vacuoles*)? How are the food vacuoles formed? Do the food vacuoles move within the cell? If so, trace their course? What finally becomes of them? Evidences?

5. Contractile vacuoles (clear spherical objects rhythmically disappearing and reappearing). Number? Position? Rate of contraction? Do they contract at the same time? What becomes of the clear material during the contraction of the vacuole? Are they deep or superficial structures? Your evidences? Does change of temperature cause any change in their rate of contraction?

6. Distinguish between the inner mass of protoplasm (*endosarc*) and an outer layer (*ectosarc*). What are the characteristics of each as regards motion, clearness, firmness, etc.? Note the changes in these portions on the addition of dilute acetic acid or iodine at the edge of the cover-glass.

7. Discover, if possible, nuclear bodies. These are not usually recognizable without careful staining. Place at the edge of the cover-glass, in a fresh preparation of *Paramecia*, a drop of 5–10% aqueous solution of methyl green. Compare the result with a permanent mount stained by suitable methods (see Appendix: Suggestions for the Laboratory).

191. **Other Protozoa.**—The pupils should examine stagnant water for as many types of protozoa as may be found. Compare these, noting the points of similarity and difference in general structure and activities. Especially profitable protozoa for laboratory work are the green flagellate infusorian, *Euglena*, which often tinges the water, or forms a green scum over shallow pools of water; the colonial ciliate form, *Vorticella*, found attached to submerged objects in ponds or pools of slowly moving streams in which there is considerable decaying organic matter. The colonies are easily visible to the naked eye. *Stentor* is a very large trumpet-shaped infusorian which may be alternately attached and free-swimming. It lives upon submerged sticks and leaves and may often be found attached to the sides of vessels in which such matter has been placed. In all such studies and identification of the protozoa the student should seek evidence of the unicellular character of the organism.

## DESCRIPTIVE TEXT

192. In this first and lowest group of animals, the individuals of which consist of single cells or loosely associated similar cells, we find something of the variety of shape which we observed in the tissue cells of the higher animals (Chapter V). The Protozoa are especially interesting to the biologist because they represent the simplest forms of animal life now found on the earth and because some of their representatives are very



like some of the simplest plants. Indeed some of them are claimed by both the botanists and the zoologists. It also seems probable that the first animal life to appear on the globe had the general characteristics of some of the Protozoa. Whether some type of ancient protozoan is to be considered as the ancestor of the higher many-celled animals or not, it is true that we find illustrated here in the simplest possible way the beginning of all those functions which are so completely distributed among the special organs of the complex animals. The *Paramecium* does in a satisfactory way all that any complex living animal needs to do in order to live and perpetuate its species.

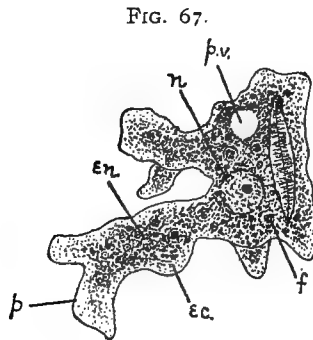


FIG. 67. Amoeba. *ec.*, ectosarc; *en.*, endosarc, containing food vacuoles (*f*); *n*, nucleus; *p.*, pseudopodium; *p.v.*, pulsating vacuole.

**Questions on the figure.**—Define the various terms used in the legend above in describing the parts of the amoeba. What changes may the amoeba undergo in its life history? Compare with figures 2 and 7.

### 193. General Characters.

1. Mostly unicellular throughout life. If colonial, all cells similar and little or no division of labor.
2. No true tissues or organs.
3. The protoplasm usually consists of a clearer outer portion (*ectosarc*) and a more granular inside portion (*endosarc*) (Fig. 68, *ec*, *en*).
4. Reproduction chiefly by fission, the resulting individuals occasionally remaining associated.

FIG. 68.

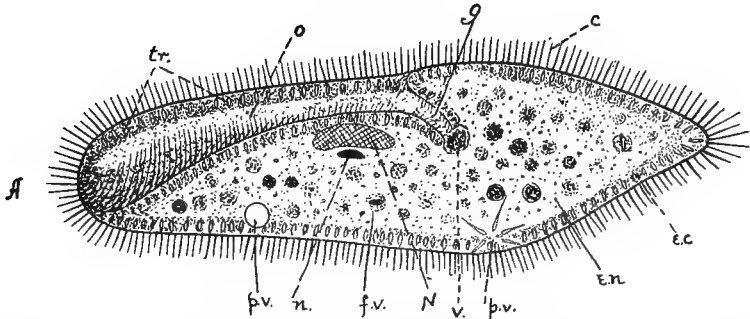


FIG. 68. *Paramecium* in optical section (semi-diagrammatic). A, anterior end; c, cilia; e.c. ectosarc; e.n., endosarc; f.v., food "vacuole"; g, gullet; N, meganucleus; n, micronucleus; o, oral groove, leading to the mouth; p.v., pulsating vacuoles in different stages of contraction; tr., trichocysts; v, food vacuole in process of formation.

**Questions on the figure.**—In what sense is the term "vacuole" descriptive of the structures to which it is applied in *Paramecium*? Describe the special adaptations of the anterior end. Judging from their distribution have the cilia any other function than locomotion? In what way are the food vacuoles formed? Why do some food vacuoles appear lighter than others?

194. **Habitat.**—Protozoa in their active stages require abundant moisture, hence they are usually found in water, fresh or salt, and as parasites in the bodies of other animals. The *Sporozoa* are parasitic. Some amœboid *Rhizopoda* infest the digestive tract of man and other animals, producing irritation and disease. The *Infusoria* occur in water in which there are decaying organic matter and minute organisms of various kinds. *Volvox* and *Euglena*, green forms often classed as Protozoa, have the power which green plants possess (*photosynthesis*) of building up carbohydrates from  $\text{CO}_2$  and water in the presence of sunlight.

195. **Organization.**—We cannot say that Protozoa have organs in the sense in which we have defined that term hitherto, yet they are certainly organized. The organization shows itself in the nucleus, in the distinction of ectosarc and endosarc, in the pulsating and food vacuoles, in temporary projections of protoplasm called *pseudopodia*, in more permanent vibratile projections of the ectosarc known as *cilia* or *flagella*, in the mouth—found in many forms, in cell-wall and secreted skele-

ton, in delicate intracellular fibres, and in stalks for attachment to objects (see Figs. 68 and 70). By means of these differentiations all the functions necessary to life are performed. There are many colonial Protozoa. In such (as *Volvox*) there may be some division of labor among the cells,—as between reproductive cells and body cells (Figs. 72, 73).

196. **Nutrition.**—The parasites absorb food, already digested and fitted for absorption, directly from their hosts. Most of the free forms take solid particles directly into the endosarc through permanent or temporary openings in the ectosarc. In some shelled forms, in which there is no mouth, the food is digested outside the body proper (Fig. 74) by the pseudopodia. These envelop the food and gradually transfer it to the main body of protoplasm through openings in the shell. In the other instances the digestion takes place in the body of the protoplasm. The enzymes found in the protoplasm are doubtless responsible for the digestive changes and act in much the same way as the special enzymes secreted from the cells of the digestive glands in the higher animals. Circulation is effected by the general protoplasmic motion. Respiration, whereby the protoplasm gets rid of  $\text{CO}_2$  and receives  $\text{O}$ , occurs largely through the cell surface without special structures. All projections of the cell-body assist in this exchange by increasing the area of the surface. Excretion may take place from the surface of the cell. It seems probable that the contractile vacuoles have both a respiratory and an excretory function.

197. **Movement.**—The majority of Protozoa move freely in their medium. In *Amæba* the motion is of a gliding character and is effected by putting forth processes into which the protoplasm streams. The process or *pseudopodium* thus enlarges at the expense of the body of the cell and progress is had in the direction of the growing pseudopodium. The direction of motion is changed by the formation of new processes in a new direction. In those Protozoa which have a cell-wall special devices enable the animals to move. Most of the free-swimming forms possess *cilia* or *flagella*, which act as oars on the

water and thus propel them. In the attached forms contractile strands (*myonemes*) extend from the body proper into the stalk. *Vorticella* (Fig. 70) by this device may change its position with much suddenness. Attached forms are able to break loose from their moorings and become free-swimming for a time, later becoming attached again. Still other species are encased in shells and are almost or wholly destitute of the power of independent motion. Even the most active types may assume the non-motile or resting stage, by which they pass, uninjured through such unfavorable conditions as drouth, cold, and the like.

198. **Sensation and Behavior.**—All the Protozoa show more or less sensitiveness to external conditions. They may be caused to contract and to move by mechanical stimuli such as contact or jarring, by chemically active substances in the water, by light, by changes in temperature, and the like. *Vorticella* and *Spirostomum* are exceedingly sensitive to contacts; *Amæba* avoids the light; many forms seem to find their food as the result of the chemical differences in the water and may be seen to swarm about suitable objects; the contractile vacuoles of many forms contract more rapidly in warm than in cold water; *Paramecia* tend to collect in groups at the edge of the cover-glass, around air-bubbles, about green filaments, or even without any foreign matter whatever. Many forms apparently lack special sensory structures and responses seem to be due to diffused protoplasmic irritability alone. In some Infusoria and some Mastigophora a special neuromotor apparatus has been found.

On the whole, when protozoa are stimulated, their response is an advantageous one. That is it is *positive*, or *toward* substances or forces that are favorable; and *negative* to stimuli that are hurtful. It is not believed that the protozoan is conscious of these conditions. It probably means that they have inherited the tendencies which through untold generations have resulted in safety. Those with wrong tendencies have been eliminated. In this way, through generations of trial and error and by adjustments on the part of the organisms they have become adapted to the present conditions of life. We have no

FIG. 69.

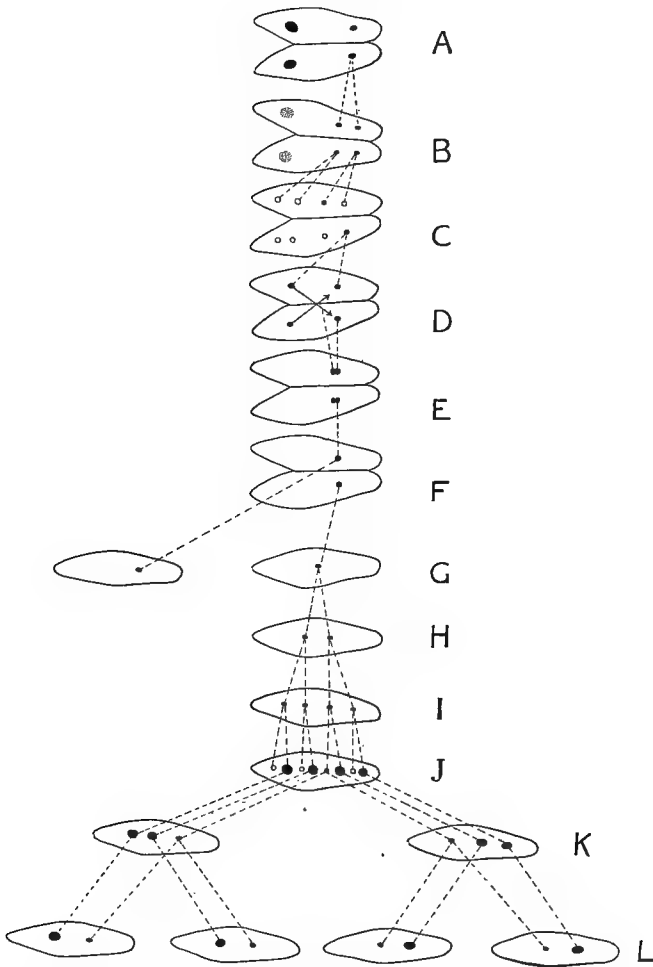


FIG. 69. Diagram showing nuclear changes taking place during conjugation (A-F) and during division (G-L) in Paramecium. (After Jennings; by the courtesy of Richard Badger, Boston.) The processes are identical in the members of the pair.

**Questions on the figure.**—What happens to the meganucleus? Trace the behavior of the micronucleus throughout. In terms of the micronucleus, what is the result of conjugation? When does the new meganucleus appear and what is its origin? What conceivable values has conjugation?

evidence that they learn by experience. They transmit their native qualities, but apparently not the results of accident, to the individual body.

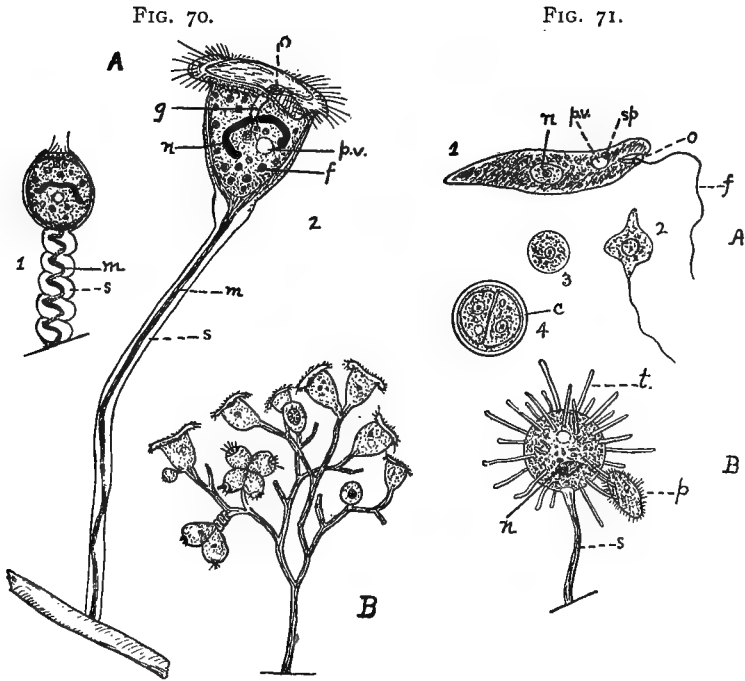


FIG. 70. A, *Vorticella*, a stalked ciliate Infusorian; 1, contracted; 2, extended. *f*, food "vacuoles"; *g*, gullet; *m*, contractile fibre (muscular); *n*, nucleus; *o*, mouth, surrounded by ciliated disc; *p.v.*, pulsating vacuole; *s*, stalk. B, a colonial type similar to *Vorticella*.

**Questions on the figures.**—Compare the internal structure of *Vorticella* with that of *Paramecium* (Fig. 68). What are the principal differences? Likenesses? How is a colonial type (as B) formed? How are new colonies started? In what way does the animal become extended after contraction? Compare living animal.

FIG. 71. A, *Euglena viridis*, a green flagellate. 1, typical swimming condition; 2, somewhat contracted; 3, spherical resting condition; 4, encysted stage in which fission has taken place. *c*, cyst; *f*, flagellum; *n*, nucleus; *o*, mouth; *p.v.*, pulsating vacuole; *sp*, pigment spot.

B, *Podophrya*, a stalked Infusorian bearing tentacles (*t*). *p*, Infusorian captured for food; *s*, stalk.

**Questions on the figures.**—How does multiplication in *Euglena* differ from that of *Paramecium*? What are the differences in the method of feeding employed in *Vorticella* and in *Podophrya*? What is the structure and function of the tentacles in the latter?

199. **Reproduction.**—In the Protozoa we discover methods of reproduction which are to be looked upon as suggestions of methods found in the Metazoa. Reproduction among the Protozoa is, primarily, mere *fission* or division of the cell-substance. In some instances this division is little more than an irregular breaking up or fragmentation of the protoplasm. In others, one or more buds may arise from the parent cell (budding). A more typical method is by the equal division of the parent into two new individuals. In still other instances, especially among the Sporozoa, there is the formation of a *cyst*, within which the protoplasm rearranges itself in numerous small bits (*spore formation*). These finally break from the cyst as new individuals. In all such cases the old nuclear material is distributed among the daughter individuals. Fission, budding and spore formation are asexual methods of reproduction.

At irregular intervals there may be a temporary (*Paramecium*) or permanent (*Vorticella*) union of two or more individuals. This is *conjugation*. The essential thing in conjugation seems to be the introduction of new nuclear matter into the cell. The full value of this nuclear fusion is still in controversy. The conjugation-cells (*gametes*) may be alike (*Paramecium*), or diverse (*Vorticella*).

*Paramecium* may reproduce for many generations by division, and then two individuals may conjugate (Fig. 69), exchange certain nuclear elements, and separate,—beginning once more their process of division. There is here no sign of sexual dimorphism in the Paramecia themselves. It has been discovered, however, that the portion of the nucleus which passes out of each conjugant into the other is smaller than that with which it unites.

In many Protozoa, as *Vorticella* and *Volvox*, there is the union and permanent fusion of the whole protoplasm of cells, distinctly different in form and size, to produce the new individual. This is much like the dimorphism found in the sexual cells in the Metazoa or many-celled animals, and illustrates *heterogamy* (see §101). Consult Figs. 7, 69, 73.

200. **History.**—The existence of the Protozoa was practically unknown until the compound microscope came into use.

A naturalist of Holland, Leeuwenhoek, first discovered the Infusoria, and thus opened up one of the most interesting

FIG. 72.

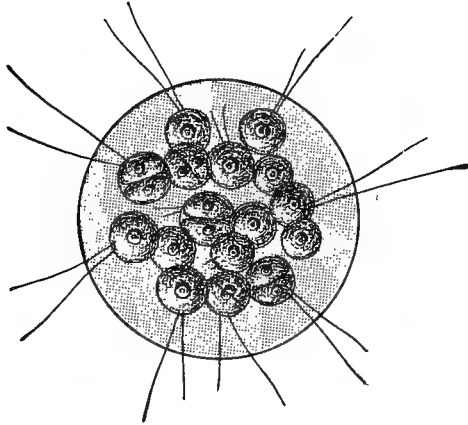


FIG. 72. *Eudorina*. A colony of 16 flagellate cells imbedded in a gelatinous matrix.

FIG. 73.

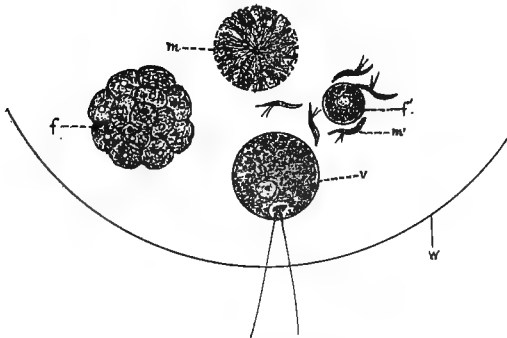


FIG. 73. *Eudorina*. The development of reproductive bodies within the colony from the ordinary vegetative cells (*v*). *f*, a mass of female gametes; *m*, a mass of male or motile gametes; *f'*, a single female gamete surrounded by 16 male gametes (*m'*); *w*, the boundary of the original colony.

Questions on figures 72 and 73.—What suggests that this is a colony rather than an individual? What suggests the reverse? Compare accounts in other texts to test your conclusions. What degree of differentiation is shown among the cells?

departments of zoology. It was not until the middle of the nineteenth century that the simple, unicellular structure of



the Protozoa was really understood. Many of them can endure drying, and then take up active life again on the return of water, so that thereupon, in a few hours, Infusoria may literally swarm where none seemed to be. This is responsible for the long life

FIG. 74.

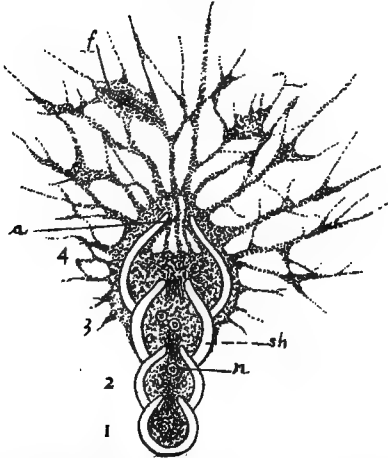


FIG. 74.—A compound Foraminiferan—*Nodosaria*. *a*, aperture of shell; *f*, food particles captured by the strands of protoplasm outside the shell; *n*, nucleus; *sh*, shell. 1-4, the successive chambers of the shell; 1, being the oldest.

**Questions on the figure.**—Does this seem a colony or a single individual? Why? Why is digestion possible outside the capsule? Compare this with figures of Protozoa in which there is no large aperture to the shell.

of the old belief that they arose by “spontaneous generation,” that is without parents. It is only in recent years that this belief has been finally disproved. It is known that they do not appear in water that has been boiled and kept free from exposure to the air. Much brilliant work has been done on the group in recent years, on structure, on behavior, and on their relation to disease.

**201. Classification of Protozoa.**—The following are the principal classes of Protozoa

**Class I. Rhizopoda (root-footed).**—Type: *Amæba*. The Rhizopoda are amœboid in form with pseudopodia, which may be either blunt (Fig. 67) or slender (Fig. 74). The protoplasm may be naked (*Amæba*) or may secrete a shell either calcareous (*Foraminifera*) or siliceous (*Radiolaria*). In the shelled forms the pseudopodia pass out through openings in the skeleton (Fig. 75). Reproduction is usually by division, or by the formation of many spores. Encystment frequently occurs.

*Class II. Mastigophora (whip bearers).* Types: *Euglena*, *Chilomonas*, *Volvox*, *Trypanosoma*. Active Protozoa which may be simple or colonial. They bear one or more large lashes or flagella. The trypanosomes are blood-parasites.

*Class III. Infusoria (in infusions).*—Types: *Paramecium*, *Stentor*, *Vorticella*. Predominantly active Protozoa, usually without shell, but with distinct cortical portion from which project permanent vibratile threads of protoplasm (cilia or tentacles), from the possession of which the sub-classes are named. There is

FIG. 75.

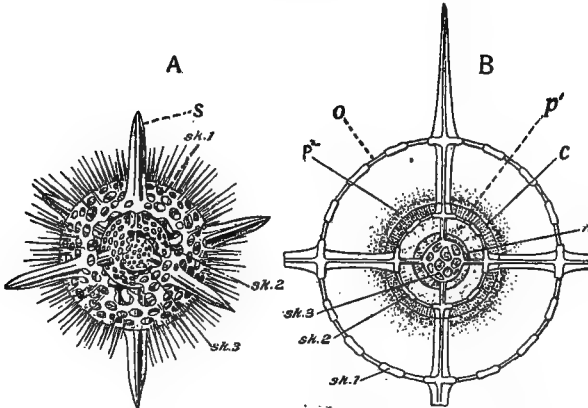


FIG. 75. *Actinomma*, a radiolarian with a shell and no mouth. *A*, whole animal with a portion of two spheres of shell removed. *B*, section, showing relation of protoplasm to the skeleton. *c.*, central capsule; *n*, nucleus; *p*, protoplasm; *o*, openings through which the pseudopodia extend (From Parker and Haswell.)

usually a permanent mouth. The nucleus is always present and assumes a great variety of shapes. The Infusoria are typically free-swimming, but many are capable of attachment by a contractile stalk, to foreign objects (*Vorticella*). Reproduction is normally by equal division, but budding and spore formation occur. Conjugation is common, and may be either temporary or permanent.

*Class IV. Sporozoa (spore animals).*—Types: *Plasmodium vivax*, *Gregarina*. Protozoa predominantly passive in habit, parasitic, with no pseudopodia, and no cilia in the adult. Remarkable for encysted resting stages and spore formation. Conjugation often precedes the formation of the cyst.

202. **Place in Nature.**—Protozoa are an important element in the food of many aquatic animals. Despite their minute size, their immense numbers and universal distribution make them important. Together with bacteria they serve to save for the organic world much decaying material which no other animals could utilize. The bacteria decompose organic matter and the Protozoa devour bacteria. They in turn become food for higher animals. We have seen that there are green forms

that manufacture their own food. Some live on débris, some are predatory, some are parasitic, and some are symbiotic with algæ. Rhizopod shells dropping to the bottom of the ocean form the "ooze,"—the chalk of later geological epochs. Other forms of limestone also are produced by the accumulations of these calcareous shells. Similar masses of the siliceous shells occur in various parts of the earth.

Some of the Protozoa, especially the parasitic Sporozoa produce diseases in man and other animals. Malaria and yellow fever in man are caused by Sporozoa and Mastigophora respectively, in the blood. In both these diseases, species of mosquitoes are the cause of the introduction of the parasites into the human system. Texas fever, one of the most dreaded of the diseases of cattle, is communicated through the cattle tick, in which the sporozoan producing the disease undergoes a portion of its life history. Trypanosomes, flagellate blood-parasites, are responsible for "sleeping sickness" in man in tropical regions. Similar parasites are found in the blood of rats and other animals.

Amœba-like rhizopods in the intestine of man cause some forms of dysentery and other derangements of the tract. Similar organisms have been supposed to cause pyorrhœa. Certain problematical organisms accompany small-pox, hydrophobia, and other diseases, though it is not known whether they have an active influence on the diseases.

Pieces of such Protozoa as *Stentor* have been shown to be able to regenerate a whole animal, provided a portion of both nucleus and protoplasm are present, but not otherwise. This shows that each is necessary to the activities of the animal. Because they are lowly and simple animals, we must not consider that they are either unimportant or unsuccessful in the struggle for existence. Their wonderful reproductive power insures that they hold their own whenever the conditions are at all favorable for them. They occur in practically all the waters of the earth, increasing or decreasing as their food varies in abundance.

### 203. Supplementary Studies for the Library.

1. The reactions of Protozoa to light; to chemical substances; to heat; etc.

2. Their power of resistance to heat; cold; drouth. The practical results thereof.
3. The economic importance of Protozoa.
4. What is "plankton"? What is the importance of its study?
5. Conjugation in Protozoa. Compare methods of reproduction and conjugation in the various groups. Follow the nuclear changes in conjugation of *Paramecium*.
6. Why should *Volvox* and *Euglena* be considered animals rather than plants?
7. Diseases in man or animals believed to be caused by the *Sporozoa*. The rôle of the mosquito in the life history of the parasites causing malaria and yellow fever. The life cycle of these parasites. The bearing of these facts upon infection and the management of these diseases.
8. Various forms of the Protozoa of different classes as shown by the illustrations in the larger text-books.
9. The varying form of the nucleus in different species of Protozoa.
10. The history of discoveries relating to Protozoa. Improvements in technique which have made these discoveries possible.

## CHAPTER XI

### PHYLUM PORIFERA (Sponges)

#### LABORATORY EXERCISES

204. **Grantia**.—This is a marine sponge and in consequence the majority of schools will be compelled to depend upon alcoholic material. *Grantia* occurs along our New England coast, and is found attached to piles or to stones a few feet below the low-tide mark. If the school is near the coast the living sponge should be studied in a basin of sea-water.

1. *General Form*.—(Keep in a watch-glass, covered with the preserving fluid.) Make careful outline sketches of everything discovered.

*Note*,—the basal or attached portion; the column; the free end. How do the ends differ? Are there any openings?

Do you find any connection between individuals (budding)? Are these individuals of equal size?

2. *Structure*.—Split the body longitudinally with a sharp scalpel, and examine with hand lens or a low power of the microscope.

*Study*,—body wall; cloaca (internal cavity); the relation of the cloaca to the osculum (the opening at the unattached end).

By what is the osculum surrounded? Notice in the wall of the cloaca the minute openings of the radiating chambers. Do they communicate with the exterior? What are the functions of the osculum and of the pores? Evidences?

3. Make thin cross sections with a razor, mount under cover-glass, and examine further for points in 2. Do both internal and external pores open into the radial chambers? Notice the spicules. Is there any regularity in their arrangement? What differences in shape and size have you discovered in the spicules from different regions of the body?

4. Place a bit of the sponge in a small amount of a 5% solution of caustic potash and boil. Examine under high power, and draw the differently shaped spicules.

5. Place a bit of the sponge on slide and allow weak acetic or hydrochloric acid to pass under the cover. Note and interpret results.

### 205. Comparison Demonstrations.

1. *Fresh-water Sponge*.—In portions of the country where the streams are clear, swift, and with rocky bottoms, a fresh-water sponge may often be found which will be valuable to compare with *Grantia* or to substitute for it. It grows attached to submerged objects and is commonly of a dirty greenish color, though this may vary. This sponge is firm and gritty to the touch, and may be either compact or branched. Use the general outline prepared for *Grantia*, noting the points of contrast. Is there anything like the osculum? the cloaca? Gemmules or reproductive bodies may occur imbedded in the flesh, especially at the base.

2. *The Sponge of Commerce*.—This is merely the skeleton of a sponge from which all the cellular part has been removed. Select a small rounded specimen. Do you find any signs of the attached end? of an osculum? Split the sponge with scissors, beginning with an osculum. Are there any canals as in *Grantia*? If so, what is their arrangement? Examine a small portion of the skeleton under the microscope. Test as before (for calcium carbonate) with dilute acid. Is the skeleton elastic? Why?

## DESCRIPTIVE TEXT

206. The Protozoa are unicellular animals, or at most, masses of similar cells in a more or less globular form. This condition is comparable to the morula stage of the embryos of higher animals (see §54). In all the other groups (Metazoa) the cells at some stage in development are in at least two layers, an inner and an outer or superficial layer, a structural condition which we have seen at its simplest in the gastrula (see §55). The exact position of the Porifera in the animal series has long been a matter of debate, but the great majority of zoologists agree that they stand below all the other Metazoa, presenting transitional features between the Protozoa and Metazoa. For this reason they are especially interesting. Some authors include them with the next phylum—the Coelenterata. They possess two cell-layers, but the division of labor among the cells is not so decided as in the Coelenterata, and the individual cells are very much more independent of each other in consequence.

### 207. General Characters.

1. Porifera possess a system of internal chambers through which the water flows. The water enters by means of many minute pores at the surface, passes along radiating tubes (*incurrent* and *radial canals*) to the central cavity (cloaca) and escapes through one or more larger openings (*oscula*) at the unattached end. There is no true *cœlom* (see §58).

2. Parts are arranged about the central cavity but usually not in a symmetrical fashion.

3. There are two distinct layers, dermal and gastral. These are separated by a gelatinous middle region in which are included

FIG. 76.



FIG. 77.

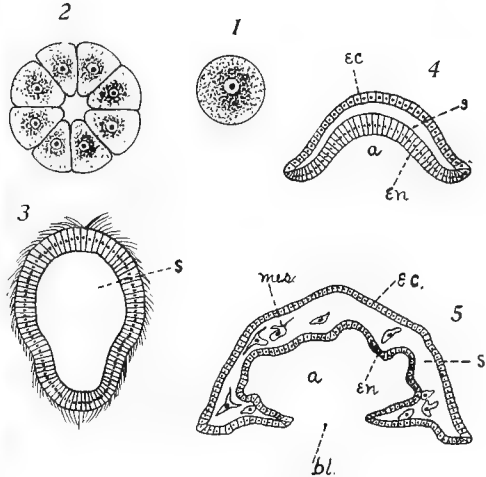


FIG. 76. *Leucandra*, a simple type of sponge. (From Delage and Herouard; "Traité de Zoologie Concrète.")

**Questions on the figure.**—What is the position of the osculum? Which is the attached end? How many individuals are represented in the cut?

FIG. 77. Diagrams to illustrate the development of one of the simpler types of sponge: 1, the egg; 2, section of 16- to 32-celled stage; 3, section of later stage, a ciliated larva (blastula); 4, gastrula; 5, section through older larva which has become attached by the end containing the blastopore. New openings break through by the coalescence and perforation of the two layers and a form results such as is figured in Fig. 78. *a*, archenteron; *bl.*, blastopore; *ec.*, dermal layer; *en.*, gastral layer; *mes.*, mesenchyma; *s*, segmentation cavity.

**Questions on the figures.**—What terms would be applied to the cleavage and gastrulation in this sponge? What is suggested as to the mode of forming mesoderm? The attachment of the sponges by the blastopore end of the larva necessitates what later development? See Fig. 78. Examine figures in other texts of the development in other species.

cells of different kinds (*mesenchyma*) not in a true layer. In the cells of the dermal layer spicules are produced, forming the supporting skeleton (Fig. 79, *C*).

4. Non-sexual reproduction is prevalent, but dimorphic sexual cells are also formed in the mesenchyma. The sexually produced larva is free-swimming; the adult is attached.

## 5. Mostly marine; wholly aquatic.

208. **General Form.**—The simpler sponges are cylindrical or vase-shaped sacs with an opening (the *osculum*) at the unattached end. From the central cavity (*cloaca*) of the sac numerous radial passages pierce the walls (Fig. 78), and terminate directly or indirectly in pores at the surface (whence

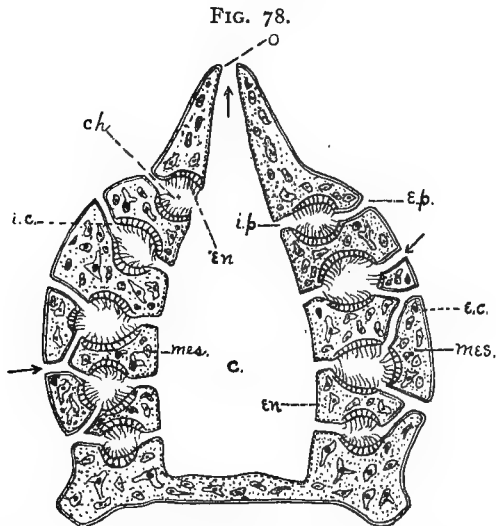


FIG. 78. Diagram of simple type of sponge, more mature than in Fig. 77. *c.*, cloaca; *ch.*, chambers, lined with flagellate cells; *e.p.*, external pores; *i.p.*, internal pores; *mes.*, mesenchyma; *o.*, osculum; *i.c.*, incurrent canals. Other letters as in Fig. 77. In the adult sponge the canals and flagellate chambers become much more complex than figured here.

**Questions on the figure.**—What portions of the animal are lined by the dermal layer? With the gastral layer? What two main types of gastral cells are figured? What is the actual nature of the mesenchyma in sponges? Is there a cœlom (a cavity bounded by mesoderm)? What mechanical advantage do you see in the fact that the water currents enter by way of the incurrent canals and find their exit through the osculum, rather than the opposite direction? Compare with Fig. 79.

the name—*Porifera*). In the more complicated sponges there is such power of budding and lateral growth that there is formed a dense tuft of sponge made up of many individuals in organic connection with each other. In such sponges the simplicity of the internal structure is lost, and the cloaca may branch, opening to the exterior by a number of oscula. The



passages which penetrate the wall become much branched and enlarged in special regions until the mesenchyma becomes honey-combed with the passages and chambers. No animals are more profoundly influenced by their environment, in respect to the special form which the individual or colony assumes, than the sponges. Individuals which develop in active currents differ much in bodily shape from members of the same species which grow in sheltered places. In all instances the form assumed appears to be correlated to the varied external conditions.

209. **The Structure of the Body.**—In the typical condition the sponge consists of an outer epithelium (dermal layer) and its derivatives, an inner epithelium (gastral layer), and an unorganized middle region (mesenchyma). From certain unusual occurrences in the early development of sponges we are not sure that the dermal and gastral layers in them are homologous with the ectoderm and endoderm in the animal kingdom generally.

The outer epithelium is usually of flattened cells. These cover the whole outer surface and line the incurrent canals. From this layer arise certain specialized cells which come to lie deeper and even to invade the mesenchyma. In the dermal layer are cells that secrete the hard parts, as spicules of lime and spongin fibres. In the middle region are amoeboid cells,—which ingest, store, and convey foods,—and reproductive cells. The inner epithelium, or gastral layer, lines the general cavity and the tubes and chambers which penetrate the body wall. In the cloaca the gastral layer is flattened; but in the radial canals it is columnar or flask-shaped, collared, and flagellate (Fig. 79, *D*). These cells by means of their flagella create the inward currents of water that bring food to the animal.

In the mature specimen all these tissues are penetrated and supported by the spicules or threads of secreted skeleton. These may be calcareous, siliceous, or horny. The sponge of commerce illustrates the last. The spicules may be isolated and independent as in *Grantia*, or become fused into a continuous framework. But for this framework the otherwise soft animal would collapse into a shapeless mass and thus close the openings whereby water brings the oxygen and food. It is the

form of the skeleton too which gives the characteristic form to the individuals and colonies of the different species.

210. **Nutrition.**—The food of sponges is essentially similar to that of the single-celled Protozoa. It is carried in by the water currents, which enter the pores, pass along the canals lined with the collared flagellate cells into the cloaca, and from there reach the exterior by way of the osculum. The food particles are taken up principally by the gastral cells lining the radial chambers and by the amœboid cells which belong to the mesenchyma. In these cells digestion takes place as in *Amœba*. The indigestible parts of the food are returned to the current and are eliminated through the osculum. There is no other circulation. The digested food apparently diffuses from cell to cell or is carried by the amœboid cells. Respiration occurs through all the cells which are in contact with the water.

211. **Sensation and Motion.**—Sponges are fixed and vegetative in their adult life, and show very little of the more active functions. In addition to the ciliated and amœboid cells already described, the pores may be slowly closed in response to stimulus. Contractile elements have been described as occurring in the epithelium of these regions. It is uncertain whether there are any nervous elements. The oscula open and close under certain conditions, the flagellate cells work in unison, and their rate may be caused to vary by change of conditions.

212. **Reproduction** by outgrowth or budding is common. In this way large colonies arise from a single individual. New colonies may arise, especially in the fresh-water sponges, by the separation of gemmules or groups of cells produced asexually within the mesenchyma. These, after a period of rest, escape and produce new individuals. Sexual reproduction also occurs in all sponges. The ova and sperm are developed in the mesenchymatous layer. The male and female cells originate from the same individual (*hermaphroditism*). Usually however the sexes mature at different times.

213. **Development.**—Fertilization of the ovum and early cleavage take place in the mesenchyma near the incurrent

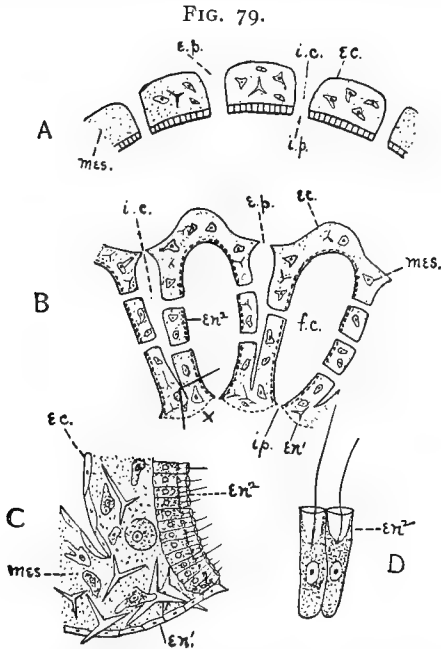


FIG. 79. Diagrams showing the arrangement of the radiating canals in two types of sponges: A, Ascon type; B, Sycon type; C, a portion (x) of the latter, more highly magnified, showing character of the three layers. *ec.*, dermal layer; *en*<sup>1</sup> gastral layer (flattened layer); *en*<sup>2</sup>, flagellate gastral layer; *e.p.*, external pores; *f.c.*, flagellate chambers of the radiating canals; *i.p.*, internal pores; *mes.*, mesenchyma; *i.c.*, incurrent canals; D, two flagellate cells more highly magnified. After Korschelt and Heider.

**Questions on the figures.**—Trace the relation of dermal layer to the gastral layer in these two types? Compare these with illustrations in reference texts. Is there any way of accounting for this disproportionate growth of the gastral layer? What are the apparent functions of the flagellate, collared epithelium? What structures are to be found in the mesenchyma in sponges?

FIG. 80. *Axinella polypoides*, showing numerous oscula. After Schmidt.

**Questions on the figure.**—What are the principal external differences between *Axinella* and *Leucandra* (Fig. 76)? How many individuals are represented here? What are the grounds for your answer? Compare this with the skeleton of the sponge of commerce.

canals, by means of which the spermatozoa find entrance. Cleavage is total and for the most part equal (see §53), pro-

ducing an oval blastula which swims freely by means of cilia or flagella. While there are some peculiar features about the gastrulation, a gastrula or two-layered embryo is ultimately formed. Strangely enough it is the flagellate cells of the larva that become the inner or gastral layer of the adult. Conversely, the cells which in other Metazoa give rise to the gastral layer form the outer epithelium of sponges.

The embryo finally settles to the bottom and becomes attached by the end containing the blastopore, which thus becomes obliterated (Fig. 77, *bl*). An excurrent pore breaks through at the opposite end, and the numerous incurrent pores are formed at the sides. The mesenchyma seems to be formed by special blastomeres or by cells which migrate from the other layers into the segmentation cavity, thus filling it. The gastral layer outpockets into the mesenchyma, establishing connection with the ingrowing dermal layer, thus forming the incurrent canals (see Fig. 78). In most species the process is much more complex than that described here.

#### 214. Classification.

The divisions of the group Porifera are made on the basis of the differences in the skeleton. Two principal groups may be recognized, as follows:

I. *Calcarea*.—Sponges in which the skeleton is composed of calcareous spicules. Laboratory type,—*Grantia*.

II. *Non-Calcarea*.—Sponges with glassy (siliceous) spicules, or with horny (spongin) fibres, or with merely a gelatinous mesenchyma. Laboratory types:—the Venus Flower-basket; the fresh-water sponge; the commercial sponge.

215. *Ecology*.—Sponges are chiefly marine animals, and flourish in all the seas and at any depth. The larger horny sponges, of which the bath sponge is the skeleton, are found in the warmer seas and in relatively shallow water. The best ones are found in the Mediterranean, in the South Indian Ocean, and about Florida and the West Indies. By reason of their budding and branching, the sponges form immense colonies or beds, and many other forms of life associate with them in varying degrees in intimacy. Worms, crustacea, and the larvæ of many forms play hide-and-seek and burrow in the thickets of growth produced by sponges. In several species of crabs their shells may be covered by sponges, thus becoming less conspicuous. In other cases the sponges may protect the

crab by their ill odor or taste. Sponges have no power of attacking any but microscopic organisms. They may, however, by their growth smother fixed animals like the oyster. Because of their harsh spicules or their unpleasant secretions they are rarely used for food by other animals.

The horny skeleton of certain species, the "sponges" of commerce, is the chief contribution of the group to human uses. Fossil sponges, apparently of the same general characteristics as those now living, are found in very early geological strata.

#### 216. Supplementary Library Studies.

1. Economic value of sponges. Sponge fisheries. Sponge "farming." The mode of preparing sponges for market.

2. What arguments may be advanced for considering the sponges as colonial Protozoa? What is the conclusive argument for regarding them as Metazoa?

3. By comparing the figures of sponges found in your reference books, note the different degrees of development of the passages lined with gastral and dermal layers in the walls of various species.

4. In what special ways do sponges become adapted to the conditions in which they are situated? Effect of rapid currents on them? Of quiet water? Of muddy water?

## CHAPTER XII

PHYLUM CŒLEENTERATA (HYDROIDS, CORALS, JELLY-FISHES, ETC.)

### LABORATORY EXERCISES

217. **Hydra.**—Hydras are small tubular animals found in permanent fresh-water pools, attached to submerged leaves, twigs, algæ, etc. They are somewhat difficult to recognize when disturbed because they contract into small rounded masses, close against the supporting object. Promising materials should be collected from several ponds, and placed in shallow vessels (a white-ware dish is good), and in a short time the hydras will become extended. The green hydra (*H. viridissima*) is perhaps more common and hardier, but is not so satisfactory for general laboratory work as the brown (*H. oligactis*), because it is less transparent.

1. Study the living animal in a glass jar (tumbler).

Is it free or attached? What happens if it is freed from its attachment? Is it lighter or heavier than the water? Evidences. Can it move from one portion of the vessel to another? If so, does it become detached? Watch some individuals from day to day. What is its position in the water? If the vessel containing hydras be placed near the window for several days, at which side of the vessel do the animals become collected? When the animals are stretched out at their greatest length, touch lightly the tip of one of the tentacles. Touch the body. Repeat the experiment until you are sure of your results. Note and explain as well as you can the results. Of what degree of contraction is the animal capable? Do you notice any contractions or motions of parts, when the hydra is undisturbed? What seems to be the purpose of the motions? Evidences? Bring a piece of meat the size of a pin-head, or a *Daphnia* or *Cyclops*, in contact with the tip of a tentacle and note the results. How do the other tentacles behave? Place a food-particle di-

rectly at the base of the tentacles. How is it swallowed? How long does it take? What becomes of it? How long does it remain in the body? Classify the results which you have attained, under the following heads:—motion and locomotion, nutrition, sensation. Devise still other experiments to test special points which you desire to know. Have you discovered anything that would lead you to think that their behavior is modified even temporarily by experience?

2. *General Structure*.—Transfer a living animal to the slide, covering it with a drop or two of water. Observe with a low power without cover-glass. Draw carefully in outline *everything* discovered.

Note body regions.

Foot (attached end).

Column.

Tentacles, position, number (examine several specimens).

Hypostome, surrounded by the tentacles.

Mouth.

To what extent do these regions vary in their dimensions during the different stages of contraction of the hydra? Would you say there is any distinct symmetry? Which is the *main* axis? Is there any indication of an internal (*gastro-vascular*) cavity? What is its extent? Are the tentacles solid structures? Evidences? Are there any buds in your specimen? Relation to the parent? To what extent do different parts of the body do different work?

3. *Microscopic Structure*.—Cover with a cover-glass supported by objects nearly as thick as the animal. Study with a higher power. Verify the points studied above. Follow the *gastro-vascular* cavity more fully. Is there an *aboral* opening?

Body wall.

Ectoderm, or outer layer of cells.

Entoderm, or inner layer of cells.

Determine the extent of each layer. Are they continued into the tentacles? What differences do you find in the thickness of the layers and in the shape and character of the cells of each layer in the various parts of the body? Is there anything between the ectoderm and entoderm?

In the ectoderm, especially in the knobs on the tentacles, find highly refractive oval bodies, the *nettle capsules*. Irrigate with a drop of dilute acetic acid, and watch the tentacle all the while. What changes have occurred in the nettle cells?

[A whole animal stained and mounted may be studied profitably in comparison with the preceding.]

4. *Histology from Sections*.—By comparison of longitudinal and transverse sections verify your observations concerning the extent of ectoderm and entoderm. What occurs between the layers? Study the shape and arrangement of the cells in both layers. Compare as to size. What is the relation of the nettle cells to the other ectodermal cells?

5. *Histology from Maceration Preparations*.—Place a specimen in a watch glass, and draw away some of the water with a pipette. When the Hydra is well extended, pour over it an aqueous solution of hot corrosive sublimate. Rinse and place in Müller's fluid or 15% alcohol for 24 hours. Take a portion of the body and place on a slide in a drop of glycerine and water. Cover, and tap the cover-glass very gently with a needle. The cells thus become separated, and their shape may more readily be seen. Instructions for staining may be found in texts on histology.

Study the nettle cells, the ectodermal cells, the entoderm, and the gland cells of the foot and gullet.

218. For comparison with *Hydra* secure some alcoholic material of some of the marine hydroids, as *Pennaria*, *Obelia* or *Campanularia*. A few slides should be secured bearing whole mounts and sections properly stained.

The following points should be studied briefly: Relation between individuals in the colonies,—branching. What classes of individuals are discoverable, *i. e.*, how do the different branches end? Is there any covering to the softer portions? Tentacles; are they present? If so, what is their arrangement? Hypostome? Mouth? Is there a gastro-vascular cavity? Ectoderm? Entoderm? Give attention to polymorphism among the *polyps* or *zooids*.

219. *Metridium* (Sea-anemone).—Using well-hardened and preserved specimens of sea-anemone make a series of cross sections from various parts of the body, with a thickness of one-eighth to one-fourth inch. These sections may be fastened to cards or to plates of mica by thread or fine wire and kept in preserving fluid. One specimen should be split lengthwise, and one left whole. Four or five specimens could thus be used from year to year for demonstration.

The following studies should be made. Make drawings to illustrate *all* points observed.

#### 1. *General Form*.

Base, or aboral disc (the end attached during life).

Column.

Oral disc: zone of tentacles; intermediate zone; lip-zone; mouth; siphonoglyphs (grooves in the angles of the mouth),—number?

#### 2. *Transverse Sections*.

Body wall.

Esophagus; does it appear in all the sections? Siphonoglyphs?

Mesenteries. How is the esophagus held in position? What differences do you find in the mesenteries? They are described as complete (or primary), and incomplete (or secondary, tertiary, etc.).



Show by a diagram the number and arrangement of them, especially of the primary. Are they in pairs? Notice the inter-mesenteric chambers. Can you find the muscular thickenings in the cut mesenteries? Sketch their position. Compare with conditions figured in various text-books.

3. *Longitudinal Section.*

Complete your study of the structures mentioned above.

Compare the complete and incomplete mesenteries.

Identify:

Mesenteric filaments (on free edge of mesenteries).

Genital glands (developed in the substance of the mesentery near the edge).

Ostia, or ring canal; openings through the mesenteries by means of which the mesenterial chambers communicate with one another.

Are the tentacles solid or hollow?

4. *General Considerations.*

Make diagrams in longitudinal and transverse view to show the distribution and connection of the cavities of the body. Is the mouth the only opening into the cavity? Describe the symmetry of the anemone. Is it radial or bilateral? Give reasons for your answer.

220. *Oculina* (or other branching coral).—Study the branches and note the position of the polyps. Is the arrangement orderly? If so, describe.

Note with a hand lens the arrangement of the septa, which grow between the fleshy mesenteries of the coral. Compare their arrangement with that of the mesenteries of the sea-anemone.

## DESCRIPTIVE TEXT

221. Some authors place the sponges and the coelenterates in the same group on account of the typical barrel shape, the absence of a true coelom or body cavity, the somewhat similar character and origin of the middle mass (mesenchyma), and the agreement of the principal axis of the adult with that of the gastrula. In the coelenterates however there are no lateral pores. The principal opening serves as a *real* mouth as well as *vent* for the voiding of undigested matter, whereas in sponges it is not a mouth in any sense. In general the *individual*, even in the colonial forms of coelenterates, is more distinctly an individual than in the sponges. The division of labor among the parts and the interdependence of parts is greater than among the sponges.

222. *General Characters.*

1. A single system of internal chambers (*gastro-vascular*

*cavity*) in which both digestion and circulation occur. No coelom.

2. Parts radially arranged about an oral-aboral axis. Tentacles usually at the oral pole (Figs. 82, 85).

FIG. 81.

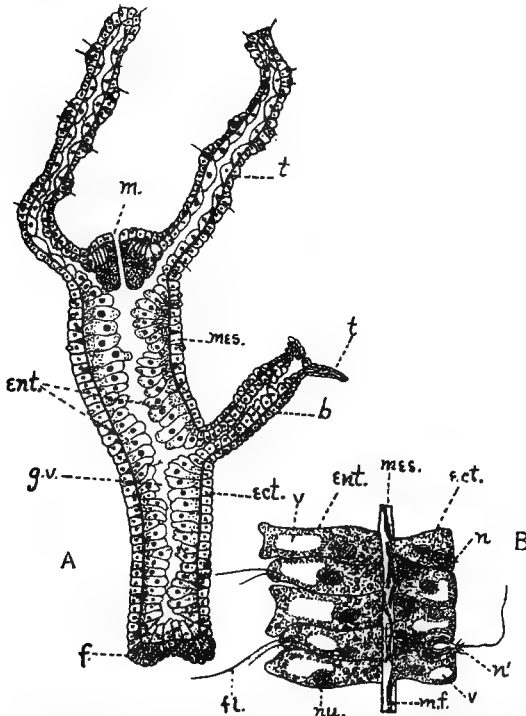


FIG. 81. *A*, Longitudinal section through the body of Hydra (diagrammatic). *B*, small portion of the wall more highly magnified. *b*, bud; *ect.*, ectoderm; *ent.*, entoderm; *f.*, foot; *fl.*, flagellum; *g.v.*, gastro-vascular cavity; *m.*, mouth; *mes.*, mesenchyma (non-cellular); *m.f.*, muscular processes of the ectodermal cells; *n.*, netting cells; *n'*, same, exploded; *nu.*, nucleus; *t.*, tentacle; *v.*, vacuole.

**Questions on the figures.**—How many cellular layers are to be distinguished in Hydra? What differentiations are represented in the ectoderm in different regions? In the entoderm? What is the relation of the bud to the adult? Why is the cavity called a gastro-vascular cavity? How is contraction effected in Hydra?

3. A supporting layer or mass (mesenchyma) between ectoderm and entoderm, sometimes without cells. More often with cells of various kinds, derived from the other layers.

4. Nettle cells in practically the whole group (Fig. 83).
5. Nerve cells (sensory) and muscle cells present.
6. Reproduction commonly by non-sexual methods, often alternating regularly with the sexual. Individuals of the two generations sometimes very different in appearance and habits.
7. Wholly aquatic; chiefly marine.

223. **General Survey.**—The Cœlenterata embrace animals very diverse in general appearance, which may nevertheless be reduced to two types. The first and most primitive is the tubular *hydroid* type. This is sessile and is essentially a gastrula, at the unattached end of which occurs the mouth, usually surrounded by tentacles. The cavity of the tentacles is continuous with the gastro-vascular cavity (Fig. 81). Of this type we may distinguish two conditions: (1) in which the individuals (polyps) occur singly (*Hydra*), or if in colonies, the various individuals have the same form (as the *corals*); (2) colonial forms in which the individuals making up the colony are very different (as the *Siphonophora*), embracing open-mouthed nutritive individuals, mouthless reproductive polyps, protective polyps abundantly supplied with nettle-cells, bladder-like supporting polyps, etc. (Figs. 86, 87). The extreme conditions of (1) and (2) are connected by forms possessing intermediate degrees of polymorphism. Though the individual polyps are attached, the whole colony may float freely. The second type is the active *jelly-fish*, or *medusoid* (bell) type. The medusæ, though varying greatly as to details, agree in having a shape comparable to that of an umbrella or a bell (Fig. 82, 6). The convex surface is normally the upper surface. At the margin of the umbrella are tentacles—often very numerous, and frequently much elongated. In the middle of the concave surface is a projection, at the lower end of which is the mouth-opening. The gullet leads from the mouth into a cavity in the central portion of the body of the bell (*gastro-vascular cavity*). From the central cavity radiating passages run through the substance of the bell to the margin where they may communicate with a circular canal which passes around the

bell near the bases of the tentacles. This whole internal cavity is lined with entoderm, and therefore no portion of it represents a coelom (Fig. 82, 6).

FIG. 82.

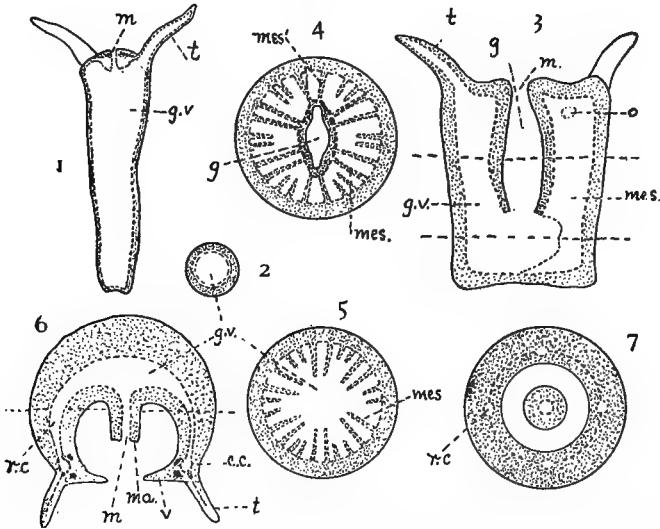


FIG. 82. Sections of types of Coelenterates (diagrammatic): 1 (longitudinal) and 2 (transverse) of a tubular hydroid; 3, Sea Anemone (longitudinal); 4, same (transverse, at the level of the upper dotted line); 5, same (transverse, at the level of the lower dotted line); 6, longitudinal or vertical, section of a Medusa; 7, transverse section of same at the level of the dotted line. The continuous line is ectoderm, the broken line, entoderm, and the stippled portion, mesenchyma. *c.c.*, circular canal; *g*, gullet; *g.v.*, gastro-vascular cavity; *m*, mouth; *ma.*, manubrium; *mes.*, mesentery; *mes.<sup>1</sup>* directive mesentery; *o*, ostium; *r. c.*, radial canal; *t*, tentacle; *v*, velum.

Questions on the figures.—By a careful comparison of the diagrams what points of similarity do you find in these three types? What are the principal points of difference? Examine similar diagrams in other texts. Why is *Coelenterata* an appropriate name for all.

The bell is comparable to an *inverted* pölyp in which the main axis has become much shortened, accompanied by a thickening of the body in the direction of the other axes.<sup>1</sup> The gastro-vascular cavity is further modified by the increase of the mesenchyma of the aboral disc and by a union of the oral and aboral walls of the cavity in certain regions. The

<sup>1</sup> See Textbook of Zoology, Parker and Haswell, 1921 edition, Vol. I, p. 138, Fig. 102.

large chambers between the mesenteries in such forms as the sea-anemone thus become limited to small radial canals.

Frequently both the tubular and the bell types are found in the life history of the individuals of a single species. The tubular colonial polyp produces, by asexual processes such as budding or fission, the bell or medusoid forms which are sexual. These may remain attached or become free swimming. They produce ova or spermatozoa, or both, and from the sexual union of these elements the non-sexual tubular polyp is again produced. This regular alternation of sexual and sexless individuals is known as *alternation of generation*. In some forms, however, the polyp has no corresponding bell (as in *hydra*; *corals*; *sea-anemone*), and for some bells (as in some large pelagic medusæ) there is no corresponding polyp stage.

224. **The nutritive processes** in the Cœlenterata are marked by relative simplicity. Food, consisting mainly of small organisms and organic débris, is taken into the mouth often with the assistance of tentacles. The tentacles are frequently armed with numerous special cells in which are developed capsules containing long stinging threads, with poisonous tips. When these threads are discharged they may penetrate and paralyze small organisms. They are very irritating even to the human skin. In some types of nettling capsules the thread forms a cork-screw coil that may take hold of the hairs or other projections of the prey. They serve as organs both of defense and food capture (Fig. 83).

Digestion and circulation both take place in a general cavity (*gastro-vascular*) lined with *entoderm*. In other words the circulatory function in this group is not differentiated from the digestive. In the colonial forms the gastro-vascular cavity of the various polyps in the colony may be directly continuous (Fig. 87). Thus a kind of cooperative digestion occurs. In the *medusæ*, the *corals*, and forms like *anemone*, the cavity is much more complicated than in the tubular *hydroids*, on account of the mesenteries. The entoderm seems to take up food from the gastro-vascular cavity, in part at least, by means of the amœboid action of some of the entodermic cells as well as by

absorption. Pseudopodia are formed, and particles are directly taken into the body of the cell. Special gland cells also occur in the entoderm, by the secretions of which the food undergoes changes preparatory to absorption. There is no anal opening. Undigested remnants are eliminated at the mouth. Respiration.

FIG. 83.

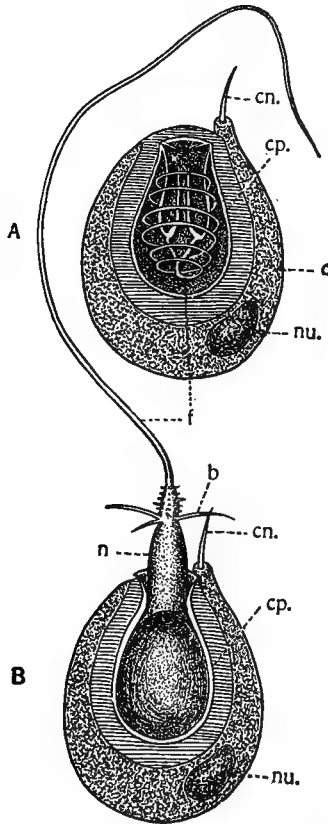


FIG. 83. Netting cells of Hydra (after Schmeil). *A*, unexploded; *B*, exploded. *b*, barbs; *c*, the netting cell in which the netting organ is developed; *cn*., the cnidocil or "trigger;" *cp*., the capsule or netting organ; *f*, the netting filament or lasso; *n*, neck of the capsule; *nu*., nucleus of the cell.

**Questions on the figure.**—Compare the parts of the netting organ before and after explosion and note the difference in position. How would the barbs in the neck of the capsule behave as it is forced inside out by the compression of the capsule? Find from reference literature the nature of the fluid secreted on the inside of the lasso.

tion—the exchange of carbon dioxide for oxygen—takes place by means of the individual cells of the body layers, though it may occur more satisfactorily in the thin-walled, more actively moving tentacles. Excretion is likewise a general body function.

**225. Motion.**—All the Cœlenterata are supplied with contractile fibres or processes. Many of these are modified ectodermal or entodermal cells rather than true mesoderm (Fig. 81, B). The fibres run both longitudinally and transversely. In the more active types cross-striate fibres may occur. The attached (polyp) forms have well-developed longitudinal fibres in the body wall and the mesenteries, which enable the soft parts of the animal to be drawn close to the supporting object. In the medusoid types locomotion is effected by rhythmic contractions of the *bell* as a whole. By this means the water is expelled from the cavity of the bell, and the reaction forces the animal forward.

**226. Support.**—The attached colonial forms (corals, sea-fans, etc.) usually possess a skeleton of calcareous or horny matter commonly secreted by the ectoderm. Each polyp contributes a portion to the common skeleton—the *corallum*. The corallum differs greatly in form in the different species. The particular form depends on the manner and rate of budding or non-sexual reproduction of the polyps, and the activity shown by the individual in secreting. In some cases single polyps produce a skeleton (*cup-corals*). The coral reefs of tropical seas are illustrations of the power of corals to form and excrete carbonate of lime. Much of the lime-stone of the earth's crust shows that corals assisted in its formation.

**227. Sensation and Behavior.**—The nerve cells may be scattered diffusely over the surface of the body with a mesh-work of fibrils to connect them with the muscular and nettle cells and with each other, as in *Hydra*. In some other polyp-forms there is more differentiation of cells and fibres, but the elements are still scattered. In the more active types there is a collection of the cells either as a continuous ring, or in groups,

in the tentacle-bearing rim of the animal. Associated with this collection of the nervous material into a kind of nervous centre, there are often special areas of sensory epithelium, or sense organs, developed from the ectoderm. It is not wholly clear what kinds of stimuli they are suited to receive although they are designated as "eye spots," or as "auditory" or "olfactory" pits. Otocysts (see §1111) are found in the *Ctenophores* and in some medusæ, and apparently function chiefly as organs of equilibration or perception of disturbances in the water.

Experiments show that coelenterates are sensitive to differences in intensity of light, to mechanical stimuli, to temperature, to gravity, and to chemical stimuli. The responses may be local, as when a *Hydra* withdraws its tentacle upon a light touch or uses all its tentacles and the region about the mouth when stimulated mechanically and chemically by its prey; or general, as when it contracts body and tentacles completely upon vigorous mechanical stimulation.

In addition to such responses to external stimuli there are in *Hydra* bendings of the body, wavings of the tentacles, and even contraction and extensions of the whole body that suggest "seeking" movements. Hungry specimens are more active than well-fed ones. All of this shows that even in the simplest representatives of the group there is effective nervous and muscular coordination.

**228. Reproduction and Development.**—The occurrence of both sexual and asexual methods of reproduction has already been mentioned (§223). It is by non-sexual budding that colonies are normally built up and a given locality well occupied by the species. By means of the sexual method dispersion is effected, and new regions are occupied. The ova and spermatozoa develop in special *gonads* (ovaries or testes) derived in some species from the ectoderm, in others from the entoderm. The sexual cells usually escape into the gastro-vascular cavity and reach the outside by way of the mouth. As a rule the sexes occur in separate individuals. After fertilization cleavage is total but sometimes not equal. A blastula is formed which is often converted into a peculiar, free-swimming, ciliated larva



(*planula*), consisting of a two-layered sac with no opening. This condition may arise by the closing up of an ordinary two-layered gastrula (as in *Aurelia*). In other cases the entoderm may be formed by cells budding into and finally lining or even filling the segmentation cavity of an ordinary blastula (Fig. 84), resulting in a quite similar condition. The planula after a brief free life becomes attached by one pole and becomes elongated; a mouth surrounded by tentacles is formed at the

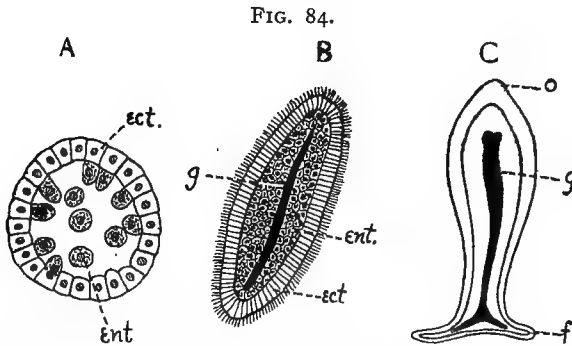


FIG. 84. Diagrams illustrating development in some of the hydroid types. A, blastula in which the entoderm (*ent.*) is produced by proliferation from ectoderm (*ect.*), B, ciliated planula formed by the continuance of this process. A split in the entoderm furnishes the beginning of the gastro-vascular cavity (*g*) of the adult. C, more mature condition, in which the planula has become fixed: *f*, foot or attached end; *o*, oral or free end at which the tentacles and mouth will be developed.

**Questions on the figures.**—How does this blastula differ from the typical blastula in the formation of entoderm? What is a planula? Is a gastrula formed? After an opening forms at the oral end what likeness is there in the adult to a gastrula? What changes would C need to undergo to become essentially similar to Hydra?

other. Thus it assumes the typical polyp form. In nearly all species the polyps may produce new individuals by buds either from the wall of the polyp or from special organs (*stolons*, or *runners*). If, when these are mature, they separate from the parent no colony is formed. More commonly the daughters remain in association with the parent. The medusoid individual,—often of a very much simpler type than that described above (§223),—may be produced in a similar way from a bud. This sexual individual may degenerate until it is little more than a case for the sexual cells. It usually breaks its

attachment with the parent stock and, in the perfect medusæ, becomes free-swimming.

229. **Classification.**—The following classes of Cœlenterata may be recognized.

*Class I. Hydrozoa* (Hydra-like animals).—Hydrozoa are cœlenterates with two cell-layers (ectoderm and entoderm), between which there is a supporting layer (the *mesoglaæ*) non-cellular in structure. The reproductive cells arise chiefly from the ectoderm. The life cycle may consist of polyps alone (*Hydra*); or of medusæ alone; or of both in one life history (*Campanularia*, *Pennaria*, *Obelia*). Medusoid forms may be free or attached. The gastro-vascular cavity is not divided by mesenteries. Here are included all the rather scarce fresh-water cœlenterates, many tubular marine forms somewhat similar to *Hydra*, and the much diversified colonies of the Siphonophora (as the Portuguese Man-of-War, found in mid-ocean, especially in the region of the Gulf Stream). See Figs. 86, 87.

*Class II. Scyphozoa* (cup animals).—Cœlenterates in which the mesenchyma contains cellular elements. The reproductive cells arise from the entoderm and escape into the digestive cavity. Chiefly medusoid forms, though in some the bell-form alternates with a polyp stage. Types: *Aurelia* and the larger jelly-fishes. The majority of the Scyphozoa swim on the surface of the ocean; some are found at considerable depths. Many of them are very large and handsome. An especially interesting fact in connection with the development of such a type as *Aurelia* is that its polyp (known as the *Scyphistoma*) is intermediate in its characteristics between the polyps of the Hydrozoa and those of the Actinozoa. The *Scyphistoma* has four ridges which *partly* separate the gastro-vascular cavity as do the mesenteries in the Actinozoa.

*Class III. Actinozoa* (ray animals).—Cœlenterates with only the polyp form. Cells in the mesenchyma. There is a well-developed ectodermic gullet (stomodæum). The gastro-vascular cavity is more or less completely divided into chambers by mesenteries. Sexual cells entodermal. A skeleton of calcareous or horny material often present.

Types: Sea-anemones; sea-fans and corals. The sea-anemones or sea-roses are common on rocks and other objects just below low-water mark. Though attached, they have some power of gradually changing their position. Species of sea-anemones are known in which the individuals are as much as two feet in diameter, though polyps of the colonial forms are usually very small.

*Class IV. Ctenophora* ("comb-bearers").—The Ctenophora are free-swimming, pear-shaped jelly-fishes, never occurring in colonies, and not associated with a polyp stage. They bear eight meridional plates supplied with transverse rows of cilia, which function as locomotor and possibly as respiratory organs, and suggest the name of the group. There is a well-developed stomodæum. The gastro-vascular canal branches from this and is much divided, one division lying under each row of combs. There are two small aboral openings to the digestive canal, known as excretory pores. The mesenchyma is well developed. There are no netting cells as in the other cœlenterates; but glue-cells with similar structure and functions are found. (Some students of the Ctenophora place them in a separate phylum.)

230. **Ecology, etc.**—The food of Cœlenterates consists largely of organic *débris* broken up by the waves, and of small

animals and plants captured by the tentacles. The attached forms flourish best in the comparatively shallow water near the shore. Food is especially abundant in such regions and hence the passive animals are more successful here than elsewhere. *Hydractina* (Fig. 85) and even the *sea-anemone* form interesting partnerships with the *hermit-crab*. The polyps may cover portions of the shell occupied by the crab, while the polyps doubtless profit by a share of the food broken to pieces by the crab,

FIG. 85.

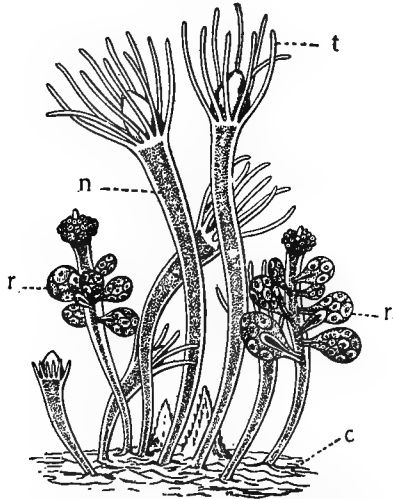


FIG. 85. *Hydractina echinata*, after Hincks. *c*, the *canosarc*, forming an incrustation over the object on which it lives; *n*, nutritive polyps; *r*, reproductive polyps, bearing buds in which are ova; *t*, tentacles.

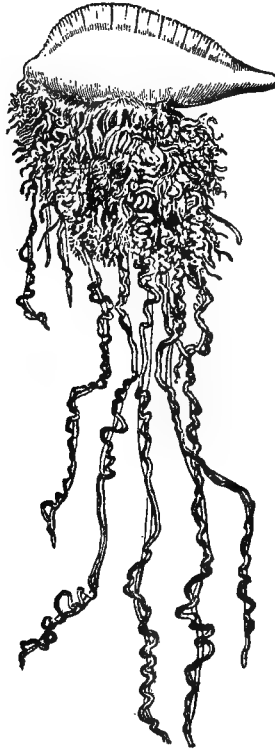
**Questions on the figure.**—How many types of individuals seem to be represented? What evidence of budding do you see in the species? What is the *canosarc*? What is its nature in *Hydractina*? What can you find concerning the habits of the members of the genus? How does this colony compare with that in Fig. 86?

as well as by the change of place as the crab moves about in search of food. Some anemones have living algæ in their entoderm cells which seem to help supply the animal with oxygen in return for foods of other kinds.

Nearly all the cœlenterates are marine. A few species of *Hydra*, one parasitic form, *Polypodium*, and a few fresh-water

medusoids are the only known exceptions. *Cordylophora*, a colonial polyp, is found in brackish tidal waters, and has been discovered in inland rivers. It seems to be a species in process of adjustment to fresh-water conditions.

FIG. 86.

FIG. 86. *Physalia*, the Portuguese Man-of-War. After Agassiz.

**Questions on the figure.**—For what is this animal remarkable? To what group of coelenterates does it belong? Compare Huxley's figure of the same animal (see Parker and Haswell's *Zoology*, Vol. I, p. 163, and other reference texts). What various types of polyps are represented in the colony? Compare with Fig. 87.

The jelly-fish are used as food by fishes and whales, though they cannot contain much solid matter. The group has little economic value. The red coral of the Mediterranean, of very slow growth, is used in making jewelry. The reef-forming corals

have changed the land contours by additions of marginal reefs. Much of the limestone of the crust of the earth is from corals.

FIG. 87.

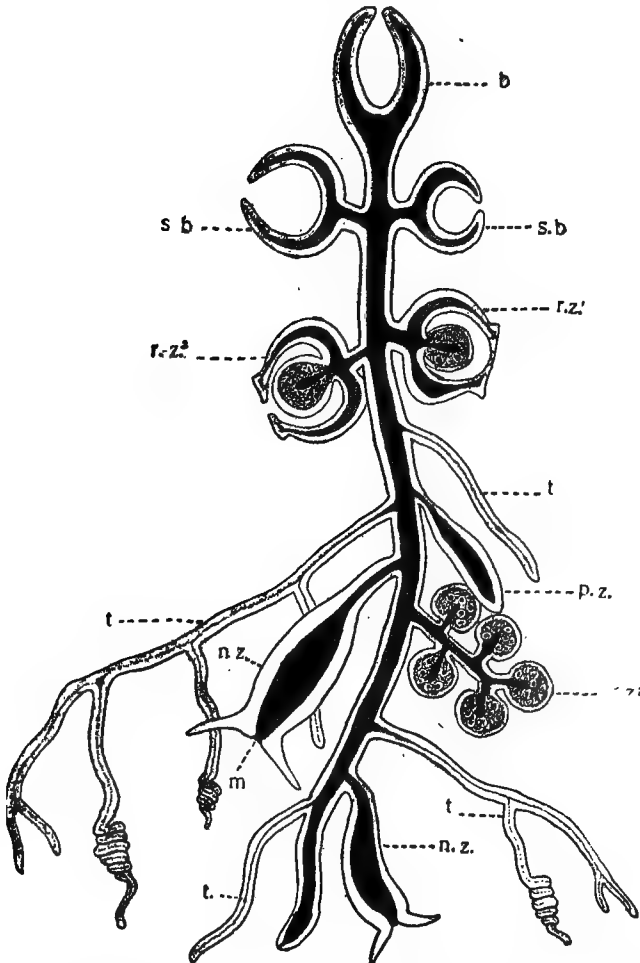


FIG. 87. A very diagrammatic and generalized illustration of a complex coelenterate colony. The shaded portion represents the gastro-vascular cavity. The light portion, the body tissues. *b.*, a bell-like individual developed into an air-bladder; *m.*, mouth; *n.z.*, nutritive individual; *p.z.*, protective individual; *r.z.¹*, *r.z.²*, *r.z.³*, different types of reproductive individuals; *s.b.*, swimming bell; *t.*, tentacles, which are sensory and protective structures. After Lang.

Questions on the figure.—What is meant by “generalized” above? How does such a polymorphic colony as this differ from a highly organized individual? In what respect is it similar to an individual? What is the function of the gastro-vascular system? What is the gain in its wide distribution through the colony? How do the Siphonophora differ from the other colonial coelenterates?

Many interesting experiments have been performed on members of this group to determine the power of regenerating lost parts. Many of the polyps have been shown to have this power and even the medusæ may become perfect animals again after having lost very considerable portions of their structure. *Hydra*, one of the simplest members of the group, is most famous for its power of regaining its original form, even from very minute pieces. As long as there is a piece of the trunk of appreciable size containing both ectoderm and entoderm it may regenerate the whole animal,—stalk, mouth, tentacles, and all,—under favorable conditions.

Nothing about the coelenterates is more interesting to the zoologist than the way in which the *individuals* in the polymorphic colonies (as in the Siphonophora) come to do the work done by special *organs* in the higher Metazoa.

231. **Supplementary Studies**, for field and library.

1. Make a list of all the places where *Hydra* may be found in your locality.

2. Can you find an account of any other fresh-water Coelenterata?

3. What facts can you find concerning the power of regeneration in *Hydra* or other coelenterates?

4. Coral reefs: kinds and mode of formation. Conditions of life necessary to the reef-forming corals.

5. Polyp colonies. Show, by reference to all the specimens and figures you can find, where the newest bud appears and how this helps determine the shape of the colony.

6. Polymorphism and division of labor in polyp colonies.

7. Corals in geological time.

8. Sense organs among coelenterates.

9. Alternation of generation in *Obelia*. In *Aurelia*.

10. The symmetry of the coelenterates.

11. The structure, position and uses of the netting cells in the phylum.

12. Study the polyp of *Aurelia* (*Scyphistoma*) from descriptions and cuts, and show in what respects it seems to stand intermediate between the Hydrozoa and the Actinozoa.

## CHAPTER XIII

### UNSEGMENTED WORMS (FLAT-WORMS, THREAD-WORMS, ROTIFERS, POLYZOA, ETC.)

232. It seems desirable, for the sake of convenience and in order to prevent a confusing array of details, to embrace under this head a number of groups of animals which do not have very much in common except their place of uncertainty in the animal kingdom. They are not to be considered as forming a phylum. There is abundant evidence indeed to enable one to believe that four or five distinct phyla are here included. Some of these groups, however, have members which bear more or less striking resemblances to animals belonging to the recognized phyla, especially to embryonic stages of them. These facts render them of great interest to the zoologist, because they furnish grounds for the hope that, through the study of this heterogeneous assemblage, the origin and kinships of the other phyla may be made clearer. The same facts make them unfit objects for extended study in elementary classes.

233. **Points of General Resemblance.**—In external form these animals differ very greatly. They may vary from a cylindrical or even a globular form to a thin ribbon-shape. They agree for the most part, however, in having a main axis which in the free-swimming forms is usually horizontal in position, the anterior end of which is structurally distinguishable from the posterior. There is usually a distinct bilateral symmetry (see §120) which takes the place of the radial symmetry found in the Coelenterates. In some types of the Coelenterates there are certain suggestions of bilateral symmetry but never to the complete exclusion of the radial. This is the most primitive group of multi-cellular animals whose individuals move with one end continually foremost and one of

the body surfaces continually up and the other down. This is a distinct advance in organization and accompanies a more active life. The Polyzoa are attached in adult life and have lost this symmetry, and many of the Rotifers, while having definite anterior and posterior ends, have lost their right-left symmetry in part, but their embryonic stages are in many respects similar to the more typical forms. By saying that these animals are unsegmented it is meant that in a distinct individual there is usually not a linear series of equivalent body-parts or metameres. There are however several types which reproduce new individuals by transverse division ("fission"). These new individuals may remain together, temporarily at least, in a chain, as in *Microstomum* (Fig. 91) or the tape-worm (Fig. 93), forming a *strobila*. In this condition there is a repetition of all the essential organs in each of the "segments." Some authors regard this process of strobilation as the condition from which the ordinary segmentation, as seen in the Annelida, has arisen, by the adhesion and gradual differentiation and coordination of the originally similar individuals.

The animals of these groups agree in the fact that the third or mesodermal layer of tissue becomes established. They are therefore *triploblastic* animals. In addition to this the mesoderm often, though not universally, splits, forming a *cœlom* or body cavity (§58) wholly separate from the digestive tract. The cœlom is lined with mesoderm. All the animal phyla above the Cœlenterates possess this character and on this account are called *Cœlomata*.

These animals further agree with those above them in the scale of development in possessing a system of excretory tubules which connect the cœlom, or the mesodermal tissue if there is no cœlom, with the outside world. This system eliminates nitrogenous wastes.

**234. Laboratory Exercises.**—An extended laboratory study of these groups is not necessary in an elementary course, yet enough material representing the various included phyla should be examined to enable the student to justify the separation of these uncertain forms from the more exactly defined phyla, and to show him how ill-defined is the assemblage which we have thus brought together. The Tapeworm of man may sometimes be secured from physicians, and other



species of *worms* are found not infrequently as intestinal parasites in cats, dogs, or other animals dissected in the laboratory. The general form, the method of attachment to the host, the progressive development of the proglottides or "segments," and the difference between these segments and those of the earth-worm should be noted. Permanent whole mounts of a mature proglottis may be made, showing the embryos in the uterus. Demonstrations of the structure of the proglottis may be given by properly prepared transverse sections, if the equipment and time allow.

An hour's work may profitably be devoted to the study of some one or more of the common Rotifers, which may be found in water taken from the stagnant pools in which there is much decaying matter. They are microscopic animals and are to be recognized by the possession of discs at the anterior end, which present the appearance of rotating wheels because of a rhythmic action of the cilia. Make sketches showing the change of shape which the animal undergoes. How is the change effected? How is locomotion accomplished? What evidences have you of its ability to receive stimuli and to respond to them? How does it get food? Can you trace the digestive tract in the body of the animal? Notice the contracting object just back of the mouth. What conclusions do you reach as to its function? Give your evidences. Verify by consulting some textbook. Can you prove from what you see that this is not a single-celled animal like *Stentor*? These specimens should not be considered as closely typical of the whole group of Rotifers, since there is very great variety of form among them.

Planarians often appear in the laboratory in water containing an abundance of decomposing organic matter, taken from ponds and foul streams. The most important points to be noticed are their general form, the method of locomotion, sensitiveness to stimuli, and life habits. Asexual reproduction by fission is frequent among them.

The Polyzoa occur as tufts of many minute animals in colonies attached to objects in the water. *Plumatella* is a rather common fresh-water form and makes a beautiful demonstration to illustrate the ordinary physiological processes, as motion, feeding, the action of the digestive tract in churning the food, sensitiveness to stimulus and the like. Schools near the sea-shore will find an abundance of marine material for the comparison of the colonial forms of different species of Polyzoa, since they are more common in salt than in fresh water.

**235. Classification and Description.** *Phylum Platyhelminthes (Flat-worms).*—In the worms of this phylum the body is flattened or compressed in a dorso-ventral direction, and from this fact the name is given. They are soft-bodied animals without any true skeleton. There is no body cavity and no true blood-vascular system. The space which would be given to such structures is filled with a solid mesoderm. Through this body-mass run the minute tubes of the excretory or water-vascular system (Fig. 88, *ex.*), often terminating internally in special cells (*flame cells*, Fig. 90). These tubes have external pores. By means of this system of organs waste products, probably of a nitrogenous nature, are eliminated from the tissues. The digestive tract may be wholly wanting as in the Cestodes, or be a simple or forked sac, or a central sac with lateral branches. When present, it is blind, *i.e.*, has only the oral opening. In the more complicated types of digestive tract the much-branched sac serves the function of carrying the digested food to all parts of the body. Many of these forms are parasitic and in conse-

quence the organs referred to are often very much simplified and degenerate. The digestive tract, for example, may be entirely lost. Reproduction by transverse division is not uncommon. By this method strobilæ or chains of more or less closely connected individuals occur (Figs. 91, 93). The sexual organs are exceedingly complex, particularly in the parasitic members of the group (Fig. 94). The development is in some instances direct, in others indirect. The principal classes are the Turbellaria, Trematoda and Cestoda.

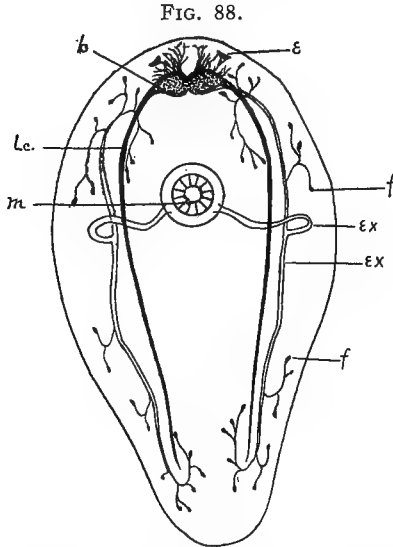


FIG. 88. Diagram of a Turbellarian, showing the general arrangement of the nervous structures and one of the modes of occurrence of the excretory tubules, which in this case open separately into the pharynx, on the ventral side of the animal. *b*, brain; *e*, eye-spots; *ex*, excretory canals consisting of a transverse portion passing from the mouth toward the dorsal side (see also Fig. 89), and longitudinal tubes which branch into the capillary vessels terminating in *f*, the flame cells; *l.c.*, lateral nerve cords; *m*, mouth.

**Questions on the figure.**—Compare this figure with the next and identify the structures shown in both. What other positions of the mouth do you discover in the Turbellaria, as figured in reference texts? What other arrangement of the excretory canals and pores?

*Class I. Turbellaria (Planarians, etc.)*.—These are mostly small non-parasitic Platyhelminthes with a ciliated ectoderm. They are chiefly aquatic and are carnivorous. The ventral mouth may be anterior, posterior, or median in position. It opens into a muscular eversible pharynx, which may be used to assist in locomotion as well as in capturing food. The digestive tract may be simple or very much branched. The brain consists of a pair of ganglia in the anterior region. From the brain lateral nerve cords pass backward through the body. The excretory organs (Figs. 88, 89) usually consist of two or more longitudinal tubes which open on the exterior separately or by a common orifice. The position of the opening

FIG. 89.

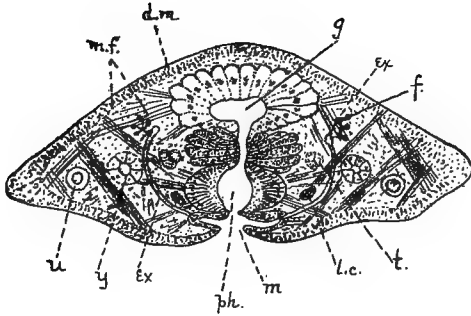


FIG. 90.

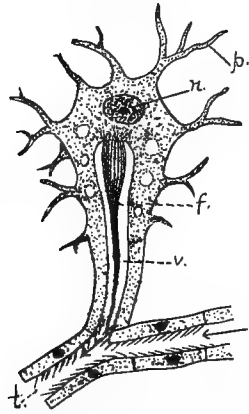


FIG. 89. Diagram of transverse section of a Turbellarian through the region of the mouth. *d.m.*, dermo-muscular wall containing longitudinal fibres; *ex*, excretory system; *f*, flame cells; *g*, gut; *l.c.*, lateral nerve cord; *m*, mouth; *m.f.*, muscle fibres; *ph.*, pharynx; *t*, testis; *u*, uterus; *y*, yolk glands.

**Questions on the figure.**—Determine with care the relation of this to the preceding diagram and identify the common structures. What new structures are represented here? What would be their position in the former figure? The great range in position of the muscle fibres and the spongy character of the body contribute to what powers?

FIG. 90. Diagram of flame cell, the internal terminus of the excretory tubules. *c*, cilia lining the tubule; *f*, special cilia constituting the flame; *n*, nucleus of flame cell; *p*, cell processes; *v*, cavity formed by cell communicating with the capillary tubules (*t*).

**Questions on the figure.**—What is the function of the cell itself? Of the flame?

FIG. 91.

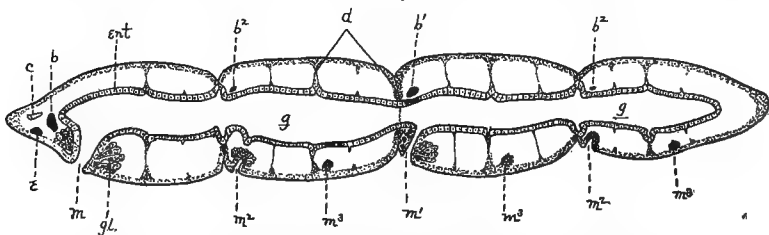


FIG. 91. Diagrammatic sagittal section of *Microstomum*, showing a chain of four zooids produced by fission. *b*, brain of the original zooid (the exponents indicating corresponding structures of the more recently formed zooids); *c*, ciliated pit; *d*, dissepiments indicating different stages in the separation of the zooids; *e*, eye-spot; *ent*, entoderm; *g*, gut; *gl.*, glandular cells about the mouth; *m*, mouth of the original worm.

**Questions on the figure.**—What various evidences can be found of the relative age of the zooids? Is the mouth formed apparently from entoderm or ectoderm? Is the gut a blind sac? What incidents seem necessary when this chain separates at the oldest plane of division, and forms two chains, in order that each may be like the parent? How is this like segmentation in annelids (see Fig. 101)? How unlike?

varies very much in the different orders. The tubules are much branched interiorly and penetrate the soft tissues of the body as minute capillaries with thin walls. They terminate in cells of special structure which are excretory in function. A group of cilia (the *flame*, Fig. 90, *f*) helps in creating a current in the capillary tubes. The lining of the tube may also be supplied with cilia. Reproduction is by division (*fission*, Fig. 91) or by eggs and sperm. The Turbellaria have remarkable powers of regenerating lost portions. Experiments show that very small portions of an individual will, under favorable conditions, reproduce all the parts of a complete animal. In habit they may be terrestrial, fresh-water or marine. They vary in size from microscopic fresh-water forms to a length of six inches or more in the case of the marine and land types (Figs. 88-91).

*Class II. Trematoda.*—The Trematodes are small, usually parasitic, Platyhelminthes. The ectoderm is provided with a protective "cuticle" and is consequently destitute of cilia. They possess a well-developed and often much-branched digestive sac, which has only one opening—the mouth. Usually one or more sucking discs are present. By means of these the parasite attaches itself to the host. The nervous and excretory systems are similar in general to those of the Turbellaria, but are somewhat better developed and more complex. In those members of the class which are external parasites there is usually no metamorphosis in the development. In the internal parasites, as the Liver-fluke of the Sheep, there is a complicated metamorphosis. A Liver-fluke (*Fasciola hepatica*) is found in the bile ducts of the liver of the sheep, where it gives rise to a much-dreaded disease—"liver rot." The eggs which are formed, fertilized and pass through the early stages of cleavage here, pass out of the bile ducts to the intestine and thence to the exterior. If the larva reaches water it develops into a free-swimming larva (Fig. 92, *C*), which to insure further development must bore into the tissues of a particular pond-snail (*Limnæa truncatula*). It there develops into a kind of sac (*sporocyst*) in which a number of parthenogenetic ova are produced. These ova develop into *redia* (Fig. 92, *F*) which escape from the sporocyst. These *redia*, in turn, produce parthenogenetic ova which may develop into other *redia* or a very different, tailed form known as a *cercaria* (Fig. 92, *G*). These *cercaria* escape from the snail into the water, ultimately encyst on damp grass, and are swallowed by sheep. The larvæ find their way to the liver and develop there again into the adult fluke. It is evident that such a form must have immense powers of reproduction, when it is considered that the reproduction takes place at several points in the life cycle (Fig. 92, + \*). This compensates for the great loss of life involved in changing from host to host. It is said that a single fluke may produce half a million eggs. The disease is prevalent only in those countries where this species of *Limnæa* occurs. It is much worse in wet years. Millions of sheep have died in England alone, in a single year, from the attacks of this parasite. Trematode parasites are common among animals and frequent most diverse organs. As compared with the Turbellaria, the Trematodes have lost their eyespots, have less well developed sense organs and central nervous systems and have highly elaborate reproductive organs and metamorphosis. These facts are related to the parasitic habit.

FIG. 92.

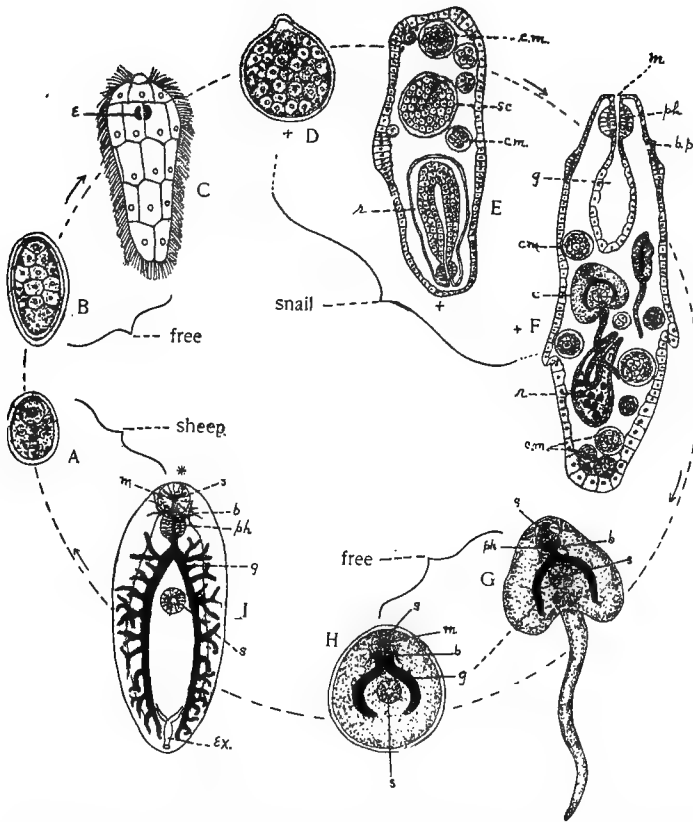


FIG. 92. A series of diagrams illustrating the life cycle in the LIVER-FLUKE (*Fasciola*). After Thomas, Leuckart, and others. A, egg in its case; B, early embryo, still in case; C, free-swimming ciliated embryo (*miracidium*); D, same after encysting in tissues of snail (*sporocyst*); E, sporocyst at later stage, producing from parthenogenetic ova *rediae* (*r*) which break from the sporocyst and lead an independent life of their own in the tissues of the snail; F, a mature redia producing within itself new generations of rediae, and a new type of larva, *cercariae*, which escape by a birth-pore (*b.p.*) and make their way into the water; G, *cercaria*; H, same after losing its tail and becoming encysted; I, the young fluke in the liver of the sheep, where it becomes sexually mature and produces perhaps 500,000 new eggs. *b*, brain; *b.p.*, birth-pore; *c*, cercaria; *c.m.*, cell masses; *e*, eyespot; *ex.*, excretory tubules and pore (only the posterior portion shows); *g*, gut; *m*, mouth; *ph*, pharynx; *r*, redia; *s*, suckers; *sc*, sporocyst.

Questions on the figures.—In which stages are eyespots found? Number and position of the suckers? In which stages found? What is the result of increasing the points at which reproduction occurs in the cycle? Compare this with the life history of the tape-worm. Note the encysted stage by which it passes from water to its host in each instance.

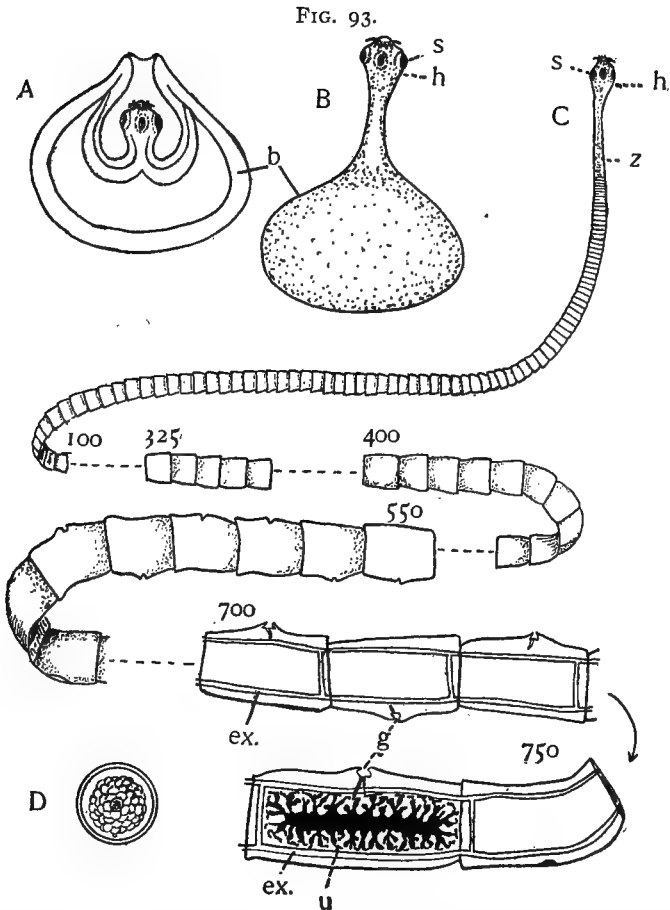


FIG. 93. Diagram showing some stages in the life history of the Tapeworm (*Tenia*). A, Cysticercus or Bladderworm stage, before the "head" protrudes from the bladder; B, same, later stage; C, Strobila, or chain of proglottides, many being omitted; D, embryo, such as fill the uterus of the mature proglottides. It is protected by a shell. *b*, bladder; *ex.*, excretory canals; *g*, genital pore; *h*, head or scolex provided with hooks and suckers (*s*); *u*, uterus in a mature posterior proglottis; *s*, zone of budding or segment formation. The numerals show the approximate number of the segments, reckoning from the front. Not more than 5 per cent. of real length of the chain is represented.

**Questions on the figures.**—What arguments do you find from the figure for considering the strobila an individual? What for considering it a colony? Where does non-sexual reproduction occur? Where sexual? Seek figures of stages between D and A in the reference books.

*Class III. Cestodes (Tape-worm, etc.).*—The Cestodes are internal parasites having a complicated life history usually involving two hosts, sometimes three. In the tissues of the first host occurs the “bladder-worm,” *Cysticercus*, or embryonic stage (Fig. 93, A); in the intestine of a second host the strobila or adult tape-worm (Fig. 93, C) is found. The adult form has no mouth or digestive tract, the animal taking its food by absorption of the digested material in which it is bathed. The anterior end is supplied with hooks, suckers, or both, by means of which it attaches itself to the intestinal wall. Just behind this “head” is a region in which

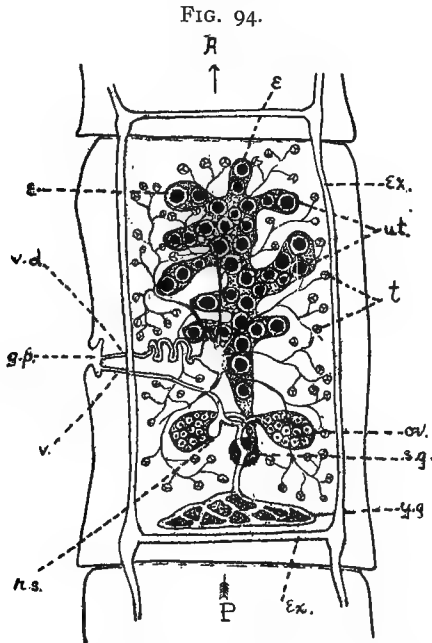


FIG. 94. Diagram of a sexually mature proglottis of *Tania*. A, anterior end; e, embryos; ex., excretory canals; g.p., genital pore; ov., ovaries (paired); r.s., receptaculum seminis; s.g., shell gland; t, testes; ut., uterus filled with embryos; v, vagina; v.d., vas deferens; y.g., yolk gland.

**Questions on the figure.**—Why is self-fertilization possible in tapeworm? What is the function of the various portions of the reproductive apparatus? Trace the following steps and indicate where each incident happens: formation of eggs and sperm; passage of sperm to vas deferens and into vagina; storing of sperm in receptaculum seminis; fertilization in the oviduct; addition of yolk; ovum covered with shell secretion; passage into uterus where development proceeds.

transverse division (Fig. 93, z; and §126) is continually taking place. This results in the continuous formation of new segments or *proglottides*, the older ones being pushed further from the head by those newly formed. Each proglottis becomes in time a sexually mature *hermaphrodite* individual. All stages of sexual maturity are found in one strobila or colony, the posterior individuals being most mature.

At the posterior end of an old colony the proglottides (Figs. 93, 94) are filled with the developing embryos, and on breaking away from the chain these brood cases pass with the fecal matter from the intestine of the host. In this way it becomes possible for the embryos to find the way into a new host. On being swallowed by some suitable animal they break from their cysts, bore through the wall of the digestive tract into the tissues. Here they grow, become encysted and at this stage develop the head or scolex which remains attached to the bladder-like cyst (Fig. 93, A, B). Development stops at this point unless the flesh of this host is eaten by some other animal. When this happens the bladder is thrown off, the head becomes attached to the wall of the intestine of the new host, and the active formation of the chain of proglottides begins again.

The more common tape-worms of man are *Tania solium* and *Tania saginata*. The former is more common in Europe and is received into the system by eating the raw flesh of the pig, in which the bladder-worm stage occurs. The latter is obtained chiefly from beef and is more common in America. Only by adequate cooking is the danger of infection removed. The American habit of eating beef rare contributes to the spread of the pest. Other tapeworms infest, as their two hosts, the dog and the rabbit; man and fish; the cat and the mouse; the shark and other fishes.

The excretory system is a pair of continuous lateral tubes with transverse connections in the various proglottides (Fig. 94, *ex*). The nervous system in the adult tapeworm includes a rather complex series of loops containing nerve-cells, in the scolex, with right and left lateral lines of nervous tissue running the length of the strobila. There are numerous longitudinal, transverse (circular), and dorso-ventral muscle fibres passing through the spongy tissue of the worm. There is a well-developed external cuticle.

*Phylum Nematelminthes (Round- or Thread-worms).*—Nematelminthes are elongated, cylindrical forms which taper at the ends. The body is covered by a dense cuticle. Many are aquatic, but some are parasitic at least during a part of their life. An alimentary tract is present and has both a mouth and an anus. There is a coelom which is not divided into chambers and contains a fluid without corpuscles. There is no circulatory system other than this. There are no special respiratory organs. The central nervous system consists of a ring around the esophagus, from which nerves arise at various points and pass both forward and backward. The chief posterior nerve is ventral, but there may be also dorsal and lateral ones. The sexes are usually separate. Development is sometimes direct, sometimes indirect. The best-known representatives are the round-worms (*Ascaris*), different species of which are found in the intestine of man, of the pig, and of the horse; vinegar-“eels”; trichina; and numerous free-swimming forms.

*Trichinella* is one of the most dangerous of the nematode parasites. The sexually mature worm occurs in the intestine of the rat, the pig, man, or other mammal. The young are retained by the mother in the uterus until well developed. When born the young bore through the wall of the intestine of the host and make their way to the muscles, where they become encysted and cause degeneration of the muscle fibres and often other acute symptoms of the disease known as *trichinosis*. The larvæ remain in their cysts indefinitely or until the death of their host. For further development the flesh must be eaten. In the intestine of the new host where the cyst is dissolved the adult condition is quickly reached,



reproduction takes place again, the embryos migrate into the muscles and the new cycle is begun. The reproductive power of *Trichinella* is very great. It is estimated that an ounce of "measly" pork may contain 80,000 cysts of *Trichinella*, and that each female produced from these embryos may contain at one time 1,000 or more embryos. During her life she may produce ten times this number. Thus the 40,000 females from such a meal would soon supply 40,000,000 young worms for the infection of the muscles, with the ability of renewing the supply at short periods. Perfect cooking is the only sure safeguard against the possibility of infection.

The hookworm, *Necator americanus*, belongs to this phylum and is a common parasite of man in the southeastern states. It has only one host in its life cycle. The adult worms attach to the wall of the intestine with a sucker-like mouth. The teeth pierce the wall and the esophagus works as a pump to extract the blood. From the mouth, secretions are poured that prevent the blood from clotting. This adds greatly to the loss of blood. One worm may thus make many wounds; and in some cases more than a thousand have been found in one person. The female may produce thousands of eggs, but these cannot develop in the intestine of man. They pass from the intestine, and then hatch and undergo their early development in the moist soil. If they do not, at a certain stage, find their way back into man or some similar host they die. Possibly they may get back into the intestine on raw vegetables, but a much more remarkable way has been demonstrated. It has been found that they can penetrate the skin, and many of the poorer people go barefoot in these regions. The larvæ bore into the capillaries, are taken with the blood to the heart and thence to the lungs. Here they bore into the lung cavity, pass up the bronchial tubes, through the trachea into the gullet and on into the intestine. It takes about seventy days from the time the larvæ enter the skin until a new generation of eggs appear from the intestine. The effect of infection upon human beings is bloodlessness, weakness, deranged digestion and poor nutrition, abnormal appetite, and laziness.

Prevention of infection involves stopping the miscellaneous infection of the soil by discharges from the intestine and protecting the skin from exposure. Drouth and freezing are fatal to the larvæ. Recent investigations have shown that at least under some circumstances, certain domestic animals (pigs, chickens) play a part in disseminating the eggs and larvæ.

*Phylum Trochelminthes (wheel-worms or rotifers).*—The Rotifers or wheel-animalcules are microscopic animals. They usually tend toward bilateral symmetry. The anterior end possesses a retractile disc supplied with cilia variously arranged, the rhythmic motions of which often give the appearance of a rotating wheel. From this the name of the group comes. This organ assists in locomotion and produces currents in the water by which food is brought within reach of the mouth. There is a digestive tract with both mouth and anus. The pharynx into which the mouth opens is provided with a chitinous grinding apparatus (*mastax*). Usually a pair of digestive glands open into the stomach. The nervous system is usually limited to a single ganglion dorsal to the pharynx. Eye-spots and other sense organs, called tactile rods or antennæ, are present. There is a true coelom communicating with the exterior by means of excretory tubules. For a diagrammatic view of these structures see Fig. 95.

The sexes are distinct and are frequently very different in appearance. The males are often much smaller than the females, are much less numerous, and are

often degenerate. The summer eggs are of two kinds—large and small—and develop parthenogenetically. The large eggs produce females and the small, males. The winter eggs have a thick shell and are believed to require fertilization in order to develop. They rest during the winter and in the spring develop into females. Development is direct. The adult condition in the Rotifers suggests the larval (*trochophore*) condition in some Annelida. There are some traces

FIG. 95.

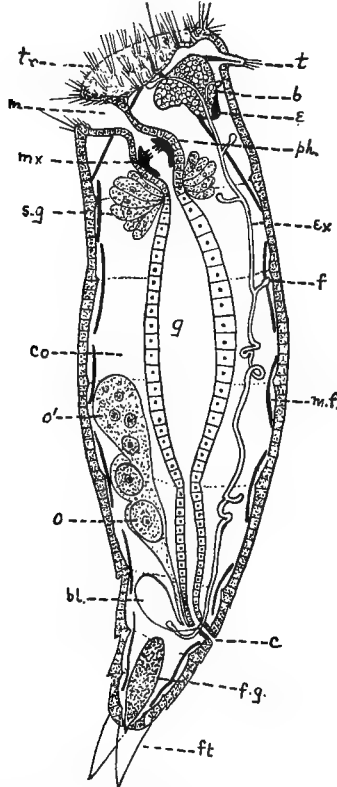


FIG. 95. Diagram of a sagittal section of a Rotifer. *b*, brain; *bl.*, excretory bladder; *c*, cloaca; the common opening of digestive and reproductive organs; *co.*, coelom; *e*, eyespot; *ex*, excretory canal; *f*, flame cells; *f.g.*, foot gland; *ft.*, foot; *g.*, gut; *m*, mouth; *m.f.*, longitudinal muscle fibres, *mx*, mastax; *o*, ovary; *ph.*, pharynx; *s.g.*, salivary gland; *t*, tentacle; *tr*, trochus, or cilia-bearing disc.

**Questions on the figure.**—What sets of organs and functions are indicated in the diagram? Does this seem a lower or higher form than the other types studied in this chapter? What are your grounds for your answer? What indications of segmentation are represented in the figure? Is the mastax in the stomodæum or mesenteron? Where do the various authors classify Rotifers?

of external segmentation in the tail or foot region in some species and for these reasons some authors class the Rotifers near the Annelida. Rotifers are aquatic, being more common in fresh water than in the sea. They are abundant in water-troughs, gutters, ponds. Some species are capable of resuming activity after having been dried up in the mud for a year or more. This power must be of great value in preserving the species as well as in spreading it.

*Phylum Molluscoidea (mollusk-like).*—The two groups included here are quite diverse in general appearance and habit. They are probably not as closely related as this classification would suggest. Their larval stages have more points in common than the adult. There is in the adult a variously shaped tentacle-bearing ridge (*lophophore*) about the mouth. The central nervous system consists of one or two ganglia about the esophagus. The Brachyopoda have often been grouped with the mollusks, but authors are agreed that much of the seeming resemblance to mollusks is superficial.

FIG. 96.

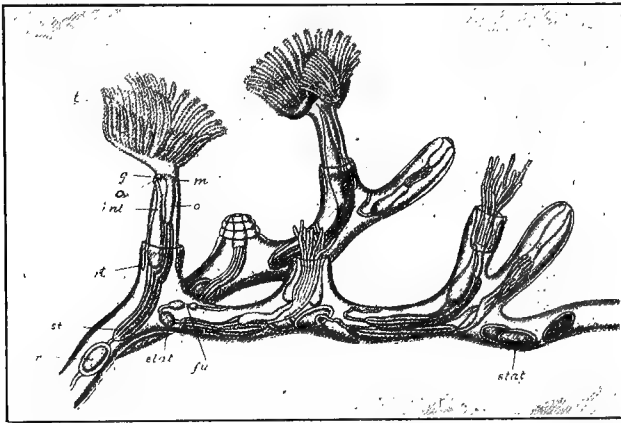


FIG. 96. A fresh-water polyzoan, *Plumatella*. From Parker and Haswell, after Allman. *a*, anus; *fu.*, funiculus, a band of tissue anchoring the intestine to the body wall; *g*, ganglion; *int.*, intestine; *m*, mouth; *o*, esophagus; *r*, reproductive gland; *rt*, retractor muscle; *st*, stomach; *stat*, statoblast; *t*, tentacles.

**Questions on the figure.**—Is this an individual or a colony? What is the function of the retractor muscles? To what degree are the polyps capable of contraction as shown in the figure? The value of this power? What are the *statoblasts*?

*Class I. Polyzoa (Bryozoa; sea-mats; corallines).*—The Polyzoa are colonial animals which resemble in general appearance some of the compound hydroids. The individual animals however are very different in their structure. They are found both in salt and fresh water. In Polyzoa (Fig. 96) the digestive tract is sharply bent, the anus opening close to the mouth either within or outside the circle of tentacles (*lophophore*). A distinct cœlom is typically present. There are no blood vessels. An exoskeleton is formed by the ectoderm, by means of which the individuals of the colony are held together. Each member of the colony may retire into its own particular portion of the exoskeleton, when disturbed, by

the contraction of appropriate muscles. The brain consists of a single ganglion lying between the mouth and anus. The two sexes usually occur in the same individual. The colonies are formed by budding which takes place in each species in a way that is characteristic of that species. Thus it comes about that the colonies differ as much in general appearance as their individuals do in structure. Internal buds, resulting in statoblasts, commonly occur.

*Class II. Brachiopoda (arm-footed; lamp-shells).*—Brachiopods are marine forms chiefly of geological interest, as there are at present only a few living species. They were very prevalent in early geological times. They possess a bivalved shell which suggests that of the bivalve Mollusca (as the clam). From this external resemblance they have long been classed as mollusks. The valves are strictly dorsal and ventral in the Brachiopods, however; whereas in the mollusks they are right and left. Their shell is therefore no longer considered as homologous with the mollusk shell. The internal structure is still further removed from that of the clam. The digestive tract is often bent much as in the Polyzoa, and the mouth is surrounded by a tentacle-bearing lophophore (the "arms"). The lophophore may have a skeletal support which in different types assumes different shapes (loop, helix, or spiral). A peduncle usually extrudes at the hinge, by means of which the animal attaches itself to foreign objects. The Brachiopods are not colonial. The student is referred to the more extended texts for illustrations of this group of animals.

236 **Some Forms of Doubtful Relationship.**—The old group "Vermes," or worms, has in recent years had several fairly definite phyla removed from it. Clearest among these is the phylum Annulata or segmented worms (Ch. XV). More recently the Phyla Platyhelminthes, Nematelminthes, Trochelminthes, and Molluscoidea have been recognized by many students. In this old waste-basket of worm-like animals are still the raw-materials for several more phyla when we learn enough about them to distinguish them. None of these groups is numerous in species, or of much economic or human interest. They cannot receive much attention in an elementary course. Among them are:

1. *Mesozoa*, which are simple, parasitic forms less complex even than the *diploblastic* animals. It has been thought that they are intermediate between Protozoa and Metazoa.

2. *Nemertinea*, similar in some ways to flat worms. They are peculiar in development, and have some systems of organs better developed than other unsegmented worms. They live in water, chiefly salt, and in moist earth. Some attain a length of ninety feet. They are slender and usually flattened.

3. *Acanthocephala*, spine-headed parasites sometimes classed with the nematodes. Found in many vertebrates.

4. *Chatognatha*, which includes *Sagitta*, the arrow-worm. Free-swimming marine animals, sometimes placed near the segmented worms.

5. *Gephyrea*, marine worms living in sand or mud, unsegmented with large body cavity, and protrusible proboscis. The *sipunculids* are the best known representatives.

The student is asked to seek figures of some of these rarer types in the larger exts, and notice the various ways in which they are classified.

237. **Notes on Ecology and Distribution.**—The organisms included in this chapter represent the most varied modes of life.

The Turbellarians are free living animals and may be terrestrial, fresh-water or marine; the Rotifers are as a rule free-swimming and occur chiefly in fresh water; the Polyzoa are aquatic, attached, colonial forms but lead for the most part an independent existence, or may occasionally be commensal with other types of animals; the Brachiopods are marine and may be attached, but are not colonial; the Trematodes and Cestodes represent all kinds and degrees of parasitism. Even if all these classes of animals could be considered akin, their habits of life and their consequent adaptations are so various as to produce the greatest range of general form and special structure.

If we consider the relatively small number of species of animals in these groups, the species of the Platyhelminthes are among the most widely distributed of the Metazoa. This is true both of the free Turbellaria and Nematoda and the parasitic Trematoda and Cestoda. There is probably not a large species of the higher Metazoa which escapes being the host of one or more of these worms at some stage of its life history. The fact of parasitism, the ability to carry on the life cycle in a series of hosts, and the prevalence of the carnivorous habit among its hosts all help the distribution. The organs more commonly infested by the parasites are the digestive tube, the blood and lymphatic vessels, the cœlomic cavity or other organs where the nutritive fluids of the body are abundant. They produce all sorts of disorders from mere functional disturbance (such as digestive disorders and anæmia from the presence of the tape-worm) to the destruction of the tissues of the organs involved. It is very commonly true that the adult or sexually mature individuals are produced in one host, and the eggs or larvæ produced by them find their way into another species of host where a portion of the development toward maturity occurs. The transfer of the parasite from the second back to the first host-species is necessary to complete the cycle. In size the unsegmented worms vary from minute microscopic dimensions to thirty feet in length in the tape-worm, *Diphyllobothrium latum*. Some suggestion of their importance to man and the higher animals may be gathered by reference to the following table (p. 206).

## LIFE HISTORIES OF SOME PARASITIC WORMS

THE MATURE STAGE			THE LARVAL STAGE	
NAME	HOST	POSITION AND RESULTS	HOST	POSITION AND RESULTS
<i>Tenia solium</i> .	Man.	Intestine.	Pig, etc.	Muscles and other organs.
<i>Tenia saginata</i> .	Man.	Intestine.	Cattle, Giraffe, etc.	Muscles and other organs.
<i>Echinococcus granulosus</i> .	Dog, wolf, etc.	Intestine.	Man, many domestic mammals.	Liver, lungs, etc.; hydatid disease.
<i>Multiceps multiceps</i> .	Dog.	Intestine.	Ruminants.	Brain, etc.; "staggers."
<i>Diphylidium caninum</i> .	Dog.	Intestine.	Flea and louse.	
<i>Tenia pisiformis</i>	Dog.	Intestine.	Rabbit.	
<i>Hymenolepis diminuta</i> .	Rat, mouse, man.	Intestine.	Various meal-infesting insects.	Liver and omentum.
<i>Diphyllobothrium latum</i> .	Man.	Intestine.	Copepod, then certain fish.	Muscles.
<i>Ascaris lumbricoides</i> .	Man, pig.	Small intestine.	Man, pig.	Lungs; inflammation.
<i>Trichinella spiralis</i> .	Man, pig, rat and other mammals.	Intestine.	Pig, man, rat and other mammals.	Muscles; inflammation, degeneration of tissue.
<i>Filaria bancrofti</i> .	Man.	Lymphatic system; elephantiasis.	Man, mosquito.	Blood, in man; thoracic muscles in mosquito.
<i>Dirofilaria immitis</i> .	Dog.	Heart and pulmonary artery.	Mosquito.	Malpighian tubes.
<i>Fasciola hepatica</i> .	Man, sheep, ox.	Liver; degeneration.	Snail.	Liver or other tissues; may destroy host.
<i>Schistosoma hæmatobium</i> .	Man.	Veins of large intestines, bladder, etc., producing inflammation, hæmaturia, etc.	Snail.	
<i>Necator americanus</i> .	Man.	Intestine; scars, ulcers, malnutrition.	Early development in soil; later development in man.	

**238. Supplementary Studies for the Library.**

1. In what different ways are the forms included in this chapter classified in the various textbooks to which you have access?
2. Consider the economic importance of the parasites included in this chapter.
3. Make a further study of the life histories of selected representatives of these parasites.
4. Illustrate by means of the unsegmented worms the degeneration and simplification which attends parasitism.
5. In what various ways do the intestinal parasites in the group adhere to the walls of the digestive tract of the host?
6. Do you think the domestic animals are more or less likely to be attacked and suffer from these internal parasites than the wild? What evidences would you offer for your view?
7. Prepare for the class a diagram of the reproductive organs in the Tape-worm, indicating the function of each of the portions.
8. What is meant by the "dermo-muscular" sac in worms? Its functions?
9. Report on the importance of the Brachiopods in early geological time, with the main structural features of the class.

## CHAPTER XIV

### PHYLUM ECHINODERMATA (STARFISH, SEA-URCHINS, SAND-DOLLARS, SEA-LILIES)

#### LABORATORY EXERCISES

239. **Asterias (Starfish).**—Both dry and alcoholic, or otherwise preserved, materials should be at hand.

1. General form.

Central disc.

Rays; number, form, size, etc. Compare several individuals.

Oral surface (contains mouth); aboral surface. Note the general differences between these surfaces both in the arms and the disc.

The axis of an arm is known as a *radius*; the space between is *interradial*.

Is the body bilaterally symmetrical or radially symmetrical? Give the reasons for your conclusion.

2. External anatomy.

Oral surface.

Mouth: position and surroundings.

Ambulacral groove: position, relation to the mouth, extent.

Ambulacral feet: how arranged? Is the foot hollow or solid? Pull off one, and examine with lens or low power of the microscope.

Aboral surface.

Madreporic body: position (radial or interradial?), shape, size, structure.

Bivium; trivium (see text, §243).

Examine the spines on both surfaces and determine the arrangement and shape in different regions. How are they fixed to the body?

Pedicellariæ (at the base of the spines); papulæ (soft bodies among the spines). Examine with lens.



Make an outline drawing of each surface, filling in the details of the disc and one arm and showing the points above determined. Sketch one of each of the various classes of spines in profile.

### 3. Organs of the body cavity.

Using alcoholic or other moist preparations, cut into one side of an arm of the trivium, making an incision from near the tip almost to the disc. Cut across the back of the arm near the tip and make a similar incision on the other side. Lift the flap thus separated and notice the organs attached to it. The material should be dissected under water or 50 per cent. alcohol, or kept moistened therewith.

Hepatic cæca; extent, number, and attachment.

Detach the hepatic cæca from the aboral wall by breaking the mesenteries, and treat all the arms of the trivium as above.

Carefully connect the incisions across the interradii and remove the entire aboral wall except that around the madreporic body and that between it and the centre of the disc, being careful to disturb none of the soft parts. A few good, permanent dissections, to be used as demonstrations, will be of value.

Notice:

Body cavity, its extent and contents.

Stomach: pyloric (aboral) portion; shape, position. Are the hepatic cæca connected with it? Verify. (The stomach opens aborally into a small, short rectum and anus usually very difficult of demonstration.)

Rectal diverticula? number and position?

Cardiac (oral) portion of stomach; pouches, number and form; retractor muscles, attached to the floor of the arms.

Mouth; peristome.

Remove the hepatic cæca from one arm and find the genital glands which lie in the floor of the body cavity. What is their number and arrangement? At what point do they connect with the body wall? Can you prove that they communicate with the exterior?

Ampullæ (on ventral floor): determine if they connect with ambulacra feet.

Make three diagrams showing the position of the organs thus far studied: (1) the aboral surface with the wall removed, showing the stomach in the disc, the hepatic cæca in one arm, the reproductive bodies in a second, and the ampullæ and retractor muscles in a third; (2) a transverse section of an arm about midway between its ends; and (3) a sagittal section of an arm continued through the disc.

### 4. Ambulacral system.

In a specimen from which the preceding organs have been removed, make a transverse section of an arm about an inch from the disc. Find the radial water canal, a small tube lying just outside the skeleton in the ambulacral groove. Force air into it with a blow-pipe, or inject a colored solution with a hypodermic syringe. What other structures are affected? Trace connection between *radial canal*, *ampullæ*, and *ambulacral feet*. Compare the number of ampullæ and the number of feet. Follow the radial canal toward the disc. How does it terminate?

From the madreporic body trace the S-shaped stone canal toward the oral surface. How does it terminate?

Ring canal: its position. Are there any other structures (sacs) in communication with the circum-oral ring-canal beside the stone canal and the radial water-tubes? form and position?

5. Nervous system.

There is a *radial nerve* (in the skin) superficial to the radial water canal in each arm. This may be demonstrated by a stained microtome transverse section of the arm of a young starfish. The radial nerves unite to form a circumoral *nerve ring*.

6. Skeletal parts.

Dried material and portions soaked for a few days in a 10 per cent. solution of potassium hydroxide should be used to supplement the alcoholic specimens.

Is the skeleton complete, *i.e.*, are the ossicles in contact?

Are they similarly arranged on the aboral and oral surfaces? Which surface shows the greater differentiation? Illustrate, and find a reason if you can. How are the ossicles related to the spines? to the papulae? Study with some care the ossicles forming the ambulacral groove, beginning at the middle line.

Ambulacral rafters: shape and arrangement.

Ambulacral pores; are they in, or between, the ossicles?

Adambulacral ossicles (just lateral to the former); how do these compare in number with the ambulacral ossicles?

"Cross-shaped" ossicles.

Which of the above bear spines? what kind?

Place some of the cleaned ossicles in dilute hydrochloric acid. Result? What is the significance of this result?

7. Physiological experiments are possible only near the seashore. The animals must be kept in sea water, and studied soon after being collected. When possible, locomotion, the action of the ambulacral feet, feeding, and sensitiveness should be studied. Do you find any indications, among the specimens provided, of the power to renew a lost arm? With care and perseverance, at the proper time of year, the sexual elements may be collected and the maturation, fertilization, and cleavage of the ovum illustrated in this group. Inland schools may procure prepared slides demonstrating the early development of the starfish or sea-urchin.

8. Compare briefly the external gross features of other "stars" with that already studied.

240. Sea-urchin (*Echinus* or *Arbacia*).

A few skeletons of sea-urchins and sand-dollars will be of great value in enabling the pupil to see how the same general plan of structure may be varied, in different organisms.

1. Spines (if present): arrangement and method of attachment. Are they of the same appearance and composition as the skeleton? Do you find any signs of the former presence of ambulacral feet? If so what, and how arranged? Can they *all* have the same function as in the starfish? Proofs?

2. Ossicles; Make out the boundaries. Compare with the condition in the starfish. What are the special advantages gained by each arrangement? Can you find anything corresponding to *ambulacral ossicles*? (Look for the pores.) What corresponds to the *ambulacral groove* in *Asterias*? Identify the *interambulacral* ossicles. How arranged? What is radial and what interradial in the urchin? What in the sea-urchin would correspond to the oral and aboral surfaces in the

starfish? Evidences? Find the madreporic body. Make a plot of all the oscles in this region, noting the differences. Find the genital pores.

3. "*Aristotle's lantern*" (the mouth apparatus).

Examine the structure as a whole. How related to the body? Study the parts in their relation to each other. Number, and method of action?

### DESCRIPTIVE TEXT

241. The Echinoderma (*spiny-skinned*) form a very distinct group of animals, which in the adult condition at least show a decided radial symmetry. They possess a more or less extensive calcareous exo-skeleton with outwardly directed spines. The starfishes, sea-urchins, brittle stars, sea-lilies, and sea-cucumbers are representatives. They are marine in habit and may be either fixed or slow-moving. They agree with the Coelenterates in having radial symmetry, and in the absence of a well-marked brain and other signs of cephalization. There is considerable ground for believing that this is an outcome of their sluggish habit, since the larval free-swimming condition is bilaterally symmetrical, and radial symmetry is clearly adapted to a passive life. It is difficult to determine the relationships of the Echinoderms; yet it seems probable that their ancestors were bilateral forms.

#### 242. General Characters.

1. Larvæ bilaterally symmetrical; adults with a more or less complete radial arrangement of equivalent parts, usually on the plan of five. In this radial plan all the principal sets of organs share: as the nervous, digestive, reproductive, etc.

2. Complete differentiation of digestive tract and body cavity. The latter is spacious.

3. Blood-vascular system partially differentiated from the body cavity, but communicating with it.

4. Exo-skeleton calcareous, derived from the mesoderm; composed of isolated spicules or united plates; usually bearing spines.

5. A water-vascular system present, consisting of a series of tubes (closed except at one point), muscular sacs (ampullæ) and distensible feet, and serving a locomotor and respiratory function.

6. Reproduction exclusively sexual; development usually indirect, *i.e.*, with a metamorphosis.

243. **General Survey.**—Most echinoderms have a central disc in which are located portions of the various sets of organs. Ordinarily there radiate from this disc more or less clearly defined rays or arms in which lie radial outgrowths from certain central organs. The spaces between the rays (*inter-radii*)

FIG. 97.

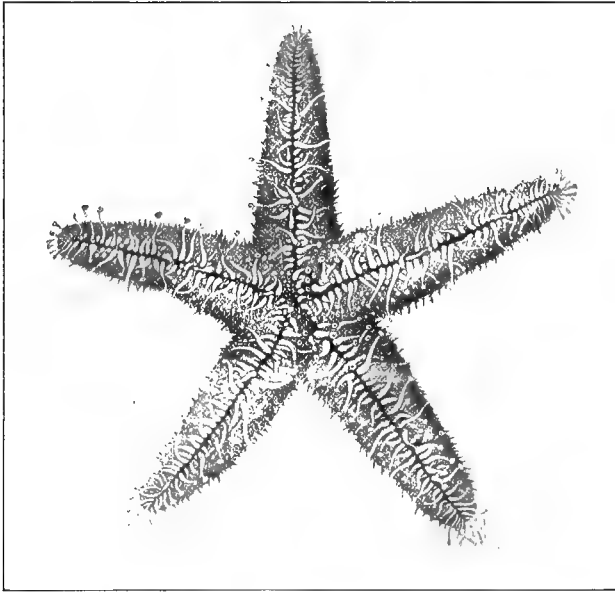


FIG. 97. Starfish, from chart of Leuckart and Nitsche.

**Questions on the figure.**—How would you describe the symmetry of the animal? Identify and name, by comparison with the diagrams and the text, all the structures which show in the figure. Compare this with specimens or figures of the common American species and note the chief differences.

may be bridged by growth in such a way that the distinction between rays and disc is not marked (echinoids). In crinoids the arms may be much branched. The oral-aboral axis is usually pronounced, often short, and is vertical in position (aster-

oids, echinoids, crinoids, etc.), though in the sea-cucumbers (holothuroids) it is horizontal and much elongated. Starfish are flattened vertically, as are the sand-dollars, but many of the urchins (echinoids) are dome-shaped. The antimeres are at right angles to this chief axis. In addition to this dominant radial symmetry, there is seen even in the adult a suggestion of the bilateral condition. The madreporic body generally occurs in only one interradius, and a plane passing through it and splitting the opposite arm divides the body into two symmetrical halves. No other plane does this. The two arms embracing the madreporic body are known as the *bivium*, the remaining three, the *trivium*. In some of the echinoids the bilateral symmetry becomes much more pronounced than in starfish.

244. **The integument** consists of an outer ectodermal portion which is often ciliated (cilia wanting in the holothuroids and ophiuroids), and a subepithelial, mesodermic layer in which is developed the calcareous ossicles. These may occur as spicules, as rods, or as plates in the various classes. They may be bound together by connective and muscle fibres. Frequently the ossicles bear spines which may or may not be movable. The spines are useful in defense and locomotion. Special forms of spines known as *pedicellariæ* often occur (asteroids and echinoids). They consist of two- or three-pronged pincers moved by muscles. They may be mounted on short stalks. It is suggested that they help clear the body of foreign objects which lodge among the spines.

245. **Digestive System.**—The mouth and anus usually open at opposite poles of the principal axis (asteroids, holothuroids, and some echinoids). When the axis is vertical the mouth is usually directed downward, in the centre of the oral surface, and the anus occupies a more or less central position on the upper or aboral surface. In some of the echinoids and crinoids the mouth or anus, or both, have vacated their central position and may come to occupy opposite margins of the body. The digestive tract is a simple tube, in the holothuroids running spirally through the body. In the echinoids a similar condition

is found except that it begins in a complex masticating apparatus of five parts (Aristotle's lantern). In the asteroids the mouth opens by a short esophagus into an expanded stomach which is divided into an oral, or cardiac, and a pyloric portion (Fig. 98). From the pyloric part the narrow intestine passes to the anus. Outpocketings (cæca) may occur in any of these divisions. The most important are the *hepatic cæca* which are glandular in function.

FIG. 98.

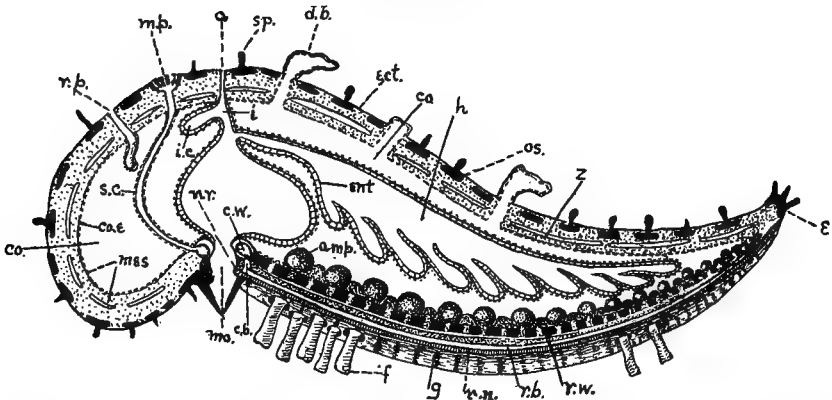


FIG. 98. Vertical (sagittal) section through an arm and an interradius of a Starfish (diagrammatic). *a*, anus; *amp.*, ampulla; *c.b.*, circular blood vessel; *c.w.*, circular water canal; *co.*, coelom; *co. e.* cœlomic epithelium; *d.b.*, dermal branchiæ; *e*, position of the eyespot; *ect.*, ectoderm; *ent.*, entoderm; *f*, ambulacral foot; *g*, ambulacral groove; *h*, hepatic cæca or liver; *i*, intestine; *i.c.*, intestinal cæca; *mes*, mesoderm; *mo.*, mouth; *m.p.*, madreporic body; *n.r.*, nerve ring; *os.*, ossicles in mesoderm; *r.n.*, radial nerve band; *r.b.*, radial blood vessel; *r.p.*, reproductive pore; *r.w.*, radial water canal; *s.c.*, stone canal; *sp.*, spines; *s*, lacunar spaces in the mesoderm. (Adapted from various sources.)

246. **The body cavity** is well developed in the disc and usually in the arms, is lined with a ciliated epithelium, and contains a fluid with amœboid corpuscles. It is completely distinct from the digestive cavity. Thin outgrowths of the body-wall (*papulae* or *branchiæ*) contain extensions of the coelom. These assist in respiration.

247. **Ambulacral or Water-vascular System.**—This system of tubular organs is peculiar to the echinoderms. It originates (see also 254), in common with the body cavity, as an outgrowth from the archenteron and is to be regarded as a specialized por-

tion of the body cavity. In some cases these two cavities are in communication in the adult. The water vascular system consists essentially of a *ring-vessel* about the mouth from which pass *radial tubes*, one in each arm. From the radial tubes arise lateral channels which communicate, directly or through bladder like *ampullæ*, with distensible *feet* which reach the exterior by pores in the skeleton (Figs. 99, 100). The tip of the foot may be provided with a sucking-disc, serving as a means of attachment and of locomotion. Frequently the walls of these feet are thin and apparently serve for respiration, and the terminal

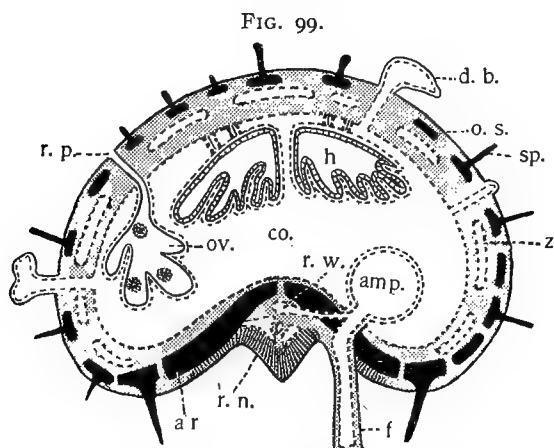


FIG. 99. Transverse section of the arm of a Starfish near the disc: Diagrammatic Lettering as in preceding figure. *a. r.*, ambulacral rafter (ossicle); *ov.*, ovary, containing ova.

**Questions on figures 98 and 99.**—What are the principal sets of organs represented in the disc of the starfish? Which of these have radial portions going into the arms? Follow carefully the ectodermal, entodermal and mesodermal boundaries. Locate and identify the various structures lettered, and determine as far as possible, whether the essential part of each is furnished by ectoderm, entoderm or mesoderm. Is there a coelom? Your evidences? What is the relation of the water-vascular cavity to the coelom, in origin?

“foot” at the end of each radius may be highly modified to form a sense organ (*tentacle*). The feet, the ampullæ, and even the radial vessels may be wanting. The ring-canal, in typical forms, communicates with the surrounding sea-water by means of a tube (*stone canal*) which terminates in a sieve-like plate, the *madreporic body*, through which the water enters the water-

vascular system. In the majority of the Holothuroids the madreporic tubes open into the body cavity instead of opening to the exterior. In consequence the fluid which is found in the water-vascular system is the same as that of the body cavity and contains amoeboid cells. In the crinoids also the water-vascular system communicates directly with the coelom, but there is no true madreporic canal. In its stead is found a system of ciliated water-tubes in connection with the ring canal. Identify the elements in the water-vascular system from Fig. 100.

248. **Respiration** occurs in connection with the water-vascular system especially in those forms in which the tentacles and ambulacral feet are possessed of thin walls (holothuroids and some echinoids). In the asteroids and echinoids there are thin outpocketings of the body-wall, papulae or branchiae (Fig. 99, *d.b.*), the cavity in which is continuous with the body cavity. The body fluids may thus be aerated from the water outside. In some forms water is drawn into special branching pockets (*respiratory tree*) in the wall of the rectum, and later is forced out again.

249. **Circulation.**—The circulatory vessels are merely partly differentiated portions of the coelom or body cavity. Our knowledge is by no means complete but it seems that in none of the groups is there a complete separation of the blood spaces from the coelom. There are probably no contractile hearts. The walls of the blood spaces may bear cilia which assist in securing the motion of the fluid. The blood contains migratory cells, usually colorless, and is identical with the fluid in the body cavity. The general body contractions are important in causing motion of the fluids. It should be remembered that the water-vascular system is also partly circulatory in function. The blood vessels of the various classes agree in having a central circular portion consisting of one or more rings, with radial tubes running into the arms, and in some instances vessels which accompany the intestine. The vessels of the oral surface are, throughout, in close connection with the nervous epithelium (Fig. 98, *r.b.*).



250. **Excretion.**—It is impossible to name any organs known to be solely excretory in function. As in respiration many organs may take part in the work. The gaseous and soluble excreta are eliminated through the general body surface, the papulæ, the respiratory tree, or the ambulacral organs. The skeletal ossicles in the mesoderm represent, in part at least,

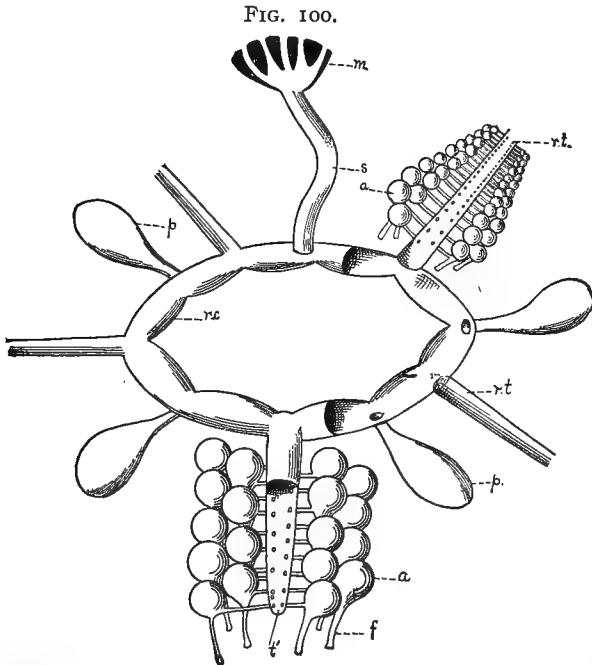


FIG. 100. Diagram of a portion of the water-vascular (ambulacral) system of the Starfish. *a* ampullæ; *f*, ambulacral feet; *m*, madreporic body; *p*, Polian vesicles; *r.c.*, ring canal, with the upper portion removed at the right of the figure; *r.t.*, radial water tubes (in *r.t.*' the upper portion is removed at the distal end and the proximal portion is represented entire); *s*, stone canal.

**Questions on the figure.**—Where does the water enter this system of vessels? At what points in the system is it of use? By comparing all illustrations at your disposal, describe the mode of using this system of organs for locomotion. How may it be used in respiration?

the elimination of certain inorganic salts which can not be used in the vital activities and are therefore excretions.

251. **The Muscular System.**—The degree of the development of the muscular system varies. In those forms which have a well-developed skeleton the body muscles are not of

much significance. In the holothurians, on the contrary, the body is capable of definite and considerable contractions, by reason of both circular and longitudinal fibres. In forms with incomplete skeletons, as the starfish, muscular fibres connect the ossicles. There is a high degree of flexion of the arms of crinoids and ophiuroids. There are also special muscles controlling the water vascular system, the stomach, the mouth parts, the spines and pedicellariæ. The fibres are non-striate.

252. **The Nervous System** consists of a ring around the mouth and a radial nervous band in each arm supplying, by a plexus of fibres and cells, all the radial organs. This system is superficial ("ventral") to the radial water-tube (Fig. 99, *r. n.*) and in the starfish preserves its connection with the ectoderm from which it is in all forms derived. Other deeper lying, and even aboral, nervous elements are described for some of the members of the group. These elements, when present, have as their function the innervation of the muscles of the interior and of the aboral wall of the body.

Sensory organs are not highly developed. The animals show evidences of possessing a chemical sense (analogous to taste and smell) by which the presence of food is detected. This is apparently localized in the tentacles in such forms as have them. A tactile sense is also present, and is most highly developed in the tentacles, ambulacral feet, and other movable outgrowths. At the tip of the antimeres of the asteroids, or of the radial nerve (echinoid) are structures bearing pigmented spots, which appear to be sensitive to light (*eye-spots*). These cannot give more than a very general impression of light, by means of the chemical changes induced in the pigment cells by the action of the light. Starfish are more quiet during the day. When the starfish is placed on its "back" it makes definite coordinated movements to right itself. Experiments seem to show that the behavior of the starfish is modified slowly by its experiences. That is to say it *learns* to do certain things in certain ways. It *retains* ("remembers") for at least a few days.

253. **Reproduction** is wholly sexual. The sexes are distinct, but the males and females are not often distinguishable by

external characters. The sexual organs, ovaries or testes, are lobed bodies occurring usually in pairs in an interradial position. These open by pores also interradial, and usually dorsal (Fig. 99, *r. p.*). There are typically five pairs of genital glands, but in the holothurians the number is reduced to one. Fertilization takes place outside the body, and usually the development is wholly independent of the parent. In some instances however the parent has special pouches in which development proceeds.

254. **Development.**—The fertilized ovum undergoes total and practically equal segmentation, producing a ciliated blastula. Gastrulation occurs by invagination resulting in ectoderm and entoderm. The mesoderm is formed in two ways: (1) by migrating cells budded from the entoderm into the segmentation cavity (Fig. 14, *c*); and (2) by the outgrowth of coelomic vesicles or pouches from the wall of the archenteron or entoderm. These latter outpockets of the wall of the gut are those which give rise to the coelom and to the water vascular system (see §247).

In the later larval development the cilia of the gastrula become limited to two zones,—a preoral and a preanal,—and the shape of the larva is much modified. Numerous paired, lateral outgrowths serve to accentuate the fundamental bilateral symmetry. In most members of the group a marked metamorphosis occurs in the passage from the larval to the adult condition. During this change, the water vascular system and the mid-gut of the larva are retained with the necessary modifications. About these as a centre, what we might almost call a new animal, the radiate starfish, begins to grow at the expense of the larval organs which are absorbed by the amœboid cells, and thus new organs appropriate to the adult are formed. During this process the bilateral symmetry of the embryo gives place to the radial symmetry of the adult. While there is no reproduction by budding there is a striking power of renewal of arms or other portions which may be lost by injury, or in some instances by self-mutilation. Arms are readily reproduced if the disc is uninjured (stars, brittle-stars, and crinoids); portions of the internal organs, as the digestive tract, are said to be regenerated

by some of the holothurians. Occasionally, at least, an arm and a small portion of disc seems to have the power of reproducing a new disc and other arms. This power of throwing off arms and replacing them is doubtless a means of protection.

255. **Ecology.**—The echinoderms are marine. The larvæ are free-swimming, but after the assumption of the adult form they usually become much less active. The crinoids are typically stalked and often attached. The asteroids and echinoids inhabit the bottom of the ocean where they creep more or less slowly. They may be found at almost any depth, from the shallow pools at low tide to the deeper bottoms. Many of them burrow in the mud and sand, and others (some sea-urchins) have the power of scouring out burrows in the rocks by the action of their spines. Echinoderms, being slow movers, are compelled to subsist upon such food as the currents or the chance movements of other animals may bring, or upon the débris which falls to the bottom of the sea, or upon such organisms as are attached and cannot escape. The starfishes, for example, are a constant menace to the oyster beds. The fact that some starfish are in a measure gregarious makes this all the more serious. It is difficult to see how the starfish can get the oyster from the protection of its shell, but it manages to get the shell open and clasping its arms about its prey it turns the cardiac portion of its stomach inside-out over the soft part of the oyster and thus leisurely digests it outside its body, so to speak, leaving the empty shell behind. Except for this the group is of little economic importance. The Chinese esteem some species of *Holothuria* (the trepang, for example) as food. The group appeared early in geological time (Cambrian) and has had very characteristic representatives in all succeeding ages up to the present. The changes which have taken place in the echinoderms from one geological age to another are among the most interesting and instructive furnished by the invertebrates.

256. **Classification.**—*Class I., Blastoidea; Class II., Cystoidea.*

(These are both extinct, fossil classes. They comprise stalked and attached forms, and perhaps represent the nearest approach of our known species to the primitive echinoderms.)

*Class III. Crinoidea (feather-stars and sea-lilies).*—These forms are less com-

mon than in earlier geological times, when they must have been very abundant and very beautiful. They contribute much to the formation of the limestone of the Palæozoic. They are usually provided with jointed stalks, by which they may be attached to the bottom. At the summit of the stalk is a central disc with five arms often much branched and bearing lateral pinnules. The anus is on the oral or upper surface, the stalk arising from aboral surface. They are inhabitants of both shallow water and deep seas.

*Class IV. Asteroidea (starfishes)* (Fig. 97).—The asteroids, of which there are several hundred species, are free echinoderms with a central disc and usually five arms. The latter are large and contain liberal coelomic spaces in which are lodged outgrowths of the digestive system and other organs. There is a distinct oral and aboral surface. The anus and madreporic body are on the latter. Distinct ambulacral grooves lie on the oral surface of the arms. Adult starfish may vary in size from a few inches to two feet or more in diameter.

*Class V. Ophiuroidea (serpent-stars)*.—These are fragile, free echinoderms in which the arms are small and much more distinct from the disc than in the asteroids. The organs of the disc are not all continued into the arms. There is no anus, no ambulacral grooves, and the madreporic body is on the oral surface. Their slender arms are useful in clinging to supports or to prey, and are used in locomotion. They are readily broken and regenerated.

*Class VI. Echinoidea (sea-urchins, sand-dollars)*.—These are free echinoderms without free arms. The arms are connected by the development of interradial plates. The calcareous rods are united into plates which produce a complete external skeleton varying from flat dome-shape (as in sand-dollars) to a globular form (*Echinus* or *Arbacia*). The mouth is usually in the centre of the oral surface and the anus near the centre of the aboral, yet one or both may come to have an excentric position. In this way the bilateral symmetry is accentuated at the expense of the underlying radial symmetry. The madreporic body is aboral and there are no ambulacral grooves. The spines of the urchins are usually well developed and may be used to scour out rounded pockets in rock in which the animals are sometimes found.

*Class VII. Holothuroidea (sea-cucumbers)*.—These are soft, free echinoderms, elongated, cylindrical or flat, with mouth and anus at opposite poles of the horizontal long axis. The skeleton is not well-developed, usually being represented merely by scattered spicules. The water-vascular system in most forms communicates with the body cavity instead of the exterior. Well-developed tentacles occur about the mouth. Most holothurians burrow in the sand or mud, but others cling to rocks near the surface of the water, and still others occur at great depths in the ocean. Their reactions are rather more complex than in the other members of the phylum. They are more muscular and more responsive to light and contacts. In addition to hiding by burrowing, they often contract the muscular wall violently and eject large portions of their viscera. These may be replaced by regeneration.

### 257. Suggestive Studies for the Library or Laboratory.

1. Read and report on the metamorphosis of the various members of the group.
2. Study from dry and moist material and report on the

structure and mode of action of "Aristotle's lantern" in *Echinus*.

3. Construct a table of parallel columns—one for each of the five living classes—and contrast them as to: (1) general form of body including symmetry, (2) manner of motion, (3) position of mouth and anus, (4) position of madreporic body, (5) character of digestive tract, (6) differences in the spines and other skeletal structures, (7) the position and character of the ambulacral feet, (8) habitat and food, (9) parts repeated in the anti-meres.

4. Report on the habits, appearance, and abundance of crinoids in geological time.

5. The origin and development of the water-vascular system.

6. Compare the figures of the various classes as illustrated in your reference texts, and mark the degree of variation.

## CHAPTER XV

### PHYLUM ANNELIDA (SEGMENTED WORMS)

#### LABORATORY EXERCISES

258. **The Earthworm** (*Helodrilus* or *Lumbricus*).—The principal work should be done with living worms. For whatever anatomical work is undertaken, specimens may be killed by exposure to fumes of chloroform while wrapped in cloth moistened with water; they should then be pinned out straight, and hardened in an abundance of alcohol. If needed in the winter they may often be found under manure heaps, or about greenhouses. They may be kept alive in flower pots containing moist earth.

1. *Promorphology; General Form.*—Is there an anterior and a posterior end? How distinguished? Is there any distinction of dorsal and ventral surfaces? If so, what? Is there bilateral symmetry? What external evidences of segmentation do you find? How are the similar units (*metameres* or *segments*) arranged? Compare with the condition in the starfish. Compare the metameres of different parts of the body, noting differences. Is the body divisible into regions (*i.e.*, groups of similar metameres)? Locate (by numbering the segments) all such regions. How many segments in the animal? To what extent does this vary in different specimens? Show by a series of diagrams the shape of the animal, and the shape and size of cross sections in various regions.

2. *Activities.*—Describe, after careful observation, the method of locomotion in the earthworm. Place the worm on a rough board; on a plate of glass. What is the difference? And why? Compare the various parts of the body as to size, during movement. Cause of the difference? Can each end move foremost? What seems to determine which end *shall* protrude as the result of the muscular contractions?

Does the animal respond equally to contact (with pencil or toothpick) at anterior, posterior, and middle parts of the body? Devise a method of determining whether it is sensitive to light. Record results.

Place moist soil and dry soil side by side on a board; place the worm in various positions to test its preference. Record results. Place a piece of filter paper which has been dipped in acetic acid in the path of a worm. How does it react? Try similarly a sugar solution; a salt solution; a decoction of decaying leaves. Will an earthworm pass voluntarily into water? Do your experiments bear in any way on the habits of the earthworm in nature? Can you secure any evidence as to the food of the earthworm? How? Record your results.

3. *Special External Structures.*—Locate the mouth, the preoral lobe, clitellum (a series of swollen segments), anus. Compare preoral lobe with other segments. With a lens and by drawing the worm backward between the fingers discover the setæ or bristles. Are they found on all segments? Number and position of the groups of setæ in each segment? What is the function of the setæ? Proofs?

4. *Internal Anatomy.*—Pin out a large specimen, which has been hardened in alcohol, on dissecting board or pan, and carefully remove the dorsal wall from the anterior half of the body by making lateral incisions with sharp-pointed scissors, or make a single incision along the back a little to one side of the middle line. After noting the transverse membranes (*dissepiments*), their relation to the rings on the outside, and their attachments, cut them so the body wall may be folded back and pinned. The dissection should proceed under fluid,—50 per cent. alcohol, for example. Make all the outline drawings necessary to show all your discoveries. Notice the coelom. It is completely divided by the dissepiments? Are the chambers of equal size?

(a) Digestive organs: Beginning at the anterior end, note the following regions:

*Pharynx*, a pear-shaped enlargement: how held in place? In what segments is it situated?

*Esophagus*, a narrow tube; *crop*; *gizzard*; *intestine*.

Determine the segments in which each region occurs. Does the digestive tract show any signs of segmentation, *i.e.*, in correspondence with the external rings?

(b) Circulatory system: A living or newly killed specimen is somewhat better for this. Discover, if possible:

Dorsal vessel (just dorsal to the digestive tract).

Ventral vessel (just ventral to the digestive tract).



Hearts, transverse vessels connecting the longitudinal vessels, in segments VII to XI.

There are other vessels more difficult to find. Examine a drop of the contents of the blood vessels with the microscope.

(c) Reproductive System: These organs are rather too complicated for satisfactory results in an elementary class. Instead of a detailed examination note the reproductive segments (in the region of the esophagus) with the whitish bodies showing at the sides of the alimentary canal, and ventral to it. They are attached to the septa. (Compare figures in various text-books.) Make a composite diagram of your own.

(d) Nervous System: In a well-hardened preparation, identify:

Brain, a whitish lobed ganglion just dorsal to, and in front of the pharynx; collar, around the mouth, connecting the brain with *ventral ganglia*, the first of a longitudinal chain of ganglia which give off nerves in each segment. How are the ganglia of the ventral chain related to the dissepiments?

(e) Excretory Organs: Just lateral to the nerve-chain the student may be able to find coiled thread-like structures (*nephridial tubes*) in nearly all the body segments (see text, §270). How many in each segment?

5. *Microscopic Demonstration*.—Good permanent mounts of transverse sections from various regions of the earthworm are valuable. Students should identify the structures studied in the gross dissection, and determine the nature of the following parts (see Fig. 103):—

Cuticle, or outer layer.

Body wall, and the relation of the circular and longitudinal muscles.

The ventral nerve-chain in position.

The dorsal and ventral blood vessels.

The wall of the digestive tract; gland cells, typhlosole, etc.

259. *Dero* (or other minute aquatic Annelid).—Any one of these fresh-water worms may be used very profitably to supplement the students' work on the earthworm. They seem to the author much to be preferred even to the earthworm for an understanding of the arrangement of the internal organs. Mount the living worm, being careful to support the cover-glass. Study with low power. Compare at all points with the earthworm. *Dero* may usually be had at any season of the year by taking mud and organic matter from the bottoms of foul brooks or ponds and placing it in vessels in the laboratory. The worms will usually come to the sides of the vessels where they may be seen. Owing to its transparent qualities, such a form will be especially valuable in giving the student a better idea of the performance of function in the group. What evidences of muscular action are manifest? How is locomotion effected? Position and mode of action of setæ? Study the capture of food;

how is its progress through the digestive tract, and its elimination therefrom effected? Do you discover any circulation of the blood? Direction of flow? Evidences? How accomplished? Test for ability to receive and respond to stimuli of different sorts. Where are new segments formed? Discover, if possible, instances of fission, by which new individuals are formed.

260. **The Leech.**—The leech may be studied and compared with the earthworm as to its external features, its habits, mode of locomotion, and the like. If large specimens can be had some members of the class might substitute it for the earthworm and the results of the studies brought into comparison.

261. **Nereis.**—Compare specimens of *Nereis* with the earthworm.

Note especially:

(a) The specialization of the anterior end; proboscis, mouth, jaws, palps, cirri, eyes, antennæ.

(b) The fleshy supports of the bristles, *parapodia*.

## DESCRIPTIVE TEXT

262. The Annelida are separated from the unsegmented worms by the possession of a series of segments or metameres which show on the exterior as rings, and contain similar or homologous organs or similar portions of a continuous organ. There is also a more uniform development of the coelom than in the lower worms. They differ from the Coelenterata in having bilateral rather than radial symmetry in the adult condition. The development is often direct, but in many, especially the marine forms, there is a metamorphosis, the peculiar balloon-shaped larva known as the *trochophore*, being (Fig. 106, *E*), similar in some respects to the Rotifers.

### 263. General Characters.

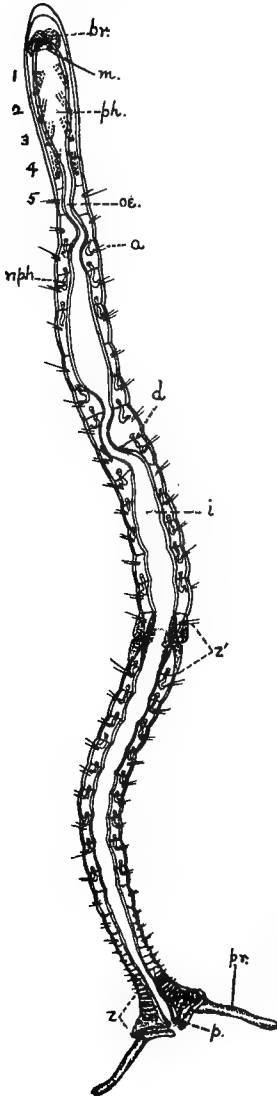
1. Body elongated, bilaterally symmetrical and segmented.
2. External paired appendages when present not jointed.
3. A well-developed coelom present.
4. One pair of excretory organs (*nephridia*) in practically all segments, connecting coelom with outside. Certain highly modified nephridia may serve as outlets for the reproductive cells in some species.

5. The nervous system consisting of (1) a supra-esophageal ganglion (brain), and (2) a circum-esophageal collar or connective uniting it with (3) a ventral chain of ganglia with a ganglion in each segment.

6. Locomotion is primarily effected by means of the contractions of the body wall, acting on body fluids in the cavity within.

7. Development either direct or indirect. When indirect, the larva passing through a trochophore stage.

FIG. 101.



264. **General Survey.**—The Annelida though conforming to the type outlined above are very diverse in appearance, habits and internal structure. While the Chætopoda,—the class to which the forms studied in the laboratory belong,—are taken as the type, the leeches, which have no bristles but possess suckers, are undoubtedly related, as is shown by their development. The Rotifers and other forms are sometimes included among the relatives of the Annelida. Metamerism

FIG. 101. *Dero*, a fresh-water oligochaetous annelid, in optical (frontal) section. Enlarged 30 times. *a*, appendages; *br.*, brain; *d*, dissepiments; *i*, intestine; *m*, mouth; *nph*, nephridium; *oe*; esophagus; *p*, pecten, lined with ciliated entoderm; *ph.*, pharynx. *pr.*, processes from the anal segment; *s*, zone immediately in front of the anal segment where new segments are continually being formed; *z'*, the zone of budding. This takes place in the middle of a segment. The anterior half-segment of *z* will produce a region like *z* for the anterior half of the worm. The posterior half-segment will produce a head and four segments like those which contain the pharynx (1-4) of the parent worm.

**Questions on the figure.**—What regions of the digestive tract are sufficiently differentiated to deserve notice? What is the number of the segment in which budding is taking place? What structures must the anterior half of this segment make? The segment behind the dividing segment becomes number 5 of the new posterior worm. What structures then must be developed from the posterior half of the dividing segment?

in animals is a most interesting phenomenon to zoologists. This group is the first in which we have found true metamerism. The body of the animals is more or less constricted on the outside into rings—as the name (Annelida) implies. The internal organs also show metamerism, but in various ways. These organs may pass directly through, with slight segmental modification, as the digestive tube and ventral nerve cord; they may be repeated independently in each segment, as the setæ or nephridial tubules; or they may be represented in only one or a limited number of

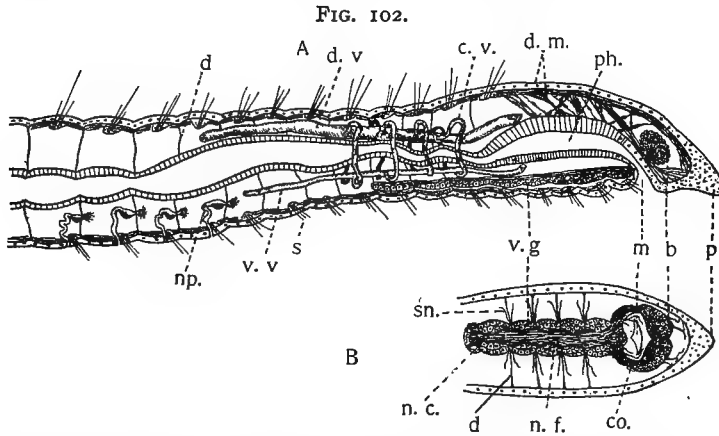


FIG. 102. Longitudinal section of anterior end of *Dero*. A, sagittal section; B, frontal section to show anterior portion of nervous system. *b*, brain; *co.*, nervous collar about the mouth; *c.v.*, contractile blood vessels ("hearts"); *d*, dissepiment; *d.m.*, dermo-muscular wall; *d.v.*, dorsal blood vessel; *m*, mouth; *n.c.*, nerve cells; *n.f.*, nerve fibres; *np.*, nephridia; *p*, prostomium; *ph.*, pharynx; *s*, setæ; *sn.*, segmental nerves; *v.g.*, ventral chain of ganglia; *v.v.*, ventral blood vessel. Notice that only a portion of the blood vascular system is shown, and this appears unsectioned in the figure; also that nervous structures and nephridia are only partially represented.

**Questions on the figure.**—Compare this with the cross section of *Dero* and identify the parts. How do the four anterior segments differ from the others figured? Does the ventral nerve cord continue the whole length of such an animal as this? Which organs may be described as segmental and which as continuous through the segments?

segments, as the brain or the reproductive organs. The segments are not therefore exactly equivalent, yet the agreement between successive segments is sufficient to merit the term *homonomous* (see §125). The number of segments varies from a few to hundreds. The body is from four or five to many times

as long as broad, and is usually cylindrical or flattened dorso-ventrally.

265. **The dermo-muscular sac** is composed of the integument and the muscular layers of the body wall. Being filled with the body fluids it is a very important instrument of locomotion. This is accomplished by the alternate contractions of the circular and longitudinal fibres with which the wall is supplied. Externally there is a cuticula, usually very thin, overlying and secreted by the layer of hypodermal cells. Some of the cells of the hypodermal layer are glandular and others are sensory. The setæ or bristles are secretions of the hypodermal

FIG. 103.

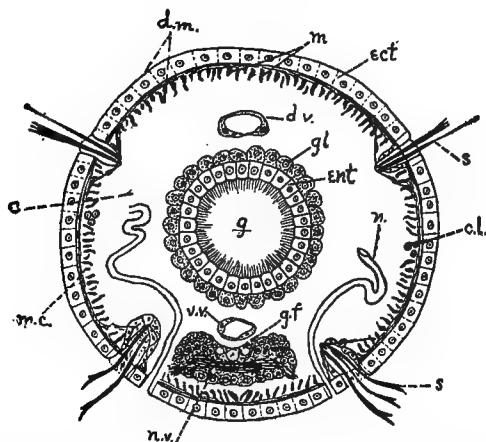


FIG. 103. Transverse section of *Devo* (diagrammatic).  $\times 300$ . *c.*, cœlom; *c.l.*, cells of the so-called "lateral line;" *d.m.*, dermo-muscular wall including muscles and skin; *d.v.*, dorsal blood vessel; *ect.*, ectoderm; *ent.*, entoderm; *g.*, gut; *g.f.*, giant nerve fibres; *gl.*, glandular cells assisting in digestion; *m.c.*, circular muscle fibres; *m.*, longitudinal muscle fibres; *n.*, nephridium; *n.v.*, ventral nerve chain, made up of nerve cells and nerve fibres; *s.*, setæ; *v.v.*, ventral blood vessel.

**Questions on the figure.**—Compare this with Fig. 102 and identify all the structures which appear in both. What elements enter into the dermo-muscular wall? Identify nerve cells, fibres and the "giant fibres" in the ventral nerve cord.

cells and lie in sacs in the integument. These structures vary in number and position but are usually paired,—two or four groups to each segment. They are absent in the leeches. Next to the skin is a layer of circular muscle fibres, and within these are the longitudinal bands of muscle fibres. In the leeches there

are also dorso-ventral fibres. Special groups of fibres occur in connection with the setæ, the mouth parts, suckers, etc. The fibres are spindle-shaped and unstriate. The dermo-muscular wall bounds a true body cavity in the chætopods; but in leeches the cœlom is almost filled with connective tissue. This suggests the condition in many of the unsegmented worms. See Figs. 101, 103.

266. Worms as a rule have no external skeleton other than the cuticula, but in some instances a tubular protective structure is formed by secretion or by cementing together small particles of foreign matter. Because of the absence of hard skeletal parts little is known concerning the worms of past geological ages.

267. **Digestive System and Feeding.**—The stomodæum, the mesenteron, and proctodæum (see §93) are all to be distinguished in the enteric canal. The mouth is not quite terminal,

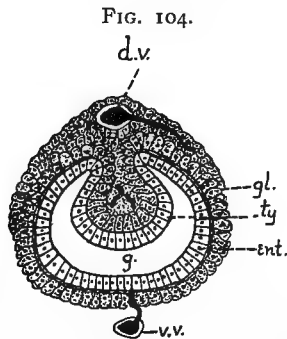


FIG. 104. Transverse section of the intestine of the *Earthworm*. *ty*, typhlosole, an infolded longitudinal ridge in the gut in which the gland cells (*gl.*) are especially aggregated. Other letters as in Fig. 103.

**Questions on the figure.**—Of what conceivable gain is the typhlosole? What is it analogous to in the higher types of animals?

but slightly ventral. The *prostomium* (or preoral lobe), a muscular extension of the oral segment, overarches it. There is typically an enlarged muscular pharynx which is often eversible, followed by a narrow tubular esophagus. Often there is no further differentiation, the remainder of the tube being fairly uniform and called the intestine. Frequently, however, special

enlargements occur, chief among which is the stomach or gizzard, —a grinding organ. In the leeches the alimentary system is much modified in accordance with the blood-sucking habit of the animal. The crop is capable of great enlargement and may contain enough blood to nourish the animal for a long time. The mouth is sometimes armed with special cuticular outgrowths which serve as teeth. Glands either unicellular or compound occur in various regions of the digestive tract. These secrete enzymes similar to those of higher animals. In the earthworm and related forms there is a dorsal longitudinal fold of the intestinal wall into the lumen of the tube, thus increasing the exposed surface. This is called the *typhlosole* (Fig. 104) and is supplied with cells which have been described as digestive. The entodermal epithelium is surrounded by connective tissue and muscular fibres.

Worms make use of every possible kind of food. Earthworms eat pieces of vegetable or animal matter, and soil containing these. They are lovers of darkness, and capture their food at night. When the light is dim they may come to the surface of the ground and, with the tail segments inserted in the opening of the burrows, explore the surroundings as far as they can reach. After night showers they may come entirely out. It is at such times as these that they become the prey of the "early bird." Many of the marine forms are actively carnivorous. Most leeches are blood-suckers, though some are carnivorous. Many small worms flourish in foul water where they use much decaying organic matter and microscopic organisms.

268. **Respiration.**—The exchange of gases is effected for the most part through the general body wall, into which the blood capillaries or the lacunæ of the cœlom may penetrate. In some forms there are special thin places and out-pocketings of the body-wall (branchiæ) by which the exchange is facilitated. These are characteristic of the Polychæta especially (Figs. 107, 108).

269. **Circulation.**—In some of the simplest worms there are no special blood vessels. The cœlomic spaces contain a fluid, which possesses corpuscles and is moved by the general body contractions. In the typical condition there are two or more

longitudinal vessels, dorsal and ventral (or lateral) in position. These are often connected by transverse loops in a few or many segments of the body especially at the anterior and posterior ends. The circum-intestinal loops are often contractile, and the longitudinal vessels may show a wave of contraction passing from one end to the other. Capillaries vary much in perfection of development. The blood contains only white corpuscles. There is hæmoglobin in the plasma.

270. **Excretion** takes place by means of the *segmental organs* or *nephridia*, of which there is usually one pair in each segment, with the exception of some of the anterior segments. The nephridium is a tubular structure consisting essentially of the following portions (Fig. 35): (1) a ciliated funnel, communicating with the coelom; (2) a tortuous glandular region; and (3) an outlet through the body wall, often supplied with muscle fibres. The nitrogenous waste products find their way into the fluid of the coelom and thence into the nephridium, or directly into the nephridium from blood capillaries which may occur in its walls, and thus are finally eliminated upon the exterior of the body.

271. **Nervous System and Behavior.**—The “central” nervous system may be said to consist of three portions: (1) a mid-ventral line of nerve fibres, and nerve cells which are diffusely scattered or collected in ganglia, (2) a brain which is anterior and dorsal to the pharynx, (3) a connective, or collar about the pharynx connecting (1) and (2) (Fig. 102). The brain and ventral cord may show distinct right and left lobes or may be completely fused into a median mass. From the brain, nerves pass to the head-parts. From each of the segmental portions of the ventral chain nerves pass to the walls, viscera, etc. The ventral cord frequently lies in a blood sinus which provides its abundant nourishment (leeches).

The sense organs occur very unequally in the group. The Polychæta and the leeches are best supplied. The integument is generally sensitive to mechanical contact, to chemical stimuli and to moisture. This sensitiveness is perhaps specially localized in the tentacles, cirri, and more movable parts. Statocysts,



fluid-filled cavities bounded by sensory epithelium, occasionally occur (see §III). Some solid particles (statoliths) float in the fluid. These have been described as organs of hearing but the sensation resulting is probably quite different from what we know as hearing. They are apparently organs of equilibration, enabling the animal to appreciate its position in relation to the pull of gravity and to appreciate the action of water waves. Eyes may consist merely of a group of pigmented cells with nervous connections, or may be very complicated, consisting of a capsule with refractive media and retina. Images of objects are not formed, in all probability, but the direction and intensity of light can be appreciated. In the leech there are sense organs in each segment somewhat similar in structure to the eyes. Their function is unknown. Even in the earthworm and other forms in which there are no eyes, the skin is sensitive to light. Most worms prefer dark places.

272. **Reproductive Organs.**—The Oligochæta and the leeches are hermaphrodite. In the Polychæta the sexes are separate. The sexual products are developed from the coelomic epithelium, sometimes on the dissepiments, sometimes on the body wall, or in other special regions. The elements may be produced in many segments (Polychæta), or in a few anterior ones (Oligochæta). The region is usually distinguishable only about the breeding time. In the hermaphrodite forms the ova and spermatozoa often mature at different times and are produced in different segments. This of course insures cross-fertilization. In the Polychæta the conditions are relatively simple. The elements are freed in the body cavity and when mature find their way into the water where fertilization takes place. The organs are much more complicated in the hermaphrodite worms. The spermatozoa are produced in the *testes*, are passed into the *seminal vesicles* where they are matured, and at the time of copulation escape to the exterior by the *vasa deferentia*, to be deposited in the *sperm sacs* or *receptacula seminis* of another worm. From this place, any time after copulation, the sperm is brought into contact with the ova of this second worm, as they pass from the *ovary*, where they are produced, to the *egg-sac*

or to the exterior. It is believed that in some instances at least the genital ducts are modified nephridia.

It will be a profitable practical exercise for the student to make for himself a diagram of the sex organs of the earthworm or some other hermaphrodite form by reference to several standard texts.

**273. Reproduction and Development.**—Sexual reproduction appears in all groups. As we have seen, copulation may occur

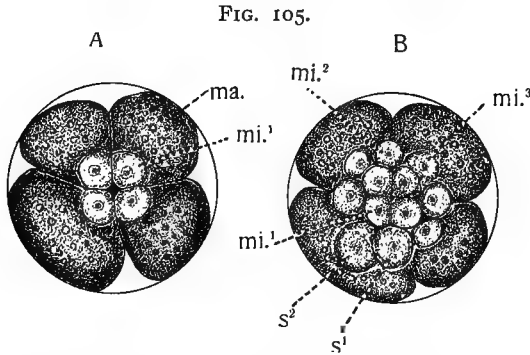


FIG. 105. Two stages in the development of *Nereis*. A, 8-celled stage; B, 16-celled stage, both viewed from the active or ectodermal pole. *mi.<sup>1</sup>*, *mi.<sup>2</sup>*, and *mi.<sup>3</sup>*, the first, second and third sets of micromeres separated from *ma.*, the macromeres; *s<sup>1</sup>*, first somatoblast, one of the second group of four cells to be budded from the macromeres; *s<sup>2</sup>*, second somatoblast, one of the third group, which gives rise to the mesoderm. The micromeres are ectodermal and the macromeres produce the entoderm. (After Westinghausen.)

or the elements may come together in the water. In the Oligochæta and leeches the fertilized ova, or the ova together with masses of spermatozoa, are enclosed in a cocoon of secreted material and within this case the young worm is developed. In the Polychæta the larva undergoes its development in a free state. Segmentation in Annelida is complete and usually unequal, giving rise at the eight-celled stage to four *micromeres* and four *macromeres* (Fig. 105). The micromeres produce the ectoderm; directly or indirectly the macromeres give rise to the entoderm. Early in the cleavage “primitive mesoblasts”—cells which produce the mesodermal structures—are separated from the macromeres. A gastrula is formed either by invagination or by overgrowth. In the earthworm (Oligochæta) the blastopore of the gastrula forms the mouth of the adult worm.

In *Nereis* (Polychæta) the blastopore closes by growth, and the stomodæum and proctodæum arise by ectodermic invaginations which finally become continuous with the entoderm of the archenteron (Fig. 106, *D*, of *Polygordius*). A ciliated, free-swim-

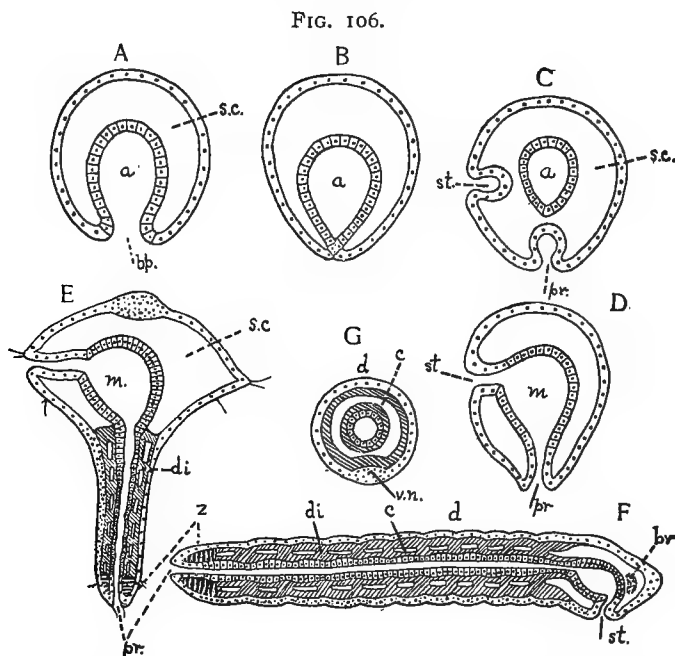


FIG. 106. Diagrams of stages in the metamorphosis of *Polygordius*, a primitive annelid. Ectoderm throughout is represented as nucleated without cell boundaries; the entoderm has the cell-boundaries shown, and the mesoderm is diagonally shaded. *A*, gastrula; *B*, same with blastopore closed; *C* and *D* represent formation of stomodæum and proctodæum from ectoderm; *E*, *Trochosphere* stage showing formation of segments in the posterior portion; *F*, adult (sagittal); *G*, adult (transverse). *a*, archenteron; *bp*., blastopore; *br*., brain; *c*., coelom; *d*., dorsal; *di*., dissepiments; *m*., mesenteron; *pr*., proctodæum; *s.c.*., segmentation cavity; *st*., stomodæum; *v.n.*., ventral nerve chain; *z*., zone of formation of nerve segments. (After Fraipont.)

**Questions on the figures.**—Trace the behavior of ectoderm and entoderm in these figures and determine what structures each seems to give rise to. What is a trochophore? Distinguish between somatic (body) and splanchnic mesoderm. (See §58.)

ming larval stage ensues,—known as a *trochophore* (Fig. 106, *E*). The trochosphere may be looked upon as representing the anterior or head end of the adult. The later metamorphosis to the adult condition involves the reduction in size of the enormous anterior region, and the growth of segments at the posterior end,

and is characteristic of Polychæta. The development of leeches is direct as in the Oligochæta, or in some instances it might be more accurate to say that the process of metamorphosis is very much abbreviated, being completed by the time of hatching.

274. In addition to sexual reproduction many worms, particularly the aquatic forms, have the power of multiplying by budding. Zones of rapidly forming segments (*Nais*, *Dero*, etc.) are produced somewhere in the mid-region of the body, and from this zone a new head is developed for the posterior zoöid and a new tail for the anterior zoöid, which usually become structurally complete before the separation takes place (Fig. 101, *s'*).

In some of the Polychæta (as *Autolytus*) a distinct alternation of generation is found in which sexual and non-sexual individuals are of very different appearance.

When artificially mutilated the earthworm, and some other types as well, may regenerate the lost portions. Groups of segments of one worm may be grafted upon another, complete healing taking place in such a way as to produce an apparently normal worm. Pieces may be grafted on the side of another worm in such a way as to produce a forked or otherwise abnormal result.

275. **Ecology.**—The leeches are aquatic in habit and many of them live on the blood of higher animals,—a kind of temporary parasitism; the Polychæta are almost exclusively marine, and the Oligochæta are chiefly fresh water or terrestrial in habit. A few of both groups are parasitic. Of the aquatic worms some are actively free-swimming, others crawl in and out among the living and dead matter of the bottom, others burrow in the sand, or secrete a tubular skeleton into which they may retire. Their chief economic importance is that they serve as food for fish and other food-animals. The earthworm, in forming its underground burrows, eats its way into the earth, swallowing the soil for the organic matter which it contains and passing it through its digestive tract. These castings may often be seen at the mouth of the burrows. Worms thus break up the soil, making it more porous and accessible to air, moisture, bacteria, and the rootlets of plants. Darwin esti-

mated that three inches of the subsoil is thus brought to the surface in fifteen years through this agency. Doubtless earth-worms bring to the surface materials that renew the soil fertility, replacing substances taken from the surface soil by plants.

276. Classification.

*Class I. Chætopoda (bristle-footed).*—Annelida with metameres usually well marked both externally and internally; with setæ developed from the hypodermis. The cœlom is usually voluminous and is divided into chambers by transverse dissepiments. Closed blood-vascular system. Ventral nerve-chain ordinarily with a distinct ganglion to each segment.

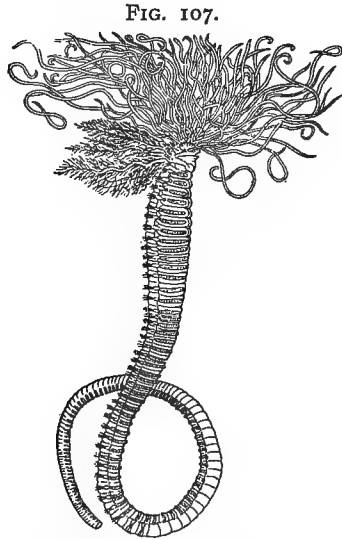


FIG. 107. *Amphitrite ornata*, from Verrill's "Invertebrate Animals of Vineyard Sound."

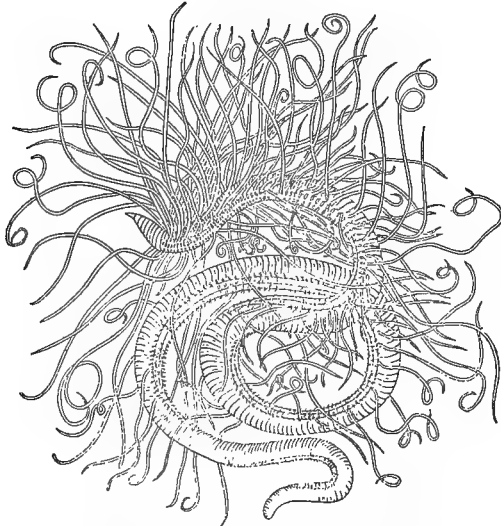
*Subclass I. Polychæta (with numerous bristles).*—Marine Chætopoda with numerous setæ typically borne on elevations of the body wall (*parapodia*). Head usually well differentiated, bearing eyes, antennæ, cirri, etc. Branchiæ or gills often present. Sexes separate; the reproductive organs simple, and repeated in many segments. A metamorphosis occurs; the larva is known as a trochosphère.

*Nereis*, the "sand worm" of fishermen, is a type of this group. *Autolytus* is a small worm especially interesting because of its power of reproducing by budding. The bud which is freed from the hinder end of the worm differs from the parent stock in that it is sexual. *Amphitrite* is a beautiful worm which represents the attached or tube-forming types. As the result of their habits such forms tend to lose their segmentation and the appendages of the posterior part of the body. The gills and tentacles accumulate about the head. These and other types grow abundantly in the sand and mud of harbors, amid the vegetation of the bottom, and over exposed objects of all sorts from low-water mark to deep water. Their value

in utilizing débris and the more minute organisms as food and thus becoming a link in the saving of these to serve as food for the higher organisms cannot be overestimated. (Figs. 107 and 108.)

*Subclass II. Oligochæta (with few bristles).*—These are Chætopoda with no parapodia and comparatively few setæ which usually occur in two or four clusters in each segment. They are mostly fresh water or terrestrial in habit. Fleshy outgrowths, such as gills, are almost universally absent. The sexes are united in one individual and the accessory reproductive organs are very complicated. Ovaries and testes limited to a small number of anterior segments; development direct. The anterior end not so highly specialized as in the Polychæta.

FIG. 108.

FIG. 108. *Cirratulus grandis*, from Verrill.

**Questions on Figs. 107 and 108.**—Are these Chætopods? What are your evidences? What is the nature and function of the numerous outgrowths (*branchial cirri*)? In what respects are they differently arranged in the two types? Are these Oligochæta or Polychæta? Your reasons?

The earthworms, of which there are numerous species, are the best known types of this subclass. The genera and species are distinguished chiefly by the position of the sexual organs. The aquatic Oligochæta, which are much smaller, are found in practically all ponds and ditches where organic matter is decaying. The more common genera are *Dero* (Fig. 101), a beautiful, almost transparent worm which often forms a temporary tube for itself of particles cemented by its own secretion, and *Tubifex*, a longer worm which burrows in the mud at the bottom of streams; a portion of the body protrudes from the mud and waves gently back and forth in the water. They may occur so thickly that thousands may be seen in the space of a few feet. When their home is jarred they speedily withdraw from sight. A

colony of *Tubifex* nearly always has associated with it one or more genera of smaller worms, as *Dero* or *Nais*, a species similar to *Dero* but with eyespots. *Dero* has an interesting respiratory apparatus at the posterior part of the body (Fig. 101, p.), one of the few instances where Oligochæta possess such organs.

*Class II. Hirudinea.*—Annelida in which there are secondary external rings which tend to obscure the metamerer, inasmuch as the external and internal segmentations do not coincide. There are no bristles. The body cavity is much reduced by the growth of muscles and connective tissue. The remaining spaces contain blood and are in communication with the vascular system. Two sucking discs are present and are powerful organs of attachment. The anterior sucker embraces the mouth; the posterior is near the anus. Sexes are united in one individual; testes numerous, ovaries a single pair. Development direct. Marine, fresh water or terrestrial. Predatory or parasitic in habit.

277. There are several other groups of "worms" of considerable interest to the zoologist, sometimes classed with the Annelida, which it seems necessary to pass by with mere mention. (See also §236).

Class: Archi-annelida; a few primitive forms, as *Polygordius* (Fig. 106).

Class: Sipunculoidea (*Gephyrea*). With traces of segmentation in the embryo, but not in the adult.

Class: Chætognatha (arrow worms).

Some authors would place here also the Rotifers (see §235).

#### 278. Suggestive Studies for Library and Laboratory.

1. Look up the characteristics of the Archi-annelida, the Gephyrea, or Sagitta, and report on their likenesses to the types studied.
2. On what grounds might the rotifers be associated with the Annulata?
3. Compare the "segments" in cestodes and Annulata.
4. In the Chætopoda which sets of organs pass through all the segments, which are repeated in essentially all, and which are limited to a few?
5. Examine and report on the habits of the earthworm. (Study in its natural haunts or in box of moist earth in laboratory.) What are its haunts? Method and rate of burrowing? Does it avoid water? What is its food? How taken? Does the animal prefer light or darkness?
6. If near the sea-shore select other forms and report in a similar way.
7. Investigate parasitism among the Annelida.
8. What is the economic value of the earthworm? Of other worms?
9. Make a study from the text-books of the reproductive organs in any of the hermaphrodite Oligochæta.
10. In how many species of aquatic Oligochæta do you find reproduction by fission? In what particulars does the process seem to differ in the different species?
11. Outline the life-history of *Autolytus*, including the origin of the sexes.

## CHAPTER XVI

### PHYLUM X.—MOLLUSCA

#### LABORATORY EXERCISES

279. **The Clam (*Mya*) or Mussel (*Anodonta*, *Unio*).**—Either the marine or the fresh-water type will serve. The latter are to be found in almost all our streams and small lakes. They may be obtained with a long-handled rake from the shore or from a boat. They often occur partly buried in the sand or mud. If kept in water they may be transported to the laboratory and placed in a tub of water with a few inches of sand at the bottom, where something of the physiology may be studied with profit. If they cannot be collected when needed for study, they should be well hardened and covered with the preservative fluid in which they are to be kept.

1. *The Living Animal.*—What facts were observed, in collecting the material, concerning their haunts, their abundance in different localities, their range in size, etc.? Are there any efforts at active feeding, as far as you have seen? Do you think all your specimens belong to the same species?

In nature or from the specimens in the tub, make out the following points:

Has the animal power of voluntary motion? If so, what of its rate, manner, and the position of the animal during motion? Note the trail. Determine anterior and posterior ends, right and left sides, dorsal and ventral surfaces. How is this done? To what extent can the soft parts protrude from the shell? Note briefly, for later reference, the position of all visible structures. How widely does the shell open during life? With a pipette place a drop of some colored but harmless fluid (carmine in water) near the fringes of the posterior end, and note the results. Vary by introducing salt, sugar, and acid in the solution. Devise experiments to test whether the animal shows



sensitiveness to stimuli of various sorts: jars, contacts, currents in the water, light, warmth and cold.

2. *General Form.*—Renew your observations concerning the symmetry of the clam by careful examination of the animal. Determine and show in a sketch all the points distinguishing the anterior and posterior ends. Are the right and left halves symmetrical? Use a pair of empty shells for more complete study.

The shell: what is the relation between the valves? How are they held together? Are they normally open or closed? Give your evidences? To what extent may the shell open without doing violence to the animal? How does the shell vary in thickness at various parts? Contrast the interior and exterior as to *finish* and *markings*. Make note of everything found, with outline drawings, showing position. Locate the following regions and structures:—hinge, umbo or beak (a prominence near the hinge), hinge ligament, hinge teeth, pallial line (a slight depression marking the attachment of the mantle muscle), muscle impressions, lines of growth. Review after studying soft parts.

What layers are discoverable in a broken shell? How do the inner, outer, and middle layers differ in thickness and appearance?

Do you find any differences worthy of note in different individuals?

3. *Soft Parts.*—Remove the left valve by cutting the two muscles which hold the valves together. Leave *all* the soft parts in the right valve as little disturbed as possible. Make a sketch showing the relation of the body to the shell. If there is any difficulty in cutting the muscles, the clam may be made to open by immersing it in water heated to about 140° F. Identify:

Left mantle flap. How related to the right? to the shell?

Siphons: modifications of the posterior margins of the mantle. (These will be conspicuous or rudimentary in accordance with the species studied.) Number?

Adductor muscles of the valves; number and position.

Mantle cavity. Separate the right and left mantle lobes

along the ventral margin, except in the region of the siphon, and fold back the left. Where is it attached to the body? The ventral or *incurrent* siphon opens into the *branchial* chamber, the dorsal or *excurrent* into a smaller dorsal chamber,—the *cloaca*. Verify and sketch.

Gill plates or sheets; number and attachment. Are they symmetrical on the two sides? The eggs and developing embryos may be found in the outer gill cavity at favorable times. (A special study and report may be profitably made by some student on the structure of the gills as shown by a hand lens and the low power of the microscope. A bit of the living gill from a fresh specimen should be examined.)

Abdomen,—the soft, fleshy mass between the pairs of gills, which terminates in a more solid part,—

Foot: position and form?

Mouth and labial palps; at the anterior end and just below the adductor muscle. How many palps?

(It is to be remembered that *all* the structures examined thus far are *external* organs. The body wall has not been penetrated at all. If it is the plan to study the anatomy more closely, the following are the chief sets of organs deserving attention.)

#### 4. Other systems of organs.

Circulatory system. Open the pericardial cavity, just beneath the hinge and a little posterior thereto, and find the

Heart: auricles and ventricle. In a fresh preparation the contractions of the heart may be observed.

Vessels: one passes in each direction, but they are not easily followed without injecting.

The intestine passes through the ventricle without open communication with it.

#### Excretory organ.

Organ of *Bojanus*, or kidney, lies just beneath the floor of the pericardial cavity, one part on either side.

Each portion is a dark-colored sac, with an abundant blood supply.

#### Nervous system. (Traced best in hardened preparations.)

Visceral ganglia. Look between the gills in the posterior portion of the body, beneath the posterior adductor muscle, and in the floor of the cloacal cavity. Number, and closeness of connection? By careful dissection determine what nerves leave them. Trace a pair of these forward to the

Cerebral ganglia, on either side the mouth. Note the connections between the cerebral ganglia. Trace from these ganglia the connectives which pass ventrally to the

Pedal ganglia in the muscular foot, close to its union with the abdomen. Make a clear diagram showing the relations of these three pairs of ganglia.

Digestive system.

Begin with the intestine at the heart. Trace posteriorly to the anus.

What is its relation to the posterior adductor muscle? Pass a bristle into the intestine anteriorly and use it to guide the dissection. Trace the intestine through the abdominal mass, and plot its course. Identify the stomach, the esophagus, and the mouth. The liver is a brownish or greenish mass surrounding the stomach.

Much of the visceral mass through which the intestine coils is made up of the large reproductive glands which open into the mantle cavity.

5. Cross Sections.—A series of cross sections may be made, numbered, and used with profit as demonstrations. For such sections the soft parts of the animal should be hardened for 24 hours in 1 per cent. chromic acid; then one day each in 70 per cent. and 90 per cent. alcohol. Keep in 95 per cent. alcohol for a few weeks. Cut one-fourth to one-third inch thick and number so as to be able to locate position of section. Float in dish of alcohol and identify the parts found. Make sketches of sections passing (1) through the stomach, (2) through the heart, and (3) through the middle of the posterior adductor muscle.

280. **The Oyster.**—One or two students should prepare a report on the structure of the oyster and present to the class an account of the chief points of contrast between the oyster and the clam. The adult oyster is fixed by one of its valves. Is it the same one in all specimens?

### 281. **The Pond Snail** (*Limnæa*).

1. *The Living Animal.*—Observe, both in its natural home and in glass vessel containing water, in the laboratory.

To what does the animal adhere in the water? Must it have solid support? Can it swim? What is its method of locomotion? What does it eat, and how? Can you determine whether it uses the air in breathing or gets its oxygen from the water? Proof? How is the gliding motion effected? Watch, with a lens, one crawling along the side of the glass vessel. Record signs of sensitiveness to stimuli, by experiments of your own devising.

2. *General Form.*—Is there any sign of bilateral symmetry? In what parts? How are anterior and posterior distinguished? Relation of the shell to the animal? Identify:—

Head: tentacles, number and position; eyes, number and position.

Foot, the muscular expansion: shape, changes in form and position.

Mouth.

Respiratory orifice, position. Under what circumstances seen?

3. *Shell* (secure empty ones).—Make sketches of the shell and identify the structures referred to in the following terms: apex, aperture, lip, spire, whorl, suture, columella. (See Fig. 110).

How would you describe the direction of the spiral? How many whorls? Have the young and old the same number? Can you detect lines of growth?

4. *Soft Parts*.—These may be removed by dropping the animal suddenly into hot water, and then gradually twisting the soft portion from the shell. It will scarcely repay the trouble to do more than re-identify the following parts: mouth, respiratory orifice, mantle and mantle chamber, and collar (a portion of the mantle). The spiral is occupied by the digestive tract, its glands, the reproductive bodies, etc.

5. *Development*.—Examine the stems of plants and the sides of the vessel in which snails have been kept for some days for gelatinous capsules of eggs. They are almost transparent and the eggs may be easily located. What seems to be the value of the gelatine? Number and arrangement of the eggs? What is the shape of the eggs? Get the earliest stages possible, and watch day by day at short intervals, or compare capsules of different ages. If care is taken, some idea of the early segmentation stages may be obtained. Look for the blastula: are the cells of the same size? Do you find a gastrula? What are the first signs you find of differentiation of parts? Look for different stages of the later development. It will not be profitable to try to follow the changes in detail.

282. A very valuable laboratory exercise may be had by comparing large numbers of shells of a single species, found under varying conditions. Compare as to shape, markings, etc., and see whether there are individuals connecting your extreme groups. The land snail (*Helix*, Fig. 121) is favorable for such study. *Helix* may be substituted for *Limnaea*.

283. **The Squid**.—The laboratory should have a few specimens of the Squid. Make drawings showing all external features.

Note particularly:—

Head: tentacles, number, comparative length; suckers on the inner surface, arrangement of suckers.

Eyes: number, size, position.

Olfactory organs opening beneath folds of skin behind the eyes.

Neck.

Body: general shape. It is surrounded by the

Mantle; note the fin expansions at the posterior end. Where are the attachments of the mantle to the body?

Siphon; how related to the mantle cavity?

What are your conclusions as to the symmetry and the normal position of the squid? Do you find anything from your external examination which would lead you to class it with the clam and the snail?

### DESCRIPTIVE TEXT

284. The group Mollusca (*mollis*, *soft*) embraces about 65,000 living species among which there are very great differences as illustrated by forms as unlike as slugs, snails, oysters, clams, devil-fishes, and squids. With the exception of a few, they are sluggish animals and largely aquatic or frequenters of moist places. Some are well protected by external armor and others are perfectly naked. The typical adult mollusk is clearly marked off from both the radiate animals such as echinoderms and the segmented animals such as the arthropods and the Annelida, but some of the simpler types of mollusks, and the larvæ of certain of them which undergo a metamorphosis, strongly suggest that they may be related to some of the worms.

#### 285. General Characters.

1. Body soft, unsegmented, bilaterally symmetrical and without segmented appendages.

2. Organ of locomotion a muscular thickening of the body, called the *foot*; variously modified.

3. A thickened dorsal fold of the body wall, called the *mantle*, usually present, enclosing a space, external to the body, known as the respiratory chamber.

4. Often a calcareous shell, secreted by the mantle usually becoming either spiral or separated into a right and left valve.

5. Central nervous system usually consisting of three sets of ganglia: (1) the cerebral or "brain," above the mouth, (2) the pedal, in the foot and connected with the cerebral by nerves, and (3) the visceral, also connected with the brain by a pair of nerves (Fig. 38).

6. Except in the headless forms (*Acephals*) a tooth-bearing ribbon, the *odontophore*, present in the mouth.

286. **General Survey.**—The more commonly known forms are easily recognizable by the hard calcareous shell which protects the soft unsegmented body within. The shell may be

in two sub-equal valves, right and left, or may be in one piece, in which case it is usually coiled or spiral (Fig. 110). The bivalved types are able to open and close the shell, and the soft parts are capable of protrusion from the partly opened shell. This latter power is much more pronounced in the univalved types (*e.g.*, snail). The fundamental bilateral symmetry is obscured in the more sluggish forms, but is very decided in such active animals as the squid and some of the bivalves.

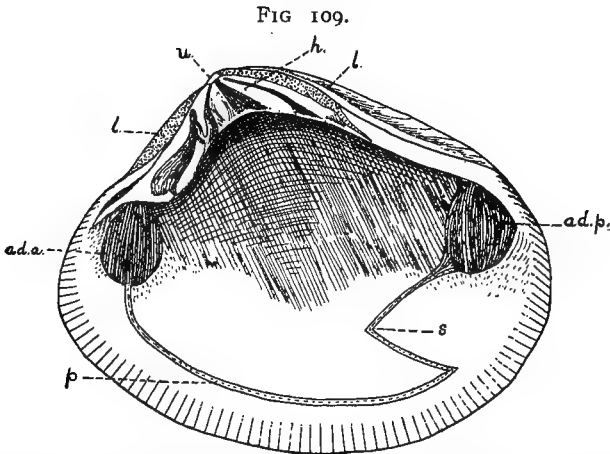


FIG. 109. Shell of a Bivalve Mollusk, inner surface. *ad.a.*, depression showing the attachment of the anterior adductor muscle; *ad.p.*, posterior adductor muscle; *h*, hinge with teeth; *l*, attachments of the ligaments; *p*, pallial line, marking the attachment of the mantle muscles; *s*, the pallial sinus, marking the attachment of the retractor muscles of the siphon; *u*, umbo or beak.

**Questions on the figure.**—Which is the dorsal and which the ventral portion of the shell? Is this the right or left valve? What is the effect of the contraction of the adductor muscles? What is the value of the teeth on the hinge? To what point in the shell of the snail does the umbo correspond?

One of the most interesting points of difference among the members of the group is the degree of development of the "head." In the bivalves (lamellibranchs) there is a very slight cephalization, or collection of special organs about the anterior end. For this reason they are often called Acephals. In the gasteropods (snails, etc.) and cephalopods (squid), on the other hand, the head is well developed both as to special mouth parts and nervous organs.

The forms with shells are somewhat more limited in size than the cephalopods, which furnish the largest representatives of the phylum, measuring in extreme cases 20 to 40 feet in the reach of the arms.

The calcareous shell insures abundant fossil remains, representatives being found in various geologic formations from the beginning of the Palæozoic era to the present.

FIG. 110.

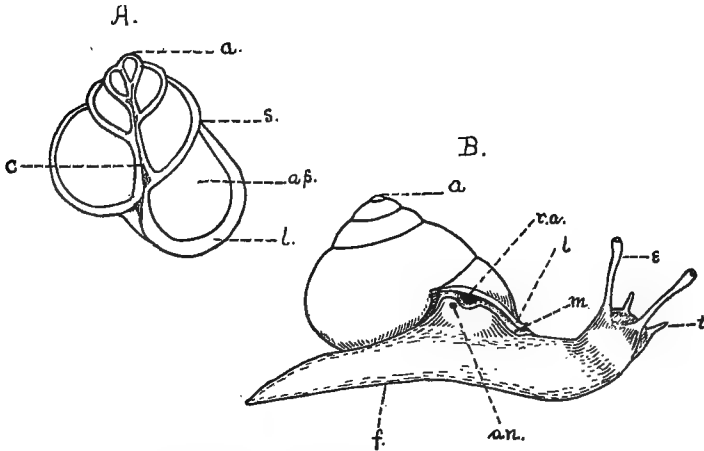


FIG. 110. *Helix*. A, an empty shell in section from apex to base. B, the relation of the animal to the shell when extended. *a*, apex of shell; *an.*, anus; *ap.*, aperture of shell; *c*, columella or axis of shell; *e*, eyestalk; *f*, foot; *l*, lip of shell; *m*, edge of mantle, which secretes the shell; *r.a.*, respiratory aperture; *s*, suture, between the whorls; *t*, tentacles.

**Questions on the figures.**—What suggestions of bilateral symmetry are shown by the snail? Where does growth occur in the shell? What are the functions of the tentacles? What is the function of the edge of the mantle called the “collar” (*m*)?

**287. Integument (skin).**—This consists of a layer of epidermal cells, covering a deeper dermal layer derived from the mesoderm. The former is made up chiefly of the supporting cells and the simple glandular cells which secrete mucus, or lime, or pigment. In many forms a large portion of the epithelium in the mantle cavity (as the inner surface of the mantle and the covering of the gills in lamellibranchs) is ciliated. The dermis is a complex of connective tissue, muscle fibres, pigment cells, etc. The *mantle* is a fold of the integument which is very

characteristic of Mollusca. It grows out from the dorsal wall of the body and encloses a space known as the mantle cavity. It is usually important in respiration, and contains the shell-glands.

288. **Shells** are formed in all the classes of Mollusca, although naked forms occur in several of them. The shell is a true secretion or excretion, deposited by the epithelial layer of the mantle. It consists of three layers: (a) a thin external layer of organic material known as *conchiolin*, (b) the *prismatic* layer, embracing the greater thickness of the shell and made up of prisms of carbonate of lime cemented by conchiolin, and (c) the *nacreous* or pearly layer over the inner surface. The edge of the mantle secretes the first and second layers, and they usually show lines of growth parallel with the edge of the mantle; the pearly layer is deposited by the whole surface of the mantle. The point of attachment of the muscles presents a depression in this layer because the deposit has been interrupted (see pallial line and muscle scars, Fig. 109; and in shell of clam).

In some Cephalopods there is an internal skeleton in part secreted by the mantle (cuttle bone), and in part formed of cartilage (the brain case).

289. **The muscular system** is made up of unstriped muscle fibres, which usually occur in more or less prominent bands or muscles. These may be classified as follows: (1) shell or skeletal muscles, which embrace (a) *adductors*, those which draw the valves together (lamellibranchs), (b) *retractors*, which withdraw the whole or special portions of the animal into the shell (lamellibranchs and gasteropods), (c) *protractors*, or *extensors*, which enable the animal partly to extend itself; (2) *pallial* (mantle) muscles, best developed in cephalopods; (3) the *foot*, which is a mass of muscle and is one of the most characteristic of the molluscan organs; and (4) minor muscles controlling the *radula* or tongue, the other mouth parts, and the like.

Locomotion in the group is accomplished chiefly by the foot, in its various modifications, or by rhythmic opening and shutting of the valves. The squid has a fin-like extension of the integument which is an efficient organ of forward motion. The



siphon of the same animal is regarded as a modification of a part of the foot and takes part in backward locomotion. The tentacles about the mouth are also looked upon as arising from the anterior part of the foot, hence the name Cephalopoda, which means "head-footed."

290. **Digestive Organs.**—Mouth and anus both occur, and are usually widely separated. In the coiled forms (as the snail), however, by the looping of the digestive tract they are brought close together. In all except the group of headless mollusks (lamellibranchs) the mouth is supplied with a *radula*, or tooth-bearing tongue. This lies in the floor of the mouth and, as it is worn away in front, is renewed from behind in the radula sac (Fig. 111). It rasps small particles from solids and conveys

FIG. 111.

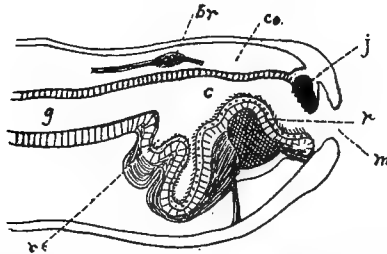


FIG. 111. Diagram of mouth of snail, showing the lingual ribbon (radula). *br*, brain; *c*, buccal cavity; *co.*, coelom; *g*, gullet; *j*, jaw, against which the radula works; *m*, mouth; *r.*, radula; *r.s.*, radula sac, in which the radula is renewed as it is worn away in front.

**Questions on the figure.**—What parts go to make up the "odontophore?" How do the parts act in biting?

them backward into the esophagus. In the gasteropods there is a plate in the upper jaw against which this organ works. In the cephalopods beak-like jaws occur suited to their carnivorous habit. The mouth is followed by a gullet, which may communicate at once with the stomach (lamellibranchs), or may expand into a crop (gasteropods and cephalopods). The stomach is well marked and opens into the intestine which is usually long enough to make one or more coils in the body mass. It may open externally (gasteropods) or in the mantle chamber (cephalopods and lamellibranchs). Salivary glands pour their secre-

tion into the mouth cavity or into the gullet, and the so-called liver connects with the stomach or intestine.

291. **Respiration.**—The oxygen may be derived from the water (lamellibranchs, cephalopods, and some gasteropods) or from the air (pulmonate gasteropods). In the latter a pulmonary chamber is formed by the mantle. Blood is richly supplied to the walls of this sac and is there aerated after the manner of lungs. In the water-breathing forms the gills are

FIG. 112.

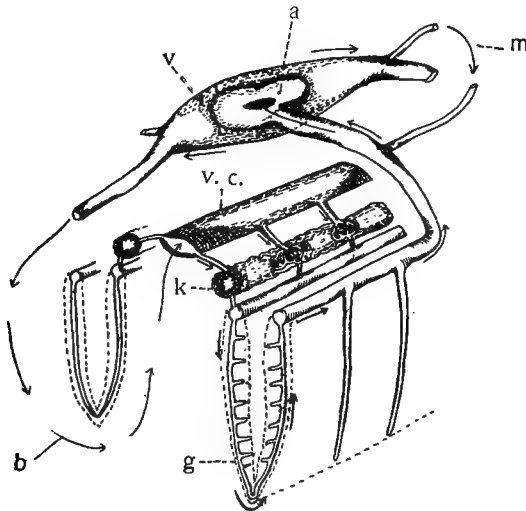


FIG. 112. Diagram showing the heart and general course of the circulation in the Lamelli-branchs. Only a short section is shown. *a*, auricle (right), with slit to ventricle; *b*, the body (region of spaces, lacunæ, capillaries); *g*, the region of the gills, with capillaries; *k*, kidneys, with their capillaries; *m*, the mantle and capillaries; *v*, the ventricle from which arteries pass forward and backward; *v. c.*, "vena cava," in which the blood collects on returning from the tissues of the body.

**Questions on the figure.**—Follow by the arrows and letters the general course of the blood flow. How many sets of capillaries are passed by the blood which goes to the mantle? By that which goes to the system, before returning to the heart? What changes take place in the blood in the capillaries of the various regions?

variously constructed. Lamellibranchs possess a pair of "gill-plates" hanging in the mantle cavity on either side the body. These are made up of an immense number of ciliated tubular filaments which intercommunicate in a complicated lattice-work. To the naked eye they appear as thin sheets with stri-

tions passing from the dorsal to the ventral margin (see dissection of clam). The walls of the gills contain blood vessels, and the water, assisted by the action of the cilia, circulates over and through the gills. In the cephalopods and aquatic gasteropods the gills occur as tufts of filaments, which may or may not be covered by the mantle. In addition to these special organs the mantle and the soft body surface assist in respiration. (For figures of the gill structure in the clam see Parker and Haswell's Text-book of Zoology, Vol. I, Fig. 669.)

292. **Circulation.**—There is usually a well-developed circulation of the blood, but a portion of it occurs through irregular spaces devoid of walls proper. The organs consist of a contractile heart usually with undivided ventricle and a single auricle

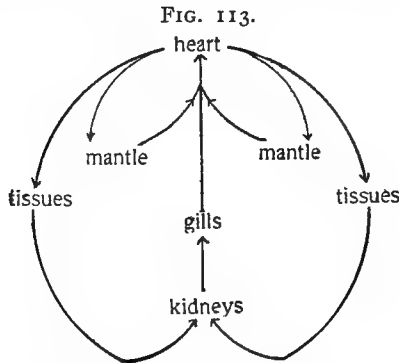


FIG. 113. Diagram showing the general course of the circulation in mollusks. Compare with Fig. 112, which shows the organs more nearly in their relative position.

**Question on the figure.**—Why does the blood which passes to the mantle need not pass the gills before returning to the heart?

(gasteropods), or one pair of auricles (lamellibranchs, squid), or two pairs (*Nautilus*). Definite arteries pass both forward and backward from the ventricle. The blood passes from the ventricle to the tissues of the body, whence it gathers into venous spaces and passes into the kidneys and the gills by way of a principal vein. From the gills it finds its way to the auricles. In lamellibranchs the blood which goes from the ventricle to the mantle is aerated and returns directly to the auricle. In some cephalopods there are branchial hearts near the gills to

assist the return of the blood to the heart. The accompanying diagrams (Figs. 112, 113) will help the student follow the main facts of the circulation. In lamellibranchs the ventricle often surrounds the intestine. The corpuscles are colorless and amoeboid. The plasma, however, quite commonly contains a bluish pigment (*hæmocyanin*) which assists respiration in much the same way as the hæmoglobin of the vertebrates.

293. **Excretory Organs.**—In mollusks the excretory organs consist, when reduced to the simplest terms, of one or more nephridia which communicate interiorly with the pericardium or principal cœlomic space, and with the exterior by way of a tubular ureter. The kidney portion of the tube is much modified, has glandular walls and is well supplied with blood vessels. It lies in the immediate region of the pericardial chamber in most cases.

294. **Nervous System.**—The nervous system of mollusks is usually made up of at least three pairs of ganglia: (a) the “brain” or cerebral ganglia dorsal to the mouth and varying in size according to the degree of development of the head; (b) connected with the brain by a pair of connectives are the pedal ganglia lying ventral to the mouth and innervating the foot; (c) the pleuro-visceral ganglia variously situated in the different groups and connected with the brain or both with the brain and the pedal ganglia. From it nerves pass to the mantle, and to the posterior organs. In gasteropods and cephalopods all these ganglia are much closer together and are collected about the mouth. Still other ganglia are often associated with them. The student should notice how this collection of nervous matter accompanies the development of “head” organs in the better developed members of the phylum.

295. **The Organs of Special Sense.**—As usual, scattered sensory cells are situated in the exposed epithelial surfaces. These give rise to a diffuse sensitiveness to tactile and chemical stimuli. The edges of the mantle and the tentacles are especially sensitive. Patches of sensory cells—*osphradia*—are often found near the bases of the gills, which probably

have a value in testing the character of the water flowing over them. Still other patches occur about the lips. Otocysts or statocysts (see §111), occur in all the groups. Eyes are usually found and are of various degrees of complexity. They are simplest in the lamellibranchs (Fig. 43), and when found at all in this group may occur in great numbers along the mantle.

FIG. 114.

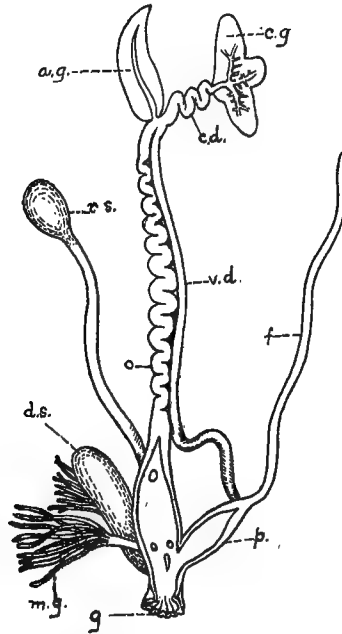


FIG. 114. Diagram of a dissection of the reproductive organs of a snail. *a.g.*, albumen gland; *c.d.*, common or hermaphrodite duct; *c.g.*, hermaphrodite gland; *d.s.*, dart sac; *f*, flagellum; *g*, genital aperture; *m.g.*, mucous glands; *o*, oviduct; *p*, penis; *r.s.*, receptaculum seminis; *v.d.*, vas deferens. The slit from the genital aperture into the oviduct and penis shows the openings of the dart sac, mucous glands, and the receptaculum seminis. (After Pelseneer.)

Questions on the figure.—By a careful study of the figure and the text, determine the functions of the various parts of the system. Does self-fertilization occur in a form like this? Evidences.

In the gasteropods the eyes are borne on the ends of tentacles and are frequently destroyed by accidents. The animals have the power of regenerating the tentacle,—eye and all. This manifestly is a very useful adaptation. The eyes of cephalopods are the most perfect single eyes found among the invertebrates.

Though originating in a different way, these are strikingly like the vertebrate eye.

The forms with shells are not so responsive to stimuli as free types such as cephalopods, but even the snails, and in less degree the clams, are sensitive to light, contact, gravity, chemical states of the air and water that would in us arouse the sense of taste or smell. The most characteristic reaction of the lower forms is to withdraw into the shell or to close it. Gravity and light and odor also direct their motions.

296. **Library Reference.**—Make a report on the position and general structure of the eyes in gasteropods, cephalopods and lamellibranchs.

297. **Reproduction and the Genital Organs.**—Reproduction is always sexual. In some of the lamellibranchs (*e.g.*, oyster) and many of the simpler gasteropods, including the land snails, the individuals are hermaphrodite. The sexes are separate in the cephalopods and in most of the lamellibranchs and gasteropods. The organs are more complicated among the hermaphrodite gasteropods than elsewhere in the group (see diagram, reproductive organs of snail, Fig. 114). The sexual glands are usually situated in the visceral mass among the coils of the intestine. The ducts ordinarily open into the mantle cavity, where fertilization may occur. The eggs after fertilization are often, either singly or in masses, surrounded by a gelatinous secretion (as in the snail) which serves as a protection from drouth and as a means of attachment. In lamellibranchs the young are not infrequently retained in the gill cavities until partly developed.

298. **Development.**—Segmentation is total (lamellibranchs and gasteropods) or partial and discoidal (dibranch cephalopods). It is usually unequal in the lamellibranchs and gasteropods, but in some of the latter it is equal during the first two divisions, producing four equal blastomeres. Each of these divides into a large and a small cell—*macromere* and *micromere*. Still other micromeres are formed at the expense of the macromeres, and these by continued division form a cap of ectodermal cells (Fig. 115). From the macromeres arise ultimately the entoderm and mesoderm. The gastrula may be formed either by

invagination of the large cells or by the overgrowth of the micromeres, depending on the size of the segmentation cavity and of the entodermal cells. In the cephalopods, owing to the large supply of food substance in the ovum, cleavage is confined to a small disc at the active pole. From this point where the embryo is destined to be developed, a sheet of cells gradually extends itself by growth around the yolk. Thus a yolk-sac is formed by means of which the food is used in the further development of the embryo. By the time the embryo is hatched the yolk is exhausted. Although the yolk does not segment we see that it serves its purpose in the development of the embryo.

FIG. 115.

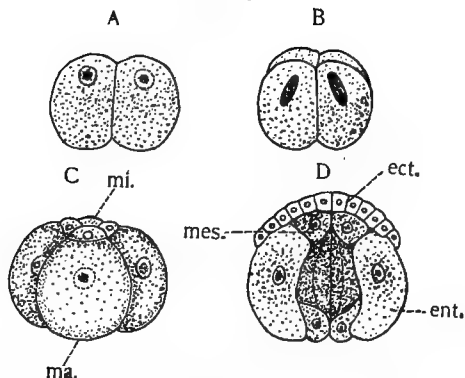


FIG. 115. Diagram of early segmentation stages in a Gasteropod. A, 2-celled stage; B, 4-celled; C, 8-celled; D, later stage, in section. *ect.*, ectoderm cells (micromeres); *ent.*, entoderm cells, macromeres; *mes.*, mesoblasts, early put aside,—before gastrulation—to form the mesoderm; *mi.*, micromeres; *ma.*, macromeres.

**Questions on the figures.**—What causes are assigned for the difference in the size of the cells in the 8-celled stage? In what other ways is mesoderm formed in the metazoa? Which cells seem to divide more rapidly, the micromeres or the macromeres? Compare with *Annelid*, Fig. 105.

The *later development* is typically indirect, *i.e.*, with a metamorphosis, though many (as the cephalopods) develop directly into the adult form. A larval stage (*trochosphere*) occurs, suggesting the larvæ of the Polychæta. This is followed by another stage (*veliger*) which is more characteristic of the mollusks.

**299. Library Exercises.**—Students may well supplement the text by making short reports on the following topics: the early segmentation of lamellibranchs and gasteropods; of the cephalopods; the veliger of mollusks; the formation of the

organs in cephalopods; development in the clam or mussel. Illustrations should be found in the advanced text-books and presented to the class.

300. **Ecology.**—The bivalves are sedentary or sluggish in their manner of life; the motion of most of the gasteropods is slow and difficult. In conformity with their limited powers of locomotion, they are scavengers, feeding on the débris and the small animals and plants brought to them by the water currents (oysters, mussels, etc.), or are largely herbivorous (many snails). A very few are parasitic. The cephalopods are much more active and are carnivorous. For the most part the sluggish forms are well protected by the shells, nevertheless they furnish food for many diverse sorts of animals. Some of their enemies are internal parasites, others bore through the shells and thus gain access to vital parts.

The animal within may thwart this attack of its enemies by the continued secretion of mother-of-pearl on the inner surface at the threatened point. Some animals crush the shells, or swallow the mollusks, shell and all. Starfishes, as we have seen, are especially troublesome to the oyster beds.

Many of the bivalves are capable of still further protection because of their elongated siphons which enable them to burrow deeply in the mud or sand, the food being carried in through the siphons by the water currents (Fig. 116). Several species of marine bivalves have the power of boring into wood or even stone. This serves as a protection to them, but often results in the complete destruction of piles and other structures placed in the ocean by man.

Many of the mollusks seem more or less gregarious, as is illustrated by beds of clams and oysters, the schools of squid, etc.

Notwithstanding the low organization and sluggishness of a large portion of the branch Mollusca, we are compelled to consider that it has been a very successful group in that it has held its place with practically equal numbers through the geological ages, and has succeeded in adapting itself to the changes in conditions during those ages. Of no less interest is the additional fact that there is scarcely a nook, into which they have not penetrated, except where continuous drouth prevails.



On the other hand, it is among the more active types—the cephalopods—that the ancient geological forms have least successfully adapted themselves to modern conditions. The cephalopods appear much less numerous and varied now than in earlier geological time, although the types which have persisted are the most perfect and active ones that have appeared.

301. **Relation to Human Interests.**—This is the first phylum that we have studied that furnishes any food, worthy of mention,

FIG. 116.

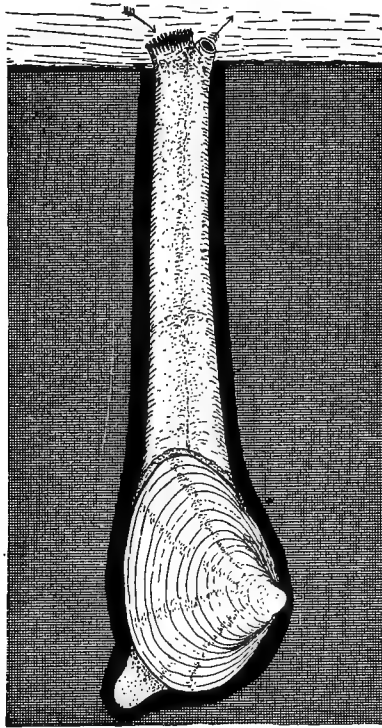


FIG. 116. *Mya arenaria*, a burrowing clam. The siphon is represented as fully extended. This is quickly retracted when the animal is disturbed. (After Kingsley.)

**Questions on the figure.**—What is the function of the much elongated siphons? Which is the anterior end of the animal? Which the dorsal side? What would seem to be the chief function of the foot in this case?

to man. It is estimated that about \$15,000,000 annually are derived from our oyster fisheries. There are several species of

clams and mussels that are used for food. Less frequently snails and squid are eaten.

Pearl buttons, knife handles, and other objects are made from the "mother-of-pearl" shells of mollusks. Pearls, one of the most prized ornaments, are produced by a number of species, notably fresh-water mussels and the marine pearl oyster.

Squid produce cuttle bone and sepia, and are used for codfish bait.

The oyster industry and the clam-shell industry have become so extensive that they have ceased to be merely "fisheries." Promiscuous fishing, if profitable, always results in threatening the whole industry. The next step is to limit fishing or devise means of encouraging the growth of the organisms, or both. This has been done for the oyster and is beginning for the clam. The steps involved are to favor the young by artificial means, to give them suitable places to settle, to furnish them with food, and to protect them from enemies and unfavorable environment. This is a form of "farming," rather than fishing. Coupled with legal limitations upon fishing such measures make for steadiness of supply, and should be encouraged in every way possible.

302. **Classification.**—The following are the principal classes:

*Class I. Pelecypoda (hatchet-footed) or Lamellibranchiata;* (Mussels, Oysters, etc.).—Lamellibranchs are mollusks in which the fundamental bilateral sym-

FIG. 117.



FIG. 117. *Ensis americanus*, the razor clam. From Verrill, after Gould.

**Questions on the figure.**—Where is the hinge, the umbo, etc.? Trace the lines of growth and compare with other figures of bivalves.

metry is shown in the right and left valves of the shell secreted by a bilobed mantle, and in some of the internal organs. There may be one or two adductor muscles. The head is undeveloped. The ventral body region is differentiated into a muscular foot, shaped like a plow-share. The gills are in sheets (see §291) usually two on either side, and are suspended in the mantle cavity. Paired labial palps occur about the otherwise unspecialized mouth. The three pairs of ganglia—the cerebro-pleural, the pedal, and the visceral,—are usually well sepa-

rated. The heart consists of two auricles and one ventricle surrounded by a pericardial space, which is a portion of the body cavity and communicates with the exterior by a pair of nephridial tubes. The reproductive organs are simple; the sexes are ordinarily separate. Development by a metamorphosis.

[The primary subdivisions of the group may be made on the basis either of the gill structure, the adductor muscles, or the presence or absence of the siphon.]

Order 1. *Isomya*: Two adductor muscles which are essentially equal.

(a) Siphon well developed, retractile; pallial line (Fig. 109) with a sinus. Here occurs *Mya arenaria*, the common clam of the Atlantic coast. Great heaps of shells of this clam show that it was much used by the Indian tribes as food. In New England the clam fisheries are of very considerable importance. *Mya* burrows in the mud, using its long siphon to keep it in connection with the water from which it gets its food. Of somewhat similar habits is the razor-shell clam

FIG. 118.

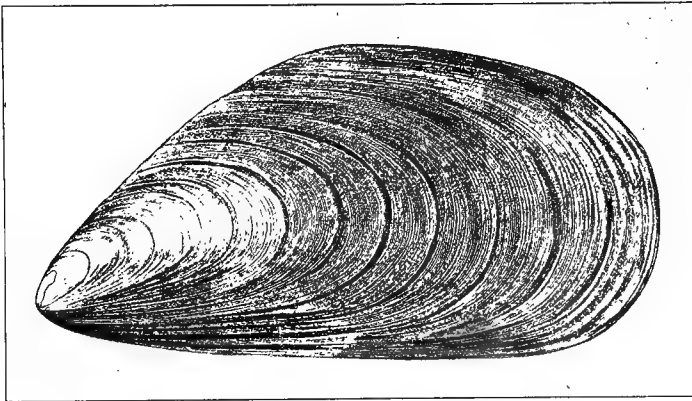


FIG. 118. *Mytilus edulis*, a Mussel. From Binney's Gould.

**Questions on the figure.**—Identify the umbo. What are your evidences that it is the umbo? Compare the lines on the shell with those in Fig. 117. What is the significance of the specific name (*edulis*)? What are the habits of the species?

(Fig. 117). The "borer" (*Pholas*) and the "ship-worm" (*Teredo*) belong to this group and possess the power of boring into wood or stone and are thus of much damage to submerged structures in waters where they abound.

(b) Siphon usually present but not highly developed; no pallial sinus. In this group are embraced the more abundant fresh-water mussels (*Unio*, *Anodonta*, *Cyclas*), and the cockles (*Cardium*) of the ocean. The Unionidæ are very widely distributed and very common in our own fresh waters. They are not much used for food at present, though the Indians used them, probably in times of scarcity of other food. Their shells are widely employed in the making of buttons, knife handles and the like, and pearls of value are not of infrequent occurrence. These are merely the mother-of-pearl, which ordinarily lines the shell, secreted about some infected or irritated point on the epidermis of the mantle. Considerable

quantities of these pearls have occasionally been found in the graves of the mound builders.

In some of the fresh-water clams there is an interesting temporary parasitism during the early development. When the young, called *glochidia*, escape from the gills of the mother, they must become attached to the fins or gills of a fish. They may become deeply imbedded and be nourished in the tissues of the host for several weeks. During this time they pass through their metamorphosis and develop the adult organs. This habit brings about a better distribution of the clams than would otherwise happen, since it has been shown that adult clams do not voluntarily migrate widely.

FIG. 119.

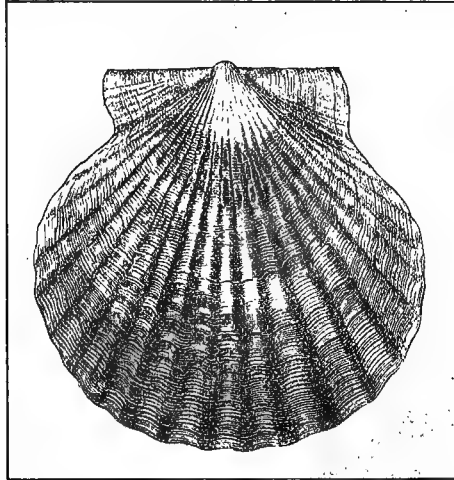


FIG. 119. *Pecten irradians*,—a Scallop. From Binney's Gould.

**Questions on the figure.**—Is this an external or internal view of the shell? Where is the umbo? What is peculiar about the hinge in this case? What is the significance of the lines nearly concentric with the margin? Of the radial lines?

**Order 2. Heteromya:** Two adductor muscles, the anterior much reduced; siphon usually wanting. Here are included the horse-mussel (*Modiola*) and *Mytilus*, edible mussels which occur in clusters just below low tide mark; also the pearl-oyster, from which the best pearls are taken. The last mentioned form is not found on our own coasts.

**Order 3. Monomya:** One adductor muscle (posterior); no siphon. The genus *Ostrea* (oyster) and the genus *Pecten* (scallop) are the most interesting and important representatives of this order. The species of *Ostrea* differ much in size in different regions. The largest living species is a Japanese form which is known to reach a length of two to three feet. The oyster is hermaphrodite. The young after a short free life, become attached by one of the valves. The oyster constitutes a larger element in the food supply of man than any other invertebrate. The scallops are not attached, and swim by a rapid opening and closing of their valves.

*Class II. Gasteropoda (belly-footed; Snails, Slugs, Whelks, and Periwinkles).*—Gasteropods are mollusks with unsymmetrical, univalved, usually spiral shells (occasionally lacking the shell altogether). The head and foot ordinarily preserve the bilateral symmetry, but the other organs lose their symmetry both from the spiral form of the shell and from a twisting which many of the forms undergo by which the nervous system and certain other visceral organs lose their original right and left relations. The head region is well developed, having tentacles, eyes, and a mouth with a tooth-bearing radula. Gills in the mantle cavity two, one, or none; in the air-breathing forms there may be merely a pulmonary sac. The sexes are separate (*Streptoneura*) or united in one individual (land snails). Development is mostly indirect.

FIG. 120.

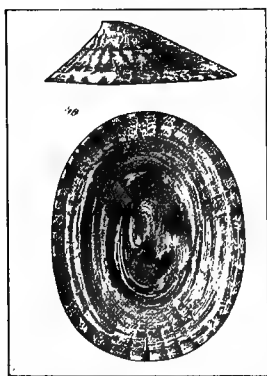
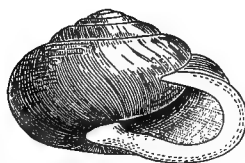


FIG. 120. *Acmaea testudinalis* (Limpet), from Binney's Gould. Upper figure lateral view; lower figure, dorsal view.

**Questions on the figure.**—How do the Limpets differ from the majority of the snails? What is the appropriateness of the specific name (*testudinalis*)?

FIG. 121. *Helix albolabris*, a pulmonate Gasteropod. From Binney's Gould.

FIG. 121.



**Questions on the figure.**—What is the significance of *Helix*? Of *albolabris*? Identify the parts of the shell. Is it a right or left spiral? What do you mean by your answer?

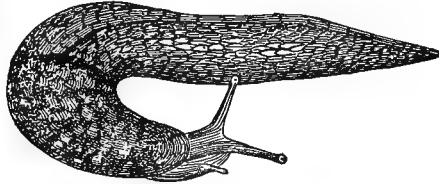
*Subclass I. Streptoneura.*—Gasteropods in which the nerve loop made by the visceral commissures, is twisted in development into the form of the figure 8; the other visceral organs are twisted so that right and left are interchanged. Only one pair of tentacles on the head. Sexes separate. Gills usually in front of the heart.

One of the common representatives of this group is *Littorina*, the common periwinkle of the seashore. Many other types of almost infinite variety of form, size, and color inhabit the ocean, their shells often being washed ashore by the waves; such are the cowries, the whelks, the cone-shells, etc. Here belong the uncoiled *Limpet* and the slightly coiled *Crepidula* or boat-shell.

*Subclass II. Euthyneura* (Land Snails and many naked Mollusks).—Gastero-

pods in which the nerye loop is not twisted. The head usually bears two pairs of tentacles. The sexes are united in the same individual. The most important of these are the Pulmonata or air breathing Gasteropoda, some of which are terrestrial and others aquatic. Of the terrestrial snails the genus *Helix* (Fig. 121) is the most widely distributed. Its variability is such that between three and

FIG. 122.

FIG. 122. *Limax flavus*, a Slug. From Binney's Gould.

**Questions on the figure.**—How do the slugs differ from the other gasteropods? In what external respects do they appear similar to them? Compare all the figures of slugs you may be able to find.

FIG. 123.

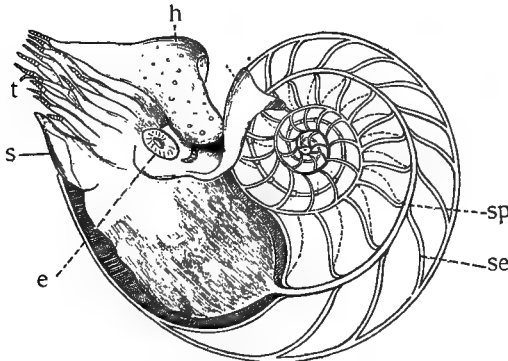


FIG. 123. *Pearly Nautilus*. From Nicholson. *e*, eye; *h*, hood, a muscular portion of the foot which protects the softer parts; *s*, siphon; *se*, septa, separating the successive chambers of the shell; *sp*, siphuncle; *t*, tentacles.

**Questions on the figure.**—How does this shell compare with those of the gasteropods? What is considered to be the homology of the tentacles or arms in cephalopods? What is the siphuncle? What is the character of the eye in *Nautilus*?

four thousand species have been described. *Limax* (Fig. 122) is a pulmonate form in which the shell is practically wanting. It is especially destructive to certain types of plants as it is a voracious vegetable feeder. The aquatic pulmonates are represented by the "pond-snail" (*Limnæa*), and by *Planorbis*, a snail whose coils are in one plane, presenting a helix rather than a spiral.

*Class III. Cephalopoda (head-footed; Squid, Devil-fish).*—The cephalopods are bilaterally symmetrical mollusks with a well-developed head in which the front part of the foot surrounds the well-armed mouth as a series of lobes or tentacles. The head protrudes permanently from the mantle cavity, leaving the mantle surrounding the posterior part of the body. The posterior lobe of the foot forms a siphon, communicating with the mantle cavity. Into this cavity the nephridia, the anus, and the reproductive glands open, and in it the gills lie. The shell may be present and external (*Nautilus*), internal and slightly developed (*Squid*), or wanting (*Octopus*). An internal cartilaginous skeleton protects the brain. The coelom is well developed. The ganglia of the nervous system are massed in the head region. The sexes are separate and the development direct. The Cephalopoda are to be looked upon as the most highly developed of the Mollusca. They are little in evidence now, however, as compared with earlier times.

FIG. 124.

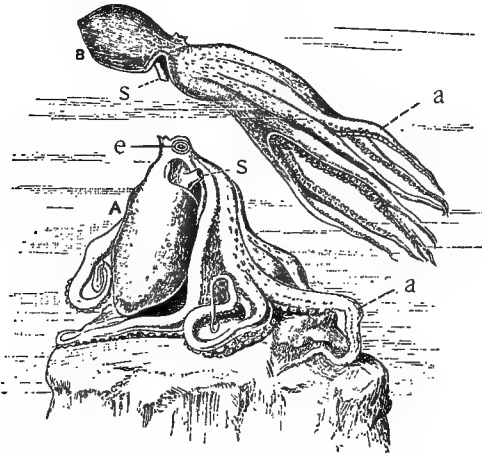


FIG. 124. The Devil-fish (*Octopus*). From Cooke, after Mercuriano. A, at rest; B, swimming, a, arms, with suckers on the inner aspect; e, eye; s, siphon or funnel.

**Questions on the figure.**—Which is the anterior end of the animal? What is the position of the mouth? What is the function of the siphon? Of what structure is it a part?

*Subclass I. Tetrabranchiata.*—Cephalopoda in which the front segment of the foot is divided into lobes bearing numerous tentacles, without suckers. Shells external and chambered (and in *Nautilus*, the only living genus, coiled). Two pairs of auricles; two pairs of gills; two pairs of nephridia.

This group is important for its extinct rather than for its living representatives. The pearly or chambered nautilus (Fig. 123) found in the Pacific and Indian Oceans, is the only important living species. The *Nautilus* appears to be the only remaining representative of the once numerous coiled forms and more remotely still of the Orthoceratites, the rulers of the Palæozoic seas (see Geology).

*Subclass II. Dibranchiata.*—Cephalopods in which a circlet of 8 to 10 arms surround the mouth. These bear sucking discs. Shell internal and rudimentary

or absent. One pair of gills, one pair of nephridia, and one pair of auricles. An ink gland is present.

Order 1, Decapoda, embraces the cuttle-fish and squid.

Order 2, Octopoda, embraces the devil-fishes (Fig. 124) and the paper nautilus (Fig. 125).

FIG. 125.

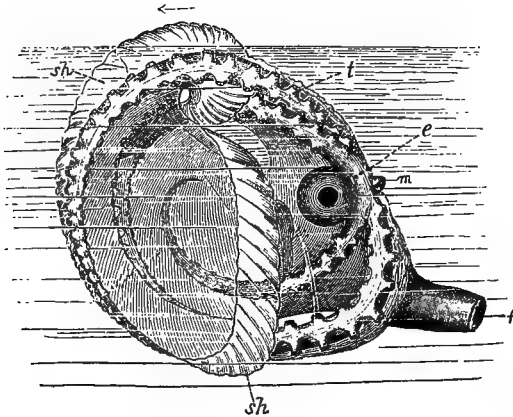


FIG. 125. The Paper Nautilus (*Argonauta argo*). From Cooke, after Lacaze-Duthiers. *e*, eye; *m*, mouth; *f*, siphon; *sh*, shell; *t*, tentacles.

**Questions on the figure.**—In what way does the siphon serve in locomotion? In which direction will the animal move by means of the siphon? How does the shell of *Argonauta* differ from that of *Nautilus*?

### 303. Supplementary Studies for Library, Laboratory, and Field.

1. Compare the clam, snail, and squid with regard to the following particulars, putting the results in a tabular form:

- (a) Degree of development of the head.
- (b) Shell, development and method of using, in each.
- (c) Mantle; extent, form and modifications: mantle cavity.
- (d) Foot; parts, differentiation, and uses.
- (e) Respiration; how accomplished?
- (f) Sense organs; position, character, and degree of development.

(g) Locomotion; how effected?

(h) Protection; special devices.

2. Can you find any indication among the mollusks of a relation between the degree of development of the sense organs



and the activity shown by the animals? Between the external protective structures and activity?

3. When did the various classes of mollusks make their appearance in the history of the earth? (See geology.) What can you say of their importance in the formation of the sedimentary rock? Evidences?

4. In what ways may the fresh-water forms have arisen from the original salt-water mollusks?

5. What members of the group of mollusks are economically important? Indicate in what way and to what extent?

6. A report on all the mollusks to be found in your community; their distribution, habits, etc.

7. Formation of pearls, and pearl fisheries.

8. The industries connected with the use of the shells of the clam.

9. The life history of the fresh-water clam.

10. The life history of the oyster.

## CHAPTER XVII

### PHYLUM ARTHROPODA

304. This group is one especially favorable for study in the field, in the haunts of the animals themselves. For this reason, wherever it is at all possible, the members of the class should collect a portion of the material needed in the laboratory and submit a report on such items of physiology and ecology as may be expedient in each case. Detailed suggestions will be found in the supplementary exercises.

305. **The Fresh-water Crayfish (*Cambarus*) or the Lobster.**— This form should be studied when living specimens may be had. They may be kept for considerable time in a tub containing an inch of water. This should be changed every day or two. Feed on small pieces of meat or earthworms.

#### I. *Physiology.*

1. Locomotion: walking; how effected? swimming: how effected? Under what circumstances does the animal swim? Do all the walking legs act together in walking? How many are at rest at once? In what order do they act?

2. Movements of the parts of the body; segments and appendages. Describe the manner and purpose of these motions as far as you can determine. In what different ways do the various groups of appendages seem to act? Watch them, one pair at a time.

3. Feeding: kind of food used and manner of securing it.

4. Respiration: by means of air or water? How can you be sure? Does the animal do anything to renew the water, by producing currents? Place a minute amount of carmine or indigo solution at the side of the animal at the union of the abdomen and thorax; at the front of the thorax. What is the difference? What does it signify?

5. Evidences of sensitiveness: Devise experiments of your own to prove whether the crayfish is stimulated by light; contacts; the presence of food in any other way than by sight;

sound. Are all parts of the body equally sensitive to touch? To chemical stimuli? Make use of a 5 per cent. solution of acetic acid; strong salt solution; strong beef extract. What inferences may be drawn from your experiments? Place a crayfish on his back. Describe his actions. What is the nature of the stimulus that arouses this reaction? Evidences?

II. *Symmetry*.—(This group is especially favorable for this study.)

Notice what is implied in bilateral or tri-axial symmetry.

Antero-posterior axis: are the poles alike or different?

Make a memorandum of all the chief differences.

Dorso-ventral axis (as above).

Right-left axis. Record the points of agreement.

Contrast the axes in length. Can you think of any *causes* for the differences and likenesses discovered above?

Any *advantages* arising therefrom?

III. *General Form*.—Distinguish two regions;—Cephalo-thorax and abdomen.

Cephalo-thorax; carapace.

Head; rostrum, eyes, mouth.

Cervical groove.

Thorax.

Abdomen; how many segments do you find? What seems to determine a segment?

Applying these criteria can you find any indications of segmentation in the cephalo-thorax? (Make a temporary estimate of the number of segments in the animal.)

Make two sketches showing a dorsal and a ventral view of the crayfish, preserving proportions.

Examine one of the *abdominal* segments (the third or fourth from the front). How is it joined to those next it? Follow the line of union. Note tergum, or dorsal piece; sternum, or ventral piece; pleura, the lateral projections from the tergum.

Make a sketch of an imaginary cross section showing the relation of these parts to each other, together with the attachment of the appendages.

IV. *Appendages*.—Group them into regions and notice the general differences and the differences in the uses to which they are put. If time will allow, study the appendages in detail as follows;

1. Begin with the third or fourth abdominal appendage (*swimmerets*) making the drawings necessary to show the parts:

Protopodite, or basal portion.

Exopodite, or external branch.

Endopodite or internal (median) branch.

Compare all the abdominal segments with that studied. Do different individuals agree in the appearance of the first and second abdominal segments? Compare the last segment (telson) with those studied. How many segments in the abdomen? Of what parts is the tail fin made up?

2. *Cephalo-thoracic Appendages*.—Remove with scissors the over-arching portion of the carapace and expose the base of the appendages. Find the third maxilliped (the first appendage in front of the large claw). Remove by inserting a scalpel and bringing away all that belongs to it.

Identify:

Protopodite, of two segments (coxopodite, next the body, and basipodite).

Endopodite and exopodite. How many pieces in each?

Epipodite, lying in the gill-chamber. Are there any special outgrowths on it?

Study and compare with this the large claw, and the other walking appendages. Which part is wanting in these, exopodite or endopodite? Reasons for your view? How do these five appendages differ from each other.

Examine and compare the appendages in front of the third maxilliped in order:

Second maxilliped.

First maxilliped.

Second maxilla.

First maxilla.

Mandible.

Antenna.

Antennule.

} Head parts.

What are the evidences that the antennæ and antennules are homologous with those already described?

Revise your estimate of the number of segments.

Compare the appendages again by groups, and notice the chief points of difference, and the ends served by these differences. Make a careful sketch of each type of appendage, labeling all parts. (The *names* of the segments of the larger appendages may be found in fuller texts, if desired.)

By studying the living specimen, determine just the work done by each of the types of appendages.

Note the position of the eyes. Examine with a low power.

In the basal joint of each antenna is the opening of the "green gland."

In the basal joint of the antennules are the otocysts (statocysts).

V. *Gills*.—Examine the gill-chamber, and the position of the gills therein. Which appendages bear gills? How many tufts to each appendage? How do they differ as to the place of their attachment? How many in all? Make a table showing these factors.

VI. *Internal Organs*.—Remove with much care the carapace from the thorax and the terga from the abdominal segments, by the use of scissors and forceps. Sketch the organs in their natural position. What organs are visible?

Examine in some detail the following sets of organs.

(a) The circulatory organs. (Use an injected specimen.)

Heart: just beneath the carapace, in a membranous chamber (pericardial sinus).

Apertures, by which the blood enters the heart from the sinus; dorsal, ventral, lateral. How many do you find?

Arteries; anterior, posterior.

(There should be, if possible, a permanent dissection of the lobster in which the arterial circulation has been injected with a colored mass.)

VII. *Reproductive Organs*.—These will be found immediately beneath the pericardial sac as whitish (male), or yellowish to brown (female) lobed structures.

Depending on the sex there will be found

Ovaries or testes. Form, position, and number of lobes?

Oviducts or vasa deferentia. Course, length and outlets?

Can you determine the sex of your specimen? Note especially the external differences between males and females.

VIII. *Digestive Organs*.

Liver, a pair of yellow, brown or reddish masses anterior to the reproductive organs.

Stomach; sketch in position. Dissect later, if time allows, and note the anterior and posterior chambers, and the grinding apparatus.

How is the mouth situated relatively to the stomach?

Follow the intestine backward from the stomach to the

Anus: position of?

Make a sketch of the entire tract from a side view, showing in what part of the carapace each portion is.

IX. *Muscular System*.—How is the abdomen flexed and how extended? How do the muscle fibres run? To what attached? Are they plain or striate? How are the appendages worked? Split open the segments of the cnela.

X. *Nervous System*.—(If the time is short a demonstration may be made, preferably with a lobster.)

Remove the intestine, and cut carefully through the muscles in the median line until the white ventral nerve-chain is uncovered. Follow it forward to the head, cutting away the covering plates in the thorax.

How many swellings (ganglia) in the abdominal region? Relation to the segments? Where do nerves arise?

Thoracic ganglia: number and relation to appendages?

Sub-esophageal ganglion; circum-esophageal connective.

Supra-esophageal ganglion (brain).

Do any nerves arise from the brain? Where distributed? Draw from above.

Make a diagram of the relation of the digestive tract and nervous system from the side view.

XI. *Excretory Organs*.—The green glands occur at the base of the head, in front of the mouth. The outlets are at the base of the antennæ.

Make a diagrammatic view of an imaginary cross section of the thorax in the region of the heart, and one of the abdomen, showing the position of the internal organs. Also a diagram of a sagittal section showing relations of all the parts discovered.

306. Sow-bug (*Oniscus*, a terrestrial form; or *A sellus*, a fresh-water Isopod).—

*General Form*.—Use hand lens and identify:

Head: size, form, number of segments.

Eyes: number and position.

Antennules and antennæ.

Mouth-parts: number and structure.

Thorax: number of segments. What variation therein?

Abdomen. How many segments? Proofs?

*Appendages*.

Remove carefully, mount in water on a slide, and examine with low power, a thoracic appendage. Sketch.

Examine similarly the other thoracic legs and the mouth parts, and make drawings of them arranged in the order of their occurrence.

Examine similarly the abdominal appendages. What is their number? Sketch?

Compare the appendages from the different regions, as to structure, form and probable function. Are there any gills? Where situated?

What is the number of segments in the body, if there is a pair of appendages to each segment?

*Comparisons*.—Compare the sow-bug with the crayfish as to the degree of union of head and thorax; the number of segments represented in each of the three regions; the degree of differentiation among the appendages; the mode of respiration; the presence of both exopodite and endopodite; as to food, and habits.

*Physiology and Ecology*.—A study and report of the animal's habitat, food habits, methods of motion, sensitiveness to light and to other classes of stimuli, should be made. How does *Oniscus* behave when touched? Do you find any trace of eggs or young? What facts are to be noted concerning them?

307. Cyclops.—These minute fresh-water Crustacea may be found in almost any pool where aquatic plants are found. They flourish well in aquaria. Select several of the larger specimens with egg masses, one on each side the abdomen. Examine in a watch glass with a little water to which a drop of chloroform has been added. Use low power of microscope.

*General Form*.—(Study both dorsal and ventral surface.)

Cephalo-thorax:

Anterior portion covered with the carapace. How many segments represented? How can we know that this is not merely the head, or the whole cephalo-thorax?

Posterior portion (four free thoracic segments). How is it known that these are not abdominal segments?

Abdomen: form; number and character of the segments.

*Appendages*.—Antennæ, oral, thoracic, abdominal. Number and general character of each. Where and how are the egg-cases attached?

*Sense Organs.*

Eye-spot (appearing as *one*, from which the name *Cyclops*).

Do you find any organs which suggest a tactile function?

Report on all available points of physiology: as food habits; methods of locomotion; reaction to light and other stimuli.

308. *Comparisons*.—Collect all the minute fresh-water Crustacea possible and compare them with *Cyclops*. Learn to identify them by their manner of moving in the vessels of water. *Daphnia* is especially favorable for microscopic study on account of its semi-transparency.

309. **Spider** (any common species large enough for study).

*General Form*.—Study the relations of head, thorax, and abdomen. Are there any antennæ? Oral appendages? Number and character of the thoracic appendages? Does the abdomen show any signs of segmentation? Has it any appendages? Make sketches showing a ventral and a lateral view.

*Special Organs.*

Examine the head with a hand lens and locate the eyes.

Note more particularly the types of appendage found, and the degree of differentiation. Find the openings to the air-sacs on the ventral surface of the abdomen.

Locate the spinning glands. Number?

*Activities and Habits*.—How do the legs act in walking? At what joints are they flexed at various parts of the step? Do all the legs on one side act in unison? Observe the spinning action. Does the spider ever produce the threads except when weaving a web? Describe. Determine if possible the kind of web formed by the species studied. Or find as many types of nest or web as possible and learn to recognize the spiders producing them. How does the spider travel on its web? Where do spiders place their webs? Place a living fly or other insect in a newly constructed web and record the actions of the spider. Can you devise means to prove whether the spider possesses the sense of smell?

310. **The Grasshopper**.—Several species of the locusts may be found in almost every locality. They are especially abundant in the early autumn. For laboratory study select the largest species found in sufficient abundance. In connection with the

securing of material the students should make observations on the following points:

1. *Habits*.—Where and under what circumstances found? At what time of the year does this species occur in greatest abundance? Under what circumstances are they most active?

2. *Methods of Locomotion*.—How many methods seem available? Degree of efficiency of each? Under what circumstances is each used? What distance can be attained at one effort? Continue the study later in more limited quarters, as in the room and under a bell-glass. Compare the work of the various legs. Are the wings used at all in jumping?

3. *Protective Features*.—Coloring; to what extent do you find this of protective value? Reasons for thinking so? Does the animal show a distinct instinct for hiding? Compare all available species in these regards.

4. Do they produce definite sounds? Under what circumstances? Do you find any hint as to the method of their production?

5. Do you detect any movements which suggest *respiration*? Rate? (Find spiracles in the thorax and abdomen.)

6. Supply hungry animals with fresh leaves and study the feeding process. Dip the leaves in various solutions and notice whether it makes any difference to the grasshopper.

If alcoholic material is used for the following morphological studies it should not be allowed to become dry. If dipped in a mixture of glycerine and 50 per cent. alcohol, specimens will not dry so rapidly.

The sexes differ, particularly in the abdominal region. Procure specimens thus differing by examining a number of individuals, and keep both kinds for comparison. Sketch dorsal, lateral and ventral views of each (especially in the regions of difference).

*External Features*.—Study the following points:

1. The regions of the body.

Head; thorax; abdomen.

What are the signs of segmentation in these three regions?

Where is it most clearly indicated? Where are the segments most similar?



## 2. Abdomen.

Number of segments (differs in male and female).

Dorsal and ventral plates. Are they equally developed in all segments.

Appendages: which segments possess them?

*Ovipositors* (paired outgrowths found only in the female).

*Anal cerci* (examine the male). Are they found in the female? To what segments do these appendages belong?

*Spiracles* (small openings at the side of the segments); number and distribution?

*Tympanic membrane*, at the sides of the first abdominal segment.

## 3. Thorax: studying from the front; backward, find:

Prothorax; mesothorax; metathorax. Note the form, size, and structure of each part.

Appendages of each segment.

Legs: number; relative size; parts (beginning at the body), coxa, trochanter, femur, tibia, tarsus. Compare the legs.

Wings (can these be regarded as homologous with the jointed appendages?): number; position, at rest and in motion; characteristics; position of veins.

Compare the two pairs in all essential particulars.

Are there any spiracles in the thorax? Position?

## 4. Head (is there any "neck"?). The head is covered with chitinous plates; identify:

Epicranium, the dorsal plate.

Clypeus, the anterior plate.

Genæ, the lateral plates.

Labrum or upper lip, anterior to the clypeus.

Examine the compound eyes, their form and relation to the plates. Slice off a portion of the surface and study the surface with a low-power objective.

Ocelli or simple eyes. How many and in what position?

Mouth aperture; position.

Appendages of the head:

Antennæ, near the eyes; number.

**Mouth-parts.** These are complicated and demand careful study. Remove the labrum and proceed from before, backward.

*Mandibles*; a pair of horny tooth-bearing jaws. Draw in position.

*Maxillæ*; a pair of compound jointed organs made up of three portions, the *lacinia* (nearest the median line), the *galea*, and the *maxillary palpus* (external).

*Labium* or lower lip; this also bears a *palpus*. The labium may be studied and removed before the study of the maxillæ.

Tongue.

How many segments seem to be represented in the head? Evidences.

*Internal structure.*

Select large female specimens preferably. Clip the wings close to the body, and pin the specimen to a board, dorsal surface upward.

With a pair of fine, sharp pointed scissors make a longitudinal incision into the integument of the abdomen near each side. Gradually and carefully remove the skin between the cuts from behind forward. Look for the heart,—a long, thin-walled, mid-dorsal vessel, which if not removed with the skin may be seen just beneath it. Unroof both the abdomen and thorax. Note the exposed muscles of the thorax, also the whitish fat bodies next the body wall.

1. *Tracheæ*.—If the specimen is freshly killed the tracheæ will be filled with air and will show as white, glistening tubes. Seek their connection with the spiracles, and note their ramification and unions in the body. Isolate some of the smaller branches and study under the microscope. Prove that they are tubes. How kept open?
2. *Reproductive Organs*.—(These are much more difficult in the male.)

Ovaries: In how many masses? Notice the subdivisions of the ovaries.

These contain the eggs and communicate by means of an *oviduct* with the outside. In what segment? Examine an ovum with the microscope. Mash, and notice the yolk.

3. How do the muscles of the thoracic region differ from those in the abdominal? Are the fibres plain or striate?
4. *Digestive Tube*.

Dissect forward into the head, and press the other organs aside so that the course of the tract may be revealed. It consists of the following parts, which should be identified:

Mouth.

Esophagus; size and course.

Crop (an enlargement of the esophagus); shape, position.

Stomach; character and extent. (At the anterior end is a ring of tubular appendages which are glandular in function,—the gastric cæca; at the posterior end it is limited by a circle of fine tubes—Malpighian tubules—which are excretory.)

Intestine; length, course and size.

Anal opening; position.

Make drawing of digestive tract from side view, showing in outline the body regions and the relation of the portions of the tract to these.

5. *Nervous System*.—(Remove the alimentary tube and examine the floor of the abdominal cavity.)

Ventral nerve cord. Is it single or double?

Ganglia; number, and relation to the segments.

Nerves; origin and distribution.

Trace forward into the thorax and head.

Ganglia; number and position. How connected? Is there any portion dorsal to the digestive tract (brain)?

Nerves.

Compare the nervous system of the grasshopper part by part with that of the crayfish.

Make diagrammatic representations of imaginary cross sections through thorax and abdomen showing the relation of the different structures; likewise of a sagittal section.

The cricket or cockroach may be substituted for or compared with the grasshopper.

**311. Supplementary Laboratory and Field Work.**—It is perhaps inexpedient for students in an elementary course to make dissections of other representatives of the Arthropoda, but the common air-breathing forms are so numerous, so varied, and have such interesting habits and histories, that they may profitably be used as a basis for individual field and laboratory and library work and to serve in the comparison of homologous organs in related groups. The following outlines are suggestive rather than exhaustive.

I. Make a table in which can be displayed the points of contrast between the crayfish, the grasshopper, the "June bug" (or other beetle), the squash-bug or the cicada ("locust"), the butterfly, the wasp, the fly, the spider, and the centipede, in the following particulars:

1. The regions of the body; head, thorax, and abdomen; their degree of development and separateness.
2. The number of segments in the body, and the clearness with which they are manifest.
3. The degree of diversity shown by the segments in the various parts of the body.
4. The points of structure which the various segments possess in common.

II. Make a similar table, for the same animals, of the appendages:

1. Head appendages: antennæ; mouth parts, number and kinds.

## 2. Thoracic appendages:

Legs: number, position, kinds, joints, special adaptations to special work.

Wings: number, size, position, structure, principal veins.

Compare the first and second pairs as to size, structure and function.

## 3. Abdominal appendages: number, structure, function.

III. Make a table comparing these and other available forms as to their eyes, simple and compound.

IV. Find, if possible, another form embodying the same general features found in each of the above-mentioned animals.

V. Compare these (or other forms which may be selected) from the point of view of their habits. Introduce all discovered correlation between structure and function and between form and manner of living.

1. Haunts and place of living. If peculiarly local, can you find any reasons?

2. Locomotion: methods, and the efficiency of.

3. Feeding: material used, and the method of obtaining it.

4. Respiration: organs and their location; any special points as to their use.

5. Special senses: physiological evidences; morphological evidences.

6. The laying of eggs and provision for the young.

(The library may be used profitably to supplement field work in this section.)

VI. Study by observation the homes, temporary or permanent, their mode of construction and uses, in the following: Spiders (as many species as possible), the paper-wasp, the mud-wasp, the honey-bee, the bumble-bee, ants, flies, etc.

VII. Development or life history. Studies may be made in many cases by periodic observations in natural conditions. When this is not possible, animals may often be reared in confinement by supplying the appropriate conditions. This is a very attractive line of investigation and one in which real contributions to knowledge may be made. The following are some of the matters to be kept in mind.

1. Is there a metamorphosis or is development direct? (See text, §330.)
2. Eggs: where deposited? In what numbers? Relation to future food supply?
3. Larval condition ("grub," "maggot," "caterpillar"). Form, segmentation, general external characters, special organs; habits, food, coloration, enemies.
4. Pupa (a resting and transforming stage); how protected? What is the origin and character of the protecting structure? What changes are undergone at this stage?
5. Adult. How do the larva and pupa compare with it in segments, appendages, etc.

The following forms may be studied and compared as to life history:

Squash-bug; all stages are to be found on squash, gourd, cucumber and similar vines.

Potato beetle; equally abundant on the Irish potato plant in some years.

Bees and wasps; to be found in their nests.

"Blue-bottle" fly. This form may be studied in confinement. (Expose raw meat for the eggs to be laid. Place on a chip in a dish of moist earth or sand. Invert a tumbler or bell-jar over it and watch the growth and changes, as decomposition proceeds.)

Mosquito. The larvæ may be found in stagnant pools, and watched in confinement.

Cabbage butterfly. This form may be studied in the garden, or in the laboratory by placing the cabbage leaves with the larvæ under a bell-jar and keeping the conditions favorable.

Some large caterpillar should be studied with some degree of care in order to ascertain the general arrangement of organs.

Spider. If a mass of spiders' eggs can be found, the student by watching may be able to determine whether the development is direct or indirect.

Silk-worm. The various stages may be studied in confinement.

VIII. Group the Arthropoda known to you, in three classes: (1) those hurtful to man's interests, (2) those beneficial thereto, and (3) those having no apparent relation to man. State the grounds of your classification of each form. In what stage of its metamorphosis is each species hurtful or helpful. Extend your own knowledge by inquiry, by observation, and by reading.

### DESCRIPTIVE TEXT

312. **The group of Arthropoda** (jointed-legs) embraces more than one-half the species in the whole animal kingdom, and is correspondingly rich in individuals. This is the same assaying that they are remarkably variable and adaptable to various conditions of life. The segmented, bilaterally symmetrical body and the arrangement of the nervous system are the most important points of similarity with the Annulata. The general resemblance is more striking in some of the lower forms (*Peripatus*), and in the larval stages of those which undergo a metamorphosis.

#### 313. **General Characters.**

1. Elongated, bilaterally symmetrical body.
2. Segmented; somites usually heteronomous, and typically grouped into three regions: (1) head, (2) thorax, (3) abdomen.
3. An outer skeleton, of a secreted chitinous substance.
4. Each somite typically with a pair of jointed appendages (whence the name *arthropod*).
5. Central nervous system similar to that of Annulata: (1) brain, (2) a nerve ring around the esophagus connecting the brain with (3) a ventral, ladder-like chain of ganglia.
6. Heart, dorsal to the digestive tract.
7. Cœlom greatly reduced and not forming a part of the rather spacious secondary body cavity (hæmocœle).

314. **General Survey.**—The symmetry of the Arthropods is very pronounced, except in the case of fixed, parasitic, or otherwise degenerate forms (as barnacles, *Sacculina*, etc.).

The group presents great diversities expressive of a high degree of adaptation to almost every conceivable mode of life. They may be parasitic—internal or external, symbiotic, social, or independent; they may be aquatic, terrestrial, burrowing or aerial; they use all sorts of food; they bore, crawl, swim, jump, fly, or may be fixed. In geographical distribution they are practically cosmopolitan. The group is one of the most successful in the animal series. None of the living species, however, attains a very great size. The king-crab and the lobster are among the largest. Many are microscopic.

315. **The Segments.**—There is a great deal of diversity among the segments of the body as to size, shape, the form and use of their appendages, as well as in their contained structures. In the more primitive forms (*Peripatus* and the centipedes) and in the larval condition, the somites are well marked externally, but in the majority of forms there is more or less fusion of contiguous somites in certain body regions. A variable number of segments at the anterior end, which bear the mouth parts and sense organs, form the head. Behind these a group of three (insects), or more (crayfish), may fuse to form the thorax. The head and thorax are often fused into one piece—the *cephalothorax*. The abdominal segments are usually unfused.

316. **The Appendages** also differ much in form in the various representatives and on different segments of the same individual. This diversity of structure is closely connected with the variety of work to be done, and is an excellent illustration of the differentiation which accompanies "division of labor." They are unquestionably serially homologous organs as is shown by their similarity of origin and by the fundamental likeness of structure,—clearly to be seen in the primitive forms. They may be said to consist typically of a basal portion with one or more segments, supporting two jointed branches,—a median and an external. Appendages may be entirely wanting (as in the abdominal segments of almost all adult insects); and yet these may appear in a rudimentary form in the early stages of the embryo, only to disappear later.

Where the metamerism is obscured by fusion, the number of appendages may be the only indication we have of the number of segments; but as we have seen, the appendages themselves are sometimes aborted in regions where they are no longer needed. So it is not always possible to determine how many segments are really represented in an animal.

General groups of appendages are as follows: (1) preoral, mostly sensory,—as antennæ; (2) oral, biting and sucking structures,—mandible and maxillæ; (3) thoracic, chiefly walking appendages; (4) abdominal, variously modified (as swimmerets, gills, etc.), or wanting. The wings are not to be regarded as homologous with the jointed appendages. They originate as expansions of the integument of the body, supported by numerous tubular “veins” containing blood spaces, tracheæ, and nerves. Wings, when present, comprise one (flies) or two pairs (bees). Often the anterior pair is hardened and serves merely as a protection for the second pair. Either pair, more often the second, may be aborted.

317. **Cœlom.**—The development of the arthropods shows that the spaces in the body are not truly cœlomic as a rule, but are, so to speak, much enlarged blood spaces containing the corpuscle-bearing fluid. The pericardial sinus is one of these. Such a body cavity is known as a *hæmocœle*.

318. **Integumentary Structures.**—The arthropod integument has a hypodermal layer of cells which secretes the chitinous cuticle constituting the external skeleton. The chitin may be mixed with salts of lime. Beneath the hypodermis, in certain groups, is a layer of connective tissue,—the dermis, containing nerves and blood vessels—within which are the longitudinal muscles of the body wall. In Insecta, Arachnida, and Myriapoda the body wall is composed of a cuticula, a hypodermis and a basement membrane. The chitinous covering serves for protection and support of the soft parts, and for the attachment of the muscles of locomotion. At intervals this exoskeleton is shed off (moulted), in which process the old cuticle is separated from the hypodermis, rupturing along some line of weakness, and allowing the escape of the animal. This moulting extends not only to the minutest of the external organs, but to the stomodæum and proctodæum and certain other internal structures



as well. A new cuticle begins to be secreted at once, but this "soft-shelled" condition is one of great danger and helplessness to the animal. The process besides is exhausting, and to these facts we may attribute, in part at least, the small size of most arthropods. Chitin is not deposited in the cuticula at the joints, thus securing the flexibility necessary in locomotion.

**319. Muscles and Locomotion.**—The muscles are well developed, and many of the arthropods are very powerful in proportion to their size. The circular muscles characteristic of the body wall of Annelida are lacking in the arthropods. The chief body muscles are the longitudinal which cause the flexion and extension of the segments. There are in addition the muscles by which the appendages are moved. These fibres are of the cross-striate type. Less massive groups of fibres are found in the walls of portions of the digestive tract.

The paired, segmented appendages are primarily organs of locomotion. They are variously used for crawling, walking, jumping, and swimming. Many have wings, and the quality of the nervous and muscular control of these can be realized from the fact that the honey bee can make some 326–435 wing strokes per second and the house fly 330 per second. Some forms, as the crayfish, have the power of using segmented portions of the body in a powerful backward swimming stroke. Some types have the power of skating round on the surface of water. Locomotion in the phylum is remarkably varied and efficient.

**320. Digestion and the Digestive Organs.**—The alimentary tube is typically rather complex. It commences with a mouth which is usually supplied with three or more pairs of external appendages assisting in the capture, transfer, and preparation of food. This is followed by an esophagus either with or without a crop; a stomach frequently consisting of several regions: viz. (a) a *proventriculus* or gizzard in which food is further broken to pieces physically, and (b) a *ventriculus* or stomach proper in which chemical digestion occurs; an intestine which is not always clearly marked off from the stomach; and a posterior opening,—the anus. The development of the gut shows both stomodæum and proctodæum (see §93). The former is often very extensive,—embracing even the proventriculus, in

which chitinous grinding plates may occur (crayfish, cockroach). The "salivary" glands when present open into the esophagus or mouth cavity. Into the mesenteron important digestive glands may open, as the pyloric cæca (many insects), or liver (crayfish and spiders). The *Malpighian tubules* (see dissection of the grasshopper) associated with the hind gut are believed to be excretory rather than digestive in function. The digestive system as a whole is strikingly correlated with the character of food used, which is exceedingly diversified in this phylum. This results in the fact that the details of structure are scarcely the same in any two species. Indeed the digestive process and structures are very different in the larval and adult stages of the same individual,—as in the caterpillar that feeds on green leaves and the adult that lives on nectar or fruit juices. This can be appreciated only by extended observation and comparison. The student is urged to compare such figures of these organs as he may be able to find in the reference texts at his command.

321. **Respiration.**—In some instances the Arthropoda obtain their oxygen directly from the air, in others from the water. In the latter the exchange is effected through the body wall, or by gills. These are essentially thin outgrowths of the body wall, with the cuticula much reduced, into which the blood passes (*e.g.*, the majority of Crustacea). In the former it takes place wholly by means of tubular air-passages or *tracheæ* (insects), or these may be supplemented by thinned folds of the body wall—*book-lungs* (spiders). By these devices the oxygen of the air or water and the blood are brought into intimate relations. In the water-breathing forms the gills are either the modified appendages (*Limulus*, *Asellus*), or specialized outgrowths from them or from the general body wall (crayfish; Fig. 126, *g*). The gills vary widely in number and position, but are found especially in connection with the thoracic and abdominal appendages. The air-breathing forms possess a system of interbranching tubes which may open to the exterior by a pair of *spiracles* (*stigmata*) or pores in each somite. These tubes unite, branch and penetrate to every portion of the body. The air is carried to the blood rather than the blood to the air

The tubes are lined by a thin layer of cuticle, and are kept open by a spiral thread of the same material reinforcing the wall. The book-lungs when present lie within a sac which opens to the exterior by a spiracle or pore, and consist of a series of pleat-ings, *within* which the blood circulates and *between* which the air circulates.

The larvæ, especially of air breathers, are often developed in conditions very different from those chosen by the adults.

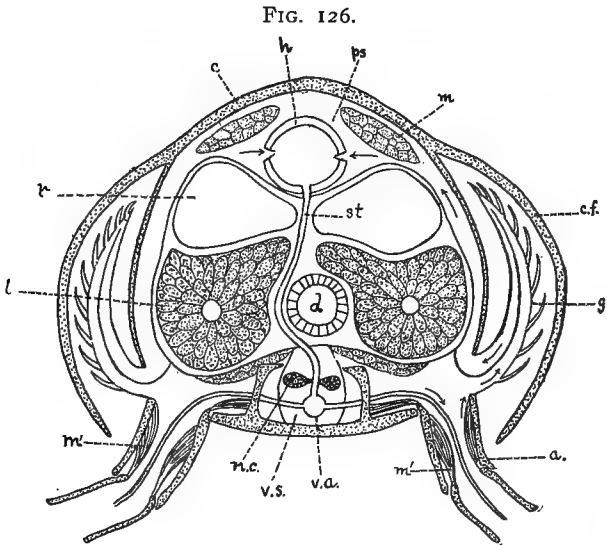


FIG. 126. Diagrammatic cross section of Crayfish in the thoracic region, to show relation of circulation and respiration. *a*, appendage; *c*, carapace; *c.f.*, flap of carapace overhanging the gills; *d*, digestive tube; *g*, gill; *h*, heart; *l*, liver; *m*, body muscles; *m'*, muscles of the appendages; *n.c.*, nerve cord; *p.s.*, pericardial sinus; *r*, reproductive glands; *st*, sternal artery; *v.a.*, ventral artery; *v.s.*, ventral blood sinus in which the nerve cord lies. Modified, from Lang.

**Questions on the figure.**—What is the relation of the gills to the body wall? Follow the course of the circulation by the arrows. It leaves the heart by definite arteries and comes back by less definite blood sinuses. What is the function of the valves? What gain is there in the position of the ventral nerve cord in the blood sinus?

This fact may make necessary very important changes in the respiratory organs in the metamorphosis. Some forms are even water breathers in the larval stage and air breathers in the adult (dragon-flies).

322. **Circulation.**—The heart or pulsating organ when present is dorsal and may be much elongated, with an enlargement in each somite. It lies in a membrane-bounded cavity called the *pericardial sinus* (Fig. 126, *ps.*), which is a part of the hæmocœle or secondary body cavity (§317). The blood comes to the pericardial cavity and enters the heart by means of slit-like openings, with valves. Definite arterial vessels leave the heart and pass to capillary regions and thereupon open into irregular spaces in the tissues without definite walls (*lacunæ*). The hæmocœle is in reality an enlarged lacuna. In insects there is an anterior artery only; in spiders and crustacea, posterior and lateral arteries also occur. The return of the blood takes place through the irregular hæmocœle spaces (*lacunæ*). These become more definite in form as they near the pericardial chamber, or as they approach the gills in aquatic forms. One of the more important blood spaces is the ventral, in which the nerve cord lies (Fig. 126, *v.s.*). The blood corpuscles are colorless and amoeboid. The plasma may be variously colored by pigments which seem to assist in the work of respiration, as hæmoglobin does in vertebrates.

323. **Excretion.**—The importance of excretion increases with the activity of animals. Except in *Peripatus* it is not conclusive that any of the adult excretory organs in this phylum are homologous with the segmental organs of Annelida. In insects and spiders there are excretory tubules communicating with the hind gut. In the crayfish and related forms a pair of excretory glands—“*green glands*”—open at the base of the antennæ. It is of importance to remember that the exoskeleton of the Arthropoda is an excretion, which is incidentally protective and supportive.

324. **The Nervous System** consists essentially of the same parts as have been described for the annelids. It is, however, on the whole, more fully developed. This development accords with the differentiation which we have seen in the somites and body regions. The brain and sub-esophageal ganglia, for example, have become more pronounced with the differentiation of the head; accompanying the fusion of the body seg-

ments there is a massing and fusion of the corresponding ganglia; and in general, everything considered, those ganglia are best developed which lie in the best-developed somites. The concentration of the ganglia of the ventral cord may continue until they form practically one mass. Nerves arise from the brain, from the connective about the gullet, and from the ventral ganglia, and pass to sensory organs and to the muscles of the body and the appendages.

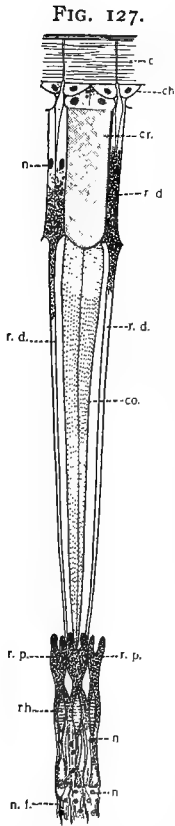
325. **Organs of Special Sense.**—As the thickened cuticular covering of the arthropods develops, it is apparent that much of the sensitiveness of the surface to external conditions must be lost unless special structures are produced to compensate for this by the reestablishment of connection between the internal organs and the outside world. Such structures we find in the chitinous hairs of various shapes which project beyond the surface and in pits or canals which pierce the skeleton. These all have nervous connections and have been variously interpreted as tactile, taste, auditory, and olfactory organs. They are especially abundant in the more movable portions, particularly those about the mouth, though they may be found over the whole surface of the body. Figures illustrating the great variety of forms of such hairs should be sought in the reference texts.

It has been shown that the crayfish and many insects are sensitive to chemical stimuli. These sensations have to do with selection of food and with testing the character of the water or air. They are analogous to our sensations of taste and smell. The organs may be scattered over the body or more commonly localized on the appendages about or in front of the mouth.

At least three classes of organs have been described as auditory among the arthropods: (*a*) vibratile hairs, as in the case of the male mosquito (Fig. 42); (*b*) otocysts, as in many aquatic forms; (*c*) a tympanum or membrane in connection with which are special nervous cells for the reception of the vibrations (as in the grasshopper and other insects). The otocysts of the Crustacea may be open or entirely closed. In the former case the animal itself may place the otoliths in the otocyst in the form

of grains of sand. Investigations, however, show that the function of this organ is not hearing, so much as that of informing the animal of its relation to the pull exerted by gravity, thus enabling it to keep its equilibrium.

There are two classes of eyes in the group: (a) *compound* eyes, made up of numerous similar elements, as in the insects and Crustacea, and (b) *simple* eyes—*ocelli*—found alone in spiders and in many larvæ, or in connection with the compound eyes, as in many insects.



The compound eye is made up of elements (*ommatidia*) radially arranged about the end of the optic nerve. Each ommatidium is probably capable of forming an image of a limited portion of the field, and consists of (1) a cuticular *cornea*, appearing externally as a "facet," (2) a cellular lens or cone which directs the rays of light, (3) sensory retinal cells which receive the light, and

FIG. 127. An ommatidium or eye-element from the eye of the *Lobster* (after G. H. Parker). *c*, cornea (cuticle); *c.h.*, corneal hypodermis, which secretes the cuticle; *co.*, cone cells; *cr.*, crystalline cone; *n.*, nuclei; *n.f.*, nerve fibres; *r.d.*, distal or outer retinula cells; *r.p.*, proximal or inner retinula cells; *rh.*, rhabdome.

**Questions on the figure.**—Identify the following regions: (1) protecting part including the cornea and hypodermal cells; (2) focusing portion,—the crystalline cone and the cone cells; (3) the pigmental elements of the retina (distal and proximal retinular cells), the former of which prevent rays of light entering one ommatidium from passing obliquely into adjacent ones; the proximal cells may be more immediately connected with (4) the nervous elements which unite the eye with the nerve centres. Define an ommatidium. Is it known whether the image is inverted in such an eye as this?

(4) pigment cells which separate the retinal elements of adjacent ommatidia, and play an important, though not fully understood, rôle in vision (see Figs. 44 and 127).

326. **Library Exercise.**—If time allows some student might make a more detailed report of the structure of the compound eye in Arthropods and its method of image formation. Other reports may be made, in which drawings of the various sense-organs in arthropods are presented to the class, especially the various types of auditory organs.

327. **Reproduction and the Reproductive Organs.**—Reproduction in arthropods is sexual. With few exceptions the sexes are permanently separate. There is often much difference in the size, color, structure, and activity of the two sexes. The males are often smaller, more active, and more highly colored than the females (see “sexual dimorphism,” §149). Sometimes the members of a single sex are dimorphic, as in the workers and queens among the bees. This is correlated with individual division of labor in the social insects.

The sexual organs are usually paired, and in the female consist of the *ovaries* (which may be subdivided into *ovarioles*), *oviducts*, *receptacula seminis*, in which spermatozoa are stored at copulation, accessory glands, sometimes external copulating and egg-depositing organs. The male has *testes*; *vasa deferentia*, which may have special enlargements for the storing of spermatozoa and the formation of sperm masses; and external copulatory organs. See figures of the sexual organs of the honey-bee or other representative insect in the reference texts. Compare them with those of the snail.

328. **Parthenogenesis.**—In several insect types the eggs have the power of developing without being fertilized by the male element. Its occurrence is determined primarily by the absence of males, but even when males are present the female may often deposit unfertilized eggs. She is influenced to do this possibly by the special conditions of temperature, nutrition, and the like, to which she is subject.

The individuals resulting from parthenogenesis may differ very materially from those produced by the normal sexual method. In the case of the bee, the males or drones come from unfertilized eggs, and the workers and queens from fertilized. The cause of the differences between workers and queens is apparently one of nutrition purely. Biologically, parthenogenesis is to be considered as a modified or abbreviated form of sexual reproduction, in which the stimulus to cleavage comes from some source other than the male cell.

329. **Development.**—After fertilization the nucleus divides as described for other forms, but usually, on account of the

abundant yolk which the eggs contain, complete segmentation of the cell is not effected. After a series of divisions some of the free nuclei assume a superficial position where they become surrounded by protoplasm, and form the *blastoderm* (Fig. 13, D, 3). This is described as *partial* and *peripheral* segmentation. On the side of the egg where the embryo is to lie, a thickening called the *ventral plate* is formed. From this area of the blastoderm there arises, by specialization, by insinking, and by multiplication of the cells, the three-layered condition. The presence of yolk so obscures and complicates the process that the student must be referred to more comprehensive books for even an outline of it.

330. **The Later Development** may be either direct or indirect. That is to say, the young when hatched may be the

FIG. 128.

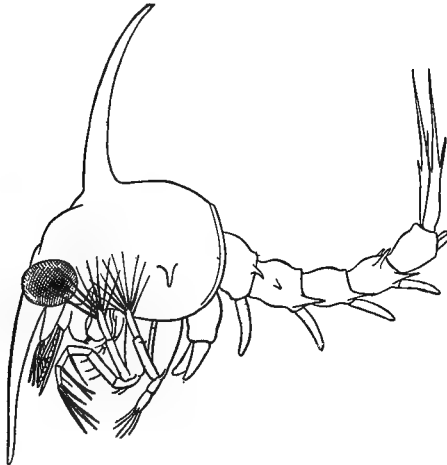


FIG. 128. The Zöea of *Cancer irroratus*. From Verrill.  $\times 15$ .

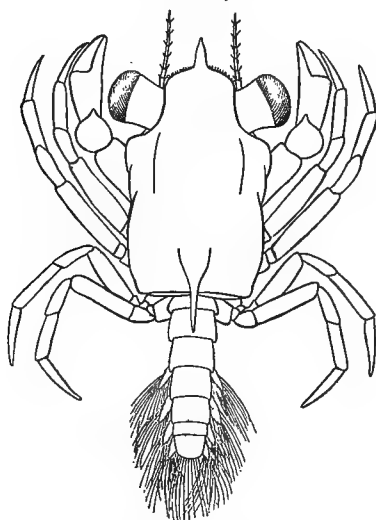
**Questions on the figure.**—Compare with the larva of lobster (Fig. 131) and with the *Megalops* (Fig. 129), and note likenesses and differences.

adult in miniature, possessing its form and habits, or may have a very different form and assume the adult condition by one or more *metamorphoses*. The differences between the larval and adult conditions may be slight or very great. To effect



the change from larva to adult a series of moultings of the chitinous covering is usually necessary; these may be accompanied or preceded by periods of rest, in which important internal changes take place. The metamorphosis is more common among insects (Figs. 142 and 148), although a similar thing happens in many of the Crustacea (as crabs, Figs. 128–130). In spiders the development is direct. The eggs of many insects hatch as worm-like larvæ (grubs, maggots, caterpillars). These are usually active, voracious, fat-storing animals, which after

FIG. 129.

FIG. 129. Megalops of *Cancer irroratus*. From Verrill.  $\times 15$ .

Questions on the figure.—Compare with Figs. 128 and 131, and make note of the chief points of contrast. Compare also with adult crab (Fig. 130). What differences are to be noted between the development in the lobster and in crabs? Is the larval or adult crab more like the lobster?

a period pass into a resting condition, often surrounding themselves with protective coverings (*cocoons*). During this quiescent stage they are described as *pupæ*. In the pupal stage the accumulated fat is used by the organism in connection with the formation of the new organs of the adult or *imago*. Many of the internal larval organs may be torn down completely by the aid of amœboid cells and be made to contribute material to

rebuild the new. The extent of these changes can only be realized by a comparison of the structure of a caterpillar and of the butterfly into which it develops. The larvæ may be suited to aquatic life, the adult to aerial; the larva may be carnivorous or herbivorous, the adult may live on the nectar of flowers. These changes of habit are closely correlated with the changes of structure noted in the metamorphosis. The reproductive organs are not mature until the imago stage is reached. Frequently the imago only survives long enough to insure the laying of fertilized eggs. In general the length of

FIG. 130.

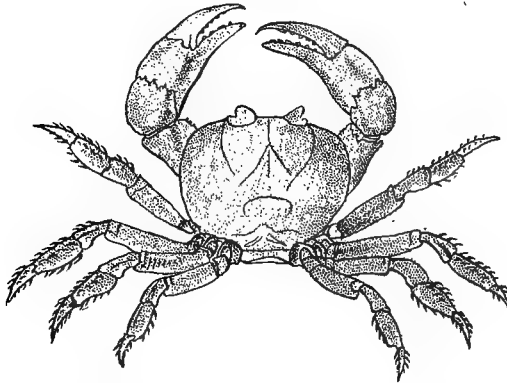


FIG. 130. Violet Land-crab. After Shufeldt.

**Questions on the figure.**—Compare the crab with the lobster (Fig. 132) as to the development of the body-regions, segmentation, appendages, etc. Compare all the figures of crabs available and note in what respects they vary externally.

**331. Library References.**—Make a report on the metamorphosis in Crustacea. What is meant by an incomplete metamorphosis? Illustrations.

life in insects is short, although it is claimed that queen bees may live five years and queen ants thirteen. The Crustacea are much longer lived.

**332. Ecology.**—When we remember the great number of species and of individuals in the group of arthropods we are forced to realize something of their importance in their relation to other forms of life on the earth. Their numbers and their enormous power of reproduction make it inevitable that they become pests and threaten the existence of the plants and animals on which they prey, and likewise that they become

important elements in the food supply of animals which prey on them. It is only by their great reproductive power that they can hold their own against their many enemies,—the birds and other insectivorous animals, and the accidents of climate, etc. The Crustacea furnish a large part of the food of fishes.

From a human point of view they may be the greatest pests or the greatest helpers. In the voracious larval stage they devour waste material as scavengers, strip vegetation, spread disease, produce silk, and furnish food to the higher animals. In the adult stage they may destroy crops; cross-fertilize flowers in their search for nectar, which they may store for themselves and their young—to be intercepted in the case of the bee by man; may spread diseases; may devour stored grain, or by their mere presence become a nuisance to man and the domestic animals. In both mature and immature stages they may be parasites on man and other animals. Few of the arthropods are directly useful as food to man, though lobsters, crayfish, shrimps, etc., are important items in our food supply.

Many special devices of structure and of instinct have arisen making their continued existence in the presence of their enemies possible. Indeed there is no group of animals in which so many and such interesting adaptations to the special conditions of life are found as among the arthropods. All are provided with some degree of external protective covering. Many are so colored and shaped as to be inconspicuous in their natural environment. Some are endowed with offensive odor and taste, some with stinging organs. Others which are themselves perfectly harmless are so much like forms which are repulsive or dangerous, as to be protected thereby from their enemies (see Chapter VIII).

Many insects as ants, bees, and wasps are strikingly social in their habits, and show a high degree of differentiation among themselves. Among the bees a special class of females—the queens—lay the fertilized eggs, the other females—the workers—being sexually immature. In the ants, still further division of labor occurs among the workers. Some individuals act as soldiers for the protection of the ordinary workers. Some species of ants make slaves of other species of ants which do the

work of the colony, or of other animals (aphids) for the purpose of feeding on their secretions. A high order of social instincts and skill is shown by certain members of this group,—the highest, apparently, shown by any of the invertebrate animals.

333. **Behavior.**—In the Arthropods we are dealing with organisms more complex in their nervous organization and with a greater variety of sense organs than we have yet found,—with the possible exception of some of the cephalopods. Their reactions to stimuli and general behavior in the presence of the conditions of life, and probably their mental life, are correspondingly rich and varied. Their activities are reflex and instinctive rather than intelligent, although it has been definitely shown by experiment that the crayfish and some of the insects learn to accomplish things by the trial and error method. That is, they modify behavior through experience.

The nervous system, scattered as it is largely through the segments of the body, is suited more to reflex activities than to intelligent activities. The latter become more pronounced as the brain comes to contain a larger portion of the nervous matter, with more complex connections.

Crayfish prefer darkness and are positively thigmotropic (that is, like to touch solid objects). Both these reactions are valuable in bringing them into hiding.

Some species of insects show striking powers of recognizing one another, and of communicating their mental states. This is done apparently through tactile and chemical sense organs in the antennæ and other appendages and by the making and hearing of sounds. The whirring and buzzing of wings in flies and bees and mosquitoes, the scraping of legs and wings by which chirping is done, the sustained stridulations of the cicada are examples of these. The lazy hum of the bee is very different from the angry buzz, and is quickly recognized by other members of the hive. In others as the mosquito the song of the female is probably a sex call. Probably many of them, such as the tappings of some beetles, are without meaning except as evidences of nervous activity. Others are merely incidental to necessary activities, as flying.

The complex instincts of many insects as yet defy our analysis. We do not know to what extent these instinctive actions are produced by external and by internal conditions, but we do know that external stimuli furnish the occasion; for example decaying meat initiates the egg laying reflex in gravid flies. The most remarkable instincts are connected with the place and time of egg laying, the building of homes, the capturing of prey, and the complex social life of the higher forms. The student can well afford to seek illustrations of these.

In some of the Crustacea there is an interesting power of breaking off an injured leg *at a definite point*. This is not because of particular weakness at this point, but is the result of definite muscular contractions. It is a reflex response to certain stimuli. The regeneration of the leg occurs from the stump. Many crustaceans have the power of regenerating any of the appendages which may be lost. This is true also of the eyes, which are on stalks. Under certain circumstances antennæ may develop in place of the eyes.

334. **Library Exercises.**—Reports on the social life of bees and ants; on the animals captured and utilized by ants; on power of flight in ants; on queens among ants and bees; on myrmecophilous (ant-loving) insects; on intelligence among insects and spiders.

### 335. Classification.

*Class I. Crustacea (with shell; Crayfish, Crabs, Barnacles, etc.)*.—Arthropoda, chiefly inhabiting the water and breathing by means of gills or through the body wall. The head typically consists of five segments more or less fused and bearing two pairs of antennæ or feelers, one pair of mandibles, and two pairs of maxillæ. The thorax or second region of the body may be separate from or fused with the head (*cephalothorax*). It possesses a variable number of segments, which usually bear the locomotor appendages. The remainder of the body (abdominal segments) is normally of distinct segments in which the appendages are much reduced. The chitinous skeleton is ordinarily well developed.

*Subclass I. Entomostraca*.—Crustacea, small and simple in organization, with a variable number of segments of which the appendages are simple and less diverse than in the next subclass. Many of them are parasitic and degenerate. A metamorphosis occurs. The group embraces many small free forms, found both in fresh and salt water, some fish parasites, and the sedentary barnacles. Here belong *Cyclops* and *Daphnia*, which occur abundantly in fresh water pools and feed on the algæ common there. They constitute an important portion of the food of the fresh-water fishes. They multiply very rapidly and keep closely up to the limit of the food supply. The eggs of many of them can resist drying to a remarkable degree. This is of manifest importance when we remember that they frequent pools in which drouth is not uncommon.

The barnacles (Cirripedia) are Crustacea which in adult life become attached to the rocks near low water-mark or to floating objects of various kinds. The bottoms of ships become foul with them. The group is especially interesting in that it points to the giving up of free motion, which its ancestors possessed, for a mode of life wholly different, and demanding marked changes of structure. They possess, besides the organs for attaching themselves, bivalve shells similar to those of Mollusca, for protection; they are often hermaphroditic, which is a very uncommon thing in arthropods. The advantages gained by their special habits are evident. The waters near the shore contain a great deal of organic débris, and any organism which can attach itself here and yet be protected from destruction by the waves is fortunate. Those attached to floating objects are brought, without their effort, into constantly changing localities.

*Subclass II. Malacostraca.*—Crustacea of larger size and more highly organized. Segments, except in one order, twenty, and well differentiated. Nineteen of these segments bear appendages. The first stage in the metamorphosis (the

FIG. 131.

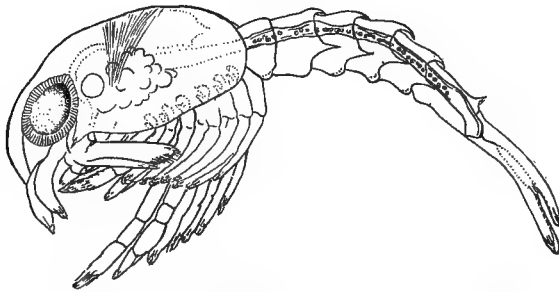


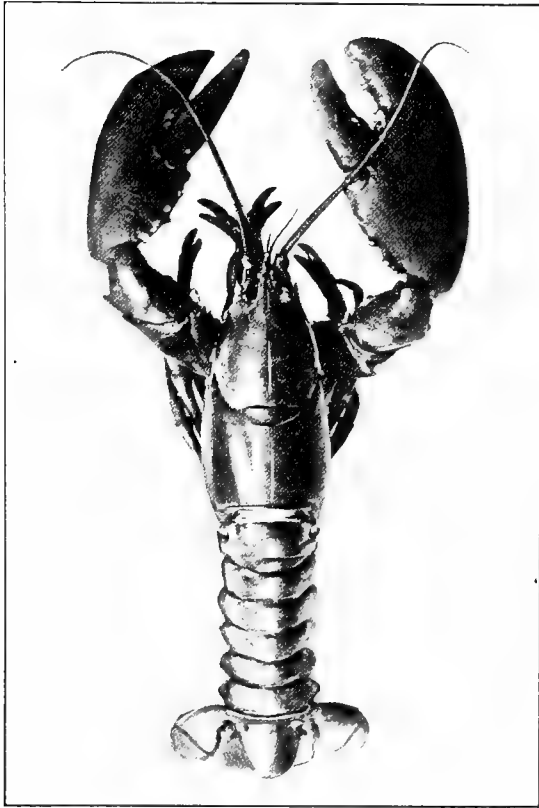
FIG. 131. Larva of Lobster (*Homarus americanus*) removed from egg shell. From Herrick.

**Questions on the figure.**—Compare with the adult (Fig. 132) and note similarities and differences? Examine Dr. Herrick's figures (Bull. U. S. Fish Commission for 1909) and notice the gradual change to the adult condition by successive moultings. What structures can you identify?

*nauplius*) is usually passed before hatching. The group embraces (1) the Decapoda, or the lobsters, crabs, crayfishes and shrimps, which agree in the possession of ten walking feet, eyes on movable stalks and a carapace covering the thirteen fused segments of the cephalothorax; and (2) the Tetracapoda, comprising numerous smaller types such as beach-fleas, sow-bugs or wood-lice, in which head and thorax are not fused, the eyes are not movable, and the walking appendages are fourteen.

The crayfish and lobsters have well-developed abdominal segments, whereas in the crabs the abdomen is reduced and bent under the thorax, which becomes broad and massive (Figs. 129, 130). The larger Crustacea are omnivorous, almost all organic matter, dead or living, being acceptable. Lobsters are known to attack and devour fishes. The lobster (*Homarus*, Figs. 131 and 132) is economically the most important member of the group, and stands next the oyster as the most important invertebrate food species. It is estimated that, in times past, as many

FIG. 132.

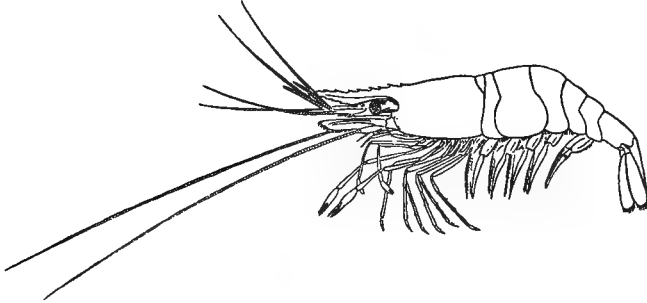
FIG. 132. The American Lobster (*Homarus americanus*). From Herrick.

**Questions on the figure.**—What body-regions are distinguishable in the lobster? Compare by actual measurement the size of the crushing claw with that of the body. How many segments in the abdominal region? Compare with Fig. 130.

as one hundred million lobsters have been taken in a single year in Canadian waters alone. There is no doubt that the lobster is in immediate danger of extinction as a food animal, as is shown by the fact of greater difficulty in obtaining them and by the decrease in the average size of the animals put on the market. This decrease occurs in the face of the fact that the mature female produces from ten thousand to one hundred thousand eggs. These are carried under the abdomen of the mother until hatched, which requires a period of ten or eleven months. After hatching the young undergo a series of moultings during which time they are the prey of many kinds of enemies. Such is the mortality that, on an average, not so many as two of all the young of a female reach maturity. This is another

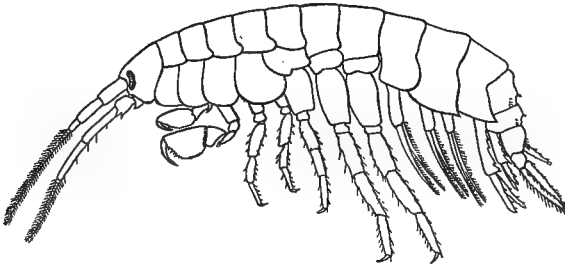
way of saying that a species is losing ground. Two general methods have been tried to make good the decline in the supply: first, legislation forbidding the taking of animals under the size which indicates sexual maturity (eight to twelve inches), and forbidding the capture of females carrying the developing embryos; and, sec-

FIG. 133.

FIG. 133. *Palæmonetes vulgaris*. From Verrill.

**Questions on the figure.**—Compare the appendages of *Palæmonetes* with those of the lobster, the crab and *Gammarus*. What seem to be the functions of the various appendages, so far as position and form may indicate?

FIG. 134.

FIG. 134. *Gammarus ornatus*. From Verrill.

**Questions on the figure.**—How does this form compare with the lobster and the crabs in differentiation of the segments, in fusion of the segments and in the differentiation of the appendages?

ond, attempts on the part of the national government to hatch artificially and care for the moulting young under such conditions that they will be protected from their natural enemies. The problem is not yet solved, and in the meantime another source of food is likely to be destroyed through overfishing.

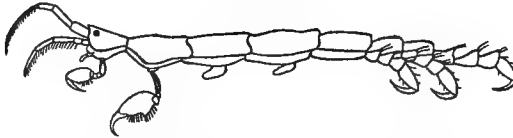
The crayfish is prized for food in European countries, but is little used in America as yet. Shrimps, prawns, the "soft-shelled" or blue crab are all of considerable importance in this regard. The smaller crustacea are a very important element in the food supply of the fishes, both in the fresh waters and in the sea.

*Class II. Onychophora.*—*Peripatus* is the best known genus of this class. It is interesting chiefly because it is, in some degree, intermediate between the



Annelida and the higher arthropods. They are remarkable for a wide distribution out of proportion to their numbers, and are found in moist places, under wood, stones, and in rotting bark. They agree with the chætopod annelids (see §276) in the possession of segmental organs (nephridia), a dermo-muscular sac, and poorly developed appendages. The segments are also homonomous (see §264) as in the worms. The relationship to arthropods is indicated by the possession of tracheæ, by the substitution of hæmocœle (the enlarged lacunæ in

FIG. 135.

FIG. 135. *Caprella geometrica*. From Verrill.  $\times 4$ .

**Questions on the figure.**—In comparison with other Crustacea what are the aberrant or peculiar features of this form? See also figures in reference texts (e.g., Parker and Haswell's *Zoology*, Vol. 1, p. 546).

which circulation occurs) for the true cœlom, and by the differentiation of some of the anterior segmental appendages as mouth parts. The Onychophora resemble the larval condition of those insects which undergo a metamorphosis much more than the adult stages. This suggests that they are more closely related to the ancestral types from which the insects have sprung than to the insects themselves (Fig. 136).

*Class III. Myriapoda (many feet; Centipedes, etc.)*.—Tracheate arthropods with a worm-like body. Segments numerous, and much alike, one (or, in Dip-

FIG. 136.

FIG. 136. *Peripatus capensis*. From Nicholson after Moseley.

**Questions on the figure.**—Externally in what respects is this form like the Annelids? In what respects different from them? Of what special zoological interest is this genus? What are its habits? In what respects is it like and in what unlike the centipede (Fig. 137)?

lopada, two) pair of appendages to each segment. The head is distinct and bears antennæ and mouth parts. The eyes are numerous and simple (*ocelli*). In fundamental structure and development the myriapods resemble insects. There are two principal orders. One embraces the centipedes (Fig. 137) which are carnivorous, have biting jaws, have one pair of appendages to each segment, and are poisonous. The second includes the millipedes which are vegetable feeders and possess mandibles suited to chewing vegetable matter. They are wholly harmless. They have two pairs of legs to each of the numerous segments except the first four.

Both centipedes and millipedes inhabit the land, and frequent dark places. Many are nocturnal in habit.

**Class IV. Hexapoda (six feet; Insects).**—Tracheate arthropods with three distinct body regions,—head, thorax, and abdomen. The head is a fusion of at least six segments of which four are represented by appendages,—a pair of antennæ and three pairs of mouth parts. The thorax has three segments (pro-, meso- and meta-thorax), each of which, in adult insects, bears a pair of legs; the meso-thorax and the meta-thorax may each bear a pair of wings. The abdomen has a variable (often obscure) number of segments. Its appendages are usually entirely wanting or much reduced. A metamorphosis frequently occurs. The larval condition often suggests the annelids and the myriapods in the similarity of its segments, and in the numerous appendages.

The student is referred to more comprehensive works for a complete exposition of the numerous orders of this enormous group Hexapoda. Only the more important are described below.

FIG. 137.

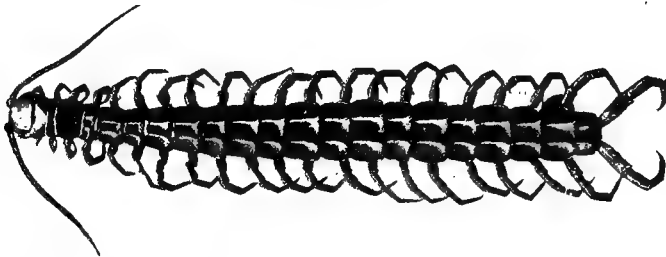


FIG. 137. Centipede (*Scolopendra heros*). Photo by Folsom. Four-fifths natural size.

**Questions on the figure.**—What differentiation of segments is apparent? Are there any fusions into body-regions? What is the law of the occurrence of appendages? What diversity is there among them?

**Order Aptera (without wings).**—This order embraces a number of minute, wingless insects which do not undergo metamorphosis. The body is covered with scales or hairs. The spring-tails and snow-fleas are examples. These make their leaps by suddenly straightening out a tail-like structure which is bent under the body when at rest. They are not the only wingless insects and hence the name is somewhat misleading. See Fig. 138. This group is often regarded as representing two distinct orders, *Thysanura* (the bristle-tails) and *Collembola* (the spring-tails).

**Order Orthoptera (straight wings).**—In this order the metamorphosis is incomplete. There are usually two pairs of wings, the anterior often somewhat thickened, serving as a cover for the posterior. Mouth parts are adapted for biting and chewing. Here belong the cockroaches, grasshoppers, crickets, locusts, katydids, walking-stick insects. The order is of considerable economic importance. Most of its members are vegetable feeders and when they are gregarious are often very destructive. The Rocky Mountain locust, so named because it breeds on the plateau at the eastern base of these mountains, in 1873 and again in 1878, migrated eastward over Nebraska and Kansas in search of food, literally stripping

fields of vegetation. Since the settlement of the regions where they breed, with the ploughing up of the eggs and the destruction of the young, there is reason to hope that these migrations are at an end. Accounts of similar migrations of locusts are recorded in the history of the old world. These migrations and their effects illustrate how climatic conditions in one locality may change the balance of life in another. The second chapter of the prophet Joel gives a vivid account of a visitation of locusts. See Fig. 139.

FIG. 138.

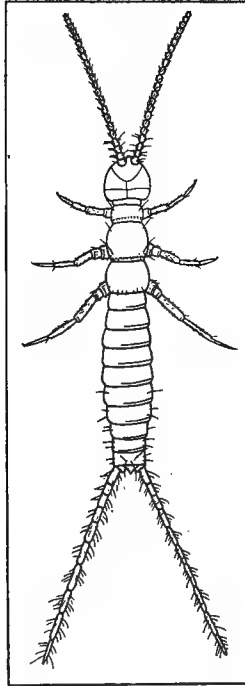


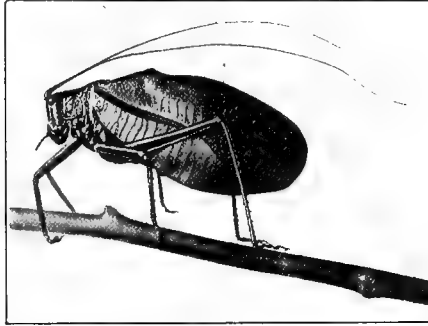
FIG. 138. *Campodea*,—a Thysanuran. Magnified 30 times. By J. W. Folsom.

**Questions on the figure.**—In what respects does this form seem intermediate between the Myriapods and the higher insects? How does this compare with the larvæ of insects which undergo a metamorphosis? Can you distinguish head, thorax, and abdomen?

**Other Orders.**—Some of the smaller orders are as follows: the *Ephemera*, or May flies whose adults may live for only a few hours, although the larvæ may require from one to three years to develop; the *Odonata*, or carnivorous dragonflies, and damsel-flies; the *Plecoptera*, or stone-flies; the *Isoptera*, or termites (white ants) which are social, polymorphic forms; the *Corrodentia*, book-lice and bark-lice; the *Mallophaga*, parasitic bird-lice which eat hair and feathers; the *Thysan-*

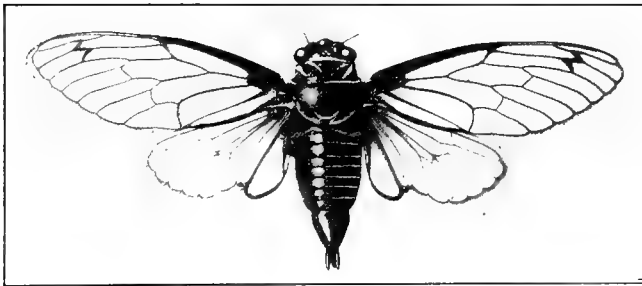
*optera*, or thrips; the *Dermaptera* or earwigs; the *Neuroptera*, the Dobson flies, ant-  
lions, and lace-winged-flies; the *Trichoptera* or caddice flies, each of which in the lar-  
val stage constructs around itself a protecting case made of sand or other particles  
of matter.

FIG. 139.

FIG. 139. Katydid (*Pterophylla camellifolia*), natural size. Photo by Folsom.

**Questions on the figure.**—How many pairs of appendages are visible in the figure? How many pairs are present? To what order of insects does the Katydid belong? What are its feeding habits? What can you find of its development?

FIG. 140.

FIG. 140. Periodical *Cicada*. Natural size. Photo by Folsom.

**Questions on the figure.**—To which order of insects does Cicada belong? Which of its habits are most familiar to you? What are its nearest relatives among the insects?

*Order Hemiptera (half-wing).*—Hexapoda with an incomplete metamorphosis, and having two pairs of wings, or none. Mouth parts are modified for piercing and sucking. Here are included the true bugs, as the squash bug, chinch bug, bedbug, the water boatman, etc.; the plant-lice; the scale insects; and the cicadas (sometimes called "locusts"). These should not be confused with the beetles,

which are often called "bugs." See Fig. 140. The Hemiptera furnish some really serious pests, as the scale insects, aphids, chinch bugs, etc.

*Order Diptera (two wings).*—These Hexapoda undergo a complete metamorphosis, having the anterior pair of wings developed except in three or four groups, which are wingless. Hind wings reduced to mere rudiments. The mouth parts are well adapted for piercing and sucking. The order is very large in species and includes such common forms as the flies, mosquitoes, gnats. Many members of this group are of great importance to man. The maggots of the true flies are usually scavengers, developing in decaying organic matter and assisting in its destruction; the adults, on the other hand, besides being unpleasant companions

FIG. 141.

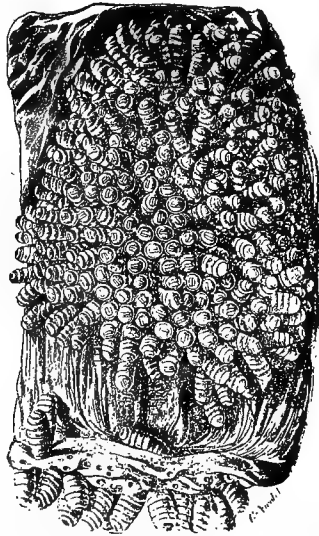


FIG. 141. Larvæ of the Bot-fly (*Gastrophilus equi*) in the stomach of the horse. One-half natural size. From Luggar, after Heller.

**Questions on the figure.**—What do you know of the habits of the bot-fly? Where are the eggs deposited? How do the larvæ come to have the position figured above? How do they pass from this to the adult condition? See also Fig. 142. How does it retain its position in the stomach of its host?

and demanding a share of our comforts, spread disease. Other species suck the blood of man and domestic animals, producing disease and death. The bot-flies are most destructive in their larval stage. The eggs, deposited on the exterior, are taken into the digestive tract and there develop, often migrating into other organs and producing definite diseases. Mosquito larvæ devour the decaying organic matter in stagnant pools. The adult female is a blood-sucker and is, through the parasitic protozoa which may infest it, the chief instrument of the spread of malaria and yellow fever among men. They are all very prolific and develop rapidly, considering the fact that they undergo a metamorphosis. The house fly,

for example, only requires a few hours for hatching into the maggot stage. If food and temperature are favorable, this maggot may grow to full size in a week, when it passes into the resting or pupa stage, from which another week or more is required for the young fly to emerge.

The eggs of mosquitoes are deposited in water, where they hatch into active larvæ called "wigglers." These breathe the air by means of a tube on the next to the last abdominal segment. Their common position with the end of the tail at the surface of the water is thus explained. The mosquito larva does not cease to be active, but by a series of moults comes to the pupa stage from which by an

FIG. 142.

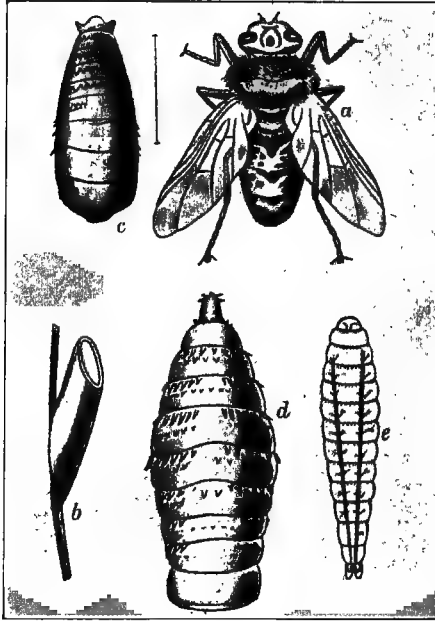


FIG. 142. Stages in the development of the Bot-fly (*Gastrophilus equi*). From Parker and Haswell, after Brehm. *a*, adult insect; *b*, egg attached to a hair; *c*, *d*, and *e*, stages in the development of the larva. (See also Fig. 141.)

early moulting the adult mosquito emerges, balancing itself on the floating pupal skin until its wings are hardened sufficiently for use. See Fig. 143.

The Hessian-fly deposits its eggs on the leaves of growing wheat; certain of its near relatives produce galls which interfere with the growth of the plant, often very seriously. In the case of the Hessian-fly great damage to the wheat crop often results. See Fig. 144.

The fleas are to be looked upon as degenerate. They are often placed in a separate order (*Siphonaptera*). The adults are external parasites without wings. They are flattened laterally and thus pass readily between the hairs of the host. The larvæ are not parasitic, but live on decaying organic matter.

*Order Lepidoptera (scale-wings).*—These are Hexapoda which pass through a complete metamorphosis, in the adult possess sucking mouth parts, and have two pairs of large membranous wings covered with scales. The moths and butterflies are the representatives of the order. The larvæ are known as caterpillars, which, with a few exceptions, are vegetable feeders. The adult butterfly differs from the

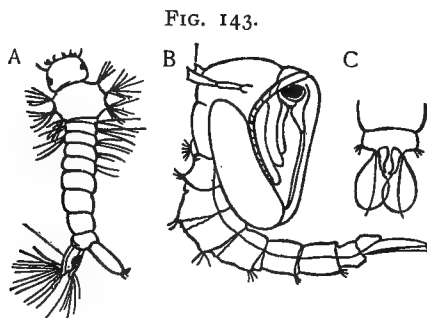


FIG. 143. Two stages in the metamorphosis of the Mosquito. From Packard. A, larva; B, pupa; C, ventral view of the oar-like appendages of the last segment of the pupa

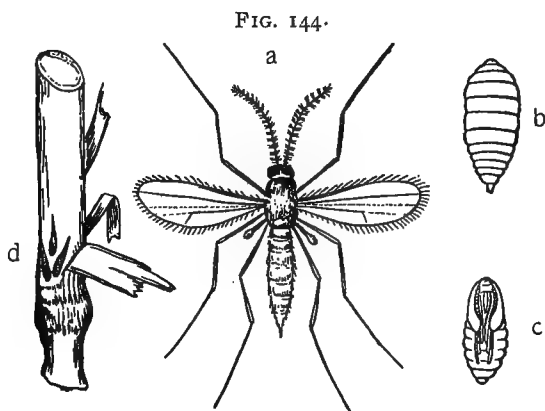


FIG. 144. The Hessian Fly (*Phytophaga destructor*). From Standard Natural History. a, the adult; b, larva; c, pupa; d, larvæ in position on stalk of wheat.

**Questions on the figures.**—Give names to all the structures apparent on the adult. In which stage does the insect do its damage? What is its economic importance? What is the origin of its common name?

moths (typically) in the fact that the former fly by day, hold the wings erect when at rest and have antennæ with a club on the end. The butterflies and moths share with the birds the preëminence in beauty among animals. They present many points of interest in their metamorphosis, in their habits, their coloration, their distribution, and their economic effects.

The caterpillars are usually voracious and may strip their food plant of its leaves and buds. The majority of the larvæ have become highly specialized in their food habits, becoming restricted in some instances to one species or to a few related species (as illustrated by the tomato worm, which feeds on tomato, potato,

FIG. 145.

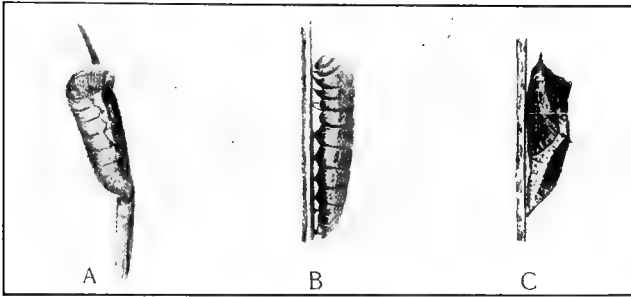


FIG. 145. The Cabbage Worm (*Pieris rapæ*). Natural size. Photo by Folsom. A and B, larvæ; C, pupa.

**Questions on the figure.**—What is a larva? What is a pupa? Which is the earlier stage? What is the color of this caterpillar in nature? See the next figure for the adult.

FIG. 146.

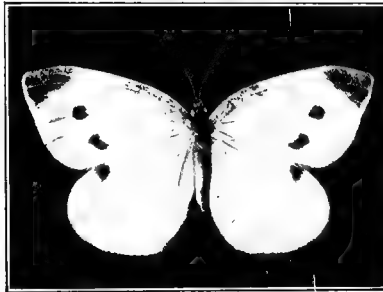


FIG. 146. The adult Cabbage Butterfly (*Pieris rapæ*). Natural size. Photo by Folsom.

**Questions on the figure.**—Why is the larva of this animal called the cabbage worm? Why is the adult called the cabbage butterfly? What are its feeding habits?

and tobacco leaves; or the cabbage worm which eats the leaves of certain of the cruciferous plants). The distribution of such species is thus clearly determined by that of their host plants. Among the most injurious to vegetation are the "tent-caterpillars" which occur gregariously and spin a web-like nest; the army-worm so-called because it sometimes appears and moves from its hatching grounds



in great numbers; the cotton-boll worm; the canker-worms and fruit-borers. The silk-worm is a very useful member of the order. The clothes-moth lays its eggs in woolens or furs.

The adults are usually short-lived and some do not eat at all. The majority of them suck nectar from flowers and juices from ripe fruits and other objects by means of special tubular mouth parts which are modified paired appendages. They carry pollen from flower to flower, effecting cross-fertilization, in some instances. The color of the larvæ and the adults is very varied and often has close relation to the environment and habits of the animals. We have already noticed in the chapter on adaptations (Chap. VII) how the coloration may be protective. This is the more needed since the group has many enemies, especially in the larval stage. The power of reproduction is great. Several broods per year may be produced. There are more than 50,000 known species of Lepidoptera, about 8,500 of which occur in North America, north of Mexico. The species are more numerous and striking in the tropical regions of South America.

FIG. 147.

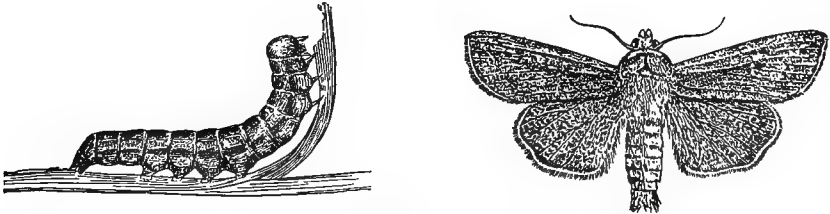


FIG. 147. The Army Worm (*Carpis unipuncta*). After Riley. A, caterpillar; B, adult moth.

**Questions on the figures.**—What are the principal facts concerning the habits and economic importance of the army-worm? Why is it so called?

**Order Coleoptera (shield-wings).**—In this group there is a complete metamorphosis. The mouth parts are suited to biting and chewing. The front wings (*elytra*) are hardened and serve as covers for the true membranous wings when the latter are not in use. These are the beetles,—falsely called “bugs.” Although a well-defined order the beetles manifest a wide range of variation, as will be seen from the fact that there have been described over 18,000 species for this continent north of Mexico. There are said to be more than 150,000 known species of beetles.

Many of the larvæ are commonly known as grubs. The feeding habits are almost as diversified as the form. Many are scavengers and lay their eggs in carrion and other decaying matter; others bore into wood and bark, as the long-horned beetles; some frequent grain, nuts, fruits; others are leaf-eaters; a few devour other insects. The Colorado potato-beetle, the weevils, the museum pest, the locust-borer or the hickory-borer will serve to illustrate some of the more hurtful representatives of this immense order.

Some especially interesting forms are the fire-flies, the sacrabæids which include the sacred dung-beetle of Egypt, and the ladybird-beetle. The latter is useful to man owing to the fact that it preys on certain hurtful insects. In California the cottony-cushion scale, which in some way had been imported from Australia,

promised at one time to destroy totally the orange industry. The Australian ladybug, which keeps it within bounds in its native home, was imported, and the increase of the ladybugs was such that the cushion-scales were all but destroyed. This species of ladybug feeds exclusively on the cottony-cushion scale, and therefore the destruction of the latter led in turn to the rapid decline of the ladybugs, due to the loss of their food supply. Indeed it was necessary to keep colonies of the scale insects protected in order to furnish food and to prevent the entire destruction of the imported beetle by starvation. In Australia where both are at

FIG. 148.

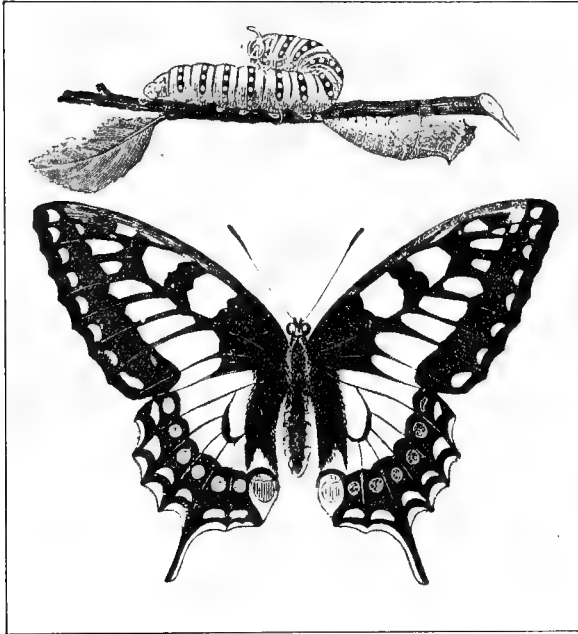


FIG. 148. Swallow-tail Butterfly (*Papilio machaon*),—larva, pupa, and adult. From Nicholson.

**Questions on the figure.**—Which is the larva and which the pupa? Which of these is the earlier stage? What are the chief characteristics of the three stages in the metamorphosis of butterflies,—the larva, the pupa and the imago?

home the natural conditions and the adjustment of the two species are such that this scale-insect does not become a pest. The discovery of the biological relations of these species, and the relief of the orange industry furnish a sample of the excellent work being done by the U. S. Department of Agriculture in connection with the economic aspects of biology.

*Order Hymenoptera (membrane-wings).*—Hexapoda with four membranous wings; mouth appendages adapted for sucking or for biting; metamorphosis complete. This is the most highly developed division of Insecta, and embraces such

forms as bees, wasps, and ants. The most important habits of the group, which are those growing out of their social life, have been referred to in the chapter on adaptations (Chapter VIII). The chief economic value of the order is in the honey of the honey-bee, the fertilization by bees of certain plants, as clover, and the reduction of more hurtful species of insects by certain parasitic members of the order, as the ichneumon-flies and chalcid-flies. Some of the larvæ are leaf-eating, as the rose-slug, and others produce galls on the oak and other plants in depositing their eggs. These are harmful to human interests.

FIG. 149.



FIG. 149. Hornet's nest, sectioned. Photograph from life by Shufeldt.

*Class V. Arachnida* (spiders, scorpions, etc.).—Arachnida are arthropods in which the head and thorax are typically fused and represent about seven segments with six pairs of appendages. There are no antennæ. The abdomen is often segmented but usually without paired appendages. Respiratory organs are confined to the abdomen, and may be of three types: *book-gills*, associated with appendages (king-crab); *tracheæ* similar to those of insects; and *book-lungs* (spiders). Development is usually direct.

*Order I. Xiphosura* (the king crab).—This order contains only one genus, *Limulus*, a marine form with book-gills, and a cuticular test like that of the Crus-

tacea, with which it was formerly classified. Numerous related forms flourished earlier in the world's history but are now extinct (*Trilobites*).

*Order II. Scorpionida* (scorpions).—Arachnids with a much elongated and segmented abdominal region closely connected with the thorax. They are air-breathers, with four pairs of book-lungs in the abdomen. The posterior abdominal segments form a tail the last segment of which bears a sting. See Fig. 150.

FIG. 150

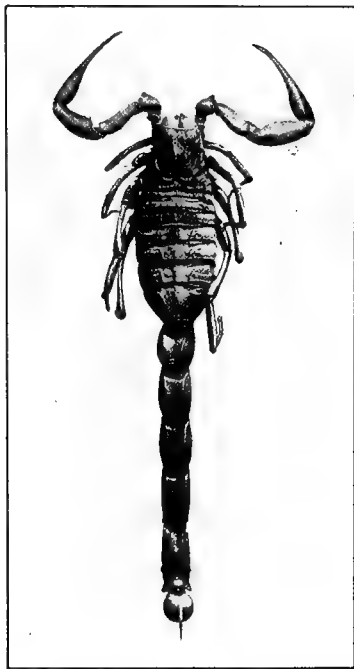


FIG. 150. Scorpion (*Buthus*). Photo by Folsom.

**Questions on the figure.**—Compare the scorpion with figures of Crustacea, insects and spiders, noting the chief differences and likenesses. Of what use is the long, segmented abdomen in the scorpion?

*Order III. Araneida* (spiders).—The Araneida are air-breathing arachnids, with book-lungs alone or in connection with tracheæ. Poison glands are common in connection with the first pair of appendages (chelicerae). The abdomen is unsegmented and without appendages, unless the spinnerets represent reduced appendages. On these latter, open the ducts of the numerous glands secreting the fluid which hardens on exposure to the atmosphere and makes the silk of the web.

Spiders may be classified on the basis of the type of web which they make. The "*orb-weavers*" construct webs of great regularity and beauty; others, as the

FIG. 151.

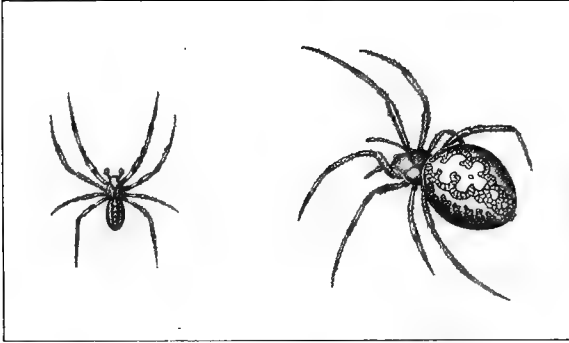


FIG. 151. Spiders (*Epeira marmorea*). After McCook. Male on left; female on right. Natural size.

**Questions on the figure.**—What differences do you note with respect to the sexes? What habits of the spiders are correlated with this difference in size in the sexes?

FIG. 152.

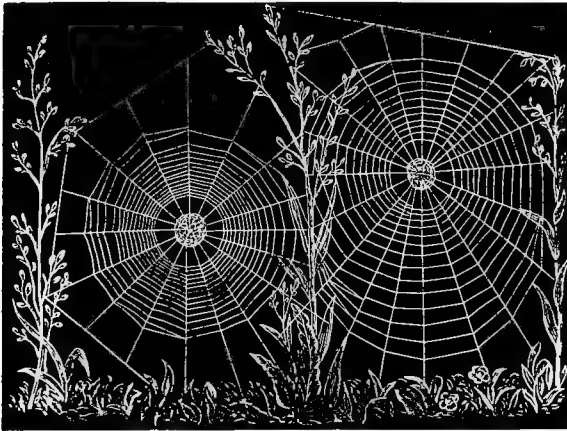


FIG. 152. Web of *Epeira strix*, an Orb-weaving Spider. After McCook.

**Questions on the figure.**—By reference to other texts or by observation determine if there is any regular order in which the parts of the web are produced. To what is this form of web an adaptation? Evidences? What other forms of webs are constructed for similar purposes?

cob-web spider, make a complex and irregular mesh-work of fibres running in all directions; others spin a web similar to the last with the exception that at one point it is continued into a tube into which the spider retreats for hiding. The webs of these spiders are for the purpose of catching flies and other insects on which the animal feeds. The trap-door spiders make a tunnel in the ground which they line with their secretion; a door is woven which is so covered with materials like those about the nest that its presence is effectually hidden. A considerable number of spiders do not spin webs proper, but use their secretion merely in forming cocoons for their eggs, or in binding together objects to make a home. This wonderful secretion is used by the spider in many other ways than in the capture of prey and the making of a nest. By means of it some of the spiders make a near approach to flying. A spider may bridge the space from one object to another either by fastening one end of the strand and hanging at the other, or by sitting still, he may allow the free end to float out until it becomes attached. In some cases at least it is known that, by spinning thus loose silk in abundance, the weight of the spider may be readily carried by the action of the wind upon his silken sails.

The chief economic importance of spiders lies in their habit of preying on various insects, of which they destroy considerable numbers.

The Arachnida embraces a number of other orders including less important or less easily observed animals, as the mites, true ticks, harvest-men or "daddy-long-legs," and many parasitic or otherwise degenerate forms.

### 336. Suggestive Studies, for Field and Library.

1. Dimorphism and polymorphism in insects.
2. Protective adaptations in insects.
3. What senses seem most used among the insects?
4. Report on observed signs of intelligence among arthropods.
5. Is there any evidence of power of communication among the social insects, as the ants?
6. Courtship among the spiders.
7. Spiders' webs: form, position, efficiency, mode of construction.
8. There are some insects which have wings during a portion of their life but lose them later. Investigate the conditions and find an explanation.
9. Report an observed instance of insects pollinating flowers (*i.e.*, transferring pollen from one to another). How is it effected? Why does the insect do it? Is the pollination of flowers by insects deemed a common and important phenomenon by botanists?
10. Can you find any recorded instances of what may be

called symbiosis (see §160) between insects and other organisms? '

11. Have you any experimental evidence as to how growth can take place in forms with a firm external skeleton such as that of the crayfish?

12. Do you have any reason for thinking that a metamorphosis is advantageous to any of the Arthropoda? Is it in any respect disadvantageous?

13. How is moulting effected?

14. Habits of the "hermit crabs."

15. The lobster and its habits.

16. Silkworm culture, value and methods of.

17. Insects introduced from foreign countries. Results? '

18. The history of the efforts to find enemies to some of the more important noxious insects.

19. Relation of insects to the culture of figs.

20. The structure and habits of the king crab (*Limulus*). Why is it not to be classed with the true crabs?

## CHAPTER XVIII

### PHYLUM CHORDATA

337. This phylum includes, beside the typical Vertebrata to be described in later chapters (fishes, amphibians, reptiles, birds and mammals), several groups of much more simple organization. These latter forms may be included under the general head Protovertebrata, not because they all show close relationship among themselves, but because of their primitive character, considered as Chordata. They are of very great interest to the biologist on account of the hints they may offer concerning the ancestors of the vertebrates. For detailed description of the manner of life and the structure of these primitive chordates the student must be referred to advanced text-books of zoology.

**338. General Characters of the Chordata (Protovertebrata and Vertebrata).**—The Protovertebrata are allied with the typical vertebrates and separated from the invertebrates by the possession, either in the immature or adult condition, of the following features:

1. A mid-dorsal, longitudinal rod of cells (*notochord*) derived from the entoderm, but often surrounded by mesodermal structures (see Fig. 157). This lies ventral to and supports
2. The central nervous system, a mid-dorsal cellular tube with thickened walls derived from the ectoderm.
3. Gill-slits or perforations connect the cavity of the pharynx with the outside directly or through an atrial chamber.
4. The heart is typically ventral to the digestive tract.

**339. In the Group of Protovertebrata may be placed:**

1. *Balanoglossus*, a soft-bodied, worm-like form whose claim to a place among the Chordata rests upon the fact that an out-growth of the gut extends into the proboscis, where it forms a solid rod which in its origin suggests the notochord; a portion of



the nervous system is dorsal; and gill-slits occur. On the other hand there is a connective around the esophagus and a ventral nervous thickened band as in Annelida, and it shows little or no signs of segmentation (see Fig. 153).

2. *Tunicates* (sea-squirts, ascidians, etc.) comprising a variety of forms which may be said, on the whole, to be degenerate in the adult condition. It is in the larval or tadpole state particularly that their relation to the Chordata is suggested. In the larva they possess a notochord especially in the

FIG. 153.

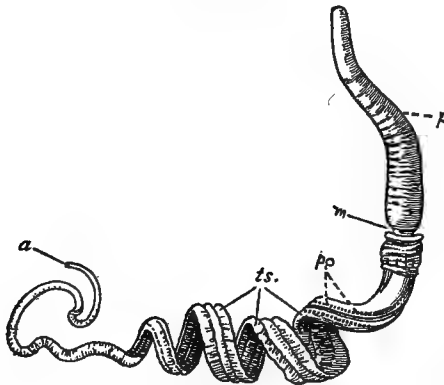


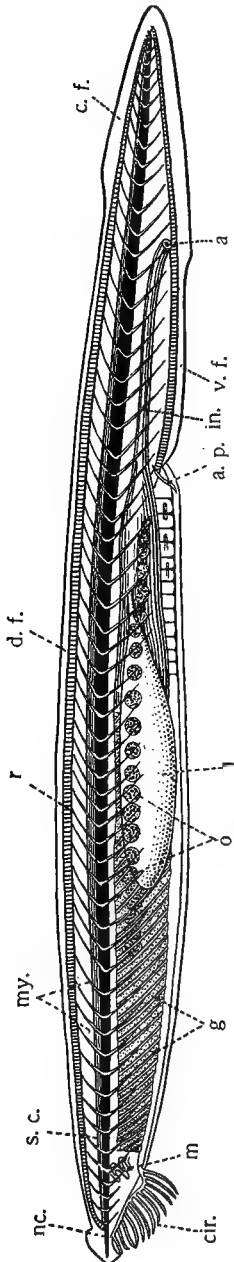
FIG. 153. *Balanoglossus* (Male). After Bateson. *a*, anus; *m*, mouth; *p*, proboscis; *po.*, pores, the openings of the gill-slits; *ts.*, testes.

**Questions on the figure.**—Make reference to other texts and figures and determine what features of *Balanoglossus* tend to ally it with the chordates. What are the habits of the animal? Where do the earlier zoologists class *Balanoglossus*?

tail region, a dorsal nervous system, and gill-slits. The adult forms are usually attached, many of the larval organs becoming much changed or even wholly lost in consequence of the changed mode of life. The adults have been variously classified as worms, mollusks, etc. Many of the tunicates multiply by budding and form colonies from the fact that the buds remain associated.

3. *Branchiostoma* (*Amphioxus*; lancelet) possesses the characters above mentioned as belonging to all the Chordata, except that there is no true heart. In addition it has a fish-like body, and the muscles are arranged in segments which appear exter-

FIG. 154.



nally. It lacks paired fins, but has a median dorsal fin which continues over the tail and forward a part way on the ventral side. In front of this is a thick fold (*metapleure*) on either side the body, at the junction of the side with the belly of the animal. The metapleure is thought by some zoologists to be the forerunner of the vertebrate appendages. *Branchiostoma* is without a definite brain; that is to say, the anterior end of the nervous tube is not highly specialized. It has no skull, eyes, nor ears, such as characterize the head of true vertebrates. *Branchiostoma* is a small semi-transparent animal about two inches long (Fig. 154). It burrows in the sand with only the fringed mouth exposed. It may vary this by swimming about for short periods.

4. *Cyclostomata* (Lampreys).—These are eel-like animals formerly classed with the fishes, and are doubtless more closely related to them than to the forms before mentioned, but because of their primitive qualities they may be placed for the purposes of this course

FIG. 154. Diagram of the anatomy of *Branchiostoma*, drawn as a semi-transparent object (after Perrier "*Traité de Zoologie*"). *a.*, anus; *a.p.*, atrial pore; *c.f.*, caudal fin; *cir.*, cirri, on the edge of the vestibule leading to the mouth; *d.f.*, dorsal fin; *r.*, fin rays; *g.*, gill or branchial structures consisting of alternate *slits*, through which the water passes, and supporting *plates*, in the walls of which are the blood vessels; *in.*, intestine, from which as a diverticulum springs *l.*, the liver; *m.*, the mouth surrounded by a fringed *velum*; *my.*, myotomes or muscle segments; *n.c.*, notochord; *o.*, ovaries; *s.c.*, spinal cord; *v.f.*, ventral fin.

**Questions on the figure.**—What elements of structure appear in the figure suggesting the chordate character of *Branchiostoma*? What is the relation of the spinal cord, notochord and digestive tract? How much of the length of *Branchiostoma* possesses gills? What is the position, extent and function of the atrium? (Refer to more extended texts.) What structures show evidences of segmentation? What fins has *Branchiostoma*? Compare with fins of fishes.

among the Protovertebrata. They have a round sucking mouth destitute of jaws; they lack paired appendages and the external skeleton. There is only one nostril, which may or may not communicate with the pharynx. The cyclostomes possess a true brain, a cartilaginous internal skeleton, and gills (usually 6 or 7 pairs) in pouches. They differ from the true fishes in the fact that the notochord is not constricted, *i.e.*, the mesodermal sheath does not, by its growth, compress it by the development of distinct vertebræ around it (see §344). See Fig. 64.

340. **Library Exercises.**—By reference to all the available literature make a report on the general structure, habits, and important adaptations of each of the above types? How do the larvæ and adults of the tunicates compare? How is the degeneration accounted for. To what extent is colonial life represented among these types? Are any parasitic? Examine particularly for figures of these groups in the standard reference zoologies.

## CHAPTER XIX

CHORDATA (CONT.): SUB-PHYLUM VERTEBRATA (FISHES, AMPHIBIANS, REPTILES, BIRDS, AND MAMMALS)

### LABORATORY EXERCISES

For general illustration of the vertebrates the author is convinced that no form is superior to the frog for use in elementary classes, although a fish may be used. In a course arranged for one year it is not desirable to make elaborate dissections of more than one or two vertebrate types. Directions are given both for the fish and the frog for the convenience of those who prefer the former. Supplementary studies for the other classes of vertebrates will be found in connection with the chapters devoted thereto.

**341. Fish.**—Any common fish will serve—perch, sucker, trout, smelt. Specimens eight to ten inches in length are of most suitable size. If convenient one-half the class might take one species and the remainder another and compare results.

*A. The Living Animal.*—Place in an aquarium. Watch the locomotion and notice all the accompanying motions of the various parts. What is the rate of the tail stroke? How far, on an average, does one stroke of the tail carry the fish? Compare these points when the fish is in very rapid motion. What part do the anterior fins play in locomotion? Bind one of them flat against the body with a string. Bind both. Results? Experiment similarly with the other fins and see if your first conclusions are strengthened. Do you find any variations in the above respects by comparing several species?

How does the temperature of the fish compare with that of the water? Allow one specimen to remain for an hour or more in water at a temperature of 70° F.; another in cooler water (50° F.): compare results.

Can the fish detect in the water the presence of substances which have a decided taste to us? Use colorless solutions,—acid, sugar, quinine. Can you get the animal to show any choice as to food?

Note the motions of mouth and eyes. Can the fish see any point with both eyes at once?

*B. External Anatomy.*—(Make careful outline sketches showing all points of structure.)

*The Topography of the Body.*—Note the symmetry; indicate the degree of differentiation of anterior and posterior ends, and of dorsal and ventral surfaces, as shown by the shape, special organs, etc. What structures appear paired? To what degree are head, trunk, and tail clearly distinguishable? Locate and

identify all the external openings. How would you describe the general shape of the body? What are the external evidences of segmentation?

*The Appendages.*—How many paired? Unpaired? Locate: the dorsal, caudal, anal, the pectoral, and the pelvic or ventral. Does the skin of the body extend over the fins? What seems to be the nature of the fin rays? Number? Are the upper and lower lobes of the caudal fin equal or unequal?

*The Covering.*—Does the specimen possess scales? Is there any regularity in their arrangement? Is this constant among several specimens? Is it the same in different species? Are any parts of the body free of scales? Are the scales covered with skin? What is the shape and nature of the free margin of the scales? Examine with a hand lens or low power of microscope. Is there any color? How does this appear under the microscope? Do you distinguish a line (*lateral line*) along one of the rows of scales on the side of the body? Examine one of these scales under the microscope. How does it differ from the others? How many rows of scales above the lateral line? Below?

*The Head.*—What goes to make up the head of the fish? Note position, shape and size of mouth. Find the bony framework: upper jaw (*premaxillaries* in front articulating with *maxillaries* behind); lower jaw (*dentaries*). Are both jaws movable? Locate all the bones which bear teeth? How are teeth arranged? Is there a tongue? Do the nostrils communicate with the mouth cavity?

Eyes: number, position, coverings (lids?), iris, pupil.

Are there any "ears?" Evidences?

*Gills and Gill-coverings.*—How many bones in the gill cover (*operculum*)? Describe the structure at its inner, lower margin. How wide is the isthmus between the right and left gill-openings? Identify and number the gill arches, which bear the reddish gill-filaments, and the gill slits between. With what do the passages between the gill arches communicate? Determine by extending a probe into mouth. How does the inner or pharyngeal side of the gill arches differ from that which bears the filaments? Examine the gills for parasites:

*C. Internal Structure.*—With forceps and sharp scalpel remove a strip of skin an inch wide from one side of the fish, from the belly to the dorsal fin. Note the muscular segments (*myotomes*). Is the line separating two of these a straight line? In what direction do the muscle fibres run?

With scissors cut the body wall along the middle line of the belly from just in front of the anus to the isthmus. Be very careful not to injure any of the organs within the coelom. A portion of the side muscles may be removed on one side or cuts may be made perpendicular to the first so that the sides may be more readily opened. Notice the lining of the body cavity (*peritoneum*). Color? How is the heart separated from the abdominal cavity? (*False diaphragm*.) Sketch the cavities thus laid open and represent the organs as they appear before disturbing them. Has the liver lobes?

Examine more in detail, turning liver to one side.

1. *Digestive Organs.*—Extend probe through the mouth into stomach, and locate: esophagus; stomach, form and position; intestine, its point of origin, course and outlet. About the junction of stomach and small intestine look for finger-like projections from the surface of the gut (*pyloric caeca*). If present, cut one: is it solid or hollow? Examine the membrane (*mesentery*) which holds the intestine in place. To what part of the body wall is it attached? The *spleen*, a dark-red, ductless gland, occurs close to the intestine. Cut intestine an inch from the anus

and the esophagus in front of stomach. Remove, open, and examine interior. Figure differences in different portions. Look for parasites in the tract.

2. *Reproductive and Excretory Organs.*—Find the whitish testes or the yellow or pinkish ovary (or ovaries). Do they possess ducts? Where is the outlet?

Observe position and dimensions of the air-bladder (if present); pierce it and discover dorsal to it the red kidneys. Number, shape, and dimensions of these? Can you find their outlets?

3. *Pericardial Cavity and its Contents.*

Shape and boundaries of the cavity.

Heart: position; portions; ventricle (ventral) and auricle (more dorsal).

From the ventricle the whitish *bulbus arteriosus* passes forward and narrows into the *ventral aorta*. Posterior to the heart is the thin-walled *sinus venosus* which communicates with the auricle.

[The teacher may supplement this work by a demonstration of the ventral aorta with its branches passing to the gills, by means of a larger fish in which these vessels have been injected with a colored mass. See appendix.]

4. *The Nervous System.*—Cut off the head and remove the muscles from the back and top of the skull. Use a strong cartilage knife and gradually slice and pick the bone until the cavity within is well uncovered. Note the loose tissues covering the brain. Remove this with great care.

Beginning in front, identify as you pass backward: *olfactory* lobes, tapering toward the front and communicating with the nasal cavities; *cerebrum*, two oval prominences meeting in the middle line; the two large, rounded *optic lobes*; the *cerebellum*, a single median lobe; and the *medulla oblongata*, which tapers backward into the *spinal cord*. Is there any real boundary between the spinal cord and the medulla, or is the distinction arbitrary? What is the size of the cord where it emerges from the cranium? What is its position in relation to the vertebræ? Have you found any nerves leaving the medulla or the cord? If so how many? Are there any cavities in the brain lobes?

5. *The Eye.*—Remove the bone from above the eye and examine it in position. How is the eye moved in life? Can you discover any of the muscles effecting these motions? How are they attached? What is the shape of the eye? Split it open, and find the lens. Is the lens more or less nearly spherical than you expected?

6. *The Skeleton.*—The general shape and character of the skull and its bones may be seen by boiling the head of another fish and scraping and picking away the flesh. The principal regions are the *cranium* or brain case, the *opercular* bones of the gill covers, and the *facial* bones. Notice the loose way in which the lower jaw is articulated.

Boil a two inch block taken from the tail of the fish until it becomes tender. Notice incidentally the shape of the individual myotomes or muscle segments as they fall apart. Clean the vertebræ of flesh, and study the structure of one of them. Note the *centrum*; the dorsal or *neural arch* and *spine*; the ventral or *hæmal arch* and *spine*. What is the shape of the centrum? What structures occupy the arches? Prepare a trunk vertebra and compare in all respects with the caudal. How are the ribs related to the vertebra? Can you find any evidence whether they are homologous with the hæmal processes?

Are there any bones connected with the fins?

D. *General Questions.*—What internal organs show segmentation? Do they show it equally in all parts of the body? Do the internal organs show bilateral

symmetry as completely as the external? How do you account for the fact? Compare the relative position of the anterior and posterior appendages in as many species of fish as you can secure? What are the habits of the species you have been studying? Feeding habits; spawning and breeding habits? What are its nearest relatives among the fishes?

E. *Studies in Nature*.—Many most interesting and instructive problems present themselves for the student of fishes in their native haunts, if the school is favorably situated. What species are found in the nearby waters? How do they differ in appearance? How in habits of feeding; of swimming; of spawning? What kind of habitat does each prefer? What knowledge must a successful fisherman of a given species have?

342. **The Frog.** (*Rana*).—Any species of frog will serve. For internal anatomy as large specimens as possible should be used. The frog is especially suitable to represent the vertebrates because of its metamorphosis from a water-breathing or fish habit into the air-breathing condition, and the readiness with which the main facts of this metamorphosis may be followed even by an elementary class. Frogs may be kept alive almost indefinitely, even through the winter, by putting them in a deep box covered with netting, in which a pan of water is placed. The bottom of the box should be covered by sod or moss which must be kept moist. Change the water in the pan every few days. Do not place large and small frogs in the same box, as the small ones are more than likely to disappear. Unless living animals, as grasshoppers and the like, can be given them it is scarcely worth while to try to feed them. They seem to do quite as well without food for a reasonable length of time.

A. *The Living Animal* (chiefly physiology).—One or more exercises may well be given to observation of frogs in their native haunts, if the study comes at such time as will allow. You will know enough about the frog to set for discovery a number of interesting things. Keep careful notes of all your questions and your discoveries. If field study is not possible, much can be gained by studying living specimens in the laboratory. Record what you know from observation of the animal's general haunts and habits. To what extent is it a terrestrial animal? Aquatic? What is the natural position when at rest? What are its modes of locomotion on land? Place on the floor, and test. Describe its motions in water, and the use made of

the parts of the body in swimming and in its other methods of locomotion. Can it rest at the surface of the water? How much of the body protrudes from the water? How does it dive? Can you find any evidence that it does anything to increase its specific gravity when diving?

Feed by placing living grasshoppers or flies in the vessel with a frog, or by dangling a piece of meat in front of it at the end of a string. Note the action of the tongue in making the capture. Examine the mode of attachment of tongue, and suggest its possible advantages.

Watch the animal while floating at the surface of water or out of water. Can you detect any signs of breathing? Note carefully the nostrils, the cheeks and the sides of the abdomen, and determine how it gets air into its lungs. Prove your conclusions. Determine what senses are represented in the frog. How does it react to salines, acids, sweets, bitters? Judging from the position of the eyes and from experiment, can a frog on the ground see objects in all directions? Can it do so while floating on the surface of the water? Are the eyes movable? Can the frog see any point with both eyes at the same time? What happens if a frog is placed on his back? Explain. Does the frog seem to have any sense of elevation when he comes to the edge of a table? How do you estimate this? By experiment and by reference determine whether the frog's actions are at all modified by experience.

Select a small frog and chloroform it until quiet, but not enough to kill it. Wrap it in a wet cloth, and place on a support of such height as will allow the web to be stretched over the opening in the stage of the microscope. With the lower power note the pigment cells and blood vessels. Determine which are arteries and which veins; present your evidences. By placing a little water and a cover-glass on the web the high power may be used, and the behavior of the corpuscles studied as they pass through the capillaries. Similar studies may be made on the gills of very young tadpoles.

B. *External Anatomy*.—What is its symmetry? Compare carefully the structure and form of the dorsal with that of ventral surface; similarly those of the anterior and posterior



ends. Compare several individuals as to shape, color markings, size, etc.

General form.

Head, trunk, limbs. Is there any neck?

Anterior appendages: arm, forearm, hand (including digits). Compare with your own hand, and determine which is the first digit, or the thumb side of the hand.

Posterior appendages: thigh, shank, ankle, foot. How many digits? Which is the first? How many joints in each? What other peculiarities are noteworthy?

Special head structure.

Mouth; position, dimensions, degree of extensibility; tongue; teeth, where located?

Sense organs: position of eyes, ears, nose. Do the nasal openings communicate with the mouth? Pierce the tympanic membrane in a dead frog and discover with what the opening communicates.

Cloacal opening.

C. *Internal Anatomy*.—Make a slit in the skin of the ventral surface from a point just in front of the cloaca forward to the throat, a little to one side of the middle line. Make incisions perpendicular to this and turn the flaps back to show the muscles beneath. Is the skin as closely attached to the muscles as in the fish? Do you find myotomes as in the fish? Draw in outline some of the more important muscles of the chest and abdomen. Cut the muscular wall in the same way, passing to one side of the breast bone. Turn back the flaps and sketch and identify the organs in their position in the coelom.

1. *Digestive Organs*.—Pressing the liver aside, identify the following parts of the digestive tube: esophagus, stomach, small intestine, large intestine. Are there any sharp boundaries between these parts?

Compare the lengths of the different portions. Find the *mesentery*, and show its relation to the intestines. What is the relation of the liver to the digestive tube? Find the gall-bladder: does it have any duct leading to the tube? What is

the position of the light colored pancreas? Of the darker spleen (this organ has no duct)?

Cut the large intestine about an inch from the anal opening and the esophagus in front of the stomach; remove the tract from the body. Split it from end to end, wash it of its contents and describe and make drawings of the interior. Do you find any internal parasites?

2. *Urinogenital Organs*.—Without removing any other organs identify:

The kidneys: color, form, position. Do they have any outlet? The bladder; position and general structure.

The fat bodies: position? With what connected?

In the male:

Testes; yellowish, rounded bodies. With what organ connected?

How in a fresh specimen can you be sure you have found the testes?

In the female:

Ovaries, which vary much in size and appearance with the time of year. What are their position and attachments?

Oviducts. Do these communicate with the body cavity?

How do they communicate with the exterior? Is there any trace of the oviducts in the male?

3. *The Lungs*.—Open the mouth, find the *glottis*, insert a blow-pipe, and inflate the lungs: number, position and shape? Cut them open and examine the inner surface.

4. *The Circulatory System*.

The heart: Does this organ lie free in the body cavity? What is the shape of the heart? To what is it attached? Identify the auricles in front, and the ventricle behind. Can you recognize the aorta arising from the ventricle; and the venous sinus dorsal to the heart and receiving the large veins? How many chambers to the heart? Their relation to each other?

Further study can be pursued successfully only by injecting the vessels with a colored mass. If time allows each student may well inject the arterial system and trace its course. At

least a specimen thus injected and dissected by volunteers should be used to demonstrate the three aortic arches (*carotid*, *systemic* and *pulmonary*), the *dorsal aorta* and its chief branches.

5. *Muscle*.—Strip the skin from the leg. Without cutting, separate the muscles from each other, demonstrating their general shape and the tendons at the ends by which they are connected with the bones. The end attached to the least movable bone is the *origin*, the other, the *insertion*. What is the origin and what the insertion of the large muscles of the thigh? Are the muscle fibres plain or cross-striate? (Examine a small bit under the microscope after tearing it apart as much as possible.) These studies may very well be extended to include the muscles of the throat, chest, arm, abdomen, and leg. In all such studies the most important question the student can ask and answer is this: "What does this muscle do when it contracts?" To answer the question one must find the origin and insertion of the muscle, as well as its relation to other muscles. Which are extensor and which reflexor muscles?

6. *Nervous System*.—Remove with great care the skin, muscles and bone from the roof of the skull so as to expose the brain. Continue backward and expose the anterior portion of the spinal cord. Sketch, as it appears from above, and identify, beginning with the anterior end:

Olfactory lobes.

Cerebral hemispheres; number, size, form. Are they separate?

Optic lobes.

Cerebellum; a narrow transverse band.

Medulla oblongata, tapering into the spinal cord.

Examine the nerves arising from the spinal cord. Look within the body cavity also for these. What is their position in relation to the vertebræ? How many pairs can you discover? Does each arise by a single or double root? Find the large nerve (*sciatic*) which is the chief nerve of the hind leg. How many spinal nerves enter into the formation of it? Identify a similar *plexus* in connection with the front leg. Seek the sympathetic ganglia in body cavity on either side of the backbone.

Dissect the bone and muscle from one side of the skull, showing the cranial nerves. Begin at the anterior end and identify: (1) the olfactory nerve; cut, and lift the brain slightly, showing (2) optic nerves. Cut these as far from the brain as possible.

Note other smaller nerves and cut these. How many are there? From what part of the brain do the majority of them arise? Do the optic nerves join at the point where they enter the brain?

7. *Skeleton*.—Pick the bulk of the flesh from the bones of an uninjured skeleton. Boiling will be of advantage in the final stages of cleaning. Identify the *axia*

*skeleton* and the *appendicular*. Do the appendages unite directly with the axial skeleton? If not, what? Count the vertebræ. To what extend fo they differ? Can they be grouped into regions? Select a typical one, and draw from various positions to show structure. Do any bear ribs? Describe the posterior bone in the series. Identify the parts of the anterior and posterior limbs and girdles by referring to Fig. 161, and see to what extent they depart from the type described there. Make outline sketches of all the bones of the right girdles and appendages. What is the nature and action of the various joints of the limbs? In the skull notice how small a portion is brain-case. How is the great width of the head secured? How is the lower jaw related to the skull? Make a sketch showing the proportions of these various parts. In what position are teeth borne? Examine the sternum or breast bone. How related to the girdle? Of what parts is it composed. How much of it is cartilaginous?

8. *Development*.—Eggs of frogs and toads may be found in the early spring in ponds or sluggish streams, floating or attached to submerged objects. They occur in slimy strings or masses, each egg enveloped in a jelly-like covering. Transfer these to the laboratory, and keep covered with water in a shallow vessel. Change the water frequently, and keep a close watch on the changes which the eggs undergo. After hatching keep a few water plants in the vessels for the tadpoles to eat.

Note appearance of the egg (with low power of microscope).

Gelatine: outer layer, not really a part of the egg.

Fertilized ovum; the darker interior sphere, of protoplasm and yolk.

If the eggs are recently laid, the beginning of segmentation will furnish an interesting demonstration for the class. How are the first cleavage planes related to each other?

If more advanced, note especially: the gradual elongation of the embryo, the enlargement of the head, development of the tail, hatching, the external gills. What becomes of the gills? Do you find any trace of mouth, eyes, nasal openings? Where do the legs first appear? What becomes of the tail? Prove. Tadpoles of all ages may usually be found in the shallow ponds late in spring. These should be compared with those reared in the laboratory. Dissect one of the larger tadpoles, and examine particularly the intestine and the gill chamber.

343. Compare with the frog any other amphibian types which can be found,—as the toad, the newt, or the salamander. Note especially the differences in habits, haunts, external form, appendages, method and time of depositing eggs, the form of the tadpoles, etc.

## DESCRIPTIVE TEXT

344. **General Characters**.—In common with the simpler Chordata thus far considered the Vertebrata are bilaterally symmetrical Metazoa with a cœlomic cavity, a notochord derived from the entoderm, gill-slits at some stage of life, dorsal nerve tube and a ventral heart. In addition, the following points may be given as distinguishing the true vertebrates:

1. Notochord surrounded by a sheath of tissue derived from the mesoderm, thus producing around the notochord the internal

skeletal axis, the centra of the vertebræ, composed either of cartilage or bone (Figs. 156-158).

2. Outgrowths from these centra extending dorsally to protect the nerve tube, and ventrally to protect the viscera (Fig. 159).

3. Several sets of organs with varying degrees of metameric segmentation: *e.g.*, vertebral column; muscular system; nervous system.

4. Jointed appendages having a central skeleton never exceed two pairs; one pair or both of them may be rudimentary or wanting.

5. Respiratory system developed in connection with anterior end of digestive tract.

6. Heart with at least two chambers and the blood containing red corpuscles.

345. **General Form.**—While varying greatly in form, vertebrates are typically elongated animals with the mouth at or near the anterior extremity of the long axis. The position of the anus is variable. It may be one-half the length of the body from the posterior end. The body is roughly divisible into *head* and *trunk* with or without an intervening *neck*. The neck is more pronounced in the land than in the water forms. Posterior to the trunk containing the body cavity, there may be a *tail* into which the skeleton is continued but which is destitute of a body cavity.

Bilateral symmetry is shown by the paired condition of the eyes, ears, and other external and, to a less degree, internal organs. Metamerism on the contrary is much more evident from the internal than from the external organs. There are usually two pairs of lateral appendages for support and locomotion: the *thoracic* at the anterior end of the trunk, and the *pelvic*, ordinarily occurring near the union of the trunk and tail. These are variously modified as to their form and internal structure (*e.g.*, fins, legs, arms, wings), but are looked upon as homologous. In many water forms there are median appendages (dorsal, ventral, and caudal fins) also assisting in locomotion. The coelom or body cavity is well represented in the trunk region, and arises by a splitting of the mesoderm into

an inner layer which comes to unite with the digestive tract and an outer layer which unites with the ectoderm (Fig. 156). In this—the *visceral* cavity—beside the mesoderm-covered digestive tract to which reference has already been made, lie the principal organs of respiration, of excretion, of circulation, and of reproduction. Dorsal to the notochord the nervous system occupies a cavity within the mesoderm, which is not, however, a part of the cœlom. This is described as the dorsal or *neural* cavity and is protected by a sheath of cartilage or bone. In the anterior region this is much enlarged to accommodate the brain. This condition of a dorsal and ventral cavity is very characteristic of vertebrates. In mammals the ventral cavity is further divided by the diaphragm into an anterior or thoracic and a posterior or abdominal cavity.

346. **Protective and Supportive Structures—the Integument.**—Covering the body of vertebrates is the skin, which consists of two layers;—the outer, or epidermis, which is derived from the ectoderm, and the dermis or true skin which is mesodermal in origin. The epidermis consists of from two to many layers of cells in thickness, and in the higher forms the differentiation into layers becomes very pronounced (Fig. 155, *E*). The outermost cells of the epidermis frequently become hardened for the better protection of the parts within. This is especially true of the terrestrial forms. The inner layer of the epidermis is usually columnar in form, and from this layer the outer cells are renewed, and all special epidermal growths arise (Fig. 155, *c.e.*). The dermis consists largely of connective tissue, but contains in addition nerves and blood vessels beside such ingrowths from the epidermis as glands, hair-follicles, etc. Fat is deposited in the lower layers of the dermis in many vertebrates.

347. **Special Products of the Integument** often occur in the form of outgrowths or ingrowths. Glands are examples of the latter, and are frequent in connection with the epidermis. They may be simple and unicellular (mucous glands in fishes) or multicellular, penetrating deep into the dermis (sweat and oil glands, Fig. 155, *sg*). The mammary glands of Mammalia are possibly modified forms of the sweat glands. The outgrowths

may be purely epidermal, as in hair, feathers, nails, hoofs, claws, and the scales of some reptiles; or in other instances the principal structures are formed in the dermis, usually with an outer layer

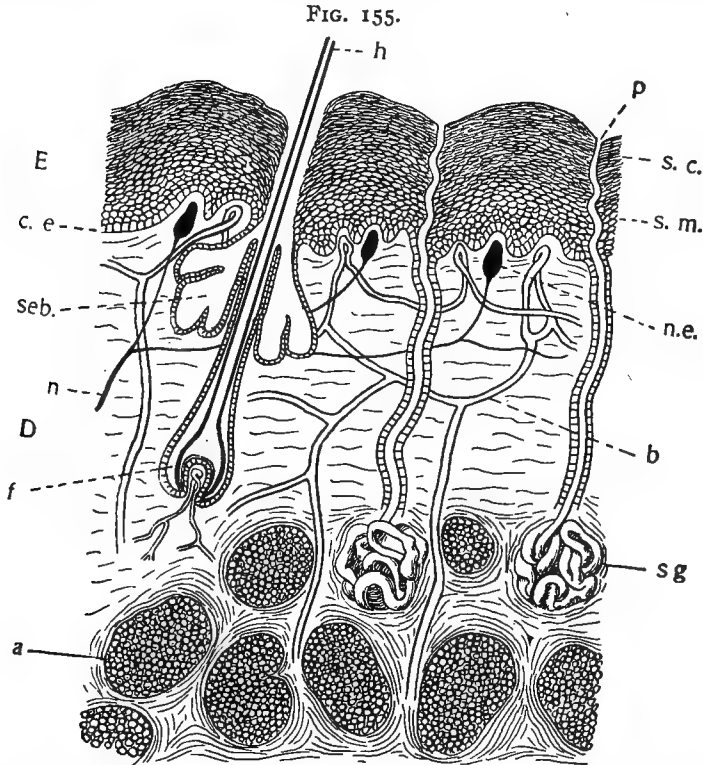


FIG. 155. Diagram of the skin in Mammals, showing the multiple layered condition, together with outgrowths and ingrowths. Drawn by Dr. J. W. Pilsom. *E*, epidermis; *D*, dermis; *a*, adipose tissue,—fat deposited amid the connective tissue; *b*, blood vessels; *c.e.*, columnar epithelial layer of the epidermis; *f*, hair follicle; *h*, hair; *n*, nerve; *n.e.*, nerve ending (sensory corpuscle); *p*, pore of sweat gland; *seb.*, sebaceous or oil gland of hair; *s.g.*, sweat gland; *s.c.*, horny layer of epidermis; *s.m.*, mucous layer of epidermis.

**Questions on the figure.**—What suggests that the columnar layer of the epidermis is the most vitally important layer? Are the hair and glands dermal or epidermal growths? Which structures found in the dermis seem to be invasions of that layer by outside structures? What are the functions of the various layers of the skin? Which parts are ectodermal and which mesodermal in origin?

contributed by the epidermis, as in the teeth or the scales and bony plates which form in many instances (turtle, armadillo, etc.), a very complete external skeleton. Some of the bones

of this external, or dermal, skeleton persist even in the highest forms (*e. g.*, man) and unite with bones of the internal skeleton, as in the formation of the cranium and the facial bones.

The most apparent function of the skin is protection. The outgrowths (hair, scales, claws, etc.), evidently increase its adaptation to this function. In addition, the skin is partly respiratory and excretory. The glands represent a specialization of this latter function. It is also sensory, and in an indirect way assists in regulating bodily temperature, especially in the warm-blooded types.

348. **The Skeleton.**—Attention has already been called to the exoskeleton as the derivative of the skin. The endoskele-

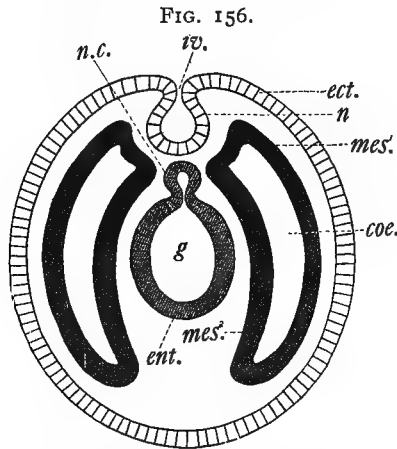


FIG. 156. Diagram of transverse section through embryo of a Vertebrate, showing the mode of origin and the relations of the notochord, nervous cord, ectoderm, entoderm and mesoderm (see also Fig. 15). *coe.*, coelomic pouches; *ect.*, ectoderm; *ent.*, entoderm; *g*, lumen of the gut; *iv.*, invagination of ectoderm which forms the nerve cord (see *c*, in succeeding figures); *mes¹*, somatic or body mesoderm; *mes²*, splanchnic mesoderm, that portion of the mesoderm which becomes allied with the entoderm; *n*, the nerve (spinal) cord; *n.c.*, notochord, arising by an outpocketing of the entoderm.

ton is surrounded by muscles separating it from the integument. In general it may be said that these two bony systems supplement each other. In the higher forms where the internal skeleton is best developed the exoskeleton is usually reduced to a minimum. Elements from both sources may become fused in the formation of a single structure (the skull; the carapace of the turtle). A difference between the internal and the



external skeleton is in the fact that bone of the former is typically formed in and around cartilage, whereas in the latter there is no cartilage. The internal skeleton consists of two portions, (1) the axial, embracing the vertebral column, and (2) the appendicular, or that supporting the appendages.

As was seen in the arthropods the chief functions of skeletons are to protect and support soft parts, and to furnish hard lever-ages for muscular attachment. It is clear that any rigid skeleton which entirely surrounds an elongated animal must have some breaks or articulations in it. We found this to be true in Crustacea and insects. Similarly in the internal skeleton in vertebrates, the attached muscles would be useless if there were no joints. It is clear that solid bones coming together in a joint with the muscles external to them will make a stronger articulation than hollow shells coming together like the segments of a stovepipe. The arthropod joint is effective for small animals but would not meet the needs of the large vertebrates.

349. **Axial Skeleton.**—In its simplest condition this consists of the notochord which it will be remembered is derived from the entoderm and lies between the alimentary canal and the spinal cord (Fig. 156). In the true vertebrates, cells arising from the mesodermal pockets on either side (Fig. 158) produce a continuous skeleton-forming sheath about the notochord. From the cells of this sheath are developed, finally, rings of cartilage or bone about the notochord (*centrum*; plural, *centra*, Fig. 159, *c*) and about the spinal cord (*spinous processes*, Fig. 159, *na*). These, with certain other growths, constitute the typical vertebræ. In this process the notochord often becomes obliterated by the developing vertebræ. To each vertebra may be attached a pair of ribs, which protect the ventral structures, somewhat as the neural arch protects the nerve cord. The ribs of fishes and of the higher forms are not considered to be homologous structures (Figs. 159, 160).

The axial skeleton varies from this typical condition in different parts of its course. In the head region, for example, the nervous cord is immensely enlarged and the neural arches are much modified, being replaced by plates and supplemented

by the dermal bones. The following regions may be described as typical:

1. Head region (skull) embracing the *cranium* or brain case and its associated ventral arches including the bones of the face.
2. Cervical vertebræ, located in the neck and lacking ribs. Usually the anterior one or two are considerably modified.

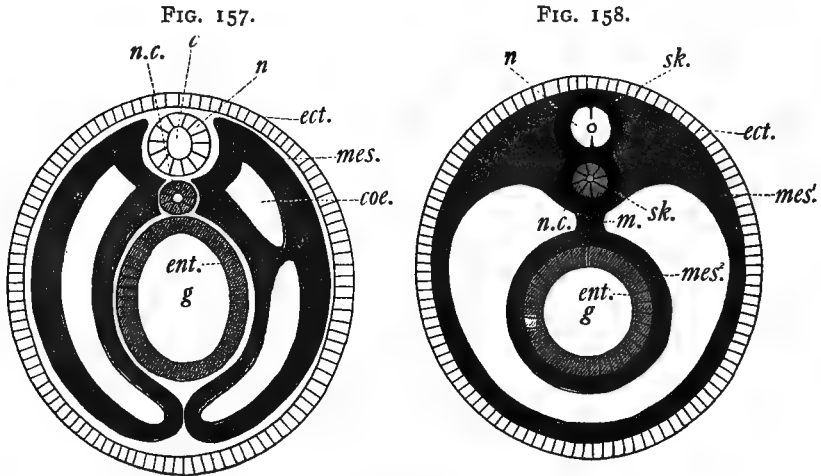


FIG. 157. Diagram similar in position and lettering to Fig. 156, at a later stage. *c*, central canal of spinal cord.

FIG. 158. Transverse section of an embryo Vertebrate at a stage later than Fig. 157. *m*, mesentery; *sk.*, the beginning of the mesodermal skeleton which surrounds the notochord (*n.c.*), and in part the spinal (nerve) cord, *n*.

Questions on the figures 156 to 158.—How does the mesoderm originate in vertebrates? Trace its gradual growth and differentiation in the figures. What two principal portions are to be distinguished? How does the notochord arise? How the spinal cord? What is the source of the cavity of the spinal cord? From which of the three layers does the protecting skeleton arise? What does the mesentery connect? What other organs might be expected in the coelom, if it were the purpose to make a complete diagram of the visceral organs?

3. Dorsal vertebræ, in the thoracic region and bearing well-developed ribs which may unite with a ventral bone, the sternum.

4. Lumbar vertebræ, following the dorsal vertebræ and not bearing ribs.

5. Sacral vertebræ, usually a small number of vertebræ, frequently fused into one piece with which the girdles of the posterior appendages unite.

6. Caudal vertebrae, posterior to the sacrum and possessing no ribs.

The number of bones in these regions is very variable in the phylum as a whole, but, in the higher forms particularly, individuals of related species present remarkable uniformity.

(The discussion of the condition of the skull and the origin of its parts is entirely too technical for an elementary text. The student should refer to more advanced works.)

FIG. 159.

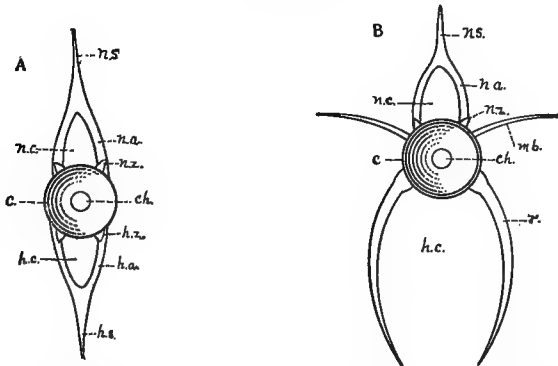


FIG. 159. Diagram of vertebræ of a bony fish. *A*, caudal; *B*, trunk. *c.*, centrum or body of the vertebra; *ch.*, the notochord; *h.a.*, hælmal arch; *h.c.*, hælmal canal; *h.s.*, hælmal spine; *h.z.*, hælmal zygapophysis, or articulating facet; *m.b.*, inter-muscular bone; *n.a.*, neural arch; *n.c.*, neural canal; *n.s.*, neural spine; *n.z.*, neural zygapophysis; *r.*, rib.

**Questions on the figures.**—What is the meaning of hælmal? Of neural? In life what occupies the neural canal? What occupies the hælmal canal in the caudal region? In the trunk region? Is there anything to suggest that the ribs in fishes are homologous with the processes which form the hælmal arch (*h.a.*)?

**350. The Appendicular Skeleton.**—Here are embraced the skeletal parts of the appendages proper, together with the bones binding them to the axial skeleton (*girdles*). Each girdle may be said to consist typically of three bones, uniting to form a joint with the first bone of the limb. One of these is dorsal and the others ventral (Fig. 161, *B*; *il*, *is*, *p.*). The appendages are much alike both as to their girdles and the limbs proper. The posterior is, in higher forms, more intimately fused with the axial skeleton, thus securing greater strength at the expense of freedom of motion. The first joint of each appendage consists of one bone (arm or thigh); the second, of two (forearm or

shank); then follows a region of several small bones (wrist or ankle), succeeded by the hand or foot with five (usually) bones, and then by five digits (fingers, toes) of a varying number of joints. The accompanying diagrams (Fig. 161) will make clear these relations, as well as the names of the bones. Bones may disappear or fuse with others in such a way as to cause wide variation from this type; indeed the type is perhaps never realized in any single animal. In fishes the appendage and the girdle are often very simple, the limb being little more than

FIG. 160.

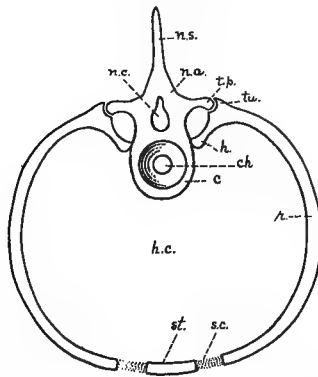


FIG. 160. Diagram of a trunk vertebra in a Mammal. *c*, centrum; *ch.*, position originally occupied by the notochord; *h.*, head of the rib; *h.c.*, hæmal cavity; *n.a.*, neural arch; *n.c.*, neural canal; *n.s.*, neural spine; *r.*, rib; *st.*, sternum; *s.c.*, sternal cartilage uniting ribs and sternum; *t.p.*, transverse process of vertebra; *tu.*, tubercle of rib.

**Questions on the figure.**—Compare all the parts here with corresponding ones of Fig. 159: *A*, *B*, and note the differences. What is gained by the articulation of ribs with a sternum? What is lost? In which groups of Vertebrates is a sternum found? In which are fully developed ribs found?

radiating fin-rays covered by a membrane (Figs. 177, 178). Yet it is believed that from some such primitive condition the more specialized appendages have arisen.

351. **The Digestive Organs.**—As in many of the invertebrates which we have studied, the alimentary canal in the vertebrates possesses an anterior, ectodermal portion (stomodæum), a mid-gut lined with entoderm (mesenteron), and a posterior ectodermal part (proctodæum). The tract is lined throughout with a mucous membrane. Outside of this are the

FIG 161.

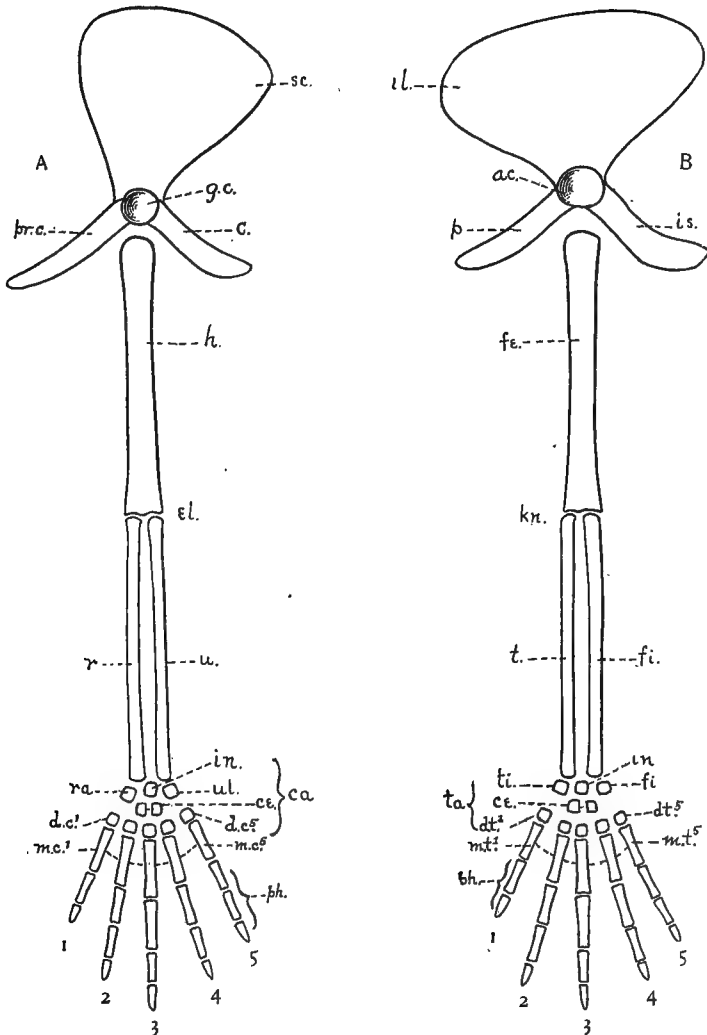


FIG. 161. Diagrams of the girdles and appendages in a typical Vertebrate. *A*, anterior; *B*, posterior. *ac.*, acetabulum, articulation of the humerus with its girdle; *c.*, coracoid; *ca.*, carpals; *c.e.*, centralia; *d.c.*, distal carpals; *d.t.*, distal tarsals; *el.*, elbow joint; *f.*, fibula; *fe.*, femur; *fi.*, fibulare; *g.c.*, glenoid cavity, articulation of arm with girdle; *h.*, humerus; *il.*, ilium; *in.*, intermediale; *is.*, ischium; *kn.*, knee joint; *m.c.*, metacarpals (1-5); *m.t.*, metatarsals (1-5); *p.*, pubis; *ph.*, phalanges (1-5); *pr.c.*, precoracoid; *r.*, radius; *ra.*, radiale; *sc.*, scapula; *t.*, tibia; *ta.*, tarsals; *ti.*, tibiale; *u.*, ulna; *ul.*, ulnare.

Questions on the figures.—Compare the two appendages throughout and note the corresponding bones. How much is girdle? How much appendage proper? How many carpals? Tarsals? Which are proximal? Which distal? How do

the phalanges differ? Which is the thumb? How can you be sure? Compare this figure with figures (in reference texts) of the appendages, both front and rear, of the frog; of some bird; or some carnivore; of the horse; of man. Where are the greatest variations, *i.e.*, which bones depart most from this typical condition?

layers of unstriped muscle fibres, circular and longitudinal, by which the food is forced onward. The muscles are especially developed in certain regions, as in the stomach. Outside of all these, in the portion passing through the body cavity, is the serous membrane derived from the mesoderm, a portion of the lining of the body cavity. The mucous surface which is, naturally enough, the important portion in digestion and absorption may be increased by the lengthening of the tube as a whole or by means of outgrowths (the glands) or by ingrowths (folds of various kinds). The highly nourished condition of the entodermal sheet of cells presumably leads to their rapid growth and foldings. The folds are often so arranged across the axis of the tube as to retard the progress of the food through the tract, thus making digestion and absorption more complete, by increasing the time during which the food is exposed to the action of the digestive juices, and to the absorbing surface.

352. **The Divisions of the Tract.**—The mouth, which may be either terminal or ventral, opens into the *buccal cavity*, which is bounded dorsally by the floor of the brain case, on the sides and in front by the jaws, and ventrally by a muscular floor from which the tongue arises as a fold. The jaws are made up of bony elements from two sources; a core of bones from the internal skeleton (the first visceral arch) and a covering of dermal bones which fuse with it. The latter are the bones which (typically) bear the teeth. Teeth however occur in the lower vertebrates in the roof of the mouth or on the tongue. Their place may be taken by horny epidermal structures, as in the beak of birds. When present the salivary glands open into the mouth cavity. Posteriorly the buccal cavity communicates with the *pharynx*, which may be defined as the part of the digestive tract in connection with which the lungs or gills are developed. In fishes and in the embryos of higher forms there are slits in the side walls connecting the pharynx with the outside. Gills are developed in the walls of these slits. In forms above fishes the

slits become closed as the embryo develops. Above the Amphibia they never bear gills.

The *esophagus* is a narrow muscular tube of varying length

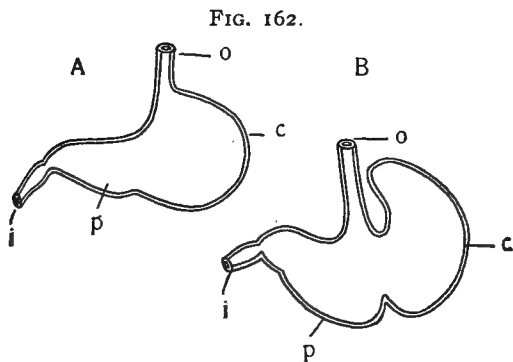


FIG. 162. Stomach of Dog (A) and of Rat (B). *c*, cardiac portion; *p*, pyloric portion; *o*, esophagus; *i*, intestine.

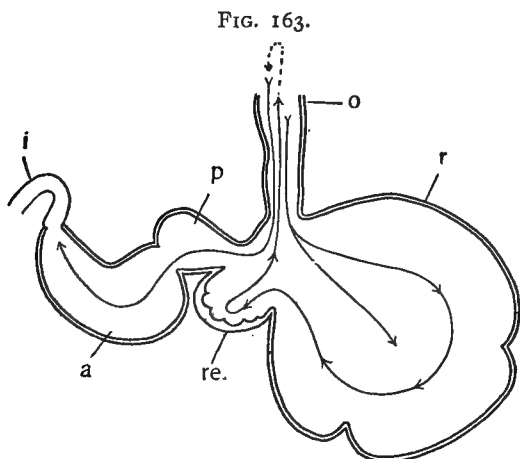


FIG. 163. Diagram of the stomach of a ruminant. *o*, esophagus; *r*, rumen or paunch; *re.*, reticulum, or honeycomb; *p*, psalterium or manyplies; *a*, abomasum or rennet; *i*, intestine.

Questions on figures 162 and 163.—Taken as a series, what is illustrated by the three diagrams? What do the arrows indicate? What is known of the function of the various portions of the ruminant stomach?

leading to the stomach. In birds an enlarged portion of it (the *crop*) may serve for the temporary storing and softening of the food.

The *stomach* is usually well differentiated and may consist of one chamber or of several. In the latter case there is a division of labor among the parts. One portion may be highly muscular and supplied with a hardened internal lining for grinding the food (gizzard of fowls, Fig. 164); in such instances another portion is glandular. In the ruminants (ox, deer, etc.), there are four chambers in the stomach (Fig. 163). The gastric glands produce an acid secretion which contains certain enzymes acting chiefly on protein foods.

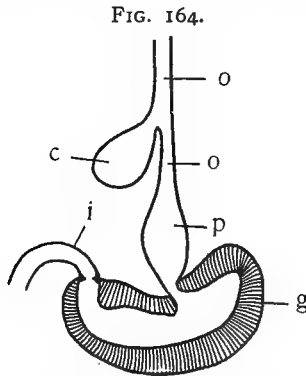


FIG. 164. Diagram of the stomach and esophagus of the Fowl. *o*, esophagus; *c*, crop; *p*, proventriculus or glandular stomach; *g*, gizzard or grinding stomach; *i*, intestine.

**Questions on the figure.**—Compare this figure with that of the stomach of ruminants as to complexity. What are the functions of the various portions? What changes take place in the gizzard of flesh-eating birds if they are forced to live on grain? Why is the crop located outside the cavity inclosed by the ribs?

The food is retained in the stomach by means of a circular (*sphincter*) muscle at its posterior end where it narrows into the *intestine*. This latter portion is the principal digestive and absorptive portion of the tract and varies much in length in the various groups in accordance with the nature of the food used,—the vegetable feeders for the most part possessing the longest intestines. Numerous circular or spiral folds of the mucous membrane occur in the intestine. Special absorptive organs (*villi*) supplied with blood and lymph vessels may cover these folds. Near the anterior end the ducts of the liver and pancreas open into the intestine. The liver is the largest



of the glands, and the pancreas one of the most important in digestion. The intestine may open directly on the exterior (most mammals), or into the ectodermal pocket (*cloaca*) which also receives the excretory and genital products (reptiles and birds).

**353. Exercises for Field and Library.**

1. What difference have you observed in the number, position, and kinds of teeth in the various vertebrates of your acquaintance?

2. Can you cite from your observation any evidences of special adaptation of the parts of the digestive tract to the peculiar food and habits of the animal possessing it? Supplement by library references.

3. To what extent is food prepared in the mouth, *i.e.*, antecedent to swallowing, in the various vertebrates whose habits you have observed?

**354. Respiration.**—As in all higher animals there are two things to be considered in the respiration of vertebrates: (1) the exchange, between the blood and the external medium, air or water, of carbon dioxide for oxygen, which may be called *external* respiration, and (2) the exchange by which the blood gives the cells of the body oxygen and receives their carbon dioxide, or *internal* respiration. The former is usually meant when the simple term respiration is used, though the latter is really the vital process. A certain amount of respiration takes place through the skin in almost all vertebrates. Beside this, special devices—both gills and lungs—are developed by which the blood and the medium containing the oxygen are brought into closer relation. In fishes and larval amphibians gills are present; in most adult amphibians and in reptiles, birds, and mammals, only lungs occur.

Gills are thin-walled external folds or groups of filaments bounded by a mucous membrane, in which the blood circulates freely. In vertebrates they are found on the wall of passages leading from the pharynx to the outside (gill-slits). The water passes into the mouth and out over the gills, through the thin walls of which the gases are exchanged. The walls between the slits may be supported by cartilages or bones (*visceral* or *gill-arches*). The gill-slits ordinarily vary from four to eight in number. In the higher, air-breathing vertebrates traces of the gill-slits appear in embryonic development, but they never bear gills. (See Figs. 32, 33.)

355. **Lungs** arise as out-pocketings of the ventral wall of the pharynx. These may persist as relatively simple sacs, as in the frog, or by great growth and folding they may become very complicated, and thus increase their surface to a wonderful degree. They are lined throughout with the entodermal epithelium. The blood capillaries are in contact with this layer and through these thin walls the gases are exchanged. The outer surface of the lung is covered by the *pleura*, the lining of the body cavity. The tube connecting the pharynx with the body of the lung is known as the *trachea*. The upper or anterior end of the trachea is modified into a chamber known as the *larynx* in the air-breathing vertebrates. The *epiglottis* closes the opening (*glottis*) from the pharynx into the larynx, whenever food is passing from the mouth through the pharynx into the gullet. On account of the presence of currents of air passing in and out and capable of producing vibration, certain portions of the tract are used in making definite sounds whereby the animals are put into communication with their kind. The parts so used are the lips, teeth and vocal cords. The latter are membranous folds in the mucous lining of the larynx, which may be brought into such a position as to close that organ, in part, to the escaping current of air. The tense edges of the membrane are put into vibration. The resulting sound, reinforced or otherwise modified by the other organs, is *voice*. Voice has considerable evolutionary significance in animals.

356. **Supplementary Exercises for Library.**—Where does the “swim-bladder” in fishes occur? Is anything known of its function? Is anything like a lung known among the fishes?

What are the most important differences between the “voice-box” of mammals and that of birds? Have all the vertebrate groups vocal organs? Do they all have voice? What is the difference between voice and speech? What are the uses of voice to animals possessing it?

357. **Circulation.**—The blood in vertebrates contains both colorless and colored (red) corpuscles. The red coloring matter (*hæmoglobin*) has an affinity for oxygen and thus be-

comes a vehicle for transporting it. The colored corpuscles have no motion of their own, but are carried by the blood currents. The colorless cells are much less numerous than the red and have power of independent motion (amœboid). The fluid in which the cells float is called the *plasma* and carries the food and waste materials of the body in solution.

The muscular heart always consists of at least two chambers, (1) an *auricle* which receives blood from the *veins*, and

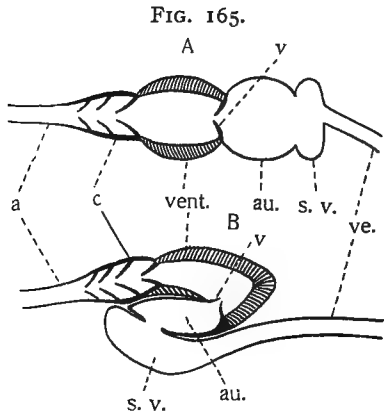


FIG. 165. Diagrams of the structure of the heart in the lower Vertebrates. *A*, primitive condition; *B*, the position of the parts in the fishes. *a*, artery; *au.*, auricle; *c*, conus arteriosus with valves; *s.v.*, sinus venosus; *v*, valves; *ve.*, vein; *vent.*, ventricle. The dorsal portion of the heart is toward the bottom of the figure.

**Questions on the figure.**—Which side of the figure represents the anterior? Compare the walls of the vessels. Where are the valves located? How is the term “sigmoid flexure” appropriate to the form in *B*? Notice how it results in what is morphologically the posterior portion of the heart becoming anterior. Trace the course of the flow of the blood.

(2) a *ventricle* which has thick walls and propels the blood into the *arteries*. Morphologically the auricle is the posterior portion of the heart (Fig. 165, *A*), but in development the heart has undergone an *s*-shaped bending which has brought the auricle in front of the ventricle (Fig. 165, *B*). The veins and arteries are often specially enlarged and modified in the region of the heart. The main trunk leaving the heart is called the *aorta*. As the vessels extend from the heart they branch and become smaller and the walls become thinner. The final

divisions are the *capillaries* through the thin walls of which the blood exchanges materials with the tissues (Fig. 34, *c.s.*; *c.r.*). The capillaries unite to form the smaller veins and these

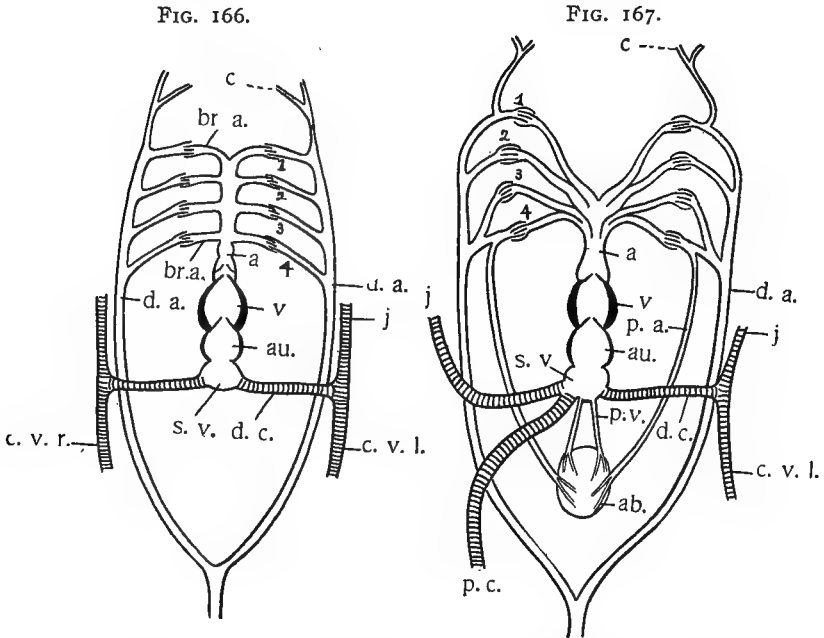


FIG. 166. Diagram of the heart, the branchial arches, and the principal veins in the Teleosts. Ventral view. The heart is represented without the sigmoid flexure; that is, with the auricle posterior. The same is true of Figs. 167 to 170. *a*, aorta; *au.*, auricle; *br.a.*, branchial arches of the aorta (1-4, numbering from the front); *c*, carotid; *c.v.*, cardinal veins (right and left); *d.a.*, dorsal arteries; *j*, jugular veins; *d.c.*, ductus Cuvieri; *s.v.*, sinus venosus; *v*, ventricle. Only four arterial arches are shown.

**Questions on the figure.**—Refer to the table on page 344 and identify the parts there described. Compare this figure with those following (Figs. 167-171). Compare also with Figs. 181 and 182, Ch. XX. Which is the anterior and which the posterior portion of this and the following figures?

FIG. 167. Diagram of heart and branchial arches in *Ceratodus* (one of the *Dipnoi*). Position and lettering as in Fig. 166. *a.b.*, air bladder (lung); *p.a.*, pulmonary artery; *p.c.*, post caval vein (right); *p.v.*, pulmonary vein.

**Questions on the figure.**—What organs appear in this diagram which are not present in Fig. 166? What changes of the various portions do you note in comparing the two figures?

uniting, complete the circuit back to the heart. It is evident that the capillaries are the most important portion of the system, the part for which the rest in reality exists.

In all the vertebrates there are certain structures called *ductless glands*. These are always well supplied with blood vessels. They seem to manufacture and to pour into the blood

FIG. 168.

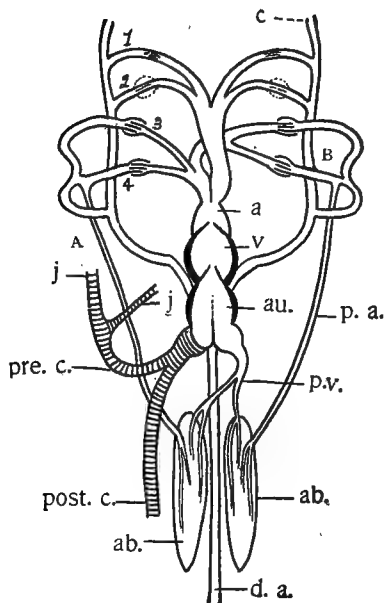


FIG. 169.

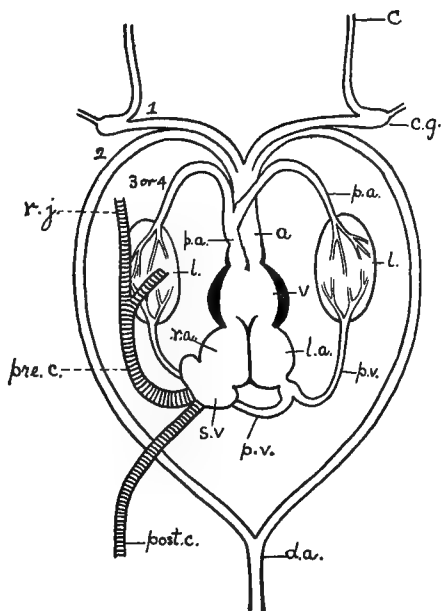


FIG 168. Diagram of the heart and branchial arches in Protopterus (one of the Dipnoi). Position and lettering as in the preceding. *pre.c.*, precaval vein, made up of right and left jugulars subclavians, etc.; *post.c.*, postcaval, made up of the cardinals, right and left.

**Questions on the figure.**—What are the chief differences between the conditions here and in the preceding figures: (1) as to the heart; (2) as to arteries; (3) as to veins; (4) as to lungs?

FIG. 169. Diagram of the heart and branchial arches in the Frog. *c.g.*, carotid gland; *l.*, lungs; *l.a.*, left auricle; *r.a.*, right auricle.

**Questions on the figure.**—How does the heart differ from that of the Dipnoi? How many branchial arches of the aorta are shown? What evidences can you find by comparison that the pulmonary arch is derived from the 3d or 4th branchial? What evidences that the carotid and systemic are the first and second respectively? Compare with the table on page 344. Is there anything to indicate that the impurest blood in the heart will go to the lungs?

directly certain secretions that have effect on even remote parts of the body. These glands may properly be discussed as a part of the circulation since they have no other outlets. These

secretions are called *hormones* or *internal secretions*. The *spleen*, the *thyroid*, the *thymus*, *adrenal bodies*, and *pituitary body*, are the chief ductless glands.

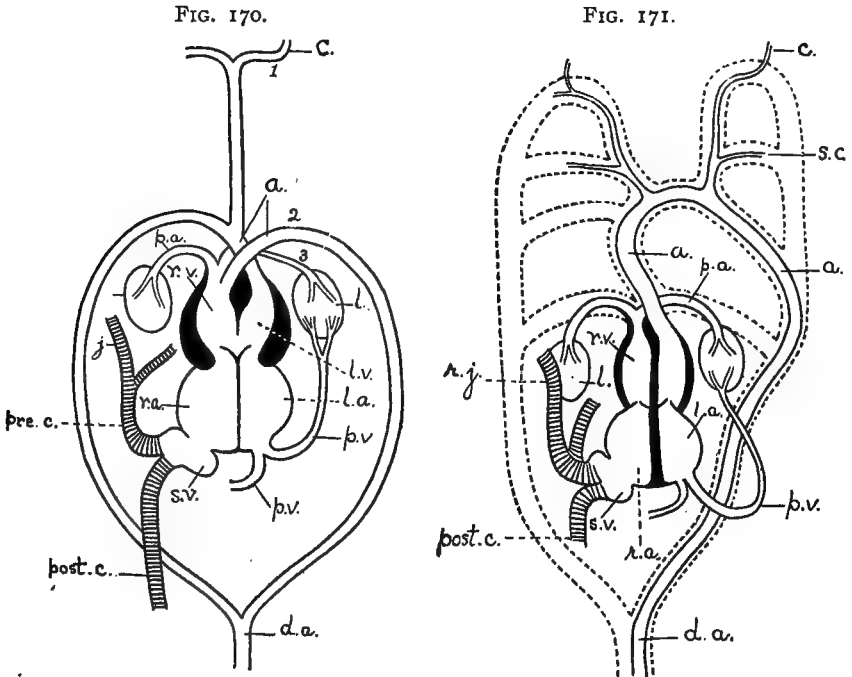


FIG. 170. Diagram of the heart and branchial arches in a Reptile. Position and lettering as in preceding figures. *l.v.*, left ventricle; *r.v.*, right ventricle.

**Questions on the figure.**—Compare this with figures 166–169 and make a note of the differences. How much communication is there between the two sides of the heart? What tends to insure that the purest blood in the heart shall go to the head? That the least pure goes to the lungs?

FIG. 171. Diagram of the heart and the branchial arches in Mammals. A dotted-outline of the arches of the Fish is drawn for ready comparison. The auricles are represented in a posterior position, as in the preceding figures.

**Questions on the figure.**—What changes in the heart are shown in this as compared with former figures? In the systemic branchial arch? Remember that the heart is not represented in its normal position; the auricles are really at the anterior of the heart (see Fig. 166). Compare this condition with table, page 344. What are the grounds for believing that the auricles are, morphologically, the posterior part of the heart?

The spleen is a dark body on the mesentery near the beginning of the small intestine. In its cavities old red blood cor-

puscles are broken down, and probably white blood cells are produced. The thyroid and thymus glands are paired glands which are developed in the neck in relation to the embryonic branchial arches. The function of the thymus is obscure. There is iodine in the thyroid secretion. In man the disease or removal of the thyroid produces serious disturbances in development. It may produce physical degeneracy and deformity, and idiocy.

The adrenal bodies are placed near the kidneys, as the name indicates. They secrete into the blood a substance known as *adrenalin* which among other things causes the muscles around the blood vessels to continue in a state of contraction. In this way the blood pressure is controlled. Removal produces derangement of functions and death.

The pituitary body is in part a ventral outgrowth from the floor of the brain (see *inf.*, Fig. 172, *B*). This fuses with tissues arising from the pharynx. Excess or deficiency of the secretion of this organ causes changes in the growth rate of certain organs and in a number of the metabolic processes. Removal of the organ in dogs causes functional disturbance and death within a fortnight.

In connection with the developing and mature gonads (testes and ovaries) internal secretions are developed which, operating in connection with other endocrines, cause the normal development of the male and female organism. All of the distinctive bodily or mental qualities of males and females seem to be the product of these secretions.

358. In Figs. 166 to 171 will be found diagrams of the circulation in the principal groups of vertebrates. It will be seen that there is a progressive complication of the structure, involving the heart, veins, and arteries, as we ascend the scale. These changes accompany and are partly caused by the change from gills to lungs. See also the accompanying table. Locate the vessels and trace the changes indicated by means of larger texts.

359. In fishes the blood passes through the heart only once in making the circuit of the body. In all the air-breathing

TABLE SUMMARIZING THE COMPARATIVE CONDITION OF THE CIRCULATORY SYSTEM IN VERTEBRATES

	PRIMITIVE CONDITION	FISHES	AMPHIBIA	REPTILES	BIRDS AND MAMMALS
Heart.	Auricle. Ventricle.	One, + (sinus venosus). One, + { Conus arteriosus } { Bulbus "          " }	Two; right and left. One. Wanting. Wanting. Carotid.	Two. Partially separated. Wanting. Wanting. Carotid.	Two. Completely separated. Wanting. Wanting. Carotid.
	First visceral arch; mandibular. Second visceral arch; hyoid. Third visceral arch; first branchial. Fourth visceral arch; second branchial.	Persists in elasmobranchs as spiracular artery. Persists in elasmobranchs and ganoids. First gill. Second gill.	Two; right and left. One. Wanting. Wanting. Carotid.	Partially separated. Wanting. Wanting. Carotid.	Completely separated. Wanting. Wanting. Carotid.
Arches of the Aorta.	Fifth visceral arch; third branchial. Sixth visceral arch; fourth branchial.	Third gill. Fourth gill; with branch to air-bladder in Dipnoi.	Systemic arches, unite form dorsal aorta.	As in amphibia.	Systemic; the left aborts in birds, the right in mammals.
	Superior cardinals } Ductus [right and left] } Cuvieri Inferior cardinals } [right [right and left]. } and left].	Jugular [right and left]. Cardinals [right and left] and left].	Jugulars. Anterior portions of cardinals atrophy in part. The posterior portions unite to form a post-caval. Present; receiving also a portion of blood from posterior extremities. Present, but reduced in importance.	Pre-cavals. } = Jugulars right and } + sub-clavians left.	Much as in reptiles. Much as in reptiles.
Principal Venous Trunks.	Hepatic portal; veins from stomach and intestine to liver. Renal portal; veins from the capillaries of the posterior extremities breaking up in the capillaries of the kidneys.	Present. Present.	Present; receiving also a portion of blood from posterior extremities. Present, but reduced in importance.	Present. Present as small branches of the pelvics. [Wanting in Chelonia.]	Present. Wanting.



forms at least a part of it returns twice, passing from the heart to the lung, then back to the heart, and thence to the system and back to the heart again. In Amphibia and reptiles the blood from the lung and from the system mix somewhat in the heart, because the partition between the right and left sides is not complete, but in birds and mammals the two sides of the heart are completely separated and the pure and impure blood are not allowed to mix (see Figs. 169, 170).

360. **Excretion.**—We have seen that carbon dioxide, one of the waste products of the protoplasmic activity, is eliminated through the lungs and skin. Water is similarly excreted. The most important remaining waste (*e.g.*, *urea*) contains nitrogen. This is taken from the blood by means of the *kidneys*, a pair of organs very complicated both as to structure and development. They lie near the middle line of the body at the back of the body cavity. Each gland represents a large number of *nephridia* or tubules similar in some respects to the segmental organs of worms (Fig. 35), but much more complicated. The kidneys are always well supplied with blood. In fishes, amphibians, reptiles, and birds both arteries and veins carry blood to the kidney; in mammals, only arteries. The excretion, more or less in solution in water, is poured by the tubules into a duct—the *ureter*—which may be the final outlet; or the ureters may empty first into a *urinary bladder*, which has its own outlet (the *urethra*).

361. **Reproduction.**—With certain exceptions among the fishes the sexes are separate in the vertebrates. In development the primary germ cells arise, in several groups of the vertebrates (probably in all), from the entoderm of the intestine (mesenteron) and migrate into the germinal (mesodermal) epithelium to the future position of the gonads. The eggs vary in size from  $\frac{1}{100}$  of an inch in mammals to 5 inches (ostrich), or more in some extinct birds. The outlets for the ova and spermatozoa (*oviducts* and *vasa deferentia*) are modified portions of the embryonic excretory and kidney ducts. Throughout the group there is a close connection between the excretory and the reproductive organs. The oviducts may have special glands for depositing nutritive or protective material about the egg before or after

fertilization (as the albumen and shell in egg of birds). Fertilization is external in most fishes and some amphibia, and internal in the higher groups. Naturally it must be internal in all forms in which large masses of food or shells come to surround the ovum proper, since the sperm could not penetrate these after they are once formed. Similarly internal fertilization would be necessary in all cases where the young are developed within the body of the mother. In all such there are special organs and special instincts that lead to the introduction of the sperm into the body of the female (copulation). This however must not be confused with fertilization. The *uterus* is a special portion of the oviduct where early embryonic development may occur. (See Figs. 205, 206.)

362. **Development.**—Those eggs which are fertilized outside develop principally at the expense of the yolk of the ovum. Those internally fertilized may receive, after impregnation, additional materials for the further nourishment of the embryo, as above noticed for reptiles and birds. The fertilized ova may be retained for a longer or shorter time in the oviduct or in some modified portion of it (uterus, in mammals) and undergo development there. Where internal development is slight (as in birds) or absent the animals are described as *oviparous*; where it is considerable, as in mammals, and the young are free at birth they are described as *viviparous*.

The table on page 347 will give some of the facts concerning the early development of vertebrates. It will be found an excellent exercise for the students to verify the data collected in this and the preceding table (p. 344). It can readily be supplemented by a demonstration of figures from more advanced texts.

363. **The Muscular System.**—We have seen above (§345) that the internal layer of the mesodermic pockets comes to be united with the digestive tract. This layer furnishes the non-striped muscle fibres of its walls. The external portion, which becomes associated with the ectoderm, gives rise to the muscles of the body-wall and those which move the skeleton. The fibres of these muscles are cross-striped or voluntary (Fig. 30). It is by means of them that locomotion is effected. The skeletal muscles may be classed as (1) axial, and (2) appendicular. The axial are well shown in *Branchiostoma* (Fig. 154) and the fishes, where the whole body is made up of repeated

SUMMARY OF EARLY CONDITIONS IN THE DEVELOPMENT OF VARIOUS TYPES OF CHORDATA

	BRANCHIOSTOMA	FISHES	AMPHIBIANS	REPTILES AND BIRDS	MAMMALS
Yolk.	Slight in amount and well distributed.	Usually abundant and collected at nutritive pole.	Not excessive, but tends to collect at lower pole.	Excessive. The protoplasm confined to a relatively small disc at the upper pole.	Slight in amount.
Fertilization.	External.	Usually external.	External (anura); or internal (some urodela).	Internal; must take place in body cavity or upper part of oviduct before albumen and membranes are added.	Internal; in oviduct or uterus.
Segmentation.	Total and almost equal.	Usually partial; discoidal.	Total, but usually unequal; micromeres and macromeres.	Partial; discoidal. Initial stages while passing down the oviduct.	Total and essentially equal.
Gastrula.	Formed by invagination.	Formed by overgrowth.	Formed by a combination of invagination, delamination, and overgrowth.	Essentially the same as in amphibians but obscured by presence of much yolk.	Gastrula much disguised.
Embryonic Membranes.	None.	Yolk sac.	None.	Yolk sac; amnion; allantois.	Trophoblast, amnion, and allantois. Yolk sac.

segments (*myotomes*) of muscle fibres. The muscle segments alternate with the segments of the spinal column, as one would expect. The appendicular muscles are those which move the limbs. Their general arrangement will be seen from the study of the frog. In the higher vertebrates the segmentation of the axial muscles becomes less conspicuous especially in the head region, and the appendicular muscles become relatively of greater importance because of the greater use of the appendages. The muscles associated with the entoderm are unstriate and not under conscious control.

**364. The Nervous System.**—The nervous system in vertebrates consists of two portions, the *central* and *peripheral*. The central nervous part embraces the deep-seated organs, the *brain* and *spinal cord*. From these organs the cell-processes or fibres pass to the various tissues of the body, terminating in a manner appropriate to the special case whether it be a muscle, sense organ, or gland. These nerves and their endings constitute the peripheral part of the system.

**365. The Central Organs.**—The central nervous system originates from the ectoderm as a longitudinal groove-like depression in the mid-dorsal line of the embryo. The union of the edges of this fold produces a tube and an overgrowth of the ectoderm separates it from the outside world (Fig. 156). It becomes surrounded by mesodermal elements (bone and connective tissue, Fig. 158), and itself undergoes numerous and complex changes. At the anterior end of the tube occur three distinct enlargements (Fig. 172, *A*). These are known as the *primary vesicles* of the brain, and by the later growth and differentiation of their walls they give rise to the five brain-regions of the adult. The brain must be considered merely as the specially modified anterior portion of the spinal cord.

Three sets of changes occur in the development of the adult vertebrate brain from this primitive condition:

1. The axis becomes more or less curved, the concavity being ventral.

2. Out-pocketings of the walls occur, in special regions, whose cavities (ventricles) retain connection with the central cavity (*e.g.*, the hemispheres). See Fig. 172, *h, tel.*

FIG. 172

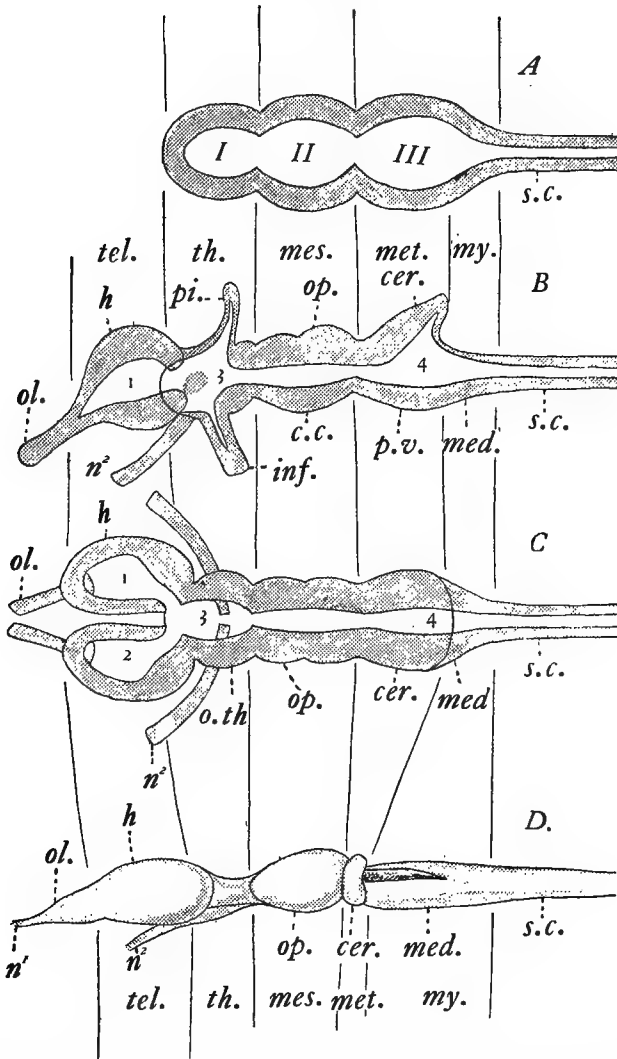


FIG. 172. Diagrams of the brain in Vertebrates, showing the primitive regions and their chief modifications. A, early stages, showing the anterior enlargement in three lobes: I, II, and III, the primary vesicles. B, a sagittal section, showing the more fundamental modifications of the walls of the primary vesicles. C, frontal section of same. D, lateral view of the brain of the Frog. The vertical lines indicate corresponding points in the different diagrams. I, 2, 3, and 4 are the ventricles of the brain. *c.c.*, crura cerebri; *cer.*, cerebellum (hind brain); *h*, hemispheres (cerebrum or fore brain); *inf.*, infundibulum; *med.*, medulla oblongata; *mes.*, mesencephalon or mid brain; *met.*, metencephalon or hind brain; *my.*, myelencephalon or medulla; *n<sup>1</sup>*, olfactory nerve; *n<sup>2</sup>*, optic nerve; *ol.*, olfactory lobe; *op.*, optic lobes; *o.th.*, optic thalamus; *p.v.*, pons Varolii; *s.c.*, spinal cord; *tel.*, telencephalon or fore brain; *th.*, thalamencephalon or "between" brain.

**Questions on the figures.**—What portions of the adult brain are produced from each of the three primary lobes? Where are the principal outgrowths, thickenings and thin portions of the wall? In comparison with figure *D* what portions of the brain become highly developed in the higher Vertebrates? Make a diagram based on *D*, which will show the general relation of these parts in man. Compare the diagrams with the table on page 349, and verify the statements there.

3. Thickenings or thinnings of the roof, sides, or floor of the tube may produce lobes and affect the size of the cavity of the tube. The accompanying diagrams and table will furnish an outline from which the student may pursue the details somewhat further.

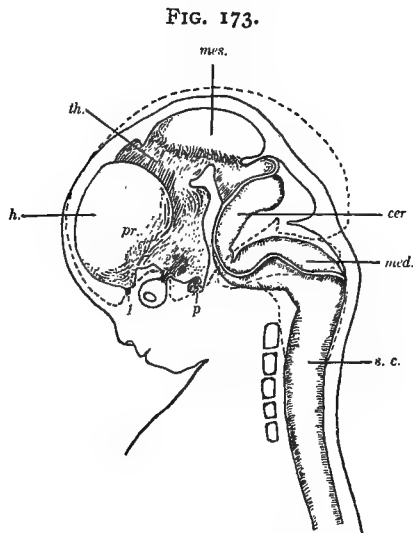


FIG. 173. Diagram of head and brain of human foetus six weeks old (heavy boundaries). The dotted line indicates the outline of the brain of a foetus three months old. Note the great growth of the hemisphere (*h*). *cer*, cerebellum; *med*, medulla oblongata; *mes*, mesencephalon; *p*, pituitary body; *pr*, prosencephalon; *s.c.*, spinal cord; *th*, thalamencephalon; 1, olfactory nerve; 2, optic nerve. Compare with Fig. 172.

**Questions on the figure.**—Locate point by point the corresponding regions in the diagrams in Fig. 172. What are the chief points of modification? Note particularly the great flexures of the organ. Where is the cerebellum of the older embryo? What is the nature of the pituitary body in the adult?

These diagrams (Fig. 172) do not give the exact proportions between the various parts of the vertebrate brain. The student is urged to examine figures less diagrammatic in their nature in the larger texts. See, Fig. 173; also, Edinger: "Anatomy of

TABLE SUMMARIZING THE PRINCIPAL REGIONS OF THE ADULT BRAIN AND THE RELATIONS TO THE PRIMARY VESICLES

PRIMARY VESICLE	CHANGES UNDERGONE	PRINCIPAL STRUCTURES	CAVITIES	ADULT PART
Prosencephalon	Out-pocketings of lateral-anterior wall; in higher forms accompanied by much folding and thickening of sides and floor.	Cerebral hemispheres. Olfactory lobes. Corpus striatum.	1st and 2d ventricle.	Telencephalon or cerebrum.
	Lateral walls thicken.....	Optic thalami. Pineal outgrowth. Outgrowth forming optic nerve. Infundibulum.	Foramen of Monro. 3d ventricle.	
Mesencephalon	Dorsal wall evaginates.....	Optic lobes (2 or 4). Crura cerebri.	Aqueduct of Sylvius.	Thalamencephalon or 'tween-brain.  Mesencephalon or mid-brain.
	Ventral wall evaginates.....			
Rhombencephalon	All walls thicken; otherwise little change	Cerebellum; one median, and two lateral lobes. Pons Varolii; largely fibrous, and commissural.	4th ventricle.	Metencephalon or cerebellum.  Myelencephalon or medulla oblongata; passing with little change into the spinal cord.
	Dorsal, lateral.....			
	Thickening and outgrowth of dorsal wall.	Epithelial roof of 4th ventricle. Substance of the medulla oblongata.		
	Thickening of ventral wall.....			
	Dorsal wall thin.....			
	Lateral and ventral thickened.....			

Find the parts mentioned in this table in Fig. 172.

\* Except in front where it remains membranous.

the Central Nervous System in Man and Vertebrates," Figs. 21, 107-112.

366. That portion of the central nervous system not enclosed in the skull is called the spinal cord. It is surrounded and protected by the dorsal arches of the vertebræ. The cord is nearly circular in cross section, is somewhat enlarged in the regions of the appendages, tapers toward the posterior end and is divided into symmetrical right and left lobes by a dorsal and a ventral longitudinal groove (see Fig. 174, *d.f.*, *v.f.*). It possesses a cen-

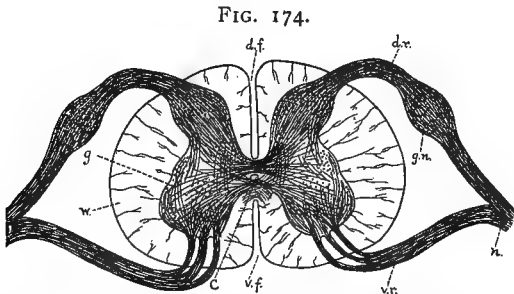


FIG. 174. Diagram of a cross-section of the spinal cord through the roots of spinal nerves. Drawn by Folsom. *c*, central canal; *d.f.*, dorsal fissure; *d.r.*, dorsal root of spinal nerve arising from the dorsal horn of the gray matter (*g*); *g.n.*, ganglion on the dorsal root; *n*, spinal nerve; *v.f.*, ventral fissure; *v.r.*, ventral root of the spinal nerve, arising from the ventral horn of the gray matter; *w.*, white matter. (The dorsal fissure in the diagram is broader than it should be.)

**Questions on the figure.**—What is the structural difference between the white and gray matter in the cord? Describe their arrangement. How are the two halves of the cord united? Which are sensory and which motor roots? What structural differences do you notice in the roots?

tral canal continuous with the cavities of the brain. The outer part of the cord (Fig. 174, *w.*) is composed of the white matter (longitudinal nerve fibres) and the interior portion, of gray matter (a mixture of nerve-cells and fibres). This is somewhat the reverse of the condition found in the brain.

367. **Peripheral Nervous System—Spinal Nerves.**—Groups of nerve fibres spring from the gray matter of the cord and pass to the organs of the body. These nerves arise in pairs—one pair to each body segment—and pass out between the vertebræ. Each nerve has two "roots," a dorsal and a ventral, from each of which some of its fibres come (Fig. 174, *d.r.*, *v.r.*). The roots



differ in appearance in that the dorsal has an enlargement (*ganglion*) containing nerve cells; the ventral has none. The fibres from these two roots combine to form the nerve, but each fibre remains independent throughout. It is known by experiment that the fibres of the dorsal root carry impulses toward the spinal cord ("sensory") and those of the ventral root carry impulses from the cord ("motor"). In certain regions the nerves springing from successive segments of the body may have numerous interlacing fibres, forming what is known as a *plexus*.

368. **Cranial Nerves.**—Those nerves arising from the brain, that is, inside the cranium, are called *cranial nerves*. There are ten to twelve pairs of these, but they are not of equal morphological value, nor are they strictly equivalent to the spinal nerves. Some have dorsal and ventral roots, but a much larger number have only one group of roots, either dorsal or ventral. Some are purely sensory nerves, some are motor, and some are mixed. How these nerves are related to the segments of which the head is believed to be composed is yet an unsettled question.

The *first* or *olfactory* pair arises from the olfactory lobe of the fore-brain; its fibres, which are purely sensory, are distributed to the lining of the nose, the end organ of smell.

The *second* or *optic* nerve arises from the second division of the brain (*thalamencephalon*), consists of purely sensory fibres, and is distributed to the retina of the eye, the end organ of vision.

The *third*, *fourth*, and *sixth* pairs are purely motor and are distributed to the muscles of the eye. The third and fourth arise from the third division of the brain (*mesencephalon*). The sixth nerve arises from the medulla, as do the following.

The *fifth* (*trigeminal*) comes from the anterior portion of the medulla (hind-brain) and, like the spinal nerves, has both dorsal and ventral roots. It is largely sensory, supplying the skin of the face, mouth and tongue. Motor fibres pass to the muscles of the jaw.

The *seventh* (*facial*) is largely motor, is distributed chiefly to the muscles of the face and controls facial expression.

The *eighth* or *auditory* is sensory, and is distributed to the inner ear, the end organ of hearing and of equilibration.

The *ninth* or *glossopharyngeal* is a mixed nerve and is distributed to the muscles and mucous membrane of the pharynx and to the tongue.

The *tenth* or *vagus* arises by numerous roots, has both motor and sensory fibres, and is the most widely distributed nerve in the body. Its fibres pass to the posterior visceral arches, lungs, heart, stomach and intestines.

We find the cranial nerves and their nerve endings concerned chiefly with the higher senses, the muscles of expression, and the sensations and activities involved in the fundamental processes of nutrition.

369. **The Sympathetic System** which is always distributed to the visceral organs is made up of a series of connected ganglia in the dorsal part of the body cavity. This system is in connection at various places with the central nervous system. It serves to connect the internal organs more intimately, and is reflex in its action.

370. **The Special Senses.**—The sense organs represent specialized terminations of the nerve fibres, or special epithelial cells which have become associated with such fibres (Fig. 43). From the very nature of the case they must be external. In the case of higher animals, the more complicated sense-organs are removed from the surface and are much modified, but the essential sensory portion is similar in all, and they retain some suitable connection with the outside. It is usually these accessory structures which transmit the stimuli to the nerves that render the sense organ so complicated.

371. **The Skin Senses.**—Scattered over the body of many forms of animals are single cells, or groups of cells, or free nerve endings, which are for the reception of contact and temperature stimuli. These are not equally numerous or well developed in all parts of the body. They are often especially developed in connection with hairs. In the lower aquatic vertebrates, especially the fishes, groups of such sensory cells occur in pits or longitudinal grooves along the sides. These are called the organs of the *lateral line*. Their exact function is still in some doubt. It is thought that they may possibly assist in the recognition of slow vibrations in water.

372. **The Chemical Senses—Taste and Smell.**—The chemical senses involve close contact and a chemical union between the substance to be perceived and the organ itself. For that reason the substance must be capable of solution in the fluids that moisten the surfaces. In vertebrates these organs are located at the anterior end of the body and usually within special pits or cavities. The taste organs are in the mouth, especially on the tongue and soft palate. In some animals the sense is poorly developed. The end organs of the sense of smell are located in pits (nose), anterior or dorsal to the mouth, lined with folds of the mucous epithelium. In most fishes these pits

are not connected with the pharynx, but in all air-breathing forms there is such connection, and the nostrils constitute the normal inlet for air to enter the lungs. The sense of smell is much more developed in the air-breathing vertebrates, if indeed it can be said to exist at all in the aquatic animals. It is not always easy to distinguish between smell and taste. The olfactory organs are more sensitive than those of taste. At any rate smaller particles of the stimulating substances will arouse the sense of smell than will serve to arouse taste. This makes it true that smell is useful to detect chemical conditions at a greater distance than is possible in taste.

373. **The Ear.**—There is a single pair of ears in vertebrates, and these are located at the sides of the head behind the eyes. The essential sensory portion of the ear (internal ear) arises as an in-pocketing of ectoderm, and consists of a closed, fluid-filled membranous sac which is surrounded by mesodermal structures—often solid bone. Ordinarily this sac is constricted, being thus partially separated into two irregular chambers, the dorsal (*utricle*) and the ventral (*sacculus*). From the former arise three *semicircular canals* which are supplied with sensory hair-cells in the epithelial lining and are looked upon as being an organ to assist in detecting direction of motion and maintaining balance or equilibrium. From the sacculus arises an outgrowth, the *cochlea*, which in higher forms is well developed. It becomes spiral, and is well supplied with sensory cells. It is regarded as the chief auditory organ in those forms possessing it. This membranous sac or *labyrinth* is completely surrounded by cartilage or bone in fishes. There is no external ear. In forms above the fishes a membrane (*tympanic membrane*) stops up the spiracle and incloses what is known as the middle ear, which still communicates with the mouth by the *Eustachian* canal. A bridge of minute bones is also formed from the tympanic membrane across the middle ear whereby the external vibrations can be communicated to the internal ear. In addition to this, particularly among the mammals, is found an external tube leading to the tympanic membrane. Expanded folds of skin supported by cartilage form a funnel to

catch the waves. The tube (*external auditory meatus*) and the funnel or *pinna* constitute the external ear.

374. **The Eye.**—The eyes of vertebrates are a single pair of organs lying imbedded in an orbit of cartilage or bone, within which they have considerable freedom of motion. Six muscles,

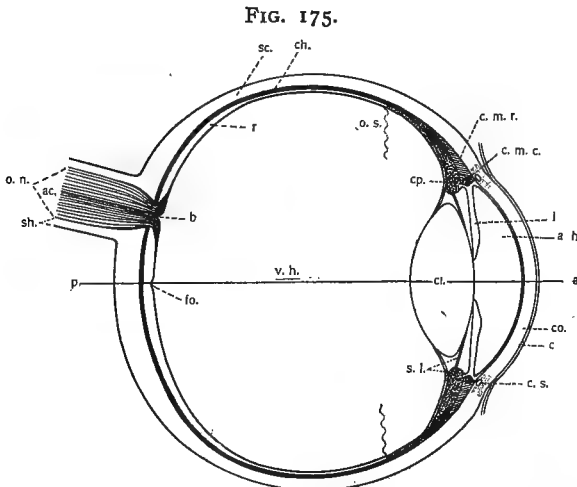


FIG. 175. Diagrammatic horizontal section through the right eye of Man. The line *a p* is the axis of vision. The optic nerve leaves the eye on the median side of this line. *a. c.*, central artery; *a. h.*, aqueous humor; *b.*, blind spot, the entrance of the optic nerve; *c.*, conjunctiva; *ch.*, choroid layer of the eyeball; *cl.*, crystalline lens; *c. m. c.*, circular fibres of the ciliary muscles; *c. m. r.*, radial fibres of the ciliary muscles; *co.*, cornea, the transparent portion of the sclerotic; *c. p.*, ciliary process; *c. s.*, canal of Schlemm, a lymphatic vessel; *fo.*, fovea centralis, the point of clearest vision; *o. n.*, optic nerve; *o. s.*, ora serrata, the anterior wavy margin of the visual portion of the retina; *r.*, the retinal layer; *sc.*, sclerotic layer; *sh.*, sheath of the optic nerve; *v. h.*, vitreous humor.

**Questions on the figure.**—Which is the essential sensory portion of the eye? Which parts are concerned in bringing the rays of light to a focus? How many refractive surfaces are present? How many refractive media? Which portions of the eye are primarily protective and supportive? What is the function of the various parts of the choroid layer? In what way is an image formed on the retina, of objects in front of the lens?

four straight (*rectus*) and two *oblique*, serve to move the eyeball. These muscles receive the third, fourth, and sixth of the cranial nerves. In the higher forms muscular folds of the skin serve to protect the eye in front. The upper and lower lids act vertically, but the third (*nictitating membrane*) works from the

inner angle of the eye outward. Sometimes all three lids are present together. In the lower groups the lids are wanting.

The essential part of the eye is the sensory expansion of the optic nerve—the *retina*—which occupies the innermost posi-

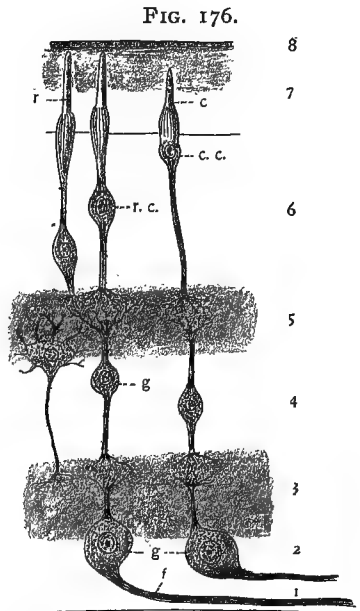


FIG. 176. Diagram showing some of the retinal elements in their relations to each other. Layer 1 is directed toward the interior of the eye and consists of nerve fibres (*f*) which finally enter the optic nerve at the blind spot; 2, the ganglion-cell layer, made up of the nerve cells of which the fibres are a part; 3, the inner "molecular layer" made up of the fine, much-branched nerve fibrils from 2 and 4; 4, the inner nuclear layer, containing numerous ganglion cells (*g*); 5, the outer "molecular layer," similar in structure to 3; 6, outer nuclear layer, containing the nuclei of the rod and cone cells (*r.c.* and *c.c.*); 7, the layer of rods and cones (*r. c.*). This is the nervous epithelium, or the nerve-endings of vision. The rods and cones are partly imbedded in a pigment epithelium (8). It must be remembered that hundreds of elements are omitted where one is shown in the figure.

**Questions on the figure.**—From what direction would the light come in this figure? Which portion of the retina does the light first strike on entering the eye? To what point must it penetrate to arouse nervous activity? Over what route must a nervous impulse pass to reach the brain from the point of stimulation (rods and cones)? Compare with similar figures in other texts.

tion, bounding the posterior portion of the cavity of the eyeball. This is a very complicated layer, but a general idea of it can be obtained from the diagram (Fig. 176). The layer of rods and cones, in close connection with a layer of pigment, is the sensi-

tive layer. Light falling directly on this from all directions would produce no image, just as the photographic plate exposed outside the camera would present a general blur. We find then the necessity of the same optical devices as are found in the camera: (1) a sensitive surface, the retina; (2) a box for support and for keeping out the light except from one direction, the opaque layers of the ball of the eye; (3) an aperture for the passage of the light into the interior of the box, the pupil and the transparent cornea overlying it; and especially (4) a lens or series of refracting surfaces which cause all the rays of light coming to the eye from each external point to be brought together again beyond the lens at a corresponding point on the sensitive surface. The elementary relations of these parts as found in the eyes of vertebrates may be gathered from a study of Fig. 175.

Accommodation of the eye to objects at different distances is effected by means of changes in the shape of the lens through the action of appropriate muscles.

**375. Library Exercise.**—What portions of the vertebrate eye are derived directly from the ectoderm? Which from the brain (*i.e.*, indirectly from ectoderm)? Which from mesoderm? (See Fig. 45.)

What variation occurs among vertebrates as to the condition of the bones in the middle ear? Whence are they considered to be derived? What variation in the cochlea? Study from figures the structure of the cochlea.

**376. Classification.**—The principal divisions of the subphylum Vertebrata are:

Class I. Pisces (*e.g.*, sharks, lung-fishes, bony fishes).  
Page 359.

Class II. Amphibia (frogs, toads, salamanders, etc.). Page 376.

Class III. Reptilia (crocodiles, lizards, snakes, turtles).  
Page 385.

Class IV. Aves (birds). Page 399.

Class V. Mammalia (mammals). Page 438.

## CHAPTER XX

### CLASS PISCES

377. The class of fishes, representatives of which are familiar to all, is important not only from the point of view of its specialized present-day representatives but from the fact that it was the first successful vertebrate group of geological times. It represents the primitive aquatic habit from which the land-inhabiting types of vertebrates must have arisen, and in it we find the fundamental plan of structure which has been modified in the higher forms (as the Amphibia) in adaptation to their present mode of life. It must of course be borne in mind that the types of fishes which are supposed to be the ancestors of the air-breathing vertebrates were much less specialized in structure than the present members of the class. There are, however, even now some of the fishes which have changed less than the majority, from the primitive condition.

#### 378. General Characteristics.—

1. Aquatic vertebrates having gills functional throughout life. Gills consisting of filaments or sheets, containing blood-vessels and attached to bony or cartilaginous arches in the region of the pharynx.

2. Paired appendages (pectoral and pelvic) normally fin-like,—not having a median jointed axis as in the limbs of the higher vertebrates. Medial fins dorsal, ventral, and caudal, the latter being the chief organ of locomotion.

3. There is usually a dermal skeleton consisting of scales, covered with epidermis. The latter may deposit enamel on the dermal core of the scale.

4. Heart two-chambered containing systemic (impure) blood.

5. Vertebral column either cartilaginous or bony; the vertebræ biconcave.

6. No true (allantoic, see Fig. 108, *al.*) urinary bladder.
7. A longitudinal line of sense organs ("organs of the lateral line") on each side of the body.
8. Nasal pit not (usually) communicating posteriorly with the mouth.
9. Fertilization and development usually occurring outside the body.

379. **Form.**—Fishes usually have a body somewhat flattened from side to side, though it may be quite cylindrical or flattened dorso-ventrally, and gradually tapering toward either end. This is readily seen to be a form well suited to motion through water. Those which enter crevices under rocks or elsewhere, as eels and catfish, are cylindrical. Some types are extremely freakish in form, as the spherical globe fish, angler-fish which is chiefly head, the strange hammer-headed shark, the pointed gar-pike and sword-fish, and the seahorse.

The head end, while not so specialized as in the higher forms, is much more cephalized than in the Protovertebrata. The mouth with its modifications of movable jaws, teeth, etc., the respiratory arches, the sense organs of sight, hearing, taste, and possibly smell, the brain and brain case all enter into this cephalization.

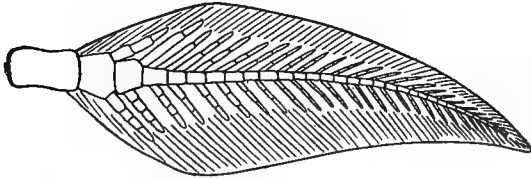
There is no neck, *i.e.*, the head is not movable with reference to the body. The length of the body varies very greatly as does the number of metameres embraced. The body may be distinguished as pre-caudal and caudal.

380. **Appendages.**—Fishes possess two classes of appendages—paired, or lateral, and median. These are expansions of the skin supported by rays of bone or cartilage. The paired fins are four in number and are considered to be homologous with the pectoral and pelvic appendages of the higher vertebrates. They differ much as to their position, especially the posterior pair, as may be seen by a comparison of the figures in this chapter. In its typical condition the appendage consists of girdle and the fin proper. In the lung-fishes there is a central axis (Fig. 177) through the fin, instead of the usual radiate arrangement (Fig. 178, *f.r.*) of the fin-rays. The legs of higher



vertebrates are supposed to have been derived from this type (the *archipterygium*).

FIG. 177.

FIG. 177. Diagram of the anterior fin (*archipterygium*) of *Ceratodus*.

**Questions on the figure.**—What are the chief points of contrast between this fin and that of Teleosts, figured in Fig. 178? How does Gegenbauer consider that this might give rise to the simpler type of Vertebrate legs?

FIG. 178.

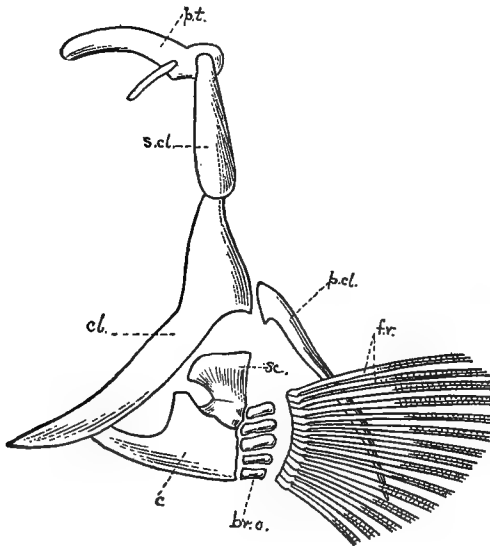


FIG. 178. Pectoral girdle and fin of a Teleost. *br. o.*, branchial ossicles; *c.*, coracoid; *cl.*, clavicle; *fr.*, fin rays; *p. cl.*, post clavicle; *p. t.*, post temporal which unites with skull; *sc.*, scapula; *s. cl.*, supra-clavicle. By Pilsom.

**Questions on the figure.**—Which girdle is this, right or left? Do authors regard any of these bones as homologous with similarly named bones in the higher Vertebrates?

The median fins consist of one or more dorsal portions which vary in extent, a caudal portion, and a ventral part near the

anus. These may represent remnants of a continuous median fin such as is seen in *Branchiostoma* (Fig. 154). They are supported by fin-rays in the dermal fold, which are in turn supported by spines imbedded in the muscles. The form of the caudal fin, which is much used in locomotion, differs widely.

FIG. 179.

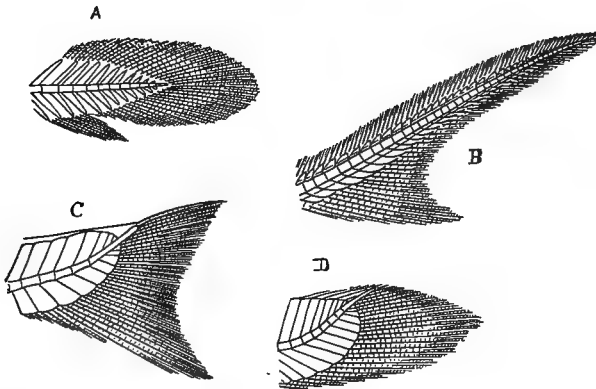


FIG. 179. Diagrams of some principal forms of tails in fishes. A, protocercal fin (as in *Polypterus*); B, heterocercal (as in Sharks); C, homocercal (as in most Teleosts); D, homocercal (as in *Amia*). By Folsom.

**Questions on the figures.**—What is the essential difference between the symmetry of D and of A? What conceivable advantage has the symmetrical over the unsymmetrical type? Are the heterocercal types successful swimmers?

These differences, correlated with modifications of the end of the vertebral column, have considerable importance in subdividing the class. The following types may be noted:

1. The vertebral column passes straight to the end of the tail and the fin-rays are disposed symmetrically with regard thereto (*protocercal*); found in lung-fishes and some primitive extinct forms (Fig. 179, A).

2. The vertebral column is bent dorsad, and a small fin lobe develops from its ventral side. The tail, though two-pronged, is not symmetrical (*heterocercal*). Found in sharks and many ganoids (Fig. 179, B).

3. The vertebral column may become still more bent and

reduced; the ventral lobe develops until the whole structure appears symmetrical again (*homocercal*). Found in bony fishes (Fig. 179, *C, D*).

FIG. 180.

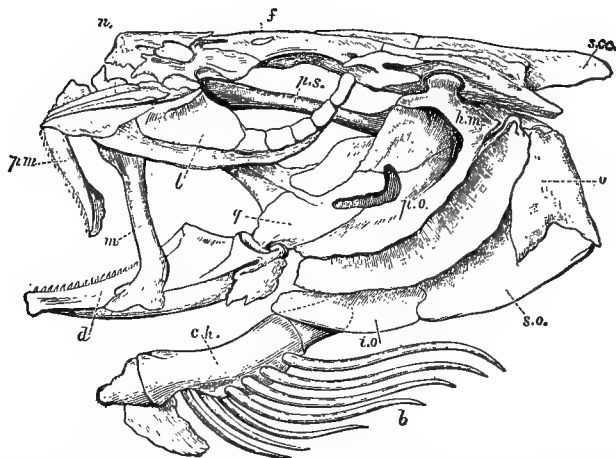


FIG. 180. Skull of Cod (*Gadus morhua*). From Nicholson, after Owen. *b*, branchiostegal rays borne on *c.h.*, the ceratohyal bone; *d*, dentary portion of the mandible; *f*, frontal; *h.m.*, hyomandibular; *i.o.*, interoperculum; *l*, lachrymal; *m*, maxilla; *n*, nasal; *o*, operculum; *p.m.*, premaxilla; *p.o.*, preoperculum; *p.s.*, parasphenoid; *q*, quadrate; *s.o.*, sub-operculum; *s.o.c.*, supra-occipital.

**Questions on the figure.**—What is the operculum? How many bones are associated to form it? Which bones are figured as bearing teeth? Which of these bones belong to the cranium proper? What is the difference between cranium and skull? What do authors believe to be the origin and homology of the chief facial bones?

381. **Covering.**—Most fishes are more or less covered by scales or scutes developed in the dermis and lying between the dermis and epidermis. The scales often receive a layer of enamel from the epidermis. In form they may be *cycloid* (round, with smooth margin), *ctenoid* (toothed margin), *placoid* (plate-like bodies often bearing points covered with enamel), and *ganoid* (thick rhomboid scales covered over with enamel, and often closely articulated into a coat-of-armor). The scales are usually placed as shingles are on a roof, and doubtless protect the fish from mechanical injuries. A good many species of fishes are destitute of scales altogether, the skin of such often being supplied with numerous mucous glands. In many extinct forms the external covering was made up of large plates fused into a dense armor.

382. **The Skull.**—The skull in fishes is especially noteworthy for the looseness of the connection between the facial bones (*i.e.*, the visceral or branchial arches) and the cranium. They are readily separated from the cranium. The lower jaw is not articulated directly with the brain-case but with the upper jaw (see Fig, 180, *q*).

383. **Locomotion.**—Fishes are aquatic and are complete masters of their medium. The density of water as compared with air makes the matter of support in the medium much easier for the fish than for the bird. The denser medium is however more difficult to penetrate. The specific gravity of the fish as a whole does not widely differ from that of water, although it varies within narrow limits. Four problems are thus presented to the fish for solution:

1. *The Regulation of Specific Gravity.*—It is thought that this is effected in part at least by the air bladder. The body muscles may bring about the compression of the contained gas and thus decrease the size without change of weight. The air bladder may aid in the recognition of changes in pressure due to differences in depth.

2. *Propulsion.*—The chief organ of propulsion is the caudal fin, acted on by the powerful lateral muscles of the body. The resultant of the alternate strokes against the water is forward motion. This may be supplemented by the action of the paired fins, especially in slow motion.

3. *Steering.*—This is accomplished in part by the changes in specific gravity and the regulation of the stroke of the tail, and in part by the action of the paired fins. The semicircular canals probably assist the animal in appreciating changes in its position,—its orientation, thus enabling it to choose its direction.

4. *Balancing.*—Since most fishes are flattened from right to left there is some difficulty in keeping an upright position. The sense of position is doubtless given by the semicircular canals. The paired fins are used in balancing, as are the dorsal and anal. Doubtless all the fins along the body of the fish are used somewhat as the keel of a boat or the planes of an air ship or a submarine.

FIG. 181.

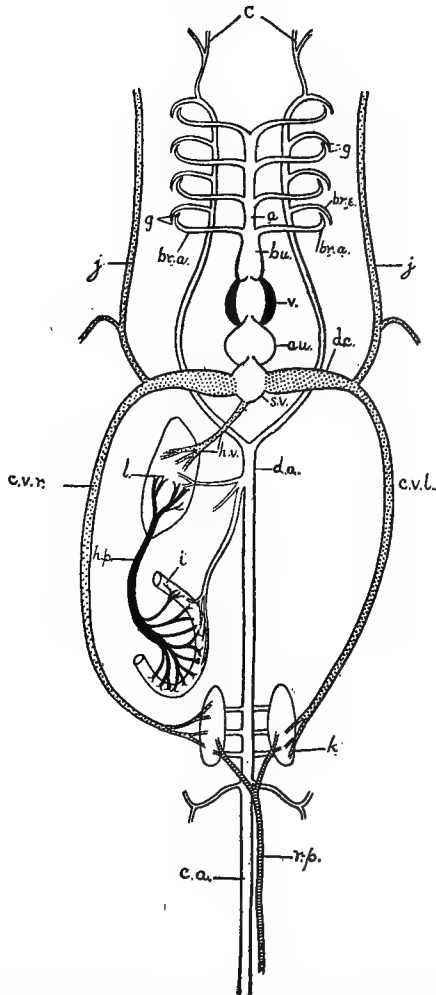


FIG. 181. Diagram of the principal vessels in the circulation of a fish,—ventral view. *a*, aorta; *au.*, auricle; *br.a.*, afferent branchial arteries; *br.e.*, efferent branchial arteries; *bu.*, bulbus (or conus) arteriosus; *c.*, carotid; *c.a.*, caudal artery; *c.v.r.*, right cardinal vein; *c.v.l.*, left cardinal vein; *d.a.*, dorsal artery; *d.c.*, ductus Cuvieri; *g.*, gills; *h.v.*, hepatic vein; *h.p.*, hepatic portal vein; *i.*, intestine; *j.*, jugular vein; *k.*, kidney; *l.*, liver; *r.p.*, renal portal vein; *s.v.*, sinus venosus; *v.*, ventricle.

Questions on the figure.—Follow the general course of the circulation, noting changes in the character of the blood in various capillary regions. What is the extent of the hepatic portal system? Of the renal portal? Where is the purest blood in the body? Reason for your answer? What do you mean by "impure" blood? Where are the chief impurities removed from the circulation?

384. **Supplementary Exercise for the Library.**—What is the structure and position of the “swim-” or air-bladder in fishes? With what organ is it related? Does it communicate with the outside? Are there any evidences that it is of value as a respiratory organ in any of the fishes? Can you conceive any use it might be in steering, for the purpose of rising or sinking in the water? What would be the effect of compressing the air-bladder at one end more than at the other?

385. **The Circulation.**—Little needs be said here in addition to what has been said in the general discussion of the vertebrate circulation (see Figs. 166–171). The heart is two-chambered. The auricle receives the venous blood from the system; it is passed to the ventricle through a valve which forbids its passage in the reverse direction. From the ventricle the blood passes through a valvular region into the *ventral aorta*, which carries it, by a series of right and left branches, to the gills. Here aeration

FIG. 182.

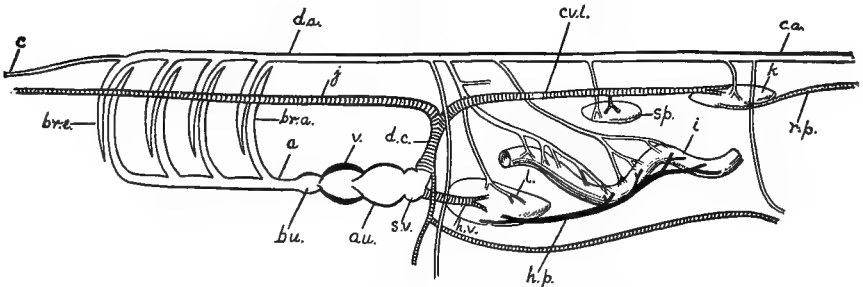


FIG. 182. Diagram of the principal vessels in the circulation of a Fish,—lateral view. Lettering as in the preceding figure. Adapted from Parker and Haswell.

**Questions on the figure.**—Compare the two views (Figs. 181 and 182) and identify the parts common to both, tracing the course of the circulation in the various vessels.

takes place, the pure blood being gathered from the gills by a series of efferent branches which combine (except some anterior branches which go to the head) to form a *dorsal aorta*. The dorsal aorta gives off branches to the body wall, to the paired appendages, to the liver, digestive tract and kidneys,—continuing into the tail where it breaks up in the muscles.

The impure blood from the capillaries of the tail is brought back to the kidneys by the *renal portal vein*, where it again passes through capillaries; here the blood is purified of its urea

and similar impurities. The blood supplied direct to the kidneys from the aorta and that of the renal-portal circulation is returned to the heart by way of right and left (*cardinal*) veins which join corresponding right and left veins (*jugular*) from the head to form the veins (*ductus Cuvieri*) which empty into the auricle. The blood which was distributed to the stomach and intestines is gathered into a vessel (*hepatic portal vein*) which carries it to the liver, together with much of the food absorbed from the intestines. The hepatic portal vein here breaks up into capillaries. The blood from the liver and from the appendages unites with that carried by the *ductus Cuvieri* before it reaches the heart. The student should carefully follow out the course of the circulation in the accompanying diagrams (Figs. 181, 182) and determine just what changes take place in the blood in the various capillaries through which it passes. Variations from this typical condition are numerous, accounts of which must be sought in more extended texts.

386. **Library Exercise.**—Find description and figures in the reference zoologies locating the unfamiliar structures in circulation of fishes in the table on page 344 and testing the statements found there.

387. **Habits and Food.**—Fishes occur abundantly both in fresh and salt water. Usually the whole life is spent under the same general conditions. The salmon and shad, however, are bred and partly develop in fresh water and later pass out to the sea. These forms return, often with remarkable precision, to the place of their own hatching to deposit their eggs. Use is made of this habit in the capture of them for commercial purposes. Unless some means are found for limiting the destruction of the adults during the breeding period, some of our most valuable food fishes are in danger of extermination. Others, as the eels, may generate in the sea and spend a part or all their adult life in fresh water. Some burrow in the muddy bottoms, as the eel, cat-fish, mud-fish; others lie on the bottom, as the flat-fish; many quaint forms frequent the depths of the sea. The most are active swimmers in open water near or away from the shore. Many forms (herring, shad, salmon, etc.), are distinctly gregarious, moving in great shoals especially at spawning

time or when in search of food. This fact and the knowledge of places and times are matters of much moment to the fishermen. The food of fishes is very diverse. Some forms are actively carnivorous, preying on animals as large or larger than themselves (sharks); others, and these are the most numerous class, depend upon small animals such as the young of their own or other species of fish, on crustacea, insects and worms. The microscopic animals and plants occurring in immense numbers in the water are important items in the food of fishes. Some fishes are scavengers, living largely upon the dead materials found in the water. Fishes differ much in their energy, courage, and resistance to attack. Those possessing these qualities in high degree are denominated "game" fish and are prized for the difficulty involved in their capture. The family of the trout and salmon includes several such species.

The deep sea habit results in most interesting adaptations. The conditions of life are different from anything we know. Light is absent, the temperature invariable and not far above freezing point, the pressure is something enormous. Many of the fishes are luminescent. Sometimes these luminous organs seem arranged to attract the prey. Some forms have very large eyes to use this weak light; others are blind as are some of the cave fishes. The sense of touch is greatly developed. In form they are very varied and bizarre.

388. **Economic Value.**—From primitive times fish has been one of the important human foods. Probably a larger percentage of the well-known species of fishes are regarded as edible than of any other animal group. Their rate of multiplying and their occurrence in schools at available points are quite as important factors as the delicacy of the flesh in determining the food value of a species. The improved devices for capturing fish, the development of methods of preserving them by drying and by canning, and the increased price of other food substances for which fish may be substituted have all conspired to increase the destruction of the more important edible fish both in the fresh and salt waters. In recognition of this, most nations have appointed commissions for the study of problems connected with



the fisheries and for the better regulation of the same. The United States Fish Commission in conjunction with similar state boards, has done an immeasurable amount of good espe-

FIG. 183.

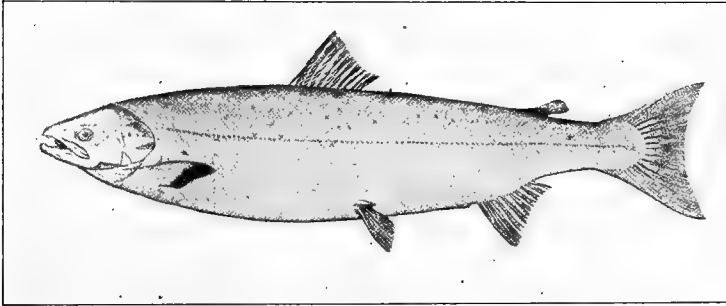


FIG. 183. Atlantic Salmon (*Salmo salar*). From the "Manual of Fish Culture," U. S. F. C.

**Questions on the figure.**—What are the names of the various fins shown in the figure? What is the dotted line along the side of the fish? What type of tail has this fish?

FIG. 184.

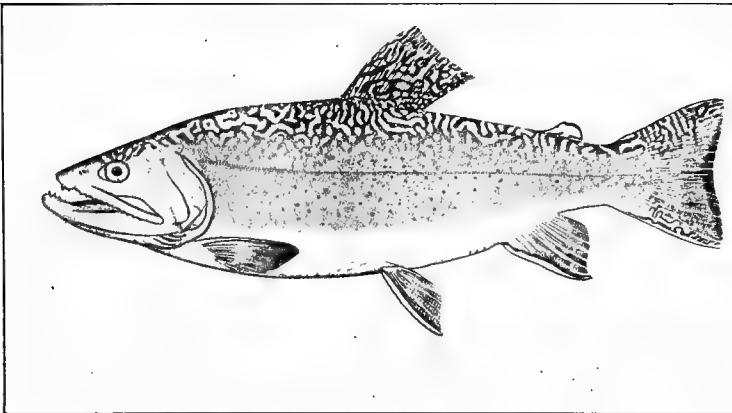


FIG. 184. Brook Trout (*Salvelinus fontinalis*). From "Manual of Fish Culture," U. S. F. C.

cially in the following particulars:

1. In taking the spawn of our most important food fishes and caring for it artificially during the period of early development when the young animals are in the greatest danger of

destruction. Such fish hatcheries are scattered all over the Union and many of our fresh waters are being restocked with species believed to be hardy and suitable for food.

2. By determining the foods preferred by special fish and artificially encouraging its abundance.

3. By encouraging the destruction of species of animals that prey upon the food fishes, and by the study of fish diseases produced by plant and animal parasites.

4. By studying the habits of the fishes and by regulation of the time, place and manner of catching.

The money value of the annual catch of fish in our waters cannot well be less than \$50,000,000. The most valuable fresh-water forms are the lake trout, white fish, cat fish, bass, perches, suckers. The chief marine species are cod, haddock, halibut, mackerel, menhaden, herring, and salmon. The latter, though marine, is caught in fresh waters in its breeding migrations.

There are numerous species of fish which are destructive to the food fishes, by devouring the young or in other ways. Among these are the gar-pike, pickerel, muscalonge, German carp, the dogfish and other sharks.

### 389. Supplementary Exercises for the Library.

1. Make a report concerning the principal food fishes used by the people of the United States: their habits and geographical range, the mode of their capture and putting on the market.

2. Make a study of the methods of capturing fish from primitive time to the present and show how the methods have been adapted to the habits of the fish.

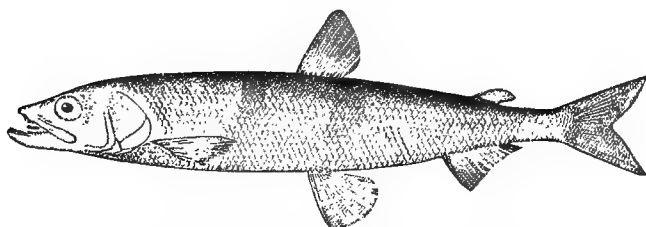
3. A study of the history and work of the United States Fish Commission as shown in the annual reports and bulletins. Its economic side. Its scientific side.

**390. Reproduction and Development.**—The sexes are separate. The sexual elements are produced in great numbers. The ova (*spawn*) are usually deposited in the water, in shallows on the open bottom, under rocks, or in places specially provided for them by the parents. The sperm (*milt*) is poured over these by the male, and the fertilization and later development take place in the water usually with little or no care on the part of the parents. Great loss of life occurs among the young from the voracious habits of other species and sometimes of the parents themselves. It is not difficult to believe that the enormous number of eggs produced by the female is an adaptation

to meet this risk of mortality among the young. In some cases (most sharks and a few bony-fishes) the eggs are fertilized and the young hatched within the body of the mother. Only a few young are produced in such forms.

The eggs of fishes are usually well supplied with yolk, segmentation being partial (discoidal, see §53). The unsegmented portion comes to be surrounded by a yolk sac and furnishes nourishment for the early stages of development.

FIG. 185.

FIG. 185. The Smelt (*Osmerus dentex*). Bull. U. S. Fish Commission.

391. **Special Adaptations.**—In addition to those already mentioned the group of fishes shows many adaptations to special modes of life.

*Color.*—Most fishes show color as the result of pigment in the cells of the skin, or of delicate markings on the scales. In general, the tone of color tends to accord with the environment. This becomes very striking in some of the less active forms, as the flounders, in which the colors may change more or less rapidly to accord with the bottom on which they lie. It seems probable that some degree of protection from enemies may thus be gained, which would be of distinct value to the species. In some cases, however, the color is in sharp contrast with the environment, and may be very conspicuous. This is believed to be a warning coloration in some instances, accompanying some disagreeable quality. Some deep-sea forms are luminescent. This is probably of considerable importance, as no sunlight penetrates to that depth.

*Electrical Organs.*—In several groups of fishes (rays, eels, etc.), certain muscular tracts have become so modified that under nervous stimulus instead of producing motion by contraction

they form and accumulate electrical energy which may be discharged at the will of the animal. This power certainly has a protective value, as the discharge is in some cases powerful enough to paralyze much larger animals than the fish itself. It is probably useful also in capturing prey.

FIG. 186.

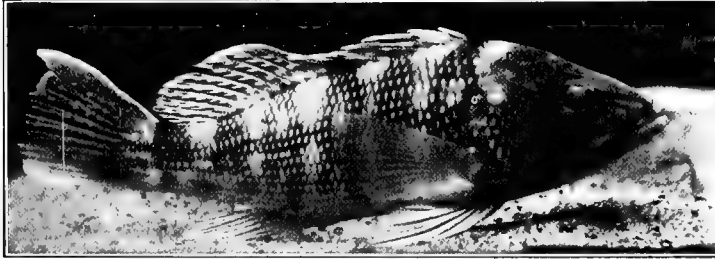


FIG. 186. Young Sea-bass (*Centropristis striatus*). Photo from life by Dr. R. W. Shufeldt.

**Question on the figure.**—Locate the pelvic fin and compare with other fish as to position.

*Asymmetry.*—In the flat-fishes we find a very striking compression from side to side. In early life they have the position normal to other fish, but in the adult stage they rest and swim with the dorso-ventral plane horizontal instead of vertical—on the left side in some species and on the right in others. The side that is uppermost becomes pigmented like the back, and the under side loses its pigment and becomes white, as the belly of fishes in the normal position. The eye which belongs to the under side changes its position until it comes to lie on the upper side. The bones of the cranium, especially those about the eye, are twisted and the right and left branches of the jaw are unequally developed. The dorsal and ventral fins become continuous and the body tends to become bilaterally symmetrical in the new position. We can scarcely doubt that this asymmetrical condition has been brought about by the position which the animal takes in relation to the environment, but we know that in some species the eye begins to migrate now before the fish assumes the lateral position.

### 392. Classification of Fishes.

*Subclass I. Elasmobranchii* (Sharks, Dog-fishes, Rays, Skates).—This group is often recognized as a separate class. Marine fishes with essentially cartilaginous skeleton; no operculum or gill-cover; mouth on the ventral surface of the head; heterocercal tail; external skeleton of placoid scales; spiral valve in the intestine; no air bladder. The elasmobranchs are regarded by some as being the nearest present relatives of the primitive fishes. They occur most abundantly and are larger individually in warm seas. They are powerful swimmers as befits carnivorous, preying animals. They feed on Crustacea, Mollusca, and fish.

#### *Subclass II. Teleostomi.*

*Order 1 Crossopterygii.*—Vertebral column well ossified; tail diphyccercal; pelvic fins, when present, abdominal. *Polypterus* and *Calamoichthys* include the only existing representatives.

*Order 2. Chondrostei.*—Skeleton largely cartilaginous; ganoid scales; tail heterocercal; pelvic fins abdominal. Paddle-fishes and sturgeons. Largely fresh-water forms. Feed upon small organisms.

FIG. 187.

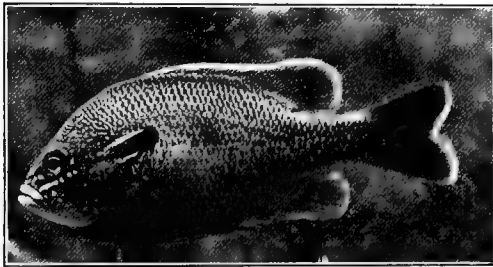


FIG. 187. Long-eared Sunfish (*Lepomis auritus*). Adult. Photo from life by Dr. R. W. Shufeldt.

*Order 3. Holostei.*—Skeleton bony; scales ganoid or cycloid; tail diphyccercal or homocercal; ventral fins abdominal. Gar-pikes and bow-fins. Predatory on other fish, crayfish, mollusks, etc.

*Order 4. Teleostei.*—Skeleton bony; tail usually homocercal; scales cycloid or ctenoid. Carp, suckers, catfish, white fish, trout, pike, etc. This order contains the majority of living species of bony fishes. Many of the species are very important commercially. Food habits varied.

*Subclass III. Dipnoi* (Lung-fishes).—Fishes with a persistent notochord and the internal skeleton incompletely ossified; soft cycloid scales; spiral valve in the intestine, the swim-bladder used as a lung, the auricle partly separated into two chambers, paired appendages with a central axis producing a flapper rather than a fin (Fig. 177). There are only three genera of living representatives, but these are especially interesting to the zoologist from the fact that they may represent the division of fishes from which the air-breathing vertebrates sprang. One genus (*Neoceratodus*) is found in the rivers of Queensland; the second (*Protopterus*) in the rivers of southern Africa, and a third (*Lepidosiren*) in the Amazon in South America. No marine forms are known. From fossil remains it is evident that the ancestors of the present Lung-fishes were very much more widely distributed.

FIG. 188.

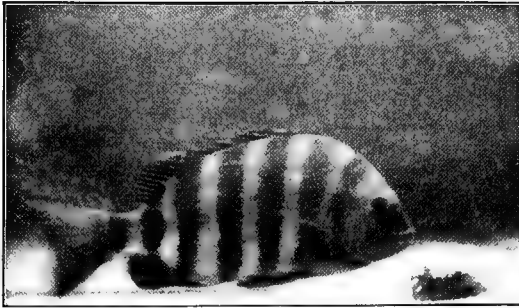


FIG. 188. Sheepshead. Greatly reduced. Photographed from life by Dr. R. W. Shufeldt.

FIG. 189.

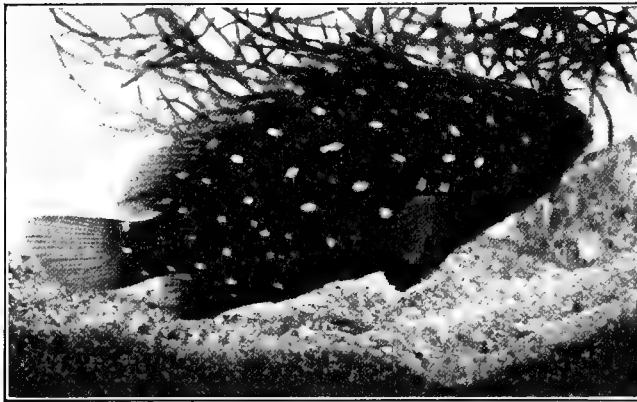


FIG. 189.—Young of the Snowy Grouper (*Epinephelus niveatus*). Photo from life by Dr. R. W. Shufeldt: American Naturalist.

### 393. Supplementary Studies for Library and Field.

1. What are the theories as to the origin of the paired fins of fishes?
2. In what way do fishes change their long axis from the horizontal position so as to ascend or descend obliquely in swimming?
3. Range of size in fishes.
4. Probable origin of fresh-water fishes. What forms are now able to pass back and forth from fresh to salt water?
5. Accumulate data concerning the habitat, food, breeding habits, distribution, economic importance (with the reasons therefor) of some of the following fishes: salmon, trout, white-fish, sunfish, muskalonge, herring, eel, cod, flat-fish, mackerel, shark, ray, sturgeon, gar-pike, bowfin.

6. What is known of the habits of the lung-fishes calculated to suggest how the lung may be of value in preserving the life of the animals?
7. Migrations among fishes.
8. Parental care among fishes.
9. The number of eggs produced by various species.
10. Study figures showing the embryology of the salmon or other bony fish.
11. The blind fishes found in caves. What are the principal facts concerning them, and what explanations have been offered to account for their habits and modifications.
12. Collect all the data possible concerning the flat-fishes.
13. Examine all the figures of fishes found in your library, and make note of the chief points of variation and the range of these.

## CHAPTER XXI

### CLASS AMPHIBIA (FROGS, TOADS, SALAMANDERS)

394. The amphibians are especially interesting to the zoologist because they begin life as gill-breathers (tadpoles), and later they usually replace the gills by lungs. This is the meaning of the name. The fact that the amphibian in its individual life passes from a fish-like condition to the form and habits of the higher air-breathing vertebrates is taken as evidence that the higher vertebrates have sprung from fish-like ancestors through forms similar to the amphibians. The change from gills to lungs is not equally complete or striking in all the members of the group. The transition from water to air involves important changes in the problem of physical support, of locomotion, and of respiration, and in consequence, of the organs performing these functions as well as correlated changes in the integument and in the organs of circulation. The Amphibia were much more abundant in earlier geological times than at present, and attained huge size, whereas the modern forms, with a very few exceptions, are small. There are nearly two thousand living species. The tailless types (frogs and toads) are much the more numerous, as well as more highly developed.

#### 395. General Characters.

1. Vertebrata possessing gills during the larval stage and usually lungs in the adult; in some instances gills retained throughout life.
2. Paired appendages when present conforming to the general vertebrate type; *i.e.*, limbs with digits (typically five), instead of fins.
3. Exoskeleton of scales and plates absent; skin glandular.
4. Heart three-chambered; two auricles and one ventricle.
5. A renal-portal and hepatic-portal circulation present. Red corpuscles nucleated.



6. The anus and the ducts from the excretory and genital organs open into a cloaca.

7. Development usually by a metamorphosis. Segmentation total but unequal.

396. **Form.**—Amphibia differ much as to the shape of the body. The newts and salamanders are elongated, slender and eel-like; the frogs and toads have large, flat heads, stout trunks, and muscular limbs. Among the former groups there may be as many as two hundred and fifty body segments, in the latter the vertebræ behind the head are reduced to ten. The neck is usually inconspicuous and the head movement limited.

397. **Appendages.**—There may be two pairs of appendages, one pair, or none at all. In most forms except the Anura (*tailless*) the limbs are small and weak as compared with the body (Fig. 191). The limbs have a distinct dorsal and ventral (*palmar* surface, as well as an anterior and a posterior border. The digits are enumerated from the anterior border which terminates in the first, or thumb. In many forms there is a reduction of the digits on the anterior appendage from five to four. The digits universally lack claws. The feet are often webbed, and in the climbing toads the digits may end in discs by which they cling to objects.

398. The **skin** is normally soft, and slimy by reason of a glandular secretion. It is composed of two layers, epidermis and dermis. In the frog the epidermis is in two layers, the outer of which may be shed at intervals. In toads, and other forms frequenting dry places, the epidermis may form warty thickenings. The skin is often highly colored owing to the presence of pigment cells in the deeper layers. There are two chief kinds,—black and yellow pigment cells. The pigment cells are much branched, and the pigment may either be concentrated or diffused through the cells. The different colors are due to different concentration and different proportions of the various pigments. In some cases the tones of color may be changed in accordance with the surroundings by direct action of light on the pigment cells, or by the reflex nervous action of the

animal, resulting from impressions on the retina of the eye. Besides light,—heat and cold, moisture, and probably internal states of the animal, may produce color changes. In many instances these colors are protective by making the animal like its surroundings. In the extinct Stegocephali external protective plates were developed in the dermis. Minute dermal scales are found in some of the lowest present forms (“*blind-worms*”).

399. **The Skeleton.**—The points of contrast with the skeleton of fishes are, chiefly: the presence of a *sternum* (formed independently of the ribs); the imperfect development of the ribs; the typical limb skeleton; the union of the pelvic girdle with the spinal column; the closer fusion of the upper jaw with the cranium.

The vertebræ of the lower forms are biconcave as in fishes, in the higher forms (Salientia, and higher Caudata), concavo-convex. The vertebral column consists of one cervical vertebra; a variable number of thoracic and abdominal vertebræ; usually one sacral, to which the posterior girdle is attached; and a variable number of caudal vertebræ (*one*, in Salientia).

400. **Respiration.**—In early larval stages the respiration is effected wholly by means of the skin, and even after the development of special organs of respiration the skin continues to serve this function in a greater or less degree. Most amphibians have, when hatched, external gills which may be retained through life (as in *Siren*, the “mud-eel”), or may give place to internal gills covered by a fold of skin (as in the development of the frog). Typically, lungs replace both kinds of gills in the adult. The gill slits do not exceed three or four pairs in number. Some of the aquatic forms retain their gills when the lungs are developed, each method of respiration supplementing the other. Those which possess lungs alone in the adult must of necessity undergo profound changes in passing from the water-breathing to the air-breathing habit. The lungs arise as a ventral outgrowth from the esophagus or pharynx. From the short trachea the two sac-like lungs spring. The walls are in folds but the sacs are simple. In some salamanders there are neither gills nor

lungs in the adult, respiration taking place through the body surfaces, and by means of the bucco-pharyngeal membranes. The frog breathes through its nostrils. The mouth cavity can be increased by muscular action, thus allowing the entrance of air. The nasal openings are then closed by flaps and the air is forced by muscular action into the lungs.

401. **Supplementary Exercises for the Library.**—Find as many different types of respiration as possible among the amphibians, and cite examples. What forms have gills only? What evidence is there that the environment has much to do with hastening or retarding the change from gills to lungs? Give the natural history of the Mexican axolotl as far as respiration is concerned. Are any Amphibia hatched with lungs at the outset?

402. **Circulation.**—In the gill-breathing larvæ the circulation is quite similar to that in fishes (§385; Fig. 181). When the gills are lost and lungs developed, the arterial arches (Fig. 169) which supply the gills change their course, or suffer destruction. This is an interesting instance of the modification of old structures to meet new demands. Coupled with these changes we find the separation of the auricle into two chambers—right and left. The veins from the lungs empty into the left, and the systemic veins into the right auricle. While there is only one ventricle into which both the pure blood from the lungs and the venous blood from the system go, it is so arranged that the venous blood is chiefly returned to the lungs and the purest blood goes to the head and to the systemic circulation. The venous circulation is modified in general accordance with the changes in the heart and arteries.

403. **Supplementary Exercise.**—Compare the arterial vessels in the adult frog with those in the fish and the tadpole stage of the frog, and find what, in the opinion of various authors, is the fate of each of the arterial arches. See Figs. 166–169. What are the most important differences in the venous circulation in fishes and in adult amphibians?

404. **Locomotion.**—In the lower Amphibia, in which the appendages are poorly or not at all developed, the muscles of the body show the segmental arrangement seen in fishes, and locomotion is effected by a serpentine or eel-like action of the body. In the higher forms, especially the Salientia, the limbs are well developed; and the body muscles lose something of the regularity of their arrangement becoming more as we find them in the higher vertebrates. The muscles that move the

limbs in relation to the body come to overlies and obscure the axial muscles proper. The Anura (frogs and toads) are especially adapted to leaping and swimming by the great muscular development of the hind legs.

405. **Exercise.**—Are there any special advantages in the leaping habit of motion either in the capture of prey or in escape from enemies? Verify from behavior of toads and frogs. Can you find illustrations from other groups of animals?

406. **Habits and Habitat.**—There are no marine Amphibia. Nearly all live in or near the fresh-water streams, swamps, or ponds, even in the adult air breathing stage. Some are good climbers (tree-toads); others burrow. The tailless forms (Salientia) are found the world over except in salt water. The Caudata belong chiefly to the northern hemisphere. All are more abundant in warmer climates. Their food consists largely of insects, worms, and the smaller animals. The larvæ even of carnivorous forms are sometimes vegetable feeders. They may live for a long time without food, and survive the winter in the colder latitudes by burrowing deep into the mud at the bottom of their ponds, or otherwise hibernating. During this time the vital processes are suspended or much reduced.

407. **Reproduction and Development.**—The common Amphibia lay rather large eggs, with a considerable amount of yolk which results in more or less unequal cleavage (Fig. 13, *B*). The eggs are usually surrounded by a gelatinous material, for their protection and adhesion, but they have no shell. They are almost universally deposited in the water, where impregnation takes place. In some of the Caudata impregnation is internal. In occasional species the young are brought forth alive. Ordinarily further development takes place in the water without any attention from the parents (frogs and toads). In a small South American frog (*Rhinoderma*) the male carries the fertilized eggs in his vocal sacs until hatched; in one of the tree-frogs from South America (*Gastrotheca*) the female has a pouch on the back in which the eggs are stored and hatched; in the Surinam toad the eggs are placed by the male on the back of the brooding female, where they become surrounded by spongy tissue. In these pits they hatch at once into the adult form without having

FIG. 190.

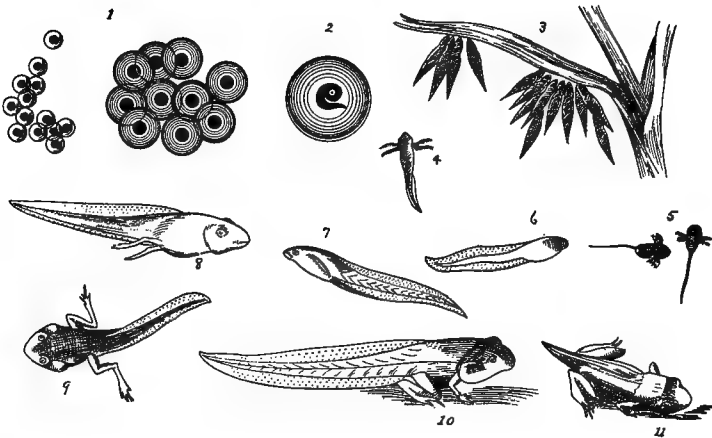


FIG. 190. The metamorphosis of the Frog. (After Brehm.) Numbers indicate the sequence.

**Questions on the figures.**—How much of the egg is really ovum? What are the changes which take place in passing through the various stages? In what order do the legs appear? How is respiration effected after stage 6? After stage 11? What is proven by the collecting of the tadpoles as shown in 3? How do they retain their position.

FIG. 191.

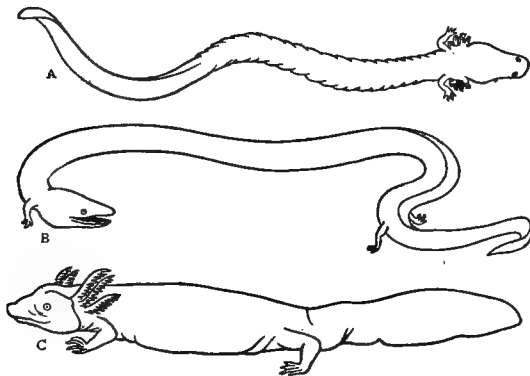
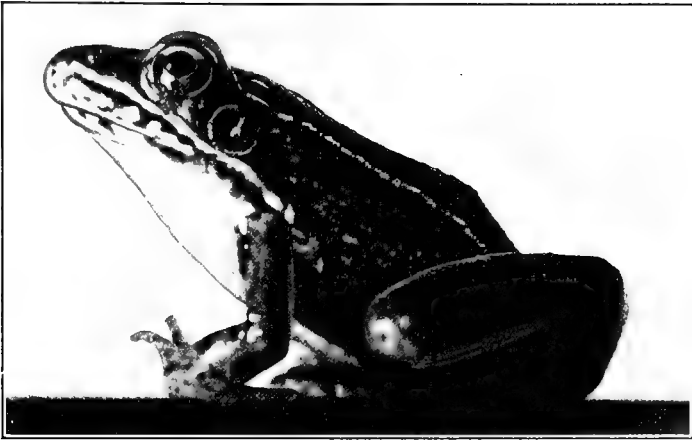


FIG. 191. Tailed Amphibians. From Nicholson, after Mivart. A, *Siren*; B, *Amphiuma tridactylum*; C, *Necturus*.

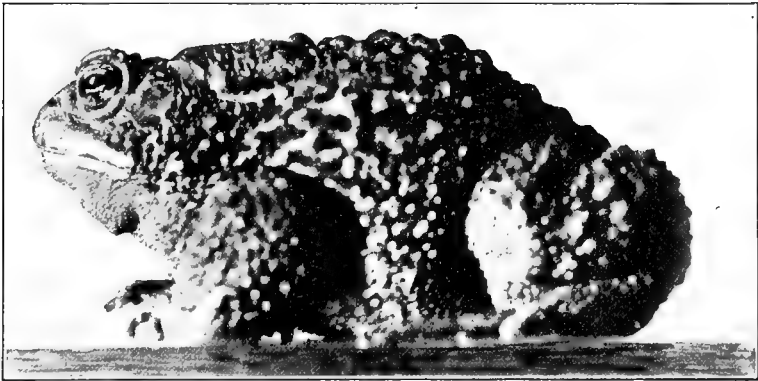
**Questions on the figures.**—Compare these three types and note all the chief differences of external structure. Compare also with figures you may be able to find of other Urodela.

FIG. 192.

FIG. 192. Frog (*Rana*). Photo from life by J. W. Folsom.

**Questions on the figure.**—What is the round object behind the eye? What elements in the resting position of the frog put him in readiness for a quick spring?

FIG. 193.

FIG. 193. The Common Toad (*Bufo Americanus*). Photo from life by Folsom.

**Questions on the figure.**—Compare with the figure of the frog and note points of external similarity and difference. What do you know of the habits of the toad, —as to feeding, egg-laying, etc.? Where do they spend the winter? What of their development?

external gills. This is of course a successful adaptation (by eliminating the metamorphosis) to a completely aerial habit.

From this group we have beautiful illustrations of unequal cleavage of the ovum, of which the student should have the opportunity of seeing figures in more extended works. If possible the cleaving eggs should be studied.

408. **Place in Nature.**—The amphibians are among the oldest vertebrates. They are not, however, a very successful group as measured by numbers of species or of individuals. The class itself and such species as the frog suggest the way in which the zoologist thinks the land animals arose from the aquatic. Among amphibians we have types that are like fish, gill-breathers all through life; others begin as gill-breathers, retain their gills and develop lungs; still others lose their gills when the lungs are perfected; and some are hatched out with lungs, never having had functional gills. This makes a very suggestive series of connecting links between water and air-breathing forms.

None of the species has large individuals. The "giant salamander" of Japan is the largest, reaching a length of 3-5 feet.

Amphibians are practically uniformly helpful to human interests, or at least without serious hurt to them. The toads destroy many injurious insects, and are thus particularly valuable about gardens. Toads are easily reared artificially and might be made to give us even more aid in controlling this difficult group. The legs of some of the larger species of frogs are eaten. The flesh is white and delicate. Frogs are also used in great numbers in the zoological laboratories, for dissection and experimentation. They have thus contributed no little to our knowledge of animal functions, particularly the functions of the nervous system.

Profitable frog "farms" are being conducted in various parts of the country to meet the demands referred to above. This suggests possible uses for certain swamp lands not now suitable for other purposes. Edible frogs and turtles might be encouraged in such regions instead of inedible types.

409. **Special Exercises.**—Describe the life history and the stages in the metamorphosis of the frog. (Fig. 190.) What

larval organs disappear? What new organs are introduced? Compare other amphibians as to the degree and facts of metamorphosis.

#### 410. Classification of Amphibia.

*Order I. Apoda.*—Degenerate Amphibia with neither legs nor tail; body worm-like; no gills nor gill-slits in the adult; eyes more or less degenerate. Small scales are imbedded in the skin. Represented by the so-called blind-worms of tropical countries.

*Order II. Caudata.*—Amphibia with tails persistent throughout life; body elongated; usually two pairs of appendages (sometimes only the anterior are present), which may be poorly developed.

The principal suborders are:

1. Proteida, three pairs of gills; two pairs of gill openings; eyelids absent. (Examples: *Necturus*, *Proteus*, *Typhlomolge*.)
2. Meantes, three pairs of gills; three pairs of gill openings; no eyelids; no hind limbs. (Examples: *Siren*, *Pseudobranchus*.)
3. Mutabilia, no gills in adult; gill openings usually absent; eyelids commonly present. (Examples: *Cryptobranchus*, *Amblystoma*, *Diemyctylus*, *Plethodon*, *Amphiuma*.)

*Order III. Salientia.*—Amphibia in which the tail is absent in the adult condition, if present in the embryo. Two pairs of appendages, the posterior of which are well developed. Undergo a metamorphosis in which the larvæ usually have the "tadpole" form, with gills and tail but without appendages. All traces of gills lost in the adult. The Salientia embrace the Bufonidæ or common toads, the Ranidæ or common frogs, the Hylidæ or tree-toads, and other less common families. The Salientia include the great majority of the species of Amphibia.



## CHAPTER XXII

### CLASS REPTILIA (CROCODILES, TURTLES, LIZARDS, SNAKES)

#### LABORATORY WORK

411. Specimens of reptiles are scarcely abundant enough to serve as satisfactory laboratory types for elementary classes, but instructive comparisons may be made by individual students or by groups of students. These results should be reported to the class.

Prepare three parallel columns, one for the lizard, one for the snake, and one for the turtle. Select a specimen of each and compare them with regard to their haunts; habits; food; general form of body; appendages, number, position, joints, digits; covering; manner of locomotion.

#### 412. Special Topics for Investigation in the Laboratory and Field.

1. Are reptiles warm or cold blooded? Your evidences?
2. What are the differences between the scales of snakes and of fishes?
3. In what various ways is the tail of reptiles used? How is the tail to be distinguished from the rest of the body?
4. What special senses do reptiles possess? What are your evidences? What peculiarities have the organs of sense?
5. What peculiarities do the internal organs of the snake have which to you seem to be correlated with the slender, elongate form of the animal?
6. What species of snakes, turtles, and lizards are found in your locality? Report on the special habits of each species in so far as you can determine them by observation. Supplement by reference to authorities.

#### DESCRIPTIVE TEXT

413. The Reptilia differ from the vertebrates hitherto studied in the fact that at no period of life do they possess gills. They agree with the lower forms in being cold-blooded and in the incomplete separation of the heart into right and left compartments (except in the crocodiles). They are, in addition to their air-breathing habit, similar to the birds and mammals in possessing the protective embryonic membranes known as

the *amnion* and *allantois* (see §423), the latter of which is important in embryonic respiration, that is, before hatching or birth. The group reached its culmination in numbers, variety and size in the Mesozoic age. So conspicuous was this group that the Mesozoic is called the "Age of Reptiles." All present living reptiles are but a remnant of what was once the greatest and most diversified group of the land vertebrates. In the Mesozoic era there were immense swimming, fish-like forms (*ichthyosaurs* and *plesiosaurs*) which ruled the seas; powerful terrestrial *dinosaurs*, often walking on their hind legs, and including the largest land animals known to have lived; and others, with membranous wings like the bat, the first vertebrates to learn the art of flying (Fig. 196). With the exception of a few marine turtles, the boas and pythons, and the alligators and crocodiles, the living species are for the most part small animals.

#### 414. General Characteristics.

1. Usually covered with scales or plates derived from the dermis (bony), or the epidermis (horny), or from both.
2. Digits (3-5) when present provided with claws.
3. Vertebrae concavo-convex, usually concave in front and convex behind.
4. Heart three chambered;—that is, auricles completely separated, but the ventricles only partially so except in the Crocodilia.
5. Two aortic arches, a right and a left, in the adult.
6. Gills absent in all stages.
7. Chiefly oviparous; eggs large, well supplied with yolk, and protected by a leathery shell.

Embryonic membranes,—amnion and allantois—first make their appearance in this group.

415. **The Reptiles** are very diverse in form. Perhaps the lizards may be taken as typical, with more or less cylindrical body, generally distinct head and neck, distinct tail, and usually two pairs of appendages, each possessing five digits armed with claws. They are mostly small animals, though one species is known to attain a length of seven or eight feet. The crocodiles

and alligators are similar in shape but much larger. The turtles and snakes are most widely different from the type and must be regarded as much specialized forms. The turtles have a characteristic protective bony box, and are ill adapted for rapid motion either on land or water. Snakes, on the other hand, elongated and devoid of appendages, are graceful in their motions and some species exhibit rapid locomotion. Some of the lizards agree with the snakes in lacking legs.

416. **Covering.**—The external covering in reptiles is in the form of scales or plates formed by the epidermis, or the dermis, or both. That deposited by the epidermis is horny and that by the dermis, bony. In snakes and many lizards the scales are epidermal and may be periodically shed and renewed. The scales usually differ in shape and size in different parts of the body. In turtles and their allies the horny constituent, which is illustrated by the "tortoise shell" of commerce, is in the form of plates and is reinforced by bony dermal plates beneath. The latter do not, in the adult at least, correspond in number and size with the former, but are closely associated with the bones of the internal skeleton. In crocodiles the dermal scales correspond in general with the epidermal.

The members of the group are on the whole well protected by these external growths. In many instances, as in certain of the lizards, prominent projections are formed upon the body covering, giving a striking appearance to the animals.

417. **Internal Skeleton.**—The vertebral column, except in the snakes and snake-like lizards, shows the customary regions (see §349). In the limbless forms only two regions are recognized,—the *pre-caudal* vertebræ which bear the ribs, and the *caudal* or tail vertebræ. The vertebræ are usually concave in front and convex behind, thus making a kind of ball-and-socket joint. In snakes the number of vertebræ is very large. No sternum occurs in turtles and snakes. When present, as in lizards and crocodiles, it is formed in connection with the ventral end of the ribs.

The skull articulates with the first vertebra by one surface

(*condyle*) instead of two as in mammals. In the snakes and lizards the quadrate bone is movable thus permitting great increase in the caliber of the throat (Fig. 194). The cranium is completely ossified thus showing an advance over the Amphibia. The radius and ulna and the tibia and fibula are separate. Vestiges of the pelvic girdles are found in some snakes, although the limbs are wanting.

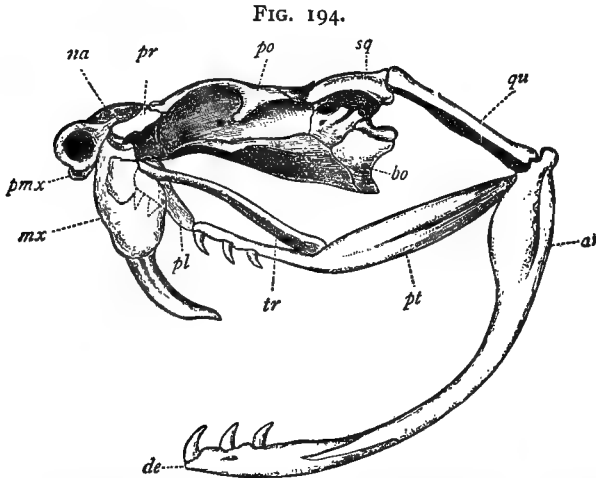


FIG. 194. Skull of Rattlesnake (*Crotalus horridus*). From Nicholson, after Huxley. *ar*, articular portion of lower jaw; *de*, dentary portion; *bo*, basi-occipital; *mx*, maxilla, bearing poison fang; *na*, nasal; *pl*, palatine, the front end being represented by a dotted line as though seen through the maxilla; *pmx*, premaxilla; *po*, post frontal; *pr*, prefrontal; *pt*, pterygoid; *qu*, quadrate; *sq*, squamosal; *tr*, transverse bone.

**Questions on the figure.**—Which bones bear teeth? Which are cranial and which facial bones? What bones do you find common to the snake and the fish (Fig. 180)? How do they differ in the two forms? What is the function of the quadrate? How does it differ in the different groups of Vertebrates?

**418. Respiration.**—Functional gills never occur, though gill-slits are partly developed in the embryo only to close again before hatching. The trachea is elongated and is supported by cartilaginous rings as in the higher forms. It divides into two bronchi, each of which passes to a spindle-shaped sac—the lung—which is much simpler in its internal structure than those of birds and mammals. In the snakes one lung (the left) is much

reduced or even altogether aborted. This is an adaptation to the narrow elongated body cavity. The ribs when present and the muscles acting on them are the prime agents in breathing.

419. **Circulation.**—In reptiles the right and left auricles are entirely distinct but, with the exception of the Crocodilia, the ventricles are only partially so. The septum in the ventricle is perforated. Yet in those forms in which the pure blood of the left auricle and the impure blood of the right partially mingle in the ventricle, the arrangement is such that the purest blood

FIG. 195.

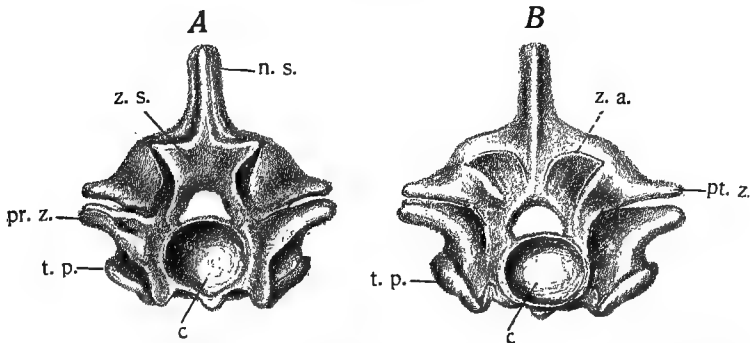


FIG. 195. Vertebrae of a Reptile (after Huxley). *A*, anterior view; *B*, posterior view of the vertebra in front of *A*. The surface of *A* fits against the surface of *B*. *c*, centrum, which is convex in *B*, fitting into a concavity in *A*; *n.s.*, neural spine; *pr.z.*, pre-zygapophyses, or anterior articular facets, which fit against *pt.z.*, post-zygapophyses; *t.p.*, transverse processes; *z.s.*, a wedge-like articular face on the neural arch designed to fit into *z.a.*, a depression on the posterior face of the neural arch of the vertebra in front (*B*).

**Questions on the figures.**—Try to form a clear picture of the relations of the articulating surfaces of the vertebrae and indicate the possible advantages of the arrangements. Where is the neural cavity? Where do the ribs articulate? What is the gain in muscular attachments from the numerous bony outgrowths on the vertebrae?

goes to the brain and the least pure to the lungs (see Fig. 170). Two aortic arches unite, giving rise to the dorsal aorta. In the reptiles and higher groups of vertebrates the renal-portal circulation (see Fig. 181, *r.p.*) ceases to be of much importance, but the hepatic portal is increasingly important. The red corpuscles are elliptical and possess nuclei.

420. **Nervous System and Special Sense Organs.**—The brain is not large in the reptiles, but is rather more highly de-

veloped than in the Amphibia. This is especially true of the cerebral hemispheres. The usual senses are represented. The rather large eyes are provided with movable eyelids except among the snakes, in which a permanent transparent membrane covers the eye. In some reptiles (lizards) there is a remnant of a median eye which is very degenerate in the adult. It is in connection with the *pineal body* in the second division of the brain. Hearing varies. It is rather keen in turtles; apparently less so in snakes. Smell is well developed. Touch is represented in the skin over the body, but is interfered with by the scales and plates.

421. **Habits.**—The reptiles are best represented in the tropical regions. The larger types, as the crocodiles, python, boa are almost confined to the warm zones, especially of South America, Africa and Asia. Numerous smaller representatives of the lizards, snakes, and turtles are found in temperate latitudes. These usually undergo a period of hibernation during the cold season. This habit of hibernating and seeking warmer climates seems related to the cold-blooded condition. The heat-producing qualities of the animals are not equal to the task of maintaining activity during extreme cold. The variation of temperature is of course a more serious problem to terrestrial animals than to aquatic types. Although air-breathers, very many of the group are aquatic, as the turtles, crocodiles, and many snakes. The lizards are almost without exception terrestrial. Nearly all prey on other animals; the smaller on worms, insects, and eggs of various kinds, and the larger on birds, fish, Amphibia, and mammals. The land tortoises are vegetable feeders.

Reptiles are rather sluggish animals. They like to bask in the sun. They are capable often of very rapid motion; but it is spasmodic.

Reptiles, especially the snakes, have a bad reputation, yet there is no doubt that their dangerous qualities are much exaggerated in popular opinion. The lizards are almost wholly non-venomous and the majority of the common snakes of this country are also harmless. The principal dangerous snakes

are the cobra of the East Indies where nearly 25,000 deaths were caused by serpents in 1899; the vipers of Europe; the rattle-snakes, water-moccasin, and copperhead of our own country. There are twenty-seven poisonous species in this country of which fifteen species are rattle-snakes. The venom serves the snake both as a means of defense and of paralyzing its prey. Some forms which are not poisonous assume bodily attitudes similar to those of the poisonous species. The dangerous species (and unfortunately the harmless ones) are being rapidly exterminated by man.

FIG. 196.

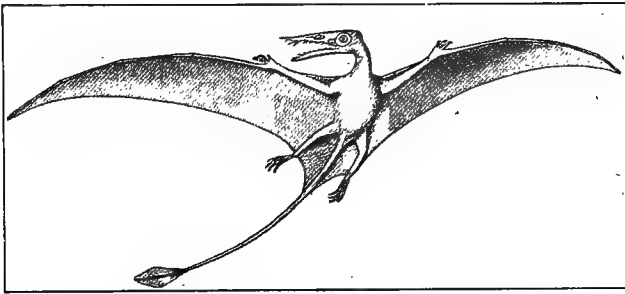


FIG. 196. *Rhamphorhynchus merensteri*,—a restoration of an extinct flying Reptile. From the Cambridge Natural History, after Geikie.

**Questions on the figure.**—In what respects does a form like this differ in external appearance from a bird? From a bat? What skeletal structures would a palæontologist need to find in order to believe that an extinct form had the power of flight?

422. **Special Exercises.**—Find data concerning hibernation in reptiles and other vertebrates: its object and advantages; preparation; place; degree in which vitality is suspended during the process, etc.

Describe the poison apparatus of venomous snakes. What is the homology of the fang? Of the gland?

How do different snakes capture their prey? How prepare it for swallowing?

Describe and attempt to explain the motion of snakes from actual observation: in water; on land.

423. **Reproduction and Development.**—The ova escape from the two ovaries into the body cavity. The ova enter the oviducts, and during the descent are fertilized. After fertilization the glands in the walls of the oviducts add albumen and shell structures, as in the birds. The eggs require a period of incubation which usually occurs outside the body; though some

lizards and snakes retain the eggs in the oviduct until the embryo is hatched, thus bringing forth their young alive. Many forms deposit their eggs in the warm sand or earth or in decaying rubbish heaps, where the abundant heat is favorable for the developing young.

Much yolk is present in the egg and segmentation is partial, being confined to a disc. The germinal layers and the important organs develop about the axis of this disc, the outer margins of which spread over the whole yolk in the form of a sac designed to nourish the embryo. The details of the growth are entirely too complicated for statement here. Two important embryonic membranes—the *amnion* and *allantois*—appear for the first time (see also §440). The amnion consists of folds of the blastodermic disc which arise, surrounding the embryo at its margin. These folds grow dorsally over the embryo and ultimately fuse to enclose a space which becomes filled with fluid. The amnion folds include both ectoderm and mesoderm. It is protective in function (Fig. 208, *am*). The cavity between the two layers of the amnion is an outgrowth of the coelom. The allantois arises as an evagination from the posterior portion of the digestive tract, and is made up of entoderm and mesoderm. It grows into the cavity of the amnion. It finally surrounds not merely the embryo but the yolk on the ventral side, and being well supplied with blood vessels is most important in supplying the embryo with oxygen. In this and in other features the reptiles show a close kinship with the birds.

424. **Place in Nature.**—Reptiles live upon both plant and animal food. They devour worms, insects, fish, amphibians, birds, small mammals, and eggs. Not many animals depend on reptiles for food. They are, perhaps, more immune from attack than most animals. Some of the predaceous birds eat lizards and snakes.

The group does not aid man at many points. Certain large lizards, and the tortoises and turtles furnish food. The soft-shelled turtle, the green-turtle, and the diamond-back terrapin are the most prized.

Skins of crocodiles and of some snakes, and the horny tor-



toise-shell are used in the manufacture of bags, ornaments, and the like.

Probably the chief value of the group to man is in the destruction of noxious insects by lizards and rodents by snakes.

#### 425. Classification of Reptiles.

*Order I. Testudinata (Turtles and Tortoises).*—The *Testudinata* are reptiles with short, flattened or dome-shaped bodies enclosed in a case formed by a dorsal shield (*carapace*) and a ventral (*plastron*). In some the carapace and plastron make a rather tight-box practically covering the animal. In others they are smaller and the edges are further apart. In these the appendages may protrude more, and the freedom of motion is much greater. The jaws are covered with a

FIG. 197.

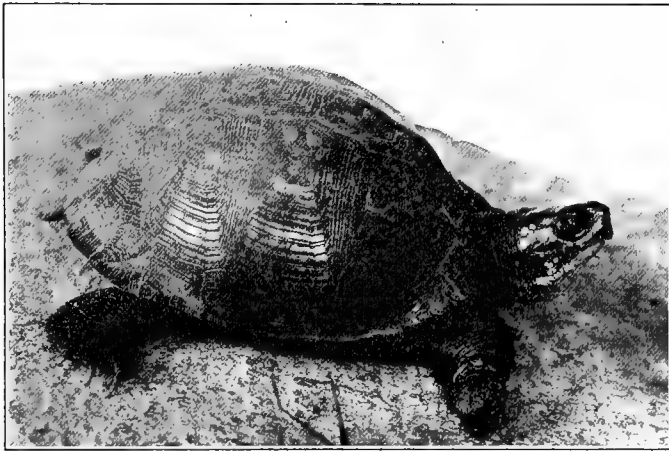


FIG. 197. Common Box Tortoise (*Terrapene carolina*). Photographed from life by Dr. R. W. Shufeldt.

horny case and are destitute of teeth. The quadrate bone is firmly fused to the cranium. The sternum is absent. Turtles seem rather more common in the northern hemisphere. The largest species are marine and may attain a weight of half a ton. Some live in fresh water and others on land. The flesh of some species is much prized for food. The green-turtle of the Atlantic coast is one of the choicest, its flesh being much used for soups. The large hawks-bill turtle of the tropical seas furnishes "tortoise-shell," used in combs and other ornaments. The shells of the leather-back and other "soft-shelled" turtles are not completely ossified. The "snappers" are ferocious animals, the big snapper of the Southern states being particularly vicious.

*Order II. Squamata (Lizards). Suborder Sauria.*—Reptiles in which the body is usually covered with small scales. Two pairs of limbs are ordinarily present; but either or both may be wanting. The quadrate bone is somewhat movable. The teeth are not in sockets of the jaw. Sternum present. The cloacal opening is transverse.

The Sauria include, beside the types commonly known as lizards, the horned-toads, and the glass snake—a legless lizard. They subsist largely on insects and the eggs of other animals. Only one species is known to be poisonous—the “Gila monster” of New Mexico and southward. The glass snake possesses in a high degree a power more or less common among lizards—of breaking loose from the tail when struck, or held by that organ. In some species, at least, a new tail may be regenerated. Most lizards are terrestrial, though a few are aquatic. They

FIG. 198.



FIG. 198. Swift Lizard (*Sceloporus undulatus*). Adult. Photographed from life by Dr. R. W. Shufeldt.

run, burrow, and climb. One species (Fig. 199) has a membrane extending from the sides, supported by ribs, that serves as a parachute.

*Suborder Predentia*, includes the chameleons.

*Suborder Serpentes*.—Reptiles with elongated bodies covered by fold-like epidermal scales which may be shed as a single “cast.” Limbs are wholly wanting. The mouth is capable of great extension on account of the elongate, movable quadrate bone. Teeth are numerous and fastened (not in sockets) to the bones

FIG. 199.

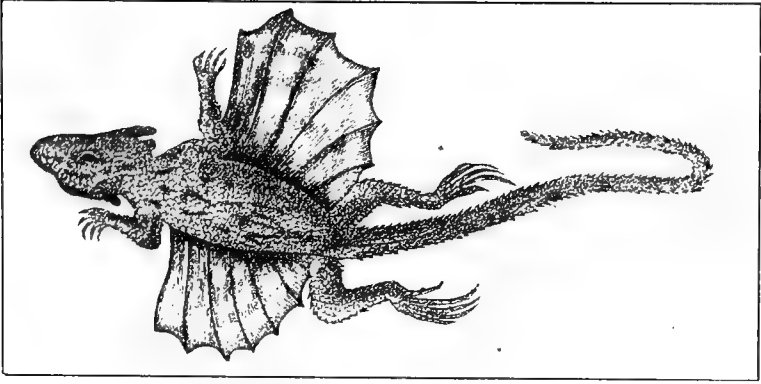
FIG. 199. Flying Lizard (*Draco volans*). From Nicholson.

FIG. 200.

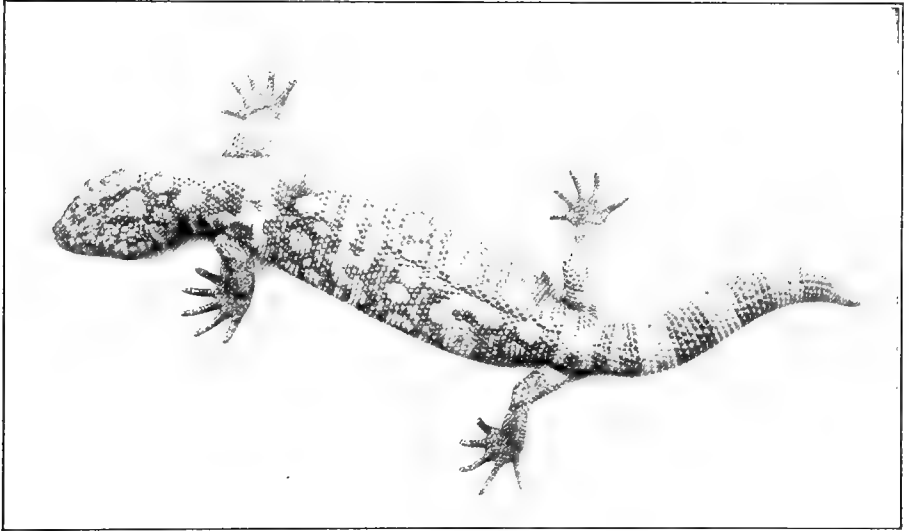
FIG. 200. Dorsal view of a "Gila Monster" (*Heloderma suspectum*). Photographed by Dr. R. Shufeldt.

FIG. 201.

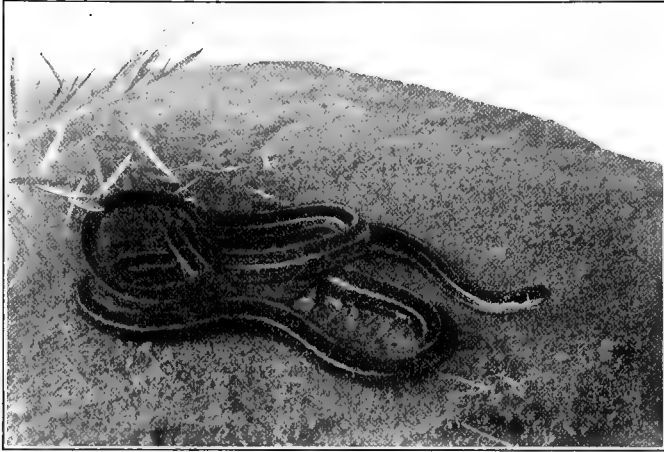


FIG. 201. Common Garter Snake (*Thamnophis sirtalis*). Photographed from life by Dr. R. W. Shufeldt.

FIG. 202.

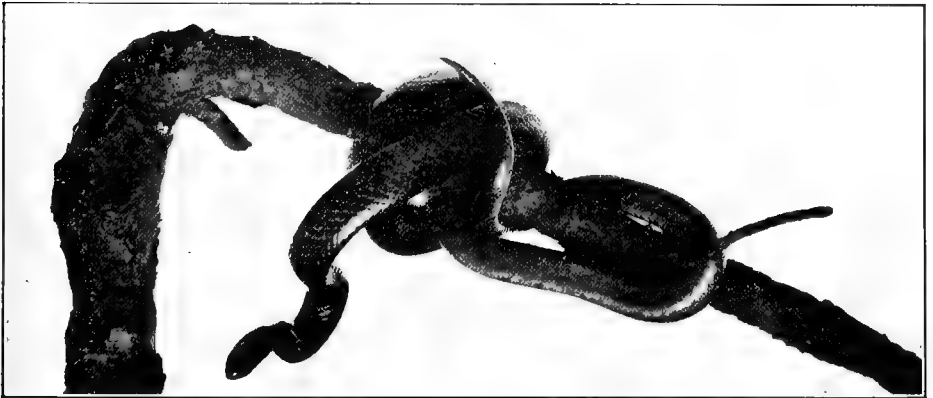


FIG. 202. Brown King Snake (*Lampropeltis rhombomaculata*). Photographed from life by Dr. R. W. Shufeldt.

**Questions on the figure.**—What structural adaptations have the snakes which tend to take the place of appendages? Illustrate your conclusions by citing examples.

bearing them. Sternum wanting. There are no movable eyelids. The tongue is protrusible, and is doubtless much used as an organ of touch, and possibly hearing.

Snakes are, like lizards, partial to warm climates, but are also found in temperate latitudes. Most are terrestrial, but some take to water readily; and there are some which never come to land. These bring forth their young alive. Many snakes are beautifully and characteristically colored. In some instances the coloration is deemed to be protective.

*Order III. Crocodylini (Crocodiles, Alligators, etc.).*—Fresh-water reptiles with elongated bodies bearing two pairs of well-developed appendages. The skin is armed with dermal bony scales or scutes covered by epidermal scales. Teeth occur in sockets. The quadrate is immovable and the sternum is present. The adult heart is completely divided into right and left halves. The cloaca opens by

FIG. 203.

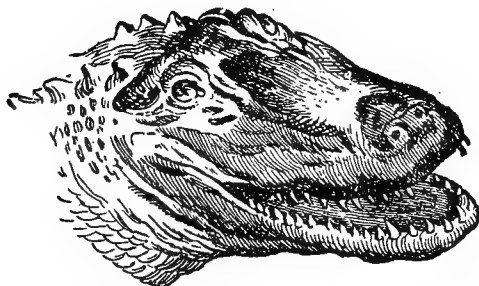


FIG. 203. Head of the American Alligator (*Alligator mississippiensis*). From Eckstein.

a longitudinal slit. Here are included the gavia of the Ganges, the crocodiles of the Nile and of tropical America, and the alligator of America. They are somewhat sluggish animals, but when hungry will attack with success the larger mammals or man. They may attain a length of twenty feet or more. Crocodylia are chiefly aquatic, though they rest and deposit their eggs on the shore.

There are numerous orders of extinct reptiles which show close relationship with the amphibians, birds and mammals of early geological times. This is merely another way of saying that the early Reptilia and the other vertebrates were much more generalized in their characteristics and less differentiated than those of the present. Reptiles occupy a central position among the classes of land vertebrates.

#### 426. Supplementary Topics for Investigation.

1. Have the venomous snakes any characteristic appearance?
2. Report on the habits of the rattle-snake. Whence the structure giving rise to the name? The nature of the fang and the poison gland.
3. What is the degree of activity and strength of the reptiles and cold-blooded animals, as compared with the warm-blooded?

4. The characteristics of the principal groups of geological reptiles.
5. The meaning of hibernation. Illustrations of its method among the reptiles.
6. The various methods of capturing prey among reptiles.
7. The facts concerning incubation and care of young among reptiles.
8. The development of the amnion and allantois. See figures in reference texts.

## CHAPTER XXIII

### CLASS AVES (BIRDS)

427. **Laboratory and Field Studies.**—Each student or group of students should be encouraged to select one or more species of birds and to study their behavior and external structure in the light of the following outline.

#### I. *Habits, Instincts and Activities.*

Haunts and feeding habits. What are its favorite foods?

How determined? What emergency foods will it use?

Social habits; solitary or gregarious?

Mating habits; monogamous or polygamous? Degree of sexual dimorphism?

Determine and describe its powers of song. Are they equally developed in all individuals of the species? Can you cite any evidence that the power is of any use to the animals?

Nesting habits; number of eggs, their size and other characters. Is their color of any conceivable use? Which sex incubates the eggs? Condition of the young at hatching and the care given by the parents to the young. Sum up the instinctive reactions which relate to reproduction, beginning with the spring migration and ending with the autumn migration.

Migrations. Are there any evidences of winter (or other important) migrations? If not, how is the winter spent?

If so, at what time does it occur? When does the species return? Any other known facts.

Power and peculiarities of flight. Other modes of locomotion? Is the power of perching well developed?

What are its relations to the other animals of the locality?

Has it any enemies? Is it hostile to any species of animals?

What is its abundance or scarcity in your locality? Can you assign any explanation of the facts observed?

#### I. *General External Appearance.*

Regions of the body: head, neck, trunk, limbs. Record all observable facts about:

Head: beak, mouth, nares, eyes (how many lids?), ears.

Neck: length, natural position, flexibility, etc.

Trunk: proportions, symmetry, shape, size, etc.

Wings: arm, forearm, hand.

Legs: thigh, shank, foot. Where is the heel? Evidences?

Note further arrangement and number of digits; form of the claws; covering of the *tarso-metatarsus*.

Covering of the body. Compare the color of all visible parts.

Select feathers from various parts of the body; study as a type one of the large wing feathers, noting: shaft (*quill* and *rachis*), vane (*barbs* and *barbules*).

Compare the other feathers selected with this one. What would you suggest as the prime function of each kind?

Arrangement of the feathers.

On wings: *remiges* (large), primary (on hand) and secondary (on forearm); *coverts*.

On tail: *rectrices*, number and arrangement; *coverts*.

On body (dip in hot water and pluck): note the pits which have borne the feathers; arrangement of these.

Are they uniformly distributed over the entire body?

Sketch the plucked bird, studying more carefully the regions already noted. Locate

Openings: mouth, nares, ears, cloaca.

Queries:

Is there any connection between the closing of the toes and the flexing of the leg? Has this any use to the animal?

Which digits are represented? Are they equally developed?

Which digit is turned backward? How is this determined?

Is there a tongue? Are there teeth? Do the nostrils communicate with the mouth?

What do you consider the function of the nictitating membrane? Are the eyes movable? Do they view the same field?

Do the two together cover the entire field of view?

How much external ear is present?



Are the scales homologous with feathers? (See reference texts.)

III. *Internal Structures.* (The pigeon is a good type for anatomical study.)

The student knows what internal organs and systems of organs to expect in vertebrates, and may well be required to block out an outline of work. What are the principal sets of organs to be expected? How do these compare with the corresponding structures in the fish or frog? Do you find any structures not found in the lower types. Uncertainties may be settled by reference to more extended texts. Record both by description and drawings.

#### DESCRIPTIVE TEXT

428. Birds may be looked upon as sharing with mammals the first place in the animal kingdom. Even the mammals as a class are not so highly specialized in structure and in habits as the birds. Their most striking features of specialization are connected with the demands of aerial life which they have so successfully met. They share with the insects the most perfect development of the power of flight found among animals. It follows from their high degree of specialization that they are among the most easily recognized of the vertebrates. The earliest geological traces of birds show that they are closely linked with reptiles in their origin, and the modern birds preserve many interesting likenesses to the reptiles. Some of these are seen in the scales on the shank and feet of birds; in the habit of laying large, yolk-laden eggs which hatch outside the body; in the structure of the egg and its mode of cleavage; the peculiarities of the ankle joint; in the presence of a cloaca.

#### 429. **General Characteristics of Birds.**

1. Epidemic outgrowths usually in the form of feathers (or scales in special regions, as the feet).
2. Anterior appendages in the majority of forms modified for flight. Large development of the pectoral muscles and the bones to which they are attached.
3. A single occipital condyle.
4. Heart completely four-chambered; only one (systemic)

aortic arch, which turns to the right; red corpuscles oval and nucleated. High bodily temperature,  $100^{\circ}$  to  $110^{\circ}$  F. Renal portal circulation almost wanting.

5. Some of the bronchial tubes terminating in air spaces (not true lung tissue) located in various parts of the body. These communicate with air cavities in some of the bones.

6. Parts of the skeleton much fused. Teeth absent, the jaw being sheathed by a horny product of the epidermis (beak).

7. Right ovary and oviduct aborted or rudimentary.

8. Oviparous; yolk abundant; segmentation discoidal; amnion and allantois present.

430. **Form.**—The birds, like many of the extinct reptiles, are bipeds. The axis of the more or less stout body makes an angle of varying size with the axis of the legs, that is, the vertical. The sacrum and the soft parts of the body project behind this point of union in such a way as to balance the anterior parts. The anterior appendages are not always well developed but are much anterior to and above the centre of gravity. This results in a more stable position of the body in flight. The posterior appendages are relatively long, sometimes extraordinarily so. In all cases there is an interesting correlation between the length of the neck and that of the legs. The wading birds are especially endowed in these particulars. The posterior appendages usually have four digits. These may all be directed forward as in some swifts, or much more commonly the great toe (number 1) is directed backward; in some species two are turned backward and two forward. In swimming birds a web is present which stretches from toe to toe. The special form and arrangement of the web differ in different species. The digits end in claws which vary greatly in accordance with the habits of the possessor. The anterior appendages usually show traces of three much reduced digits

431. **Supplementary Studies.**—Make a series of studies of the angle made by the axis of the body with a vertical line in various birds. Compare this angle in the robin when at rest and when running. Make outline drawings of the shank and toes of all the types of birds which can be found, and discuss the differences in the light of the habits of the birds. Compare these with figures in texts. Make figures of the varieties of webs found in the aquatic birds.

432. **Covering.**—The form of birds as outlined above is much modified by the presence of feathers. They increase the stretch of the wings and the surface exposed to the air, and thus are important as aids to flight. In addition they are protective in several respects. Pigment in the feathers serves to enhance greatly the beauty and variety of the members of the group. That the color patterns are of distinct value in sexual attraction

FIG. 204.

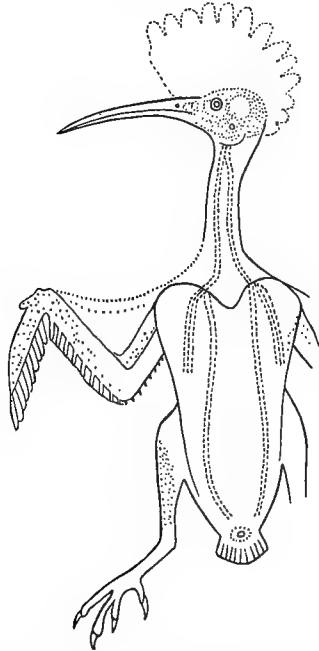


FIG. 204. Diagram showing the tracts where the principal growth of feathers occurs (*U pupa epops*)  
From Bronn. The dotted areas are the *pteryla*.

**Questions on the figure.**—Is this a dorsal or a ventral view? Find a figure giving the opposite view of some bird and compare with this. Is there variety in the different species of birds as to the distribution of the growth of feathers?

has been believed by many naturalists. The feathers, together with the scales of the shank, the claws, and the beak, are epidermal growths. Feathers are not usually produced uniformly over the body, but are grouped in regions which differ in different species. They also vary a great deal in form, from the down feathers of the young to the stiff quill-feathers of the wings and

tail. Most birds shed their feathers either a few at a time the year round, or within a short period. In the former case the change may be scarcely noticeable. When the moulting takes place rapidly, it may be accompanied by temporary disturbance in the health and habits of the animal. The new feathers may differ in color from the old, and thus a periodic change is apparent in the dress of some of our birds. This is not infrequently of such character as to accord in color with the changes in nature outside, giving a real protective value.

**433. Supplementary Topics.**—In what various ways are the feathers of birds protective? Explain how the protection is realized in each case. What varieties of feathers may be found in birds, and what are the chief differences in structure? How are the color patterns obtained? Are they made up of feathers of one color so put together as to form the pattern, or is a single feather of more than one color? Does a single feather ever show an independent complex color pattern? Where is the boundary between feathers and scales on the legs of various breeds of chickens? Do you find any evidences that feathers are highly modified scales? Are any of the feathers like the hair of mammals?

Secure further data from nature and from reference books concerning the moulting habits of birds.

**434. Endoskeleton.**—The chief points of importance to the elementary student are as follows:

1. There is a fusion of several vertebræ in the sacral region (including some of the thoracic, all of the lumbar, the sacrals and the caudals) with the dorsal bones of the pelvic girdle, to form a strong dome-shaped structure above the viscera. The cervical vertebræ vary much in number (eight to twenty-four) with the length of the neck.

2. The cranial bones fuse closely, and the bones of the face are prolonged into the core for the beak (Fig. 219).

3. The sternum is normally well developed and provided with a keel to which the muscles of flight are attached. Finger-like processes also increase its surface for the attachment of muscles and the support of the viscera.

4. The ribs are double-headed, and each has a process on the posterior margin, joining it to the rib behind.

5. The pectoral girdle has its clavicles fused ventrally in the flying birds, forming the "wish bone."

6. In the pelvic girdle the ventral bones (*ischium* and *pubis*) both pass backward from the hip joint and support the viscera.

7. The ankle region of the birds is very characteristic. The proximal tarsals unite with the tibia, and the distal tarsals unite with the fused metatarsals to form the *tarso-metatarsus* or shank. The joint is between the proximal and distal tarsals (see Fig. 161).

435. **Digestive Organs.**—The horny beak entirely replaces the teeth in the modern birds. In the ancient members of the group teeth are known to have been present. The esophagus, often of great length, is usually expanded into a non-glandular crop, where the food is stored and softened. The stomach often consists of two portions, the anterior glandular *proventriculus* and the posterior muscular *gizzard*. In birds which habitually feed on grains or other hard objects the inner wall of the gizzard is lined with a hard and thickened cuticle which assists in grinding the food. Fragments of rock, sand, etc., are nearly always swallowed by grain-eating forms to assist in the process. These are manifestly devices to do work usually done by teeth. The usual glands are found associated with the digestive tract, excepting the salivary. The tract ends in a cloaca.

436. **Supplementary Studies.**—What is the exact position of the crop? Advantage of this position? Make a comparative study of the beak in various birds; how adapted to the habits? Is there any recorded evidence that the character of the gizzard in a given individual may vary somewhat in accordance with the food used?

437. **Respiration.**—The trachea usually corresponds in length to the length of the neck. Its rings are rigid (partly ossified). It divides into a right and left bronchus which pass to the respective lungs. The lungs are closely applied, and even attached, to the dorsal wall of the thorax and are small in proportion to the size of the animal. Some of the bronchial tubes connect with air spaces (nine in the pigeon) among the viscera and extending even into the hollow bones. They are probably chiefly respiratory in function.

Bird notes are produced not at the upper end of the trachea as in other vertebrates but near its lower end, where it joins the bronchi. The organ is called the *syrinx*. Its mode of action is somewhat similar to that of the vocal cords in the larynx of mammals.

#### 438. The Nervous System and Organs of Special Sense.—

The cerebral hemispheres are relatively larger than in any of the groups yet studied. Their surface is smooth. The cerebellum is also large and concentrated chiefly in a central or median lobe. By the growth of these two portions the well-developed optic lobes are crowded into a lateral position. The olfactory lobes are small and the sense of smell is not so acute as in many other vertebrates. The optic lobes and the eyes are well developed and the sense of sight is correspondingly acute. The eye protrudes as a somewhat rounded cone in front. This is supported by a ring of sclerotic (bony) plates. The power of accommodation, that is, of focusing the eye upon objects at different distances, is very great in birds. In addition to the upper and lower lids a transparent fold of the conjunctiva (*nictitating membrane*) may be drawn over the eye from the inner corner. Hearing is acute, and the condition of the ear is interesting chiefly in the facts of the absence of the *concha* of the external ear, and in the presence of a well-developed but uncoiled *cochlea* in the internal ear.

Birds are sensitive, easily aroused, active. This nervous activity is correlated with the high temperature, rapid respiration, and large consumption of food.

439. **Habits.**—None of the animal groups present habits more interesting, more readily studied or more suggestive of the adaptation of structure to the demands of the environment than do the birds. The student will find by observation and by reference to current works on natural history many interesting facts in connection with bird-life. Under the suggestive studies a partial list of such topics will be found. In the chapter on *Adaptations* and in the section on the *classification of birds* (Ch. VIII, and §441) additional facts have been pre-

sented. Much of the time given to the practical studies of the group of birds should be directed to their life and adaptations.

FIG. 205.

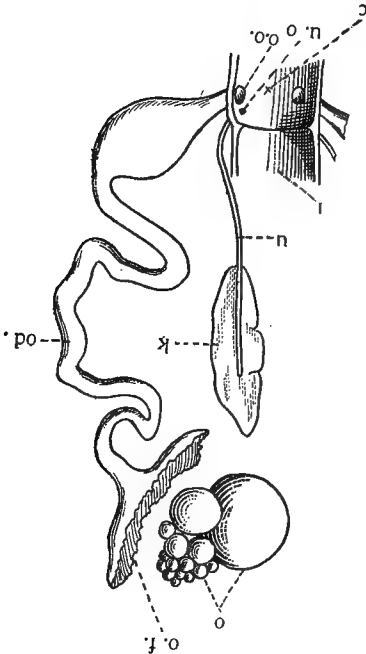


FIG. 206.

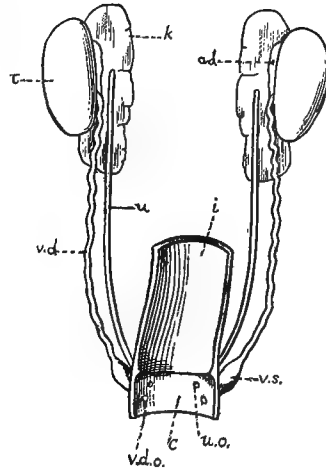


FIG. 205. Diagram of the female genital organs of a Bird. *c*, cloaca; *i*, intestine; *k*, kidney; *o*, ovary with ova of different size; *od.*, oviduct; *of.*, funnel of the oviduct; *o.o.*, opening of the oviduct into the cloaca; *u*, ureter; *u.o.*, opening of ureter into the cloaca. Only one ovary and oviduct are fully developed in the Birds.

**Questions on the figure.**—What openings has the oviduct? Why must the union of sperm and ovum take place before the egg gets well down the oviduct? Define the cloaca. On which side are the sexual organs rudimentary in the female bird?

FIG. 206. Diagram of the urino-genital organs of a male Bird. *ad.*, adrenal body; *c*, cloaca; *i*, intestine; *k*, kidney; *t*, testis; *u*, ureter; *u.o.*, opening of ureter into the cloaca; *v.d.*, vas deferens; *v.d.o.*, opening of the vas deferens; *v.s.*, vesicula seminalis.

**Questions on the figure.**—What is the function of the vas deferens? Of the vesicula seminalis? What differentiates the cloaca from the intestine? What are the chief differences in the excretory organs of birds and mammals?

These various habits and modes of life have frequently been made the basis of classification: for example, some fly and some do not; some wade, having long legs; others swim and

have webbed feet; some capture living prey with talons and curved beak; some scratch and have blunted claws; some climb and have two digits directed forward and two backward; others perch and have only one toe pointed backward. The resort to such superficial features in classifying birds suggests that the members of the class are more closely related and more similar among themselves in the fundamental features of structure than is the case with the subdivisions of the other classes of vertebrates.

FIG. 207.

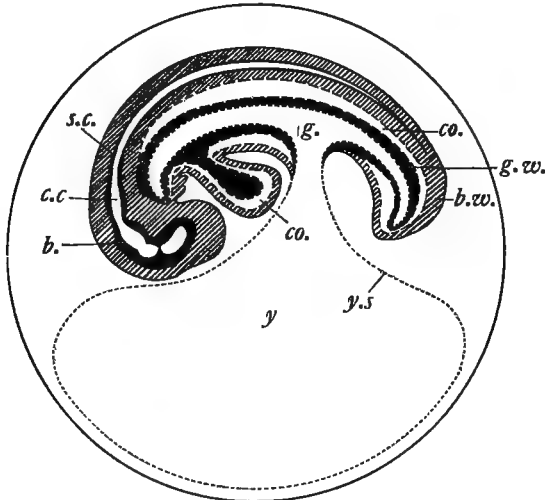


FIG. 207. Diagram of a longitudinal section of the embryo of a fowl, without the amnion and allantois. Ectodermal boundaries are in continuous lines, the entodermal and mesodermal are in broken lines; the entodermal of short dashes, the mesodermal of long. *b.* brain; *b.w.* body wall; *c.c.*, central canal of spinal cord; *c.o.*, coelom; *g.* gut; *g.w.*, wall of gut; *s.c.*, spinal cord; *y.s.*, yolk sac.

**Questions on the figure.**—What is the relation of the yolk sac to the digestive cavity? Which of the embryonic layers surrounds it? In what way is the abundant yolk in the yolk sac brought into the circulation of the embryo (see reference texts)?

440. **Reproduction and Development.**—Reference has already been made to the fact that the right reproductive organs of the female birds are much reduced or wanting. The ovum is always large, containing abundant yolk. When mature it breaks from the ovary, enters the funnel-shaped end of the oviduct and as it passes outward is fertilized. It then receives



a layer of albumen, and later is surrounded by a membranous covering and by a porous, limy shell, all of which are secreted by the walls of the oviduct. The protoplasm is confined to a small germinal disc and segmentation is discoidal, resulting in a blastoderm like that of reptiles. In the newly laid egg cleavage

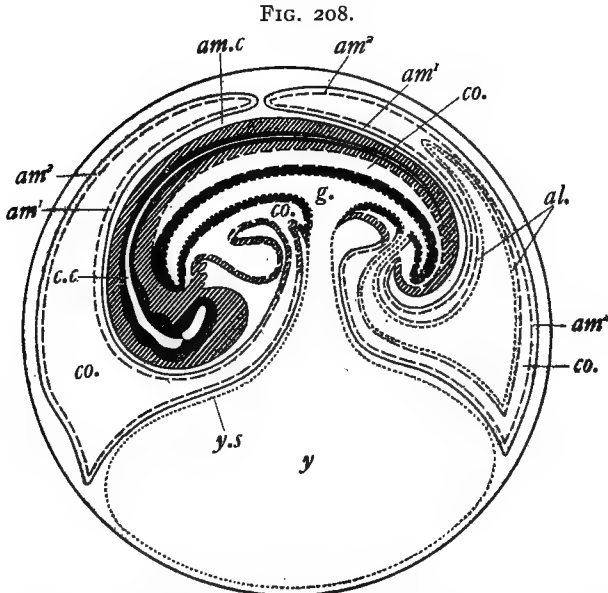


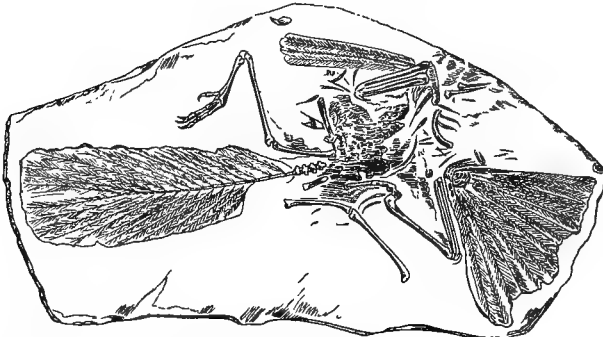
FIG. 208. Diagram of a longitudinal section through the embryo of a fowl, showing formation of amnion and allantois and the relation of these membranes to the embryo. The boundaries are as in the preceding figure. *am*<sup>1</sup>, inner or true amnion; *am*<sup>2</sup>, outer or false amnion; *am.c.*, amniotic cavity; *al.*, allantois; *c.c.*, central canal of the spinal cord; *co.*, coelom; *g.*, gut; *ys.*, yolk sac.

**Questions on the figure.**—Which of the three embryonic layers enter into the amniotic folds? Which go to form the allantois? Show that the cavity between the true and false amnion is “extra-embryonic” coelom. How is the amniotic cavity lined? With what is the yolk sac lined? The cavity of the allantois is in reality a portion of what cavity? Which of these membranes unite in mammals to form the *chorion* (see §462).

is well advanced. After the egg is laid, cleavage is checked until the necessary temperature for further development is supplied either by the brooding of the parent or by some special device. Owing to the action of gravity on the heavier yolk the living disc is always directed upward,—the position most favorable for getting the warmth of the parent’s body in incuba-

tion. For the details of further development the student must be referred to more extensive texts, but it may be stated that the blastoderm comes to consist of two layers of cells which have been likened to two watch glasses so placed as to enclose a shallow cavity. The outer layer is ectodermal and is continuous at the edge with the inner, which is composed of larger cells incompletely separated from the yolk beneath (Fig. 13, C, 4). This inner layer gives rise to both entoderm and mesoderm. The blastoderm continues to grow at the margins until the yolk is entirely enveloped by a living membrane which is well supplied with blood vessels and serves to extract the food for the use of the embryo and to aerate the blood before the lungs become of use.

FIG. 209.

FIG. 209. *Archaeopteryx lithographica*, an early reptilian Bird. From Claus.

**Questions on the figure.**—What in the figure shows this to be a bird? What shows it to be different from typical birds? What is signified by each of the terms in its scientific name?

The amnion and allantois (see §423; Fig. 208) are both developed as in reptiles. Of these the amnion appears first. By a study of Figs. 207 and 208, together with others in the reference texts, it will be seen that the amnion is an outgrowth of the body wall of the embryo and has a cavity continuous with the coelom. The outer layer is known as the false amnion; the inner is the true amnion (Fig. 207,  $am^2$ ,  $am^1$ ). Into the space between the amnion-layers the wall of the gut evaginates, forming the allantois (Fig. 208, *al.*). The cavity of this sac is continuous with the lumen of the gut. The embryo thus becomes com-

pletely surrounded by protective membranes. The cavity between the true amnion and the body wall (Fig. 208, *am. c.*) is the amniotic cavity and may be filled with a fluid.

#### 441. Classification of Aves.

*Subclass I. Archæornithes.*—These are extinct birds related to the extinct reptiles—the dinosaurs—in having a vertebrated tail, and jaws bearing teeth. Each vertebra of the tail possessed

FIG. 210.

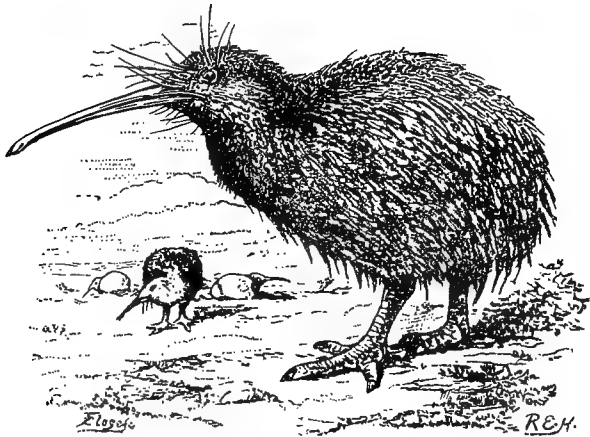


FIG. 210. *Apterix australis*. From Romanes.

**Questions on the figure.**—What peculiarities does this bird present? What does *Apterix* mean? What is the distribution of this species? What are its nearest relatives among the birds?

a pair of feathers, the tail thus having a row of rectrices on either side.

Archæopteryx, of which three specimens have been found in the lithographic quarries of Bavaria, represents the group and was about the size of a crow (Fig. 209).

*Subclass II. Neornithes (modern birds).*—This group is characterized by the reduction and fusion of the tail vertebrae in such a way that the tail feathers (*rectrices*) are arranged in a semicircle (or sometimes wanting). Teeth are wanting except in some extinct forms, which stand intermediate between the Archæornithes and the recent birds.

*Division I. Ratitæ (flat).*—These are running birds with a

flat breast bone (*i.e.*, no *keel*) and with all the organs of flight much reduced. The barbs of the wing and tail feathers are not held together by barbules, thus producing plumes.

The Ratitæ are the lowest forms of living birds and include the ostriches, emus, cassowaries, in all of which the wings are reduced, and the Apteryx or wingless bird of New Zealand (Fig. 210) in which they are very rudimentary. The ostrich (Fig.

FIG. 211.

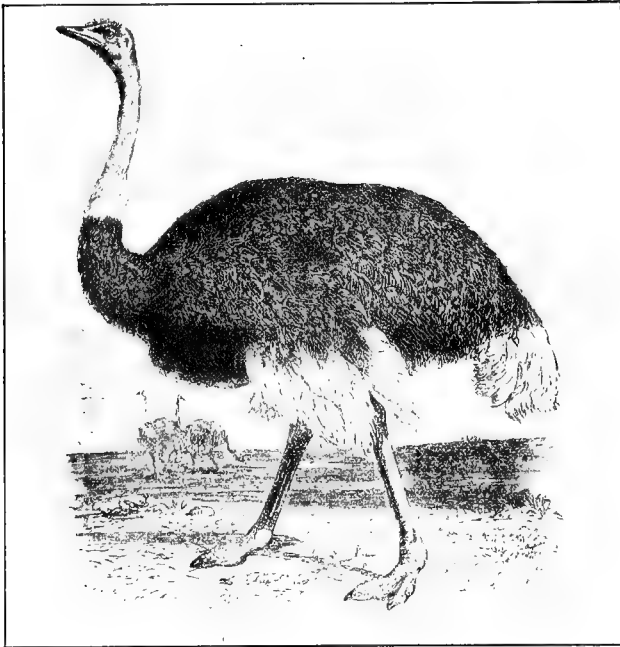


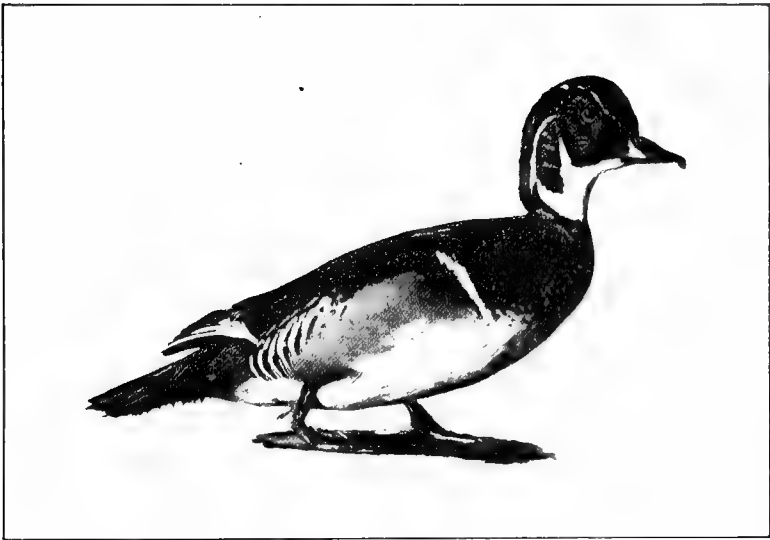
FIG. 211. Ostrich (*Struthio*). From Wood's Natural History.

**Questions on the figure.**—Which of the types of feathers of ordinary birds become the plumes in the ostrich? What is the real size of the ostrich?

211) is the largest and most powerful of living birds. Ostriches are somewhat gregarious, and frequent regions more or less desert. At mating time they unite in pairs, the male assisting in incubating the eggs, which are laid in holes in the sand. Ostrich culture is an important industry in South Africa and

to a certain extent in America, on account of the plumes which are extensively used as ornaments. Besides the types mentioned there are a number of extinct forms belonging to this division, some of which have become extinct in recent time. *Apyornis* is one of these, formerly a native of Madagascar, where remnants of its eggs have been discovered showing that

FIG. 212.

FIG. 212. Wood Duck (*Aix sponsa*). Photographed by Dr. J. W. Folsom.

its volume was about six times that of the ostrich egg, *i.e.*, having a capacity of about two gallons.

*Division II. Carinatae* (with a keel).—Birds with the keeled breast bone, the wings, and the other organs of flight usually well developed. Barbs of the feathers have barbules. All the modern flying birds are embraced in this group.

The further subdivisions of the Carinatae, as given in the recent classifications, based upon internal structure, are regarded by the author as unsuited for beginners. An older arrangement of the principal orders, based upon habits and certain superficial features, is presented below for the convenience of the

student. It should be remembered, however, that the classification is not the best possible, inasmuch as forms in reality not very closely related in structure are, according to it, placed together because of similar habits. The student is asked to refer to other texts for different arrangements. Some of the important orders are as follows:

FIG. 213.



FIG. 213.—Ross's Gull (*Rhodostethia rosea*). Upper figure adult male; lower, young female. From "Chapters on Natural History"; drawn by Dr. R. W. Shufeldt after Ridgway.

**Questions on the figure.**—What indications of structural adaptation to habits do you find in the figure? What sexual dimorphism is perceptible?

The *Pygopodes* (*feet on the rump*) include the auks, grebes, and loons. These are all aquatic birds and are expert divers and swimmers. Their feet are poorly adapted for the land, and in consequence the birds are awkward. Auks have poorly

developed wings. Loons however are good fliers. Auks and puffins are marine forms. The loons and grebes are found in fresh waters and use flags and rushes for nests.

FIG. 214

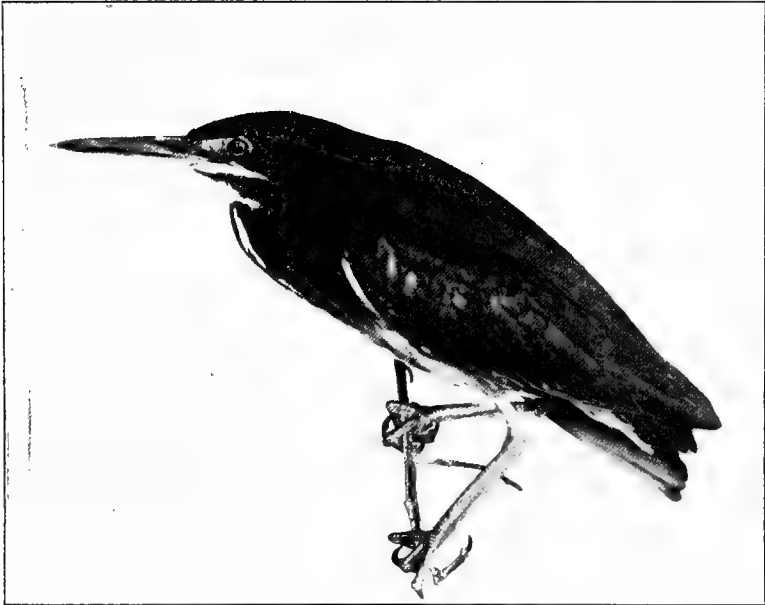


FIG. 214. Green Heron (*Butorides virescens virescens*). Photographed by Dr. R. W. Shufeldt

**Questions on the figure.**—To what order of birds does the heron belong? What are its nearest relatives? What can you say of the habits of the order?

The *Longipennes* (*long-winged*) are the tern, gulls, etc. These are aquatic birds with webbed feet and long, pointed wings. They are splendid fliers and mostly good swimmers. There are both marine and fresh-water types. They are gregarious, especially at the breeding season, when they swarm on sandy shores, in the marshes, or on the rocky coasts, where they lay their eggs in crude nests or on the bare rocks. They are the most common birds of the seashore and the high seas.

In the *Steganopodes* (*web-footed*) are included cormorants, pelicans, etc. These are large water birds in which the legs are

usually long and the feet suited to wading and swimming. They are heavy eaters, living largely on fish. They are often expert fishermen,—the white pelicans acting in concert in driving the fish before them into shallow water, where they capture numbers of them in a capacious pouch of the lower jaw. The flamingos are long-legged, wonderfully colored birds with most interesting gregarious nesting habits.

FIG. 215.



FIG. 215. A right lateral view of the skull of the American Flamingo (*Phenicopterus ruber*)  
Photographed from specimen by Dr. R. W. Shufeldt.

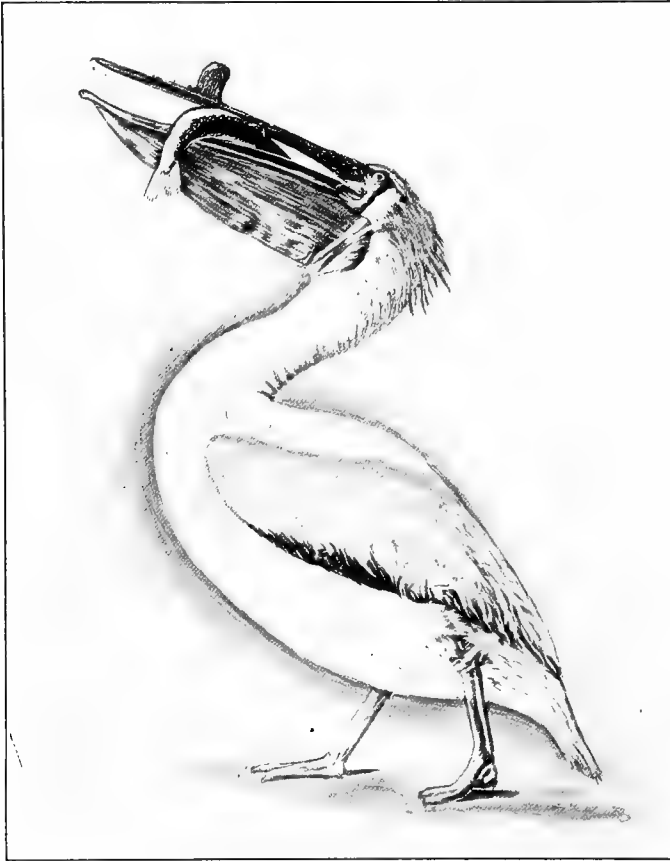
**Questions on the figure.**—Distinguish upper and lower jaws, comparing them as to massiveness. Is this the usual condition in birds? How much of the skull is occupied by the brain? To what habits of the flamingo is the form of its beak an adaptation? Compare with Fig. 219.

The *Anseres* (*geese*). The geese, ducks, and swans are familiar because of their widespread migrations and because of numerous domestic varieties. They have heavy bodies and characteristic form (Fig. 212). Three toes are united by the web. Their bills are broad and serrate. They feed upon vegetation and the smaller water animals. Their wings are long and



broad, and they are good fliers. The ducks and geese spend their winters in the tropics and nest in the colder regions. They are much hunted by man during these migrations, when

FIG. 216.

FIG. 216. Pelican (*Pelecanus erythrorhynchos*). By Folsom.

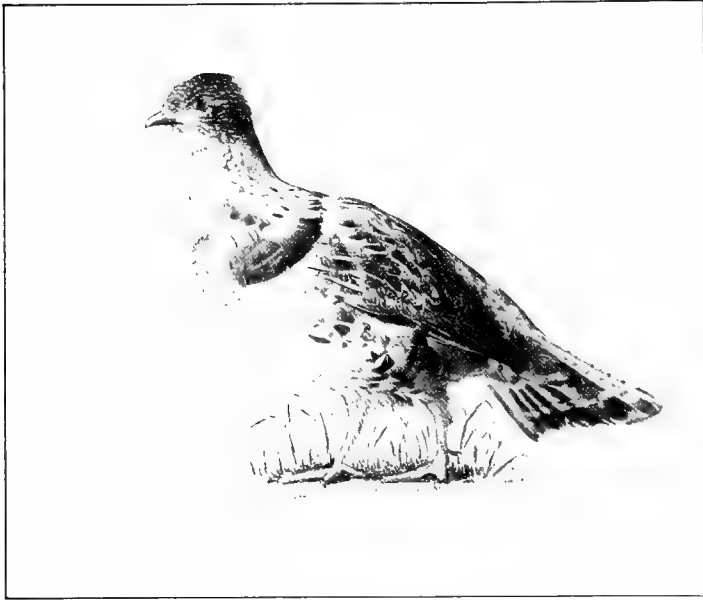
**Questions on the figure.**—What is the nature and purpose of the fold beneath the jaw? To what division of the birds does the pelican belong?

they frequent the streams and lakes of the temperate regions. They are found the world over. There are said to be about forty species and subspecies of ducks, eighteen species and sub-

pecies of geese, and three species of swans native to North America north of Mexico.

*Paludicolæ* (*living in swamps*). This group includes marsh birds which stalk about the shallow waters picking up the small animals to be found there. They have long legs and correspondingly long necks. The cranes, trumpeters, rails, coot, and gallinules are classed here. Their toes are not completely

FIG. 217.

FIG. 217. Ruffed Grouse (*Bonasa umbellus umbellus*). Photographed by J. W. Folsom.

webbed. They are light birds in proportion to the reach of their neck, legs, and wings.

*Limicolæ* (*shore-residents*) inhabit the margins of streams and lakes and may wade in the shallows. These are similar in many ways to the preceding group, but are smaller birds. The group embraces the snipes, woodcock, sand-pipers, plover, killdeer, avocets, and many others. They have slender legs and long bills. They are alert birds with quick, active habits,

FIG. 218.



FIG. 218. Nelson's Parnassian. Shufeldt, after Ridgway.

protectively colored, and take promptly to cover. For these reasons they are "game" birds, sought by hunters.

*Raptors* (*robbers*) are preying birds with hooked beak and claws, sharp vision, powerful wings, and instincts to match.

FIG. 219.

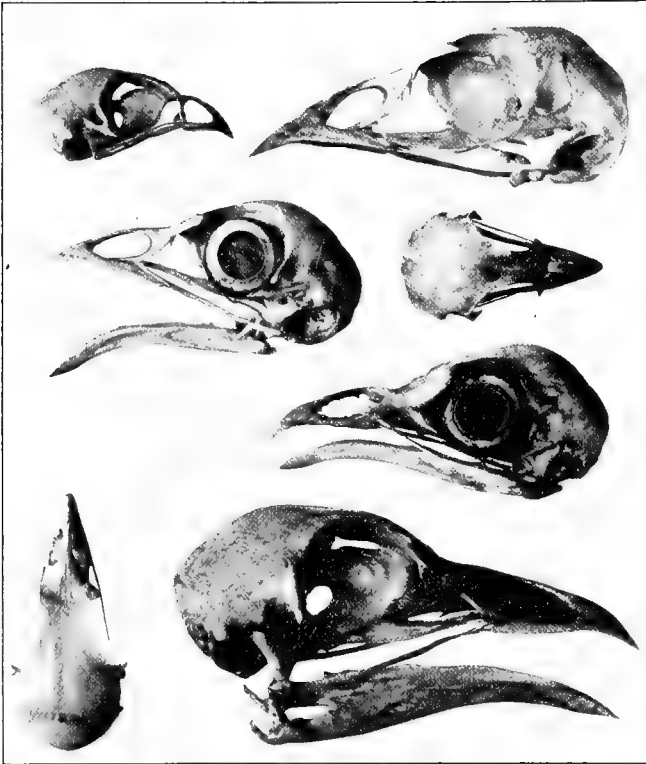


FIG. 219. Skulls of gallinaceous Birds, as Partridge, Grouse, etc. Photographed from the specimens by Dr. R. W. Shufeldt. Adult.  $\frac{1}{2}$  natural size.

**Questions on the figures.**—Compare these skulls and note the points of similarity and dissimilarity. Find the position of eye, ear, and nares. What are the chief points of contrast between these skulls and that of the owl (Fig. 222), and of the flamingo (Fig. 215)?

Eagles, hawks, kites, falcons, owls, and vultures may be classed here. They are widely distributed, and have a great range of size and adaptations. The vultures, including the buzzards

and the great condor of South America, are scavengers. The owls are noted for their striking appearance and for their nocturnal habits and the adaptations associated therewith.

FIG. 220.



FIG. 220. Great horned-owl (*Bubo virginianus virginianus*). Adult female. Photographed from life by Dr. R. W. Shufeldt.

**Questions on the figure.**—What are the habits of owls? Does the figure show any structural adaptations to known habits? How does the standing position of the owl differ from that of other birds of your acquaintance? See also Figs. 221 and 222.

There is a strong human prejudice against the group, partly because some of the members attack our poultry and other domestic animals. Close observation shows, however, that most

of the species are either harmless or actually helpful because they destroy noxious rodents. Cooper's hawk, the sharp-shinned hawk, and the great horned owl are real pests.

The *Gallinæ* (fowls) include quail, partridges, grouse, pheas-

FIG. 221.



FIG. 221. Great horned-owl (*Bubo virginianus virginianus*). Young. Photographed from life by Dr. R. W. Shufeldt.

**Questions on the figure.**—Compare the young at all points with the adult. What are the points of difference? Of manifest likeness?

ants, turkeys, peafowls, and the various kinds of chickens. These birds have a plump, characteristic form. The legs are mostly short or of medium length and armed with short, blunt claws. The beak is stout and bent slightly downward at the

point. As a rule they do not take long flights. They nest on or close to the ground and they get their food there. They are less highly organized nervously than many birds, and more readily tamed. Their habits of life furthermore fit them for domestication. They have large broods, and in early life these

FIG. 222.

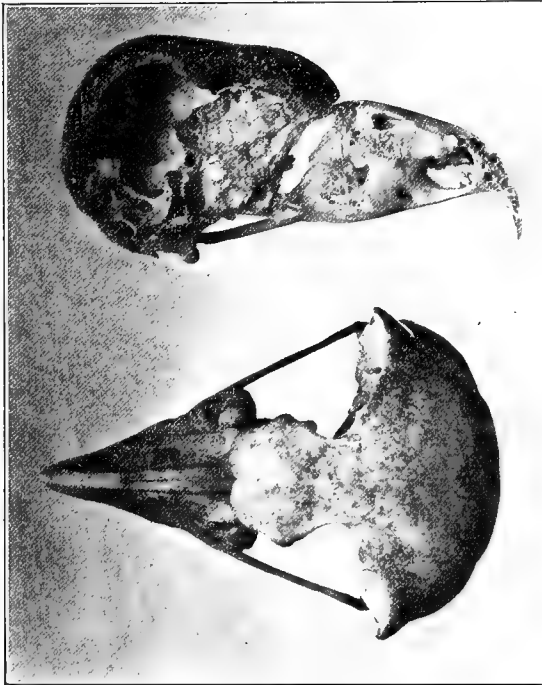


FIG. 222. Skull of Owl (*Strix varia varia*). After Shufeldt, photographed from specimens. Upper figure bisected, showing brain-case; the lower from a dorsal aspect.

**Questions on the figure.**—Is the owl a bird of prey? What is the position of the eyes in relation to the skull? Of the nares? Compare these figures with the head of the owl (Fig. 220), and with the skulls in Fig. 219.

follow the mother bird closely. This instinct may linger into adult life and families often remain together in “coveys” throughout the first year, or even longer. Thus large flocks may be formed. Their secretive instincts, their protective markings, and their edible flesh make them “game” birds of first quality.

Before civilized man destroyed their haunts and persistently hunted them with his improved weapons, these were among the very successful wild birds. Most species are now really quite scarce. The only hope of preserving them is by legal protection at critical times or by domestication.

Chief among the domesticated birds is the common fowl which is descended probably from a species native to southern

FIG. 223.



FIG. 223. Belted Kingfisher (*Ceryle alcyon alcyon*, L.). About one-fourth natural size. By J. W. Folsom.

Asia, *Gallus ferrugineus (bankiva)*. By breeding and selection almost innumerable varieties have been produced. The poultry and egg industry is one of the most important in the country, amounting to more than 700,000,000 dollars annually. In 1920, about two billion dozens of eggs (estimated) were produced on the farms of this country. This is one of the great and reliable sources of human food. Turkeys, guinea-fowl, and pea-fowl contribute in less degree.

The *Columbæ (doves)* are in many respects similar to the



FIG. 224.



FIG. 224. Arctic three-toed Woodpecker. From U. S. Dept. Agriculture, "North American Fauna."

FIG. 225.

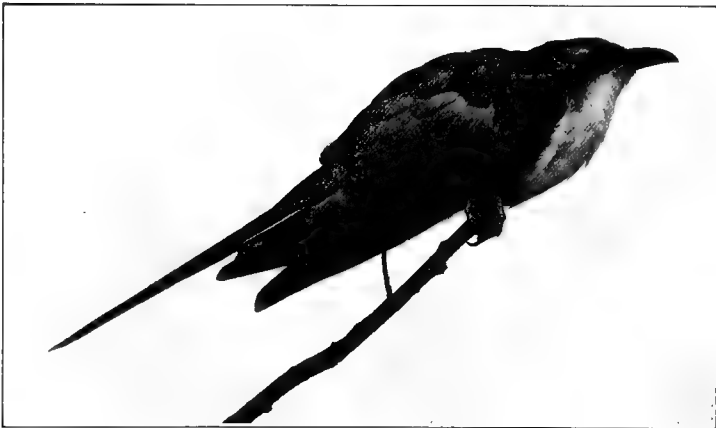


FIG. 225. Yellow-billed Cuckoo (*Coccyus americanus americanus*). Adult male. Photographed from life by Dr. R. W. Shufeldt.

**Question on the figure.**—What are the nearest relatives of the cuckoos among the birds?

FIG. 226.



FIG. 226. Clark's Crow. U. S. Dept. Agriculture: "North American Fauna.

FIG. 227.

FIG. 227. Nestling Crows (*Corvus*). From U. S. Dept. Agriculture Year-book, 1900.

*Gallinæ*. With the doves are included the pigeons. About a dozen species are found in America. None of these species is very numerous. A century ago the passenger pigeon occupied the region east of the Mississippi River in great flocks numbering millions of individuals. In the hope of saving the species there has been for some years a standing offer of considerable sums of money for information of a nesting pair of this species. It seems to be extinct. The domestic pigeon, in its numerous varieties, has arisen by breeding and selection from

FIG. 228.

FIG. 228. Gold-finch (*Astragalinus tristis tristis*). U. S. Dept. Agriculture Year-book, 1898.

the blue rock pigeon of the Old World. In cross breeding we frequently get "reversions" to this type, showing that the characters are being carried in the germ plasm even when the combinations were not such as to make them appear in the body.

In this group the young are fed with food digested by the parent and regurgitated into the mouth of the helpless but willing young.

The *Pici* (*woodpeckers*) have two toes directed forward and two backward in adaptation to the position they take in climbing. The tail may have stiff, pointed feathers with which they

FIG. 229.



FIG. 229. Mocking Bird (*Mimus polyglottos polyglottos*). From Dept. Agriculture Year-book, 1895.

FIG. 230.



FIG. 230. Wood Thrush (*Hylocichla mustelina*). Female, one-half size. By J. W. Folsom.

anchor when pecking or climbing. They have strong, sharp, chisel-like bills. By means of these they get at insects under the bark of trees, dig into the tender cambium of plants, and even excavate cavities for nests in the timber. With their long, protrusible tongue they pick up insects routed out by the hammering of their beaks. The tapping sound is also a means of attracting mates. Some species bury acorns in holes they have made in the trees, returning for them when food supplies are low.

FIG. 231.

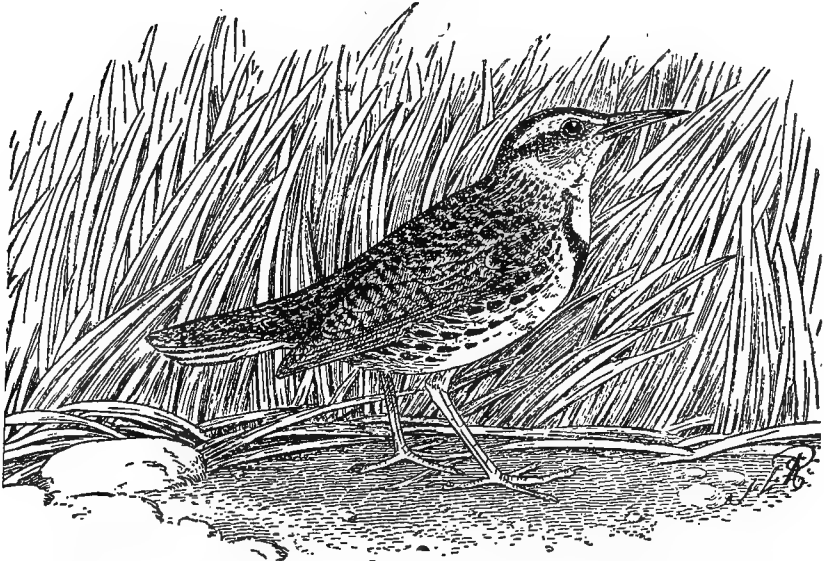


FIG. 231. The Meadow Lark. From U. S. Dept. Agriculture Year-book, 1895.

They are conspicuous birds, often most interestingly colored. Our most common forms are the red-headed woodpecker, the downy woodpeckers, the flicker, the yellow-bellied sapsucker. The latter is an injurious species, as it opens trees to decay and attacks of fungi, and probably spreads such diseases. The rest help keep in check various insect pests.

Near the woodpeckers are often classed the cuckoos, kingfishers, and toucans or hornbills. The kingfisher and rain crows or American cuckoos are likely to come under the observation

of the student. Some species of cuckoos lay their eggs in the nests of other birds, where they are hatched and fed by the host. In return for this they are said often to cast the young of the proper owners out of the nest.

The chimney-swifts, whippoorwill, and the humming birds are somewhat intermediate between the forms just spoken of and the next order.

The *Passeres* (*sparrow-like*) is the greatest order of birds. It has more than sixty recognized families and more than 6,000

FIG. 232.

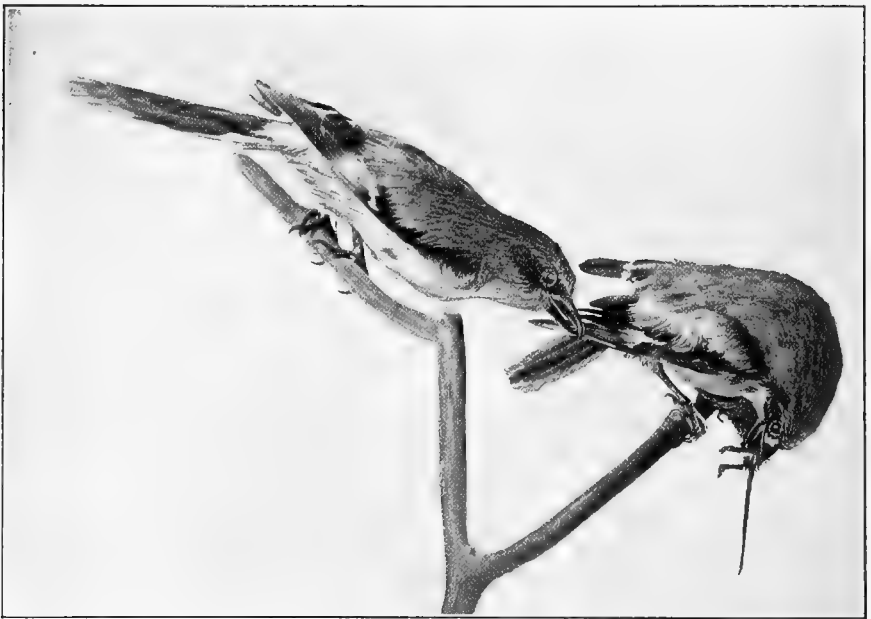


FIG. 232. Loggerhead Shrikes (*Lanius ludovicianus ludovicianus*). By J. W. Folsom.

species. About twenty to twenty-five of these families are found in North America. These birds are mostly small, with three toes in front and one behind, and adapted to perching. The majority are gifted with some powers of song (*oscines*). A smaller division, of which the king bird and phoebe may be taken as types, are known as chattering or crying birds (*clamatores*).

Among the families of *oscines*, which the student is most

likely to meet, are: the crow family (*Corvidæ*; Fig. 226) including crows, and blue jays; the sparrows and finches (*Fringillidæ*), including also snow birds, crossbills, and grosbeaks; the oriole family (*Icteridæ*) including orioles, bobolinks, meadowlark, and the blackbirds; the warblers (*Mniotiltidæ*), small migrating birds with bright colors and most interesting and attractive qualities; the wrens (*Troglodytidæ*); and, finest of all, the thrush family (*Turdidæ*), including the various thrushes, the robin, bluebirds, and many others.

For further description of the numerous interesting families of Passeres the student must refer to some special book on birds. The study of their habits and form constitutes one of the most popular and entertaining subjects of natural history for the recreation studies of busy people. Much good, and some very indifferent, literature intended for guidance in such studies is now being produced.

442. **Relation to Surroundings.**—It is easy to be seen from the foregoing discussion that birds, while very much alike in fundamental structure, have succeeded in adjusting themselves to a remarkably varied life. In structure this adaptation is shown in the size and shape of the body, in the modifications of such external structures as neck, beak, legs, toes, claws, wings, and tail. Among the instincts and habits the following have a large place in the adaptations of birds: the food habits, instincts of mating and of song, nesting and breeding instincts, care of young, and response to climatic changes as shown in the migration impulses.

Wings vary from the most rudimentary, as in the ostrich and apteryx (kiwi), to the powerful ones of ducks which drive the birds at a rate of ninety miles an hour. The tail is equally variable. There may be no special tail feathers, as in the kiwi, or the tail may be of the most striking character, as in the male peafowl or bird of paradise. In these extreme styles, as in many birds of smaller size, the tail is a sex development, the male usually having greater specialization. Tails of more normal size serve as balancers when the birds are perched and as rudders when they fly.

The legs and neck are closely related in length. If the legs

are long the neck must be of corresponding length to allow the head to reach the ground. Long legs are often coupled with a wading habit; though in the ostrich and some of the land birds length is associated with the running habit.

The feet,—including the number and position of toes, the character of the claws, and the presence of the web,—are a good index of the manner of life. The amount and arrangement of the web varies greatly in the different water birds. The beak and the feet, though separated by the extreme length of the animal are really three appendages which work together. Aside from the prime functions of the feet in walking and swimming, the beak and claws work in close cooperation in getting food, in offense and defense, and in the nest-building operations. Both claws and beak are strikingly adapted to the food habits.

By means of the *syrinx* (§437) most birds produce sounds. In the higher birds (oscines) the sounds may become highly organized and melodious. Such songs are for the most part related to mating and the breeding season. The call-notes are more permanent though not so full of melody. By these the birds express such simple emotional states as fear, anger, contentment, and excitement. They are a simple language well understood by the other members of the species. It is probable that the mating songs are similarly expressions of the exuberant emotions of the mating time, which become sustained and elaborated from the pleasure they come to give the producer. In other words they represent a passage from the useful to the esthetic even for the bird himself.

The succession of instincts which in the spring will cause even one-year-old birds to go with remarkable precision through the migration, courtship, mating, the selection of a suitable place and materials for nest making, egg-laying, incubation, feeding and protecting the young, and finally their introduction to the world, is at once the marvel and despair of the naturalist. In all these respects there is the greatest variation. Some mate yearly, others mate for life. Some conceal their nests with greatest ingenuity and build it with great care, while others lay their eggs in the barest possible places. They may lay one egg or a score. Incubation of the eggs may be performed by the



female, by the male, or by both. The male may supply the female with food during incubation or pay no attention to the process. The young may be ready to leave the nest and run about as soon as they are hatched and dry (*precocious*) or they may be naked and helpless for days (*altricial*).

The coloration of birds is most varied and interesting. They are to the vertebrates what the insects are to the invertebrates. As in insects, the color is due to pigment, to physical surface markings which produce luster, or to both. Males and females are often differently colored; if so the males are the more striking. Young birds, before the sex qualities appear, are more like the females.

Some birds are differently colored at different seasons. Where there is a difference the more highly colored feathers are produced in the winter and spring as the mating period approaches. Color in birds is believed by some to be due to the high metabolic activity they show. This activity is believed to produce pigments as waste products. These come to be represented in the coloration of the feathers. The metabolism is more active at the mating season. Color may be useful to birds in two ways. It may serve as recognition marks by which members of the species may quickly recognize each other, and it possibly proves attractive to mates; and in some instances at least it serves for concealment because of likeness to the surroundings.

The eggs of birds are frequently remarkably colored. This color is in the calcareous secreted shell. It is due to pigments secreted by certain cells in the oviduct. The color of eggs of a species is often as distinctive as the color of the bird. It may be uniform, or in definite spots, or in irregular splotches. It is probable that the coloration of eggs is also frequently protective.

None of the bird's responses to its conditions is more striking than the act of migrating. Some do not migrate, but most do. The value of the instinct is clear enough. Each species has its own customs. The time of starting, the route, the rate of migration, and the termini vary for different species. Usually the rate is not rapid. Some fly pretty steadily for considerable distance. The ducks work their way along the streams and lakes, or from one to another. The warblers flit from forest to

forest, from tree to tree, or along the fence rows, living on the country. Sometimes it is just a slow retreat before the advancing cold or progress with the advancing spring. At other times it may involve long flights.

The golden plover illustrates an extreme case. They breed in the arctic circle in June and July. They "winter" south of the equator in South America from September to March; that is to say during the southern summer. Their course in the northward spring migration is not fully known, but it is believed that they follow an overland route over northern South America, Central America, Mexico, Central United States and Canada to their Arctic breeding grounds. The return journey southward is better known. From their breeding grounds they go to Labrador in August. Here they feed on berries and grow fat after their relative fast. They work their way down to the coast of Nova Scotia. Here they desert the land and fly across the ocean to the eastern shoulder of South America. They may stop temporarily in the islands of the West Indies; or they may make the whole distance apparently without stop. In the course of a few weeks they cross the equator and reach their southernmost terminus in Argentina. Some other species have been followed with equal care and have almost equal range.

Birds have many enemies among animals. Some of the birds are prey to other birds. Snakes, some lizards, and many of the smaller mammals feed upon them whenever they can. Many eggs are eaten by these and other animals. During the nestling stage birds are in especial danger. The parents themselves are often taken at this time. Man himself has probably proved the worst enemy of the birds, which is scarcely wise or fair, since the birds are among his best friends.

443. **Relations of Birds to Man.**—Man has directly destroyed many of the wild birds for food, for their plumage, for sport, or because he deemed them injurious to his interests. In an indirect way he has destroyed even more. Many of the birds do not take kindly to civilization, but prefer the quiet of unchanged nature for feeding and breeding. Such birds have been gradually pushed into more limited or less favorable territories.

Others have adjusted themselves to human surroundings and to our crops of grains and fruits. These have suffered less; indeed some species increase in numbers more than would be possible in the wild state. Still others have been domesticated, and by breeding, selection, and support have been greatly changed and improved for human uses. The birds that have been domesticated are chiefly the ostriches, members of the goose family (ducks, geese, swans), several Gallinæ (chicken, turkey, guinea-fowls, pheasants, pea-fowls) a few of the Raptores (as the falcon), the pigeons, and occasional members of other orders, as parrots, magpies, and a few song birds.

The student of Zoology should not fail to familiarize himself with the main types of chickens which have been developed. A few of the main classes of breeds are as follows: the Asiatic breeds, including Brahmas, Cochins, Langshans; the Mediterranean breeds, including Leghorns, Minorcas, and Black Spanish; the Dutch breeds, Hamburgs and Red-caps; the French breeds, Houdans, and Crevecœurs; the English breeds, as Orpingtons and Dorkings; the American breeds, as Plymouth Rocks, Wyandottes, Dominiques, and Rhode Island Reds; and fancy breeds as the Bantams, game birds, etc.

The special egg breeds are the varieties of Leghorns, Minorcas, Spanish, and Red-caps. The meat-producing breeds are Brahmas, Cochins, and Langshans. The Plymouth Rocks, Wyandottes, Rhode Island Reds, Orpingtons, and Dorkings are desirable breeds for general service in both respects.

Aside from the food values of poultry, the group of birds renders man most notable service in two ways,—by destroying noxious insects and by eating weed seeds. To be sure they do take some toll in cultivated grains and in fruits; but with very few exceptions it has been shown by examination of stomach contents of various species at various ages that the great bulk of the smaller birds are helpful to human interests, and often greatly so. One observer found 7,500 seeds of one common weed in the stomach of one dove. If all birds were suddenly destroyed, unquestionably many species of insects would at once increase to the point where they would be a fearful pest to mankind, before a new balance in nature would be struck. Mice and

other hurtful rodents are captured by owls, hawks, and other preying birds.

These facts are at the bottom of the recent agitation that egg collecting and the slaughter of birds for sport shall stop. A careful, seven year investigation of the subject yields the following list of birds which do more injury than good: the English sparrow, Cooper's hawk and the sharp-shinned hawk, the sapsucker, and the crow. Recent investigations show that the robin is the most numerous bird in the United States, averaging six pairs to every farm of 58 acres. The English sparrow comes second with five pairs to that area. For every 100 robins there were found 49 catbirds, 37 brown thrashers, 28 house wrens, and 26 bluebirds.

The skins and feathers of birds have been much used for ornament by savage men and civilized woman. The traffic in skins and plumes has been a very extensive and profitable one, and is calculated to hasten the extermination of some species. Laws are gradually becoming more prohibitive and public sentiment is coming to support them. Shooting birds for sport and encouraging killing them for their plumage are alike barbarous. The national government, the states, and private individuals should be encouraged to establish preserves where birds may not be killed.

Because the undigested material from the digestive tract and the nitrogenous excretion from the kidneys are eliminated together the manure of birds is very rich. Large deposits of this material, known as guano, are found along the dry coasts and islands on the west shore of South America. It is deposited by sea-birds that have lodged there for ages. The richest of these deposits are already exhausted.

Of a real vital value to man are the song and color and the poetry of the life of birds. These esthetic features of birds and their wonderful habits and instincts have attracted thousands of people to the fields and woods. Man cannot get back to nature and the wild life in an open-minded and appreciative way without being the gainer. It is by no means a shallow appeal that we encourage the bird life in order that nature may be kept as interesting and beautiful as possible. The fact

that birds are useful need not obscure the fact that they are interesting.

**444. Special Topics for Investigation in Field and Library.**

1. Enumerate the special structural features which seem to fit birds for successful flight. Compare different birds as to these features? What are the different modes of flight? Compare the flight of the buzzard, the woodpecker, the quail. What is the action of the wings in flying? Of the tail? What is the effect of clipping one wing? Why? The rate of flight in different species of birds.

2. Study the group of birds from the point of view of their social and gregarious instincts. Are any solitary? Do any have varying social habits during different seasons?

3. Make a general study of the migrations of birds, collecting the facts as to range, time, supposed causes, the effects on the species and its geographical distribution, the degree of exactness in routes and the place of return.

4. Make a special study of the birds of the locality in which you are. Are there permanent *residents*? Summer residents? Winter residents? *Migrants* (those which stop only for a short time in the spring or autumn as they pass from south to north or the reverse)? Keep a record from year to year of the earliest dates at which migrating species are seen in your locality.

5. What diversity is there in the mating habits of birds? Are any monogamous? Polygamous? What are the mating and nesting habits of the cuckoo?

6. Make a report as to the nest-building habits of selected species of birds. How do the nests differ in location, in mode of formation, in perfection? Is there any relation between the character of the nest and the degree of development of the young when hatched? What range of variation in the number of eggs? In the mode of incubation? The period of incubation? Care of the young after hatching?

7. Compare the vocal powers of birds with that of vertebrates hitherto studied. Compare various types of birds as to the range and character of their notes. How are the notes of birds related to their states of mind? Which are more vocal, the males or the females? What explanations are offered for this?

8. What is the history of the English sparrow in this country? What are its habits? How do you account for its rapid spread?

9. Make a special study of the local distribution of the species of birds known to occur in your vicinity. Which prefer the meadows? The marshes? The streams? The woodlands? Do the different species nest in the same regions in which they feed?

10. The relation of selected species of birds to man. Are they helpful or harmful to his interests? Has he been helpful or harmful to them?

## CHAPTER XXIV

### CLASS V.—MAMMALIA (MAMMALS)

445. **Laboratory and Field Work.**—Almost any of the smaller mammals may be used in the following exercise. Different species may be taken with profit by the various members of a class. The chief points to be emphasized are the habits, instincts and external structure.

#### I. *Habits and Instincts.*

What are its natural haunts? What explanation can you offer therefor?

How does it protect itself from its enemies? What are its enemies? Is it active at night or by day? Reasons?

What are its habits as regards food? Evidences?

What can you say of its power and manner of locomotion?

Does the manner of motion differ materially with difference of rate?

Social habits? Mating habits? Care of young and their condition at birth?

Is it scarce or abundant? Apparent reasons?

What are its relations to human interests?

#### II. *General Form and Structure.*

Identify the regions of the body and compare the condition found here with that seen in the birds. Relation of axis of body to appendages. Compare the anterior and posterior appendages at all possible points, and indicate to what extent the work done by each is indicated by the structure. Examine the claws and the soles of the feet.

Examine the body-covering, and compare the various parts as to color, character of hair, etc. Does the hair completely cover the body? What is the position and use of "whiskers"? Evidences for your conclusion.

Locate all the external openings. Study the mouth with its contained structures; the eyes: position, color, lids (is

there a nictitating membrane?); ears. To what extent is the external ear developed?

### III. *Internal Structures.*

(The rat, rabbit, or cat will serve if it is desired to dissect a mammal). The student should map out his own laboratory outline by reference to descriptive texts. Two fundamental questions should be kept in mind in all such work: How do the discovered structures compare with those studied in other animals, particularly the vertebrates? What service do they render the animal and how well are they adapted to do the work put upon them? Make a record both by accurate description and by drawings.

446. The Mammalia embrace, on the whole, the most highly developed vertebrates. To this group man belongs. The birds are more highly specialized in some respects, but the mammals surpass the birds in the size and convolutions of the brain, and in the closer relations between the mother and offspring both before and after birth. The form of parental care seen in the Mammalia is an adaptation resulting in great advantage to the young, and has also produced a great improvement in the mental qualities of the parents. The class contains forms of very varying appearance and perfection of development, and suited to almost every mode of life. Many are aquatic, including the largest living animals, the whales; some burrow in the soil, as the mole and many rodents; some live largely in trees, as the monkeys, squirrels, sloths, etc.; a very few, as the bats, have acquired the power of flight; others—the vast majority—live on the dry land.

#### 447. **General Characteristics of Mammals.**

1. Air-breathing vertebrates in which the covering developed by the epidermis is hair.
2. Mammary glands in the skin of the female, by the secretions of which the young are nourished.
3. The diaphragm, a muscular partition, completely separating the body cavity into two, a thoracic and an abdominal.
4. Quadrupeds, with a few exceptions.
5. Heart four-chambered; temperature of the blood not

determined by that of the surrounding medium; red blood corpuscles not nucleated; one (the left) aortic arch persisting.

6. Two occipital condyles.

7. Chiefly viviparous (Prototheria are oviparous); foetus nourished during early development in the uterus of the mother, often being closely connected therewith by a complex structure known as the *placenta*.

448. **General Survey.**—There are two subclasses of mammals, Prototheria and Eutheria, which differ in mode of reproduction and in degree of development.

1. The *Prototheria* are the lowest and are characterized by the fact that they lay eggs, like reptiles and birds; there is a cloaca into which the alimentary, urinary, and genital canals open; the milk glands are poorly developed. The class is represented by the duck-mole,—an aquatic form, and the spiny ant-eater,—both natives of Australia and neighboring islands (Fig. 238).

2. The *Eutheria*, Division *Didelphia* (*Marsupials*) possess a *marsupium* or pouch, a fold of the skin into which the prematurely born young are placed and nourished until able to take care of themselves. The period of gestation is short and the connection between the embryo and the wall of the uterus is slight. In the group are embraced the kangaroo and other Australian forms, and the opossums of America. It is an interesting fact that the native Australasian Mammalia all belong to the Prototheria and the Marsupials (see Figs. 52, 62).

3. In the Division *Monodelphia* (*Placentalia*) there is a placenta or mass of closely interwoven maternal and embryonic tissue which unites the foetus with the wall of the uterus, by which arrangement the young gets its food and oxygen from the blood of the mother. The young are retained much longer in the uterus, and are consequently much more mature when born. All the common mammals belong to this group, which is distributed over the habitable part of the earth.

449. **Form.**—The axis of the body is usually separable into head, neck, trunk, and tail,—though the last may be reduced to a very small number of segments. The proportions of these



parts of course differ much and are to be connected with the habits of life. Most of the Mammalia are quadrupeds (except the allies of the whales, the porpoises, and the sea-cows); and all except man, and some of apes most like him, have the axis of the body in a horizontal position supported by all four appendages, or by the medium. The aquatic types—whales, porpoises, etc.—become more or less fish-like in form, in adapta-

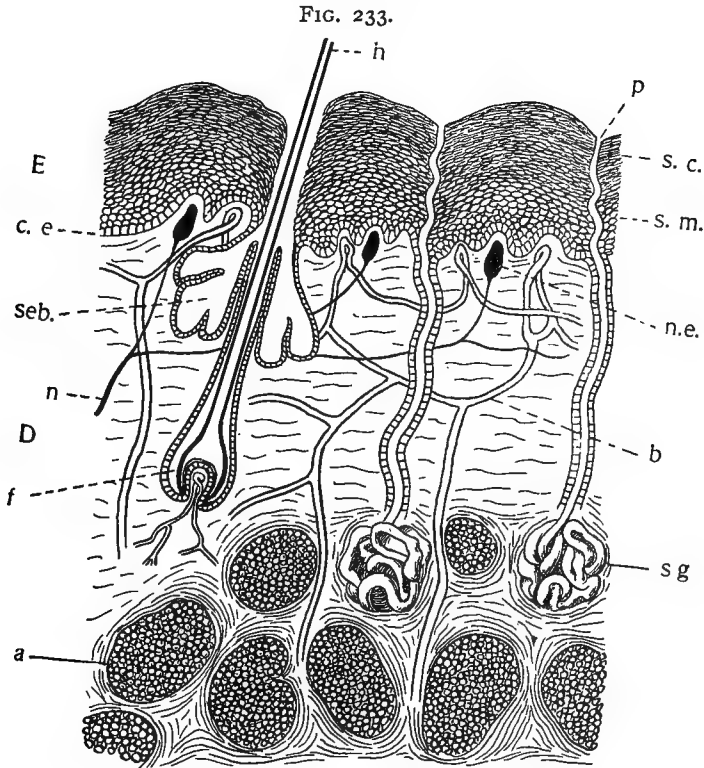


FIG. 233. Diagram of Skin in Mammals, by Folsom.

tion to the medium. There is an enormous range in size in the group,—from the mice to elephants and whales.

450. **Supplementary Topics for Laboratory and Field Work.**—Compare the relative size, length, etc., of head, neck, trunk and tail of various types of mammals, —using well known animals and the figures and descriptions of less familiar ones. Can you find any signs of connection between any of these facts and known habits of the animals studied?

Compare the anterior with the posterior appendages in a selected series of mammals, keeping in mind the following points: size, length, strength, uses; the number and character of the digits. Compare similarly the corresponding (*i.e.*, anterior with anterior) appendages in another series. Keep in mind, throughout, the adaptations of structure to the conditions of life, method of locomotion, etc.

451. **Integument.**—The skin, as in forms already described, consists of two portions,—an ectodermal portion, the epidermis, and the dermis or true skin which is derived from the mesoderm (Fig. 233). Hair is found in the young of all mammals, though it may be wanting in the adult (as in whales), or may occur only sparsely. Hair is produced by the epidermis, but is nourished by a papilla of dermal tissue (Fig. 233, *f*). Each hair consists of a central part, or pith, surrounded by a denser cornified portion, the cortex. Hair differs much in color and in structure,—from the soft fur of the seal to the quills of the hedgehog and porcupine. Hair is considered as morphologically similar to the feathers of birds and the scales of reptiles.

To be considered in the same connection with hair are the nails, claws, and hoofs, the scales on the tail of the rat or beaver and on the body of scaly ant-eaters, and the horny material of horns of cattle and of rhinoceros. The whalebone of certain whales is also an epidermal product in the roof of the mouth.

452. **Supplementary Studies for Field and Library.**—What is the economic value of the skins of mammals? How are they prepared for the uses to which they are put? What animals are prized for their hairy products (fur, wool, etc.)? What special qualities must the hair have to be useful in making cloth?

What instances can you adduce of advantageous coloring in the hair of mammals? What variations of color may be found within a single species? What changes of color are possible to a single individual? How are these changes brought about? What peculiar qualities have the quills of the porcupine?

453. **Integumentary Glands**, derived from the epidermis, are common in mammals. Associated with the hairs are the oil glands. Over various parts of the body are long tubular sweat glands buried in the dermis. There are also integumentary glands producing characteristic odorous substances. These may be for recognition within the species, or for protection from enemies. The tear glands of the eye are modified cutaneous glands.

The mammary glands, which are characteristic of the group, are specially developed skin glands, apparently more allied to

the sweat glands in their secretion. They are much lobed, and usually have teats or nipples; but in the monotremes these are wanting, and the young merely lick the secretion from a "milk area." The glands may be distributed along the entire abdominal surface (carnivora) or confined either to the anterior (primates) or posterior portion (ruminants). The number of the milk glands is correlated in a general way with the number of young produced at a birth.

454. **Skeleton.**—Some of the more elementary facts concerning the skeleton may be summarized as follows. The vertebræ usually unite by flat faces, and the five regions of the vertebral column (see §349) have a fair degree of constancy as to numbers. The neck, with a very few exceptions, has seven vertebræ, the length of the neck depending on the length of the vertebræ and not on their number. The trunk vertebræ, made up of the thoracic and lumbar, usually vary within the limits 19–23. The caudal vertebræ are most variable of all. The bones of the skull in the adult have their edges closely united by means of *sutures* (a species of close joint, which does not allow of motion). The lower jaw, the hyoid bone, and the small bones of the ear are the only movable bones in the mammalian skull. The lower jaw articulates directly with the cranium. The quadrate, which in reptiles and birds serves to articulate the jaw with the cranium, has apparently changed its position and given rise to one of the small bones of the middle ear.

The pectoral girdle and arm bones are always present, but in the whales and sea-cows the posterior are lacking. The digits are typically five in number. In many carnivores these may be reduced to four, terminating in claws. In the hoofed forms the toes are often reduced to four, three, two, or even one (the horse). In such cases rudiments of the remaining digits may occur in the form of splints.

455. **Teeth.**—The teeth are produced by the skin, and come to be lodged in pits in the bones of the jaws. While differing in shape, the teeth always possess the *crown*, the *fang* or root, the *neck* and the *pulp-cavity*. The bulk of the tooth is *dentine* deposited by the dermis. Over this is a layer of *enamel* formed by the epidermis. The teeth differ from horny outgrowths in that *both* layers of the skin are involved. In this respect they are like the scales of fishes and the plates of the armadillo

The cavity is more or less filled with "pulp tissue" which is supplied with nerves and blood vessels. Most mammals have only two sets of teeth,—a milk set which appears early and is lost and a permanent set which replaces the former. In some cases, however, there is only one set, and in a few (*e.g.*, certain whales) no teeth appear above the surface of the gums in the adult.

In the porpoises, dolphins and similar forms the teeth are

numerous, simple, and very much alike, but in the majority of mammals there are at least three types of teeth. In the front of the upper jaw (on the premaxillary bones) are simple, chisel-shaped teeth, the *incisors*; behind these (the first tooth on the maxilla) is the *canine* tooth, usually pointed and adapted for tearing; posterior to the canines are the grinders or *molars*. Those grinders which replace milk teeth are sometimes called *premolars*. The true molars do not have any representatives in the milk set. The corresponding teeth in the lower jaw are similarly named. The typical number of teeth is forty-four, eleven in each half-jaw. This may be shown by a formula in which the numerator indicates the number of each kind in one-half of the upper jaw and the denominator a similar portion of the lower:  $i. \frac{3}{3}, c. \frac{1}{1}, p. \frac{4}{4}, m. \frac{3}{3}, = 44$ . This means that there are three incisors, one canine, four premolars, and three molars in each half jaw, both above and below. The dental formula for adult man is:  $i. \frac{2}{2}, c. \frac{1}{1}, p. \frac{2}{2}, m. \frac{3}{3}, = 32$ . This may be written more simply  $\frac{2123}{2123}$ . The numbers are not always the same in the upper and lower jaw of mammals.

456. **Supplementary Studies.**—Let the student determine by examination, and write the dental formulæ of the cat, dog, horse, cow; milk set in man.

Compare the molars of some carnivorous animals with those of some herbivorous; similarly the canines. Describe the action of the jaws in the act of chewing in the dog, cow, rabbit, horse.

457. The **Digestive Organs** present the same regions and general arrangement found in the typical vertebrates. There are usually fleshy and movable lips covering the teeth. Sometimes these are much extended and in connection with the nose may become important organs (snout, proboscis) for the capture of food. The stomach varies widely but is ordinarily a simple sac with muscular walls. Sometimes it is partly separated into chambers by folds (Figs. 234, 235). This reaches its greatest complexity in the ruminants, in which four chambers occur (Fig. 235). One of these—the *rumen*—becomes a temporary receptacle for the food which is first swallowed without being

chewed. This peculiar structure is correlated with the habit of rapid feeding and retirement to less dangerous or exposed locations, where the food is forced back to the mouth in appro-

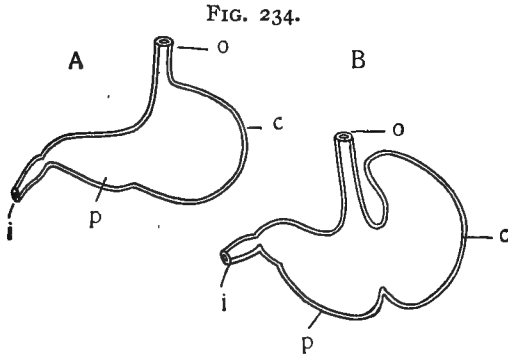


FIG. 234. Diagram of stomach of dog (A) and rat (B). After Wiedersheim.

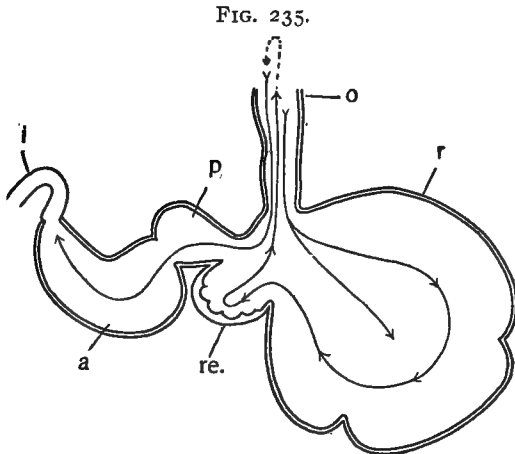


FIG. 235. Diagram of stomach of Ruminant. After Wiedersheim.

**Questions on the figure.**—What is the significance of the term ruminant? Of what conceivable advantage is this form of stomach? What animals belong to the class?

priate quantities and chewed at leisure. When swallowed the second time the food passes on to the glandular divisions of the stomach.

The liver and the pancreas pour their secretions into the

small intestine near its anterior end. The small intestine is very much shorter in flesh-eating animals than in the vegetable feeders. At the junction of the small and large intestine there is a blind pouch or sac (*cæcum*) terminating in a projection (*vermiform appendix*) which is large in the Herbivora, but in man is a mere rudiment. In man its function is obscure. It is often the seat of serious infection and inflammation.

FIG. 236.

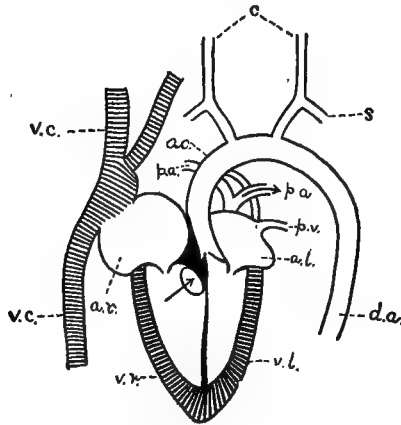


FIG. 236. Diagram of the heart and chief vessels in the mammals. *ao.*, aorta; *a.l.*, left auricle; *a.r.*, right auricle; *c.*, carotid artery; *d.a.*, dorsal artery; *p.a.*, pulmonary artery; *p.v.*, pulmonary vein; *s.*, subclavian artery; *v.c.*, venæ cavæ (pre-caval and post-caval); *v.l.*, left ventricle; *v.r.*, right ventricle.

**Questions on the figure.**—What kind of vessels communicate with the auricles? What with the ventricles? What is the position of the valves? Trace the direction of the blood flow in the various parts of the blood vessels figured. What is the distribution of the veins and arteries shown here, *i.e.*, to what organs do their minuter branches go?

**458. Circulatory System.**—Mammals are warm blooded, but with lower temperature than is found among the birds. It ranges from 35° to 40° C. The heart is completely four-chambered as in birds, the left side containing pure blood and the right impure (Fig. 236). The aorta, arising from the left ventricle, has only one arch—the left, whereas only the right is found in birds. The general comparison of the conditions in vertebrates may be seen from the table on page 344. There is an hepatic-portal, but no renal-portal, circulation.

The lymphatic vessels are an important part of the circulatory apparatus in all vertebrates. Under the pressure that exists in the arteries, some of the fluid portion of the blood finds its way through the walls of the capillaries into the spaces among the tissues. This cannot get back into the minute veins, and hence special vessels are provided to get it back into the circulation. Starting with the irregular

spaces in the tissues, in which the lymph collects, we find vessels less regular than the veins, often running together and then rebranching, gradually approaching the body cavity. On their route they pass through knots of special tissue—lymphatic glands, where colorless amoeboid cells are added. Special lymphatics—the *lacteals*—gather food from the intestines and, uniting with the general lymphatics, finally empty into the large veins in the neck region. The escaped lymph is thus returned to the blood.

459. **The Respiratory Structures** differ from those of birds chiefly in the fact that they are confined to the anterior or thoracic cavity, in which they hang freely, suspended by the *bronchi*. There are no air-sacs outside the lungs, hence all the air passages terminate in the *alveoli*, in the walls of which are the pulmonary capillaries. Inspiration and expiration of air is affected by increasing and decreasing the size of the chest cavity by means of the muscles between the ribs and by the contraction of the muscles of the diaphragm which is normally arched forward into the chest. By its contraction the viscera are forced backward and more space is given to the lung, which at once fills the chest cavity as the result of air-pressure on the inside of the lung.

460. **Nervous System.**—The special feature worthy of note in the nervous system of mammals is the large size of the brain, especially of the cerebral hemispheres. In the higher mammals, particularly, these become complicated by folds and convolutions by which the surface or *cortex* of the brain is much increased. The brain cells, or gray matter of the brain, are especially abundant in the superficial part, and therefore this increase of surface means that these cells are increased in amount as compared with other vertebrates. The intelligence of an animal is roughly proportional to the amount of the cortex. The cortex is a thin layer, varying from one to five millimeters in thickness. It has been estimated that there are about 9,000,000,000 nerve cells in the cortex of a human brain. These nerve cells represent about one five-thousandth of man's total weight, and yet they furnish the basis for the conscious life and the control of the body. The fibrous tracts connecting the various portions of the cortex are likewise more perfectly developed among the mammals, and most of all in man.

The organs of special sense are similar to those in the birds. The ear becomes more complicated. There is usually a well-developed external ear, or *pinna*, in the terrestrial forms, which is often movable and serves to gather the sound waves. The membranous labyrinth of the internal ear becomes more complicated than in any of the lower forms. This is especially true of the *cochlea*, which is spirally coiled. The middle ear is bridged by a series of three bones, instead of one or two as in the lower groups of vertebrates where such connection exists at all.

461. **The Urinogenital Organs.**—As in the other vertebrates there is close connection between the excretory and reproductive organs in mammals. The bean-shaped kidneys communicate by *ureters* with a median urinary *bladder*, which in turn has the *urethra* leading to the outside. The urethra also serves as the outlet for the sperm in the male. The testes, which in other vertebrates lie in the body cavity, pass backward and descend into a fold of the skin, in the majority of mammals. In the female, the ovaries are in the abdominal cavity, and when the ova are ripe they break forth into the cavity and pass into the fringed, funnel-shaped mouth of one of the two oviducts. The oviducts may be completely distinct, opening separately into the vagina (as in most rodents), in which case each has a special portion in which the young are retained during early development (*uterus*); or there may be found various degrees of union of the uterine portions until there is a single uterus into which the two oviducts empty (as in man).

462. **Reproduction and Development.**—All the mammals except the monotremes are viviparous. Impregnation may take place in the oviduct or in the uterus. In the Monodelphia the ova are small and have little yolk, whereas in the Prototheria there is much yolk, as among the birds. The segmentation in the placental mammals is complete but not necessarily equal. A solid sphere of cells is formed which becomes differentiated into an outer enclosing layer (the *trophoblast*, Fig. 237) and an inner mass of cells (Fig. 237, *ent.*). This mass of cells gives rise to the embryonic layers, from which are produced the adult organs. The trophoblast has little or no part in the formation of the embryo proper, but has a part in forming the foetal membranes so important in the group. The steps of embryonic development, while similar in general to those described for the other Vertebrata, are modified by the absence of the yolk and the retention of the developing egg in the body of the parent. The embryonic



membranes—*amnion* and *allantois*—occur as among birds, but their fate is somewhat different. The allantois typically fuses with the outer layer of the amnion (*false amnion* Fig. 208, *am*<sup>2</sup>) and the trophoblast (see above), and this combined tissue, the *chorion*, becomes connected with the wall of the uterus by outgrowths or *villi*. These become closely associated with the tissues of the mother. This combination of maternal and embryonic tissues is called the *placenta*, and is the characteristic organ of the Monodelphia or true mammals.

It is by means of these united tissues that food and oxygen pass from the blood of the mother into the blood of the embryo. In the marsupials the attachment is very slight, and for this

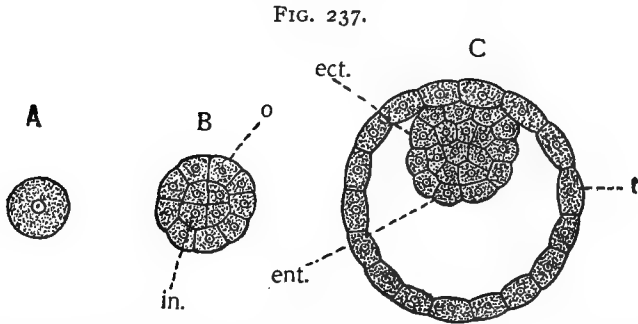


FIG. 237. Diagram of Segmentation of ovum in mammals. *A*, ovum; *B*, showing the early differentiation into an outer layer which produces the *trophoblast* (see p. 447), and an inner mass which produces the embryo; *C*, a later stage. *ect.*, ectodermal portion of embryo; *ent.*, cells destined to produce entoderm; *in.*, inner mass of the cells which form the embryo; *o*, outer layer which forms *t*, the *trophoblast*.

**Questions on the figures.**—How does this differ from the segmentation in the sea-urchin? What is the fate of the trophoblast? Examine reference texts and learn how the ectoderm, entoderm, and mesoderm of the real embryo (the inner mass of cells) are formed.

reason uterine nutrition becomes insufficient relatively early and the young must be provided for in some other way. The *marsupium*, in which the milk glands open, presents the solution of the problem of later development of the foetus. So at birth the immature young of marsupials are placed by the mother in the pouch. It is important to remember that the blood vessels of the mother and the embryo are not continuous. The blood

of the embryo is developed in the same manner as its other tissues and is not derived from the mother directly. The two blood currents interchange materials by osmosis through the capillary walls. There is no direct continuation of nervous tissue across from the mother to the young. Notwithstanding this lack of direct connection each exerts a very profound effect upon the other. It is known that the embryo secretes materials which passing into the blood of the mother produce the growth of the mammary glands that leads finally to lactation. Proper nutrition, malnutrition, endocrines, or poisons in the blood of the mother greatly influence the growth and normality of the offspring.

463. **Classification of Mammals.**—In the introductory survey in §448 the three subclasses have already been outlined.

*Subclass I. Prototheria, Order Monotremata.*—Mammals

FIG. 238.

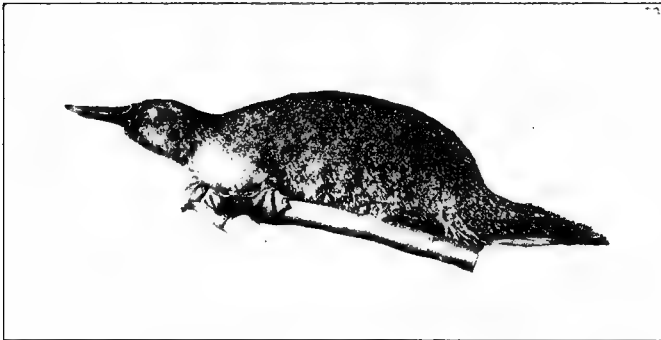


FIG. 238. Duck-bill (*Ornithorhynchus anatinus*). Photographed by Folsom.

**Questions on the figure.**—What are the peculiarities of *Ornithorhynchus*? What does the structure of its feet indicate as to its habits?

whose mammary glands have no nipples; they lay eggs with abundant yolk, which are hatched outside the body, as in birds. The alimentary canal ends in a cloaca. One ovary is sometimes incompletely developed as in birds, and the oviducts open separately into the vagina. The duck-bill or duck-mole

lives in water, or burrows in the banks of streams or lakes. It is eighteen or twenty inches long and is covered with soft fur, Its eggs are laid in its burrows. *Echidna* or the spiny ant-eater. lives in rocky places and captures ants by means of its slender, sticky tongue. They are confined to Australasia and are interesting chiefly because of their likeness to the reptiles and birds (Fig. 238).

*Subclass II. Eutheria: Division I, Didelphia, Order Marsupialia.*—Mammals with nipples; these occur in the pouch on the ventral surface of the body in which the immature young are placed at birth. The young are too immature to suck voluntarily at first, and milk is forced into the mouth by the action of muscles about the gland. The pouch is usually supported by two bones attached to the pubis and extending forward. There are two oviducts, two uteri, and even the vaginæ may be paired (Figs. 52, 62).

Many different types are included in this group. Some are rat-like in appearance, others similar to the dog, others to the bear. Some are herbivorous, some carnivorous, others insectivorous. With the exception of the American opossum family, the living species are native of Australasia. Fossil marsupials are found in all parts of the world, showing that they are an ancient type of mammals which have become extinct except in the places cited. Many of the fossil forms were of gigantic size. The largest living species is the kangaroo.

*Division II. Monodelphia (one uterus), Order Placentalia*—Mammals in which the young are connected to the wall of the maternal uterus by means of a placenta (see §462); two oviducts; uteri more or less united into one; vagina single; no cloaca; no marsupium. The segmentation of the ovum is total.

The following key will assist the student to get a view of the principal orders of the placental mammals:

Teeth wanting, or without enamel.....*Edentata*.

Teeth with enamel.

Hind limbs wanting.

Front appendages with elbow joint.....*Sirenia*.

Front appendages without elbow joint.....*Cetacea*.

Hind limbs developed.

Nails of the digits hoof-like.

Third and fourth digits equally developed, others reduced. . . . . *Artiodactyla*.

Third digit well developed, all others more or less reduced. . . . . *Perissodactyla*.

Five well developed digits. . . . . *Proboscidea*.

Nails claw-like.

The front limbs modified to form wings,

*Cheiroptera*.

No wings.

Thumbs not opposable.

Incisors and canines small,

*Insectivora*.

Incisors chisel-shape and canines

wanting. . . . . *Rodentia*.

Canines large; other teeth often pointed,

*Carnivora*.

Thumbs opposable. . . . . *Primates*.

*Order Edentata (toothless)*.—Placentalia in which the teeth are absent or imperfect, being destitute of enamel and true roots. They are found both in the Old World and in the New, especially in the tropics of the southern hemisphere. The chief representatives are the sloths and the hairy ant-eater of Central and South America, the armadillo of South America and as far north as Texas, and the scaly ant-eaters of Asia and Africa. The sloths are sluggish vegetarians living in the trees, on the branches of which they hang or climb, back downward, by means of their long curved claws. The ant-eaters are almost wholly devoid of teeth, but have narrow extensible tongues which they project into ant-holes, capturing the ants by the sticky saliva. The group furnishes a noteworthy exception to the statement that the mammals lack an external skeleton. Overlapping bony scales, or plates in the form of rings, may furnish a complete armor by means of which they are kept from extermination in spite of their inoffensive, sluggish habits. This is best seen in the armadillo.

*Order Insectivora (insect-feeders).*—These are small mammals with clawed digits, which feed on insects and other small invertebrates. The brain is small and smooth. The incisors are small. Many burrow, and have special adaptations for such a life; among these one of the most interesting is the degeneration of the eyes. The moles, shrews and hedgehogs are the chief representatives. The moles have the reputation of eating corn and other planted grains. Their burrows frequently follow the rows. Their food, however, is the insects that collect about the planted grain. They do much damage to turf in making their burrows. A single specimen has been known to burrow twenty yards in a day. For brief periods and in reasonably firm soil they have been seen to dig a yard in ten minutes.

*Order Sirenia.*—A small group of aquatic Placentalia, more or less whale-like in form. They are sluggish, ungainly, vegetable feeders. They have no posterior appendages and the anterior are flipper-like, though capable of bending at the elbow. They live near the shore and are represented by two living genera, the sea-cow of our own eastern shores (*Manatee*), and the Dugong of the Indian Ocean.

*Order Cetacea (Whales, Porpoises, Etc.).*—The Cetacea are aquatic mammals with a fish-like body. There are no posterior appendages, and the anterior act as paddles, being without joint. The tail is horizontally expanded into a powerful paddle, and a dorsal fin is usually present. Teeth are present in the embryo, but may be lost or replaced by “whale-bone” in the adult. The stomach is chambered. The two mammæ are posterior. Hair is very scant, but the layer of fat or “blubber” beneath the skin is very thick, and serves as a non-conductor of heat.

The whales are the largest living animals. The sulphur bottom whale may reach a length of ninety-five feet and a weight of 150 tons. It must be remembered that the whales are air-breathers, and therefore must come to the surface to breathe or “blow.” The Cetacea prey on the smaller swimming or floating animals found in the ocean, as fish, squid, crustacea, etc. Whales are principally sought for their fat and baleen, or whale-bone.

There are two principal suborders: the toothed whales, and

the whale-bone whales. The former include the dolphins, porpoises, grampuses, narwhales, sperm whales, and beaked whales. The right whales, the hump-backed whale, the gray whale, the finback whale, and the sulphur bottom whale lose their embryonic teeth and produce whalebone. Food is taken with the mouth open and the water is forced out through the whale-bone, leaving the "catch" in the mouth.

*Order Artiodactyla (even-toed).*—These are hoofed animals with toes reduced to four or two. The third and fourth toes persist and bear the weight of the animal, and the second and fifth, if present, may or may not touch the ground. The mammæ are distributed along the entire abdomen (hog) or are confined to the pelvic region (ox).

This is a splendid group containing some of man's most valuable food animals. Included in it are cattle, sheep, goats, antelopes, elk, deer; the giraffes; the camels and llamas; the hippopotami; and the hogs and peccaries. The ox, sheep, goat, deer, and giraffe are *ruminants* (see p. 445).

The chief native American forms are llama, elk, moose, black-tailed deer, pronghorn antelope, Rocky Mountain goats, bighorn, musk ox, and bison. The bison was formerly one of the most abundant of our American ruminants. Now there are a few in captivity and fewer still wild. Most of these forms are capable of domestication, because of their tractable disposition and their feeding habits. They are very valuable both for their hides and their food products. In addition to the flesh foods, milk and its products of butter and cheese are among the most prized of human foods. Milk, as are eggs, is a complete food; that is, it contains all the constituents, both organic and inorganic, necessary to support growth and development, as is shown by the fact that it is the sole supply of food for the young immediately after birth.

*Order Perissodactyla (odd-toed).*—These are hoofed animals characterized by the fact that the weight of the body rests on the third or middle toe, the others being more or less reduced. The stomach is simple. There is no proboscis. The mammæ are few and confined to the pelvic region. The most common examples are the horse and its allies, in which the third is the

only digit, and the rhinoceros, which has the second and fourth, as well. It is known that the remote ancestors of the horse had a second and a fourth toe where only splints occur now, and even a first and a fifth, where now there is no trace of either. The horse has been domesticated as long as we have records and there are approximately as many breeds of horses as of chickens,—some half a hundred. The ass and zebra belong to the same genus,—*Equus*. They both cross with the horse. Tapirs are included in this order.

*Order Proboscidea* (with proboscis).—Two living and many extinct species of huge Placentalia with five digits, each with a distinct hoof. The nose is much developed into a prehensile organ, with corresponding changes in the skull for attachment of muscles. The skin is thick and loose. The upper incisors grow enormously, forming the tusks characteristic of the group. There are no canines; molars are very complex. The two teats are thoracic. The largest of the land mammals, the elephants and the extinct mastodon and mammoth, belong here. They are now confined to the tropical regions of Asia and Africa, though in geological times they seem to have had a world-wide range. The tusks of species of elephants, both living and extinct, furnish the ivory of commerce.

*Order Carnivora* (flesh-eaters).—The Carnivora are four- or five-toed animals with the digits ending in claws. The canines are well developed, strong and curved. The other teeth are often pointed and adapted to holding or tearing. Muscles of mastication are especially well developed. Mammæ are numerous, occurring along the entire abdomen. There are two types of Carnivora—terrestrial and marine. To the first belong the bear family, which is perhaps the least specialized group; the dog family, including dogs, wolves, foxes, jackals; the cat family, including lions, tigers, leopards; hyenas; many fur-bearing animals—as otters, weasels, minks, martens, badgers, wolverines, and skunks. There are many of these fur-bearing animals in North America. The seals and walruses belong to the marine group. In these forms the appendages have become adapted to the water habit, the digits bearing intervening webs.

The principal American cats are: the wild cat (also called

bob cat and catamount), Canada lynx, the cougar (also called puma, panther and mountain lion), and the jaguar of Mexico and South America which is the largest. Our native dog-like carnivores are the timber wolf, the coyote, the red fox, the blue fox, the gray fox. We have several species of bears,—polar, black, grizzly, and cinnamon.

The greatest of the cats are the tigers, which may reach a length of ten feet, and the lions. These with the leopard are Southern Asiatic and African types.

The order embraces many very powerful and intelligent animals which are well adapted to win in the struggle for life, if it were not for human interference. In the presence of man, however, all those which are not suited to domestication are gradually disappearing; some because of their dangerous qualities, others because of the value of their products. The group is not used to any considerable extent as food.

FIG. 239.



FIG. 239. The Kangaroo Rat (*Dipodomys ordii richardsoni*), adult male. Photographed from life by Dr. R. W. Shufeldt.

**Questions on the figure.**—What order of mammals is illustrated by this form? What explanations are offered as to the cause of the light color of the belly and the dark color of the backs of animals? Of what conceivable advantage is the difference in coloration? How does the tail of this species compare with that of our common rat?

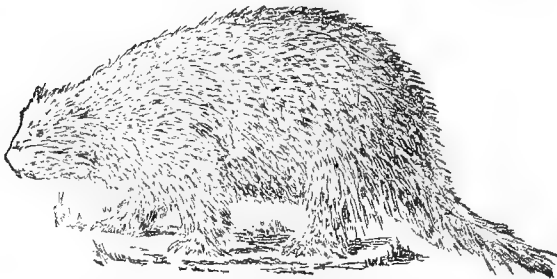


*Order Rodentia (gnawing animals).*—Rodents are small mammals with clawed digits. They have no canine teeth, but have well-developed chisel-shaped incisors which continue to grow as they are worn at the extremity. The chisel edge is preserved by the fact that the enamel is chiefly in front, and

FIG. 240.

FIG. 240. The Fox Squirrel (*Sciurus niger rufiventer*). Photographed by Folsom.

FIG. 241.

FIG. 241. Porcupine (*Erethizon*). By Dr. J. W. Folsom.

**Questions on the figure.**—To what order of mammals does the porcupine belong? What are its peculiarities of habit and structure?

the exposed, softer dentine behind is worn away more rapidly by being used. The brain is smooth. The mammæ are abdominal. Rodents have world-wide distribution, and are

especially well represented in North America. The principal types are the rats and mice, many of which are close followers of civilized man; squirrels, chipmunks, and prairie dogs, gophers, beavers, hares and rabbits, and porcupines. Rodents feed on vegetable diet, and are destructive of many plants and grains which man uses for food. Notwithstanding man's efforts to destroy them their remarkable power of reproduction enables the more aggressive families to hold their own. Rats

FIG. 242.

FIG. 242. Flying Fox (*Pteropus*). U. S. Dept. Agriculture Year-book, 1898.

**Questions on the figure.**—What is the structure and arrangement of the wings in such a form as this? To what order of mammals does this type belong?

are among the worst of mammalian pests. They follow man closely and are very destructive of certain crops and of stored grains and other foods. Beside this the rats, and in less degree certain other rodents, are the carriers of the bubonic plague and possibly other diseases. Fleas carry the disease from rats to man.

*Order Chiroptera (hand-winged; the bats).*—These are mammals in which flight is made possible by a web or fold of the skin

stretching between the much extended fingers of the anterior appendages; between the arm, body, and the hind legs; and thence even to the tail. The thumb and posterior digits are clawed. The sternum has a keel as in birds. The mammæ are thoracic. Bats are the only mammals capable of active flight. They feed on insects or fruits. The members of one family, the true vampires, live on blood of warm blooded animals. They cut through the skin with sharp front teeth and lick up the escaping blood.

Bats are small animals and are chiefly nocturnal in habit, at which time they fly actively. During the day they seek retired and dark places where they hang head downward, holding on by their claws. Those in temperate regions hibernate during cold weather, often using caves for this purpose. (Fig. 242.)

*Order Primates (first or highest).*—With the exception of man the primates are arboreal in habit. In adaptation to this

FIG. 243.

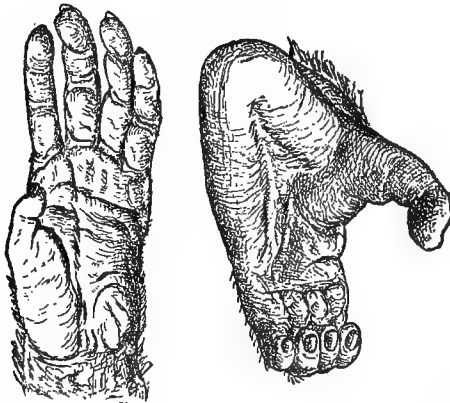


FIG. 243. Hand and foot of Chimpanzee. From Home and Country Magazine.

**Questions on the figure.**—Which is hand, and which foot? In what respects do they differ? How do they differ from the hand and foot of man? In which is the difference from the human condition greater? What is the functional meaning of these differences?

the thumb and great toe are usually opposable to the other digits, as in the human hand. The digits are armed with nails which are in some cases claw-like. The cerebrum is large and

in higher forms much convoluted. Mammæ chiefly thoracic (abdominal in some lower forms). The group embraces the lemurs, monkeys of various kinds, baboons with non-prehensile tails, the tailless apes most like man, and man himself. While the primates have produced some species with the highest intelligence to be found among mammals, and man places himself at the head of the animal series, many of the bodily characteristics of the primates are rather primitive. For example, the habit of walking on the whole foot (*plantigrade*), the nails, the teeth, and many other structures are regarded as more primitive and less specialized than corresponding structures in such groups as the carnivores or ungulates. We are more near the center of the shaft of evolution. (See Fig. 251.)

The chief divisions of the primates are:

1. Lemuridæ, or lemurs.
2. New World monkeys, with broad and flat noses.
3. Old World monkeys, having narrower nose with more bridge.
4. The man-like apes of the Old World.
5. Some intermediate extinct types of man. (Found in caves of Europe.)
6. The Genus *Homo*,—modern man.

The primates below man are found chiefly in tropical regions and more abundantly south of the equator. They feed largely on fruit and insects, though some eat birds and other small animals. Many of them are social, or at least gregarious, and their habits of life are interesting and suggestive in a high degree, when we consider their possible relation to the human species.

464. **Additional Notes on the Habits of Mammals.**—We have seen that mammals have succeeded in occupying the land, in much less degree the water, and least of all the air. We have classified them as insectivorous (moles, ant-eaters, and bats); carnivorous, as the beasts of prey; herbivorous, or vegetarian, as the hoofed animals, rodents, and kangaroo; or omnivorous, as the pigs and man. They are very versatile and have dominated the earth since the tertiary epoch when they supplanted the mense reptiles of the earlier ages.

One of the most noteworthy facts in connection with the group is the degree of care given to the young by the parents, especially the mother. This is true not merely in gestation but after birth in the attendance of the mother to the needs of the young, both in supplying food and in protecting from danger. It must be remembered that this is done at the expense of the parent's safety. This means that the species may be kept alive by the birth of a smaller number of young, because more will reach maturity than if left early to shift for themselves; and, further, that a higher development of the young becomes possible owing to the increased length of youth. The degree of development at birth is quite variable. In a general way it is less in the case of those whose parents can best protect the helpless young. For example the young of the Carnivora and of the Primates are much less able to take care of themselves at birth than the young of the Herbivora. Many biologists have called attention to the fact that the greater care of the young implies higher instincts and intelligence on the part of the parent. Any such improvement is subject to the action of natural selection as an advantageous characteristic. In turn a longer youth or period of development is demanded for the maturing of these higher instincts, thus in turn making a new demand on the parent for more care and training.

The social instinct is well represented among mammals. This may vary from collection in mere shoals or herds where food is abundant, to groups organized for offense and defense and for work,—as wolves, deer, beavers, and men. Indiscriminate mating is the rule, yet in some instances strict monogamy is found. In many cases mates are won by force, and this tends to result in the selection and propagation of the strong. The struggle among the males is accompanied by the development in them of numerous structures which the females do not possess at all or at least in such degree:—as antlers, horns, tusks, manes,—and greater size.

Mammals do not have so great freedom of motion as the birds, and hence do not make as much use of migration to escape winter conditions. They tend to keep up an active life, like the rabbit and wolf, or hibernate, like the woodchuck. There are some

forms however that do migrate. These migrations may be related to the breeding habits or to food supply rather than to temperature primarily. Rats, the rat-like lemmings, fur-seal, and reindeer migrate. Wonderful stories are told of the lemmings of Sweden and their occasional fierce instinctive migrations, from which nothing can turn them, not even the sea, into which they plunge and swim until they perish.

The hibernating mammals must find a place where they will not quite freeze. All their vital activities are lowered and their temperature falls gradually until in some instances it closely approaches the freezing point. Usually this state must be approached somewhat gradually if the animal is to survive. The larger hibernating mammals like the bear must seek caves or be satisfied with a hollow log or a shallow den. Burrowing forms fare best, as they merely dig themselves in below the frost line. The smaller ones must find the safer places, since they lose their heat more rapidly.

Different species vary greatly in the duration of their winter sleep. A few hibernate through the whole of the cold weather without interruption, as the woodchuck. Some may hibernate only in the coldest weather and for a brief time. Others wake up from time to time and seek food. Although the vital processes are low they keep going. This uses up material. Since no food is taken, the fatty reserves of the body are drawn upon. Animals go into the sleep fat and come out thin.

It is in the higher mammals that one finds the greatest display of intelligence to be seen in the animal kingdom, and it is in man that intelligence and reason—whose first beginnings in animals no one can mark—find their culmination. That these high qualities are closely correlated with the great development of the brain there can be no doubt. The great progress of man in getting mastery of the earth is one of the most interesting aspects of the same general problem of evolution and adaptation which gives unity to the subject matter of zoology. Thus the sciences which pertain to man in all his various interests have in some measure their foundation in the science of zoology. (See Chapter XXV.)

465. **Mammals in Relation to Man.**—Mammals are not merely closest to man in matter of kinship, but they are his most valuable allies in the struggle for existence. Doubtless they were also his worst enemies in his earlier history. They furnish him meat, milk, clothing, labor, transportation, sport, and companionship. They have always furnished his favorite game when he was not engaged in hunting other men. His domesticated animals are chiefly from this class. In most cases the beginnings of domestication go back to our earliest records and we can only guess which of the species of wild animals he began with. In these cases he has bred and selected them in so many different ways that scores of distinct varieties are now scattered over the face of the earth. Now that we are coming to understand more of the method of transmitting many of the unit characters (see §493) we shall be able to recombine desirable qualities more systematically, and doubtless new and desirable breeds will arise still more rapidly.

Man has almost destroyed those fierce mammals that were his terror at the beginning. They are all but extinct or have migrated to the jungles of the tropics. There are, however, a number of smaller ones that he has not been able to control. The cat family is very much less a menace to human interests now than the rodents. Most of these are pests. Rats and mice are the most hurtful. They attack all sorts of vegetable matter both in the fields and in storage. Rats attack poultry. They gnaw and nest in all sorts of manufactured materials. There is no doubt that they damage hundreds of millions of dollars worth of materials in the United States every year.

Rabbits in some parts of the world are scarcely less injurious. They attack all kinds of tender growths, and in winter may eat the bark from young trees as high as they can reach. These small rodents multiply rapidly and have become notorious pests, especially when introduced into new regions where their natural enemies were not found. Historic instances are, rabbits in Australia, mongoose in Jamaica and the Bermudas, and the rat into our own country.

It is not always easy to classify forms as helpful or hurtful. Forms like wolves, coyotes, foxes, mink and weasels undoubtedly

attack the poultry, sheep and the larger mammals that we cultivate, and should be killed. In eighteen months in 1912 and 1913 in the state of Texas alone, were killed 98,600 wolves and wild cats, including 53 panthers and 22 leopards. And yet when the domestic animals are properly protected, most of these forms live upon rabbits and other rodents, and insects. The balance in nature is so complex that we cannot prophesy all the results that may come from the destruction of a species or the introduction of a new one.

#### 466. **Supplementary Topics for Field and Library.**

1. Enumerate the native species of mammals known by you to be found in your locality, and determine to which of the orders of mammals they belong. Is the number of native species of mammals large or small as compared with other animals? Are the individuals of these species numerous or not? How do you account for the facts you have discovered?

2. Enumerate the species of domestic mammals in your locality. Are they related to any of the native species? Trace the history of some of the most important domestic types. What do you know of the mammals domesticated in other parts of the earth?

3. Make a report on the ruminants: their habits, their distribution over the earth, and their uses to man.

4. Make an investigation of the breeds of cattle, or horses, or goats, or sheep. Find out some of the strong and weak points of each breed.

5. What is known of the geological history of the horse family? Is the horse a native of America?

6. What is the history of the introduction of rabbits into Australia? Can you cite any similar history of rodents in this country?

7. Report on furs and fur-bearing animals. What is the present state of the seal fisheries of our Pacific coast? What steps are necessary to the preservation of the seal? On what zoological grounds are these steps necessary?

8. Make a report on the habits and instincts of the beaver. Describe the nature of its social life.



9. Report on the condition of primitive man. Which of man's instincts have been of most use to him in his development? What are the principal faculties separating him from the other primates? Do all men possess these in equal degree? What is the distribution of the principal races or varieties of the human species? What are the chief differences between these races?

## CHAPTER XXV

### CLASS MAMMALIA (CONTINUED): MAN

467. **General Statement.**—Man agrees, as we have seen, with the higher primates in all the essential structures and functions which make them mammals and primates. In many minor details, too, he resembles them. The form of the fingers and the flat nails; the number and arrangement of the teeth; the shape of the face, and numerous other superficial things might be chosen to show the likeness between man and the higher apes. It is agreed by zoologists that there is less difference of structure between man and the higher apes than between the apes and the monkeys.

In general, man agrees with all animals in all that is necessary to make an organism an animal; he agrees with all the vertebrates in the vertebrate characteristics; he agrees with all the mammals in their distinctive features; and finally he agrees with the primates in the special qualities that separate them from the lower mammals.

468. **The Structural Distinctions Between Man and the Other Mammals.**—Man differs from the other primates in the fact that he is more upright in position. This brings about a greater development of the hind legs and the pelvic bones for support and leaves the hands free to serve the individual in ways other than locomotion. He differs also in the size of the brain and in the convolutions of it. The brain of the average man weighs from two to three times that of the gorilla, while the heaviest known human brain is only twice as heavy as those of the lowest races of men. There is a corresponding difference in the shape of the head (compare Figs. 244 and 245). The great toe cannot be opposed to the other toes as in the case of the apes (Fig. 243), or as man can oppose his thumb. There is freer motion of the big toe, however, in newly born babes than in adults. The canine teeth of man are somewhat less developed, and the body covering of hair is not so pronounced, though the

hair on the head and face is more so. These differences, however, except that relating to the brain, are of minor importance.

FIG. 244.

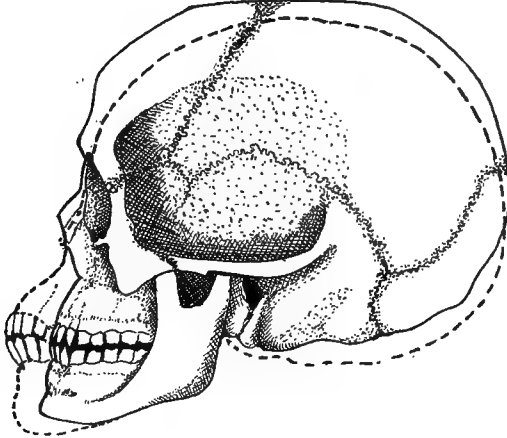


FIG. 244. Human skulls.—The one in heavy outline, with portions shaded, is a caucasian skull That merely outlined (in dotted line) is of an Australian negro.

FIG. 245.

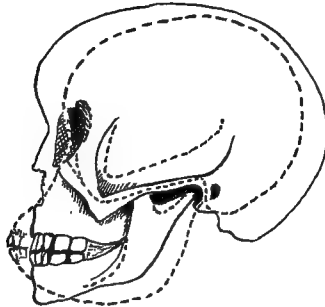


FIG. 245. Skull of young orang outang (dotted outline) superimposed on that of a young child

**469. Functional Distinction Between Man and the Other Mammals.**—While the structural differences are not sufficient to remove man from the group of primates, because they are relatively insignificant in themselves, the powers and activities and modes of life that have arisen from these do serve to place man clearly into a group of his own. These great improvements in powers have accompanied and are in some measure due to the gaining of the upright position and to the use of the hands as the

instrument of the brain and to the development of spoken language. These three things—the enlarging brain, the free and

FIG. 246.



FIG. 246. Skull of adult orang outang.

**Questions on Figs. 244-246.**—Enumerate the similarities and the differences apparent in these skulls. In what respects is the negro skull intermediate between the orang outang and the caucasian? Is the difference between the orang outang and human greater in youth or in the adult? What is the probable significance of this? What are the zig-zag lines in some of the figures? What is the meaning of the shaded area above the cheek-bone and back of the eye? How does the lower jaw in the higher races compare with that of the lower? The meaning of this?

FIG. 247.

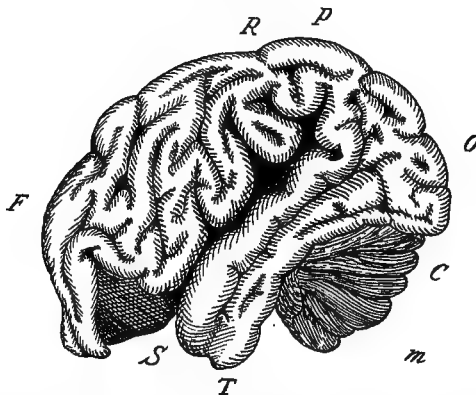


FIG. 247. The outline of the brain of an orang outang. Adopted from Gegenbauer and Vogt and Gratiolet. Front portion. *F* to *O*, cerebrum; *C*, cerebellum; *M*, medulla and spinal cord; *F*, the frontal lobe; *P*, the parietal lobe; *O*, the occipital lobe; *T*, the temporal lobe; *R*, the fissure of Rolando; *S*, the fissure of Silvius.

flexible hands, and the growing language—would tend to train and improve one another. The brain working through the

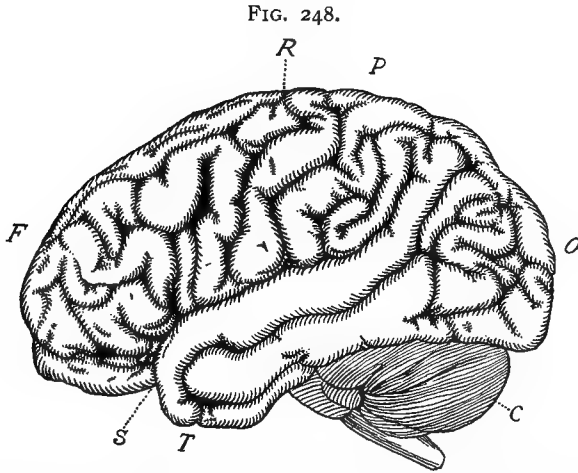


FIG. 248. Brain of Hottentot woman. From Mill's "Text-book of Animal Physiology," Copyright D. Appleton & Co. Lettering as in Fig. 247.

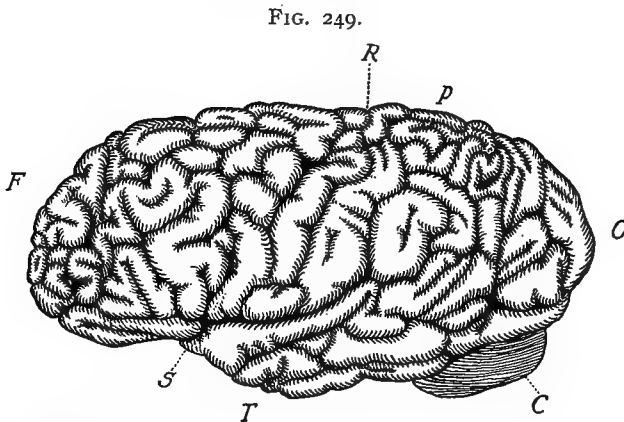


FIG. 249. Brain of Gauss, the mathematician. From Mill's "Text-book of Animal Physiology; Copyright D. Appleton & Co. Lettering as in Fig. 247.

**Questions on Figs. 247-249.**—Identify and compare the cerebrum in these three brains. What are the chief differences? Compare the mass in front of the *fissure* of Silvius (that is the *frontal lobe*), in the three. What is the reason of the connection between the numerous convolutions and mental development? Which increases more, the cerebrum or the cerebellum, as we ascend the scale? The meaning of this?

mobile hands, means the making and use of tools, of dwellings, and getting numerous forms of mastery over nature. It is scarcely possible to overstate the importance of tools in human evolution. Each new implement is a kind of new bodily organ and a stimulant to greater intelligence. The brain working through language makes it possible to communicate experiences, and to develop ideas and the power of thinking and reasoning. In the more intimate parental relations brought about by homes, all this insures the education and training of the young in the discoveries of the race. The increase of the cerebral cortex and the closer association of the different parts of this cortex are in some way related to the better consciousness and memory in man. The use of language and the power of abstract reasoning have been chief agencies in the further increase in size and complexity of the brain.

**470. Mental Life of Man, Instincts, Habits, Reason.**—Fundamentally, the mental life of man, no less than that of the lower animals, is the function of the brain and its accompanying systems of organs. He has the same nervous arcs by which stimulus, conduction, reaction, satisfactions and dissatisfactions, and the coordinations of these are made possible. His reflexes and inherited reaction patterns are much the same, and the appetites and feelings do not differ fundamentally. All the higher animals experience much the same hunger, thirst, sex impulses, satiety and pains. All have fears, aversions, loves and jealousies, and anger,—the basis of which at least is inherited. That portion of these qualities and tendencies which is inherited we call *instinctive*. Much of the mental life of man, quite as really as in the lower animals, is of these more mysterious impulses (instincts) that we do not get by our own experiences, but which belong to our make-up in some way as an inheritance from the past of our ancestors. We do not always realize how much our own life is controlled by these inherited instincts. They predispose us to do certain things in particular ways. Much of man's life and activities is made up of habitual actions that have been acquired through trial and experience, and the crystallizing of these through memory. The child

takes his first steps in actual learning very much as the lower animals do. He is stimulated and he acts somewhat at random in a new situation. If satisfaction follows the action, it is repeated. If dissatisfaction follows, some other action is tried. Finally he hits upon a suitable action. This is the trial and error method of learning.

In man, as in the higher mammals, we can modify or condition these inherited reflexes, impulses, tendencies, and instinctive reaction patterns, by associating new stimuli and rewards with them. For example, by ringing a bell always when savory food is placed before a dog or a child, we can finally get the usual reactions to food merely by ringing the bell. Or by following up a normal response always by unpleasant results the instinctive reaction can be changed or broken up altogether, and another substituted.

Man, however, working upon these internal feelings and the results of his experiences, through the play of increasing memory and imagination (*consciousness*) can compare not merely present sensations and objects, but also past experiences and mental states with those of the present. He can also consciously anticipate future conditions on the basis of this and plan and purpose to meet these in definite ways. By the power of language he can the better deal with abstract ideas, which in consciousness serve to replace concrete objects. In a word, he has gained the power of abstract reasoning and of ignoring temporarily the concrete things. He can say (or think), (1) This is true; (2) *this* is true; and (3) *therefore*, this is true. Starting from experience, he can thus reach conclusions quite beyond the power of experience to convey. These conclusions may of course be true or false; but there can be no doubt that they have greatly influenced and enriched human life. Through the use of language, again, he can make understood by others not merely concrete situations but even these entirely abstract conclusions. In this way we can substitute teaching and training in some degree for personal experience on the part of new generations.

This aspect of zoology is known as *Psychology* and is most important in all the progress we have made in discovery,

accumulation of knowledge, art, literature, science, and ethics. It does not help us in solving our own problems to forget that all this is a part of human zoology,—and that the lower animals have a similar psychology, even if it is not so complex.

471. **The Social Instincts and their Result in Man.**—In the course of our studies we have found many animals that recognize their kind and more or less definitely associate with them. This reaches a very high plane in the bees and ants. Similar social life is to be found in all the primates, but it is not so well organized among the lower primates as among the ants.

In man, even in primitive man, these social instincts are well shown. They are complex, as in the bees, involving many factors. At the center of this complex of social tendencies are: (1) The sex and mating impulses, which bring together males and females in most interesting forms of devotion; and (2) the sacrificing process of reproduction and its accompanying impulses of care and affection for offspring. In man these two associate groups of instincts and functions lead to marriage, family life, and the home, which are in their turn most important factors in the development both of the spirit and the structure of human society. These are doubtless the most civilizing functions in our human evolution; and one of the most critical and practical problems before us is the conservation and improvement of the home and family. Coupled with these two basic impulses in the making of homes, are numerous incidental tendencies and needs,—as a general gregariousness among members of the same species, the finding of shelter and comfort, the storing and preparing of food, and making rest and sleep safe. The future of our civilization depends even more on the proper management of the factors of sex, reproduction and education of the young than upon the material and economic elements in the home. There is no part of human character and behavior in which the higher psychological elements, referred to in the preceding section, have operated more powerfully than in these various attitudes underlying the home.

In this growing complexity of society, customs and regulations and special institutions to accomplish certain ends spring up in a way analogous to the origin of the division of labor in the



bee colony. These demands of society gradually mould the individuals and their social ideas. Next to the hand and to language, probably the social relations of man have been important in training his mind and developing his brain. It is easily seen that the higher qualities of man, as sympathy, love, unselfishness, heroism, and self-sacrifice, are the qualities of mind, or "heart" as we sometimes say, that would be given prominence in the home and the other really social institutions. The study of man as he adjusts himself to his social life is known as *Sociology*.

**472. Education and its Place in Human Development.—**

Education is, in general, the development of the individual in such a way that he will be able to adjust and to readjust himself rightly, in the light of his whole nature, to the essential factors of his environment. This means always to make the right response, whatever the stimuli. This adjustment has come slowly in the race, step by step in the experience of each individual. Education in mankind is an effort to give the child a short cut to the best that has been discovered by the race in its history, so that it will not be necessary for him to get it all by experience. Language is again the vehicle that makes this possible. Some education is possible through sight and imitation of parental actions, and there is probably a certain amount of such education in many of the lower animals. Confidence in the parents, imitation, and curiosity are important individual instincts underlying the education of the child. The long dependence of the child on the parents, the close relations inevitable in the home, the warmth of sympathy in the parental feeling, all enter in furnishing the motive and the opportunity for the training. That this education is efficient is shown by the fact that the individual youth in a period of twenty or twenty-five years may be brought to a knowledge of the most important experiences of the human race; to a mastery of the great implements of human progress, as spoken and written language, knowledge of nature's laws, and the relations of numbers; and to an appreciation of the great, partly natural and largely artificial structure which we call human society, as well as of the modes of behavior necessary to meet its demands.

These attainments have required thousands of years to build. Adjustment to these gains has not become instinctive. Education must supplement and guide the impulses of every new individual. It is the triumph of human education that so much can be imparted in so short a time.

473. **Man's Relation to Nature.**—There is nothing in what we can learn about man that suggests that he is not just as dependent on the natural laws of his own being and of the environment about him as any other animal in the animal kingdom. He starts in the same humble way, as a single cell; he has the same powers of growth and development, but he must have conditions favorable to them. To-day is always the child of yesterday, just as with the other animals. He has the like diseases; he is affected with similar parasites; he has enemies among the animals just as is true of the others. Equally, he depends on them for his food. The same struggle for existence and the survival of the fittest that we find in all of life can be traced in much of human history.

Man, however, has made a mastery of nature which no other forms have been able to do. Probably through his wits and his supple hands, rather than by strength, he held his own against the powerful mammals which preceded him on the earth. By the same means, but in increasing degree he holds that mastery to-day. Through his wits, again, and his wonderful hands he has managed to use the inorganic forces of nature as no other animal has done or can do. Through his wits, and most of all through his growing sympathies and unselfishness, he bids fair to build up a society, based on friendship and love, which will substitute cooperation for competitions in the broader relations of life just as it has already done in the home itself. Only by advance in this direction can we hope to have a civilization which is entitled to be called humane.

474. **The Artificial Surroundings of Man.**—In what we call civilization man has so controlled the natural conditions as to create for himself an environment which is greatly different from that under which man first lived. Clothes, houses, cities,

fire, seasoned foods, stimulants are terms which suggest some of these artificial elements that have entered into man's life. Just what their final effect will be on the body and mind of man no one can tell. Many of the most terrible diseases to which man is subject are the diseases of civilization. That his wits will continue to enable him to meet the new problems which he brings on himself, as he has met the natural ones, we may well believe. But unquestionably we must realize that his greatest task is to use his increasing mastery of nature in meeting the new difficulties which his own complex and artificial civilization is bringing upon him. Never has this truth been so apparent as during and since the Great war.

**475. The Age of Man on the Earth.**—There is no sure knowledge of when man, in his present form, first appeared on the earth. It is known that man lived in Europe in the later portion of the Ice Age, and quite probably earlier. His implements of stone are found along with the remains of such animals as the cave-bear and mastodon and man-like apes, either extinct now or found only in tropical regions. Some of the oldest of these human remains are found in southern Europe and in northern Africa. For example, in a limestone cave in the Neanderthal in Germany, fossil remains have been found of a man believed to be much more primitive than any now known. Quite a number of individuals of this prehistoric race of men have been discovered. In other words this race is regarded as a distinct *species* of men; one of several now extinct types of men that have been discovered in various localities, some earlier and some later than the Neanderthal type. We have signs of the gradual improvement of the stone implements of men from rough to smooth; the introduction of other material as bone and, later, copper, bronze, and iron. It is only after the thousands of years of this primitive, unrecorded history that we come to the history of such well-separated nations as those of the Euphrates and Nile valleys, whose monuments and inscriptions are believed to take us back 6,000 years or more.

**476. The Principal Types of Men and Their Distribution.**—It is not perfectly certain that all the men of to-day should really

be placed in one species, although if we follow them back far enough they may have had a common origin. The pigmies of Africa or the Negritos of the Philippines differ more, in a number of particulars, from the Caucasian than is true among many separate species of the wild animals, and the differences are both characteristic and constant. The varieties of men are innumerable, but there is a tendency to group them all under three main heads which we may call: (1) The white or Caucasian; (2) the yellow or Mongolian, and (3) the black or African. To these are often added the red or native American, and certain island and peninsular types that do not agree very well with any of the others. The most striking external differences are: The color of the skin, the structure and appearance of the hair, the form of the nose (which is also used in distinguishing the apes), the form of the jaw and skull. Functionally the character of the language and the social institutions help to distinguish them. Under the Caucasian race are included the wavy-haired peoples, as the chief European peoples, the Egyptians, the Jews, the Arabs, the East Indians, and the peoples of the Caucasus who give the name to the race. The Mongolians include all the straight-haired, yellowish and brownish varieties, as the Chinese, Mongols, Manchus, Tartars, Japanese, Turks, Finns, and possibly the native American tribes, as Esquimo, Indians, and the South and Central American peoples. The black or negro race includes many tropical forms dark in color and with wavy or kinky hair. Such are the dwarf Negrillos of central Africa; the Hottentots and Bushmen; the Negroes of the Nile, of the Senegambia, and of Guinea; the Caffres, Zulus, and other tribes of the east coast; and many others.

The great number of these human races, or varieties, is an evidence of the long time man has been on the earth and of his adaptability. They have arisen and have been increased by the natural tendency to vary, by the effects of climate, by migration and isolation, by interbreeding, by conscious selection of mates in accordance with local standards of attractiveness, and the like. This phase of zoology is known as *Ethnography*.

477. **The Future of the Human Race.**—Study of the life of geological times shows us that no species is permanent. Each

species increases to a maximum,—numerically and in vigor,—waned, and disappears. In a similar way genera and families rise and decline. There is nothing to indicate that the present species of plants and animals are to be exceptions to this rule. They too will become extinct by actually dying out and by replacement by other types, or will so change as to become new species, differing in some definite and significant way from the old.

Man can readily adjust himself to these gradual changes in the species about us if he can only insure that the new species which replace the old shall be as well suited to his needs as the former were. But what of man himself? Is our own species any exception to this rule of change? We have no evidence that it is. Indeed the best students of the subject hold that the species of the genus *Homo* have already changed several times since the genus first appeared. This does not mean that man ever died out and then reappeared; but that changes in our ancestors have been important enough to make a succession of species of Man.

Nevertheless man has undoubtedly introduced some new factors into the problem of his own evolution. For example, he makes, uses and improves tools for the better doing of his work, and has built up a complex industrial and economic system about this fact. He has gained power to modify and to use his surroundings as no other animal has; he can compare, and discriminate, and reason, and can preserve and convey his conclusions by means of the spoken and written language he has invented, and can thus educate as no other species can. He has organized his home and developed a spirit in his family life more far reaching than is found elsewhere. He has built up a philosophy of life, whether we call it science or religion, which enables him to prophesy and to purpose for the future on the basis of experience and faith. And upon all this he has superimposed a complex competitive-political-economic-social organization which helps or hinders the rest. By all of this he roughly measures his civilization. The student of zoology will not gain all that his course should give him if he does not properly connect all these high human attainments with the life processes he has been studying among the animals.

In all the ages of human history this civilization has been growing more and more complex, and individuals are becoming more dependent upon the common welfare. The more complex these social organizations become the more are the points at which they are open to destruction; and when they fail to function, the more profound the destruction. These human "civilizations" have risen and fallen much as species of animals have, only much more rapidly. Now and again their totterings have threatened to drag down the whole human social structure. The recent world war is an illustration of this,—the best since the middle ages. Nevertheless, thus far new groups of peoples have always come to the front, have taken over the leadership from those who have failed, and have modified,—in some ways improving,—the political or economic program. As long as there are new groups, outside the falling civilization, virile enough to improve on the old, this waning of nations is not a disadvantage to the species. Indeed all this may be a very definite check upon the decadence of the species. Nevertheless as the world is now being knitted together, it becomes less easy to destroy one center of civilization without general disaster.

From these considerations it is clear that man, as a species, has two chances to fail where ordinary animals have only one. Man, because the world is becoming more and more united into one community, may fail in his artificially built up civilization so profoundly as to jeopardize the species itself through the breakdown of our economic machinery. And, on the other hand, he doubtless has within him that inner rhythm of advance and decay which other species have shown.

In spite of the fact that it is very doubtful if man has improved organically in either a physical or mental way during historic time, our curve of efficiency as a species seems upward still, largely on account of our improvement in knowledge and in social cooperation. We may reasonably expect this upward trend to continue, unless it is broken prematurely by some vital mistake and catastrophe in the conscious phase of our evolution, as, for example, by misapplication of our scientific, social, industrial or political knowledge and powers.

The following seem to be some of the most likely factors

which might check our rise and force a sudden or a gradual decline.

1. The rapid exhaustion of the basic natural resources upon which civilization depends without a corresponding limitation in population will increase inevitably the competition between nations, classes, and individuals. Since this exhaustion is taking place in the interest of personal luxuries and of private gains rather than in the interest of permanent social evolution, we may find ourselves without the means of progress before our full capacities for progress shall have been realized.

2. There is more than a chance of the breakdown of our industrial-political machinery, because of its very complexity and weight and because it is being used selfishly and competitively, and hence wastefully, rather than scientifically for social or racial ends. Even with the best intentions our machinery always tends to develop more rapidly than our ability to use it. Coupled with injustice this outcome is made the more certain.

3. Unless we can modify the above tendencies, international wars and inter-class struggles will become increasingly disastrous. Increasing intelligence, if our present competition and economic injustices continue, will mean more, not less, inter-group conflict.

4. While we have been gradually overcoming the more conspicuous difficulties of the species, our very civilization has made us more open to new foes which are much more dangerous than the reptiles and the carnivores ever were. Our enemies now are among the insects, worms, protozoa, and bacteria. We may, or we may not, finally win in our struggle against cancer, typhus, syphilis, gonorrhoea, cholera, plague, pneumonia, and their successors, which are caused by these enemies.

5. By the very progress we have made in humane feelings and in science, we are keeping alive many strains of human stock which are socially inadequate,—as the weak, the feeble-minded, the insane, the sexually uncontrolled and degenerate. These are allowed to reproduce their kind, and in general the stocks which are below the average in capacity and intelligence, and are therefore less likely to add to the racial assets, are breeding

more rapidly than those which seem to be above the average. There is no possible way to figure out, on this basis, a human species of increasing vigor.

What can we do consciously to overcome these partly biological and partly social and economic threats against our species? The following would seem to be among our best chances.

1. To study the chemical and physiological basis of behavior, character and heredity in order to discover, if possible, chemical or other artificial means to check the internal changes of germ plasm which must lie back of any decay of the stock.

2. By preventing reproduction on the part of definitely inadequate strains, and encouraging it on the part of the more promising.

3. By limiting population to the point at which the renewable resources of the earth will give opportunity for full development to all those born.

4. By checking the use of unrenovable resources basic to the production of actual necessities for the sound evolution of the species, and by prohibiting their use in the making of those luxuries which more often injure than improve the race.

5. By exercising a rigorously scientific control over the production and distribution of the materials necessary for human welfare. This means the scientific budgeting of the material aspects of human needs, support, and progress instead of leaving these things to the cross-currents of ignorance, custom, greed, speculation, and selfish competition for private profits.

6. By reorganizing the artificial social, economic, and political structure in such a way that the premiums will actually be put on individual activity in contributing to social cooperation and progress rather than upon competition, ruthlessness and dishonesty.

7. By a conscious and thoroughgoing education of the young into this rational and cooperative spirit, and in the application of science to human problems, rather than in the attitude of selfish competition and exploitation, as at present.

478. **Topics for the Library.**—1. Study the effects of tropical conditions on the human race, as judged by the races of men now



found there: Effects on skin; on physical and mental states; on industrial and social life.

2. Study similarly the effects of the conditions of life in the temperate zones. What is the value to man of the alternation of summer and winter, in encouraging thrift and foresight; in the permanency and character of homes, etc. The effects of these things on stability of government and of social institutions generally.

3. Similarly study the conditions of extreme cold, as seen in the life of the Esquimos, Finns, Laplanders, and the like.

4. Where were the highest examples of aboriginal civilization on the American continent when it was discovered? Describe.

5. Describe the steps whereby the clan, the tribe, and the nation may be built up with the home as the starting-point. What new personal qualities are called for and cultivated by the social life of the tribe?

6. Illustrate the effects of the physical geography of the earth on man's life and history. Examples: Egypt; Greece; Palestine; the Mediterranean Sea; the depression formed by the Hudson River and Lake Champlain; the Allegheny mountains; effects of continents on races.

7. On the whole, does it seem that man has been subject to the same influence by external conditions which we have found in the lower animals? Illustrate.

8. Human migrations. Cite some of those that belong to recorded history and look at their causes and results.

9. What is the zoological character of mixed or hybrid races of men as compared with the stocks from which they were derived? What of their hardiness? Fecundity? Stability? What of the "melting pot" idea as making for a strong race?

10. What is the human population of the earth estimated to be? How is it believed to be distributed among the leading races? Which is growing with greatest rapidity? What reasons can you assign?

11. Follow some of the more modern classifications of the divisions of the human race. How do these differ from those used in the text?

## CHAPTER XXVI

### THE DOCTRINE OF EVOLUTION AND RELATED IDEAS

478. In the preceding pages the words evolution and development have been used frequently, but no effort has been made to define or justify them. In all that has been said it has been assumed that the animals now on the earth have come to their present condition of variety and complexity by natural growth and development, rather than by outright creation as we see them now. This has been assumed, not because there can be any complete demonstration of the view, but because it is more in accordance with the facts as we find them than any other theory which has been offered.

The student is now in a position to study the question of evolution more broadly, and to appreciate a more full statement of it and some of the discoveries and inferences most closely related to it.

479. **The Meaning of Evolution.**—There is a good deal of haziness in the thought of people generally as to just what the zoologist means by evolution. Evolution is not in any sense a cause; it is a term for a *process*, for the way in which present conditions have come about. Briefly, the most important elements in the thought of evolution are *gradualness* and *naturalness*. In more detail, the following features may be said to belong to the idea of evolution:

1. All life, so far as we can know, has come from pre-existing life. This year's animals are descended from those of last year; they from those of the year before, and so on back.

2. All animals are subject to change. Offspring are never just like the parents. If given time enough animals may thus change in any degree. New species may come from old by change.

3. The complex animals of the present time are descended from simpler, more generalized ones; and these from still earlier

types. So even the most developed animals of the present have arisen ultimately from ancestors as simple as the simplest. Sometimes, however, evolution is regressive, from the complex to the less complex.

4. All animals have fundamental likenesses. Some are more alike; some are less so. The fundamental likenesses mean *kinship*.

5. The process of the development of life is gradual rather than sudden, although the rapidity of it may differ at different times; it is natural rather than supernatural; it is not lawless and arbitrary, but is subject to the same laws of cause and effect which operate in chemistry and physics.

6. On the whole, the life-processes result in a closer and more perfect adjustment of organisms to one another and to the more important forces of the environment.

480. **Evidences for the Development Theory.**—Biologists generally are agreed as to the *fact* of evolution, and there is no longer any direct search for evidences for the belief. Any disagreement among them is in respect to the *manner* in which evolution has come about; and the present search is for the *cause* and the factors which produce it. Many people, however, look with some suspicion on the idea. For this reason the student should have before his mind some of the classes of facts that have convinced biologists of the reality of evolution.

481. **Variability as an Evidence.**—The changeableness of organisms is the fact that makes it impossible for the biologist to deny evolution. Every day we see differences in organisms of the same species, which variety has been brought about by differences in the surroundings, by the behavior of the organisms themselves, by cultivation by man, or by something belonging to their parents. We know that man can take advantage of these differences and can select certain types; can cultivate and select again in such a way as to get, in a few generations of cultivation and breeding, animals strikingly different from those with which he started. A proportion of these new forms seem to breed reasonably true, and a new race is said to be established. In this way the different breeds or varieties

of dogs, pigeons, chickens, and many other domestic animals have apparently arisen. None of these things could happen but for the fact that *animals can vary*. These results are not merely a proof of evolution; they *are* evolution. Any one who believes in these changes is an evolutionist by just that much.

There can be no reasonable doubt that just this kind of thing is happening in nature, without the help of man. It cannot take place, however, so rapidly as when man deliberately aids the process, by artificial selecting and breeding according to his preference, and then eliminates those that he does not want. It sometimes happens, both in nature and in cultivation, that large variations ("sports") appear suddenly, and breed true in succeeding generations. These marked variations are not so frequent as the slighter ones, but seem to be more persistent when they once appear. Whether large or small these heritable changes in animals, arising from changes in the germ plasm are known as *mutations*.

482 **Evidences from Geographical Distribution.**—In the wild state, animals usually change too slowly for us to detect that there has been any change in a species. Accurate record of measurements extending through several human generations, would be necessary in order to demonstrate permanent changes; yet we do have some evidence on a broader scale which is of a nature quite similar to that in the last section. In the way in which animals occur on the face of the earth a great many interesting factors enter, and it sometimes happens that we get some good indication of the long-time effects of variation. Sometimes we find two forms of plant or animal flourishing in two regions that are separated from each other by some kind of a barrier which does not allow them to pass back and forth and thus to mingle. These forms are in general similar, and yet are constantly and recognizedly different. Sometimes we can find that these two regions (*b* and *c*) have been stocked from some third region (*a*), and that both varieties are apparently descendants of the same ancestors. Indeed, we may be able to find specimens of all grades connecting "*a*" with "*b*" on one side, and other intermediate types connecting "*a*" with "*c*" on the

other side. In cases like this, which are by no means infrequent, it is believed that the animals found in "b" and "c" have migrated into their respective regions and in becoming adapted to their new condition of life have so changed or evolved as to become different from their parent stock and from each other.

In a similar way, but on a much larger scale and in a form too complex to discuss here, we find evidences of change and development in the animals of the great continental and other natural divisions of the earth.

483. **Evidences from Geological History.**—In the rock strata of the crust of the earth we find abundant plant and animal remains in the form of fossils. In the most recent strata we find remains similar to the species of the present time, whether of mollusks, of fishes, or of mammals. The further back we go in the earth's history the less similarity we find between the fossils and the present-day life. The earlier strata show only invertebrate remains; later the fishes appear, although much more primitive and generalized than the fishes of to-day. Later still appear amphibians, reptiles, mammals, and birds; and last of all man's remains.

The conditions are just what we should expect if life appeared on the earth in its simpler forms and gradually, by evolution through the ages, became complex and modern.

These things are not only true in a general way, but have been found to be true of the special types of animals. For example, the fossil remains of modern horses have been found in recent geological strata. The modern horse has only one toe on each foot and walks on the end of that toe. He has, however, some splints on either side of this digit which point us to the history of his toes. In the geological age preceding the present we find the remains of an animal clearly like the horse, in which these splints are larger and show more nearly the structure of normal toes. By tracing the conditions backward in geological times, links have been found which connect the skeleton of the horse of the present day with an animal of the *Eocene* period, which had four toes on the forefeet and three toes on the hind

feet and was little larger than a fox. These steps are so complete that expert students of fossils do not hesitate to regard that we have a fair knowledge of the ancestry of the horse for perhaps millions of years. Similar series of gradual changes are shown among many species of fossil animals, as mollusks, crustacea, fishes, birds, and mammals.

Of course this is not like the pedigree records that man keeps of blooded horses to-day; but it is very striking. It is entirely without explanation if animals have not been subject to gradual evolution through the ages.

484. **Evidences from General Similarities of Structure.**—In studying animals we need to keep in mind not merely the varieties and dissimilarities which we see arising, but the underlying likenesses as well. This underlying likeness of structure is really an evidence of relationship; which is another way of saying that animals, in spite of their differences, are apparently descended from a common stock. If, for example, we examine the offspring of a given pair of parents, as a litter of kittens or of puppies, we expect these individuals to be more alike in behavior, in disposition, and structure than will be the same number of offspring of totally different parents. This likeness is a sign and measure of their kinship. Two spaniels or two newfoundlands are more like each other than either is like to any other breed of dogs. The greater similarity is again the sign of their greater kinship. But the spaniel is more like the Newfoundland than either is like the wolf, for the spaniel and the Newfoundland probably belong to one species (*Canis familiaris*) and the wolf to another (*Canis lupus*).

The wolf and dog are more alike, and hence closer akin, than either is to the members of the cat family. The dogs and wolf belong to the genus *Canis* and the cats to the genus *Felis*. This is the way we express their degrees of difference. But in turn the dogs and cats are much more similar to each other than they are to the horse and cow. Because of this similarity in structure and behavior, the dogs and cats are classed together as *carnivores*, and the horse and cow together as *ungulates*.

With all their differences the carnivores and the ungulates

have many fundamental points in common. They are all warm-blooded, covered with hair, have mammary glands, carry the young in the uterus attached by a placenta. Hence they belong to the subclass *placentals* and to the class of *mammals*. They have similar parts to their skeletons, similar arrangements of the principal muscles, similar structure of the brain and central nervous system. Thus it might be shown that the Newfoundland and the spaniel are similar to all the vertebrates, and finally to all the animals.

If the similarities of structure in a litter of kittens or in a human family are a sign of kinship, we may equally believe that the similarities between the dog and the cow are also evidences of kinship; and that their differences mark the result of a gradual evolution from a common stock in special directions determined by inheritance and in adjustment to special modes of life through long ages of time.

485. **Evidences from Rudimentary Organs.**—It often happens that some animals possess organs in only a slight or rudimentary way, which in other animals are well developed and useful. In the rabbit, for example, there is a pouch called the cæcum at the junction of the small and the large intestine. It is several inches in length, well supplied with glands, and probably of considerable value in digestion. In many mammals this structure is much reduced, and in man it is only found as a "vermiform appendix," which certainly has no such value as it has in the rabbit, and is thought by many physiologists to be a positive menace.

Similarly, in many mammals there are certain muscles by which the external ear is moved and directed so as to catch the sound waves. In man these muscles, though present, are so reduced as to be of no value. Most animals have many rudimentary remnants of organs which are useful in other apparently related animals. It is said that man alone has several hundred such rudimentary structures. The rudimentary eyes of fishes and crustacea in caves, and the almost or entirely reduced organs of many parasites are mute testimony of the loss of organs once useful, through changed life conditions. In other words,

*vestigial* organs are also evidence of evolution of animals into adjustment with the surroundings.

486. **Evidences from Embryology.**—The study of embryology—the course of life in the individual—has probably furnished us the most suggestive evidence of the evolution of

FIG. 250.

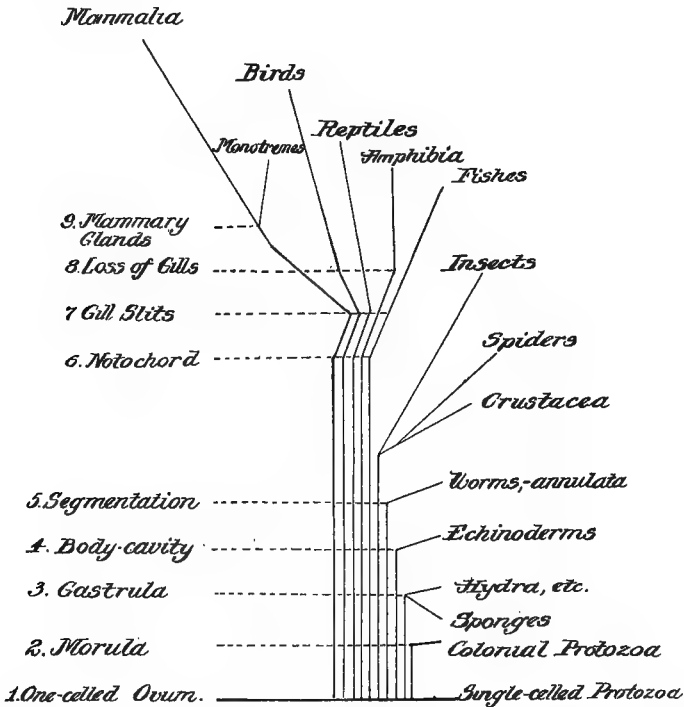


FIG. 250. A diagram to suggest the way in which individuals of the different phyla have parallel development for a while, and later diverge in their own particular way. For example, an *Amphibian* begins life as a single cell, similar to the simple protozoa (1); later it forms a mass of cells similar to some of the colonial protozoa (2); in forming a gastrula (3) it is going through a stage similar to the *Hydra*, which is a kind of permanent gastrula. *Amphibians* run parallel to the fishes in development, in the formation of a body cavity (4), in forming segments (5), in development of notochord (6), in the presence of gills in early life (7); but part company with the fishes in the fact that they lose the gills and develop lungs (8).

**Questions on the figure.**—Trace out other instances of parallelism until the purpose and meaning of the diagram become clear. Then find other facts with respect to development of animals and show how the diagram cannot do justice to the whole truth. Compare diagram with text, sections 486 and 487.

animals. The main facts, and the use that has been made of them in reaching our conclusions, may be expressed in a few brief



statements. The student must go to more extended texts for the complete handling of this complex but most interesting subject.

Some important facts of individual development are:

1. Each individual animal (with certain exceptions in non-sexual reproduction), no matter how high in the scale of life, starts its life as a single cell, similar in many respects to the permanent single-celled protozoans, except that it has the power of developing rapidly into its own peculiar species. (See Fig. 250, 1.)

2. All higher forms agree likewise in the next step of their development, which consists in the division of this single cell into a simple mass of cells. This is known as the *morula*, which is not unlike the adult, and highest stage, of such types as *Eudorina* and *Volvox* (colonial protozoa, Fig. 250, 2).

3. Practically all the higher animals pass next through a stage in which the cells become differentiated into two layers, more or less well defined and arranged in a kind of double sac—ectoderm on the outside and entoderm on the inside (see Fig. 13, A4). This is known as the *gastrula*. Animals like the adult *Hydra* (Fig. 81) are really a kind of permanent gastrula—somewhat modified in form to be sure, but a gastrula nevertheless.

The facts thus far stated may be taken as suggesting the following conclusions:

1. All organisms, even the highest, begin life at essentially the same point; that is, as a single cell. This similarity of individual origin indicates their fundamental kinship and similarity of racial origin.

2. The development of all the forms above the Protozoa is parallel for at least a brief period; that is, through the morula and the blastula stages (Fig. 13, 3 and 4). This parallelism of development added to the similarity of origin points even more strongly to their kinship.

3. There is tendency for some forms to drop out of the race and to become permanently fixed about certain of these stages: as most protozoa at the single-celled stage, *Volvox* at the morula stage, and sponges and hydra at the gastrula stage. Others go on and introduce new steps of differentiation before reaching their adult development (Fig. 250: 1-9).

487. Careful study of the later stages of development of the higher animals gives us further illustrations of these truths and enables us to state even more broadly the principles deduced above. For example, we find that insects have a parallel course of embryonic development in which the great body of insects agree (Fig. 250). The same is true of the vertebrates. One insect agrees with another insect in the mode of its development more nearly up to the complete adult character than an insect will agree with an echinoderm, or either with a vertebrate. In a similar way, all vertebrates have a course of development parallel for a longer time than they parallel any other group (Fig. 250, 1-7).

Furthermore, the same principle applies to the subgroups of the vertebrates, or of any other branch. The vertebrate development begins to differ from the insect development lower down than the divergence of the reptiles from the birds, or the mammals from the fishes (Fig. 250, 8). The parallelism between birds and reptiles ends earlier than that between one type of birds and another, or between man and the other mammals. Finally within a species, as of grasshoppers, of reptiles, or of rabbits, the course of development of different individuals continues identical through to the mature form. It is just those forms that seem most similar in structure (section 484) in which the steps of the embryonic development is most nearly identical. The two forms of similarity, structure and embryology, strengthen the idea of real kinship. If the similar course of embryological development in brothers or cousins marks kinship, the shorter parallelism of different types may also mark kinship of a less degree. Hence we have reached the conclusion that all parallelisms in the fundamentals of individual history mark some degree of relationship. The longer and more profound the parallelism the closer the relationship. A careful study of the diagram (Fig. 250) will serve to make this point clearer.

488. **The Biogenetic Law.**—Out of such considerations as these has come one of the most important and far-reaching laws that the biologists have ever stated. It is as follows: "Each

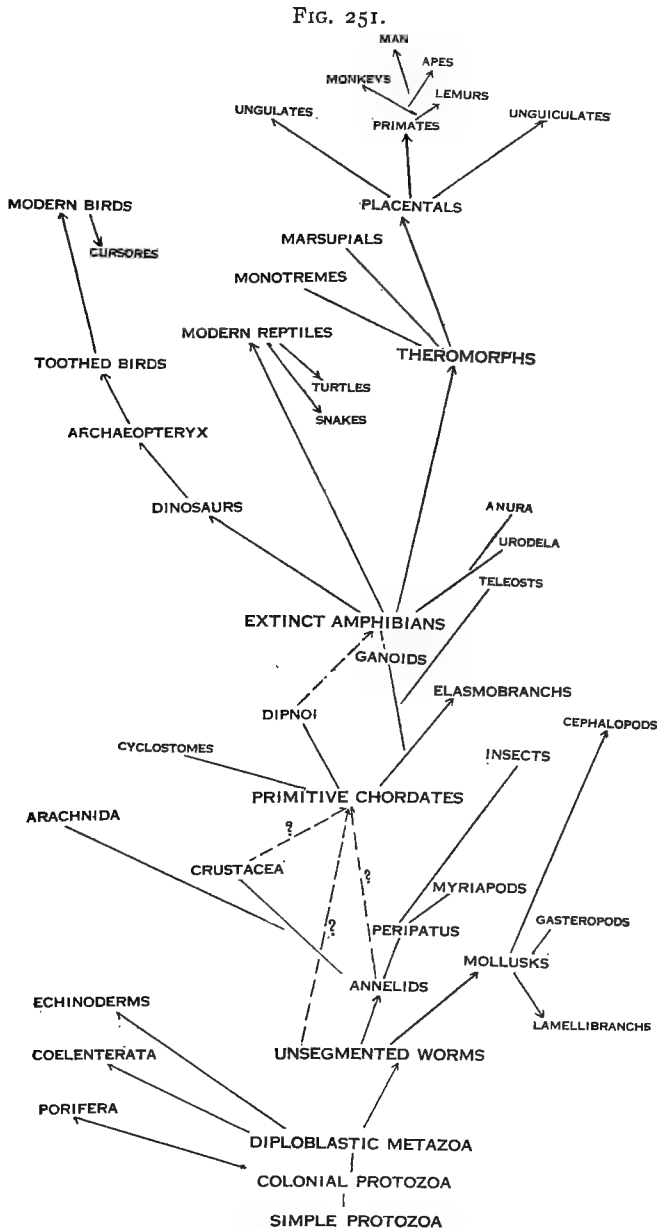


FIG. 251. A diagram designed to suggest something of the possible relationships of the various groups of animals. The vertical position indicates roughly the relative specialization or progress of the groups.

**Questions on the figure.**—Which of the groups seem to be centers from which several types may have sprung? What does this mean? Which phyla do not seem to have others springing from them? What does this mean? What three theories as to the origin of the Chordata are suggested in the figure?

individual animal, in passing from the egg to the adult, repeats in an abbreviated way, in a few days or years, many of the steps taken by the race to which it belongs, in its evolution from its single-celled ancestors to its present condition." Put briefly, it reads: *Individual history is a brief recapitulation of race history.*

Why can the individual egg cell of a frog, in a few months, pass through a morula, a blastula, a water-breathing legless fish-like stage, and into an air-breathing, four-legged adult? Because its ancestors were first single-celled animals, and through millions of years and countless generations gradually developed first into a mass of cells, later into a gastrula-like stage, and later still for long ages breathed by gills, like the fishes, and last of all became what they now are—water-breathing tadpoles with the power to breathe air in the adult life.

Because the history is so much shortened, only some of the more profound stages are recapitulated, and the advances of the race in thousands of years are compressed into moments in the individual history. Furthermore, each species has introduced idiosyncrasies that belong in no way to the race. For these reasons the general truth of recapitulation must not be applied too literally or widely.

**489. The Principal Factors Entering into Evolution.**—As was indicated earlier, biologists no longer question the fact of the evolution of the animal kingdom. They are now seeking to find the principal elements (*causes*) that are bringing about this result and the manner in which each contributes to the process. We doubtless have not found all the factors. However, those mentioned below certainly enter into the explanation.

Evolution could not take place without variation, nor without some device to preserve (*i.e.*, repeat) and to accumulate these variations from generation to generation after they arise. Furthermore, while variation may be in all directions, evolution seems to follow rather definite courses. These courses are not haphazard. They have on the whole led toward adaptation of the organisms to their most pressing surroundings. In other words there seems to have been selection and elimination of variations, and thus a guidance of evolution.

The following outline may aid the student in grasping some of the important elements of the case.

1. *Variation makes evolution possible, but only this.* We have learned (§60) that body cells and germ cells lead a parallel life in every organism. They are very different in their processes and their fate. Both of these classes of cells are in continual action, reaction, and interaction with one another and with the environment. Theoretically, therefore, variations may arise in either of two ways:

A. Changes may originate in the body cells (aside from what was transmitted from the parents).

- a. The body of a given organism may change by the direct action of the environment upon it.
- b. Parts of a body may change through use and disuse.
- c. Parts of a body may change by the interaction of one part upon another,—as in the case of the secretions from the pituitary or the thyroid.
- d. Parts of the body may change from the changed influence of the contained germ cells and the secretions that are related to these,—as in the effects of the gonad secretions upon secondary sex characteristics of the body.

B. Changes may occur in germ cells.

- a. Germ cells may be modified by the mingling of the two different germ cells,—ovum and sperm,—that originally united to form them. This new compound is different from any ever formed before.
- b. Germ cells may be modified by *their* environment,—which is chiefly the body in which they are being housed, though it is possible that the general environment also may influence them.

2. *Preservation, repetition, and accumulation of variations from generation to generation after they once appear.* Only this can insure evolution. This is the problem of inheritance, of which there are two aspects:

A. Preservation of *fluctuations* that have come to the body. If there is an early separation of germ cells and body cells and they lead a parallel course of development, it becomes a problem

whether a special quality that is gained by the body cells in their life can be imparted to their cousins among the germ cells from which the next generation of individuals arises. Unless this can be done it is clear that these bodily changes cannot be transmitted to the next generation, since the body cells do not themselves pass over. A body may have acquired a very striking quality, as a mutilation for example, without any part of this quality being found in the germ cells and thus being preserved.

B. Preservation of changes that come to the substance of the germ cells. Clearly, since the germ cells make the next generation, changes in these cells may very well influence both the germ and body cells of the next generation, and no new quality can be passed on to the next generation without somehow first becoming represented in the germ plasm. Biologists are coming more and more to feel that this is the really great field of hereditary influence, and that evolutionary studies must concern themselves increasingly with the history of these cells and the kinds of influences that can change them.

3. *The Guidance of Evolution.*—Whether we believe that the course of evolution has been purposive or not, we can, as we look back upon the course of it, see that it has actually proceeded toward certain reasonably definite goals. If evolution has been in any degree orderly, there must have been some *guiding* influences. Variations may themselves occur in an orderly or guided fashion, or if they are haphazard there must have been something which has guided in their preservation. This might take place in either, or both, of two ways.

a. If variation is guided so that chiefly suitable or appropriate changes shall occur, evolution would be controlled thereby. It is conceivable that organisms have an internal tendency to vary in definite and suitable directions; or that the environment naturally forces the changes in organic matter into channels that are fit.

b. Or, on the contrary, variations may have any range, and the environment through its life and death pressure on the organisms may eliminate some and select others on the basis of the fitness of their variation. The result of this would be to

make evolution follow the demand of the environment independently of the range of the variations.

490. **Variability and Variation.**—All organisms vary. This furnishes the materials of evolution. Variation suggests two or three things: (1) An animal may change from day to day as the result either of its own activities or of the action of the environment upon it; (2) it may differ, at any stage or condition of its life, from what its parents were at the corresponding stage; and (3) it may differ also from its brothers and sisters even at the same stage of life and under similar conditions. Some of these changes are evidently caused by conditions outside the organism; others by internal conditions. These changes make evolution possible. We do not believe that all these classes of changes enter equally into evolution. One of the most important questions of the modern biologist is this: "What produces the variation actually found in individuals of a species, and to what extent are these variations due to internal or to external causes?"

When we actually study variations in nature we find them of two principal kinds. First, and more commonly, we find what are called *fluctuations* or *continuous* variations. They are so called because they tend to cluster about a mean, with no sharp break in the series from the lowest to the highest. We should find this illustrated if we were to take at random a thousand men and arrange them on the basis of weight or height or intelligence. A curve drawn to show their distribution would give the greatest number near the average and the extremes would be gradually less numerous. The curve, however, would be a gradual one, and we would find cases illustrating all degrees within the normal range. Fluctuations are illustrated by the variations in §489, 1, A.

In the second class, however, while most members of a species will arrange themselves as above, we may find an occasional individual so different from all others that there are no "connecting links." These are known as "*sports*" or "*mutants*" and illustrate *discontinuous* variation. Experiment shows that such mutations are much less frequent, but much more liable to breed true, than the fluctuations. In the case of fluctuations even the most extreme forms produce offspring whose average

tends to be not about the extreme parent, but rather about the mean of the group. The offspring of the mutants, on the other hand, have their mean about the parent, and are quite independent of the general mean. Mutations are not necessarily discontinuous nor extreme variations, however. Small mutations behave as described above. In other words mutations are transmissible; fluctuations are not.

491. **Heredity,—the Organic Continuity between Generations.**—We have already seen (§131) that the germ cells, ovum and sperm, are the organic bridge which connects the body of one generation with that of the next. Just as new qualities cannot influence evolution until they are represented in the protoplasm of the germ cells (*germ plasm*), so all the old qualities of the race, both deep and superficial, in order to continue, must be represented in this germ plasm. We know, just because offspring continue in the main like their parents, that this germ plasm does not change easily; but, because they are never exactly like their parents, it does change some. When the germ cells have united, inheritance in the new generation has been determined. After this the parent may influence the development of the new individuals,—as the mother mammal doubtless does while the young is carried in the uterus or nourished by milk; but neither of these forms of parental influence is a matter of heredity in any sense.

In those organisms in which there is no union, where a single germ cell may develop into the adult, only one line of germ plasm is involved and heredity seems a somewhat simpler thing. However, when two different strains of germ cells unite to start the new generation, every cell of the new individual receives chromosomes, and probably other material, that came by way of both ovum and sperm. We are very confident that certain hereditary qualities are carried in some way by these chromosomes. Chromosomes from the sperm, carrying definite characteristics of the father's line, are closely mixed in the same nucleus with chromosomes of the egg carrying characteristics of the mother's line. These maternal and paternal chromosomes are distributed equally both to the body cells of the new individual and to the





have been verified and enlarged, and his conclusions tested and elaborated until we now include under "Mendelism" a large body of exceedingly important facts and suggestive theories and principles.

Mendel hybridized varieties of garden peas. One true-breeding variety is dwarf and another tall. When these are artificially crossed, no matter which variety furnishes the pollen, *all* the offspring are like the tall parent in height. The dwarf

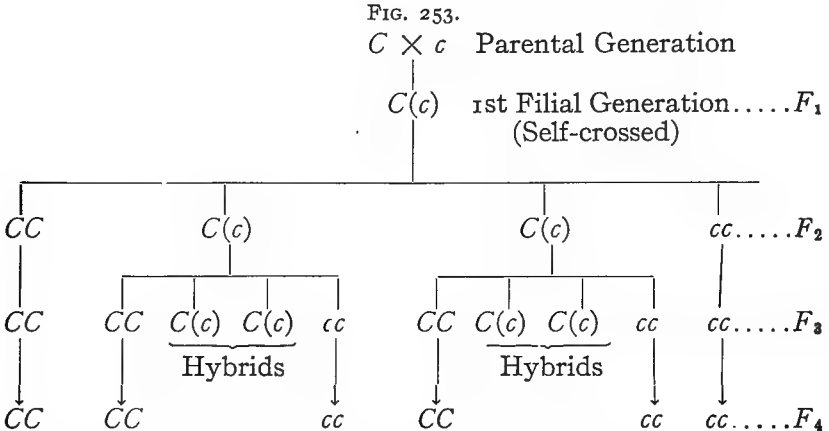


FIG. 253. A general formula for Mendelian crosses.  $C$  represents any dominant quality;  $c$ , the absence of the quality, or the recessive. The first filial generation are *all* hybrids that look like the dominant parent. If these are self-bred, the offspring of the second filial generation,  $F_2$ , will be one-fourth pure dominant ( $CC$ ), one-fourth pure recessive ( $cc$ ), and one-half hybrids ( $Cc$ ) which look and breed like their hybrid parents.  $CC$  and  $C(c)$  look alike, but breed differently. Compare with Fig. 252.

quality, which evidently must be represented in the offspring, does not show in the body at all. He therefore concluded that tallness was *dominant* over dwarfness. Dwarfness is said to be *recessive*.

When these tall hybrids were *self-fertilized*, three-fourths of their offspring were tall like the parents, and one-fourth were dwarf like the dwarf grandparent. In the case of the dwarf offspring the parents clearly transmit something which the parent body does not possess. There were no intermediate forms. Further breeding showed that these dwarfs were pure dwarfs with no taint of tallness on them; for when self-fertilized they bred true dwarf, and continued indefinitely to do so.

Close-breeding the tall showed them to be of two kinds: (1) one-third of them (that is, one-fourth of the whole offspring) were just as pure as the dwarfs were, and when self bred continued to produce tall forms indefinitely. Two-thirds of the tall (one-half the total offspring) when inbred had three tall offspring to one dwarf,—just as had been true of the first hybrid generation. Further inbreeding of the hybrid offspring continues to repeat these proportions indefinitely: 1:2:1,—that is one pure tall, two hybrid tall, and one pure dwarf.

Mendel also found that yellowness of seed coat was dominant over greenness; that smoothness of seed was dominant and wrinkledness was recessive. He also found that these different qualities were inherited absolutely separately; that is to say that the yellow or green and the smooth or wrinkled quality of the seeds might be transmitted equally in connection with either the dwarf or the tall.

The results stated in general terms might be expressed as follows: When pure bred parents differ by the presence and absence of a certain heritable quality, all the offspring of the first generation will be like one of the parents in bodily appearance. This parent and its quality are said to be dominant. When the individuals of this first hybrid generation are self-fertilized, or crossed with each other, 25 per cent. will be pure and like the recessive grandparent; 25 per cent. will be pure and like the dominant grandparent; and 50 per cent. will be hybrids like the immediate parents, having the bodily appearance of the dominant grandparent.

The diagram (Fig. 253) will aid the student in following the general results:

493. **Mendel's Laws.**—Three laws or principles were deduced by Mendel from his experiments, and have been modified by later workers.

a. *The principle of unit characters.* This suggests that organisms do not inherit the whole parental nature as a unit, but that *each* parental quality acts as a unit in inheritance. Each individual, from the point of view of inheritance, is made up of many independent unit characters which may be inherited in any combination.

Later researches support this principle in the main, but show that these unit characters do influence one another. Sometimes they are linked or coupled in such a way that one cannot be inherited without another; sometimes they repel one another so that they cannot be inherited together; and sometimes a quality that appears to us as one in the body can be shown by breeding to be made up of two or more cooperating unit characters in the germ cells.

FIG. 254.  
Possible Kinds of Male Gametes

		Possible Kinds of Male Gametes	
		<i>T</i>	<i>D</i>
Possible Kinds of Female Gametes	<i>T</i>	<i>TT</i> Pure tall	<i>T(D)</i> Hybrid tall
	<i>D</i>	<i>T(D)</i> Hybrid tall	<i>DD</i> Pure dwarf

FIG. 254. Diagram showing the possible kinds of crosses of the hybrids of the first filial generation in Mendel's peas. Each hybrid parent may produce eggs and sperm carrying, when they segregate, either tallness, *T*, or dwarfness, *D*, but *not both*. These in the long run will be equal in numbers. Each kind of sperm will have equal chances of uniting with either kind of egg.

**Questions on the figure.**—Why are these the only possible gametes? Follow out the details of the diagram and see just why the lettering in the squares is as it is, and determine the quality of the resulting offspring in each case. Is it clear why the resulting proportions are as they are? Mendelians now think of *dwarfness* as an *absence* of the quality *tallness*, and would letter it *t* instead of *D*. Develop diagrams of your own, on this basis, in lieu of Figs. 254 and 255.

b. *The principle of dominance.* There are genes, or determiners, in the germ plasm which stand for these unit characters in the body. When these are brought together by the union of two germ cells, one (*e.g.*, that for tallness) will dominate that for dwarfness (in peas). The gene for dwarfness, though present in all the cells, both body cells and primordial germ cells (see §§49, 60), has no part in developing the body. The recessive characteristic cannot develop in the presence of the dominant determiner. Whenever the dominant determiner is absent,

the alternative recessive qualities will appear. This explains why the inbred recessives *always* breed true. The recessive quality cannot show at all as long as there is any taint of the dominant quality.

FIG. 255.

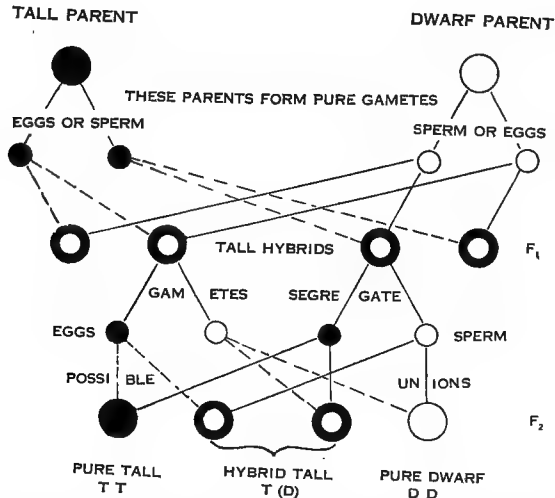


FIG. 255. A diagram to show graphically the formation of gametes, dominance, possible matings, segregation of qualities in the gametes, and the proportion of resulting offspring, in the  $F_1$  and  $F_2$  generations of the tall and dwarf peas. Black indicates tallness; white, dwarfness. Black outside the white indicates its dominance.  $TT$ , a plant in which tallness comes from each parent;  $T(D)$ , in which tallness comes from one parent and dwarfness from the other;  $DD$ , dwarfness from each parent.

**Questions on the figure.**—Why are the gametes under each original parent figured alike? Why are those of the  $F_1$  parents unlike? Why are the gametes always either white or black, not mixed as the parents may be? Carry for yourself the figure one step further, that is to the  $F_2$  generation. What kind and proportion of offspring would you get by crossing the possible gametes of  $TT \times TT$ ?  $TT \times T(D)$ ?  $T(D) \times T(D)$ ?  $T(D) \times DD$ ?  $DD \times DD$ ? Make a diagram of each.

c. *The principle of segregation, or purity of the gametes.* This principle asserts that, while both dominant and recessive determiners are to be found in every primordial germ cell, both determiners cannot go into one sperm or one ovum. In the process of maturing ova and sperm by nuclear division the two kinds of determiners separate, and thus an equal number of sperm and ova carry the dominant and the recessive characters.

In other words, while the body of an organism may be a *hybrid*, the eggs and sperm are always *pure* dominant or recessive with respect to any unit character.

In the peas, for example, if  $T$  represents the determiner for tallness, and  $t$  that for dwarfness, one-half the egg cells of the first hybrid generation will carry  $T$  and one-half will carry the recessive  $t$ . The same will be true of the male nuclei of the pollen tube. In mating the chances are even that each kind of male cell will fertilize each kind of female. The "checker-board" diagram (Fig. 254) will show the probable number of offspring of each possible type.

494. **The Mechanism of the Inheritance of Unit Characters.**—These discoveries of Mendel and his successors through breeding, when joined to other discoveries about the behavior of chromosomes in the maturation divisions (see §§49, 50) by which eggs and sperm are produced, have given us our most fruitful clues to the mechanism of heredity. The uniting of these two sets of discoveries is a peculiarly complex and technical task, beyond the scope of the present discussion. Only a few brief suggestions will be given here. The student is invited to pursue the subject in some special text on heredity.

1. The chromosomes of the germ cells seem surely to carry the genes which determine such unit characters as those discussed above. Furthermore the evidence appears to indicate that these genes are arranged in definite linear sequence in the chromosome, somewhat as beads are on a string. (We do not know that the chromosomes carry *all* the inherited characters.)

2. Thus in mitosis (metaphase stage), when the chromosome splits, each gene would be divided also. Consequently each daughter cell would have chromosomes that possess the same series of genes as did the parent cell, arranged in the same order in the chromosome.

3. It will be recalled (Fig. 11) that there are  $2x$  chromosomes\* in ordinary cells,—one half having been supplied by the egg and the other by the sperm (at fertilization). It is believed that these chromosomes really represent  $x$  pairs, and that each

\*The letter  $x$  in this paragraph is merely numerical, as in Figs. 11 and 12. It has nothing to do with the "x-chromosome" which is connected with sex.

maternal and paternal chromosome of a pair contains genes for just the same series of unit character (hereditary traits). For this reason they are called "homologous" chromosomes; and the homologous genes which they carry are at similar levels in the chromosomes. Every unit character therefore is represented by two genes in each such cell.

4. In these homologous genes there is another complication. The two genes, while relating to the same unit character, are not necessarily *identical*. For example, the gene for "tallness" and that for "dwarfness" relate to the same quality, but differ in their influence. The two homologous chromosomes might in the case of peas carry two genes for tallness, or two for dwarfness, or one for each, depending on the character of the parents.

5. During the development of the body of an individual plant or animal, these pairs of maternal and paternal chromosomes retain their independence within the nuclei. However, in the maturation of the new generation of germ cells, whether eggs or sperm, these homologous chromosomes actually *unite in pairs* (see §50) and form the *bivalent* chromosomes. At a subsequent division these pairing chromosomes separate and pass to two different cells (segregation). In this way each daughter cell (egg or sperm) receives only one of each pair of the homologous chromosomes, and hence only one from each pair of genes. This is the reduction division so frequently referred to, and seems to explain how the "purity of the gametes" may be secured. If the pairing chromosomes both carry the identical gene (as for tallness), the germ cells would all be alike in respect to this character. If however one of the pair of genes is for tallness and the other for dwarfness, the resulting germ cells would be wholly different in this character, and would carry a very different inheritance.

6. The fact that certain unit qualities tend to appear together, as the linking of color blindness with sex in human beings or color with sex in mating black Langshans and barred Plymouth Rocks, is believed to be due to the tendency of certain adjacent genes to hang together more tenaciously than the average. This association is not, in all instances of linkage, an absolutely fixed one.

7. At this point a most interesting question arises. If a single chromosome carries many genes and at division splits all of them, as has been indicated, how does it come about that qualities determined by this chromosome, when once brought together, are not perpetually *linked*? How could the unit characters ever be combined in any different way? It is believed that two homologous genes or groups of genes may "cross-over" during the pairing of the chromosomes preceding the reduction division. That is to say that exchanges of genes may take place between the chromosomes, each gene coming to reside in the other member of the pair. It is thought that this shuffling of the genes by the combination of linkage and crossing over, helps to account for the various permutations of unit qualities seen in breeding. It will be seen that this gives rise to no *new* qualities.

8. Much evidence has been accumulated pointing to the conclusion that maleness or femaleness (sex) is inherited very much as other unit characters, and is determined by one or more special chromosomes or by certain genes in these. Quite a number of sex-linked characters have been discovered.

495. **Isolation.**—When new variations occur it is clear that they will have a better chance to accumulate and result in a new and permanent stock if for any reason these new characters cannot be "swamped" or buried by crossing with the more numerous and conservative members of the parent stock. Recessive qualities could be prevalent only through such isolation.

The effects of geographic or physical isolation is seen on islands which have been populated from the mainlands, or in neighboring lakes, or in valleys between which there are barrier mountains. In such conditions the animals and plants are distinctly different from the species from which they are believed to have sprung, and those on different islands are different from one another. It is believed by many observers that a larger number of related species is found under such conditions than where there is free interbreeding and migration.

It is possible also that there are internal hindrances to mating which would operate in much the same way as geographic isolation. There may arise some instinctive feeling which would



prevent mating between the average members of a species and individuals that had varied considerably from that average. We see this in some degree in human races. Or changes in the copulating organs or in the reactions of the germ cells might render such free intercrossing impossible.

Finally, we have seen in Mendel's experiments that certain unit characters, even when the sperm and ova unite freely, do not permanently coalesce and blend; but sooner or later may separate out pure again. In a sense this is a case of physiological isolation of the structures that carry the varying characters even in the union of germ cells.

We may say then that the varying animals may be kept apart by geographic barriers; or the germ cells may be kept apart even when the animals live freely together; or the character-bearing determiners (genes) may be kept apart even when the germ cells come together.

496. **The Environment.**—Assuming that variations occur and make evolution possible, and that heredity enables some of these variations to pass from one generation to another and thus to accumulate, and that isolation keeps the various individuals from evening up and thus destroying their variations by intercrossing, it still remains to find the factors that have determined and guided the actual course of evolution in any given instance. Why has development taken the course it has?

Theoretically, as we have seen, there might be an inherent tendency in living matter at the beginning to vary or evolve in a certain direction. Biologists are not agreed upon the existence of such a tendency. On the other hand, the environment—meaning the total external conditions of the life of organisms—may guide or direct the course of development. Any guidance must come from the one or the other of these sources,—internal or external.

The environment may act in either of two ways to mold evolution. We have seen in the first place that the environment does act directly to *produce* specific changes in organisms. If these changes can be inherited, this will be a most important means of guiding evolution. It is not certain, however, that

these direct effects of the environment on the body of an organism can be transmitted to the germ cells. External conditions may likewise act directly upon the germ plasm so as to produce changes in its nature. Doubtless such changes would permanently affect future generations.

Whether or not the environment can act to *produce* inheritable changes in organisms, there is another effect of the environment which has certainly had a great influence on the *course* of evolution. The principle was discovered by Darwin and by him called "natural selection." It refers to the fact that the struggle for existence among organisms is so severe that some will inevitably be eliminated. We have seen that this is true among all species. A hundred are born of two parents: only two of these, on an average, will be preserved. Which will be successful? In the long run, those will be preserved which are best adjusted to the conditions of the life which they meet. This fact is independent of how they came to be adjusted. This is known as the "survival of the fittest." "Fittest" merely means those best adapted to live and reproduce in the environment encountered. This process of natural selection *does not cause variations* but it may make use of any variations that arise, no matter what their source nor how small in amount, provided they can be inherited; that is to say, if only these variations are really mutations. In so far as it acts, its result is to guide evolution into suitable adaptation to the conditions that are able in any degree to influence life. Nature undoubtedly can exercise at least a veto power on the direction of evolution. Darwin's doctrine of selection has been much criticized in recent years. It is, however, the only theory for the *guidance* of evolution for which there is any definite evidence.

In brief, the origin of heritable variations is in the germ plasm, produced certainly by new combinations of germ plasm, and conceivably by the direct or indirect influence of the environment upon the germ plasm. And the guidance of these variations into permanent evolutionary results is secured by the selective power of the environment.

497. **Evolution and Man.**—Many people are deterred from accepting the general theory of evolution because of unwilling-

ness to believe that man and his high mental and moral qualities could have come about in this fashion. It is of course impossible absolutely to prove that men or any other animals have thus evolved from the lower orders because a perfect pedigreed succession can never be established. All that can ever be done is to make it the most reasonable explanation for the conditions as we find them. In reality it cannot make any material difference, one way or the other, whether man developed or was created outright. One does not escape or solve any final philosophical problems in relation to the ultimate causes of the universe by accepting or refusing to accept evolution. It is a *method* and not a form of *energy*. No quality of man is any less valuable or dignified under the assumption that it has grown than under the assumption that it was made outright. Man's social or moral place in the universe, like his place in American society, is properly determined by what he really *is* and not by the mere incident of the method of becoming.

498. **Topics for Library.**—1. Find definitions of evolution. Write one of your own.

2. What are some of the arguments that have been offered to support the view that "acquired" bodily characters are transmissible?
3. State some arguments that have been advanced against the view?
4. State briefly Galton's law of heredity.
5. What does the *gradual* development of the physical, mental, and moral nature of the human individual suggest?
6. State DeVries' doctrine of "mutation" in a brief way.
7. State Johanssen's "pure line" theory.
8. State the modern usage of the term *mutation*.
9. What is meant by "genotype?" By phenotype? Can we change the genotype by changing the phenotype?
10. Discover some of the facts about the location and arrangement of the *genes* (or determinors) in chromosomes. What does *linkage* mean in this connection?
11. Mention instance of "crossing over" in Mendelian inheritance. Evidence for it? How is "crossing over" supposed to take place?
12. How is sex determined, in accordance with the Mendelian theory? What evidences do we have that nutrition or other environmental factors enter into sex determination?

## CHAPTER XXVII

### ECONOMIC ZOOLOGY

499. Reference has already been made in the appropriate places in the text to some of the most important ways in which the various branches of animals are related to human welfare. We are now in a position to look back over the economic bearings of all animals and to get a broader view of the part they play in the life of man. This is a point at which Zoology touches the interest of every citizen of the world, whether he has any other interest in it or not. The economic aspect should therefore be one of the features of the study of Zoology in our schools.

**500. An Analysis of the Ways in which Animals Affect the Welfare of Man.**—1. Helpfully: (a) as food; (b) for clothing; (c) in the saving of labor; (d) in scientific experiment and medicine; (e) for pleasure, as companions and pets or in various esthetic ways; (f) in minor miscellaneous ways.

2. Hurtfully: (a) directly hurtful or dangerous; (b) as causes or conveyors of disease in man; (c) as enemies of our friends among the animals; (d) as destructive to vegetation; (e) as injurious to various manufactured products.

These headings are by no means exhaustive nor of equal merit, but they will give the student some conception of the closeness of the bond between man and the rest of the animal kingdom.

**501. Animals as a Food Supply.**—The difficulties of human life have been such at various places and times that man has experimented with almost all kinds of food that have held out any sort of promise of nutrition or pleasure. Notwithstanding this, very few of the invertebrates have been given a wide place in his bill-of-fare. The lowest forms eaten are the "trepangs" (holothurians) which are used in great numbers by the Chinese. In the Phylum of Mollusca the oyster is at the head in importance. There are also a number of marine and fresh-water clams and mussels which are used in smaller numbers. Some

species of gasteropods (snails) are prized in certain parts of the world. It is believed that the mussels were an important article of food to some tribes of North American Indians, and to some of the peoples of the old world when they were in a corresponding stage of development. Among the arthropods the lobster comes first in importance, although it has been fished to such an extent that the output is rapidly diminishing and the size of specimens on the market is steadily decreasing. Crayfish, shrimps, prawns, and crabs are also used to some extent. The great class of insects furnishes only the honey of the honeybee. Locusts have sometimes been used as a famine ration, and among some primitive tribes normally.

Every class of vertebrates furnishes food species. The amphibians and the reptiles stand lowest in this respect. The frogs and turtles and a few lizards are their only edible representatives. The fishes, the birds, and the mammals furnish the staple meat foods. A very large per cent. of the fishes are recognized as edible. Many species of the sharks, even, are prized although they are actively carnivorous, and the carnivorous animals have usually not been regarded popularly as good to eat. Numerous species of birds have been eaten, but those that rank as of real importance belong chiefly to the Gallinæ, the Columbæ, and the Anseres. These three classes of birds supply to man hundreds of millions of dollars worth of his choicest food annually.

Among the mammals many species have been eaten, but the great division of ruminants and the swine furnish the bulk of the meat food now used by the human race. The horse is not without importance in this respect although not often eaten, in this country, knowingly. Among uncivilized people, before the domestication and improvement of the ox, the sheep, and the hog, this division (ruminants) still furnished the chief wild game animals. Besides meat they furnish milk, butter, and cheese. In the far north the walrus, the bear, and the reindeer take the place of these well-known forms.

502. **Animals as a Source of Clothing for Man.**—In the case of primitive man the skins and furs of animals were the sole source of clothing and one of the means of building and

making comfortable tents and other dwelling places. As the art of weaving was developed and the discovery and perfecting of textiles derived from plants made headway, we became less dependent on the animals. But even now, in one form or another, the skins and the fur, hair, and wool of animals are among our choicest clothing materials. The mammals are of course the main animal source of clothing, but the warmth of feathers has long been recognized, and the skins and feathers of birds furnish articles of clothing and decoration. The important mammals supplying the kind of hair suitable for clothing and for carpets and other coarser fabrics are: the various species of sheep and goats, the camels, the alpacas, and their relatives. Our leathers are made from the skins of these and related animals, and from some of the carnivora. Practically all the ruminants produce valuable leathers. Horse hides also are used for this purpose. The skins of many of the soft, thick-haired animals are dressed with the hair on, and are known as furs. Most of these, as the seals, the sable, mink, ermine, weasel, raccoon foxes, skunk, members of the cat family, and some others, belong to the carnivora. A few, as the squirrel, the hare, and the beavers (now almost extinct) are from the rodents.

One of the most marvelously delicate and beautiful of our fabrics, silk, is a secretion spun out by the larvæ of the silkworm in making the cocoon in which it pupates, or changes to the adult stage. It is killed by being put into hot water, and then the silk thread is unwound. The silk industry is of much importance in China, Japan, Italy, and France.

503. **Animals Used in Saving Human Labor.**—In the earlier stages of civilization this help consisted of aid in hunting and capture of food-animals. The dog was probably one of the first animals domesticated. Later others came to be used for riding, for drawing loads in vehicles or otherwise, for plowing the soil, and the like. The camel, the ox, the horse, and the elephant rank among the most valuable in these respects. In the earlier civilizations of the orient, the camel has been of the utmost value. His adjustment to the tropical and semi-arid conditions is striking. The "ship of the desert" is an older means of commerce than the navigation of the sea. His

relatives in South America, the llamas, have long been used as the chief animal of burden in the Andes. The reindeer is at once camel, horse, and ox of the frigid zone. The dog is also an efficient beast of burden over the snows.

In modern times the horse has come to be one of the most valuable of animals used by man, ranking in money value next to the cattle in the United States. The mule, which is a hybrid between the female horse and the male ass is a hardy, strong, infertile animal and one of our most valuable beasts of burden in agricultural communities. Since the preceding sentences were first written, about 1900, the horse has been rapidly displaced by the great development of the motor. The student will not fail to realize that the more powerful groups of human beings have used other men as animals in very much the manner we have been describing. While slavery is not now legalized over much of the earth, this exploitation of other human beings for profit is just as real as it has ever been.

Steam, gas and electricity are replacing animal power at many points, but there is little likelihood that the animals will be entirely displaced until population becomes so numerous that they are more valuable as food than they can be as labor-saving devices.

**504. Animals in Science and Medicine.**—A most interesting way in which animals have been of value to the human race grows out of the fact of the general likeness between man and the lower animals. It is safe to say that the great advances in surgery which have accomplished so much in the saving of human life have been made by early experimentation on animals in the laboratory, even more than by the actual direct study of the human body and its conditions. Experiments quite impossible of being made on human beings have first been tried on animals and have been found to accomplish what was expected of them. But it is not merely in surgery that they have shown themselves most valuable to human life. In all the work on antitoxins and serums with which to combat the germ diseases, the work must first be done on animals. The antitoxin of diphtheria comes from the horse; the virus by which we vaccinate for smallpox is obtained by giving the disease to the ox, which is only mildly affected by it; and so on

through a considerable list of such diseases. The most hopeful work that is now being done to give us control of the terrible disease of cancer is being done on mice and rats, otherwise an enemy to human interests.

It has been discovered of late years that many organs of the body secrete into the blood that passes through them, certain substances that have a most important bearing on life. Sometimes these organs become diseased and refuse to do their work. This may be true of the digestive glands, of the thyroid glands in the neck, and other glands of internal secretion. In such cases the gastric juice of the pig, or the thyro-iodin obtained from the thyroid of the sheep, or pancreatin obtained from other animals may be administered in such a way as to carry on the function or even to overcome the disease.

Frogs, rabbits, guinea-pigs, cats, dogs, sheep, cows, horses, and monkeys are among the animals that have been most useful in these respects.

505. **Miscellaneous Uses of Animals.**—This book is largely given to emphasizing the intellectual, esthetic and other educational values of animals. A long list of minor and exceptional uses of animals could be mentioned. The dog and cats have some protective value about the homes of men, where they were long before recorded history began. They have kept homes free of vermin, as rats and mice and the smaller animals, and the dog has doubtless been of protection from other enemies. They have been companions for childhood through all history.

The skins and tendons and bone of animals figured largely in all the early home industries, as sewing and tying and the like. In modern times the skins are used in many ways, as rugs and home ornaments, in the making of bags and other receptacles. Horn, bone, and ivory from the teeth and tusks of animals are fashioned into knife handles, piano keys, billiard balls, and numerous other objects. Whale oil (sperm oil) has long been used in making candles, though it has now been supplanted by the cheaper mineral oils. Bristles, brushes, perfumes, oils, glue, buttons, and fertilizers are only a portion of the numerous by-products of the modern meat-packing houses. Ornaments are made of teeth, of corals, and of pearls. Many animals are



scavengers, attacking and destroying carrion and other decaying organic matter. Some animals get their value to us because they naturally attack and check such enemies of ours as the insects, which we are not yet able to control.

506. **Animals Directly Injurious to Man.**—When man first appeared on the earth many mammals now extinct, much larger and fiercer than those of the present time, were abundant. Unquestionably these were much more of a menace to him than the predaceous animals are now. These animals, except in a few poorly inhabited parts of the world, are now practically negligible. A few poisonous snakes, some sharks and crocodiles, a few members of the cat and dog families and a few species of bear, almost extinct, about exhaust the list of animals really dangerous because of size or ferocity. But in place of these there are now numerous species that are no less dangerous to him because of diseases which they bring to man directly or indirectly. Reference has been made to Protozoa which produce malaria and yellow fever, and to the intestinal and other parasites that belong to the unsegmented worms and produce all sorts of discomfort, inefficiency, and disease among men. The mosquitoes and flies and other insects that spread these diseases are just as important to us as the germs themselves. The bubonic plague is a disease of rats and other rodents carried to man from the rat by fleas. All these temporary external parasites that go from animal to animal, as lice, fleas, bedbugs, mosquitoes, etc., are especially favorably situated to be the carrier of disease. Cattle are subject to tuberculosis; and many investigators believe that this is the same as the human disease, or at least that it is intercommunicable in man and cattle.

507. **Animals Hurtful to our Animal Friends.**—Our domestic animals are apparently almost as open to diseases as man himself. Hence it is that there are many animal diseases, caused by the various parasites of blood and organs. The Texas fever of cattle; the hæmoglobinuria of cattle and sheep; pébrine, a disease of the silkworm; the sleeping sickness of Africa; etc., are due to protozoa, and are carried by ticks, flies, and the like. The liver-rot and staggers of sheep, and the various tape-worm and hook-worm diseases of hogs, dogs, cattle, and man are

caused by the unsegmented worms. The "bot" diseases of horses, sheep, and cattle are produced by the larval stages of flies. Mange, itch, etc., as found in various domestic animals, are due to the action of mites. These also attack poultry.

**508. Animals Hurtful to Plants and Plant Products.**—At this point animals, more particularly the insects, do great damage to man's interests. The story is too long to tell here, but insects attack plants at every stage of their history from the time they germinate until the time they are stored. They devour foliage, fruits, timbers, seeds, stored grain, and manufactured products. It is said that "the elm has eighty species of insects that are more or less supported by it; birches and maples, over one hundred; corn is attacked by about two hundred species, of which fifty do notable injury and some twenty are pests; apple insects number some four hundred species."

It is estimated that the farmers and fruit growers of America alone lose above 500,000,000 dollars annually from the ravages of insects on crops and forests. Man has done much to control most animals except the insects, and something to control them. The most effective means thus far found include spraying plants, to keep away the females when about to lay, or to kill the young; the rotation of the crops in such a way that the insects may hatch without finding the kind of food on which they depend; and the introduction of animals, either predatory or parasitic, that attack the hurtful species.

Occasionally through a period of years such animals will multiply to such an extent as to become a plague, when in ordinary years they merely reduce the returns of the agriculturist. Such are the outbreaks of the Rocky Mountain locust, the Hessian fly, the San José scale, the chinch bug, and the like. Less frequently similar things happen in respect to other animals, as the plague of rabbits in Australia, and of the rats in the Bermudas.

**509. Domestication of Animals.**—Occasional reference has been made in the preceding paragraphs to the *domestic* animals. This means something quite different from the merely *useful* animals. This term refers to the control by man of the life

and habits of animals to such degree that he can work his will with them almost irrespective of the natural conditions. This domestication began before man emerged from the savage state—before recorded history began. The dog and cat were doubtless among the earliest forms, and the camel, the horse, the sheep, the donkey, the hog, the pigeon, the chicken, all have been very long in domestication.

The qualities that would make an animal suitable for domestication, and which doubtless helped to determine what forms should be domesticated, are: some gentleness of temper and lack of extreme nervousness, capability of taking training, ability to become adapted to new surroundings, some love of locality, and usefulness for food or for some other of man's real or fancied needs. The effect of domestication on animals has been to soften and dull their original wild instincts, to render them less active and alert, to render them dependent on the care which man gives them, and to produce a tendency to take on fat easily when food is plenty.

**510. The Animal Industries.**—The animal industries cluster chiefly, but not wholly, about the domestic animals. These domestic industries relate to horses, cattle, mules, sheep, hogs, poultry (including chickens, turkeys, pigeons, geese, and ducks), and constitute a large part of agriculture in the United States to-day. The successful pursuit of these industries involves a scientific knowledge of the animals reared and of their possibilities and demands. Much of this in the past has been done in a haphazard sort of way, somewhat incidental to the raising of crops. In the last half-century, however, there has been a better application of the known principles of stock-breeding and of selection than before. The modern stock-breeder crosses and recrosses various strains of cattle or hogs in order to get variety of result. Then he selects what pleases him most and breeds that in such a way as to fix and increase the features which he regards as most profitable, whether it be swiftness, size, milk-giving, cream-producing, finer wool, fertility, or the power to take on fat. This is the reason we have so many varieties of all the animals that have been long in domes-

tication. Different breeders have been, more or less consciously, selecting different qualities in animals. Men are now pushing this process even further, and are purposely and systematically producing and selecting new and better breeds on a scientific basis. The evolution will be correspondingly more rapid. Domestication is an experiment in evolution on a grand scale.

All the animal culture mentioned above is done in connection with plant culture and often on the best land the country has. There are other industries which have great possibilities in regions not suited to agriculture. Man has used some of the natural resources of these less used regions in a very prodigal and reckless way. He has not taken pains to look ahead and to act scientifically, simply because he has not been compelled to do so. The time, however, has come when the farmer uses systematically the less productive parts of his farm as well as the more fertile. If not fit for cultivation he uses it for sheep or goats or something which is best adapted to it. So it must be in the future with the whole earth. The oceans, the rivers, the swamps, the ponds and lakes, the arid regions, and the mountains must be stocked with animals that will contribute to man's food. These animals must be helped to take the place of those which are of no use. This means that the various fishing industries, as mackerel, cod, herring; and even more particularly the fresh-water fisheries, as the salmon, whitefish, and other lake and river fish, shall be more than the mere catching and canning of such fish as have been able to fight their own way through to successful maturity; they will include the bending of all possible agencies to the building up, improving, and maintaining the numbers and quality of these fish. Oyster, lobster, pearl-mussel, and sponge fishing will be more than merely to put on the market the biggest possible amount regardless of the future; it will rather be the stocking of all suitable places of the ocean margin that are not more profitably used for something else with the young of the types wanted, keeping away the enemies of the species as well as possible, and doing artificially all that can be done to insure their steady and profitable growth. The scientific treatment of these industries means the putting on the market only those that have got their

best growth and with the least injury to the partly grown individuals, just as it does on the farm or in the forest.

The conservation of our natural resources also means that the swamp lands, that cannot be drained and used more profitably, and the shallow streams shall be made to produce edible frogs or turtles instead of the other inedible amphibians and reptiles. Wherever edible fish can grow pains will be taken to place them and see that the conditions of their best life are given them.

Various bureaus of the United States Government, as that of Animal Industry, of Fish and Fisheries, of Entomology, and the like; the Agricultural Experiment Stations and the Natural History Surveys of the various States; the scientific men in the universities and colleges, and many practical workers who are in these fields in a commercial way, are studying the problems suggested in this chapter and are trying to add to the vital resources of the human race and its increasing population. It is the duty of every American to get into a sympathetic attitude to all this work.

**511. Topics for the Library.**—1. Give a report of the United States Bureau of Fish and Fisheries. How is it organized? What are its principal stations? What work does it undertake to do? What are its chief publications?

2. Discuss similarly the Bureau of Animal Industry; the Bureau of Entomology; the Biological Survey.

3. Give an account of one of the inland fish hatcheries and its work.

4. Why are the vegetable feeding animals preferred for food above the carnivora?

5. Why are woolen fabrics warmer than cotton or linen?

6. Will the vegetable food or the animal food that can be produced and supported on ten acres of ground go further in supporting human life? Discuss carefully.

7. Do you think the tendency will be to increase or to decrease animal culture as population begins to press upon the resources of the soil? Give the biological reasons fully.

8. What are the chief arguments against vivisection and experiments on living animals by investigators? What the chief arguments in favor of it?

9. Discuss the various products of the hog, utilized in the packing houses.

10. Discuss the animals that frequent human habitations, becoming pests in some degree. Give the habits of life of each so far as you can by study and reference.

11. Discuss with some care what is known of the history, the different varieties, the use, etc., of some of the domestic animals, as the dog, the horse, the fowl, the ox, and others.

12. Discuss human slavery as a zoological phenomenon. To what is due the tendency to abolish it?

## CHAPTER XXVIII

### DEVELOPMENT OF ZOOLOGY

512. **Introduction.**—Long before man discovered a way to record his knowledge he must have learned much about plants and animals. His well-being depended on it. Here he got his food. His most dreaded enemies were the great mammals that were on the earth when he appeared. His success in evading his enemies and in capturing his food made it necessary that he know something of their haunts and habits. As he learned to domesticate some of these animals, both for protection and for food supply, his knowledge was extended. As the animals were slaughtered for food and clothing and for his primitive religious rites, he learned something of their internal structure. This early knowledge probably had little pure scientific interest back of it. Most of it was incidental to the uses he made of the animals, doubtless reinforced somewhat by the feeling of wonder and the esthetic sense. In a similar way human accidents, pain, diseases, and deaths doubtless led to some study of the human body and its care and cure, as soon as human intelligence was able to grasp the situation.

It is not easy for us to whom the discoveries of the last 400 years are a well known story to realize how fragmentary and unscientific were the ideas of the early times.

513. **The Greek and Roman Periods.**—So far as we need consider here, the foundations of modern zoology were laid by Aristotle (384-322 B.C.). It must not be imagined however that his was the first effort to bring together the knowledge already gained. For example, ancient Egyptian documents twelve centuries older than Aristotle give elaborate discussions of medical subjects.

Aristotle is chiefly known as a philosopher and logician; but he was a most prolific student in many realms. He made two great contributions to natural history: (1) he brought together

in three works—“*Historia Animalium*,” “*De Partibus*,” and “*De Generatione*”—what was known of the nature and classification of animals, their anatomy, and their development; and (2) in his own great discoveries he, more than any other of the ancients, insisted on the scientific method of depending on observed facts rather than on tradition.

He did the first task so well that his successors did little to follow his scientific point of view for nearly 2,000 years, but merely asked what Aristotle had said on the subject.

Another Greek, Galen, did for medicine very much what Aristotle did for zoology. He made anatomy and physiology the foundation of medicine. Because it was forbidden to dissect the human body, he studied the bodies of monkeys and other mammals. For centuries his successors, also, followed his conclusions without using his methods.

The name of the Roman, Pliny (23–79 A.D.) is usually mentioned here because of a great collection of writings on natural phenomena. He fell away, however, from the spirit of Aristotle and Galen, and brought together without much discrimination facts and nature-anecdotes of the most fanciful kind. The Romans did very little for natural science.

514. **The Middle Ages.**—During this remarkable period of human history (400–1500 A.D.) practically no progress was made in the natural sciences. It was a period of waning of the old human civilizations and the incubation of the new. Wars, difficulty of travel, the other-world attitude of the Christian church, and many other things discouraged observation of nature and discovery. It was a time of mysticism, of metaphysical speculation, and of large dependence on the authorities. A large portion of it has been called, not inappropriately, the Dark Ages.

515. **The Modern Period (1500–1900) and its Specializations.**—In every department of human interest the revival following the “dark ages” is one of the most remarkable movements of history. This is no less true in our science than elsewhere. It was more than a revival of interest. The authority of the church and of the past had so intrenched itself that the greatest difficulty lay in getting back freedom of investigation and

utterance. The first task was to throw off tradition and authority. The names of Gallileo, Descartes, and Vesalius belong to this period of revival. Italy had a large part in the renewal of scientific work, as in other fields such as art and literature.

Starting with the general interest in natural history and classification and in medicine and anatomy, which was seen in the work of Aristotle and Galen, the modern period has developed a great many special departments, as the various workers have followed particular studies. We may profitably consider the progress in Biology under the following heads: (1) Natural history and classification; (2) Anatomy and its departments; (3) Physiology; (4) Embryology; (5) Philosophy of Biology; and (6) Applications of Biology. Of course these divisions of interest took shape only gradually, and a worker often contributed to several departments, especially at the outset.

516. **Natural History and Systematic Zoology.**—Naturally enough, until the more important animals had been recorded and compared and classified and their more striking habits and modes of living studied, these general considerations would present a most fruitful and enticing field of investigation. Gesner (1516–1565), a Swiss physician, studied animals widely and wrote a “history of animals” which was the best general zoology since Aristotle. His work, which was profusely illustrated, largely influenced later studies.

Ray (1629–1705), an Englishman, was a student of both plants and animals. In addition to his own original studies and discoveries he introduced the idea of the *species* as a definite group of organisms arising from similar parents. He was thus the real founder of modern systematic biology, and the forerunner of the great Swedish naturalist Linnæus (1707–1778), who published the *Systema Naturæ* in an effort to describe all the known species of plants and animals. Linnæus combined Ray’s *species* with the *genus*, and first used the generic and specific names as the name of the organism (*binominal nomenclature*). He invented also the brief descriptions of genera and



species. His work greatly stimulated systematic studies and laid the foundation for work in other fields of zoology.

Buffon (1707-1788), in his *Natural History*, Cuvier (1769-1832) in his "Animal Kingdom," Lamarck (1774-1829), von Siebold (1804-1885) and many later naturalists have worked to perfect our system of classification of animals.

517. **Anatomy and its Divisions.**—We have seen that Galen studied the anatomy of lower mammals to throw light on medicine. His accounts became the accepted rule for centuries. Vesalius (1514-1564) a physician, born in Brussels, made elaborate studies of the anatomy of the human body as well as of many other animals. He published a great work on the "Structure of the Human Body," in which he denied many of the views held previously. His discoveries were illustrated by many most effective figures and plates. Both because of the scope of his work and of this investigative spirit Vesalius laid the foundation of modern scientific Biology. It was not so much that all his conclusions were correct. He did what was much better; he made it possible for his successors to criticise and add to his work by following his own attitude. This makes progress.

From the study of the habits and exterior of animals, and the study of human anatomy, students would naturally pass to a study of internal structures. As time passed and details of structure accumulated, two new lines of study would be developed: a closer comparison of the structure of different organisms, and, second, the study of smaller and smaller structures. The former is called *Comparative Anatomy*, and the latter *Histology* and *Cytology*.

As in all other branches of Zoology there were forerunners of the chief discoverers, but the French naturalist Cuvier, mentioned above, was the first zoologist to undertake to compare the structures of all the groups of animals on a wide scale. His work strongly influenced his successors, particularly in France. He was thus the real founder of comparative anatomy. It was on the basis of these studies in anatomy that he made his contribution to the classification of animals. Some of those who continued the work of Cuvier were, Milne-Edwards (1800-1885)

a Frenchman, who gave us the idea of differentiation of parts and division of labor and showed its value; Richard Owen (1804-1892) an Englishman who developed the contrasts of analogy and homology in organs (see §113); Thomas Huxley (1825-1895), who did much to popularize zoology and to introduce the laboratory method into schools; Karl Gegenbauer (1826-1903), whose power of analysis and discrimination have made permanently available the work of his predecessors; and the American, E. D. Cope (1840-1897), who added greatly to our knowledge particularly in the comparative anatomy both of living and fossil forms of vertebrates.

From the study of the organs interest passed continually to the smaller and smaller units,—tissues and cells. Bichat (1771-1801) a brilliant French anatomist studied the tissues of the body, especially the membranes and their function and disorders. While he did not make use of the compound microscope as his successors did he opened up the new field. At this time the microscope had been in use for a half century or more. Its improvement and Bichat's work soon brought about a recognition of the cells of which the tissues are made. Schwann (1810-1882) and Schleiden (1804-1881) conjointly demonstrated that the cell is the essential unit of organization both in plants and animals. This was in 1838. As early as 1809, Lamarck anticipated this conclusion, but did not have the supporting mass of evidence possessed by Schwann and Schleiden. Cells in plants had been seen by the Englishman, Hooke, as early as 1665. Brown, also an Englishman, described the nucleus in 1833; but during this time no great importance was attached to the facts. In 1861, Max Schultze (1825-1874) was the first to make clear that it is the *protoplasm*, rather than the cell as such, that is fundamental.

From this time on the study of protoplasm and its minute structures, its chemistry, and activities,—*cytology*—has been one of the most attractive and profitable fields of research. The improvements in the microscope, in sectioning and staining cells, and the like, have made possible some of the most brilliant attacks on the mysteries of life. From these studies we have our knowledge of the nucleus, the chromosomes, the centro-

somes, the mitochondria as organized parts of the cell; we have learned of the texture and chemical qualities of protoplasm; we have discovered the complexities of nuclear division and the relation of cell structure and the behavior of the nuclear units to heredity. It is impossible in a brief statement such as this to discuss the whole list of brilliant investigators who have had a part in this. The German biologists have been peculiarly prolific in this work. The names of Nageli, von Mohl, Cohn; De Bary, Virchow, and many others should be mentioned. Boveri in 1900 first stated the law of the constancy of number of chromosomes in the cells of any one species. Our own Edmund B. Wilson of Columbia University has done as much as any zoologist to delimit what has been accomplished from what is yet to be done, and to stimulate the continual pushing forward of the boundaries of our knowledge of intimate cell structure and behavior. The last thirty years have been rich in American contribution in this department of Zoology.

518. **Physiology.**—Wm. Harvey (1578–1667), an Englishman, may be credited with the founding of physiology as an experimental science. His best known work was his demonstration of the circulation of the blood. Haller (1708–1777) studied physiology as independent of human anatomy and medicine, as a worthy science of its own. Johannes Müller (1801–1858) made a modern science of it. He brought to bear in its study the comparative method which was so fruitful in anatomy, and made use of the microscope and of physics and chemistry in its interpretation. His work has justly dominated the science until the present. Following Müller and continuing his work were Du Bois-Reymond (1818–1896), Claude Bernard (1813–1878), and Liebig, a master in physiological chemistry. Michael Foster of England and Verworn in Germany have done great work in the subject in recent times.

519. **Embryology.**—The beginnings of human thinking concerning the origin and development of animals was even more crude than in other realms of Zoology. Even Aristotle thought that frogs and many other animals arose spontaneously from mud, maggots from meat, and the like. Redi (1626–1697), an

Italian physician, showed experimentally that maggots arose from the eggs of flies. Harvey, to whom we have already referred, and Malpighi (1628-1694) an Italian histologist and one of the first to make much use of the microscope, were the pioneers of embryology. They studied chiefly the development of the chick and a few mammals. Harvey announced that all animals arose from eggs. Malpighi thought that parts of the embryo already existed in the egg in miniature. During the next hundred years this theory (known as the preformation theory) took strong hold on the imagination of the students of the subject, and the physiologists Haller, Bonnet, Leibnitz, etc., developed the idea that the miniature embryo, preformed in the egg, must in its turn contain the next generation also preformed in miniature, and this the next, and so on indefinitely. About 1677 it was discovered that the sperm united with the egg, and some believed that the miniatures were in the sperm rather than in the egg. Kaspar Wolff in 1759 attacked the whole preformation theory, and held the egg to be unorganized at first, with no trace of the future organs in it. He believed some vital principle organized the undifferentiated material into an embryo. Bitterly opposed at first, his general view came to dominate Embryology.

Von Baer (1792-1876) is recognized as the greatest of early embryologists. He adopted the comparative point of view in embryology, as Cuvier had for anatomy and Müller had for physiology and with equal fruitfulness. Von Baer discovered that all the higher types of animals develop first germ layers (*ectoderm*, *entoderm*, and *mesoderm*), and that the organs are formed by the growth and foldings of these.

The increasing knowledge of cell structure and behavior added greatly to progress in embryology. During these years it became clear that the egg and the sperm were single cells, that the fertilized ovum divides (*cleavage*) as ordinary cells do; that the descendants of these cells become different in the different layers, tissues, and organs, as they are formed. Gegenbauer, Koelliker, Huxley, Haeckel and many others made contributions at these points.

Building on the preceding work Francis Balfour (1851-1882)

of Cambridge, England, published in 1881 his monumental "Comparative Embryology." It made available the best conclusions of the past and developed general points of view that had only slightly or not at all appeared. Many great zoologists have given large attention to embryology since this time. In Germany, Fol, Oscar Hertwig, William His, Roux; and in America, Brooks, Minot, Mark, Whitman, Wilson, Loeb, and Morgan have made brilliant contributions to our knowledge. These include the study of the processes of fertilization and the behavior of the cellular elements therein; the nature of the chromosomes and their part in heredity; the effect of external agencies upon development; the origin of the special types of tissues; the continuity of the germ plasm and even of germ cells in the cycle of generations.

520. **Philosophy of Biology.**—In the early periods of human thinking the theories outran the facts. During all the time much of philosophy has accompanied the discoveries. So all the great names that have been mentioned have contributed something to our philosophy of Biology. Important as the field is we can here only mention a few salient steps. Some of them have already been suggested. The nature of some of them has been more completely discussed in Ch. XXVI. These problems include the origin and nature of living things, the causes that have operated to bring them to their present state, and the principles that seem to underlie the process.

It may be said that two main theories obtained among the ancients to explain life as we have it on the earth. One held that organisms were created supernaturally much as they are at present, closely suited to the environment in which they live. The other considered that in some way the present is a natural development from the past, and that organisms have grown into their various adjustments to external conditions. It is impossible to say how early this latter idea of evolution, so generally held at present, originated. We find evidences of it before Aristotle and still more in his writings.

Theoretically, the following views of life might be held:

1. That life has always been on the earth, and only life can give rise to life.

2. That at some time life appeared on the earth, from non-life,
  - a. Suddenly, much as it is at present.
  - b. Gradually, starting in simple form and becoming complex as at present.

Two fundamental questions are here: Did life start *de novo* at some time? Has it remained constant since it started? Another has arisen since: Can life start anew at present (*spontaneous generation*)?

John Ray about 1725 crystallized and gave formal support to the idea held by Linnæus and many of his predecessors that organisms arose *de novo*, by special creation, and since that time have remained practically constant. Cuvier also gave this view the support of his influence. Lamarck (1774-1829) contended that species were changeable, that the fossils in the strata were remains of extinct species which were the ancestors of the present ones. He held that the needs of the organism resulting in the use and disuse of organs, and the action of the environment upon the organism changed individuals and that these modifications were transmitted in some measure to the next generation. Thus he thought evolution occurred. He was the founder of the evolution theory in its modern sense and made an effort to put it on a rational basis.

Charles Darwin (1809-1882), accepting essentially Lamarck's views, added to them the principle of natural selection (§137) through the struggle for existence and the elimination of the unfit. This was his great contribution. It was so reasonable and he supported it with such an array of facts that it put the evolution idea on a firm footing and stimulated biological thought and investigation more perhaps than any other suggestion ever proposed. A. R. Wallace shares with Darwin the honor of discovering the idea of natural selection, although the latter's statement was theoretical rather than experimental.

With the work of Darwin the idea of the variability of species may be said to have been generally accepted by scientists. The questions now came to hinge upon the method of origin of the variations and their transmissibility to new generations.

August Weismann (1834-1915) held that body characters, gained as Lamarck suggested by use and disuse of the body,

could not be transmitted to the next generation. Only those changes which take place in the germ plasm could be inherited. He advanced the idea of a continuous germ plasm from which body after body arises in successive generations. Weismann held therefore that Lamarck's supposed factors could have nothing to do with evolution. Their influence stops with the body of the individual. He gave more value to natural selection than even Darwin. He emphasized also the union of two lines of germ plasm at fertilization as the principal source of variations.

Gregor Mendel (1822-1884) through his breeding experiments produced facts which strongly support Weismann's idea of continuity of germ plasm.

DeVries and Johanssen, living biologists, have strongly called in question Darwin's explanation by showing that the small fluctuations (*continuous variations*) of body which Darwin emphasized are not disposed to accumulate by selection. In other words the offspring of parents which show bodily fluctuations do not themselves vary about this new point as a mean. DeVries believes that only "mutations" (*discontinuous variations*) arising in the germ plasm are subject to inheritance. There is however probably no necessary conflict between the basic discoveries of Darwin, Weismann, Mendel, DeVries, Johanssen. When all the facts are known we shall probably find that all of them have found some truth, and that none of this is as potent as its discoverer imagined. For example, even if natural selection does not operate to accumulate fluctuations, it doubtless does preserve suitable mutations.

521. **Applications of Biology.**—From the earliest days when Biology was a mere appendage to medicine and of the act of living, it has been making continuous contributions to human welfare. It has given us more knowledge of the health and working of our own body; it has made possible the wonders of surgery; it has enabled us to master many of the contagious and infectious diseases of men and animals; it has taught us how to culture, breed, and select plants and animals for our uses, and to prepare their products to best advantage. A very large proportion of human industry depends directly upon Biology.

Some of the steps in the progress of medicine have been outlined heretofore. Many of the early biologists we have seen to be physicians.

Leeuwenhoek, one of the early users of the microscope, discovered bacteria in 1687. Soon after this it was first suggested that microscopic forms might have something to do with contagious diseases. In 1840, Heale took the position that all such diseases are caused by germs.

Louis Pasteur (1822-1895), a Frenchman, was one of the most remarkable scientists of all time. He discovered that fermentation is due to microscopic organisms (1857); established the actual connection between certain germs and the diseases produced by them; showed that germs could be made less harmful by being grown in certain conditions, and that these attenuated germs would produce only a mild form of the disease which would, however, give immunity just as fully as the severer forms. He succeeded in inoculating against fowl cholera, splenic fever of cattle, and finally against hydrophobia. In the institute which bears his name similar principles have been extended to bubonic plague, lockjaw, and other diseases. Here also was discovered the antitoxin for diphtheria. Robert Koch, born in 1843, is the Pasteur of Germany. He discovered and isolated the germ of tuberculosis (1881) and of Asiatic cholera (1883). Sir Joseph Lister the great English surgeon, born in 1827, using Pasteur's discoveries first applied *antiseptics* to wounds in order to destroy the germs that might enter. This was the foundation of *aseptic* surgery which undertakes so to sterilize everything brought near an operation that germs shall not enter at all.

One of the most interesting things to hold in mind about biological discoveries is this: it is impossible to tell how important to human welfare any discovery may prove to be. No one could have imagined that these students with the microscope studying the organisms of decomposition would be led gradually to the most profoundly important facts bearing on human life. It was not quite 200 years from the discovery of bacteria until Pasteur had discovered a way to overcome some of the diseases produced by them. Similar biological work done upon other



parasites, both micro-organisms and larger parasites, is gradually giving us mastery of yellow fever, syphilis, hookworm disease, and many others both of man himself and of the domestic animals.

Other fields in which the discoveries of the students of biology have been most valuable in practical life are: the breeding and improvement of our food and forage plants; the improvements of the domestic animals; the encouragement of wild food animals, as oysters and fish; the preservation of foods; conservation of forests; the holding in check the pests, largely insect, that often threaten to exterminate domestic plants and animals. In these fields great progress will continue,

With our increased knowledge of heredity and breeding, scientists are asking the question whether these principles which have done so much to improve the races of plants and animals may not be used to secure more rapid progress in man. Pearson, Bateson, Davenport and others claim perfectly soundly that many imperfections, such as imbecility, epilepsy, criminality, insanity, and other inheritable weaknesses, are bred back into the blood of the race every generation by unsound individuals. This process in our herds would produce *scrubs*. It is believed that the race owes itself the duty not merely to care for the individual after he is born, but to strive to see that every individual shall be as well born as possible. This science of human breeding is called *Eugenics*, and will doubtless have something important to do in answering the question as to the ultimate fate of the human race on the earth.

## CHAPTER XXIX

### EXERCISES IN COMPARATIVE PHYSIOLOGY, MORPHOLOGY, AND ECOLOGY

522. Now that the student has studied in some detail the work which even the simplest organisms must perform, the organs by means of which this necessary work is done in some of the principal types, and the relations which animals assume to each other and to the environment in general, it is desirable that he should bring these facts into such relations that they may be compared. The likenesses, the unlikenesses, and the progressive differentiation are thus brought into clear relief. The following outline exercises are intended to guide the student in this task. They are by no means exhaustive, but will suggest the principal points most essential to such a *resumé*. The laboratory notes, the textbook, and all the reference books at his command, should be used by the student. The student should be able to cite his authority for all important statements not his own, and, if possible, corroborate by reference to more than one authority. Tables with parallel columns such as those on pages 344 and 347 furnish an economical and otherwise satisfactory mode of displaying the results of these studies.

I. *Fundamental Form (Promorphology)*.—Indicate for each of the important phyla, or for chosen representatives of them, the following matters of general form: kind of symmetry represented and the perfection of its development; the degree and character of segmentation; the position, number, character, and arrangement of the appendages; the external and the internal evidences of cephalization; the relation of the principal organs of the animal to the horizontal and vertical planes.

II. *Physiology and Morphology*.—Compare the mode of performing the following functions and the organs used therein, in all the principal animal phyla.

1. The capture of food: the method; the organs devoted to it; and the relation of these to the nature of the food used.
2. Digestion; physical and chemical.

3. Circulation, as pertaining both to the nature of circulating fluid and to the organs moving it; the relation of the whole process to the organs and function of digestion and respiration in the types chosen.

4. Respiration: the medium containing the oxygen, and the contrivances for securing it.

5. Excretion: note and classify the chief modes of eliminating waste materials observed in the animal phyla.

6. The body cavity (coelom) in relation to digestion, circulation and excretion.

7. Physical support and protection (skeletal structures); their position, structure, and mode of formation.

8. Motion and locomotion: degree of each; relation of the muscular or contractile elements to the skeletal. The medium used in locomotion; the principal special devices in each group for the solution of the problems presented by the medium.

9. Sensitiveness: the kinds of stimuli to which the organisms in the various groups react; the differences in the different phyla in each of the various classes of sense organs, as to structure, position, and manner of action; the number, position and perfection of the nerve centres; and the relation of the nerve centres to the sense organs and to the muscles.

10. Reproduction. The various methods, and the special ends accomplished by each; rate; number of offspring; parental care; sex dimorphism; alternation of generation; parthenogenesis.

III. *Ecology and Adaptations to the Environment.*—Compare the animal groups from the following points of view.

1. General habitat: aquatic, fresh or salt water; terrestrial; aerial.

2. Migration or other special means of effecting distribution from the point of origin.

3. Degree of connection, organic or social, between the individuals of a species; gregarious, social and communal life; resulting social qualities; degree of division of labor; polymorphism.

4. Power of regenerating lost parts.

5. Growth; rate, and ultimate size; longevity. Special hindrances to growth.

6. Relation to human welfare: use as food; effects on crops and domestic animals; the production or dissemination of disease in man; capability of domestication; other qualities helpful or hurtful to human interests. Which phyla furnish species susceptible of domestication?

7. Diseases among animals other than man.

8. Coloration: pigments, internal and external; other modes of producing color; location of the color; supposed uses.

9. Principal methods of avoiding or surviving unfavorable periods, as cold, drouth, and the like.

10. Qualities of offense and defense.

11. Protective resemblance and mimicry. Other passive modes of protection.

12. Parasitism and the degree of degeneracy resulting from it. The more obvious effects upon the hosts.

IV. *Geographical Distribution*.—Select several representative species from each animal phylum and learn everything you can concerning their distribution on the earth. Are they local species or cosmopolitan species? What seems to be the reason for the fact? Are all the phyla cosmopolitan? Compare the animal phyla from the following points of view:

1. The facilities for migration. The special modes of migration, both active and passive.

2. What are the principal barriers to migration and distribution in the case of the representatives chosen for study?

3. Find instances of species of animals apparently closely related, with different geographical distribution. Compare, for example, the species of hares and rabbits found in North America; the species of lynx; of bears; of the alligators; species of *Unio*; of the lobster; of the genus *Equus*.

4. Make a local map of the region about your school on a large scale. Show all ponds, streams, lakes, marshes, meadows, uplands, forests, etc. Show by suitable symbols where various species of animals are to be found with reasonable certainty. Keep in a note-book belonging to the laboratory a memorandum of each new species found, and of a new locality for a known species. In time the map and the note-book will be a good account of the local distribution of species.

## APPENDIX

### LABORATORY SUGGESTIONS

#### 1. The Relation of the Descriptive Work to that of the Laboratory and Field.

—If time were of no consideration, it would perhaps be desirable for each student to get all his information concerning animals at first hand. Even under this most favorable assumption, however, his information would have a detached and unrelated quality which can only be corrected by lectures or textbook. This indicates the author's view of the purpose of the body of the text. It is to conserve the pupil's time and to unify his own necessarily scattered observations in such a way as to give them a vital and permanent interest. For this end the practical work in each phylum of animals should precede the descriptive and not be used merely to illustrate it. The textbook instruction and library references should have a much wider scope and fuller illustrative detail than is possible in the laboratory.

2. **The Nature of the Practical Work.**—Personally the author has little sympathy with the sentiment, so much in evidence in past years, that the most bizarre and superficially interesting phenomena are the ones most likely to lead to good educational results. These may be well enough in their place, but their best possible place when not abused is only to heighten interest in the more important relations and phenomena of animal life. The animal furnishes interesting and important facts in two essential relations: (1) the *internal*, in connection with which we are concerned equally with the fundamental structure and with its relation to the work to be done by the organism; and (2) the *external*, in which we are interested in this same work done by the parts of the organism, but in relation to the conditions on the outside of the animal. Physiology is thus the connecting link between morphology and ecology. The exercises of this book have been arranged in the main to lead the student to see *first* what the animal types do; *secondly*, the relation of this activity to the outside world; and *thirdly*, the more important structures by which this relation is maintained. The practical work should then be (1) physiological, which involves both the field and the laboratory; (2) ecological, chiefly in the field; and (3) morphological, chiefly in the laboratory. In each case, the student should be caused to take the attitude of answering questions, preferably of his own asking, rather than of verifying descriptions. *The laboratory outlines seek to raise questions rather than to supply answers, and to suggest topics of value rather than to exhaust the subject. The best possible outline is that which pupil and teacher construct together.*

3. **The Order of Work and the Time to be Given** (see table).—The author has arranged the matter in the book as it appears to him it should be presented if the various organisms were always available when needed, a condition which every teacher knows to be contrary to fact. Everything considered, the author thinks the best results may be had by beginning the year's work in the spring term and finishing it in the autumn term of the next year. No arrangement of courses

I. WHOLE YEAR: BEGINNING WITH SECOND (SPRING) TERM. II. WHOLE YEAR: BEGINNING WITH FIRST (AUTUMN) TERM.  
 III. ONE-HALF YEAR: AUTUMN TERM.

ORDER OF EXERCISES	HOURS OF PRACTICAL WORK	HOURS OF RECI-TATION	II ORDER OF EXERCISES	HOURS OF PRACTICAL WORK	HOURS OF RECI-TATION	ORDER OF EXERCISES	HOURS OF PRACTICAL WORK	HOURS OF RECI-TATION
General Part (Chs. 1 to 9).	8-12	20	Insects and Spiders (Ch. 17).	20		Protozoa.	2	1
Protozoa (Ch. 10).	4	2	Annulata (Ch. 15).	6		Arthropoda.	15	5
Porifera (Ch. 11).	2	1	General Part (Chs. 1 to 9).	10	20	Worms (Annulata).	2	2
Coelenterata (Ch. 12).	4-6	2	Protozoa (Ch. 10).	4	2	Mollusca.	3	2
Unsegmented worms (Ch. 13).	2	2	Porifera (Ch. 11).	2	1	General Part (Chs. 1 to 7).	5	10
Echinodermata (Ch. 14).	6-8	3	Coelenterata (Ch. 12).	4-6	2	Vertebrata (Chs. 19 to 24).	15	10
Annulata (Ch. 15).	6	3	Unsegmented worms (Ch. 13).	2	2	Echinodermata.	2	2
Mollusca (Ch. 16).	6-8	3	Echinodermata (Ch. 14).	7	3	Unsegmented worms.	1	2
Crayfish (Ch. 17).	10		Annulata: Text (Ch. 15).	6	3	Coelenterata.	2	2
Summer themes on life history and ecology of insects, to be reported and continued in the autumn.			Mollusca (Ch. 16).	10		Porifera.	1	1
Other Arthropoda (Ch. 17).	12	6	Crayfish (Ch. 17).	6	3	Parts of Ch. 25, in Review.		4
Fish and Frog (Ch. 19).	15		Arthropoda: Text (Ch. 17).	15	6	Or follow the order of the book.		
Text (Chs. 18 and 19).			Fish and Frog (Ch. 19).					
Fishes (Ch. 20).	1	6	Vertebrates: Text (Ch. 19).		6			
Amphibia (Ch. 21).	1	2	Fishes (Ch. 20).	1	1			
Reptilia (Ch. 22).	1	2	Amphibia (Ch. 21).	1	2			
Birds (Ch. 23).	5	4	Reptilia (Ch. 22).	2	2			
Mammals (Ch. 24).	5	4	Birds (Ch. 23).	5	2			
Chs. 25-29, in connection with Chs. 1-8 in review.		10-12	Mammals (Ch. 24).	5	4			
			Chs. 25-29, in connection with Chs. 1-8 in review.		10-12			

can be best for all, but the following tables may be suggestive as to the order of treatment, time to be devoted to various types, and the like. "Practical" is meant to include field work, laboratory work, demonstrations, and themes worked out in the library. A whole year's work is supposed to embrace not less than three class-room periods and two double laboratory periods a week for about thirty-six weeks. The author has purposely placed at the disposal of the teacher in this textbook about twice as much work as can be done well in the allotted time. The purpose of this is that each teacher may have the privilege of electing material most suited to the special circumstances, and yet have before him an ideal of what a thorough elementary course should cover.

For a course covering one-half year and given in the spring term the order would be about that of I and the time about as in III. In a course of one-half year the bulk of the matter in fine print should be omitted, or used in just such measure as time will permit. The marine forms, which the majority of schools will have to study from preserved materials, and the general part of the text (Chapters I to VIII) should be studied in the winter months when the local animals are least active. In connection with the review in Chapter XXIX, Chapters I to VIII should be reread by the student. Such a review will be especially helpful after the student has a larger body of zoological details at his command. Chapters XXV to XXVIII will strengthen the general impressions gained in the earlier parts.

**4. The Laboratory and its Equipment.**—(a) The laboratory or work room should be well lighted, and supplied with flat-topped tables; the plainer, the better. These should be 29 to 30 inches in height. If possible each student should have a drawer where he may keep his instruments and records. Sinks with running water are of course very desirable. Slop-jars of earthenware should be provided for refuse dissections, and the like.

(b) There should also be another room in which living animals may be kept. Very often a part of the basement with south exposure may be utilized for this purpose. The temperature should not fall to the freezing point, nor rise unduly when the furnace is heated. In such a room as this many animals may be kept much beyond the period when they disappear outside. Fruit jars, tumblers, shallow glass or crockery dishes, and, best of all, battery-jars of various sizes should be accumulated here. With a little ingenuity aquarium vessels of good size, with glass sides, may be made by means of good quality of pine boxes, putty, and panes of glass. A square may be taken from the middle of two opposite sides of such a box and the window inserted in such a way as to give good illumination of the interior. Running water is even more of a necessity here than in the laboratory. A few bell jars, wire gauze cages for insects, boxes of various kinds for other animals complete the list of the most essential features of a good working vivarium. It is always desirable to have some green water-plants in the vessels of water containing aquatic animals, *e.g.*, bladder-wort, watercress, duck weed, and spirogyra.

Each student should have access to a good compound microscope. It is possible for two students to work together with one instrument, but such a plan is never very satisfactory. At the outset the teacher should give careful instructions to the student in the use and care of the compound microscope. The laboratory should also supply dissecting pans of heavy tin, six or eight by twelve inches, with flaring sides, and one and one-half inches deep. Pour into these a small amount of melted paraffin mixed with lampblack. This forms an excellent

bottom for pinning specimens to be dissected. There should also be a bone cutter, a syringe with rubber tubing and glass canulas for injecting the blood vessels, a supply of small pipettes, a few pipettes with large bulb, and two or three flat-bottomed watch glasses for each student.

Each pupil should have, in addition, a good hand lens; a scalpel; a pair of fine-pointed scissors; a pair of forceps; a probe; dissecting needles; a small supply of glass slides and cover-glasses.

(d) *Reagents*.—The number of necessary reagents for a beginner's course is not large. The following are the most essential.

*Preserving Reagents. Alcohol*.—This is the most used of all reagents. It is a preserving fluid. It hardens organic matter by withdrawing the water from it. Commercial alcohol is usually of a strength of about 90 to 95 per cent. Specimens should first be placed in 50 per cent. alcohol and then in a day or two be transferred to a stronger grade (70 per cent.). After such treatment they may be preserved permanently in a strength of 70 to 80 per cent. Plenty of the preservative must be supplied, and care must be taken that it does not lose too much strength by evaporation. Animals must be opened, so that the fluid may the more quickly enter the cavities.

Alcohol may be secured free of the revenue tax by incorporated institutions, by application to the collector of internal revenue of the district in which the school is located. Application should be made several months before the alcohol is needed.

*Formalin* has been much used in recent years as a substitute for alcohol, or in combination with it, as a preservative. It is a 40 per cent. solution of formaldehyde in water, and be further reduced by adding water. A 10 per cent. solution of formalin is made by taking 10 parts of commercial formalin and adding 90 parts of water. This fluid will safely preserve materials through the term. The same care must be observed as with alcohol. The specimens should be washed in water before studying, as formol is irritating to the mucous membranes of nose, throat, and eyes.

*Killing Reagents*.—*Chloroform* is usually used as a stupefying reagent. Air-breathing animals exposed to its fumes are soon rendered unconscious, and die in a relaxed condition.

Minute water animals as Hydra, Dero, and the like, are often advantageously killed by sudden immersion in hot water or hot *corrosive sublimate* (saturated solution).

*Staining Reagents*.—A few stains are of advantage, if there is any attempt to study tissues or the Protozoa.

*Magenta* (aqueous solution). One part by weight of the dry magenta or fuchsin in 100 parts of water. Stains fresh tissues well, but is not a nuclear stain.

*Methyl green*; 1 per cent. aqueous solution. Add one part of acetic acid to 100 parts of this. The resulting fluid is a superior nuclear stain for elementary work.

*Mounting Reagents*.—Water, alcohol of different strengths, glycerine, and normal salt solution ( $\frac{3}{4}$  per cent. solution of common salt) are the more commonly used materials for temporary mounting of objects to be examined under the microscope. The normal salt solution is especially valuable for delicate fresh tissues, blood, and the like

The teacher, if inexperienced in technic, must consult works on microscopical methods for information about the making of permanent mounts.



Beside the materials mentioned above it is often desirable to have other substances,—as sugar, acids, salts, and some of the oils, as xyolol, benzol, and the like. These should be added gradually as their necessity and uses become apparent.

*Injection Masses.*—For the study of the veins and arteries and other tubular structures it is often desirable to inject into them foreign substances which prevent their collapse and render them easy of identification. For this purpose a syringe and some rubber tubing and small canulas are necessary. Injection masses to be satisfactory should be fluid when injected and be able to “set” or harden, after injection. For ordinary work the following will serve:

1. Starch injection mass:

Dry laundry starch.....	1 volume.
2½ per cent. aqueous solution chloral hydrate.....	1 volume.
95 per cent. alcohol.....	¼ volume.
Coloring mixture.....	¼ volume.

The coloring mixture is prepared by mixing equal parts of 95 per cent. alcohol, glycerine, and dry carmine (vermillion, chrome yellow or Prussian blue). The solid color should be ground into small portions of the fluids in a mortar so that no lumps will be present in the mass. This mixture does not spoil with age, but must always be well stirred before using and the injecting must be rapidly done, as the solids settle quickly.

2. *Gum or Gelatine Injection Masses.*—It is often desirable to have a mass which can be forced through the finer vessels, as the blood capillaries, so that the arteries and veins may both be filled by one injection into an artery near the heart. The following solution if injected warm will pass the capillaries. If the gelatine solution is first injected and then followed by a starch mass of a different color, the veins will ultimately contain the former and the arteries the latter, as the starch will not pass the capillaries, and thus both may be easily studied because of the contrast in color.

Gelatine solution (1 part gelatine to 6 or 8 of water).....	1 volume.
Glycerine carmine.....	⅓ volume.
Chloral hydrate (concentrated solution).....	
2 per cent., by weight, of the entire mass.	

The gelatine should be soaked in cold water and then slightly heated until dissolved. The glycerine carmine may be prepared as follows: thoroughly pulverize and mix 3 grams of carmine with a little water, with enough ammonia added to dissolve the carmine. Add 50 grams of glycerine. Mix and filter. Add gradually to this mixture enough acidulated glycerine (glycerine and acetic acid in the ratio of 10 to 1) to give a slight acid reaction to the carmine glycerine mass.

5. *Materials for Study.*—The types of animals needed for this course, with the exception of the marine representatives, may be secured in almost any locality, if sought at the proper time. The teacher should become entirely familiar with the common animals to be found within a reasonable distance from his school. It is especially necessary to know the life most abundant in the various ponds, lakes and streams. A close watch should be kept on the material gathered from each place, and a record kept of the various localities in which each useful type has

been found and of the best time for collection. In time the laboratory will come to have an interesting set of facts, valuable not merely in assisting in the finding of needed material, but as indicating local distribution (see also § 522; IV, 4). The students should be encouraged to make excursions, both with and without the teacher, to collect material and extend the knowledge of the locality.

If for any reason living materials cannot be secured in the locality of the school, preserved specimens of marine, fresh-water, and terrestrial species may be secured of dealers.

Supply department, Marine Biological Laboratory, Wood's Holl, Mass. (Preserved materials.)

The Anglers' Co., 913 W. Randolph St., Chicago, Ill. (Slides and laboratory materials.)

Mr. A. A. Sphung, North Judson, Indiana. Frogs, turtles, clams, and crayfish (living).

Ward's Natural Science Establishment, Rochester, N. Y. (Slides and demonstration preparations.)

Southern Biological Supply Co., Natural History Building, New Orleans, La. (Alligators, giant bull-frogs, and southern specialties.)

Powers and Powers, Station A, Lincoln, Nebr. (Living amoeba, fresh-water hydra; slides.)

General Biological Supply House, 1177 E. 55th St., Chicago, Ill. (Western Representatives of Woods Hole Biological Laboratory.)

Michigan Biological Supply Co., Nickels Arcade, Ann Arbor, Mich. (Slides; cultures of protozoa.)

Saint Louis Biological Laboratory, St. Louis, Mo. (Microscopic and lantern slides.)

Most of these dealers issue price lists which may be had on application.

Unless the instructor has the time and equipment to make satisfactory permanent mounts of microscopic preparations, he should secure a few, illustrative of cell structures, cell division, cleavage of ova; also sections of hydra, of the earth-worm, and preparations of some of the more important tissues of higher animals, as bone, nerve cells and fibres, epithelial tissue, glandular tissue and the like. Some of these may be purchased of the dealers in microscopical supplies. They may usually be secured at reasonable rates by writing to the biological departments of the large universities. Such preparations lend a great deal of interest as demonstrations in connection with the laboratory work.

**6. Laboratory Records.**—For making these the student should have a note-book of unruled drawing paper of good quality, which may be had in a tablet or kept as separate sheets in an appropriate envelope; and good drawing pencils, kept sharp, and of hardness suited to the paper. In the note-book the student should keep, concisely and in an orderly way, the record of all his observations, experiments, comparisons and conclusions. The notes may be kept on detached sheets similar to those used for the drawings, if desired.

*Outline* drawings and diagrams must be made of every structure or relation which can be shown by a well-labeled sketch. Shading should be sparingly used and only with a matured purpose, the result first being tested on a separate sheet of paper. The name of each portion of the sketch should be determined and named by running a leader from the part to an appropriate place for the name. The drawings are always to be made *in the laboratory and from the specimen studied.*

It is through the judicious criticism of the drawings that the teacher can best bring out the deficiencies in the student's observations. One teacher cannot do justice to a laboratory section of more than twelve or fifteen students. A good portion of the failure accredited in some quarters to the laboratory method is due to inefficient direction. The laboratory will no more run itself than will the class room.

The drawings, however, are by no means the most important part of the student's notes. It is more difficult and more valuable for a student to record his observations and conclusions in good, concise, exact English sentences than in drawings.

It is very desirable that students keep a field note-book, of size suitable for the pocket, in which all his own outdoor observations should be entered and dated. These notes may be put into fuller form in the reports called for in the body of the text. It is chiefly through the encouragement of such work as this that the teacher may hope to develop in his students a permanent interest in natural history, which will contribute materially to their satisfaction in later life. It is thus that men and women come to devote their lives to nature study.

**7. Library Helps.**—The library is quite as necessary to a balanced course of zoology as the textbook, the teacher, or the laboratory. First under this head may be considered *charts*. The teacher should become as expert as possible in making diagrams on the board before the eyes of the pupils. These may be supplemented by charts made by the teacher, or the pupils, by enlarging figures found in the textbooks. Such diagrams have a distinct advantage over the originals in that they may be discussed while in view of the whole class. It is excellent practice for the pupils to make copies of tables and figures for class use. For this purpose a good quality of light-colored wrapping paper will serve, if better drawing paper cannot be had. Keuffel and Esser (New York and Chicago) will send samples of drawing paper on application. The outlines should be made in water-colors with a suitable brush, in lines heavy enough to be clearly visible across the room. Colors may be put on with crayon and fixed by a spray of shellac.

Photographs and lantern slides are of value in illustrating the structure, development, and habits of animals. If the school can command a lantern or a heliopticon, a collection of lantern slides, selected in accordance with the special interests of the teacher and pupils, becomes a great stimulus in natural history work. If a large collection of books is impossible the brief lists below will assist the teacher in selecting the most helpful reference books for an elementary course. More extended bibliographical lists will be found in many of the books cited. A very good working collection of books may be secured for about \$150 to \$200.

In every written report demanding library work it is desirable to have the student record in his paper a list of all the references bearing on the subject. It is customary to arrange the authorities alphabetically, together with such other facts as are needed for ready reference. The following illustration will serve to indicate what facts should be recorded:

Parker and Haswell.

'21. A Textbook of Zoology. Vol. 1, pp. 580-583, illustrations.

In addition to the books listed below the teacher should endeavor to secure, through his representative in congress, the publications of the U. S. Department of Agriculture: the Yearbook, the Farmers' Bulletins, the bulletins of the Bureau

of Animal Industry and of the Division of Entomology. The Reports and Bulletin of the U. S. Fish Commission contain much valuable material. The publications of the state surveys and of the experiment stations of the various states are often of very high value to the teacher and are usually distributed gratuitously.

It will be helpful to make as large a collection as possible of the current elementary texts of zoology, and adopt the best suggestions of each.

### BIBLIOGRAPHY

#### I. GENERAL: ANATOMY, EMBRYOLOGY, PHYSIOLOGY, ECOLOGY, HABITS, ETC.

1. **Thompson, J. A.** Outlines of Zoology. Fifth edition. 1913. D. Appleton and Co., New York.
2. **Parker and Haswell.** Textbook of Zoology. 2 vols. 1921. The Macmillan Co., New York.
3. **Shull, A. F., LaRue, Geo. R. and Ruthven, A. G.** Principles of Animal Biology. First Edition, 4th Impression. 1920. McGraw-Hill Book Co., Inc., New York.
4. **Newman, H. H.** Vertebrate Zoology. 1920. Macmillan Co., New York.
5. **Kingsley, J. S.** Outlines of Comparative Anatomy of Vertebrates. Second Edition Revised. 1917. P. Blakiston's Son and Co., Philadelphia.
6. **Hertwig, R.** General Principles of Zoology. Translated by Field, 1896. Henry Holt and Co., New York.
7. **Hegner, R. W.** College Zoology. 1912. The Macmillan Co., N. Y.
8. **Jordan, D. S.** Animal Life. 1900. D. Appleton and Co., New York.
9. **Verworn, M.** General Physiology; An Outline of the Science of Life. Translation, 1899. The Macmillan Co., New York.
10. **Bayliss, W. M.** Principles of General Physiology. 1915. Longmans, Green and Co., New York.
11. **Howell, W. H.** A Text-book of Physiology. Seventh Edition. 1919. W. B. Saunders Co., Philadelphia.
12. **Abbott, J. F.** General Biology. 1914. The Macmillan Co., N. Y.
13. **Wilson, E. B.** The Cell in Development and Inheritance. Second Edition. 1900. The Macmillan Co., New York.
14. **Wallace, A. R.** Geographical Distribution of Animals. 2 vols. 1879. Harpers, New York.
15. **Ward, H. B. and Whipple, Geo. C.** Fresh Water Biology. First Edition. 1918. John Wiley and Sons, Inc., New York.
16. **Needham, J. G.** The Life of Inland Waters. 1916. The Comstock Publishing Co., Ithaca, N. Y.
17. **Shelford, Victor E.** Animal Communities in Temperate America. 1913. Univ. of Chicago Press, Chicago.
18. **Nelson, Edw. W.** Wild Animals of North America. 1918. Nat. Geog. Soc., Washington, D. C.
19. **Adams, Chas. C.** Guide to the Study of Animal Ecology. 1913. The Macmillan Co., New York.
20. **Morgan, T. H.** The Development of the Frog. 1897. The Macmillan Co., New York.
21. **Kellicott, Wm. E.** A Textbook of General Embryology. 1913. Henry Holt and Co., New York.

22. **MacBride, E. W.** Textbook of Embryology. Vol. I. Invertebrata. 1914. Macmillan Co., N. Y.
23. **Kellicott, Wm. S.** Outlines of Chordate Development. 1913. Henry Holt and Co., New York.
24. **Marshall and Hurst.** Practical Zoology. 1888. G. P. Putman's Sons, New York; Smith, Elder and Co., London.
25. **Hornaday, W. T.** Taxidermy and Zoological Collecting. 1897. Chas. Scribner's Sons, New York.
26. **Hegner, Robert W.** Practical Zoology. 1915. The Macmillan Co., N.Y.
27. **Morgan, C. L.** Habit and Instinct. 1896. Edward Arnold, New York.
28. **Poulton, E. B.** The Colors of Animals. (Int. Sci. Ser.) . 1890. D. Appleton and Co., New York.
29. **Wallace, A. R.** Tropical Nature. 1895. The Macmillan Co.
30. **Darwin, Chas.** The Variation of Animals and Plants under Domestication. 2 vols. 1875. D. Appleton and Co., New York.
31. **Le Conte, J.** Outline of the Comparative Physiology and Morphology of Animals. 1900. D. Appleton and Co., New York.
32. **Clark, C. H.** Practical Methods in Microscopy. 1896. D. C. Heath and Co., Boston.
33. **Lee, A. B.** The Microtometist's Vade-Mecum. Eighth Edition Edited by J. Bronté Gatenby. 1921. P. Blakiston's Son and Co., Philadelphia.
34. **Agar, W. E.** Cytology. 1920. Macmillan and Co., New York.
35. **Doncaster, Leonard.** An Introduction to the Study of Cytology. 1920. Cambridge University Press, London.
36. **Beddard, F. E.** A Textbook of Zoogeography. 1895. Cambridge (Eng.) Univ. Press.
37. **Calkins, G. N.** Biology. 1914. Henry Holt and Co., New York.
38. **Van Beneden, F.** Animal Parasites and Messmates. 1876. D. Appleton and Co., New York.
39. **Chandler, A. C.** Animal Parasites and Human Disease. 1918. John Wiley and Sons, New York.
40. **Parker, G. H.** The Elementary Nervous System. 1919. J. B. Lippincott Co., Philadelphia.
41. **Lillie, F. R.** Problems of Fertilization. 1919. University of Chicago Press, Chicago.
42. **Loeb, J.** Forced Movements, Tropisms and Animal Conduct. 1918. J. B. Lippincott Co., Philadelphia.
43. **Morgan, T. H.** Heredity and Sex. 1914. Columbia University Press, N. Y.
44. **Davenport, C. B.** Heredity in Relation to Eugenics. Henry Holt and Co., N. Y.
45. **Locy, Wm. A.** Biology and its Makers. 1908. Henry Holt and Co., N. Y.
46. **Hegner, R. W.** The Germ-cell Cycle in Animals. 1914. The Macmillan Co., N. Y.
47. **Jennings, H. S.** Life and Death, Heredity and Evolution in Unicellular Organisms. 1920. Richard G. Badger, The Gorham Press, Boston.
48. **Morgan, T. H.** A Critique of the Theory of Evolution. 1919. Princeton University Press, Princeton.
49. **Morgan, T. H.** The Physical Basis of Heredity. 1919. Lippincott and Co., Philadelphia.
50. **Doncaster, L.** The Determination of Sex. 1914. Cambridge University Press, London.

51. **Lull, R. S.** Organic Evolution. 1917. Macmillan Co., New York.
52. **Conklin, E. G.** Heredity and Environment in the Development of Man. 1915. Princeton University Press, Princeton.
53. **Babcock, E. R. and Clausen, R. E.** Genetics in Relation to Agriculture. 1918. McGraw-Hill Book Co., New York.
54. **Riverside Natural History:** J. S. Kingsley, Editor. 6 vols. Houghton, Mifflin and Co., Boston.

II. SPECIAL: BOOKS TREATING THE STRUCTURE AND CLASSIFICATION OF THE MORE IMPORTANT GROUPS OF ANIMALS

1. **Chapman, F. M.** Bird Life. A Guide to the Study of Our Common Birds. 1897. D. Appleton and Co., New York.
2. **Chapman, F. M.** Hand-book of Birds of Eastern North America. 1916. D. Appleton and Co., New York. Revised Ed.
3. **Jordan, David Starr.** A Guide to the Study of Fishes, Vols. 1 and 2. 1905. Henry Holt and Co., New York.
4. **Forbes, Stephen A. and Richardson, R. E.** The Fishes of Illinois. Second Edition. 1920. St. of Illinois Dept. of Registration and Education, Div. of Nat. Hist. Survey.
5. **Comstock, J. H.** Manual for the Study of Insects. 1895. Comstock Publishing Co., Ithaca, New York.
6. **Folsom, J. W.** Entomology: with special reference to its Biological and Economic Aspects. Second Edition. 1913. P. Blakiston's Son and Co., Philadelphia.
7. **Comstock, J. H.** An Introduction to Entomology. Second Edition. 1920. The Comstock Publishing Co., Ithaca, N. Y.
8. **Fernald, H. T.** Applied Entomology. First Edition. 1921. McGraw-Hill Book Co., New York.
9. **Pierce, W. D.** Sanitary Entomology. 1921. Richard G. Badger, The Gorham Press, Boston.
10. **Herms, Wm. B.** Medical and Veterinary Entomology. 1915. The Macmillan Co., New York.
11. **Riley, Wm. A. and Johannsen, O. A.** Handbook of Medical Entomology. 1915. The Comstock Publishing Co., Ithaca, N. Y.
12. **Lubbock, J.** Ants, Bees and Wasps. Int. Sci. Series. 1882. D. Appleton and Co., New York.
13. **Emerton, J. H.** Common Spiders. 1902. Ginn and Co., Boston, Mass.
14. **Herrick, F. H.** Natural History of the American Lobster. 1911. Bulletin United States Fish Commission, Vol. XXIX, for 1909.
15. **Calkins, Gary N.** The Protozoa. 1901. The Macmillan Co., New York.
16. **Howard, L. O.** Mosquitos. 1901. McClure, Phillips and Co., New York.
17. **Cowan, T. W.** Natural History of the Honey Bee. 1890. Houston, London.
18. **Holland, W. J.** The Butterfly Book. 1899. Doubleday and McClure Co., New York.
19. **Holland, W. J.** The Moth Book. 1904. Doubleday and McClure Co., New York.

20. Comstock, J. H. *The Spider Book*. 1912. Doubleday Page and Co., New York.
21. Sanderson, E. D. *Insect Pests of Farm, Orchard, and Garden*. 1912. John Wiley and Son, N. Y.

8. **Collections.**—While the educative value of a miscellaneous assortment of the curios so often brought to teachers is not great, a permanent collection of the typical animals of the locality may be so arranged as to be of considerable value for comparison. There should be added to these gradually, by purchase or otherwise, representatives of those classes of animals not represented in the local fauna in order to give the collection more of a synoptic value. Such a collection of types from the more important classes of animals serves an important end in giving the student a general idea of the animal kingdom as a whole, which is difficult to gain in any other way. The building up of a laboratory museum with the help of the students may be made to serve as an incentive to care and neatness on their part in making dissections or other preparations which may bear the name of the student on the labels, when permanently installed in the collection.

It is decidedly valuable to encourage students in the special study of some limited group of animals, and this may frequently be accomplished by the beginnings of a collection of the local species of the group. The permanent interest and enthusiasm on the part of the pupil in the study of the phenomena of living things may be taken as the measure of success in teaching the natural history sciences. This can be secured more readily by studying life in its natural surroundings than by dissections.





# INDEX

[The names of the *genera* cited are printed in italics. The numerals refer to pages. Those in bold-faced type indicate that the object is illustrated on that page].

- Absorption, 67  
Abyssal fauna, 137  
Acalephs, 246  
Acanthocephala, 204  
Acclimatization, 13, 107  
Achromatin, 21, 27  
Acquired characters, 101, 104  
Actinozoa, 186  
Adaptation, means of, 107; types of, 113; to inorganic environment, 114; to mates, 116; to offspring, 117; social, 122; competitive, 123; commensal, 124; symbiotic, 124; to preying, 127; for protection, 127  
Adaptive habits and instincts, 134  
Adipose tissue, 56  
Adrenals, 342  
*Aepyornis*, 413  
Aerial fauna, 138  
Age of man, 475  
Air-sacs (birds), 405  
*Aix*, 413  
Albatross, 415  
Alimentary canal (see digestive system).  
Allantois, 392, 409  
*Alligator*, 397  
Alternation of generation—in Cœlenterates, 179; in worms, 192, 197  
Ambulacral system, 214  
Amitotic cell division, 24  
Ammonites, 263  
Amnion, 392, 409  
*Amœba*, 15, 23, 93, 150  
Amphibians, 146, 376  
*Amphioxus*, 313, 314  
*Amphitrite*, 237  
*Amphiura*, 381  
Ampullæ, 215  
Anabolism, 67  
Anacanthini, 374  
Analogy, 85  
Anaphase, 25  
Anatomy, 3, 521  
Animalcules (see protozoa).  
Animal industries, 508  
Annelida, 148, 223, 237  
*Anodonta*, 239, 259  
Anseres, 416  
Ant-eater, 452  
Antenna, 268  
Antennule, 270  
Antero-posterior (see symmetry).  
Antimeres, 97  
Ants, 123, 307  
Aorta, 339 (see circulatory system).  
Apes, 460  
*Aphis* (plant lice), 300  
Apoda, 384  
Appendages—arrangement of, 97; in arthropods, 277; in vertebrates, 325; in fishes, 360; in amphibians, 377; in birds, 402  
Appendicular skeleton, 331, 333  
Appendix, 446  
Applications of zoology, 508  
Aptera, 298  
*Apteryx*, 407, 411  
Aquatic fauna, 137  
Arachnida, 307  
Araneida, 308  
*Arbacia*, 210  
*Archæopteryx*, 410  
Archenteron, 38, 41  
Archipterygium, 361  
*Argonauta*, 264  
Aristotle's lantern, 211  
Armadillo, 452  
Army-worm, 405  
Arterial arches, 339

- Arteries, 72 (see circulatory system).  
 Arthropoda, 147, 266  
 Artificial selection, 106  
 Artiodactyla, 454  
*Ascaris*, 200  
 Ascidians, 313  
*Asellus*, 270  
 Ass, 455  
 Assimilation, 13 (see metabolism).  
*Asterias*, 208  
 Asteroidea, 221  
*Astragalinus*, 427  
 Astroid-stage, 24 (cell-division).  
 Asymmetry, 93, 372  
 Atrial pore, 314  
 Atrium, 314  
 Auditory nerve, 353  
 Auditory organs, 82, 282, 355  
 Auk, 414  
*Aurelia*, 186  
*Autolytus*, 230, 231  
 Automatism, 12  
 Aves, 399, 411  
 Axiality, 92, 94  
 Axial skeleton, 329  
 Axon, 62
- Baboons, 460  
*Balanoglossus*, 312, 313  
 Barbs (see feather).  
 Barbules (see feather).  
 Barnacles, 293  
 Bass (sea), 372  
 Bats, 458  
 Bears, 455  
 Beaver, 458  
 Bees, 123, 307  
 Beetles, 305  
 Behavior (see sense organs, and sensation).  
 Bibliography, 540  
 Bilateral symmetry, 96, 98  
 Binomial nomenclature, 520  
 Biogenetic law, 490  
 Bird lice, 300  
 Birds, 144  
 Bittern, 416  
 Bivalent chromosomes, 33, 34, 36  
 Bivium, 213  
 Blastoidea, 220  
 Blastomeres, 37  
 Blastopore, 38, 40  
 Blastula, 38, 40  
 Blood, 58  
 Boat-shell, 261  
 Body-cavity (see coelom).  
 Bojanus, organ of (= kidney of clam).  
*Bonasa*, 418  
 Bone, 57  
 Bony-fishes, 373  
 Book-lungs, 282  
 Bot-fly, 301  
 Brachiopoda, 204  
 Brain: orang, 468; Hottentot, 469;  
     Gauss, 469  
 Brain (vertebrate), 348, 349  
 Branchiæ, 70  
 Branchial arches, 340-342 (see circulatory system).  
 Bronchi, 447  
 Branchiostoma, 313, 314  
 Brook trout, 369  
 Bryozoa (see polyzoa, 203).  
 Buccal cavity, 334  
 Bugs, 300  
*Bubo*, 421, 422  
*Bufo*, 382  
*Butorides*, 415  
 Butterflies, 303
- Cabbage butterfly, 304  
 Cabbage worm, 304  
 Cæcum, 446  
*Cambarus*, 266  
 Camel, 454  
 Camera eye, 83, 358  
 Campanularia, 186  
*Campodea*, 299  
 Canine teeth, 444  
 Canker-worm, 305  
 Capillaries, 72, 340  
*Caprella*, 297  
 Carapace—in crustacea, 283; turtles, 393  
 Carbohydrates, 11  
 Cardinal veins, 365 (see circulatory system).  
*Cardium*, 259  
 Carinatae, 413  
 Carnivora, 451, 455  
 Carpels, 333

- Cartilage, 55, 56  
 Cat, 455  
 Caudal vertebræ, 331  
 Caudata, 484  
 Cell, 19  
   form, 19; size, 20; structure, 20;  
   wall, 21; functions, 22; reproduction  
   23; division, 23  
 Centipede, 297  
 Central nervous system, 78, 348  
*Centropristis*, 372  
 Centrosome (centrosphere), 26  
 Centrum (see vertebræ), 329  
 Cephalopoda, 263  
 Cephalo-thorax, 279  
*Ceratodus*, 375  
 Cercaria, 197  
 Cerebellum, 348, 351  
 Cerebrum, 349, 351  
 Cervical vertebræ, 330  
*Ceryle*, 424  
 Cestodes, 199  
 Cetacea, 453  
 Chætogonatha, 204, 239  
 Chætopoda, 237  
 Chameleon, 394  
 Cheiroptera, 451, 458  
 Chelonia, 393  
 Chemical sense, 81, 354 (see taste and  
   smell).  
 Chicken, 417; breeds of, 435  
 Chimney-swifts, 430  
*Chlamydomyxa*, 22  
 Chondrostei, 373  
 Chordata, 312 (see vertebrata).  
 Chorion, 409, 449  
 Chromatin, 21, 27  
 Chromosomes, 24  
*Cicada*, 300  
 Cilia, 22, 50, 149  
 Circulation, 67, 71  
 Circulatory organs, 71; in Echino-  
   oderms, 216; in annulata, 231; in  
   mollusks, 251; in arthropods, 284;  
   in vertebrates, 338, 344; in fishes,  
   365, 366; in amphibia, 341, 379; in  
   reptiles, 341, 389; in birds, 342; in  
   mammals, 342, 446  
*Cirphis*, 305  
*Cirratulus*, 238  
 Cirripedia, 294  
 Clam, 240, 257  
 Clamatores, 430  
 Classification, 486  
 Classification—defined, 5; use, 109;  
   illustration of, 111  
 Classification—protozoa, 162; porifera,  
   172; cœlenterata, 185; unsegmented  
   worms, 196; annulata, 237; mollusca,  
   258; arthropoda, 293; vertebrata,  
   358; fishes, 373; amphibia, 384;  
   reptiles 393; birds, 411; mammals,  
   450  
 Cleavage, 36, 37, 38  
 Clitellum, 224  
 Cloaca, 168, 337, 407  
 Clothes-moth, 305  
 Clothing from animals, 509  
 Clypeus, 273  
*Coccyzus*, 425  
 Cockroaches, 298  
 Cocoon, 289  
 Cœlenterata, 148, 174  
 Cœlom (defined), 41; in unsegmented  
   worms, 192; echinoderms, 214; an-  
   nulata, 230; arthropods, 278; verte-  
   brates, 334  
 Cœlomata and cœlenterata, 148  
 Coil stage (cell-division), 24, 25  
 Coleoptera, 305  
 Colloid, 12  
 Colonies—organic, 120; voluntary, 122  
 Color, 127, 371  
*Colpoda*, 20  
 Columbæ, 424  
 Commensalism, 124  
 Compound eye, 84, 286  
 Condyle, 388, 401  
 Conjugation, 75, 15  
 Congo-snake, 384, 385  
 Connective tissue, 54–59  
 Contractility, 15 (see motion).  
 Contributors to zoology, 509  
 Convulsions (brain), 447, 469  
 Coördination, 77  
 Corallines, 203  
 Corallum, 183  
 Corals, 186  
 Corpuscles (blood), 58  
 Corrodentia, 299

- Cortex (of brain), 447  
 Corvidæ, 431  
 Cotton-boll worm, 305  
 Coverts (see feather).  
 Coxa, 273  
 Crab, 290; larvæ, 288, 289  
 Crane, 418  
 Cranial nerves, 353  
 Crayfish, 266, 294  
*Crepidula*, 261  
 Crickets, 298  
 Crinoidea, 220  
 Crocodiles, 397  
 Crop, 335  
 Crossopterygii, 373  
*Crotalus*, 388  
 Crows, 426  
 Crustacea, 293  
 Ctenophora, 186  
 Cuckoo, 425  
 Cursorres, 412  
*Cyclos*, 259  
*Cyclops*, 270, 293  
 Cyclostomes, 314  
 Cyst, 159  
 Cystoidea, 220  
 Cytology, 522  
 Cytoplasm, 20, 27  
  
 Damsel flies, 299  
*Daphnia*, 293  
 Decapoda, 264  
 Deer, 454  
 Degeneration, 132  
 Dendron, 62  
 Dental formula, 444  
 Dentine, 51, 444 (teeth).  
 Dermaptera, 300  
 Dermis, 327 (see integument).  
 Dermo-muscular sac, 229  
*Dero*, 225, 227  
*Derotremata*, 384  
 Development (see metamorphosis)—  
   porifera, 171; cœlenterata, 184; un-  
   segmented worms, 192, 197; echino-  
   derms, 219; annulata, 234; mollusks,  
   254; arthropods, 287; vertebrates,  
   346, 347; fishes, 370; amphibians,  
   380; reptiles, 391; birds, 408; mam-  
   mals, 448  
  
 Development of zoology, 518  
 Devil-fish, 263  
 Diastroid stage, 24, 25  
 Dibranchiata, 263  
 Didelphia, 451  
*Didelphys*, 117  
 Differentiation of tissues and organs,  
   29, 41, 48, 85  
 Digestion, 67, 68  
 Digestive system—protozoa, 155;  
   sponges, 170; cœlenterata, 181; echi-  
   noderms, 213; annulata, 230; mol-  
   lusks, 249, arthropoda, 281; verte-  
   brates, 332, 392; birds, 405; mam-  
   mals, 444; ruminants, 445  
 Digestive tract, regions, 334  
 Dimorphism (sexual), 76  
 Dinosaurs, 386, 487  
*Diphylobothrium*, 205, 206  
 Dipnoi, 374  
*Dipodomys*, 456  
 Diptera, 301  
 Direct cell-division, 23  
 Discophora, 239 (leeches).  
 Dispersal of animals, 136  
 Dissimilation, 16 (katabolism).  
 Distribution, geographical, 4, 138  
 Division (cell), 23, 25  
 Division of labor, 29, 66  
 Dogs, 455  
 Domestication of animals, 106, 514  
 Dominance, 500  
 Dorsal vertebræ, 330  
 Dorso-ventral axis (see symmetry).  
 Dove, 424  
*Draco*, 395  
 Dragon flies, 299  
 Duck-bill, 440  
 Ducks, 413  
 Ductless glands, 341  
 Ductus Cuvieri, 365  
 Dugong, 453  
  
 Eagle, 420  
 Ear, 355 (see auditory organs).  
 Earthworm, 223  
 Earwigs, 300  
*Echidna*, 450  
 Echinodermata, 147, 208  
 Echinoidea, 221

- Echinus*, 210
- Ecology—defined, 4 (see also adaptation); of protozoa, 162; porifera, 172; coelenterata, 186; unsegmented worms, 204; echinoderms, 220; annulata, 235; mollusks, 255; arthropods, 290; fishes, 367, 371; amphibia, 380; reptiles, 392; birds, 423; mammals, 460
- Economic zoology, 508
- Ectoderm, 38, 40
- Ectosarc, 153
- Edentata, 451, 452
- Education, 473
- Egg, 30
- Elasmobranchii, 373
- Electric organs, 371
- Elephant, 455
- Elytra, 305
- Embryology, 488
- Embryology, defined, 4 (see development), history of, 523
- Emu, 412
- Enamel, 51 (see teeth), 443
- Endopodite, 268
- Endosarc, 153
- Endoskeleton, 73, 328, 404 (see also skeleton).
- Endothelium, 53
- Ensis*, 258
- Entoderm, 38, 40
- Entomostraca, 293
- Environment, 100, 103, 114, 505
- Epeira*, 309
- Ephemera, 299
- Epiblast (see ectoderm).
- Epicranium, 273
- Epidermis (see integument), 326
- Epinephelus*, 374
- Epithelial tissue, 49-53
- Equilibrium sense, 82, 355
- Erethizon*, 457
- Ethnography, 475
- Eugenics, 519
- Euglena*, 154, 158
- Eutheria, 440
- Euthyneura, 261
- Eustachian tube, 355
- Evolution,—meaning, 482; evidences, 483; course of, 491; factors in, 492
- Excretion, 17, 67, 72
- Excretory systems—coelenterates, 183; unsegmented worms, 194, 195; echinoderms, 217; annulata, 232; mollusks, 252; arthropods, 284; vertebrates, 345
- Exopodite, 268
- Exoskeleton, 73, 325 (see also integument).
- Eyes, 83, 286, 356; median, 390
- Eye-spots, coelenterata, 184; annelida, 233
- Facial nerve, 353
- False amnion, 410
- Fasciola* (Distomum), 196, 197
- Fat cells, 56
- Fats, 11
- Faunas, type of, 137
- Feathers, 400, 403
- Femur, 333
- Ferments, 10
- Fertilization, 36, 42, 75
- Fibrillæ (muscle), 60
- Fibrous connective tissue, 55, 56
- Fin, 361
- Finches, 421
- Fishes, 146, 316, 359
- Fish Commission, work of, 369
- Fission, 192, 195
- Flame-cell, 193, 195
- Flamingo, 416
- Flat-worms (see platyhelminthes, 193).
- Fleas, 301
- Flies, 301
- Fœtal membranes (see amnion and allantois).
- Fluctuations, 104, 495
- Food value of animals, 508
- Foraminifera, 162
- Formative pole, 37
- Fox, 455-458
- Fringillidæ, 431
- Frog, 319, 382
- Frontal section, 92
- Fruit-borers, 305
- Functions (basal), 66
- Fur (see hair).
- Galea, 274
- Gallinæ, 422

- Galls, 117, 118  
*Gallus*, 424  
 Gamete, 159  
*Gammarus*, 296  
 Ganglion, 62, 348  
 Gar-pike, 373  
 Gasteropoda, 261  
*Gastrophilus*, 301, 302  
 Gastro-vascular cavity, 178, 181  
 Gastrula, 38, 39  
 Gavials, 397  
 Geese, 416  
 Gelatinous tissue, 55  
 Genæ, 273  
 Genus, 111  
 Germinal layers, 40  
 Germinative epithelium, 345  
 General characters—protozoa, 153; porifera, 166; cœlenterata, 177; unsegmented worms, 191; echinoderms, 211; annulata, 276; mollusks, 245; arthropods, 278; chordata, 311; vertebrates, 324; fishes, 359; amphibia, 376; reptiles, 386; birds, 401; mammals, 439.  
 General survey—protozoa, 152; porifera, 166, 168; cœlenterata, 179; echinoderms, 212; unsegmented worms, 191; annulata, 226; mollusks, 244; arthropods, 277; vertebrates, ch. XIX; fishes, 360; amphibia, 376; reptiles, 386; birds, 402; mammals, 440  
 Geographical distribution, 484  
 Gephyrea, 204  
 Germ cell cycle, 33, 34, 42  
 Germ plasm, 496  
 Gila-monster, 394  
 Gill-arches, 337  
 Gills, 70, 337  
 Girdles, 331, 333  
 Gizzard, 281, 336, 405  
 Glands, 51, 53; in mammalia, 442  
 Glass-snake, 394  
 Glosso-pharyngeal nerve, 353  
 Glottis, 338  
 Gnats, 301  
 Goblet cells, 50  
 Goldfinch, 427  
 Gonads, 184 (see ovary and testis).  
 Grallatores, 412  
*Grantia*, 165  
 Grasshopper, 271, 298  
 Green gland, 284  
 Grouse, 418, 422  
 Growth, 14, 74  
 Guinea-fowl, 417  
 Gulls, 414, 415  
 Gymnophiona, 384  
 Habits and habitats (see ecology), 134, 460  
 Hæmocele, 280  
 Hæmoglobin, 338  
 Hair, 441, 442  
 Hair-follicle, 327  
 Hares, 458  
 Harmful animals, 513  
 Harvest-men 310  
 Hawks, 420  
 Haversian canal, 57  
 Hearing, 82 (see ear).  
 Heart, 339 (see circulatory system).  
 Hedge-hog, 447  
*Helix*, 247, 262  
*Heloderma*, 395  
*Helodrilus*, 223  
 Hemiptera, 300  
 Hepatic portal circulation, 365  
 Heredity, 100, 496; carriers of, 102  
 Hermaphroditism, 75, 233  
 Hermaphrodite organs—tapeworm, 199; snail, 253  
 Hermit crab, 125, 187  
 Heron, 415  
 Hessian fly, 302  
 Heterocercal tail, 362  
 Heteromya, 260  
 Hexapoda, 298  
 Hippopotamus, 443  
 Historical—general, 6; protozoa, 160; of zoology, 518  
 Histology—defined, 4  
 Hog, 454  
 Holostei, 373  
 Holothuroidea, 221  
*Homarus*, 294  
 Homocercal tail, 363  
 Homology, 85  
 Hookworm, 201

- Horned-toad, 394  
 Hornbill, 429  
 Horse, 454  
 Human evolution, 476, 506  
 Humming-bird, 430  
 Hybrid, 111  
*Hydra*, 174, 178  
*Hydractina*, 187  
 Hydroid type, 179  
 Hydrozoa, 186  
*Hylocichla*, 428  
 Hymenoptera, 306  
 Hypoblast (see entoderm).
- Ichneumon fly, 307  
 Icteridæ, 431  
 Imago, 289  
 Incisor teeth, 443  
 Individual, 100  
 Infusoria, 162  
 Ingestion of food, 67  
 Injurious animals, 513  
 Insectivora, 452  
 Insects, 298  
 Instincts, 134, 470  
 Integument (see skin)—annulata, 229;  
   echinoderms, 213; mollusks, 243, 247;  
   arthropods, 280; vertebrates, 326;  
   fish, 363; amphibians, 377; reptiles,  
   387; birds, 402; mammals, 442  
 Intercellular substance, 49  
 Intestine, 336 (see digestive system).  
 Invagination, 39  
 Irritability, 12, 77 (see sensation).  
 Isolation, 495  
 Isoptera, 299
- Jackals, 455  
 Jelly-fish, 179 (see medusa).  
 Jugular vein, 365
- Katabolism, 16, 67  
 Katydid, 298, 300  
 Keeled birds, 413  
 Kidney, 72, 345 (see nephridia).  
 King crab, 307  
 Kingfisher, 424
- Laboratory exercises—protozoa, 150;  
   porifera, 165; cœlenterata, 174; un-  
   segmented worms, 192; echinoderms,  
   208; annulata, 223; mollusks, 240;  
   arthropods, 266; chordata, 316; fish,  
   316; amphibian, 319; reptile, 385;  
   birds, 399; mammals, 438  
 Labium, 274  
 Labrum, 273  
 Lacertilia, 393  
 Lacinia, 274  
 Lacteals, 447  
 Lacunæ—bone, 57; blood, 284<sup>1</sup>  
 Ladybird (ladybug) beetle, 305  
 Lamella (bone), 57  
 Lamellibranchiata, 258  
 Lamprey, 127, 312  
*Lampropeltis*, 396  
 Lancelet, 313, 314  
*Lanius*, 430  
 Lark, 429  
 Larynx, 338  
 Leech, 226-239  
 Leopard, 455  
 Lemurs, 460  
 Lepidoptera, 303  
*Lepidosiren*, 375  
*Lepomis*, 393  
 Lice, 300  
 Life cycle, 42  
 Life—nature of, 8; relation to pro-  
   toplasm, 19  
*Limax*, 262  
 Limbs, bones of, 333  
 Limicolæ, 418  
*Limnæa* (host of liver fluke, 196), 243  
 Limpet, 261  
*Limulus*, 307  
 Lion, 455  
 Littoral fauna, 137  
*Littorina*, 261  
 Liver-fluke, 196, 197  
 Lizards, 394  
 Lobster, 294, 295  
 Locomotion, 76  
 Locomotor organ—protozoa, 155;  
   porifera, 170; cœlenterata, 183; echi-  
   noderms, 214; annulata, 229; mol-  
   lusks, 248; arthropods, 281; fishes,  
   360-364, amphibia, 379; reptiles,  
   387; birds, 402; mammals, 431
- Labor-saving animals, 510

- Locust-borers, 305  
 Locusts, 298  
 Longipennes, 415  
 Lophobranchii, 376  
 Lophophore, 203  
 Lumbar vertebræ, 328  
*Lumbricus*, 223  
 Lung-fishes, 374  
 Lungs, 70, 336  
 Lymph, 59  
 Lymphatics, 446
- Macromere, 234, 255  
 Madreporic body, 215  
 Malacostraca, 294  
 Malaria, 163  
 Mallophaga, 300  
 Malpighian tubule, 282  
 Mammals, 144  
 Mammary glands, 442  
 Mammoth, 455  
 Man, 460, ch. XXV  
 Man, 466; differences from animals, 466-470; mental life, 470; social instincts, 472; education of, 473; relation to nature, 474; age on earth, 475; types of, 475; future of, 476  
*Mamatee*, 453  
 Mandible, 264, 274  
 Mantle, 248  
 Marsupials, 441, 440, 451  
 Marsupium, 440, 449  
 Marten, 455  
*Mastodon*, 455  
 Maturation (of ovum), 32, 33, 34  
 Maxilla, 268, 274  
 Maxillary palpus, 274  
 Maxillipeds, 268  
 May-flies, 299  
 Meantes, 484  
 Medical uses of animals, 511  
 Medulla oblongata, 349, 351  
 Medullary sheath (nerve), 61, 62  
 Medusa-type, 179  
 Megalops, 289  
 Mendel's experiments, 497  
 Mendel's laws, 499  
 Mental life of man, 470  
 Mesenchyma (mesogloea), 167  
 Mesenteron, 68, 332  
 Mesentery, 321  
 Mesoblast (see mesoderm), 234  
 Mesoderm, 40, 41  
 Mesothorax, 273  
 Mesozoa, 204  
 Metabolism, 67  
 Metamere, 97  
 Metamorphosis—worms, 196, 197; echinoderms, 219; arthropods, 288 amphibia; 380, 381  
 Metaphase, 24  
 Metapleure, 314  
 Metathorax, 273  
 Metazoa, 149-486  
*Metridium*, 176  
 Mice, 458  
 Micromeres, 234, 255  
 Micropyle, 36  
*Microstomum*, 195  
 Migration, 107, 136; of birds, 433  
 Millipedes, 297  
 Mimicry, 130, 391  
*Mimus*, 428  
 Mink, 455  
 Mites, 310  
 Mitotic cell-division, 24, 25  
 Mniotiltidæ, 431  
 Mocking bird, 428  
 Modern birds, 411  
 Molar teeth, 444  
 Moles, 452  
 Mollusca, 240  
 Molluscoidea, 203  
 Monkeys, 460  
 Monodelphia, 451  
 Monomya, 260  
 Monotremata, 440, 450  
 Morphology—defined, 3  
 Morula, 38, 39  
 Mosquitoes, 302, 303  
 Moths, 303  
 Motion, 76 (see locomotion); proto-plasmic, 15  
 Moulting, 280  
 Mouth-parts (arthropods), 266, 274  
 Mucous epithelium, 50  
 Muscular system, 76; cœlenterates, 183; echinoderms, 217; annulates, 229; mollusks, 248; arthropods, 281; vertebrates, 346



- Muscular tissue, 59-61  
 Mussel, 253, 255, 240, 258  
*Mutabilia*, 384  
 Mutation, 104, 108, 489  
 Mya, 240, 257  
 Myctodera, 384  
 Myotome, 314, 346  
 Myriapoda, 297  
*Mytilus*, 259  
  
*Nais*, 239  
 Natural history, 520  
 Natural selection, 105  
 Nauplius, 294  
*Nautilus*—pearly, 262; paper, 264  
 Necator, 201  
*Necturus*, 381, 384  
 Nemathelminthes, 200  
 Nemertinea, 204  
 Neornithes, 411  
 Nephridia, 72, 73, 232, 345  
*Nereis*, 226, 237  
 Nervous system, 77-84 (see sense organs); coelenterata, 183; echinoderms, 218; annulata, 232; mollusks, 252; arthropods, 284; vertebrates, 348; reptiles, 389; birds, 406; mammals, 447  
 Nervous tissue, 61, 62  
 Nettling cells, 182  
 Neuron, 62  
 Neuroptera, 299  
 Newts, 384  
 Nictitating membrane, 356; in birds, 406  
 Notochord, 312, 329  
 Nucleoplasm, 27  
 Nucleolus, 21  
 Nucleus, 21; functions of, 26  
 Nutrition, 67; protozoa, 155; see digestion, metabolism, etc.  
 Nutritive pole, 37  
  
*Obelia*, 186  
 Ocelli, 286  
*Occulina*, 177  
 Octopoda, 260  
*Octopus*, 263, 264  
 Odonata, 299  
 Odontophore, 245, 249  
  
 Oesophagus, 335  
 Oil glands, 327  
 Olfactory nerves, 353  
 Oligochaeta, 238  
 Ommatidium, 286  
*Omiscus*, 270  
 Onychophora, 297  
 Oocytes, 32, 33, 34  
 Oogonia, 32, 33, 34  
 Ophidia, 394  
 Ophiuroidea, 221  
 Optic nerve, 353, 356  
 Orb-weavers, 308  
 Organization, 19, 48, 66; of protozoa, 154  
 Organs, 67  
 Origin of tissues, 48  
 Original home of animals, 137  
 Orioles, 421  
 Ornithodelphia, 450  
*Ornithorhynchus*, 450  
 Orthoceratites, 263  
 Orthoptera, 298  
 Oscines, 430  
 Osculum, 166  
*Osmerus*, 371  
 Osseous tissue (bone), 57  
*Ostrea*, 260  
 Ostrich, 412  
 Otocyst, 82 (see also auditory organs).  
 Otolith, 82  
 Otter, 455  
 Ovary, 75, 287, 345  
 Oviduct, 253, 287, 345, 407  
 Ovipositor, 273  
 Oviparous, 346  
 Ovum, 30  
 Owls, 420, 421, 422  
 Ox, 454  
 Oxidation, 17, 69  
 Oysters, 243, 257, 260  
  
*Palamonetes*, 296  
 Palæontology, 480  
 Palæozoology, defined, 5  
 Paludicolæ, 418  
*Papilio*, 306  
*Paramecium*, 150, 154  
 Parapodia, 237  
 Parasitic worms,—cycle of, 207  
 Parasitism, 130, 196, 204, 206

- Parental care, 117, 461  
 Parthenogenesis, 117  
 Passeres, 430  
 Pea-fowl, 422  
 Pearl oyster, 260  
 Pearls, 258  
*Pecten*, 260  
 Pelagic fauna, 137  
*Pelecanus*, 417  
 Pelecypoda, 258  
 Penguin, 414  
*Pennaria*, 186  
 Perennibranchiata, 384  
 Pericardial sinus, 284  
 Perichondrium, 56  
 Periosteum, 57  
*Peripatus*, 297  
 Peripheral nervous system, 80, 348,  
     352 (see nervous system).  
 Perissodactyla, 454  
 Peritoneum, 317  
 Periwinkles, 261  
 Petrels, 415  
 Pharyngognathi, 374  
 Pharynx, 334  
 Pheasant, 422  
 Philosophy of biology, 525  
*Phanicopterus*, 416  
*Pholas*, 259  
 Phyla, key to, 148  
*Physalia*, 188  
 Physiology, defined, 4; history of, 523  
 Physopoda, 300  
 Physostomi, 373  
*Phytophaga*, 303  
 Pici, 427  
*Pieris*, 304  
 Pigeon, 418  
 Pigments, 11  
 Pituitary body, 342  
 Placenta, 449  
 Placentalia, 440, 451  
 Planarians, 194  
*Planorbis*, 262  
 Plant-lice, 300  
 Planula, 185  
 Plasma (blood), 58, 339  
 Plastron, 393  
 Platyhelminthes, 193  
 Plecoptera, 299  
 Plectognathi, 374  
 Pleura, 338  
 Pleuron, 267  
 Plexus, 353  
 Plover, 418, 434  
*Plumatella*, 193, 203  
 Polar bodies, 33, 34, 35  
 Polychæta, 237  
*Polygordius*, 235  
 Polymorphism, 120, 189, 190  
 Polyp, 176-179  
 Polyzoa, 203  
 Porcupine, 457  
 Porifera, 148, 165  
 Porpoises, 453  
 Potato-beetle, 305  
 Prairie dog, 458  
 Premolar (teeth), 444  
 Primary vesicles (brain), 348  
 Primates, 452, 459  
 Primordial germ cells, 32, 33, 34  
 Proboscidea, 455  
 Proctodæum, 68, 281  
 Proglottis (segment), 199, 200  
 Promorphology—defined, 3, 92; illus-  
     trated, 92  
 Prophase, 24  
 Prostomium, 230  
 Protective resemblance, 127  
 Proteids, 11  
 Prothorax, 273  
 Protoplasm, 10; chemical composition  
     of, 11; physical structure, 11; physi-  
     ology, 12, 66; relation to life, 9  
 Protodipite, 268  
*Protopterus*, 375  
 Prototheria, 440  
 Proto-vertebrata, 312  
 Protozoa, 149, 150  
 Proventriculus, 281, 405  
 Pseudopodia, 155  
 Psychology, 471  
 Ptarmigan, 419  
*Pterophylla*, 300  
*Pteropus*, 458  
 Pulp-cavity (see teeth), 443  
 Pupa, 289 (see metamorphosis).  
 Purity of gametes, 501  
 Pygopodes, 414  
 Pyloric cæca, 282, 317

- Quadratè bone, 388, 443  
 Quail, 422  
 Quill (see feather).  
  
 Rabbit, 458.  
 Rachis (see feather).  
 Radial symmetry, 94  
 Radiolaria, 162  
 Radula, 248  
 Rail, 418  
*Rana*, 382  
 Raptores, 420  
 Rat, 456, 462  
 Ratitæ, 411  
 Rattle-snake, 388  
 Rays, 373  
 Razor-clam, 254  
 Reason, 470  
 Receptaculum seminis, 233, 287  
 Rectrices (see feathers), 400  
 Redia, 197  
 Reduction divisions, 32, 33, 34  
 Reference books, 540  
 Regeneration, 97  
 Reintegration of parts, 85  
 Relationships of animals, 488-491  
 Remiges (see feathers), 400  
 Renal portal circulation, 365  
 Reproduction, 14; of cells, 23; asexual, 74; sexual, 75, 117  
 Reproduction organs of—protozoa, 157; porifera, 170; cœlenterata, 184; unsegmented worms, 192, 195, 197; echinoderms, 218; annulata, 234; mollusks, 253, 254; arthropods, 287; vertebrates, 345, fishes, 370; amphibia, 380; reptiles, 391; birds, 408; mammals, 448  
 Reproductive epithelium, 52, 53, 54  
 Reptiles, 144, 385; age of, 386  
 Reptilian birds, 410  
 Resemblance, general and special, 121  
 Respiration, 69; internal, 337; cœlenterata, 182; annulata, 231; echinoderms, 216; mollusks, 250; arthropods, 282 vertebrates, 337; fishes, 337; amphibians, 378; reptiles, 388; birds, 405, mammals, 447  
 Respiratory tree, 216  
 Retina, 83, 84, 356, 357  
*Rhamphorhynchus*, 391  
  
 Rhinoceros, 454  
*Rhinoderma*, 380  
 Rhizopoda, 162  
*Rhodostethia*, 414  
 Right-left axis (see symmetry).  
 Rodentia, 451, 456  
 Rotifers, 201, 202  
 Round worms, 200  
 Rudimentary organs, 487  
 Rumen, 444  
 Ruminant, 454  
     stomach, 444  
  
 Sacral vertebræ, 330  
 Sagittal section, 92  
 Salamander, 384  
 Saliencia, 384  
*Salmo*, 369 (salmon)  
*Salvelinus*, 369  
 Sarcolemma, 60  
 Sauria, 393  
 Saururæ, 411  
 Scale insects, 300  
 Scales, 363  
 Scallop, 260  
 Scarabeids, 305  
*Sceloporus*, 394  
 Schwann's sheath, 63  
*Sciurus*, 457  
*Scolopendra*, 298  
 Scorpionida, 308  
 Scyphistoma, 186  
 Scyphozoa, 186  
 Sea-cow, 453  
     cucumber, 221  
     lilies, 220  
     squirts, 313  
     urchins, 221  
 Seals, 455  
 Secretion, 17, 70  
 Sections, defined, 92  
 Segment, 279 (see metamere, somite).  
 Segmentation (see cleavage, metamerism).  
     cavity, 38, 39  
 Segmented worms (see annelida).  
 Segregation of characters, 501  
 of germ cells 43,  
 Semi-circular canals, 355  
 Seminal vesicles, 233

- Sensation, 77; (see also sense organs).  
 Sense organs—protozoa, 156; porifera, 170; coelenterata, 183; echinodermata, 218; annulata, 232; mollusca, 252; arthropoda, 284; vertebrata, 348; reptiles, 389; birds, 406; mammals, 447.  
 Sensory epithelium, 52, 53  
 Serpentes, 394  
 Sexual cells, 30 (see ovum, sperm).  
 Shark, 373  
 Sheep, 454  
 Sheepshead (fish), 374  
 Shell, 246; structure, 248  
 Shipworm, 259  
 Shrike, 430  
 Shrimp, 296  
 Sight, 82 (see sense organs).  
 Silk worm, 305  
 Siphon, 241, 256, 257  
 Siphonophora, 186, 188  
 Sipunculids, 204  
 Sipunculoidea, 239  
*Siren*, 381, 384  
 Sirenia, 451, 453  
 Skates, 373  
 Skin, 327 (see integument).  
   senses, 354  
 Skeletal system, 73—in protozoa, 154; porifera, 169; coelenterates, 183; echinoderms, 213, 217; annulates, 229; mollusks, 245; arthropods, 280; vertebrates, 328; fishes, 360; amphibia, 378; reptiles, 387; birds, 404; mammals, 443  
 Skull, 363, 388, 420, 422  
 Sloths, 451  
 Slugs, 261  
 Smell, 81, 354  
 Smelt, 371  
 Snails, 243, 247, 261  
 Snakes, 394  
 Snipe, 418  
 Snowy grouper, 374  
 Social instincts, 121, 288, 450, 472  
 Sociology, 472  
 Somite (see segment).  
 Sow-bug, 270, 294  
 Sparrows, 421  
 Special senses, 81, 354  
 Species, 110–112  
 Spermatids, 32, 33, 34  
 Spermatocytes, 32, 33, 34  
 Spermatozoon, 31  
 Sphincter, 336  
 Spider, 307, 309  
 Spinal cord, 352  
   nerves, 352  
 Spinous process, 329  
 Spiracle, 273  
*Spirostomum*, 156  
 Spleen, 342  
 Sponges, 148, 165 (see porifera).  
 Spontaneous generation, 161  
 Sporocyst, 195, 196  
 Sporozoa, 162  
 Sports, 488  
 Squamata, 393  
 Squamous epithelium, 50  
 Squid, 244, 263  
 Starfish, 206, 212  
 Statocyst, 81, 82, 285 (see otocyst).  
 Statoliths, 81, 82  
 Steganopodes, 416  
*Stentor*, 156  
 Sternum, 267, 332  
 Stigmata, 282  
 Stimulus, 13  
 Stolon, 185  
 Stomach, 336, 445  
 Stomodæum, 68, 281  
 Stone flies, 299  
 Stork, 416  
 Streptoneura, 261  
 Striate muscle, 61  
 Strobila, 198  
 Struggle for existence, 104  
*Struthio*, 412  
 Sturgeon, 373  
 Sunfish, 373  
 Supplementary studies—protozoa, 164; porifera, 173; coelenterata, 190; unsegmented worms, 206; echinoderms, 221; annulata, 239; mollusca, 264; arthropods, 310; fishes, 375; reptiles, 397; birds, 437; mammals, 464  
 Supportive tissue (see connective).  
 Suture, 443  
 Swallow-tailed butterfly, 306  
 Sweat glands, 327

- Swifts, 419  
 Swine, 454  
 Symbiosis, 124  
 Symmetry, 3, 92, 372  
 Sympathetic system, 354  
 Syrinx, 406, 432  
  
*Tænia*, 198  
 Tail, 362  
 Tape-worm (see *Tænia*), 199  
 Tapir, 455  
 Tarso-metatarsus, 405  
 Tarsus, 273, 333  
 Teeth, 443  
 Teleostei, 373  
 Telophase, 26  
 Tent caterpillars, 304  
*Teredo*, 259  
 Tergum, 267  
 Termites, 299  
*Terrapene*, 393  
 Testis, 76, 233  
 Testudinata, 393  
 Tetrabranchiata, 263  
*Thamnophis*, 396  
 Thread-worms, 200  
 Thrips, 300  
 Thrushes, 428, 431  
 Thymus, 342  
 Thyroid, 342  
 Thysanura, 299  
 Tibia, 273  
 Ticks, 310  
 Tiger, 455  
 Tissues—definition, 48; differentiation,  
     42; classification, 49  
 Toad, 382  
 Tortoises, 393  
 Tortoise-shell, 387  
 Toucans, 429  
 Touch, 81  
 Trachea, 338  
 Tracheæ, 70, 282  
 Transverse section, 92  
 Tree-toads, 384  
 Trematodes, 196  
 Trichinella, 200  
 Trichoptera, 300  
 Trivium, 213  
 Trochanter, 273  
  
 Trochophore, 202, 235, 255  
 Troglodytidae, 431  
 Trophoblast, 448, 449  
 Tube-feet, 215  
*Tubifex*, 239  
 Tunicates, 313  
 Turbellaria, 194, 195  
 Turdidæ, 431  
 Turkey, 417  
 Turtles, 393  
 Tympanic membrane, 355  
 Typhlosole, 231  
  
 Ungulata, 451, 453  
 Unit characters, 492  
*Unio*, 240, 259  
 Univalent chromosomes, 33, 34, 35  
 Unsegmented worms, 148, 191  
*Upupa*, 403  
 Urea, 72, 345  
 Ureter, 345, 448  
 Urethra, 345, 448  
 Uric acid, 72  
 Urinary bladder, 345, 448  
 Uterus, 193, 346, 448  
  
 Vagus (nerve), 353  
 Variability, 103, 483, 493  
 Varieties, 110  
 Vas deferens, 253, 287, 345  
 Veins, 72  
 Veliger, 255  
 Venomous snakes, 390  
 Ventriculus (stomach), 281  
 Vermes, 204  
 Vermiform appendix (cæcum), 446  
 Vertebræ, 330, 331  
 Vertebral column, 329; divisions of, 330  
 Vertebrates, 146, 313  
 Villi, 336, 449  
 Visceral arches, 337  
 Viviparous, 346  
*Volvox*, 154, 159, 162  
*Vorticella*, 158, 159, 162  
 Vultures, 420  
  
 Walking-stick insect, 123, 126, 298  
 Walrus, 454  
 Warblers, 421  
 Wasps, 307

- Water-boatman, 300  
Water-vascular system, 214, 217  
Weasel, 455  
Web (of spiders), 306; birds, 402  
Weevils, 305  
Whales, 453  
Whelks, 261  
Whippoorwill, 430  
White ants, 299  
Wings—insects, 280; birds, 401; bats, 458  
Wolves, 455  
Wood-lice, 300  
Wood-peckers, 425, 427  
Worms, 148, 191, 223  
Wrens, 421  
*Xiphosura*, 307  
Yolk, 37; influence on cleavage, 38  
Zebra, 455  
Zoëa, 288  
Zoology—scope, 2; history of, 6 and  
Ch. XXVIII













