

THE
MINIATURE
FRUIT
GARDEN



T. FRANCIS RIVERS

ALBERT R. MANN
LIBRARY
AT
CORNELL UNIVERSITY



CORNELL UNIVERSITY LIBRARY



3 1924 074 175 856



Cornell University Library

The original of this book is in
the Cornell University Library.

There are no known copyright restrictions in
the United States on the use of the text.

THE
CULTURE OF FRUIT TREES .

PRINTED BY
SPOTTISWOODE AND CO., NEW-STREET SQUARE
LONDON

THE
MINIATURE FRUIT GARDEN
AND
MODERN ORCHARD

OR THE CULTURE OF
PYRAMIDAL AND BUSH FRUIT TREES

WITH
INSTRUCTIONS FOR ROOT-PRUNING
ETC.

MEL. Truly, Sir, a fair garden! here have you governed nature by your art;
your ordered ranks of fruitful trees are thankful for your care, and
for your reward give you of their best

HORT. You do me too much honour, friend! (*Old Play*)

Insere, Daphni, piros, carpent tua poma nepotes—VIRG. *Ecl.* ix

BY
THOMAS RIVERS AND T. FRANCIS RIVERS

TWENTIETH EDITION

LONDON

LONGMANS, GREEN, AND CO.

AND NEW YORK: 15 EAST 16th STREET

1891



513

356

R6

1891

PREFACE

THE publication of the twentieth edition is a satisfactory proof of the successful application of the rules laid down in the preceding editions. I am happy to think that the work has contributed to the pleasure of many by drawing their attention to the fact that fruit trees may be cultivated in a smaller space than was formerly supposed to be possible, and I hope that with the spread of knowledge the pleasure and profit derived from the cultivation of small fruit trees may be extended to many cottage gardens in England.

I may here remark that apples on the Paradise stock are especially suited for cottagers. With a good selection of trees on this stock, the cottage may compete successfully at autumnal shows with the garden of the mansion, and in certain situations, well selected, the fine varieties of Belgian and French pears—peculiarly the property of skilful and wealthy horticulturists—will, by attention to the simple rules given in this work, be exhibited by the humble but triumphant cottager.

I cannot—and it is not a matter of regret—add anything new. Trees do not change their nature, and the rules for their cultivation in one year, if sound, must be the same in all succeeding years.

I have endeavoured to point out a method of making condensed orchards on a system which I believe to be sound, as it is no theory but practice. I can only hope that the present edition may deserve the same success that has hitherto attended all the previous editions.

T. FRANCIS RIVERS.

October 1891.

PREFACE TO THE SIXTEENTH EDITION

BY THOMAS RIVERS

IN giving the seventeenth thousand of my little book to the public, I trust I may be allowed to express my pleasure and gratitude for its success—perfectly unprecedented in books devoted to horticulture. The reception given to it by those numerous and increasing horticultural amateurs who seem to love to devote their leisure to the culture of fruit and fruit trees has been to me a source of much pleasure. For thirty years and more have I watched the growth of this taste in England, and more particularly in those who garden with their own hands and heads; it is such men that form the true vanguard of fruit culturists, for they almost invariably improve on any suggestion given by a writer; and, if I wanted them, I could fill a volume with letters from clever amateurs who have given new ideas, always suggestive if not always practicable. As a prominent but not new feature in this enlarged edition, I may refer to the management, and above all the protection, of low lateral cordon fruit trees. I

have also pointed out more forcibly than in former editions the capability of growing choice pears and apples on any low cheap walls, and also against walls in kitchen gardens not fully furnished with trees—in short, in all bare spaces so often found between wall trees in old gardens. These methods of cultivating choice pears and the finer kinds of American apples are worthy of much more attention than they have hitherto received.

The method of cultivating plums as vertical single cordons has been practised here for some few years; it is original, highly worthy of attention, and may be made a profitable venture, not only for the amateur but for the market gardener.

The management of those charming structures, ground vineries, is in this edition more fully gone into than before; in short, all the modes of culture hitherto recommended have been revised and made as perfect as practice can make them, for it must be recollected that all the modes of culture here recommended have been well tested, and no foreign practice recommended till found adapted to our wet English climate, the mean temperature of which is just about two degrees too low for the choice kinds of fruits to ripen without assistance.

September 1870.

INTRODUCTION TO THE FIRST EDITION

BY THOMAS RIVERS



My attention was drawn to the benefits fruit trees derive from root-pruning and frequent removal about the year 1810. I was then a youth, with a most active fruit-appetite, and if a tree bearing superior fruit could be discovered in my father's orchard I was very constant in my visits to it.

In those days there was in the old nursery, first cropped with trees by my grandfather about the middle of last century, a 'quarter'—i.e., a piece of ground devoted to the reception of refuse trees—of such trees as were too small or weak for customers; so that in taking up trees for orders during the winter they were left, and, in spring, all taken up and transplanted to the 'hospital quarter,' as the labourers called it. The trees in this quarter were taken up, often annually, and planted nearer together, on the same piece of ground. This old nursery consisted of about eight acres, the soil of a deep reddish loam, inclining to clay, in which fruit trees flourished and grew vigorously. I soon found that it was but of little use to look among the young free-growing trees for fruit, but among the refuse trees, and to the 'hospital quarter' I was indebted for many a fruit-feast—*such* Ribston Pippins! *such* Golden Pippins!

When I came to a thinking age, I became anxious to know why those refuse trees never made strong vigorous shoots, like those growing in their own immediate neighbourhood, and yet nearly always bore good crops of fruit. Many years elapsed before I saw 'the reason why,' and long afterwards I was advised by a friend, a F.H.S., to write a crude, short paper on the subject, and send it to be read at a meeting of the Horticultural Society: this paper is published in their 'Transactions.' I had then practised it several years; so that I may now claim a little attention, if the old adage that 'practice makes perfect' be worthy of notice.

This little work is not designed for the gardens and gardeners of the wealthy and great, but for those who take a personal interest in fruit-tree culture, and who look on their garden as a never-failing source of amusement. In some few favoured districts, fruit trees, without any extra care in planting and after-management, will bear good crops, and remain healthy for many years. It is not so in gardens with unfavourable soils: and they are greatly in the majority. It is to those possessing such, and more particularly to the possessors of small gardens, that the directions here given may prove of value. The object constantly had in view is to make fruit trees healthy and fruitful, by keeping their roots near the surface. The root-pruning and biennial or occasional removal, so earnestly recommended, are the proper means to bring about these results, as they place the roots within the influence of the sun and air. The ground over the roots of garden trees as generally cultivated is dug once or twice a year, so that every surface-fibre is destroyed and the larger roots driven downwards; they, consequently, imbibe crude, watery sap, which leads to much apparent luxuriance in the trees. This, in the end, is fatal to their well-doing, for the vigorous shoots made annually are seldom or never ripened

sufficiently to form blossom-buds. Canker then comes on, and although the trees do not die, they rarely give fruit, and in a few years become victims of 'bad culture, existing in a sort of living death.

There is, perhaps, no fruit tree that claims or deserves our attention equal to a pear. How delicious is a fine melting pear all the winter months! and to what a lengthened period in the spring may they be brought to table! Till lately, *Beurré Rance* has been our best spring pear; but this is a most uncertain variety, rarely keeping till the end of May, and often ripening in January and February.

The Belgian pears, raised many years since by the late Major *Esperen*, and more recently by *Monsieur Grégoire*, are likely for the present to be the most valuable for prolonging the season of rich melting pears; and of these *Joséphine de Malines* and *Bergamotte d'Esperen* are especially deserving of notice; they have the excellent quality of ripening slowly. But improvement will, I have no doubt, yet take place; for pears are so easily raised from seed, and so soon brought into bearing by grafting or budding them on the quince stock, that new and valuable late pears will soon be as plentiful as new roses.

In the following pages it will be seen that I strongly advocate the culture of pyramidal fruit trees. This is no new idea with me. I have paid many visits to the Continental gardens during the greater portion of my active life in business, and have always admired their pyramidal trees when well managed, and I have for many years cultivated them for my amusement; but, owing to a seeming prejudice against them amongst some English gardeners, I was for some time deterred from recommending them, for I thought that men older than myself must know better; and when I heard some of our market-gardeners and large fruit growers in the neighbourhood of London scoff at pears grafted on the quince stock as giving fruit of a very

inferior flavour, I concluded, like an Englishman, that the foreigners were very ignorant; and very far behind us in the culture of fruit trees.

It was only by repeated visits to foreign gardens that this prejudice was dispelled. I felt convinced that our neighbours excelled us in the management of fruit trees adapted to the open borders of our gardens. I have therefore endeavoured to make the culture of pyramidal trees easy to the uninitiated; and, having profited largely by experience in attending to it with my own hands, I trust that my readers will benefit by the result.

A humid, mild climate seems extremely favourable to the well-doing of the pear on the quince stock. Jersey, with its moist warm climate, as is well known, produces the finest pears in Europe: these are, for the most part, from trees on quince stocks. The western coast of Scotland, I have reason to know, is favourable for the culture of pear trees on the quince; and within these very few years Ireland has proved remarkably so, more particularly in the south, where some of our finest varieties of pears on quince stocks are cultivated with perfect success.

CONTENTS



	PAGE
PYRAMIDAL PEAR TREES ON THE QUINCE STOCK	1
THE YOUNG PYRAMID	5
THE MATURE PYRAMID	8
ROOT-PRUNING OF PYRAMIDAL PEAR TREES ON QUINCE STOCKS	13
PYRAMIDS FOR MARKET GARDENS	18
ORNAMENTAL PYRAMIDAL PEAR TREES ON QUINCE STOCKS	20
PEAR TREES AS BUSHES ON THE QUINCE STOCK	20
PEAR TREES ON THE QUINCE STOCK, TRAINED AS CORDONS	26
CORDON PEARS ON TRELLISES UNDER GLASS	35
HORIZONTAL CORDON PEAR TREES ON DWARF WALLS	39
ESPALIER PEARS ON QUINCE STOCKS	43
PEAR TREES TRAINED AS SINGLE VERTICAL CORDONS	47
DIAGONAL SINGLE CORDONS	48
PEAR-TREE HEDGE	53
PYRAMIDS ON THE PEAR STOCK	54
ROOT-PRUNING OF FRUIT TREES	59
PLANTING AND AFTER-MANAGEMENT	61

	PAGE
GATHERING THE FRUIT	66
KEEPING PEARS IN A GREENHOUSE	69
PYRAMIDAL APPLE TREES ON THE PARADISE APPLE STOCK	71
APPLES AS BUSHES ON THE PARADISE STOCK	79
APPLES AS BUSHES FOR MARKET GARDENS	83
APPLES AND PEARS AS SINGLE AND DOUBLE LATERAL CORDONS	87
SHELTER TRENCHES	96
VERTICAL CORDON APPLE TREES	97
APPLES AS WALL TREES	98
PYRAMIDAL APPLES ON THE CRAB STOCK	100
PYRAMIDAL PLUM TREES	102
PLUM TREES AS BUSHES	105
PLUM TREES AS CORDONS	106
MARKET GARDEN PLUM TREES	108
CHERRIES AS BUSHES AND PYRAMIDS ON THE MAHALEB STOCK (<i>Cerasus mahaleb</i>)	109
CHERRIES AS SINGLE VERTICAL CORDONS	115
BIGARREAU AND HEART CHERRIES AS PYRAMIDS ON THE COMMON CHERRY STOCK	117
FILBERTS AND NUTS AS STANDARDS	120
FIGS AS HALF STANDARDS OR BUSHES	121
SEEDLING FRUITS	123
THE BIENNIAL REMOVAL OF FRUIT TREES WITHOUT ROOT- PRUNING	125
PYRAMID ORCHARDS	126
DOUBLE GRAFTING OF FRUIT TREES	130
RENOVATING OLD STANDARD PEAR TREES	135
HOW TO PREPARE A PEACH TREE BORDER IN LIGHT SOILS	136

CONTENTS

xv

	PAGE
A CHEAP METHOD OF PROTECTING WALL TREES . . .	137
STANDARD ORCHARD TREES	139
INSECTS PECULIAR TO THE PEAR	142
METHODS OF PLANTING SMALL PYRAMID TREES . . .	145
PROPER DISTANCES FOR PLANTING PYRAMIDAL AND OTHER FRUIT TREES	146
MINIATURE FRUIT GARDEN CALENDAR	148

APPENDIX I

THE GROUND VINERY	151
PLANTING AND PRUNING VINES FROM POTS	160
CORDON TRAINING	164

APPENDIX II

INSECT PESTS, BY H. SOMERS RIVERS	186
INDEX	207

THE
MINIATURE FRUIT GARDEN

PYRAMIDAL PEAR TREES ON THE
QUINCE STOCK

THERE is no description of fruit trees more interesting to cultivate in our gardens than the pyramid—a name adopted from the French, the originators of this species of culture. The word conical would, perhaps, convey a better idea of the shape of such trees; but as pyramidal trees are now familiar things in English gardens, it is scarcely worth while to attempt to give a new name to these very pretty garden trees.

For gardens with a moderately deep and fertile soil, pears budded on the quince stock will be found to make by far the most fruitful and quick-bearing trees; indeed, if prepared by one or two removals, their roots become a perfect mass of fibres, and their stems and branches full of blossom-buds. Trees of this description may be planted in the autumn, with

a certainty of having a crop of fruit the first season after planting—always recollecting that a spring frost may destroy the blossoms unless the trees are protected. It must always be recollected that pears on quince stocks are strictly garden trees, and not adapted for orchards.

The most eligible season for planting pyramidal pear trees is during the months of November and December, but they may be planted even until the end of March; in planting so late, no fruit must be expected the first season. Still I ought to say here that I have frequently removed pear trees on the quince stock in March and April, just as the blossom-buds were bursting, and have had fine fruit the same season, particularly if sharp frosts occurred in May. The buds being retarded, the blossoms opened after the usual period, and thus escaped. The experiment is quite worth trying in seasons when the buds swell very early.

About ten or fifteen fruit may be permitted to ripen the first season; the following season one to two dozen will be as many as the tree ought to be allowed to bring to perfection; increasing the number as the tree increases in vigour, always remembering that a few full-sized and well-ripened pears are to be preferred to a greater number inferior in size and quality.

The engraving (fig. 1 on the following page) is a faithful portrait of a pyramidal tree of the Beurré

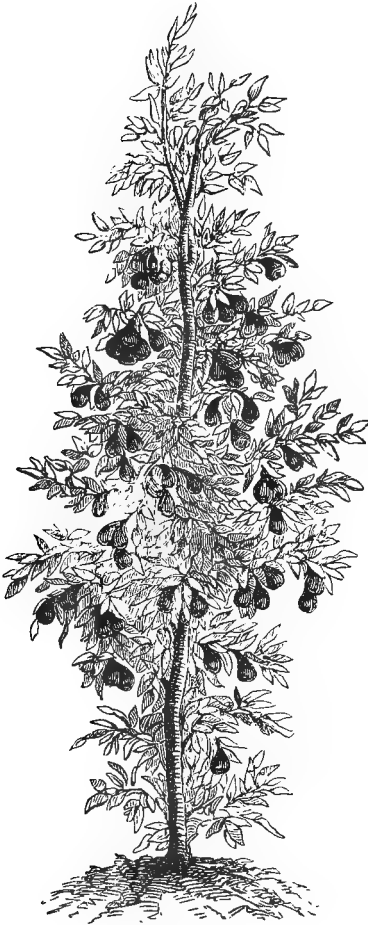

FIG. 1

de Capiaumont pear budded on the quince; it was about ten years old, and had been root-pruned three times. Nothing could be more interesting than this tree, only six feet high, laden with fruit of extraordinary beauty; for, in this soil, pears on quince stocks produce fruit of much greater beauty, and of finer flavour, than those on pear stocks. I have, however, introduced the figure as much to show its imperfection as its beauty; it will be observed that its lower tiers of branches are not sufficiently developed; this was owing to neglect when the tree was young—the upper branches were suffered to grow too luxuriantly. Summer pinching in the youth of the tree is the only remedy for this defect, if it be not well furnished below; and a severe remedy it is, for *all* the young shoots on the upper tiers, including the leader, must be pinched closely in May and June, till the lower ones have made young shoots of a sufficient length to give uniformity to the tree. This requires much attention.

Pyramids, bushes, and cordons are the trees best adapted for small gardens. To those conversant with such matters, I need only point to the very numerous instances of rich garden ground entirely ruined by being shaded by large spreading standards, or half-standard unpruned fruit trees. Now, by cultivating pyramidal pears of the quince, apples in the same form on the paradise stock, the cherry as pyramids and dwarf bushes on the *Cerasus Mahaleb*, and the

plum as a pyramidal tree, scarcely any ground will be shaded, and more abundant crops and finer fruit will be obtained.

THE YOUNG PYRAMID

IF a young gardener intends to plant, and wishes to train up his trees so that they will become *quite* perfect in shape, he should select plants one year old from the bud or graft, with single upright stems; these will, of course, have good buds down to the junction of the graft with the stock. The first spring a tree of this description should be headed down, so as to leave the stem about eighteen inches long. If the soil be rich, from five to six and seven shoots will be produced; one of these must be made the leader, and, if not inclined to be quite perpendicular, it must be fastened to a stake. As soon, in summer, as the leading shoot is ten inches long, its end must be pinched off; and if it pushes forth two or more shoots, pinch off all but one to three leaves, leaving the topmost for a leader. The side shoots will, in most cases, assume a regular shape; if not, they may be this first season tied to slight stakes, to make them grow in the proper direction. This is best done by bringing down and fastening the end of each shoot to a slight stake, so that an open pyramid may be formed—for if it is too close and cypress-like, enough air is not admitted to the fruit. They may remain unpruned

till the end of September, when each shoot must be shortened to within eight buds of the stem. This will leave the tree like the annexed figure (fig. 2), and no pruning in winter will be required.

The second season the tree will make vigorous growth; the side shoots which were stopped last



FIG. 2

September will each put forth three, four, or more shoots. In June, as soon as these have made seven or ten leaves, nip out the terminal buds of *all but the leading shoot of each side branch*; this must be left on to exhaust the tree of its superabundant sap, till the

middle or end of September. The perpendicular leader must be stopped once or twice; in short, as soon as it has grown ten inches pinch off its top, and if it break into two or three shoots pinch them all but the leader, as directed for the first season; in a few years most symmetrical trees may be formed.

When they have attained the height of six or eight feet, and are still in a vigorous state, it will be necessary to commence root-pruning, to bring them into a fruitful state.

If some of the buds in the stem of a young tree prove dormant, so that part of it is bare and without a shoot where there should be one, a notch, half an inch wide and nearly the same in depth, should be cut in the stem just *above* the dormant bud. If this be done in February a young shoot will break out in the summer.¹

These directions are for those who are inclined to rear their own pyramids. Time and attention are required, but the interest attached to well-trained pyramids will amply repay the young cultivator.

¹ Bare places in the stems of pyramids, and in the branches of espaliers or wall trees, may be budded towards the end of August with blossom buds taken from shoots two years old. This is a very interesting mode of furnishing a tree with fruit-bearing buds.

THE MATURE PYRAMID

THE following figure (fig. 3) is a pyramidal tree in its second and third year, and such as it ought to be in July before its leading side shoots and leading upright shoot are shortened. This, as I have said, is best done towards the second or third week in September. The shortening must be made at the marks —; all the side shoots must be shortened in this manner, as well as the leading shoot; no further pruning will be required until the following summer. The spurs *a, a, a*, are the bases of the shoots that have been pinched in June; these will, the following season, form fruit-bearing spurs. The best instrument for summer and autumnal pruning is a pair of hooked pruning scissors or 'sécateurs,' which are now sold of all sorts and sizes.

As the summer pinching of pyramidal pears is the most interesting feature in their culture, and perhaps the most agreeable of all horticultural occupations, I must endeavour to give plain instructions to carry it out.

The first season after the planting, by the middle of June, the side buds and branches have put forth young shoots: each will give from one to three or four. Select that which is most horizontal in its growth (it should be on the lower part of the branch, as the tree will then be more inclined to spread) for a leader to that branch, and pinch off all the others to

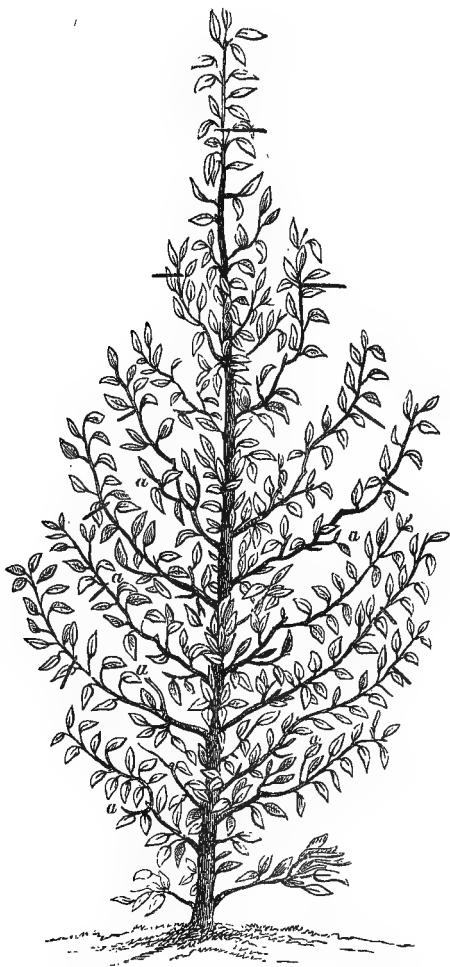

FIG 3

six or seven leaves (see fig. 3, *a, a, a*). From the point of pinching, a shoot will again grow, and should be left untouched until September. The first pinching forms the basis of fruit buds, and if the horizontal branch has a good leader it will take off all the superfluous sap, the buds will only swell, and the following season they will be fruit spurs. The upper shoots of the tree, say to about two feet from its top, should be pinched a week before the lower shoots; this gives strength to those on the lower part of the tree.

Fig. 4 is a side branch in June, with its shoots not yet pinched; about the middle of the month nip off the terminal buds of the laterals when these have made from seven to nine leaves, and, in September, stop the leading shoot to one-third of its length.

In spring the perpendicular leader of the preceding year's growth will put forth numerous shoots, which must be pinched in June in the following manner: those nearest the base leave six inches in length, gradually decreasing upwards, leaving those next the young leading shoots only two inches long. The leader of these ready formed pyramids need not be shortened in summer as directed for younger trees; it may be suffered to grow till the horizontal leaders are shortened in September, and then left six or eight inches in length; but if the trees are to be kept to six or seven feet in height under root-pruning, this leading shoot may be shortened to two inches, or even cut close down to its base. For tall pyramids of ten, twelve,

or fifteen feet, it may be left from eight to ten inches in length till the required height be attained; it may then be cut to within two inches of its base every season.

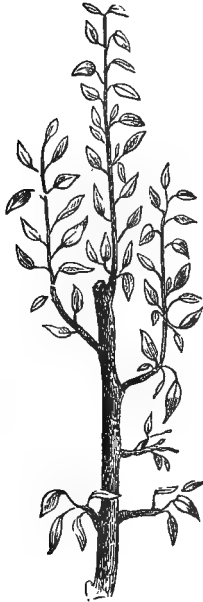

FIG. 4

I ought here to remark that pear trees differ in their habits to an extraordinary degree; some make shoots most robust and vigorous; others under precisely the same treatment are very delicate and slender. In the final shortening in September this

must be attended to; those that are very vigorous must not have their shoots pruned so closely as those that are less so; indeed, almost every variety will require some little modification in pruning, of which experience is by far the best teacher. It will, I think, suffice if I give the following directions for shortening the leaders of the side shoots, and the perpendicular leaders:—All those that are very robust, such as *Beurré d'Amanlis*, *Conseiller de la Cour*, *Beurré Diel*, &c., shorten to eight or ten inches, according to the vigour of the individual tree; those of medium vigour, such as *Louise Bonne of Jersey*, *Marie Louise*, and *Beurré d'Aremberg*, to six inches; those that are delicate and slender in the growth, like *Winter Nelis*, to four inches; but I must repeat that regard must be had to the vigour of the tree. If the soil be rich, the trees vigorous and not root-pruned, the shoots may be left the maximum length; if, on the contrary, they be root-pruned, and not inclined to vigorous growth, they must be pruned more closely. As a modification of pinching which sometimes induces excessive growth in non-fruiting trees, and in humid climates, I have found that stripping the leaves from the shoots to be operated upon has the same effect as pinching, without disturbing the flow of the sap.

If pyramidal fruit trees, either of pears, apples, plums, or cherries, are biennially removed, or even thoroughly root-pruned without actually removing them, summer pinching becomes the most simple of

all operations. The cultivator has only to look over his trees during June (penknife in hand), and pinch the terminal bud of every shoot on the lateral or side branches; the buds below the point of pinching will develop into fruit spurs, the shoots which push again from the terminals may, if the growth is not well balanced, be stopped in August, but all pruning should be deferred until the end of September.

It is possible that in some soils and climates, with a non-ripening power, summer pinching may be carried to an excess. It is difficult to lay down a hard and fast rule. As a matter of fact, in favourable fruit-growing districts—and it is hardly worth while to plant in any other—summer pinching with certain modifications will be found to give good results. The first pinching in June is really the most important, as it provides the fruit buds for the following year in the most convenient part of the tree—i.e. near the stem. If the leading shoot be shortened in September, the supplementary shoots produced by the first pinching may either be pruned or left until October.

ROOT-PRUNING OF PYRAMIDAL PEAR TREES ON QUINCE STOCKS

BEFORE entering on the subject of root-pruning of pear trees on quince stocks, I must premise that handsome and fertile pyramids, more particularly of some free-

bearing varieties, may be reared without this annual or biennial operation. I must impress upon my readers that my principal object is to make trees fit for small gardens, and to instruct those who are not blessed with large gardens how to keep the trees perfectly under control; and this can best be done by *annual*, or at least biennial, attention to the roots, for if a tree be suffered to grow three or more years and then be root-pruned, it will receive a check if the spring be dry, and the crop of fruit for one season will be jeopardised. Therefore, those who are disinclined to the annual operation, and yet wish to confine the growth of their trees within limited bounds by root-pruning say once in two years, should only operate upon half their trees one season; they will thus have the remaining half in an unchecked bearing state; and those who have ample room and space may prune their pyramids in summer, and suffer them to grow to a height of fifteen or twenty feet without pruning their roots. In rich soils, where the trees grow freely, they may be root-pruned annually with great advantage.

The following summary will, perhaps, convey my ideas respecting the management of pyramids and bushes when cultivated as garden trees:—In small gardens with rich soil either root-prune or remove all the trees annually, early in November. In larger gardens perform the same operation biennially at the same season. For very large gardens with a dry good subsoil, in which all kinds of fruit trees grow without

any tendency to canker, and when large trees are desired, neither remove nor root-prune.

Pyramidal pear trees on the quince stock, *where the fruit garden is small*, the soil rich, and when the real gardening artist feels pleasure in keeping them in a healthy and fruitful state by perfect control over the roots, should be annually operated upon as follows:—A trench should be dug round the tree about eighteen inches from its stem every autumn, just after the fruit is gathered, if the soil be sufficiently moist—if not it will be better to wait till the usual autumnal rains have fallen; the roots should then be carefully examined, and those inclined to be of perpendicular growth cut with the spade, which must be introduced quite under the tree to meet on all sides, so that no root can possibly escape amputation. All the horizontal roots should be shortened with a knife to within a circle of eighteen inches from the stem,¹ and all brought as near to the surface as possible, filling in the trench with compost for the roots to rest on. The trench may then be filled with the compost (well-rotted dung from an old hot-bed, and good turfy loam, equal parts, will answer exceedingly well); the surface should then be covered with some half-rotted dung, and the roots left till the following autumn brings its annual care. It may be found that after a few years of root-pruning the circumferential

¹ If they have not spread to this extent the first season, or even the second, they need not be pruned, but merely brought near to the surface and spread out.

mass of fibres will have become too much crowded with small roots ; in such cases thin out some of the roots, shortening them at nine inches or one foot from the stem. This will cause them to give out fibres, so that the entire circle of three feet or more round the tree will be full of fibrous roots near the surface, waiting with open mouths for the nourishment annually given to them by surface dressings and liquid manure.

The gardener who does not mind extra trouble will feel a real pleasure in every operation that tends to make his trees perfect in fruitfulness and symmetry. The annual root-pruning may, however, be irksome to the amateur ; nor is it always required in the south of England, except for small gardens and in rich moist soils in which pear trees are inclined to grow too vigorously. In the cool moist summers of the northern counties, annual root-pruning is quite necessary to make the trees produce well-ripened wood. In other cases, if the trees are summer-pruned, biennial root-pruning will be sufficient to check over-luxuriance in growth.

The following will be found a good selection of varieties for pyramidal trees on quince stocks. They may be planted in rows six feet apart, or a square may be allotted to them, giving each plant six feet, which will be found amply sufficient for root-pruned trees. Some few esteemed sorts of pears do not grow well on quince stocks, unless ' double-grafted '—i.e., some free-growing sort is budded on the quince, and after having

been suffered to grow for one or two seasons, the sort not so free-growing is budded or grafted on it. For varieties,¹ placed in order of their ripening, the following list may be safely recommended:—

Summer Doyenné	July.
Jargonelle	August.
Clapp's Favourite	August.
Beurré Giffard	Aug. Sept.
Bon Chrétien	September.
Beurré d'Amanlis	September.
Summer Beurré d'Arenberg	September.
Madame Treyve	Sept. Oct.
Beurré Superfin	Sept. Oct.
Louise Bonne of Jersey	October.
Fondante d'Automne	October.
Gansel's Bergamot	Oct. Nov.
Marie Louise	Oct. Nov.
Conseiller de la Cour	Oct. Nov.
Baronne de Mello	Oct. Nov.
Pitmaston Duchess	Oct. Nov.
Emile d'Heyst	November.
Doyenné de Comice	Nov. Dec.
Beurré d'Anjou	December.
Joséphine de Malines	January.

¹ All the varieties recommended for pyramids may also be planted as espaliers to train to rails in the usual mode.

PYRAMIDS FOR MARKET GARDENS

FIRST, a good climate must be selected somewhere south of the Trent, the site sheltered from the north and east and north-west by hedges, evergreens, or walls; also a favourable soil, which, however, by care and culture, may be made of secondary importance; a loam eighteen or twenty inches deep, on a dry stony subsoil, is perhaps the most favourable, but a clayey loam resting on clay or on sand will do very well. If required, draining must be practised, so that clays, loams, or sands must be dry.

When a rich deep fertile soil is chosen there will be nothing required but opening the holes and planting the trees; but if the soil be shallow, say less than twelve inches of staple, it should be stirred to a depth of twenty inches, leaving the stirred subsoil *in situ*. The soil is thus far prepared for planting, which will be best done in October or November. The trees should be planted six feet apart row from row, and the same distance tree from tree in the row. After the trees are planted, the soil within a circle of three feet round the stem of each tree should be trodden firmly; a small portion (the tenth of a barrowful) of litter or manure placed round each tree (or if the soil is rich this may be omitted), and the work is done. For some four or five years the centre of the space between the rows of trees may be cropped with light vegetable crops, such as onions, &c.; this culti-

vated space must be confined to a width of two feet; the remaining space next the trees must not be touched with anything but the hoe to kill the weeds, and when the intermediate cropping has covered the entire surface of the ground, it must remain firm, the only culture besides the hoe being an occasional surface-dressing of manure. This system of hard soil and occasional surface-manuring is the *summum bonum*, the last step towards perfect market garden fruit culture—except gooseberries, currants, and raspberries, which require other treatment. The quantity of manure required for a surface-dressing is five bushels to twenty-five square yards.

The rough and ready pruning necessary for market garden pyramidal pears is as follows:—Towards the middle (the end, if the season be late) of June all the terminal buds of the side shoots must be nipped off, and towards the end of September the trees are again gone over, and the leading shoots stopped; this is all the pruning required, unless the amateur market gardener pleases to amuse himself in winter by removing a crowded shoot or shortening a spur. The varieties best adapted for this mode of pear culture are few, as there are but few sorts popular in the markets. Our first and best is Louise Bonne, requiring, however, a warm climate and good soil; Williams' Bon Chrétien, Beurré d'Amanlis, Doyenné de Comice, Souvenir du Congrès, Marie Louise, Marie Louise d'Uccle, Fertility (very hardy), Durondeau, and Beacon.

ORNAMENTAL PYRAMIDAL PEAR TREES ON QUINCE STOCKS

THERE are some very few varieties of pears the trees of which may be made highly ornamental even on a well-dressed lawn, as they grow freely and form naturally beautiful cypress-like trees; at the same time their fruit is of first-rate quality. Such are Summer Beurré d'Areberg, Baronne de Mello, Fondante d'Autonne, White Doyenné, Louise Bonne of Jersey, Passe Colmar, Zéphirin Grégoire, Olivier de Serres, Souvenir du Congrès, Délices d'Hardenpont, Doyenné du Comice, Bergamotte d'Esperen, Marie Louise, Conseiller de la Cour, Fertility, Durondeau, Emile d'Heyst, Marie Benoist.

PEAR TREES AS BUSHES ON THE QUINCE STOCK

THIS mode of cultivating pear trees has struck me as being eligible, from having observed that the fruit of some of the large heavy varieties, such as Beurré Diel and Beurré d'Amanlis, is very liable to be blown off pyramids by even moderate autumnal gales. The trees also of these and several other fine sorts of pears are difficult to train in the pyramidal form; they are

diffuse in their growth, and, with summer pinching, soon form nice prolific bushes, of which the following figure (fig. 5), from nature, will give some idea. The pruning of these bushes is a simple matter. As they are likely to throw out many shoots, and so fill up the centre of the bush, thus impeding the circulation of



FIG. 5

light and air, I go over the branches in June and thin out those which are growing too thickly, the final pruning being left until the end of September. If the bushes are fruitful the pruning should be deferred until the fruit is gathered, and the summer thinning only practised.

Bushes are admirably adapted for gardens exposed to winds, and if removed biennially they may be grown in the smallest of gardens with great advantage. This biennial removal or lifting should be performed as follows:—A trench should be opened round the tree the width of a spade, and from twelve to fifteen inches deep; the tree should then be raised with its ball of earth attached to its root intact. If the soil be light and rich, and the tree inclined to grow vigorously, making annual shoots of more than one foot in length, it may be replanted without any fresh compost. Rotten manure, loam, and sand, equal parts with the addition of lime, chalk, or gypsum where the soil is known to be deficient in lime, form also an excellent compost; in planting, one wheelbarrowful to a tree will be enough. In London suburban gardens, for which these trees are peculiarly adapted, no compost need be given to the trees in replanting, for the soil is generally rich. Bush trees offer two very great advantages: they are easily protected from spring frosts when in blossom by covering them with tiffany, and they may be planted from three to five feet apart with great facility, so as to be eligible for very small gardens.

In large gardens, large bushes may be desirable. In such cases the leading shoots on each branch may be pinched, as recommended for pyramids (page 8), but instead of pinching them to three leaves they may be suffered to make ten leaves, and then pinch the

terminal bud. The trees will, if treated in this manner, soon become large, compact, and fruitful.

The following varieties are well adapted for bush culture, as they are diffuse in their growth and difficult to form into compact pyramids, although they may be made into spreading and prolific conical trees. It ought, however, to be mentioned that sorts, such as Louise Bonne of Jersey, which form handsome pyramids, make very pretty compact bushes by cutting out the central branch to within three feet of the ground, so that pyramids may be easily formed into bushes. I may add that these bush trees produce the very finest fruit, from their being so near the heat and moisture-giving surface of the earth.

In situations near the sea-coast, exposed to sea breezes, small fruit gardens may be formed by enclosing a square piece of ground with a beech hedge or wooden fence, and planting it with bush trees. A piece of ground 500 square feet will be large enough to cultivate 30 trees at 4 feet apart in it, or 25 trees at 5 feet apart. Many a sea-side cottage may thus have its fruit garden.

LIST OF PEARS ADAPTED FOR BUSH CULTURE

Summer Doyenné	.	.	.	July.
Beurré Giffard	.	.	.	August.
Beacon	.	.	.	August.
Clapp's Favourite	.	.	.	August.

Bon Chrétien, Williams'	.	.	September.
Summer Beurré d'Aremberg	.	.	September.
Beurré d'Amanlis	.	.	Sept. Oct.
Dr. Hogg	.	.	September.
Madame Treyve	.	.	September.
Souvenir du Congrès	.	.	Sept. Oct.
Louise Bonne of Jersey	.	.	October.
Fondante d'Automne	.	.	October.
Fertility	.	.	October.
Beurré Hardy	.	.	October.
Gansel's Bergamot	.	.	October.
Marie Louise	.	.	Oct. Nov.
Baronne de Mello	.	.	November.
Doyenné de Comice	.	.	Nov. Dec.
Durandean	.	.	Nov. Dec.
Beurré Diel	.	.	December.
Beurré d'Anjou	.	.	December.
Winter Nelis	.	.	December.
Joséphine de Malines	.	.	January.
Bergamotte d'Esperen	.	.	January.
Olivier de Serres	.	.	February.
Catillac (baking)	.	.	—
Uvedale St. Germain (baking)	.	.	—
Léon le Clerc de Laval (baking)	.	.	—

Pyramid pears may be grown and fruited in defiance of spring frosts, by subjecting the trees to constant removal. Under this treatment the roots become very fibrous and may be annually removed. The trees so

treated should be lifted in December, and then placed under a north wall until the end of March; they may then be returned to their fruiting places. The period of blossoming being thus retarded, a crop may be expected even in very inclement seasons.

PEAR TREES ON THE QUINCE STOCK, TRAINED AS CORDONS

THE French gardeners employ the term 'cordon' for the branch of a fruit tree on which the shoots have been pinched in, so as to form a succession of blossom-buds. The term as used by them is expressive, and lately an interesting work has been published by the Rev. T. C. Brehaut, of Guernsey, on this mode of training, under the title of 'Cordon Training of Fruit Trees.' There are various forms of cordon training, but I will begin with the five-branched vertical cordon commonly called 'upright trained trees.' This method of training originated here in April 1849, and was brought about from the necessity of planting a number of new pears on a boarded fence in a limited space; the horizontal method of training was quite inapplicable, and a modification of this system came to hand, viz., to plant horizontal espaliers, and to make them perpendicular. The following figure (fig. 6) is one of my five-branched vertical cordon pear trees.

The shoots *a, a*, should be eight inches from the central shoot, and those marked *b, b*, the same distance

from those marked *a, a*. This tree, with five branches, will thus occupy thirty-two inches—say three feet of wall room; a tree with seven branches will require four feet, but as some space ought to be allowed for the spurs on the outside branches, say five feet. If the wall be of a moderate height, eight feet for instance,

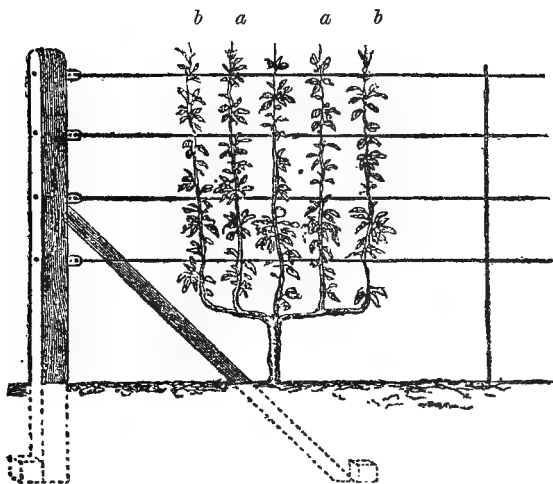

FIG. 6—A FIVE-BRANCHED VERTICAL CORDON PEAR TREE

a tree with seven branches will produce quite enough fruit of one sort. This method offers a strong contrast to espaliers on pear stocks, planted in the usual manner twenty-four feet apart and trained horizontally; nearly five trees for one will give so many additional chances to the pear cultivator; the single tree may fail, or its

fruit may become imperfect, owing to an adverse season; but out of his five trees he will in every season stand a good chance of having *some* good pears. A few words will suffice for their management: summer pinching of the lateral shoots to five leaves as recommended for pyramids (p. 5), and root-pruning or biennial removal—these operations, like Dr. Sangrado's bleeding and warm water, will do all.

Five- or seven-branched vertical cordon trees, not only of pears but of cherries on the Mahaleb stock, of plums, of American apples on the Paradise stock, and peach and apricot trees, may be planted against walls in gardens, if of a moderate height, to great advantage. As so much variety may be had in a small space, let the reader imagine himself to have a brick wall with a southern aspect, 20 feet long, and 8 or 10 feet high. According to old practice this would afford space for *one* tree; but with branched vertical cordon training, I repeat, *five* trees may be cultivated, and thus give five chances to one.

If this kind of tree on the quince stock cannot be procured, those that are trained horizontally, with five or seven branches, may be planted against the wall or fence destined for them, and their young shoots be made to curve gently, until they are perpendicular; the young shoots of pear trees are very pliable, and will easily bend to the required shape. The lower part of each shoot in such cases must be fastened to the wall with shreds and nails in the usual way,

and the remaining part trained into an upright position. If they are more than two feet, each of these shoots must then be shortened to this length. These shortened branches will, in May, each put forth two or three shoots. As soon as they have made eight or ten leaves, pinch all but one on each branch to five leaves, leaving the topmost one to each shoot. You will thus, if your tree be five-branched, have five young leading shoots, which should be carefully regulated during the summer so that no particular shoot should take precedence. This proportion must be maintained by occasional pinching or leaf-stripping. Your tree will soon reach the top of the wall, and every bud in the five branches will be perfect, either a blossom-bud or one in embryo. When this happens, commence root-pruning, unless the trees have ceased to grow vigorously and are bearing well—if so, leave their roots untouched. The directions for root-pruning are given in treating of pyramidal trees (p. 14); these may be followed exactly, and, if so, the trees will be kept in a stationary bearing state. It must be recollected that the spurs on the branches will often put forth shoots even while bearing fruit; these must be left unpruned until the autumn. In treating of the cultivation of the foregoing, I assume that trained trees of from three to four years are planted: the training and preparation of young trees would be tedious and time-consuming.

If larger trees are wished for, in order to give more fruit of each sort, trees with nine upright branches may

be planted seven feet apart, or trees with eleven upright branches, nine feet apart. Trees, however, can seldom be purchased with shoots so numerous; young trees must therefore be planted, and cut back annually for two

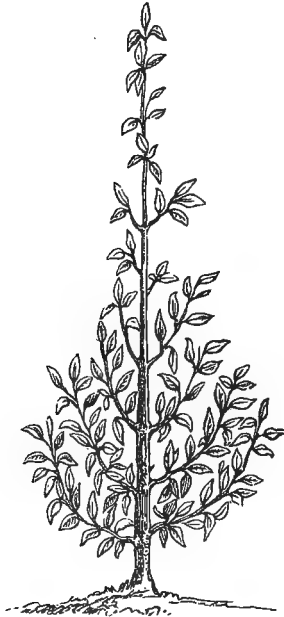

FIG. 7

or three years, till the proper number of perpendicular shoots are supplied. It may happen that trained trees with five or seven branches cannot be procured, perhaps trees with only three shoots, two horizontal and one leading shoot; in such cases they must be cut back,

leaving five buds to each shoot, and the young shoots in June trained as required.

Pyramidal trees cut flat on the side to be placed next the wall, and planted against walls or fences, will give almost a certain crop. Their shoots must be pinched, and trained so as to form a handsome semi-pyramidal tree, which when it has reached the top of the wall must be subjected to biennial root-pruning; but this will only be necessary if the tree is too vigorous, so as to keep it in a stationary fruitful state. On the preceding page I give a figure (fig. 7) of a young pyramid planted against a south-east fence.

It will, I trust, be seen how economical of space are these methods of training pears to walls; and nothing in fruit culture is more interesting than a wall of upright five-branched cordons or of pyramids full of fruit. Let us only consider that a wall 100 feet long will accommodate *five* trees on the pear stock, trained in the usual horizontal mode; the same wall will give 'ample room and verge enough' to *twenty-five* trees on the quince stock, trained perpendicularly; if their young shoots (all but the leaders) are pinched in June, no root-pruning will be needed. They are also invaluable for planting against walls between old trees, where there are bare spaces, for they soon fill up such vacancies, and bear abundance of fine fruit. A selection of varieties for wall trees will not here be out of place:—

UPRIGHT TRAINED TREES ON QUINCE STOCK

For East and South-east Walls

Madame Treyve	Beurré Bachelier
Souvenir du Congrès	Passe Colmar
Brown Beurré	Magnate
Van Mons (Léon le Clerc)	Joséphine de Malines
Glou Morceau	Monarch (Knight's)
Emile d'Heyst	Marie Benoist
	Bergamotte d'Esperen

For West and North-west Walls

Bon Chrétien, Williams'	Marie Louise d'Uccle
Jargonelle	Beurré d'Aremberg
Clapp's Favourite	Easter Beurré
Beurré d'Amanlis	Passe Crassanne
Conseiller de la Cour	Beurré Diel
Délices d'Hardenpont	Princess

For South and South-west Walls

Beurré Superfin	Van Mons (Léon le Clerc)
Louise Bonne of Jersey	Fondante d'Automne
Gansel's Bergamot ¹	Glou Morceau
Marie Louise	Duchesse d'Angoulême
Beurré Bosc	

¹ It is not generally known that this fine variety, proverbially a shy bearer, becomes, when double-grafted on the quince stock, one of the most abundant bearers.

Durondeau	Olivier de Serres
Doyenné du Comice	Bergamotte d'Esperen
Beurré d'Anjou	Easter Beurré
Beurré Rance	

The above varieties grafted on pear stocks are equally adapted for their several aspects. In shallow, gravelly, or chalky soils, pears on pear stocks are to be preferred for walls.

It is almost useless to plant dessert pears against north or north-east walls, as the fruit, unless in very warm seasons, is generally deficient in flavour. The only varieties that offer the least chance of success—and that only in a warm climate with a dry soil—are Marie Louise, Jargonelle, Louise Bonne of Jersey, Beurré Superfin. It is far better to plant against such aspects baking or stewing pears, such as Catillac, Bellissime d'Hiver, and Léon le Clerc de Laval: the Vicar of Winkfield is also a good north-wall pear—it bears well and stews well. In the north the finer sorts of pears must be cultivated on south walls.

It may seem theoretical to recommend pears on the quince stock for pyramidal trees in the north of England and in cold soils and situations, but my experience in some very cold and clayey soils in this neighbourhood enables me to feel sanguine as to the result, for I have observed that in some of the pear gardens of France many sorts are often *too ripe*.

Now this is just the tendency we require. In our

cold and moist climate most certainly pears will not get *too ripe*, more especially in the north of England and Scotland. Some years since I received a letter from a correspondent living in a hilly part of Derbyshire, from which I give an extract:—‘I have tried Beurré Diel, Beurré de Capiaumont, Marie Louise, and Williams’ Bon Chrétien, on pear stocks, all of which bear well as standards, but their fruit does not come to perfection, always remaining quite hard till it decays at the core. I have placed the fruit in a hot-house, but have never succeeded in ripening it. Williams’ Bon Chrétien we can only use for stewing.’ This seems to show that cold, hilly situations are not favourable to the cultivation of pears as standards. I have recommended some pears on quince stocks, and have heard of a favourable result.

CORDON PEARS ON TRELLISES UNDER GLASS

THIS system of pear-growing, which, I believe, will be the system of the future, from the extreme simplicity and economy with which it can be constructed and

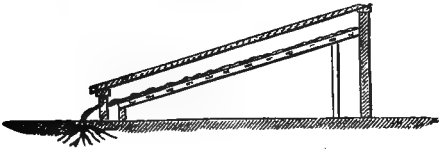

FIG. 8

adapted to all positions, was introduced some years since by Mr. Bellenden Ker for the purpose of growing

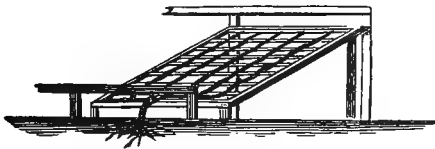

FIG. 9

peaches and nectarines on a trellis protected by movable glass lights.

Although the trellis does not give sufficient heat

and protection for the cultivation of peaches, it is admirably adapted for pears, apples, and plums. Fig. 8 is a section of the trellis, and fig. 9 is a front view of a pear tree trained to it in the upright method. The fruit grown on these trellises is remarkably fine, rivaling the best specimens of wall pears, owing to the trellis being near enough to the ground for the fruit to reap the benefit of the radiation of heat from the earth.

The lights should remain over the trees until the beginning of July, and then be removed, suffering the fruit to ripen fully exposed to the sun and air. It seems that the glass over the fruit in its young state serves to develop its growth in a remarkable manner, for rarely is a spot seen on pears grown on these trellises; they have a clear, beautiful appearance, much like those grown in the warmer parts of France. I ought to add that in cool climates, such as the north of England and Scotland, the lights may be suffered to remain over the trees till the beginning or middle of August. This will hasten the ripening of the fruit, but it should be exposed to the air in early autumn for some weeks before it is gathered, unless the climate be particularly cold and stormy, or it may suffer in flavour. Pears ripened under glass are apt to suffer in this respect. I have, however, quite recently received the following communication from a clever fruit-cultivator living in Ireland:—‘Let no one persuade you that pears grown in a well ventilated orchard-house are not

equal to those outside; I can give strong evidence to the contrary. In my house there was a small Louise Bonne on the quince stock, in an 11-inch pot; it bore twenty-three splendid pears, as far superior to the same fruit grown in the open air as it was possible to be. They were not, I admit, high-coloured, but they attained a richness and flavour that I thought Louise Bonne did not possess.'

The pear trellis, of which the section and front view (figs. 8 and 9) will give a correct idea, is of the most simple description. A row of larch or oak posts must be driven into the ground six feet apart, and another row in front; on these should be nailed plates, three inches by two, and then bars, three inches by one, placed flatwise from front plates to back three feet apart; across these common tiling laths should be nailed six inches asunder. This will form the trellis as seen in fig. 9. The supports for the lights are formed in the same manner by a row of posts at the back and the same for the front, on which are nailed plates of the same dimensions as those for the trellis; a crosspiece should be nailed to front and back plates at each end, to keep the supports for the lights from giving way. The structure with the lights, when resting on the back and front plates, has exactly the appearance of a large garden frame without back, front, or ends. Under the lights the trellis is formed with a sharp slope upwards to the back: for unless the front of the trellis is within six inches of the ground it will be

difficult to bend the trees to the required position. By this simple contrivance, pears, and even peaches and nectarines in warm gardens, may be grown in any corner of the garden, with a south or south-western exposure—for it is scarcely necessary to add that the lights should slope to the south or south-west, so as to have all the sun heat possible.

The most eligible dimensions for a trellis I find from experience to be as follows:—

Glass Lights

Eight feet long, three feet wide.

Height from ground at back, three feet six inches.

Height from ground at front, one foot six inches.

Trellis

Height from ground at back, two feet six inches.

Height from ground at foot, six inches.

Distance from glass lights, one foot.

The front border should be raised to a level with the front of trellis; this will leave twelve inches between the front ends of the lights and the surface of the front border, which will be quite enough for ventilation. Indeed, the draught in windy weather is inclined to be too sharp; I find, therefore, furze or other evergreen branches, placed along the front between the glass and the border, and a mat nailed at the back, excellent checks to excessive ventilation in cold, frosty weather. They may remain there till the beginning or end of

June, the latter if the weather be cold and stormy. The lights are fastened to the plate, back and front, by a hook and eye; they are thus easily removed to prune the trees and gather the fruit.

In the Appendix is given a diagram of a trellis recently made. Workers in iron, if applied to, would no doubt design a light iron trellis, which would probably have a more elegant look than the plan detailed here.

HORIZONTAL CORDON PEAR TREES ON DWARF WALLS

THESE four-inch walls should have a nine-inch foundation of four courses of brickwork in the ground, and should be carried up to four feet above the surface (it is scarcely safe to build them of great height), with nine-inch piers fifteen feet apart. The coping for them is made of boiling coal tar mixed with lime and sand to the consistence of mortar, which is placed on the top of the wall thus ▲ so as to carry off the water. This is a most cheap and efficacious covering—it can scarcely be called a coping, as it does not project over the edge of the wall. A coping of Portland cement is even better, as it holds the wall together.

The very best lime should be used. I have found the grey Dorking lime excellent, but any kind of lime made from limestone will answer well; that made from

chalk in this country is not strong enough. Their cost, as I learn from my bricklayer, is about six shillings a yard in length; thus a wall of the above height, twenty yards long, should cost £6.¹ In places where bricks are cheap they may be built for less; if they are dear and at a distance, their carriage will add to the expense. My walls are six feet apart, and stand end-wise; north-east and south-west; so that one side of each wall has a south-east aspect, the other a north-west; on the former may be grown the late-keeping pears, on the latter the earlier sorts that ripen from October till the end of November. We thus have one excellent aspect, the south-east; and one tolerably good, the north-west; so that no wall space is lost.

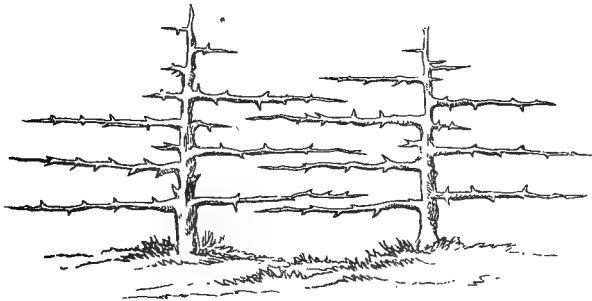

FIG. 10

The pear trees for these dwarf walls should be grafted on quince stocks trained horizontally, pruned by summer pinching as directed for five-branched vertical

¹ This estimate was made some years since; the price of labour has increased since it was given.

cordons (p. 27). They may be planted five feet apart at first, and when their branches meet they should be interlaced, as in fig. 10, and if necessary—i.e. if the shoots be long enough—they may be trained over the stems, so that the wall is completely furnished with bearing branches. At the end of five or six years every alternate tree may be removed, leaving the permanent trees ten feet apart. I advise planting thus thickly because I know from experience that the temporary trees will fill the walls, will bear a good quantity of fruit, and look more satisfactory than if they are planted thinly. When removed they may be planted out for espaliers, or fresh walls built for them.

If, owing to the soil being rich, the trees are inclined to grow vigorously and not bear, they should be lifted biennially, or root-pruned; but pears on quince-stocks will be sure to bear abundantly.

The dwarf walls, when covered with well-trained trees, have a neat and charming effect, and the trees may be easily protected by sticking branches of evergreens in the ground and letting them rest against the wall, or by cheap glass lights, in lieu of shutters, placed against the walls, and suffered to remain so as to cover the trees till the fruit is fully formed, or till the first week in June, when all fear of damage from frost is over.

Where two or more walls are built, or a square piece of ground devoted to them, a cross wall or walls should be built at the north-east end, to prevent the

sharp current of wind from the north-east, which would blow up the intervals between the walls with great violence. It is surprising what a quantity of fruit may be grown on a small space of ground with the aid of these walls. Peaches, nectarines, and apricots may be grown on the south-east aspect, but the trees must be kept in check by biennial removal. They seem to me more particularly suited to suburban, or what are commonly called cockney, gardens. How pleasant to be able to have a brick wall twenty yards long for £6, or ten yards long for £3; and how delightful to be able to grow one's own 'wall-fruit'! On a wall ten yards long, five peach and nectarine trees may be trained, and many dozens of fruit produced annually. These dwarf walls for the cultivation of peaches, nectarines, and apricots must, however, differ from those for pear trees, and be built so as to give a south or south-west aspect for the front, a north or north-east for the back. The latter may be planted with Morello cherries. To carry out the cultivation of the above-mentioned trees on dwarf walls, it is absolutely necessary to take them up biennially in November and replant them in the same place.¹ They will not require any compost to their roots, for peach, nectarine, and apricot trees are generally by far too vigorous in their growth. In some of the London suburban gardens the soil is so rich that

¹ It is a prudent practice, in all cases of biennial removal, to remove half the number of trees in alternate years, for in dry seasons those recently removed may be too much checked in their growth to bear a crop of fruit the first season after removal.

annual removal, *particularly with apricots*, may be found to be quite necessary. In country gardens, where the soil is poor, a dressing of manure on the surface over the roots two inches deep will be of service.

A matter of great consequence in peach-tree culture on walls is to keep the surface of the soil solid; if, therefore, the trees grow too vigorously, so as to require removal, say in October, the soil, after the tree is planted, should, after becoming dry, be rammed with a wooden rammer, so as to be as solid as a common garden path. In spring this hard surface should be covered with a slight coat of thoroughly decayed manure, which will be all the culture required.

ESPALIER PEARS ON QUINCE STOCKS

PEARS on the quince may be cultivated as horizontal espaliers or cordons by the sides of walks, or trained to lofty walls with much advantage, as less space is required. Horizontal espaliers or wall trees on the pear stock, trained to walls of the usual height, i.e. from ten to twelve feet, require to be planted twenty feet apart, while those on the quince may be planted only ten feet apart; this, in a small garden, will allow of much greater variety of sorts to supply the table at different seasons. With these the same high culture, if perfection be wished for, must be followed: the trees carefully

planted, so that the junction of the graft with the stock is even with the surface of the mould formed as directed for pyramids. The pruning of wall pear trees has always been a subject of controversy with gardeners, as they are inclined to grow too vigorously. If it be thought desirable to have trees of large growth, so as to cover a high wall, and yet be highly fertile, it is much better to root-prune than to prune the branches. With such trees it need not be done so severely; biennial root-pruning will be quite sufficient, commencing at eighteen inches from the wall after the tree has had two seasons' growth, cutting off the ends of all the roots at that distance from the wall, and increasing it by six inches at every biennial pruning, till a distance of six feet from the wall is reached. When this is the case the roots must be confined to the border of that width by digging a trench biennially, and cutting off all the ends of the roots at that distance from the wall.

I may, perhaps, make this more plain by saying that a tree planted in November 1890 should have its roots shortened eighteen inches in November 1892, to twenty-four inches in 1894, to thirty inches in 1896, to three feet in 1897, and so on, leaving six inches biennially till, say, a distance of six feet from the wall is reached in 1899. This border, six feet wide, will then be full of fibrous roots.¹ It should never be dug or cropped, but

¹ If the wall to which the trees are trained be twelve feet and upwards in height, the border should be eight, and even ten, feet in width. Wide and shallow fruit-tree borders are much to be preferred to those that are deep and narrow.

annually have a surface-dressing of manure about two inches in thickness; and, as I have before said, have a trench dug biennially eighteen inches deep, six feet from the wall, and the end of every protruding root cut off. If this method be followed, and summer terminal pinching of the leading branches be practised, the pruning will be simplified. The first shoots in June should be stopped as soon as seven leaves are produced, and the remainder of the pruning left until October, with the exception of occasionally removing shoots which are too crowded. The branches of the horizontal-trained trees will then form cordons issuing from one main stem; and this form of training, with all due deference to our Gallic neighbours, has been practised here for many years, although we did not give it a popular name.

In forming borders for wall pear trees on quince stocks, biennially root-pruned, the soil should be well stirred with the fork to a depth of eighteen inches, and if it be poor, a good dressing of rotten manure or leaf mould should be mixed with it. Lime rubbish or gypsum is a necessary compost. Pears on quince stocks are much better adapted for this mode of culture than those on pear stocks. If the latter be planted, the border, six feet wide, should have a thick layer of concrete at bottom, to prevent the roots striking downwards; or it would be good practice to place, eighteen inches deep under each tree, a flat piece of stone three feet in diameter; this would force the roots to take a horizontal direction, and facilitate the operation of root-pruning.

For fine specimens of wall pear trees grafted on the quince, I may refer to those on the west wall of the Royal Horticultural Society's Gardens at Chiswick. These are now more than forty years old, and are pictures of health and fertility, thus at once settling the question respecting the early decay of pear trees grafted on the quince; for it has been often, very often, urged as an objection to the use of the quince stock, that pears grafted on it are, although prolific, but very short-lived. I have seen trees in France more than fifty years old, and those above referred to may be adduced to confute this error.

PEAR TREES TRAINED AS SINGLE VERTICAL CORDONS

THIS is, perhaps, the most simple of all methods for economising space, and is in reality a very primitive form. Plant either one- or two-year-old trees, three feet apart, in quincunx or rows. If the trees are weak, and cannot make an upright growth without assistance, fasten them to a stake. Prune, when planted, about three or four buds from the top, and leave them for the first year without further pruning until October, when the summer shoots of the trees must be pruned to the lowest wood bud nearest the stem ; the pruning is then complete for the first year. The second year the trees will produce lateral shoots from all parts of the main stem. In June, pinch the terminal bud of all these shoots when they have arrived at six to seven leaves, and prune no more until the end of September, when the leaf begins to fall.

For small gardens, where the cultivator wishes for a large collection of pears in a small place, this—which is, in fact, the cordon system applied to single-stemmed trees—is much to be recommended.

Fig. 20 is a single cordon apple tree from a speci-

men growing here (single cordon pear trees require the same culture), and will, perhaps, give the reader a correct idea of the adaptability of these compact trees for small gardens ; they may be planted two feet apart.

DIAGONAL SINGLE CORDONS

THE diagonal single cordon is the most simple of all the methods supported by various writers on training. It consists merely of planting a dwarf tree with one shoot about 18 to 20 inches apart at an angle of 45° (fig. 11). The first year after planting, the side shoots should be pinched in June to five leaves, and pruned again in October to three buds from the base. This pruning includes the second growth from the first pruning. If the tree, as it often does, produces bloom spurs, do not prune them, as the tree will not be injured by precocity in fruiting. The third and fourth years will require the same treatment—that is, pinch in June and then refrain from any other pruning until October ; the trees will look a little ragged and untidy, but this will be remedied by the late pruning. Diagonal cordons of pears, plums, cherries, apples, and apricots may be cultivated with success when trained against walls with south-west and all other aspects, except north or north-east.

There is perhaps no wall-fruit tree so likely to be

largely benefited by single diagonal training as the apricot. Every gardener knows the wretched disappointment often felt in summer by large and apparently healthy branches of their apricot trees dying off suddenly, and leaving them without any remedy—for the gap made cannot be filled, owing to the rigidity of the remaining branches. There is, therefore, no

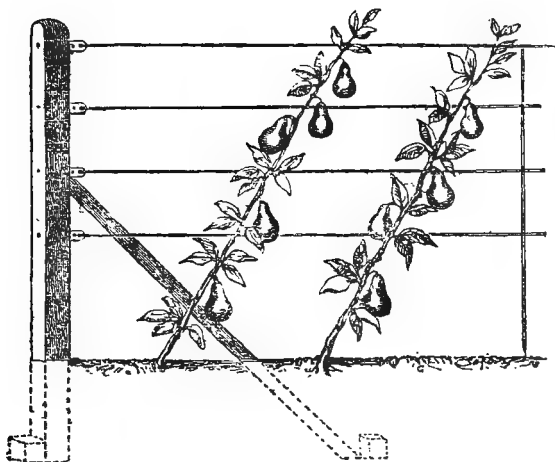

. FIG. 11

remedy for this failure of apricot trees when trained to walls in the usual manner; but there is a sure method of avoiding it—simple enough: it is by planting single diagonal cordon trees, which may be maiden trees with a single stem, or trees in a bearing state from the nursery. In planting, if the tree is slender, it is usual to keep the stem of the stock as nearly upright as

possible; but as the graft is often too stiff to bend readily, the tree may be planted slopingly.

Single diagonal apricot trees require a south or south-west aspect, and should be planted eighteen to twenty inches apart, and every shoot pinched in during the summer, as directed for cordon pear trees (p. 48), and the same directions as to reducing and thinning out the fruit spurs in winter are necessary. The leading shoot need not, as a general rule, be shortened till it reaches the top of the wall, as the shoot of an apricot tree is generally so robust and full of buds. A single diagonal apricot tree, sloped to an angle of 45° or so, will, when it reaches the top of a wall ten feet in height, be a cordon fifteen feet in length. A wall twenty feet long will thus give space enough for ten or twelve trees, which in the course of two or three years will bear large quantities of fruit. One most important advantage, I repeat, is held out by this mode of culture: no unseemly gaps need be seen, owing to the death of branches, as in the present mode; for whenever a tree dies—a very uncommon event—it may be at once replaced. The expense of ten trees instead of one may be urged by the planter, costing 15s. instead of 7s. 6d. for one well-trained tree. I have only to remark that when the system is fully carried out the demand will be met by a much cheaper supply, and it must be recollected that it gives a tenfold advantage over the old method of training.

Above all, it does away with the tiresome annual

necessity of 'laying in' shoots, and pruning and nailing in winter; if not tied to wires fixed to the wall the diagonal cordon can be fastened by three or four shreds, care being taken that the shreds are not lurking-places for insects.

Peaches and nectarines trained as diagonal cordons against walls with a south or south-west aspect are worthy of a trial, but only in the warmer parts of England.

The system of single diagonal training is so simple that one feels assured of its being widely spread among amateur gardeners, who seem likely to lead the sound gardening taste of England. It must, however, be recollected that, although such trees trained against a wire fence are pleasant to look at, they require protection from spring frost, our great enemy.

The making of these wire fences for diagonal cordons is very simple. Straining posts of oak, five inches by two and a half, are placed firmly in the ground, twenty feet apart; between these, at six feet apart, are the perforated, flat, slight iron bars used to support wire fences: the wire may be stout iron wire the thickness of whipcord, which should be painted with coal-tar and lime, or if galvanised no painting will be required. The lowest wire is eighteen inches from the surface of the soil, and the other wires are one foot apart, as high as required; but six, seven, or eight feet will be found high enough. Fig. 11 will give an idea of diagonal cordon training on a wire

fence. My trees, planted from fifteen to eighteen inches apart, are models of beauty, far surpassing espalier training, and giving more fruit in the same space. For boundary fences in the kitchen garden I know of nothing more desirable or more economical than a diagonal cordon fence covered with trees full of fruit.

The double trellis is made precisely in the same manner as the single trellis, but the addition of horizontal iron bars, fastened to the straining posts, one foot in length, gives the power of placing two rows of wires instead of one, thus economising space, and by using the same straining posts the means of gaining twice the produce is afforded; the additional expense being the iron strainers and the wires.

In cultivating pears or any other fruit trees on trellises, I recommend digging a trench parallel to the trees, about eighteen inches from the stem, and from one foot to eighteen inches in depth. This should be filled with rotten manure and loam, and should be used as a permanent root border, an alternate parallel trench being dug to supply the fresh and to receive the used-up soil. It will, I think, be understood that this system will provide fresh food for the roots of the trees, and will also form a modified system of root-pruning; the roots will be found to grow luxuriantly and will not travel far. The soil taken from the trellis trench will serve again in alternate years, as it will have had a fallow, and if the surface is dressed with manure and

lime, it will be in all respects equal to virgin soil. Care must be taken to make the trellis trench firm and solid, as the roots of trees dislike a loose soil.

I may here suggest that prisoners could make protecting mats for fruit trees at a cheap rate. These may be light, strong, and durable. The material of which they are made will be thick enough to prevent damage from the severe frosts in April and May, months when the blossoms or the young fruit suffer most.

PEAR-TREE HEDGE

A FEW years since, when visiting a friend at Fontenay-aux-Roses, near Paris, I was much struck with a hedge formed of pear-trees on the quince stock. He smiled when he told me his method of cultivation and pruning, the latter being simply clipping his hedge in July with the garden shears,¹ and thinning out the spurs in winter when they become crowded. When my friend paid me a visit, I inquired, with some interest, about his pear-tree hedge. He assured me that it was perfectly healthy, and generally gave him large crops of fruit. The sorts proper to form a hedge are Louise Bonne of Jersey, Beurré d'Amanlis, Beurré Hardy, Conseiller de la Cour, Beurré d'Aremberg, Beurré Superfin, and

¹ An English cultivator would employ pruning scissors to shorten the shoots, and thus make his hedge look as if cared for.

Doyenné du Comice. These are all free growers on the quince stock, and if planted in a favourable soil and climate would soon form a fruitful hedge. They should be planted about thirty inches apart, and in masses, i.e. planting, say, ten of each sort together. A hedge may be formed, varying more in its aspect by planting one or two trees of each sort in succession—this is a mere matter of taste. A pear-tree hedge when in full bloom has a very agreeable look, and when full of fruit is very profitable.

PYRAMIDS ON THE PEAR STOCK

THERE are some dry, warm, shallow soils, more particularly those resting on chalk or gravel, which are unfavourable to the pear on the quince stock; it is difficult to make them flourish unless great care is taken in mulching the surface, and giving them abundance of water and liquid manure in summer. In such soils pyramids on the pear stock may be cultivated with but little trouble.

To those who wish to train them as they should grow, one-year-old grafted plants may be selected, which may be managed as directed for young pyramids on the quince stock. If trees of mature growth are planted, they will require the treatment recommended for pyramids on the quince stock, but as they are more vigorous in growth excessive summer pinching must be

avoided. The strong laterals should have the terminal bud nipped in June and the rest of the pruning completed in September. There is no occasion, however, to make a mound up to the junction of the graft with the stock, as the pear does not really emit roots. *Annual* root-pruning is almost indispensable to pyramids on pear stocks in *small* gardens, and it will much facilitate this operation if each tree be planted on a small mound; the roots are then so easily brought to the surface. This annual operation, which should be done in November, may be dispensed with in soils not rich, if the trees be lifted biennially in that month and replanted, merely pruning off the ends of any long roots. Annual surface manuring, as recommended for pyramids on the quince, is also necessary, if the trees be root-pruned or biennially removed.

Trees of the usual size and quality may be planted, and suffered to remain two years undisturbed, unless the soil be rich and they make vigorous shoots (say eighteen inches in length) the first season after planting, in which case operations may then commence the first season. Thus, supposing a tree to be planted in November or December, it may remain untouched two years from that period; and then as early in autumn as possible a circumferential trench, twelve inches deep, should be dug, and every root cut with the knife and brought near to the surface, and the spade introduced under the trees so as to completely intercept every perpendicular root.

The treddle spade used in this part of Hertfordshire is a very eligible instrument for this purpose, as the edge is steeled and very sharp. The following year, the third from planting, a trench may be again opened at fifteen inches from the stem, so as not to injure the fibrous roots of the preceding summer's growth, and the knife and spade again used to cut all the spreading and perpendicular roots that are getting out of bounds. The fourth year the same operation may be repeated at eighteen inches from the stem; and in all subsequent root-pruning this distance from the stem must be kept. This will leave enough undisturbed earth round each tree to sustain as much fruit as ought to grow, for the object is to obtain a small prolific tree.

I find that in the course of years a perfect mass of fibrous roots is formed, which only requires the annual or biennial operation (the former if the tree be very vigorous) of a trench being dug, and the ball of earth heaved down to ascertain whether any large feeders are making their escape from it, and to cut them off. But it must be borne in mind that this soil will in a few years be exhausted; to remedy which a shallow trench should be made round the tree about eighteen inches from the stem: this should be filled in with a dressing of night soil and burnt earth in December or January. This manure is raw and powerful and very unsavoury, but it will not come into contact with any active roots until it has lost its pungency. Other liquid

manures are equally useful, but the above is easily obtained and applied. I must firmly impress upon the reader the strong necessity of applying lime or chalk to soils deficient in this deposit; I believe that many so-called exhausted borders require only the addition of lime in some form or other to renovate decaying trees.

Gas lime after an exposure to the air, superphosphate, gypsum, lime rubbish, or chalk will all be found to act beneficially.

There is no absolute necessity for liquid manuring in the winter, as common dung may be laid round each tree in autumn, and suffered to be washed in by the rains in winter and drawn in by the worms. The great end to attain seems (to use an agricultural phrase) to be able to 'feed at home'; that is, to give the mass of spongioles enough nutriment in a small space. A tree will then make shoots from eight to ten inches long in one season (for such ought to be the maximum of growth), and at the same time be able to produce abundance of blossom-buds and fruit. On trees of many varieties the former will be in too great abundance; removing a portion in early spring, cutting them out with a sharp knife so as to leave each fruit-spur about three inches apart, is excellent culture.

I have not yet mentioned the possibility of root-pruning fruit trees of twenty or thirty years' growth with advantage. Irregular amputation of the roots

of too vigorous fruit trees is, I am aware, an old practice; but the regular and annual or biennial pruning of them, so as to keep a tree full of youth and vigour in a stationary and prolific state, has not, that I am aware of, been recommended by any known author, although it may have been practised. In urging its applicability to trees of twenty or thirty years' growth, I must recommend caution: the circular trench should not be nearer the stem of a standard tree than three feet, or, if it be a wall tree, four feet, and only two-thirds of the roots should be pruned the first season, leaving one-third to support the tree, so that it cannot be blown on one side by the wind, and these of course must be left where they will best give this support. The following season half the remaining roots may be cut, or, if the tree be inclined to vigour, all of them; but if it gives symptoms of being checked too much, they may, on the contrary, remain undisturbed for one, or even two seasons. If, as is often the case in pear trees, the roots are nearly all perpendicular, the tree must be supported with stakes for one or two years after complete root-pruning.

The following extract from a letter received from the late C. Roach Smith, Esq., the archæologist, is interesting, as showing the prompt effects of root-pruning of trees:—‘I have only been a horticulturist for three years; I took to two very beautiful *old* pear trees, which must have cost no end of nailing, cutting, and staking. On inquiry, I found that one (a Summer

Bon Chrétien) had never produced more than *one pear* annually; the other upon a north wall had *never* given a single pear. I could get no aid from anyone what to do with those trees, and no book then accessible helped me. I reflected on the natural habit of the pear tree, and coming to the conclusion that the cause of barrenness was exuberance of roots, I resolved to cut them. Before the leaves had fallen, a friend sent me "The Retired Gardener," an old book translated from the French. In it I found an account of some experiments made in England which fortified me in the resolution I had taken. The first year the Summer Bon Chrétien¹ produced nine fruit. I pruned the roots more closely, and this year (1859), in spite of the ungenial spring, I saved fifty-nine pears. The other tree yielded thirty-six, but of so vile a quality that I have re-grafted the tree. A large plum treated in the same way produced the season after being root-pruned 2,000 fruit.'

It will not, perhaps, be out of place here to enumerate a few of the advantages of systematic root-pruning and removing or lifting of pear, apple, and plum trees, and of growing them as pyramidal trees and bushes.

Firstly. Their eligibility for small gardens, even the smallest.

Secondly. The facility of thinning the blossom-buds, and in some varieties, such as Gansel's Bergamot

¹ This is one of our oldest varieties, and remarkable for being a very shy bearer.

and other shy-bearing sorts, of setting the blossoms and of thinning and gathering the fruit.

Thirdly. Their making the gardener independent of the natural soil of his garden, as a few barrowfuls of rich mould with annual manure on the surface will support a tree for many, very many years, thus placing bad soils nearly on a level with those the most favourable.

Fourthly. The capability of removing trees of fifteen or twenty years' growth with as much facility as furniture. To tenants this will indeed be a boon, for perhaps one of the greatest annoyances a tenant is subject to is that of being obliged to leave behind him trees that he has nurtured with the utmost care.

Probably in judicious root-pruning and annual manuring on the surface, so as to keep our fruit trees full of short, well-ripened, fruitful shoots, we are all inexperienced.

Root-pruning was practised with success in a garden near where for some years a healthy peach tree was never seen, as the subsoil is a cold white clay, full of chalk stones. This change was brought about by biennially pruning the roots of the trees early in autumn, as soon as the fruit was gathered; in some cases lifting the trees and supplying their roots with a dressing of leaf-mould, sand, and rotten manure, equal parts. Powdered charcoal, or the ashes of burnt turf and rotten manure, also make an excellent root-dressing for cold heavy soils; but if the soil be dry and poor, and unfavourable to the peach and nectarine, loam and

rotten manure is the best dressing for the roots, and also for the surface.

PLANTING AND AFTER MANAGEMENT

PYRAMIDAL pear trees of from three to five years old on the quince stock, root-pruned, and full of blossom-buds, may be purchased. Trees of this description should, if possible, be planted before Christmas; but if the soil be very tenacious, the holes may be opened in the autumn, and the trees planted in February; the soil will be mellowed and benefited by the frosts of winter.¹

Pear trees grafted on the quince stock offer a curious anomaly; for if they are removed quite late in spring—say towards the end of March, when their blossom-buds are just on the point of bursting—they will bear a fine, and often an abundant, crop of fruit. This is sometimes owing to the blossoms being retarded, and thus escaping the spring frosts; but it has so often occurred here when no frosts have visited us that I

¹ The roots of pear trees on the quince stock, and, indeed, of all root-pruned trees, are very fibrous. In planting, it is good practice to give each tree two shovelfuls of fine earth or mould rather dry—to place it on the roots and shake the tree, so that the mould is mixed with the mass of fibrous roots. Before the soil is all filled in, three or four gallons of water should be poured in, so as to wash the earth into every crevice. The roots should not be crammed into a small hole. A tree with its roots eighteen inches in diameter will require a hole $2\frac{1}{2}$ feet in diameter, and so on in proportion.

notice it—in fact, no trees bear late removal so well as pears on quince stocks.

In planting pear trees on the quince stock, it is quite necessary that the stock should be covered up to its junction with the graft. This joining of the graft to the stock is generally very evident, even to the most ignorant in gardening matters; it usually assumes the form as given in fig. 12, *a*.

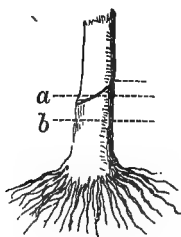

FIG. 12.— *a*, Junction of the graft with the stock. *b*, the point up to which the stock should be covered.

If the soil be not excessively wet, the tree may be placed in a hole, say three feet in diameter and eighteen inches deep, in the usual way, so that the upper roots are slightly above the level of the surface, as the tree will always settle down two or three inches the first season after planting. Some light compost should be filled in, and the tree well shaken, so that it is thoroughly mingled with its roots. The compost must then be trodden down; and so far the planting is finished. The earth should then be placed round the stem, and formed into a mound, which should cover the stock up to, *but not above*, the junction of the graft with the stock, in order

to encourage it to emit roots into the surface soil, and to keep it (the stock) from becoming hard and 'bark-bound.'

As the mounds will subside by the heavy rains of winter, presuming that the trees have been planted in autumn, fresh compost of the same nature must be added in spring, and every succeeding autumn. A quarter of a peck of soot, strewed on the surface in a circle three feet in diameter round each tree in March, is an excellent stimulant. The great object in the culture of the pear on the quince stock is to encourage the growth of its very fibrous roots at the surface, so that they may feel the full influence of the sun and air. The slight mounds recommended may be made ornamental, if required, by placing pieces of rock or flint on them, which will also prevent the birds scratching at them for worms; but the stones selected must not be very large and heavy—they should be about the size and weight of a brick. In light friable soils, the mounds may be from three to four inches above the surface of the surrounding soil; in heavy retentive wet soils, from six to eight inches will not be found too high.

In soils of a light dry nature the pear on the quince requires careful culture; the surface round the tree should be covered during June, July, and August with short litter,¹ or manure, and in dry weather give the

¹ A clerical amateur has informed me that this mulching or placing half-rotten manure one or two inches deep on the surface in a circle from two to three feet in diameter and one and a half inches deep, according to the size of the tree, will prevent pears cracking.

trees a drenching once a week with guano water (about one pound to ten gallons) and equal parts of soot, which must be well stirred before it is used. Each tree should have ten gallons poured gradually into the soil; by this method the finest fruit may be produced; and as it is very probable that ere many years elapse exhibitions of pears will become very popular, this will be the mode to procure fine specimens to show for prizes. I must also here repeat that lime rubbish or chalk should be applied to soils deficient in calcareous deposit; I think that all fruit trees would be benefited by a biennial dressing of superphosphate. Gas lime after an exposure of a month or two may be advantageously mixed with the surface-dressing of manure. Gypsum dissolved in water is a very efficient fertiliser.

Our oldest gardening authors have said that 'pears engrafted on the quince stocks give their fairest fruit'; and they are correct. It has been asserted that the fruit is liable to be gritty and deficient in flavour. I can only say that from my trees growing on a cold clayey soil, I have tasted fruit of Marie Louise, Louis Bonne of Jersey, and others, all that could be wished for in size and flavour.

In the course of my experience, and since the above recommendation to plant on mounds was written, I have found it good practice in *very dry* soils to plant pear trees on the quince stock with the junction of the graft just level with the surface, so as not to require mounds round their stems. The first season they should have

some manure on the surface, laid in a circle round the stem ; and the second year a shallow basin, two feet in diameter and four inches deep, should be dug round the stem, and filled with some manure about half-rotten.

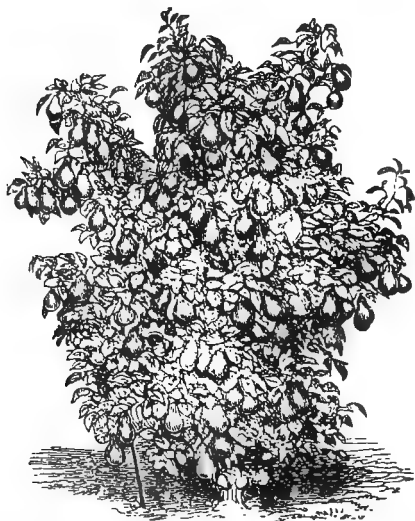

FIG. 13.—Bush pear tree in the garden of J. Meadows, Esq., Wexford. Photographed September 13, 1872. This tree, worked on the quince stock, is now 22 years old, 5 feet high, 3 feet through the centre, and 100 inches in circumference. It bears abundantly every year, and, a few days after this photograph was taken, 189 handsome pears were gathered from it.

This basin thus filled will keep moist even in the most dry and hot weather, and will become full of fibrous roots. This is also an excellent method of renovating pear trees that have exhausted themselves by bearing

too abundantly or that appear unhealthy by their leaves turning yellow. In such cases, when the trees are of advanced growth, a basin of the same depth, but three or more feet in diameter, should be formed and filled with manure; in all cases for this purpose this should be but slightly decomposed.

GATHERING THE FRUIT

THE fruit of pears, more particularly those on quince stocks, should not be suffered to ripen on the tree, the summer and autumn varieties should be gathered before they are quite ripe, and left to ripen in the fruit room.¹ The late pears should be gathered before the leaves take their autumnal tints; if suffered to remain too long on the trees they frequently never ripen, but continue hard till they rot. In most seasons, from the beginning to the end of October is a good time, but much depends on soil and climate. The following passage from that very excellent work, Downing's 'Fruit Trees of America,' is appropriate to this subject:—

'The pear is a peculiar fruit in one respect, which should always be kept in mind, viz., *that most varieties are much finer in flavour if picked from the tree, and*

¹ Pears that ripen in September and October should not be gathered all at one time, but at intervals of a week or so, making, say, three gatherings; their season is thus much prolonged.

ripened in the house, than if allowed to become fully matured on the tree. There are a few exceptions to this rule, but they are very few. And, on the other hand, we know a great many varieties, which are only second or third-rate when ripened on the tree, but possess the highest and richest flavour if gathered at the proper time, and allowed to mature in the house. This proper season is easily known, first by the ripening of a few full-grown, but worm-eaten specimens, which fall soonest from the tree; and, secondly, by the change of colour, and the readiness of the stalk to part from the branch on gently raising the fruit. The fruit should then be gathered, or so much of the crop as appears sufficiently matured, and spread out on shelves in the fruit room, or upon the floor of the garret. Here it will gradually assume its full colour and become deliciously melting and luscious. Many sorts which if suffered to ripen in the sun or open air are rather dry, when ripened within doors are most abundantly melting and juicy. They will also last for a considerably longer period, if ripened in this way, maturing gradually as wanted for use, and being thus beyond the risk of loss or injury by violent storms or high winds.

‘ Winter dessert pears should be allowed to hang on the tree as long as possible, till the nights become frosty.¹ They should then be wrapped separately in paper,

¹ I feel compelled to differ from Mr. D. in this respect, for in the autumn of 1855, I suffered many pears to hang on the trees till the end of October, and they never ripened. I believe the first week in October to be the best period to gather winter pears in.

packed in *kegs, barrels, or small boxes*, and placed in a cool dry room, free from frost. Some varieties, as the Beurré d'Aremberg, will ripen finely with no other care than placing them in barrels in the cellar, like apples. But most kinds of the finer winter dessert pears should be brought into a warm apartment for a couple of weeks before their usual season of maturity. They should be kept covered, to prevent shrivelling. Many sorts that are comparatively tough if ripened in a cold apartment, become very melting, buttery, and juicy, when allowed to mature in a room kept at a temperature of 60 or 70 deg.'

The following is from Mr. Glass's 'Gardening Book,' as given in the 'Gardener's Chronicle':—

HOW TO STORE WINTER PEARS IN SMALL QUANTITIES

'Get some *unglazed* jars—garden pots will do; make them perfectly clean, if they have ever been used. The best way is to half burn or bake them over again.

'Gather your pears very carefully, so as not to rub off the bloom or break the stalk. On no account knock them about so as to bruise them. Put them on a dry sweet shelf, to sweat. When this sweating is over, rub them dry with a soft cloth, as tenderly as if you were dry-rubbing a baby.

'As soon as they are quite dry, put them, one over the other, into the jars or garden pots, without any sort of packing; close up the mouth of the jar *loosely*, or of the garden-pot, by whelming the pan or placing a piece

of slate over it, and stow them away in a darkish closet where they cannot get the frost.

‘Open the jars now and then, to see how they are getting on.

‘Do not put more than one sort in the same jar if you can help it. Mind—the warmer they are kept, the faster they will ripen.’

KEEPING PEARS IN A GREENHOUSE

PEARS may be kept in a greenhouse, in great perfection, all the autumn.

The greenhouse in which this experiment was tried is a lean-to house with a south-west aspect, twelve feet wide, with a path in the centre, a bench in front of common slates laid on wooden bars. The pears were laid on the front bench, the glass over them shaded till the end of November, and the house ventilated; in severe frosts the temperature was kept just above freezing. The autumn and early winter pears under this treatment ripened slowly, and were of excellent flavour.

After all, I think there is no better material for preserving pears plump and sound than dry burnt earth; this never turns musty, never ferments, but seems to remain under all circumstances perfectly innocuous.

My own fruit room, in which the fruit keeps very successfully, is a span roof thatched building with a walk down the centre and benches on either side; the fruit is placed on bars of wood about one inch apart. Pears and apples keep well until their extreme limit of ripening.

Winter and very late pears will ripen well when taken from the fruit room and placed in a warmer temperature.

If the fruit is exposed to the sun under glass when gathered it will keep better than if stored immediately after picking. The exposure to the sun completes the process of ripening, and the late pears are much improved in flavour by this treatment.

PYRAMIDAL APPLE TREES ON THE PARADISE APPLE STOCK

APPLES as pyramids on the Paradise stock are objects of great beauty and utility. This stock, like the quince, is remarkable for its tendency to emit numerous fibrous roots near the surface, and for contracting the growth of the graft, causing it to become fruitful at a very early stage. On the Continent there are two varieties of the apple under this denomination, viz., the Doucin, and the Pomme de Paradis; these are called Paradise stocks in England, but on the Continent the first and last are used for distinct purposes—the first for pyramids, the latter for dwarf bushes.

The Doucin stock is probably the same as that called ‘Dutch Creeper,’ or ‘Dutch Paradise,’ by Miller, in his Dictionary, folio edition of 1759. It puts forth abundance of fibrous roots near the surface of the soil, and is not inclined to root deeply into it like the crab. Apples grafted on this stock are more vigorous than when grafted on the French Paradise stock, and less so than those on the crab; it is, therefore, well adapted for garden trees, for they are easily lifted, their roots thus

kept to the surface, and the tree consequently kept free from canker. There is another surface-rooting apple also well adapted for stocks, the Burr Knot. This, like the Doucin, will strike root, if stout cuttings, two or three years old, are planted two-thirds of their length in a moist soil; it is a large, handsome, and very good culinary apple. At Ware Park in Hertfordshire, this is called Byde's Walking-stick Apple, owing to Mr. Byde, the former proprietor of the place, often planting branches with his own hand, which soon formed nice bearing trees.

Among apples raised from seed, some will occasionally be found with this surface-rooting nature; and this is, I suspect, the reason why the Doucin stock, under the name of the Paradise, in the English nurseries, differs from the stock used as Doucins in France; there are also several varieties cultivated there, some of which are unfitted for our climate.

There are three varieties of the French Paradise, all making very dwarf trees; then come three Dutch Paradise, all much alike, but slightly more vigorous than the French sorts; next to them are two English Paradise, both of them from old English nurseries—they have much resemblance to the French Doucin stock, but are better, swelling with the graft. The Creeping Paradise is probably that mentioned by Miller, in the last century, since it is very remarkable for putting forth suckers from the roots, objectionable, but not common with the apple tribe. The Nonesuch

Paradise stock, raised here from that very old apple the Nonesuch of Queen Bess's time, is quite *sui generis*, for it has downy leaves and a knotted stem, but is wonderfully fertile. The Broad-leaved Paradise, also raised from seed here, is the best variety of the Doucin stock. The Miniature and Pigmy Paradise, both raised from seed here, have the dwarf habit of the French Paradise.

The Pommier de Paradis, or the French Paradise, seems identical with the 'dwarf apple of Armenia,' referred to in the 'Journal of the Horticultural Society,' part ii. vol. iii. p. 115. It is *exceedingly* dwarf in its habit, and too tender for this climate, unless in very warm and rich soils. Out of 2,000 imported in 1845, more than half died the first season, and two-thirds of the remainder the following. They were planted in fine fertile loam, favourable to the growth of apples, and on which the Doucin, planted the same season, grew with the greatest vigour. The same result attended an importation in 1866. I have potted some plants, and owing, as I suppose, to the roots being warmed through the pots by exposure to the sun, they make very nice little fruitful bushes—in fact, real miniature apple trees, bearing fruit when only nine inches in height; to have healthy fertile trees, I should recommend them to be gradually shifted into fifteen-inch pots. The citizen may thus have his apple orchard on the leads of his house.

The Nonesuch and Broad-leaved Paradise stocks,

before mentioned as my seedlings, are most deserving of our attention as stocks for forming fruitful healthy pyramids and bushes, the culture of which is very simple. Grafted trees of one, two, or three years' growth, with straight leading stems, well furnished with buds and branches to the junction with the stock, should be planted. No manure should be placed to their roots, but some light friable mould should be shaken into them, the earth filled in, trodden down, and two or three shovelfuls of half-rotten manure laid on the surface round each tree. This surface-dressing may be given with advantage every succeeding autumn. If the soil be very wet and retentive, it will be better to plant the trees in small mounds; and if symptoms of canker make their appearance, their roots should be examined annually in the autumn, as recommended in root-pruning of pears on the quince stock, introducing the spade directly under the roots, so as to prevent any entering deeply into the soil, and bringing all as nearly to the surface as possible, filling in the trench with light friable compost; or the tree may be lifted and replanted, which will be found more efficient.

If the soil be unfavourable, and apt to induce a too vigorous growth in apple trees, followed by canker, the roots should be annually root-pruned, or the trees lifted—i.e. taken up and replanted. If, however, the trees make shoots of only moderate vigour, and are healthy and fruitful, their roots may remain undisturbed; pinching their shoots in summer, as directed

for pyramidal pears, p. 10, and training them in a proper direction, is all that they will want. Pyramids on the Paradise stock may be planted six feet apart in confined gardens; six feet will give them abundance of room; but if, owing to the soil being of an extra fertility, they are found to require more, the trees, if they have been root-pruned, may be removed, almost without receiving a check, even if they are twenty years old. This is a great comfort to the amateur gardener who amuses himself with improving his garden; for how often does a favourite fruit tree, which cannot be removed, prevent some projected improvement!

Apples differ greatly in their habits of growth; some are inclined to grow close and compact, like a cypress—these are the proper sorts for pyramids; others, horizontally and crooked—these should be grown as bushes; others again are slender and thin in their growth, so that, to form a good pyramid of these slender-growing varieties, it is necessary to begin the first year with a young tree, and to pinch the leader as soon as it is six inches long. If by any neglect the lower part of the pyramid be not furnished with shoots, but have dormant buds, or buds with only two or three leaves attached, a notch must be cut, about half an inch in width, just *above* the bud from which a shoot is required. The notch must be cut through the outer and inner bark, and alburnum, or first layer of wood; and if the shoot or stem be young—say from two to four inches in girth—it may be cut

round half its circumference. If this be done in spring or summer, the following season a shoot will generally make its appearance; sometimes even the first season, if the stem or branch be notched early in spring. This method of producing shoots from dormant buds may be applied with advantage to all kinds of fruit trees, except the peach and nectarine, which are not often inclined to break from a dormant bud.

Varieties of apples, inclined to be compact and close in their growth, form very handsome pyramids; but they are apt to be unfruitful, as air enough is not admitted to the interior of the tree. This may be easily amended by bringing the lateral shoots down to a horizontal position for a year or two, and fastening the end of each shoot to a stake; an open pyramidal shape will thus be attained, which the tree will keep. Other varieties put forth their laterals horizontally, and some are even pendulous. The leading perpendicular shoot of varieties of this description should be supported by a stake, till the tree is of mature age. Iron rods, about the size of small curtain-rods, are the most eligible; these, if painted with coal-tar and lime, sifted and mixed with it to the consistence of very thick paint, put on boiling hot, are permanent.

Apple trees in confined gardens near large towns are often infested with 'American blight,' *aphis lanigera*; this makes its appearance on the trees generally towards the middle of summer, like patches of cotton-wool. There are many remedies given for this pest;

the most efficacious I have yet found is soft soap dissolved in soft water, two pounds to the gallon, or the Gishurst compound, sold by Price's Candle Company, one pound to the gallon, and applied with an old painter's brush. Where this pest shows itself, the branches should be painted in the autumn, after the fall of the leaf, with paraffin, care being taken to rub this well into the angles of the branches.

Here let me impress upon the lover of his garden, living anywhere within the reach of smoke, the necessity of using the syringe; its efficacy is not half appreciated by garden amateurs. As soon as the leaves of his fruit trees are fully expanded, every morning and every evening, in dry weather, should the attentive gardener dash on the water with an unsparing hand—not with a plaything, but with the perforated common syringe, such as a practical gardener would use, capable of pouring a sharp stream on the plant, and of dislodging all the dust or soot that may have accumulated in twelve hours. For apple and pear trees in pots, or in small city gardens, this syringing is absolutely necessary.

Pinching the shoots of pyramidal apple trees, and, indeed, exactly the same method of managing the trees as given for pyramidal pears on the quince stock, may be followed with a certainty of success; and the proprietor of a *very* small garden may thus raise apple trees which will be sure to give him much gratification. To have fine fruit the clusters should be thinned in

June ; and small trees should not be overburdened, for they are often inclined, like young pear trees on the quince stock, to bear too many fruit when in a very young state : the constitution of the tree then receives a shock which it will take two or three seasons to recover. For varieties with large fruit, one on each fruit-bearing spur will be enough ; if a small sort, from two to three will be sufficient.

There are so many really good apples that it is difficult to make a selection ; the following sorts will not disappoint the planter ; but fifty varieties in addition, quite equal in quality, could be selected.

Dessert apples, placed in the order of their ripening

Mr. Gladstone	Cox's Orange Pippin
Red Joannetting or	Mother
Margaret	Nonpareil
Devonshire Quarrenden	Braddick's Nonpareil
Kerry Pippin	Duke of Devonshire
Benoni	Mannington's Pearmain
Summer Golden Pippin	Scarlet Golden Pippin
Williams's Favourite	Russet Syke House
Pine Golden Pippin	Lord Burghley
Warwickshire Pippin	Allen's Everlasting
Ribston Pippin	Melon

Kitchen apples

Lord Grosvenor	Peasgood's Nonesuch
Keswick Codlin	Bramley's Seedling
Duchess of Oldenburg	Prince Albert
Golden Spire	Tower of Glamis
Warner's King	Betty Geeson
Stirling Castle	Mère de Ménage
Cox's Pomona	Dummelow's Seedling
Echlinville Pippin	Northern Greening
Bismark	Rymer
Blenheim Orange	Striped Beefing
Small's Admirable	Gooseberry

APPLES AS BUSHES ON THE PARADISE
STOCK

THERE are some varieties of apples that do not form, even with care, well-shaped pyramids; such sorts may be qualified as bushes when grafted on the Paradise stock, and are then excellently well adapted for small gardens. I have, indeed, reason to think that a great change may be brought about in suburban fruit culture by these bush trees. I have shown, in pages 20 to 25, how bush pears on quince stocks may be cultivated. Pears are, however, a luxury; apples and plums are necessities for the families of countless thousands

living near London. Apple bushes, always very pretty and productive trees, may be planted six feet apart, row from row, and four feet apart in the rows. If two or three years old when planted, they will begin to bear even the first season after planting. They should be kept from the attacks of the green aphid in summer



FIG. 14

by dressing the young shoots with quassia mixture, given in a note to page 115, and from the woolly aphid by Gishurst Compound, fir-tree oil, or paraffin, mentioned in page 77. The principal feature in this culture is summer pinching, which must regularly be attended to, once in June, and once at the end of September; this is done by pinching or cutting off the terminal bud of

every shoot as soon as it has made five or six leaves, leaving from four to five *full-sized* ones. After September no more pruning is necessary until the winter. The final or winter pruning should be done in October at the close of the growth; if deferred until November the wood is liable to injury from frost. Some varieties of the apple have their leaves very thickly placed on the shoots; with them it is better not to count the leaves, but to leave the shoots from three and a half to four inches in length. If the soil be rich and the trees inclined to grow too vigorously, they may be removed biennially, as recommended for bush pears, by digging a circular trench one foot from the stem of the tree, and then introducing the spade under its roots, heaving it up so as to detach them all from the soil, and then filling in the earth dug from the trench and treading it gently on to the roots. The following sorts are well adapted for this bush culture, but the upright varieties recommended for pyramids form nice compact bushes.¹

Dessert

Mr. Gladstone	July, Aug.
Irish Peach	August
Kerry Pippin	Aug. Sept.
Devonshire Quarrenden . . .	September

¹ These dwarf bushes are liable to be gnawed by rabbits and hares in exposed gardens. The best of all preventives is to paint them with soot and milk, well mixed, or, still better, make a fence of galvanised wire netting round the garden in which they are planted.

Wyken or Warwickshire Pippin	Sept. Oct.
King of the Pippins	Oct. Nov.
Blenheim Orange	Nov. Dec.
Ribston Pippin	Nov. Dec. Jan.
Cox's Orange	Nov. Dec. Jan.
Braddick's Nonpareil	Dec. Jan.
Mannington's Pearmain	Jan. Feb. Mar.

Kitchen

Lord Grosvenor	August.
Keswick Codlin	Aug. Sept.
Golden Spire	Aug. Sept.
Duchess of Oldenburg	Aug. Sept.
Ecklinville Seedling	Aug. Sept.
Warner's King. . . .	Sept. Oct.
Stirling Castle	Sept. Oct. Nov.
Northern Greening	Dec. Jan. Feb.
Tower of Glammis	Jan. Feb.
Dummelow's Seedling	Feb. Mar. Apr.

There is no mode of apple culture more interesting than bush culture. On page 84 I annex a sketch of a plantation of Cox's Orange Pippin (fig. 15), of one hundred trees; they were planted in the spring of 1862. They bore a fine crop in 1863 of most beautiful fruit, and in 1864 gave a crop almost too abundant. I have been obliged to move this small orchard.

APPLES AS BUSHES FOR MARKET GARDENS

IN a well-ordered fruit garden every kind of fruit should have its department, every kind should have its allotment—apples on the Paradise stock, ditto on the crab stock, pears on the quince stock, the same on the pear stock. Morello cherries as pyramids on the Mahaleb stock—the best of all methods for their culture—and the various kinds of the Duke cherries on the same kind of stock. Heart and Bigarreau cherries on the common cherry stock, plums as bushes, pyramids, or half standards, should all be separated.

I have been led into these remarks on market garden fruit-tree culture by my own experience, and especially into a consideration of the great improvement that may be made in the culture of apples on the English Paradise stock. On referring to page 82, the reader will find that I allude to my plantation of Cox's Orange Pippin apple trees on the Paradise stock (see fig. 15); these trees in the season of 1864—the third of their growth, and the fourth of their age—gave an average of a quarter of a peck from each tree. Some of the kinds likely to sell best in the markets, and which are most productive, are the following:—Lady Sudeley, Cox's Orange Pippin, King of the Pippins, Ribstone Pippin, Worcester Pearmain, Sturmer Pippin, Scarlet Nonpareil, Blenheim Orange, Yellow Ingestrie, and Dutch Mignonne; these

are dessert apples. The following are valuable kitchen apples, and abundant bearers :—Lord Grosvenor, New

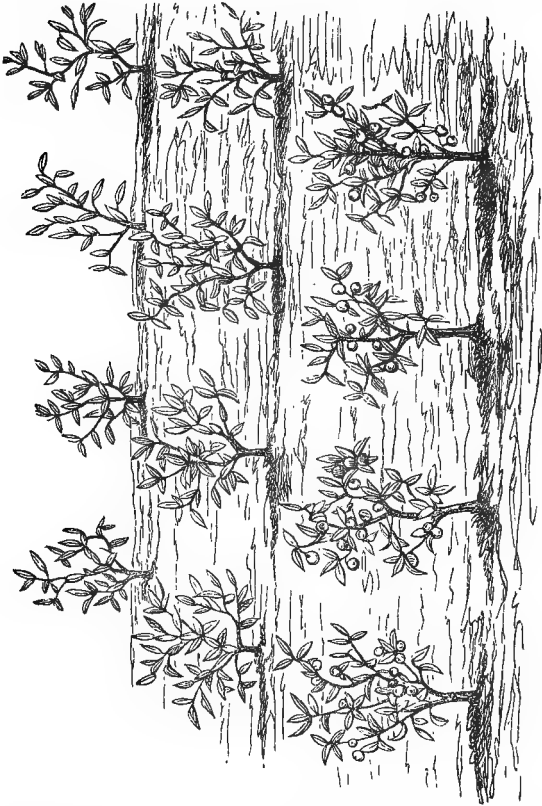

FIG. 15

Hawthornden, Stirling Castle, Cox's Pomona, Keswick Codlin, Dummelow's Seedling, Golden Spire, Norfolk Bearer, and Duchess of Oldenburg. Such large

varieties as Bedfordshire Foundling, Blenheim Orange, and Warner's King should have more space, be planted twelve feet apart, and a row of black currants or gooseberries planted between the rows, as some years will elapse before the apple trees take entire possession of the ground. One sort of apple, the Manx Codlin, grows so slowly and produces so abundantly that the plantation need not be more than six feet in the rows, and may be planted four feet plant from plant; with annual manuring large quantities may be obtained; the variety is very handsome and marketable, but it has the defect, in my soil at least, of producing fruit of irregular size. The proper method of planting and managing these bush apple trees is exactly that recommended for bush pear trees on quince stocks.

The land for these orchards should be thoroughly well cleaned before planting, and if wet and heavy should be drained. It is not necessary to trench, holes opened for the trees will answer; this should be done a month before planting; well rotted manure should be mixed with the soil previous to planting.

It will be seen that what I propose is in reality a Nursery Orchard, which may be made to furnish fruit and trees for a considerable number of years. To fully comprehend this we must suppose a rood of ground planted as I have described. In the course of eight or ten years half of these may be removed to a fresh plantation, in which they may be planted six feet apart. With proper summer pruning they will last for

many years. The great advantages reaped by the planter is the constant productiveness of his trees; from the second year after planting they will be always 'paying their way.'

The unprejudiced fruit cultivator will quickly find out the great advantage of this mode of apple and pear cultivation, and those who wish to cultivate apples and pears for market purposes may, with a sound prospect of success, if the soil and climate are favourable, plant apples on the English Paradise stock, and pears on the quince stock, either as pyramids or bushes, four and six feet apart, row from row, the former distance for dwarf prolific sorts, the latter for robust growers. This distance will admit of crops of black or red currants and gooseberries in the centre between each row for several years, until the orchard trees—which must be under summer pruning—cover the ground.

In the usual old-fashioned mode, Standard apple trees are planted in orchards at 20 feet apart, or 108 trees to the acre; if the soil be good and the trees properly planted, and the planter a healthy middle-aged man, he may hope, at the end of his threescore and ten, to see his trees commence to bear, and may die with the reflection that he has left a valuable orchard as a legacy to his children, but has not had much enjoyment of it during his life.

Plantations made at four feet apart may in the course of a few years be brought to a permanent distance for pyramidal trees, that of twelve feet apart; the trees

originally planted being removed to another plantation. They may be safely moved at two or even three years after planting, the removal being performed as early in October as practicable.

APPLES AND PEARS AS SINGLE AND DOUBLE LATERAL CORDONS

A TREE grafted on the Paradise or Doucin stock, with a single shoot, is planted in a sloping position, and the shoot trained along a wire, about ten or twelve inches from the surface. (Fig 16.)

To carry out this method of training, oak posts, about three inches in diameter and two feet in length,

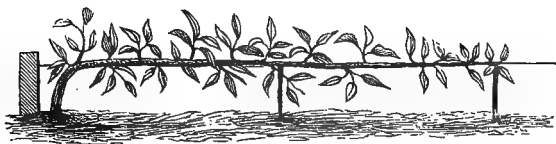

FIG. 16

should be sharpened at one end and driven into the ground, so that they stand one foot above the surface; they may be from thirty to forty yards distant from each other.

From these a piece of galvanised or common iron wire—if the latter, it should be painted—about the thickness of whipcord, should be strained and sup-

ported nine inches from the ground, at intervals of six feet, by iron pins eighteen inches long, the size of a small curtain rod, or smaller, flattened at top, and pierced with a hole to allow the wire to pass through; these should be stuck into the ground, so as to stand on a level with the straining posts. The trees should be planted six feet apart, and when the top of one tree reaches to another the young shoot may be grafted on to the base of the next, so as to form a continuous cordon. This is best done by merely taking off a slip of bark, two inches long, from the under part of the young shoot, and a corresponding piece of bark from the upper part of the stem of the tree to which it is to be united, so that they fit tolerably well. They should then be firmly bound with bast, and a bunch of moss—a handful—as firmly bound over the union; the binding as well as the moss may remain on till the autumn. The trees do not grow so rapidly as common grafts, so that the ligatures will not cut into the bark.

The terminals of every side shoot of these cordons should be pinched when five leaves have been made. It will of course occur to the reader that the spurs would soon make the tree a thick and clumsy cordon; to prevent this, every shoot should be reduced in winter to three eyes. The fruit, from being near the earth, and thus profiting largely by radiation, will be very fine.

As these low cordons are very apt to be injured in winter by severe frost, if snow is suffered to lie under

them, which by resisting radiation gives great intensity to frost just above its surface, it is necessary either to carefully remove the snow, to bank it up so as to



FIG. 17

completely cover the cordons, or to thatch them with a covering of evergreen branches, such as furze, or of firs; fern would also be a safe protection—better than all are wooden ridges made of $\frac{3}{4}$ -inch boards, so as to cover two

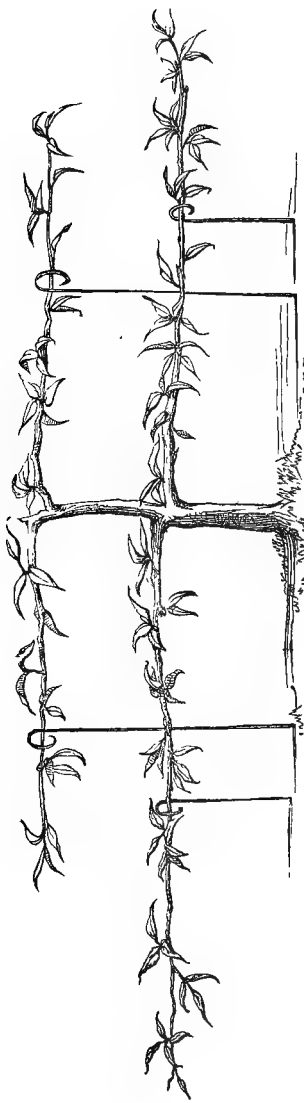

FIG. 18

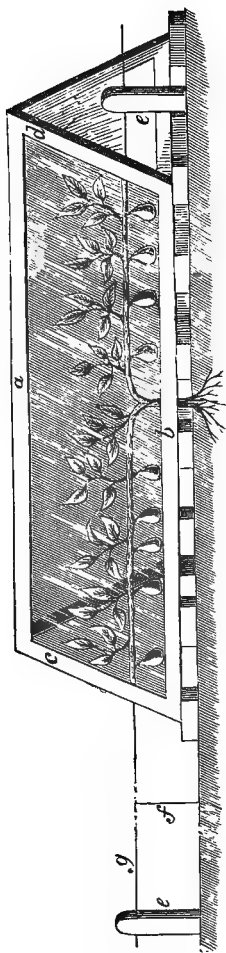

FIG. 19

or three rows of trees. For pear trees there should be boards on one side and glass on the other; they would then do to protect the blossom in spring, and bring on the fruit if placed on bricks as directed for ground vinerias.

The double or two-branched lateral cordon (see fig. 17), which is a great improvement on the French single cordon, requires the same training, pinching-in, and management. This improved lateral cordon does not require a wire to support its branches; a kind of hook, something after a shepherd's crook, may be used with advantage, thus:—the branch is introduced at *a* and is supported by the crook; the point in the ground must be barbed.



The quadruple lateral cordon is a tree well adapted for the edging of the borders of the kitchen garden; it is merely the double cordon repeated, and we must suppose the two branches of the double cordon to be trained nine inches from the surface of the ground, and above them, at about nine inches distance, two other branches in the same direction; this will give the quadruple cordon (fig. 18), or low espalier edging trees, occupying no more space than the single cordon, and giving double its produce. The stem of the short crook for single or double cordons should be 20 inches long; that of the longer one, for quadruple cordons, should be 28 inches long.

The great change in fruit culture that may be

brought about by training these double lateral cordons under glass ridges is obvious enough. The figure (19) will give some faint idea of the advantages of this new system of culture—they are endless; for not only can peaches, nectarines, apricots, plums, apples, and pears be rescued from spring frosts, but their fruit be ripened in great perfection. There is no doubt but that in some of our cold and cloudy places in the north of England and Scotland, where even the Ribston Pippin will not ripen, it may be brought to perfection under the glass fruit ridge.

The figure (19) gives but one tree trained to one wire; two rows of wire may, however, be trained under one glass ridge, which should be three feet six inches wide at base, and the wires ten inches asunder. It is quite possible that this method of training to galvanised wires may, in some situations, be better adapted to vine culture than allowing the vines to rest on slates or tiles.

I now, by permission, copy the description of my new glass fruit ridge from my article in the 'Gardener's Chronicle' for April 8, 1865, from which I have also derived the plate kindly lent to me:—

'There are no cross bars, but merely a frame three feet wide at the base. On the top bar *a* is a groove half an inch deep; in the bottom bar *b* is a groove a quarter of an inch deep;¹ in the bars *c* and *d* are

¹ An improvement on this is to have a rebate at bottom instead of a groove; the glass is more easily fitted in,

grooves half an inch deep. The pieces of glass, which should be cut so as to fit, are pushed into the upper groove, and let fall into the lower one; when all are fitted in, the two end pieces are pushed inwards, so as to drive all of them into close contact. A little putty is required at the bottom to prevent water lodging, and some at each end to keep the pieces from moving laterally. *e, e,* are the straining posts of oak, four inches square; *f,* the upright pieces of wire stuck in the ground, flattened and perforated at top to pass the wire through and support it; *g,* the wire.'

Such, then, is the description of the barless glass fruit ridge, which I think calculated to have a greater effect on domestic gardening, and contribute more to the refinement and comfort of a very large class of people than all the crystal palaces ever invented.

For ventilation and other particulars I refer my readers to the description of the ground vinery, p. 151; and for the method of placing the wires, to p. 93.

I must caution those who wish to grow fruit under glass fruit ridges, in small confined gardens, to be careful as to ventilation. A single row of bricks, with apertures of four inches, will not be enough; there should be two rows of bricks, one over the other, and consequently two rows of apertures. Peach, nectarine, and apricot trees should be planted twenty-one feet apart; but they grow rapidly, and would probably require occasional removing.

It will thus be seen that to commence glass fruit

ridge culture, three seven-foot lengths should be prepared, and in the centre of the twenty-one feet occupied by the ridge, two peach or nectarine trees may be planted. They will soon form lateral cordons of great fertility, will require pinching in June and little attention afterwards. I must not omit to state the great advantage this mode of fruit culture gives as to protection from spring frosts when the trees are in bloom, or when the fruit is young. Espaliers, pyramids, and wall trees are difficult to protect, but mats two or three thick can be piled on the ridge with great facility, and loose straw or hay, the best protectors possible from frost, can be strewed over them thickly.

I have had the pleasure of seeing all my anticipations fully realised; the cordon pear-trees have produced fruit, large, and with the fine clear rinds we see on those grown in the warm parts of France—perfectly beautiful and of fine flavour. The cordon peach-trees have produced fruit, large, and of the finest flavour. Strawberries planted between the trees temporarily until they fully occupy the room under the ridge, have ripened a fortnight earlier than those in the open air and have been of excellent quality. I have therefore no hesitation in recommending this mode of fruit culture to all amateurs who have gardens without walls or orchard houses.

SHELTER TRENCHES

THE following is a very simple and inexpensive manner of providing shelter for the cultivation of cordon trees : Open a trench as for celery about three feet wide and two deep ; bank the soil on both sides of the trench ; after settling the banks will be about one foot high, the trench with the banks therefore from the base to the top will be about three feet : in this trench plant the double horizontal cordons. The parallel banks will form the support of the protection against spring frosts, consisting either of straw hurdles or stakes laid across and covered with mats or any material stout enough to resist frost, as cheap and simple protection is thus provided, and the shelter of the trench will give a climate in which fruit may be grown equal to that from walls. Drainage will be necessary to take off the water after excessive rain ; but this can never be a serious evil, and if the trenches can be made on an incline, the water will run off quickly. If the sides are lined with slates the heat will be increased, but this extra expense is hardly necessary, as the heat will be sufficient without. I need scarcely point out that all sorts of fruit requiring shelter can be grown in these trenches.

VERTICAL CORDON APPLE TREES

IN pages 47 and 48 will be found the method of training vertical cordon pear trees. This may be applied to apples on the English Paradise stock with great success, and very charming fruitful trees they make. They should not be allowed to grow above eight feet in height, to which they will reach in the course of four or five years. I annex a figure of one of these trees, three years old, and full of fruit (fig. 20).

I have, at this period (1885), a plantation of vertical cordon apple trees which have now been planted several years; the trees are six feet apart row from row, and three feet in the rows; when in full fruit they are very interesting. I do not follow the close summer pinching recommended by Dubreuil and others; in fact, I abstain entirely from summer pruning, and I believe with good results, as the fruit is always large and finely coloured; in October every tree is closely pruned—that is, all the summer shoots are cut back to three eyes. On this plot, about sixty square poles, I have 672 apple trees of 430 sorts planted for specimens. As the apple crop is



FIG. 20

sometimes injured by spring frosts, I have an equal number of gooseberries trained as pyramids between every row of apple trees; these produce large crops of fruit every year, thus providing for a possible failure of the apple crop. This plantation thus contains 1,344 trees; the outlay upon it consists of a shallow digging in November and 16 tons of manure, with two hoeings during the summer. For the last four years I have had continual crops. An amateur will hardly require so large a plantation, but he may with perfect confidence alternate the apples or pears with gooseberries and currants.

APPLES AS WALL TREES

WE have been so accustomed to think of, and treat the apple tree as hardy, and perfectly adapted to our insular climate, that the culture of superior varieties as wall trees has been neglected, except in the extreme north of our island, where the climate is not very favourable even to the culture of the Ribston Pippin as an orchard tree.

The varieties most worthy of cultivation against walls in England, even in our most favoured counties with regard to climate, are mostly of American origin, the continental varieties, with but very few exceptions, not being remarkable for goodness of quality.

The best methods of cultivation are —

1. To have the trees trained as espaliers to low walls as directed for pear trees, the trees to be under summer pinching as given at p. 8. 2. To plant five-branched upright cordons in the spaces so often found between wall trees in old gardens. 3. To plant single vertical cordons against walls between established wall trees. Single vertical cordon apple trees, grafted on the English Paradise stock, and planted against walls 10 or 12 feet high, the trees well managed by summer and winter pruning, become amazingly prolific, and bear the finest of fruit. 4. To train at the foot of a wall the single lateral cordons (fig. 16), or the double lateral cordons (fig. 17); if the space next the wall and under the trees be paved with tiles or slates, the size and quality of the fruit will be improved. I ought here to mention that double or two-branched lateral cordon trees are to be preferred; they may be grown at the foot of walls, but not more than 9 inches from them; the tile-paving is quite necessary, as is also protection in spring from frosts. This is most effectually done by lean-to barless lights in place of the glass span ridge (fig. 19) divided into two; these most convenient lean-to lights should be 2 feet 4 inches wide, including the top and bottom bars, and 7 feet long; two hooks should be fixed to the top bar, and two eyes in the wall, so that the lights are made safe from the effects of the wind. The lower bar should rest on bricks (they should be two deep), as with ground vineries. These lean-to lights will be found a most useful invention; they form

so fine a climate against brick walls, that I see no reason why low 4-inch brick walls should not be built by market-gardeners, and lean-to lights of increased size employed for early crops; the climate they give is perfect, so efficient is the low admission of cool air in between the bricks, and the exit of the heated air at the top between the upper bar and the wall, an interstice of about two inches.

The varieties of apples most worthy of wall culture are the Newtown Pippin, Cox's Orange, Ribston Pippin, Washington, Melon, Northern Spy, King of Tompkin's County, and the New Zealand apple, Prince Bismarck.

The French apple, Calville Blanche, is also of high excellence, cultivated as a wall or orchard-house tree; and in cool climates, our fine English apples, the Cox's Orange and Ribston Pippin, are quite worthy of a place against a wall with a southern aspect, and especially Cox's Orange Pippin.

I have transplanted trees of Cox's Orange Pippin grafted on the Nonesuch Paradise twelve years old which had never been removed or root-pruned; these trees survived the removal and are now again in full fruit bearing.

PYRAMIDAL APPLES ON THE CRAB STOCK

IN soils light and poor, the apple on the Paradise stock is, unless carefully manured on the surface, apt to

become stunted and unhealthy. In such soils, and also in those of a very tenacious nature, pyramids on the crab stock may be planted with great advantage. They are also well adapted for large gardens where large quantities are required, as the trees may be made to form handsome pyramids, from twelve to fifteen feet in height.

Carefully watch the trees, for there is one thing most essential to their full success as pyramids—they must either be lifted or taken up biennially early in November, and replanted in the manner recommended for bush pear trees, or root-pruned biennially, operating upon the trees alternately. Or the following system may be adopted: neither remove nor root-prune any tree that continues to grow with moderation, does not canker, and bears well; but any tree that makes shoots from eighteen inches to three feet in length, remove once in two, three, or four years till its vigorous habit is reduced.

As these crab stock trees grow freely, summer pinching or shortening the young shoots with a pen-knife, as recommended in page 81, must be attended to; and then, in the most unfavourable apple-tree soils, healthy and most prolific pyramids may be formed. Any of the varieties recommended in pages 81 and 82 will succeed well as pyramids on the crab stock.

If managed as I have directed, fine trees may be formed not only of the robust-growing kinds, but even of the old Nonpareil, Golden Pippin, Golden Reinette,

Hawthornden, Ribston Pippin, and several others, all more or less inclined to canker. I have a row of Non-pareils and Ribston Pippins planted in the coldest and most unfavourable soil I could find; yet, owing to their being biennially removed, they are entirely free from canker.

The vigorous growth of Standard apples, when planted in orchards in the usual way, is well known, and also their tendency to canker after a few years of luxuriant growth. Pyramids on the crab without occasional removal or root-pruning would, in like manner, grow most freely; and, even if subjected to summer pinching, would soon become a mass of entangled, barren, cankered shoots.

PYRAMIDAL PLUM TREES

THE plum, if planted in a rich garden soil, rapidly forms a pyramid of large growth—it, in fact, can scarcely be managed by summer pinching. It becomes crowded with young shoots and leaves, and the shortening of its strong horizontal branches at the end of summer is apt to bring on the gum; it is a tree, however, with most manageable roots, for they are always near the surface. I must, therefore, again recommend summer pinching at the terminal bud, as directed for pears, p. 8, annual or biennial root-pruning, and surface dressing, in preference to any other mode of culture. The root-pruning of the plum is performed as

follows:—Open a circular trench eighteen inches deep round the tree, eighteen inches from its stem, and cut off *every root and fibre* with a sharp knife. When the roots are so pruned, introduce a spade under one side of the tree, and heave it over, so as not to leave a single tap-root; fill in your mould, give a top dressing of manure, and it is finished. The diameter of your circular trench must be slowly increased as years roll on; for you must, each year, prune to within one and a half or two inches of the stumps of the former year. Your circular mass of fibrous roots will thus slowly increase, your tree will make short and well-ripened shoots, and bear abundantly. From very recent experience, I have found that removing trees annually, if the soil be rich—biennially, and adding some rich compost, if it be poor—*without root-pruning*, will keep plum trees in a healthy and fertile state. For further particulars on this head, see pages 16 and 56.

Pyramidal plum trees are most beautiful trees both when in flower and fruit. Their rich purple or golden crop has an admirable effect on a well-managed pyramid. No stock has yet been found to cramp the energies of the plum tree. Experiments on the sloe have been tried here, and prove that this stock does dwarf the tree to a certain extent. My tree on the sloe is some years old, and is dwarf and prolific. The first year after grafting vigorous growth was made; but this is a very common occurrence with stock that ultimately make very prolific trees; it is so with the pear on the quince, the apple on the Paradise, and the cherry on the Mahaleb. The green-

gage seems to grow more freely on the sloe than any other sort. I have a fine vigorous bush, now about fifteen years old, growing in the white marly clay, with chalk-stones, peculiar to some part of Essex and Hertfordshire. The sloe seems to delight in this soil so inimical to most kinds of fruit trees. My greengage plum is almost vigorous in its growth; and what appears strange is, that the stock seems to keep pace with the graft—there is scarcely any swelling at the junction. The root of the tree has not been touched, and it appears to have gone deeply into the solid white clay. The plum on the sloe is easily arrested in its growth by root-pruning. The following sorts are well adapted for pyramids and walls with west, north-west, or south-east aspects.

HARDY DESSERT PLUMS ADAPTED FOR PYRAMIDS

In season from July to the end of October. Placed in the order of their ripening.

Early Favourite	Purple Gage
Early Transparent Gage	Guthrie's Late Green
De Montfort	Bryanstone Gage
Oullins' Golden Gage	Reine Claude de Bavay
Denniston's Superb	Reine Claude de Comte
Greengage	Hatthems
Jefferson	Monarch
Kirk's	Late Transparent
McLaughlin's	Coe's Golden Drop
Transparent Gage	Grand Duke

HARDY KITCHEN PLUMS ADAPTED FOR PYRAMIDS

In season from July to the end of October. Placed in the order of their ripening

Early Prolific	Victoria
Curlew	Belle de Louvain
The Czar	Gisborne's
Bittern	Diamond
Early Orleans	Cox's Emperor
Mallard	Autumn Compôte
Sultan	Pond's Seedling
Heron	Late Black Orleans
Prince Engelbert	Archduke

 PLUM TREES AS BUSHES

THE roots of no fruit tree are so easily kept within bounds as the plum. In rich soils they bear annual removal with but a slight check; but in most soils biennial removal will keep them in a perfectly fruitful state under bush culture. This is absolutely necessary; and if the soil be poor, some thoroughly rotted manure (about half a bushel to each tree) may be mixed with the soil in replanting. As with pear trees, the best season for lifting or removing them is the end of October or beginning of November. Plum bushes have the advantage of being easily protected by a square of light, cheap calico, tiffany, or any light material thrown over

them while in blossom, and a crop of fruit thus insured. All the varieties recommended for pyramids may be cultivated as bushes, and for suburban gardens they should be subjected to exactly the same treatment as recommended for apple bushes, page 81.¹

PLUM TREES AS CORDONS

THE plum forms a most prolific lateral double cordon and gives very fine fruit, when pruned and trained after the fashion of pear trees. Owing, however, to the fruit often receiving injury from heavy rains, it is almost indispensable to have a space under each tree paved with tiles, and it is a work of necessity to protect the trees from spring frosts, for they (the trees) come into blossom so early, owing to their receiving the reflected heat from the soil in early spring, that seldom or never does the young fruit survive the month of April. One of the best modes of protection is that of the ridges of glass described on page 93, for if placed on bricks they may remain over the trees till the commencement of the first week in June—here a period of rejoicing, for not till then are we safe from the fruitgrower's scourge—a severe spring frost. There is a method of cultivating a

¹ The plum is apt to produce very strong succulent shoots at irregular intervals; this growth should be stopped as soon as perceived by very close pinching.

few kinds of plums as vertical cordons practised here which is likely to be popular ; it is simply selecting the proper sorts, and then planting them in ground not too rich—say a calcareous sandy loam, and then pinching, in June, all the young shoots, and trusting to this to retain the growth of the trees, without either root-pruning or removal.

The varieties adapted to this mode of culture are as yet but few—viz., The Czar, Oullins' Golden Gage, Early Prolific, Victoria, Sultan, Cluster Damson, and Monarch. Of the latter kind upwards of 1,000 trees are planted here for fruit bearers ; they are now fruitful and profitable trees. In the course of time there will doubtless be many kinds of plums adapted to this mode of culture, for here we have many seedling plums all raised from choice varieties, and likely to give kinds as well adapted to our climate as is the Early Rivers or Early Prolific, the hardiest plum known, but yet only the first removed by seed from one of the most tender French varieties, *Précoce de Tours* plum.

Vertical cordon plums should be planted from four to five feet apart, row from row, and the same distance tree from tree ; the former distance will allow of 2,700 trees per acre, the latter 1,700, and as far as I can see many years will elapse before they will require thinning, and they will bear many bushels of fruit per acre.

MARKET GARDEN PLUM TREES

PLUMS, like pears, open up a rich field to the amateur market gardener, for it is found that they are so easily made into articles of exportation, by jam and bottling, that the demand is limitless.

The same method of culture as given for pyramidal pears on the quince stock (p. 10) is at once the most simple and beneficial.

The trees may be planted six feet apart, row from row, and six feet apart in the rows; for a few years the centre of the spaces between the rows may be cropped with dwarf bushes of currants and gooseberries. I grow strawberries, but onion or other light crops of vegetables may be grown. As soon as the trees have made sufficient growth to shade the ground, which may be in five or six years, more or less, the ground should have a dressing of manure, and be left undug; the hoe only, to kill the weeds, should be employed. The following kinds will be found the best for this mode of culture:—Early Prolific, The Czar, Sultan, Victoria, Monarch, Pond's Seedling, Cluster Damson, Autumn Compôte, and Grand Duke. The second sort named is so pyramidal in its growth that it will last many years without being crowded.

The Autumn Compôte and Victoria, two very hardy useful plums, may be planted six feet apart as directed, but their stems will require a stake to each to support

them for some three or four years, or till they become stout enough to stand without support.

Damsons are remarkably fertile and do not require pruning, in fact, the best treatment is to leave them alone, as a very acute boy defined the proper course of doing his duty to his neighbour. The best sorts for planting are the Cluster or Crittenden Damson, the Prune or Shropshire, and the Common; the white Damson is a garden tree which makes a delicious preserve but is not a market sort. The Bullace, requiring the same treatment as the Damson, makes a very productive pyramid.

CHERRIES AS BUSHES AND PYRAMIDS ON THE MAHALEB STOCK (CERASUS MAHALEB)

THIS stock has long been known in our shrubberies as the 'perfumed cherry'; its wood when burned emits a most agreeable perfume. In France it is called 'Bois de Ste. Lucie,' and it has been used there for dwarf cherries for very many years. My attention was called to it in France some twenty or more years ago, since which I have used it extensively, annually increasing my culture. Its great recommendation is, that cherries grafted on it will flourish in soils unfavourable to them on the common cherry stock, such as strong white clay

or soils with a chalky subsoil. Although the trees grow most vigorously the first two or three seasons, yet, after that period, and especially if root-pruned, they form dwarf prolific bushes, so as easily to be covered with a net, or, what is better, with muslin or tiffany, which will protect the blossoms from frost in spring, and the fruit more effectually from birds and wasps in summer; thus giving us what is certainly most rare, cherries fully ripe, and prolonging their season till September. These dwarf bushes may be planted from five to six feet apart, and their branches pruned so that seven, or nine, or more, come out from the centre of the plant, like a well-managed gooseberry bush. These branches will, in May or June, put forth, as in the horizontal shoots of pyramidal pear, several shoots at their extremities, all of which must be pinched off to five leaves, leaving the leading shoots untouched to the middle or end of September, when they must be shortened, and the pruning for the year is finished.

The Morello and Duke cherries—the most eligible for this bush culture—may have their leading shoots shortened to eight leaves. If, however, the space be confined in which they are planted, this length may be reduced, for by biennial root-pruning, the trees may be kept exceedingly dwarf. The aim is to form the tree into a round bush, not too much crowded with shoots. Towards the end of September,¹ or, in fact, as

¹ This early autumnal root-pruning will be found very advantageous, the flow of sap is checked, so that the shoots are well

soon as the autumnal rains have sufficiently penetrated the soil, a trench may be dug round the tree, exactly the same as recommended for root-pruning of pears, the spade introduced under the tree to cut all perpendicular roots, and all the spreading roots shortened with the knife, and brought near to the surface, previously filling in the trench with some light friable soil for them to rest on, and spreading them regularly round the tree, as near to the surface as possible; then covering them with the soil that was taken out of the trench. No dung or manure of any kind is required, as this stock seems to flourish in the poorest soils. Some short litter or half-decayed leaves will, however, be of much benefit placed on the surface round the stem.

I have thus far given their culture for small gardens; but those who have more space may dispense with the root-pruning, and allow their cherry trees to make large bushes, which may be planted eight feet apart and pinched regularly in the summer, and managed as directed for pear trees (p. 10). The leading shoot from each branch in such cases must be left longer, and shortened to twelve or more buds.

The most charming of all pyramids are the varieties of the Duke and Morello cherries on the Mahaleb; these by summer pinching, as practised for pyramidal ripened, and the roots soon emit fresh fibres to feed the tree the following season.

pears, become in two or three years the most delightful fruit trees ever seen, for in spring they are perfect nosegays of flowers, and in summer clusters of fruit—if spared by spring frosts.

The common Morello cherry on the Mahaleb stock, cultivated as a pyramid, forms one of the most prolific of trees; but as birds carry off the fruit when only half ripe, each pyramid should have a net placed over it, and tied round the stem of the tree at bottom. Any garden, however small, may grow enough of this useful sort by planting a few pyramids, lifting and replanting, or root-pruning them biennially, and pinching in *every shoot* to five leaves (as soon as it has made seven) in June. The Kentish cherry, also a most useful culinary sort, may be cultivated as a pyramid with great success. A French variety grown near Paris in large quantities, and known as the ‘*Cerise Aigre Hative*,’ which may be Englished by calling it the Early Sour Cherry, is a useful kind for the kitchen. By the side of the ‘*Rive Droite*’ Railway, between Suresnes and Puteaux, on the left, there are large plots of dwarf trees, about the size of large gooseberry bushes, and some very low trees, all covered (as they appear from the railway carriage) with bright red flowers. These are cherry bushes—literally masses of fruit, of the above variety. I find, however, that it is not equal to the Kentish in flavour or size in England.

I need scarcely add that the culture of all the Duke tribe of cherries by summer-pruned pyramids,



From a photograph, August 1862

FIG. 21

biennially removed, is most satisfactory ; it is, perhaps, more easily performed than root-pruning, and the trees soon form perfect pictures. As far as my experience has gone, cherries on the Mahaleb are much more fruitful when 'oft removed' ; the most eligible mode is to remove only half the trees in one season, and the remainder the following season. It will much facilitate the operation on their roots if the trees be planted on small mounds.

In forming plantations of pyramidal and dwarf cherries on the Mahaleb stock, it is necessary to arrange them with a little care. The two groups, those of the habit of the Morello tribe, and those of the compact habit of the May Duke, should be planted in separate rows. Bigarreau and Heart cherries are too short-lived in many kinds of soil, when grafted on this stock, and unless double-grafted on the Morello cherry it is not to be recommended.

The following arrangement will assist the planter :—

Section I.—*The May Duke Tribe*

Archduke		Royal Duke
May Duke		Empress Eugénie

Section II.—*The Morello Tribe*

Late Duke		Morello
-----------	--	---------

Cherries grafted on the *Cerasus Mahaleb* are eminently adapted for espaliers, or for walls, as they occupy less space and are very fertile. They may

be planted twelve feet apart, whereas espaliers on the cherry stock require to be eighteen or twenty feet apart. For potting, for forcing, cherries on this stock are highly eligible, as they grow slowly and bear abundantly.¹

CHERRIES AS SINGLE VERTICAL CORDONS

THE varieties best adapted for this very interesting mode of culture are those of the Duke tribe, such as the May Duke, Archduke, Empress Eugénie, Royal Duke, and the Morello. Young pyramidal trees, three feet apart, should be planted in rows, and their side shoots pruned into within two inches of their stems. They require the same summer pinching as that recommended for vertical cordon pears, p. 48, and should not be allowed to exceed eight or ten feet in height. Nothing can be more charming than these cordon cherry trees, with their bright ripe fruit hanging close to the stem, and shining through the net that protects them from the birds. The best protection, both from birds and wasps, is, however, Haythorn's netting, or coarse muslin,

¹ Cherry trees are often infested in summer with the black aphid. The best remedy is a mixture made by boiling four ounces of quassia chips in a gallon of soft water for ten minutes, and dissolving in it four ounces of soft soap at the time of application. It should be stirred, and the trees syringed with it twice or thrice. The day following they should be syringed with pure water.

formed into a narrow bottomless bag, which should be let down gently over the tree, so as to leave the leading shoot out, and tied at the bottom and top; Duke cherries may be thus preserved till August. I may mention here, that with these cherry cordon trees, root-pruning or removal is seldom required, their vital force is so reduced by the pruning of the young shoots; but if a rich soil gives too much vigour, it may be practised.

The Bigarreau and Heart, or Guigne cherries, are too vigorous for this mode of culture when grafted or budded, as they generally are, on the common cherry stock. The new mode of culture by double grafting, i.e. by grafting on Morello cherry trees that have been previously grafted on the Mahaleb, will make them most prolific cordons. (See page 133.)

I must add a piece of very necessary advice: all vertical cordon trees, whether pears, apples, cherries or plums, should be supported by a slight iron rod, about the size of a goosequill, which should be painted; this should stand six to seven feet above the surface, and be inserted ten to twelve inches in the ground, and the tree attached loosely to it by two or three bands of sheet lead or some soft metal.

BIGARREAU AND HEART CHERRIES AS PYRAMIDS ON THE COMMON CHERRY STOCK

THE Bigarreau and the Heart cherries (or, as the French call them, Guignes) do not succeed so well on the *Cerasus Mahaleb* as they do on the common cherry; they grow most rapidly for two or three years, and then are apt to become diseased.

The stock raised from the small black and red wild cherries is the proper one for this race, except they are double-grafted.

Pyramidal cherry trees may be bought ready-made or formed by purchasing young trees one year old from the bud, and training them up in the same way as directed for pyramidal pears (pages 5 and 6), with this variation—pears, it is well known, may be grown as pyramids successfully, with or without root-pruning or biennial removal; but cherries on common cherry stocks will grow so rapidly, in spite of summer pinching, that biennial removal is a work of necessity. In the course of a few years, pyramidal cherry trees thus treated become pictures of beauty. In France they generally fail, and become full of dead stumps and gum, owing to their trusting entirely to pruning their trees severely in summer and winter, without attending to their roots; the trees thus being full of vigour make strong shoots, only to be pinched and cut off. We must 'manage these things better' in England.

The mode of operation in removing pyramidal cherries is the same as that recommended for pears and apples, &c. It will be found, however, that more labour is required, for in two years the cherry on the common stock, like the apple on the crab, makes a vigorous attempt to lay hold of its parent earth. The second year the tree may be lifted by digging a trench round its stem, one foot distant and 16 inches deep. The fourth year this trench must be 18 inches from the stem, and 20 inches deep; the sixth year it should be two feet from the stem, and two feet deep. This distance and depth need not be departed from if the trees are required to be only fair-sized pyramids; the straggling roots beyond this circumference should be biennially pruned off with the knife. The tree managed thus will soon be in a mature fruitful state, and its roots a mass of fibres, so that when removed it will, like the rhododendron, receive only a healthy check.

Pyramidal Bigarreau and Heart cherries, cultivated after the method above given, may be planted in small grass orchards, with pyramidal pears on pear stocks, pyramidal apples on crab stocks, and pyramidal plums. A charming orchard in miniature may thus be formed. Cattle and sheep must, of course, be excluded, and a wire fence, enclosing a space from three to four feet in diameter, should be round each tree. This space must be kept free from grass and weeds.

The following varieties form handsome pyramidal trees, and bear fruit of the finest quality :—

Early Rivers	Early Red Bigarreau
Bigarreau Jaboulay	Bigarreau Napoléon
Bohemian Bigarreau	Black Tartarian or Bedford Prolific
Large Black Bigarreau	Elton
Early Black Bigarreau	Florence
Late Purple Guigne Bigarreau	Governor Wood

At the risk of repetition, and writing from my own experience, I must say that no gardening operation can be more agreeable than paying daily attention to a plantation of pyramids. From the end of May to the end of July—those beautiful months of our short summer—there are always shoots to watch, to pinch, to direct, fruit to thin, and a host of pleasant operations, so winning to one who loves his garden and every tree and plant in it.

I may here mention that the small *Alberge* apricot, raised from the stone, and producing small high-flavoured fruit, and also the *Breda* apricot, make very beautiful pyramids if lifted or planted biennially. In the southern counties of England, in a favourable season, they will ripen their fruit and produce good crops. The large *Portugal* quince is also very prolific as a pyramidal tree. Some trees only two years old have borne fine fruit here. This is the finest of all the quinces, and in the south of Europe it grows to an enormous size. The *Medlar* will also form a handsome and productive pyramid, and, 'last, but not least' in

the estimation of the lover of soft fruits, the currant. A near neighbour—an ingenious gardener—attaches much value, and with reason, to his pyramidal currant trees; for his table is supplied abundantly with their fruit till late in autumn. The leading shoots of his trees are fastened to iron rods; they form nice pyramids of about five feet in height; and by the clever contrivance of slipping a bag made of tiffany over every tree as soon as the fruit is ripe, fastening it securely to the bottom, wasps, and birds, and flies, and all the ills that beset ripe currants are excluded.

FILBERTS AND NUTS AS STANDARDS

FILBERTS, as commonly cultivated, except in the Kentish gardens, form straggling bushes, and are some years before they commence to bear. To correct this, some twenty years since I had them grafted by inarching on stems of the hazel-nut raised from Spanish nuts, as they were vigorous growers and formed stout stems. I have found these grafted trees answer admirably, and come quickly into bearing, forming nice garden trees.

As soon as the nut trees designed for stocks have made stout stems about four feet high, they should be grafted by inarching at that height with choice kinds of nuts, such as the red and white filberts and the Cosford nut—an excellent nut—and, the best of all, the Lambert

Filbert or Kentish Cob and its varieties. The purple-leaved filbert, generally planted as an ornamental shrub, may also be grafted; it gives nuts equal to the common filbert, and forms a nice ornamental standard.

Standard nuts require but little culture; they soon form round heads, and bear profusely. Care must be taken to destroy all suckers from the stem and root.

The only pruning required is, in the winter, to thin out the crowded shoots, and shorten to half their length those that are inclined to be vigorous—that is, those that are more than nine inches in length. The short spray-like shoots must not be shortened, as they are the fruit-givers.

Standard nuts planted in rich garden soils soon make trees too large for small gardens. If, therefore, they are found to grow too vigorously, they should be lifted and planted biennially in November.

FIGS AS HALF STANDARDS OR BUSHES

THERE is, perhaps, no fruit tree that disappoints the amateur fruit grower so much as the fig. If planted in the open borders of the garden, it soon grows into an enormous fruitless bush or tree, and if placed against a wall, unless a very large space can be given to it, but little fruit must be expected.

It may, however, be made eligible for small gardens,

where the climate is sufficiently warm to ripen its fruit, such as the gardens near London, and those in the eastern and southern counties. Fruitfulness and moderate growth are brought on by the following method. Trees should be procured of the Angelique, Brown Turkey, White Marseilles, and Early Violet Figs—these are the only kinds that bear freely, and ripen their fruit well; such trees should be low or half standards, or dwarfs with a clear stem (not bushes branching from the ground). The former should have a stem three feet high, and the latter from one foot to eighteen inches; in each case the tree should have a nice rounded head.

Trees thus selected should be planted in a sunny situation, and require only the following simple mode of treatment. They, we will assume, were planted in March or April. They will make a tolerably vigorous growth, and must be pruned by pinching off the top of every shoot as soon as it has made six leaves, leaving five. The stem must be kept quite clear from young shoots. By the autumn nice round-headed trees will be formed, and about the end of October they should be taken up (their leaves cut off if they have not fallen) and placed in a cellar—no matter if dark, but a light dry cellar would be preferable—some earth should be placed over their roots, and there they may remain till the first week in May, when they should be planted out, and the same routine of culture followed. They will bear one good crop of fruit in a season and ripen it in September. This annual removal brings on great stur-

diness of growth in the tree, and the roots become so fibrous as to hold a large quantity of earth, which should not be shaken from them when they go into their annual winter abode. Fine trees thus treated are grown in the garden of the Duke of Altenburg, in Central Germany, their stems as stout as a man's leg, and their heads full of fruit; and fig-trees, taken up in October, and placed in the orchard-house during the winter—their roots in the soil—will give a crop of very rich, well-ripened fruit: fresh soil must be given to lifted trees.

SEEDLING FRUITS

ALTHOUGH raising fruits is, like art, very slow in results, and the reward precarious, the pleasure of contributing to the general good is worth waiting for. For many years I have never ceased to sow seed of fruits of good quality in the hope of prolonging or advancing the season of sorts that are recognised by all to be the best of their class. I cannot say that up to the present my hopes have been fulfilled, but still there is always a chance of success.

The Transparent Gage, of whose origin I know nothing except that it belongs, though widely differing, to the family of the gages, appears capable of reproducing itself from seed; of this sort I have obtained the Early Transparent, the Late Transparent, and the

Golden Transparent, the three seedlings and the original lasting from August to October; these are in no wise inferior in flavour to the prototype, the greengage, and, indeed, excel it in size and beauty. The Early Prolific, a seedling from the *Précoce de Tours*, also exhibits a tendency to reproduce itself. I have raised many seedlings from this variety which differ little from the parent. The Late Prolific is almost identical, but ripens three weeks later. The 'Curlew,' raised from the 'Diamond,' is alike in colour and size, but is exceedingly good for the table as well as the kitchen, and ripens from ten to twelve days earlier. The 'Monarch,' a seedling from the 'Autumn Compôte,' in no way resembles the parent, being very large, of a deep purple colour, and round rather than oval. The 'Grand Duke,' also a seedling from the 'Autumn Compôte,' is oval and very large, deep purple in colour, and ripens from two to three weeks after the original.

Certain races of pears are inclined to reproduction, the Louise Beurré of Jersey belonging to this class; the seedlings Magnate and Princess both originated from this variety, of which they continue the special characteristics—the Magnate ripening in November, and the Princess in December, both bearing strong evidence of their origin. The Beurré de Capiaumont is wildly erratic, the Beurré d'Aremberg is tolerably persistent, and the Passe Colmar produces seedlings which hardly vary save in season. There is one important rule to follow in raising seedlings, and that is to

sow seeds only from the finest and best developed fruits of the highest quality. If certain fruits can be raised which will ripen consecutively through the season, the task of making a choice will be much simplified to the amateur, and the grower will be relieved from a very troublesome business, i.e. that of knowing what to grow.

THE BIENNIAL REMOVAL OF FRUIT TREES WITHOUT ROOT-PRUNING

ALL trees that are inclined to make very fibrous roots, such as plums, pears, or quince stocks, and apples on Paradise stocks, may be lifted—i.e. removed biennially or occasionally, if their growth is not too vigorous, as above described—with equal or greater facility than root-pruning them. The effect is the same; they make short well-ripened shoots, and bear abundantly. Apples on Paradise stocks, cultivated as dwarf bushes or as pyramids, if lifted *every year*, and a shovelful or two of compost given to them, form delightful little trees.¹ The most delicate sorts of apples, such as Golden Pippins and Nonpareils, may thus be cultivated in the most unfavourable soils; and Roses, more particularly Bourbon Roses, on short stems, and Hybrid Perpetuals, removed annually in the autumn, giving to

¹ In moist retentive soils the fruit-spurs of small trees become covered with moss; some powerful lime sprinkled over them will destroy it; this is best done in foggy weather in winter.

each tree a shovelful of rich compost, and not pruning their shoots till April, will bloom delightfully all the autumn, never dropping their leaves towards the end of summer, and not becoming, as is too often the case, blighted and blossomless.

If the soil be very rich, so as to induce the trees planted in it to make a growth of eighteen inches in one season, they may be removed *annually* till this vigorous growth ceases. If the trees make an annual growth only of ten to twelve inches, the trees may be removed *biennially or occasionally*; and I may add that in soils *in which trees grow slowly*, root-pruning is more advantageous than removal, as less check is given to vegetation.

PYRAMID ORCHARDS

A FAIR return ought to be made from an acre planted with pyramid trees, but, like everything that is really worth having, the realisation of profit must necessarily be slow. Supposing that it is intended to plant an acre of ground as a pyramidal orchard, I should recommend the planter to mark off a quarter acre, and to prepare this for the first plantation. If possible, trench the ground to about twenty-four inches; if you can persuade the labourer to do this honestly, so much the better; but many workmen will throw the soil loose and high, giving the digging an appearance of depth,

which exists more in the workman than in his work, as the absolute depth measured from the unbroken surface to the lowest trench may not be really more than eighteen inches, a great saving in a day's digging! Good work, from 22 to 24 inches, will probably cost 1s. 4d. to 1s. 6d. per perch; but much of course depends on the quality of the soil. If the subsoil is wet and heavy, draining is essential. Before breaking the ground, dress with about fifteen tons of good manure. This work should be done early in September, and the ground should be ready to plant the second week in October, so that the plants may bear the advantage of the warmth in the soil which has been stored up during the summer. They will commence to root immediately they are planted, and by the end of March of the ensuing year—nearly six months—the roots will have already made a good basis for the summer's growth. I assume that the remainder of the acre will not be used for stock, and that the orchard will not require fencing; but it will be evident that, if the orchard is fenced, it will be much cheaper to enclose by a single fence than as in ordinary orchards. To fence every individual tree is an expensive and unsatisfactory process, as usually before the standards have made growth enough to stand alone, the fencing rots. The next question is the number of trees to be planted; I assume that the ultimate distance of each tree will be twelve feet apart. I should therefore begin by planting two-year-old trees at four feet apart. After two years' growth a second

quarter acre should be prepared, and a third of the trees removed from the first plantation. In three years the trees ought to have made growth enough to pay for planting the entire acre. Three years must be the limit of time allowed for the last transplanting, and it must be done as early in October as possible, and the trees should be taken up carefully. Some men in drawing trees are apt to chop the roots ; this should be strictly forbidden, and the master will have to look at the trees before any damage is concealed by the earth. Every care also must be taken that the trees are solidly planted, as the wind, after the ground is loosened by frost, will break the young roots that are made during the winter. After frost every tree must be firmly set by a strong and willing labourer.

I have assumed, in the foregoing description of a condensed orchard, that the trees planted will be either plums or apples, as these are generally more profitable than pears or cherries ; but I have found that land may be economised by planting alternately with plums, a row of pears on the quince stock, or apples on the Paradise. The pear and the apple on these stocks do not grow with the same vigour as the plum. If a mixed orchard is desired, the rows must be made at six feet, and the trees planted three feet apart in the rows, with a view to their future removal ; for an orchard of pears on the quince, or of apples on the Paradise, the ultimate distance of six feet will be sufficient for many years, and if the trees are found to be close, one

year's preparation by lifting, preceding the transplantation, will ensure their safe removal to a new orchard. A mixed plantation will, I think, be found to answer very well. As large pears fetch the highest price, they will be the most profitable to plant, and the plum trees will shelter the fruit from the effects of the autumnal winds.

There remains the question of the best method of cropping the surface of the soil not occupied, and this I am unable to answer. In the neighbourhood of a town or of easy carriage, I think strawberries would pay best. Black and red currants, or gooseberries, bring the most profit, but with these crops the land must be highly manured, or the trees will suffer. In the non-bearing years of the pyramid trees some return of course ought to be made.

It is evident that great allowance for spring frosts must be made in planting orchards. Care should be taken to select a locality not liable to excessive frosts. The soil must not be heavy or wet, and should be well drained. Above all, a valley should be avoided, especially if a river runs through. Frosts are invariably more severe near the water than on a hill. If a crop can be reasonably expected five years out of seven, a fruit orchard of trees six and twelve feet apart will yield a good return for the outlay. An orchard from which crops of fruit were taken every year would probably soon be exhausted, as the trees, unless very highly farmed, would probably overbear themselves. It

is, however, a consummation never attained in this country. In other countries the balance seems to be kept up, if not by spring frosts, by other destructive agencies, such as excessive droughts. Some years since, in travelling in the Touraine during June, I noticed that the apple trees by the side of the railway for some twenty miles or more were entirely stripped of their foliage by caterpillars.

The cost of the preparation of the ground will be much reduced by opening trenches in the lines in which the trees are planted; if these are six feet apart a great saving will be made. A trench will probably not cost more than opening holes for each tree.

The trench should be two feet wide, the first spit thrown out, and the second spit of soil dug and left in its place.

The intervening soil can be cultivated with the plough the first year, but spade husbandry must be used after the trees have made a fair growth.

DOUBLE GRAFTING OF FRUIT TREES

I HAVE not been able to find this mode of culture likely to be so beneficial to fruit gardens in England, alluded to by the many authors of works on fruit trees; it may be 'as old as the hills,' and have no claim to originality, but few so-called new ideas have. I can

only therefore state how it originated here some twenty or twenty-five years since. I am not aware that it has been practised by the clever fruit-tree cultivators of France and Belgium ; if so, it has been recently copied from English practice ; but I never remember having seen it carried out. It may be described in a very few words. A double-grafted pear tree is formed by selecting a variety that grows very freely when budded or grafted on the quince, and re-grafting it—i.e. grafting the graft with a kind that refuses to unite kindly with the quince stock.

Its history, briefly told, is as follows :—All those who are skilful cultivators will know that when budding and grafting pears on the quince stock, some varieties did not grow freely on that stock, particularly the Jargonelle, Gansel's Bergamot, and the Autumn Bergamot, the Seckle, the Marie Louise, Knight's Monarch, and some others. Now, as the second and last-mentioned are notorious for their shy bearing qualities while the trees are young, even when root pruned or frequently removed, I felt anxious to see them flourishing on the quince stock, which invariably makes pear trees fertile ; but few grafts of these sorts out of scores would survive on the quince, and when they did unite they were very short-lived. This induced me to look narrowly into the habits of pear trees on the quince stock, and I found that some sorts form a most perfect union with the stock, and seemed most enduring. I therefore had some thrifty trees, two years old from the bud, grafted with

Gansel's Bergamot; the grafts flourished, and became so prolific that when three or four years old, they each bore from three to four dozen of fruit—a most unusual thing with that fine variety. This settled the question as to the fertility given by double grafting; which since this experiment has become here an extensive branch of culture. The cultivator has something to learn, for there are many pears of the finest quality, but of a delicate and infertile habit, that may be much improved by double grafting.

Our garden culture of cherries is, as yet, rude and imperfect; and espaliers of the Bigarreau and Guigne or Heart tribe are planted and trained along the sides of the garden walks, giving abundance of shoots and leaves, but very little fruit (which the birds appropriate), and, in the course of time, give out gum—owing to their having been unmercifully pruned—and die full of years and barren shoots, having given much trouble to the gardener. I have pointed out how cherries may be cultivated in gardens as pyramids, &c., and have alluded to fertility in the Bigarreau and Heart tribe being promoted by double grafting; this mode of culture is also interesting as leading to success in soils that seem unfavourable to cherries under some circumstances.

Cherries grafted on the Mahaleb are described in pp. 109 to 114; they affect calcareous soils, and, as far as I can learn, do not succeed so well in the sandstone formations, and where iron abounds in the soil; in such

situations double-grafted trees should be planted, formed in this way—the common Morello cherry should be budded on the Mahaleb stock, and after two years it should be grafted with some kind of Bigarreau, Heart, or Guigne cherry; it will form a small or moderate-sized tree, and bear abundantly. In cultivating cherry trees in soils inimical to their well-doing, abundance of chalk or lime rubbish should be mixed with the earth to the depth of two feet.

Double grafting of apples is of very inferior importance as compared with the same operation on pears or cherries, for our English Paradise stocks give the most perfect health and fertility in nearly all soils. Still there may be some peculiar positions where the soils are very light and poor, in which strong, robust sorts of the crab stock are required to make healthy fruitful trees. In such cases it is better to graft such sorts as the Hawthornden, Manx Codlin, and Small's Admirable on thrifty crab stocks, and when two years old re-graft them with choice dessert kinds; all double grafting is best done when the first graft is two years old. It is to be regretted that English cultivators, more particularly nurserymen, have not turned their attention to the benefit choice fruit trees derive from having the proper kind of stock selected for them, or from being double grafted. Mr. George Lindley, an old author, seems to have turned his attention to fruit tree stocks more than any other nurseryman of his day; still he knew only those grown by the nurserymen of his

day, a very imperfect list. It is but a few years since that the common fruit-bearing quince, raised from layers—a most unfit stock—was sold for stocks for pears, and Mussell, White Pear Plum, Brompton, Brussels, and ‘Commoners’ (i.e. common plum stocks) are still the plum stocks propagated for sale; all except the first and the last are of inferior quality and are surpassed by the White Magnum Bonum and the Black Damask Plum, which suit Peaches, Nectarines, Apricots, and all kinds of plums.

There are some free-growing kinds of apricots which, when budded on the plum, and the young apricot budded with a peach or nectarine, produce the most favourable effects on the peach tree, the union being perfect and the duration of it much lengthened. There are also one or two kinds of plums which, being budded on a wild kind of plum, form, when budded with the peach or nectarine, a most favourable stock, giving hardiness and fertility to the trees. We are still very backward in our knowledge of the effects of stocks on fruits; the subject requires much time and research, and no rushing to conclusions like some of our writers, who write on everything, and nothing well, only because they have not the necessary patience to master a few subjects thoroughly.

RENOVATING OLD STANDARD PEAR
TREES

OLD pear trees which have ceased to bear any but under-sized fruit are often an eyesore ; still the owner may be unwilling to resort to the heroic remedy of cutting them down. My remedy is not so trenchant, and, instead of destruction, will restore them to health and vigour ; it is simply to head the branches down to within three or four feet of the main stem. From these stumps will be at once produced young shoots in abundance, and in three years they will be thickly covered with fruit spurs, and the tree will be in condition to bear fruit from young wood no longer distorted and small, but fine in size and quality. I do not speak from theory, but from practice, as I have operated on trees which I thought hopeless, which have now robust young heads on old trunks. The old bearing wood of fruit trees appears to become too constricted and dense to allow the sap to flow freely, hence the inferiority of the fruit.

The vine, after seven or eight years of spur-pruning, produces small branches, which gradually lessen ; the same treatment should be applied by cutting away the old stem, and rearing a young rod from the base.

Apples and plums do not bear this treatment so happily as the pear.

HOW TO PREPARE A PEACH TREE BORDER IN LIGHT SOILS

IN our southern counties, where light sandy soils abound, the difficulty of making peach and nectarine trees trained to walls flourish is well known; in spring they are liable to the curl and the attacks of aphides, in summer they are infested with the red spider, so that the trees are weakened, and rarely give good fruit; they seem, indeed, to detest light soils. The following method of preparing borders for them in such soils may be well known, but I have not seen it described by any gardening author. The idea has come to me from observing peach trees trained to walls refuse to do well in the light sandy soil forming a part of my nursery, except near paths, and to grow and do well for years in the stiff tenacious loam forming another part. My bearing trees in pots, for which I use tenacious loam and dung, rammed down with a wooden pestle, also bear and flourish almost beyond belief; and so I am induced to recommend that in light soils the peach tree border should be made as follows:—To a wall of moderate height, say nine or ten feet, a border six feet wide, and to a wall twelve feet high, one eight feet wide should be marked out. If the soil be poor and exhausted by cropping, or if it be an old garden, a dressing of rotten dung¹ and

¹ If the border be new or rich with manure, a dressing of the loam or clay only, four inches in thickness, will be sufficient.

tenacious loam, or clay, equal parts, five inches in thickness, should be spread over the surface of the border; it should then be stirred to two feet in depth, and the loam and dung well mixed with the soil. The trees may be planted during the winter; and in March, in dry weather, the border all over its surface should be thoroughly rammed down with a wooden rammer, so as to make it like a well-trodden path; some light, half-rotten manure, say from one to two inches in depth, may then be spread over it, and the operation is complete. This border must never be stirred, except with the hoe to destroy weeds, and, of course, never cropped; every succeeding spring, in dry weather, the ramming and dressing must be repeated, as the soil is always much loosened by frost. If this method be followed, peaches and nectarines may be made to flourish in our dry southern counties, where they have hitherto brought nothing but disappointment.

The two grand essentials for peach culture are stiff loam, or a very firm soil, and a sunny climate.

A CHEAP METHOD OF PROTECTING WALL TREES

AT Twyford Lodge, near East Grinstead, Sussex, the seat of R. Trotter, Esq., is a wall 75 feet long, covered with peaches and nectarines, which, for several years, had given no fruit; some years ago, the gardener, Mr.

Murrell, asked my advice about protecting it with glass; and acting upon it with his own adaptation, has succeeded, every season since its erection, in securing fine crops of fruit of superior flavour. The following is a description of this simple structure:—

At the top of the wall, which is 12 feet high, is nailed a plate for the ends of the rafters to rest on; 4 feet 6 inches from the wall is a row of posts, 6 inches by 4 (these should be of oak), 6 feet apart, and 3 feet 6 inches in height from the ground; on these is nailed a plate to receive the lower ends of the rafters; the latter are 8 feet long, 3 inches by $1\frac{1}{2}$, and 20 inches asunder; and the glass employed is 16-oz. sheet, 20 inches by 12. Every fourth square of glass at the top next the wall is fixed into a slight frame of wood with a hinge at the top of each, and made to open all at once by a line running on a wheel; the front is of $\frac{3}{4}$ -inch deal boards nailed to the posts, one of which, one foot wide, near the top, is on hinges, forming a drop shutter the whole length of the front. Now comes the management by which red spider, the deadly foe of the peach tree, is discomfited; and let me quote Mr. Murrell:—

‘All these ventilators, back and front, I leave open day and night after May, except in very wet and rough weather. The first season I had the red spider (it was in the walls), but the fruit was of the highest flavour; the second season the fruit was very fine, and the spiders never came, I believe owing entirely to my

syringing the trees twice a day, morning and afternoon, and leaving all the ventilators open; besides this the boards have shrunk, so that there are wide crevices, and the place is always airy. I thank you for your hints about giving plenty of air: the trees are admired by all who see them.'

The roof, it will be seen, is fixed, and the whole structure a fixture; the trees can be pruned and nailed under shelter, and a crop of fruit always ensured. How superior, then, is this to all the temporary protectors for walls so often recommended!

STANDARD ORCHARD TREES

ALTHOUGH in this little work I profess to confine myself to the culture of garden fruit trees, I feel that a few words as to my method of planting trees in an orchard under grass may not be out of place, for very frequently a villa residence may have a piece of pasture land attached to it favourable to the growth of orchard trees, and quite necessary as a convenient place for the cow or the horse or horses. The common practice is to open large holes in the turf, three feet in diameter and from two to three feet deep, and in the centre to plant a tree. In rich deep loamy soils trees often succeed when planted in this manner, and as often fail, the hole becoming in wet seasons a pond.

Orchard trees, as a general rule, should be planted twenty-four feet apart, row from row, and they are for the most part planted twenty-four feet apart in the rows, so as to stand that distance apart over the whole orchard. I now propose that the rows should be twenty-four feet apart, but the trees twelve feet apart in the rows, so as to allow of one-third more trees to the acre. Instead of digging large holes, slips four feet wide, six feet in length, should be marked out on the turf, so that the centre of each is twenty-four feet apart; each slip should then be trenched, or, as it is often called, 'double-dug,' to a depth of two feet, keeping the turf at the surface of the trench and leaving the subsoil *in situ*. A row of trees should be planted in the centre of each slip, twelve feet apart, and after the lapse of some fifteen or twenty years every alternate tree should be either removed and replanted or grubbed up. As such large standard trees would require much care in transplanting, and even then probably not succeed, the latter may prove the more economic mode. By thus planting more trees than required for a permanent orchard, a great advantage is reaped, for the temporary trees will, if the land is good, bear a large quantity of fruit, and amply repay their cost, which is trifling; for whereas 95 trees are required to plant one acre twenty-four feet apart, by the above method 142 may be planted. I have mentioned from fifteen to twenty years as the probable time when the temporary trees may be removed; as this depends entirely upon the quality of

the soil and the progress they have made, a more certain rule to lay down is, that as soon as the outside roots of the trees touch each other the temporary trees should be removed. I need scarcely write the usual directions as to the trees being fenced round if horses and cows are turned into the orchard—that the trees should have stems at least six feet in height, and the lower branches should be taken off as soon as they become depressed enough for cattle to browse on them. One direction I feel, however, bound to give: a circle from three to four feet in diameter round each tree should be kept clear of grass and weeds for at least five years from the time of planting; after that period grass may be allowed to cover all the surface as in old orchards.

In preparing the slips by trenching, if the subsoil be poor and stony, it should not be brought to the surface but be merely turned over with the spade, and some manure mixed with it, replacing the turf and keeping the loose mould on the surface. If the soil be wet, drains four feet deep should be made twenty-four feet apart, one in the centre of the space between each row of trees; they should be made by careful workmen, and filled in with bushes if drain pipes are not at hand; before the drain is closed, it should be left open for the examination of the master and carefully proved. The soils best adapted for orchard trees are, first, loams with a subsoil of lime-stone; second, loams resting on a dry stony subsoil; third, loams resting on clay—

these should be drained. Light sandy loams, with a subsoil of sand, chalk, and gravel, are not adapted for standard orchard trees unless the staple of loam is from two to three feet thick.

INSECTS PECULIAR TO THE PEAR

THE young fruits as soon as formed are pierced by a small weevil (*Rhynchites*), and an egg deposited which causes the fruit to swell to a size altogether disproportionate, and after the lapse of a month to fall to the ground; there is no remedy for this other than the immediate destruction of the fruit, which can be at once detected by its abnormal size.

Another pest common to the pear and apple adheres to the bark of the tree, forming a thick layer; this is the pear-tree kermes. As weakly trees only are attacked, the best remedy is probably to root out the tree to prevent the extension of the insect; when noticed, if the tree is not sacrificed, the bark should be scrubbed with a hard brush and then washed with soft soap and quassia.

The slugworm—a small, black, shiny caterpillar—makes its appearance in August, September, and the early part of October; the tree should be dusted with quick-lime as soon as noticed, and the dose repeated when necessary.

The pear-tree oyster scale, a small insect formed on

the bark, should be rubbed off by a hard brush with soap and water and sand.

For the numerous caterpillars and larvæ which attack the pear tree there is one very simple and practical remedy, viz. the finger and thumb. The 'aphis,' which is a common pest to all fruit trees, must be very narrowly watched in the spring as soon as the young leaves are developed, and should be treated with the following mixture:—Boil four ounces of quassia chips in a gallon of soft water until the bitter principle has been extracted, the time required being from twenty-five to thirty minutes; in this mixture dissolve at the time of application four ounces of soft soap to the gallon, and apply hot if possible (up to 150° will not hurt the tree); but if it is inconvenient to use hot water, cold will answer the purpose. If trees have been severely attacked by aphis they should be washed during the winter with the above mixture.

The American blight (*Aphis lamigera*) is peculiar to the apple, and is destroyed by the above mixture. On the branches of two years and upwards an application of petroleum and milk will be useful, but the bark must be quite sound at the time of application. Vinegar is very destructive to this insect, probably the more adulterated the better; it is easy to apply and to obtain.

If the aphis descends to the roots, soot should be applied.

The pear is often attacked by a disease which has the effect of rendering the bark rough and scaly, pre-

senting almost the appearance of canker; a slight examination will, however, determine whether the disease is deeper than the bark. Washing the parts affected with a mixture of soot, lime, and sulphur will remove the roughness and restore the tree to health; if the above materials are mixed with skim milk the mixture is more enduring; the disease often shows itself after severe frost, and probably arises from a rupture of the cells.

A bright orange spot will often make its appearance on the leaves. During the summer the leaves thus affected must be at once removed and burnt; if left on the tree the spot will develop in several nipple-like protuberances, which will burst and scatter spores for future germination, and the whole tree, bark, and leaves will be attacked, and ultimately destroyed.

MANURES

In heavy, cold, and wet soils horse manure should be forked lightly into the ground in the autumn and spring; when the soil is light and sandy, cow-dung should be mixed with it. Kiln dust mixed with night soil is an excellent surface-dressing, and soot should be given liberally, particularly where a deficiency of colouring is observed in the fruit. In all non-calcareous soils, chalk, lime, gypsum, and phosphate of lime should be freely used; the absence of lime in soils is often the cause of failure; all plants contain lime, and it must therefore be supplied when non-existent.

PLANTING

In most cases it is only necessary to open holes, but in stiff and cold clay soils the bottom of the hole opened should be filled in with gravel or brick rubble, and the tree planted on a mound; but in ordinary well-drained soils it is sufficient to open holes for the trees in accordance with their size; the bottom of the hole should be convex, so that the water does not settle in the middle. The holes should be opened some three weeks before planting, and the best soil reserved for the roots; at the time of opening the holes mix the soil with good rotten dung, and chalk or lime if necessary. If the weather is very dry at the time of planting, the trees should be watered during the operation, but it is very seldom indeed that the weather during our autumn requires this treatment. The soil should be lightly and firmly pressed round the roots, which should be carefully laid out radiating from the stem, so as to form ultimately a secure support for the trees, no matter from which quarter the wind blows. If the trees are slender fasten them to a stout stake, which they will need until they are firmly established.

Another method of growing small pyramid trees (that is, from seven to eight feet high) in soils naturally bad, can be employed with perfectly good results, and makes the fruit-tree amateur independent of soil. Plant the trees in large pots, No. 6 or No. 4, which have been perforated at the sides (this will be done by the potter

if so ordered), and pot the trees with soil prepared for them. When planted, fill in a space of one foot or more round the outside of the pot for the roots to feed on when the soil of the pot is exhausted; every autumn clear away this and fill in with fresh soil, increasing the bulk, at the same time cut off every root close to the pot that has passed outside; this is another form of root-pruning, but it provides an absolute independence of soil. The trees will not make a strong growth, but they will be fruitful and will require little or no pruning; stout boxes, with holes or chinks for the emission of roots, will answer, but they are not of course so durable as the pots.

PROPER DISTANCES FOR PLANTING PYRAMIDAL AND OTHER FRUIT TREES

PYRAMIDAL pear trees and bushes on quince stocks to be cultivated as root-pruned trees for small gardens, four feet apart.

The same, in larger gardens, not root-pruned, six feet apart.

Pyramidal pear trees on the pear stock, root-pruned, six feet apart.

The same, roots not pruned, eight or ten feet—the latter if the soil be very rich.

Horizontal espalier pear trees on the quince stock, for rails or walls, ten feet apart.

Upright espaliers on the quince stock, for rails or walls, four to six feet apart.

Horizontal espaliers on the pear stock, for rails or walls, twenty feet apart.

Pyramidal plum trees, six feet apart.

Espalier plum trees, twenty feet apart.

Pyramidal and bush apple trees on the Paradise stock, root-pruned, for small gardens, three to four feet apart

The same, roots not pruned, six feet apart.

Espalier apple trees on the Paradise stock, fifteen feet apart.

The same on the crab stock, twenty feet apart.

Peaches and nectarines, for walls, fifteen to twenty feet apart.

Apricots for walls, twenty feet apart.

Apricots, plums, cherries, and apples, as single diagonal cordons, eighteen inches to two feet apart.

Cherries, as bushes and pyramids on the Mahaleb stock, root-pruned, for small gardens, four feet apart.

The same, roots not pruned, six feet apart.

Pyramidal cherries, on the common cherry stock, six feet apart.

Espalier cherry trees, for rails or walls, fifteen to twenty feet apart.

Vertical or diagonal single cordons of apples and pears, eighteen inches to two feet apart.

Proper distances for trees against dwarf walls, annually or biennially removed (see pp. 39 to 42) are for—

Pears on quince stocks, five feet apart.

Peaches, nectarines, apricots, and plums, five feet apart.

Cherries and apples, five feet apart.

MINIATURE FRUIT GARDEN CALENDAR



January.—In mild weather, planting, root-pruning, lifting, and replanting may be carried on. Some soils encourage the growth of moss on the branches of trees; lime may be sprinkled on them, or they may be painted with lime and soot formed into a thin paint with water.

February.—If the weather be mild, trees may still be planted without fear; the truth is, the modern system of growing fruit trees on dwarfing stocks, and removing them occasionally, makes them safe to plant very late or very early.

March.—Towards the middle of the month protecting to retard the blossom-buds is good practice. Planting of prepared or oft-removed trees may still be safely practised.

April.—Protecting should still be attended to.

Planting of pears on quince stocks with the buds on the point of expansion (see p. 61) may be tried as an experiment; here they often bear the finest fruit.

June.—Summer pinching must be strictly attended to; the young fruit in clusters should be thinned,

removing from pears and apples about half their number.

July.—The very early kind of pears should be gathered before they are quite ripe.

August.—Early ripening pears—viz., sorts that ripen in September—may be gathered, unless the season be late.

September.—Shortening the shoots may be done; gathering of early pears before fully ripe to be attended to. Towards the end gather apples and pears that ripen before Christmas.

October.—Towards the middle of the month planting may be commenced; and if the rain has penetrated sufficiently, root-pruning may be done; also lifting and replanting (see p. 14). About the middle gather late pears.

November.—Planting, root-pruning, lifting, and replanting may still be safely carried on.

December.—All the operations of last month may still be practised if they have been forgotten or neglected.

Always bear in mind that a vigorous-growing tree that does not bear fruit requires being lifted and replanted—even annually—till it becomes fruitful, and that a tree that bears well and makes annual shoots under twelve inches in length, requires neither root-pruning nor removal, but merely summer pinching of its shoots to about half their length.

The following extract from a letter is interesting, as

an indication of the sorts of pears which succeed at Jedburgh:—

‘And now for some account of your pears; I procured a maiden plant of Beurré d’Amanlis, which, in 1875, growing in the midst of my seedling fir beds, had reached the height of eight feet. This bush, seven and a half feet in diameter, produced 820 pears, which weighed ten stone seven pounds; very fine fruit.

‘You published some years since a note specifying the success of Beurré Hardy pear at Kelso; a year before the specimens were sent to you, I grafted a plant, filling a portion of a low wall, only seven feet high by sixteen feet in length; in 1875 my grafts of the Beurré Hardy produced 500 large pears, weighing eight stone. From Conseiller de la Cour I have had crops of most delicious fruit. It is really a grand pear.’

CANKER.—In a lecture delivered at Birmingham by Mr. Edmund Tonks, he proposes the following ingredients as an effective application for the cure of this disease:

Superphosphate of lime	.	.	.	lbs.	35
Nitrate of potash	.	.	.		21
Nitrate of soda	.	.	.		28
Sulphate of lime	.	.	.		28

in the proportion of a quarter of a pound to the square yard applied in the autumn and spring. To my knowledge this dressing has had an extraordinary effect in some cases, and has restored diseased trees to good health.

APPENDIX I



THE GROUND VINERY

THE 'Curate's Vinery,' described in the tenth edition, was contrived by Dr. S. Newington, of Ticehurst, and consisted of a ridge of glass placed over a furrow lined with slates, so that the bunches of grapes were suspended in the furrow, and in warm seasons ripened well. One objection to the furrow was its liability to be filled with water in wet weather, in low situations and heavy soils. I therefore sought to remedy this, and one day, about the end of June, 1860, I found myself looking into my original 'Curate's Vinery,' and admiring the vines then in blossom, although those within a few yards of it growing in the open air were scarcely in full leaf. I pictured to myself the bunches of grapes suspended from the vines in the warm, moist atmosphere of the trench lined with slates. My thoughts then reverted to my boyish, grape-loving days, when in an old vineyard, planted by my grandfather, I always looked for some ripe grapes about the end of September; and I vividly remembered that I always found the best and ripest

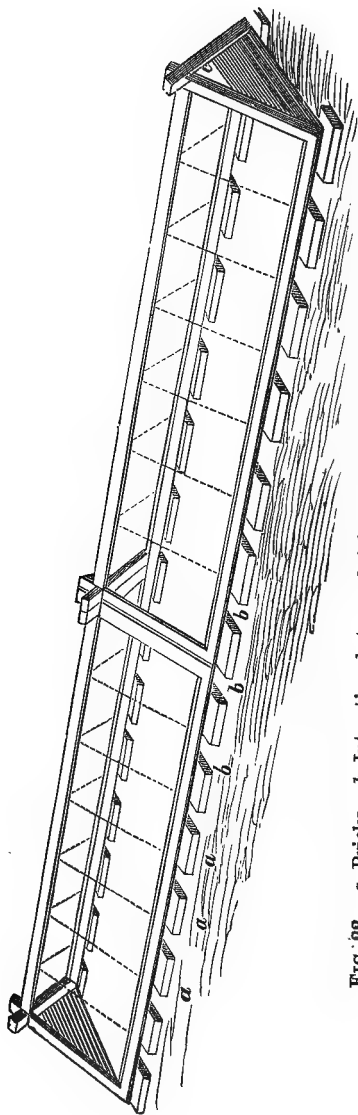

FIG. 22.—*a*, Bricks. *b*, Interstices between bricks. *c*, Opening for the egress of heated air.

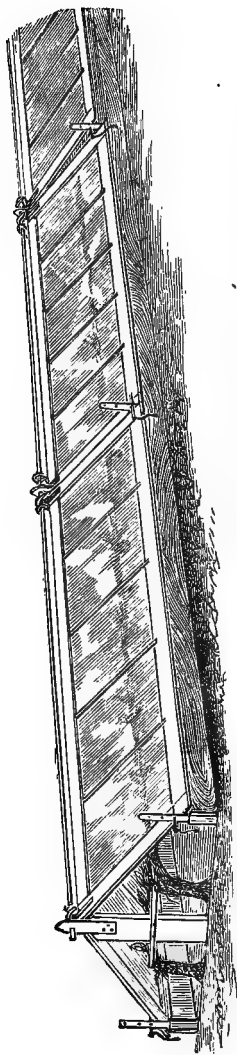

FIG. 23.—The ridge of this new appliance is simply formed of gas-piping, on which the lights are hooked; these are quite securely set, and easily removed; they can also be turned back resting on the opposite side of the ridge.

bunches with the largest berries lying on the ground, and if the season were dry and warm, they were free from dirt and delicious, and so I gradually travelled in thought from bunches of grapes lying on the ground to the same lying on slates.

The idea was new, and I commenced at once to put it into practice by building a 'Curate's Vinery' on a new plan.

I therefore placed two rows of bricks endwise (leaving four inches between each brick for ventilation) on a nice level piece of sandy ground, and then paved between them with large slates ('duchesses') placed crosswise. I am, however, inclined to think that tiles may be preferable to slates; absorption of heat is greater and radiation slower. On the bricks I placed two of the ridges of glass, as given in the foregoing figure, each seven feet long, and thus formed my vinery, fourteen feet in length. The vine lies in the centre of the vinery, and is pegged down through the spaces between the slates. One vine will in the course of two years fill a vinery of this length; but to reap the fruits of my project quickly, I planted two vines, one in the centre, the other at the north-east end—for these structures should stand north-east and south-west. One of these vines, which had been growing in a pot in the open air, was just beginning to show its fruit-buds—it was quite the last of June—its fruit ripened early in October, and were fully coloured and good in spite of the cloudy cold autumn. My black Hamburgh

grapes in my ground vineries were fully ripe by the first week in October. I therefore feel well assured that grapes lying on a floor of slates such as I have described will ripen from two to three weeks earlier than in vineries of this description with a furrow, and as early as grapes in a common cold vinery. Black Hamburgs, and other kinds of grapes not requiring fire heat, may thus be grown in any small garden at a trifling expense. I am, indeed, disposed to hope that the Frontignans, and nearly all but the Muscats, may be ripened by this method, so intense is the heat of the slated floor on a sunny day in July.

Some persons may think that the heat would be scorching, and that the leaves and grapes would alike become frizzled; but few gardeners know the extreme heat a bunch of grapes can bear. I remember a lady friend, who had resided some time at Smyrna, telling me that one afternoon at the end of the summer, when the grapes were ripening, she was sitting in her drawing-room and admiring some large bunches of grapes hanging on a vine which was growing against a wall in the full sunshine. Knowing the danger of going into the open air without a parasol, she rushed out, cut a bunch of grapes, and returned to her seat in the shady room. The bunch of grapes was so hot that she was obliged to shift it from hand to hand. I observed in the hot weather we had in July, 1859, one or two branches of Muscat grapes nearly touching the chimney of a stove in which a fire was kept up every morning,

gradually turning into raisins. I felt some of them when the sun was shining on them; they were not burning hot, but next to it. I allowed them to dry into raisins, and very fine they were, but not better than the finest imported from Spain.

With respect to the superior ripening power of slates or tiles placed on the surface of the earth, I was much interested in once hearing a travelled friend say that when he was at Paros, he observed many vines trained up the marble rocks peculiar to the island; and in all cases the grapes lying on the surface, which was almost a continuous mass of rock, were ripe, while those a few feet from it, on the same vine, some of the branches of which were trained up the wall-like rocks, were quite green. In telling me this, he said he was never more impressed with the ripening power of the earth's surface.

I have, in giving the figure and description of the ground vinery, adapted for one vine, the width of it being 2 feet 6 inches only. If this width be increased to 3 feet 6 inches, two vines can be trained under the same roof 14 inches apart, and thus at a trifling additional cost double produce can be obtained.

Cultivators will think of red spider making his home in such (for him) a happy, hot place; but he may be made so uncomfortable by keeping flowers of sulphur strewed over the slates till near the ripening season, that no inconvenience need be apprehended. It will be perceived that the ventilation is all lateral,

and on the same principle as that of my orchard-houses; nothing can be more perfect. In the figure it will be seen I have left a small aperture under the apex of the roof for the escape of rarefied air. In very hot weather this may be useful, but in my slate-floored ground vineries I have not done this, and yet the ventilation is perfect. I have not yet ascertained in what manner the heated air escapes. The ventilating apertures are all on the surface of the soil, and at the same level; but I suppose it stoops to get out, having no other mode of egress.

DIMENSIONS OF GROUND VINERIES

No. 1, for a single vine in centre

Width at base	30 inches.
Slope of roof	20 inches.
Depth in centre	16 inches.

No. 2, for two vines 14 inches apart

Width at base	42 inches.
Slope of roof	28 inches.
Depth in centre	20 inches.

These dimensions need not be arbitrary, for ground vineries of larger dimensions may be made with every chance of success, and Hamburgh grapes grown in Bedfordshire instead of cucumbers; for no part of England can be more favourable to grape culture than the fertile, sandy districts of a portion of that

county. We have heard of forty acres of cucumbers being grown for pickling, and one day we may hear of forty acres of grapes in ground vineries in some favourable locality. To form a vinery (p. 152, fig. 22), described above as No. 1, two seven-foot lengths are required; these I find from experience are better made of wood than iron, which is heavy and expensive; they are now made three feet wide at base. Their size may also be increased to 3 feet 6 inches, as described under No. 2, but they must then be placed on a wall two bricks in height, leaving apertures, four or five inches wide and six inches deep, for ventilation; this increase of ventilation is absolutely necessary with No. 2. The glass used should be 21-oz., as 16-oz. is too slight. As the vines in ground vineries often put forth their young shoots early in May, and are apt to be injured by a severe May frost, it is good practice to keep some refuse hay strewed over the glass when there is any chance of frost in that month, or to cover the ridges with mats.

In gardens where these glass ridge roofs are not wanted for vines, or fruit-tree culture, they will be found most useful. They may be placed on any warm border on bricks; and early peas, French beans, and many other early vegetables requiring protection from spring frosts, be grown under them with advantage. For the cultivation of the early strawberries they are invaluable, as they not only hasten the ripening period, but protect the fruit from heavy summer showers, often

so injurious to the crop, and also from birds. Strawberry plants, to be cultivated in ground vineries, should be planted early in autumn in narrow beds of two or three rows, the plants close together in the rows, so as to take full advantage of the glass-covered space. The rows should be 9 inches apart, and the plants in the row the same distance from each other; the beds should be made every season on a fresh piece of rich soil; and as much fruit as can possibly be grown in such a limited space must be the aim of the cultivator. If the ridges are devoted to strawberries only, much care is required in their culture, the runners should be carefully removed, and the glass ridges taken off after the fruit is gathered, and not replaced till November; the plants will require water and surface manure during the summer. In all cases the ridges should be placed on bricks, with spaces between them. Ventilation is then secured; and even cauliflower plants in winter will do well without the constant attention to 'giving air,' so necessary in the old garden frame culture. Lettuces, for early salads, succeed admirably in these structures; they should be planted in October. In gardens that are confined and very warm, I repeat it may be necessary to have a small opening left at the top, at *a* in the figure, just under the ridge, to let out the heated air, and two rows of bricks instead of one; but my vineries stand in a very exposed place, and do not require it.

On p. 153 I have given a diagram of a new plan of ground vineries; it is exceedingly simple; gas-piping

and a few oak posts support the lights, which are hooked on, and can be taken off and stored when not required. The same principle, i.e. the gas-piping and the lights with hooks, will make a very cheap and efficient glass coping for walls.

PLANTING AND PRUNING VINES FROM POTS

THE most preferable seasons for planting vines from pots are in October and November or in March, the latter to be preferred, and if vines can be placed in a cold vinery or under a garden frame till their young shoots are two inches long, they had better be planted in April, as they seem to start with greater freedom when their young shoots have commenced to grow. The mode of planting as practised here is simply to mark out a piece of ground 3 feet square at the end of fig. 22, and to dig it 2 feet deep, mixing with the soil, in digging, a coat of manure from four to five inches thick, placed on the surface before digging; the vine should not be planted under the glass, but outside, at one end; it should at once be pegged down with two or three hooked pegs thrust into the earth through the interstices between the slates in the centre of the floor. If vines from the open ground are selected, they should be planted early in March, and cut down to two eyes; if strong vines from pots are planted, they should have

their roots carefully divided and spread out ; to do this the ball of earth should be squeezed between the hands so as to loosen it thoroughly, and after planting, water should be given, the earth filled in, and after about ten days the soil round the vine should be trodden firmly. The vine from a pot, if strong and from seven to nine feet in length, should be shortened down to three feet, or, say, to eleven or twelve buds, not counting the buds within nine inches of the ground ; every bud will show a bunch of fruit ; all but three or four bunches should be removed, and every side shoot except one should be shortened as soon as it has made, say, five leaves ; the one to be excepted is the leading shoot, which, if the vine is growing tolerably well, may be suffered, even the first season, to grow from four to five feet before it is stopped : this leader may require being stopped a second time the first season if it is in a vigorous state. In the autumn (mind this is the first season) the young leading shoot may be cut down to about twelve eyes, or within three feet of the old wood, i.e. the shoot left on the vine when planted ; the latter will be furnished with spurs, and each of these must be shortened in the autumn to two eyes ; the time for pruning is towards the end of October. After the fruit is gathered, and at this time only, the ridges may be removed from the vine, and remain off for a fortnight. The pruning in succeeding years is very simple ; you have merely to shorten the leader to three or four feet, or less, and the spurs to two eyes, annually in October.

During the winter, if the vineries are standing in an exposed situation, they should be secured from the wind by driving a few stakes down on each side.

In spring, if the vines put forth their young shoots in April, they are apt to be killed by a spring frost, as is too often the case with the vines of France; this can, however, be easily averted in ground vineries, either by keeping constantly a covering of hay or straw on the glass when the weather is cold, and frost likely, or by covering the ridges with the small mats which are so convenient and so cheap, whenever the thermometer declines to 40° at 7 P.M.

There are still more ills to guard against in ground vinery culture, for mice and birds, as rats often do in common vineries, attempt to have too large a share of the fruit; they enter by the interstices between the bricks and devour and spoil many bunches; thrushes are particularly vigilant in looking after grapes, and may be trapped; but both they and the mice may be kept out by galvanised iron netting six inches wide, placed along the whole length of the vineries.

I have but little to add to my description of the management of ground vineries; their uses are endless, for not only are the finest of pears grown in them, but peaches, apricots, plums, and strawberries may be cultivated with great success; and then as winter quarters for bedding plants they are excellent. For this purpose the bricks should be removed in severe weather, and the glass ridges thickly covered with straw; they

are then perfectly frost-proof; in mild weather in winter the ventilating bricks may be replaced, and the straw removed till frost again occurs.

With respect to the most preferable dimensions for these structures—the size No. 1, thirty inches wide at base, will suffice for one vine in the centre for ten years or so; but as I perceive my old vines to be a little straitened for room, I advise a width of three feet at the base, and No. 2, for two vines or two cordons, of three feet ten inches, instead of three feet six inches.

In these more roomy structures the vines may be trained to stout galvanised iron wires, supported with iron rods flattened at top and perforated, so that the wire passes easily through; these wires should be about one foot from the surface of the slates, and the suspended bunches, partially resting on them, will ripen admirably. I ought to add, that a friend with much gardening experience finds his strawberries ripen ten days earlier than those in the open air, and his melons, planted on new, fresh, fermenting manure, in a trench, are free from red spider, and produce fine fruit. It is the constant ventilation, night and day, and the heavy dew, the result of arrested radiation, that seems to baffle this tiresome plague; for although my vines are never watered or syringed, they are always vigorous and free from red spider. The most eligible varieties of grapes for ground vineries are, the Black Hamburgh, Buckland Sweetwater, Royal Muscadine, Early Smyrna Fron-

tignan, Trentham Black, Early Saumur Frontignan, and Esperione.

Any suburban garden ten yards square, if in a sunny situation, may have one or two of these vineries, and the owner or occupier may grow his own black Hamburg grapes, known by most of the Londoners as 'hot-house grapes.' I ought to mention that the improved ground vinery, with gas-pipe ridge, so that the side opens and gives access to the interior, is the best of all.

CORDON TRAINING

By T. FRANCIS RIVERS. Extracted, by permission, from the
'Journal of Horticulture,' Nos. 356-57, 1868.

THE introduction of the system of training fruit trees, called by the French cordon training, leads me to suppose that a few outlines of description may not be unacceptable. This system of training is remarkable for simplicity, and I propose to give the necessary directions in as few words as possible.

The preparation of the ground is so well understood that it is not necessary to say much on this point. To form the oblique cordon orchard, a trench should be dug, about two feet wide, the first spit of soil being thrown out as if for a celery trench; the under spit should then be broken up and left with the top soil, a good proportion of well decomposed manure must be mixed, and

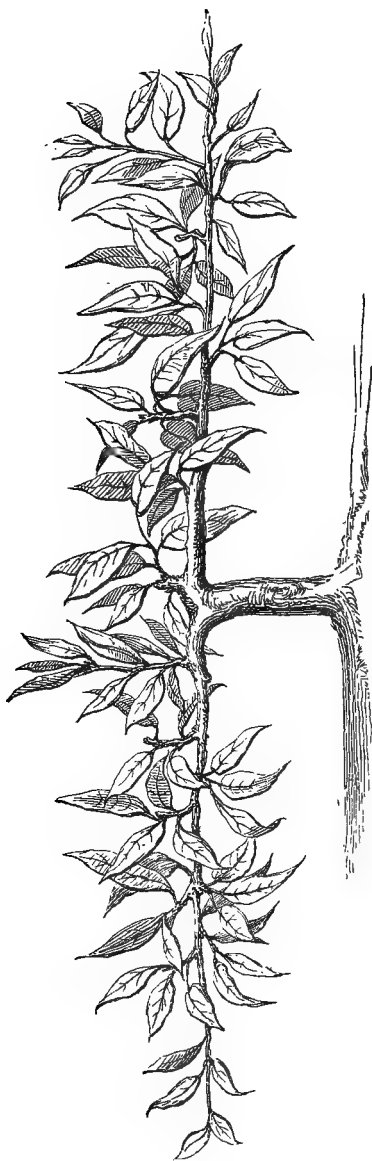

FIG. 24

the ground is ready for planting. The trench should, if possible, be made a fortnight before planting, in order that the soil may be thoroughly pulverised. If there is any deficiency of lime in the soil, it is as well to add lime rubbish or chalk. For horizontal double cordons a trench is not necessary; holes should be dug about two feet in diameter, and the soil mixed with good compost. The double-cordon trees should be from twelve to fifteen feet apart; the horizontal single cordons six to eight feet.

Fig. 24 represents a double horizontal cordon. This may be made by cutting down a dwarf maiden tree to within four or six buds of the base, the two topmost buds of which must be selected to form the cordons. The highest on the stem are the most eligible; but the operator can, of course, select the two shoots which are most convenient for his training wire, and they should be as nearly as possible opposite. When sufficiently advanced in growth to be flexible, they should be carefully bent down and fastened to short sticks, unless the training wires are used. As the whole energies of the tree are directed into these shoots, they will make rapid growth, and as they advance fresh sticks and fresh tying will be necessary. As any lateral or upright shoots are put forth they must be stopped at three or four leaves from their bases. The first year few of these will be made, but the tree will most probably, if there is a favourable growth, be studded with fruit buds. In November, or, indeed, any month from November to

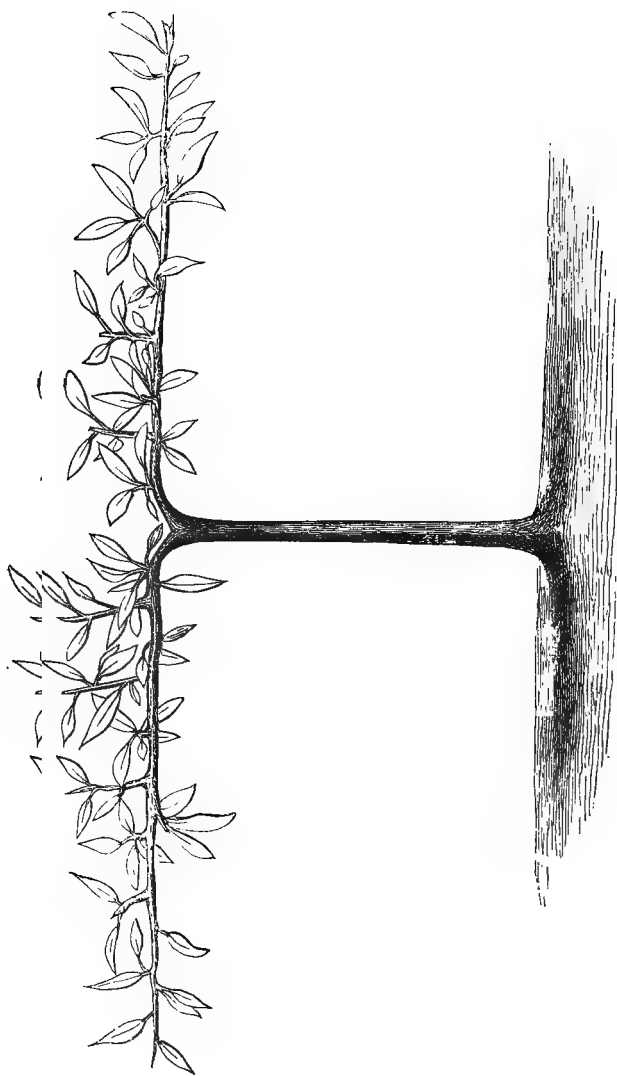

FIG. 25

March, the tips of the main shoots should be shortened three or four buds from the ends, and, unless a few lateral shoots have been left, which should be removed, the pruning for the second year will be accomplished.

The second year each cordon or branch will produce many lateral shoots, and as these are successively produced they should be pinched. The first pinching must be done when the shoot has formed five or six leaves, and, as a general rule, three leaves from the leaflets should be the stopping point. This primary shoot will form the bloom buds, and the shoot made from the terminal bud must be stopped in the same manner as the first. Discontinue pinching after June. By this time the cordon will be thickly studded with wood and fruit spurs; to thin out and regulate these will form a pleasant winter morning's work; the final pruning must therefore be deferred until October or November.

The tree after the second year will assume the appearance of a cordon—i.e. a thick rope of closely studded shoots, and the pruning must be left to the judgment of the operator. Many shoots must be removed; and as the size and strength of the tree must regulate the number of fruit-bearing spurs, a sufficient number of these being left, the operator should prune all others to wood-buds, in order to produce, year by year, an alternate succession of fruit-bearing wood.

Fig. 25 is a half-standard double horizontal cordon. This is very useful for low walls in gardens; where the border is occupied by flowers or other plants, the

part of the wall exposed to the sun may thus be used. A standard cordon with a stem six feet high may also be used for the top of the wall, the main surface being occupied by other trees. A cordon fringe, or cornice, will be found exceedingly ornamental, and may be carried the entire length of a wall, the standards being planted at intervals of twenty feet or more.

Many other forms of cordon training will, doubtless, be discovered as the system becomes better known.

Single horizontal cordons (fig. 26) require the same pruning as the double, but the dwarf maiden tree does not absolutely require the cutting-back necessary for double cordons. The tree may be planted in a slanting position against the training wire, and the shoot tied down. The first year after planting, most of the buds will break and produce shoots; these must be treated in the same manner as the double horizontal cordons. If a single cordon is required for a special height, the shoot should be shortened to the height required, and a single horizontal shoot selected to form the cordon.

Single oblique or diagonal cordons may be planted to training wires by the sides of walks, or in rows in the garden devoted to their cultivation. The space given up to them will yield an ample and quick return in fruit. They may be planted $1\frac{1}{2}$ ft. apart, and if the cultivator does not object to wait a year, dwarf maiden trees are the best to plant, as they may be bought cheaply. The trees should be planted upright, and the

shoots, which are generally very flexible, should be bent to an angle of about 45° . It is not necessary for the

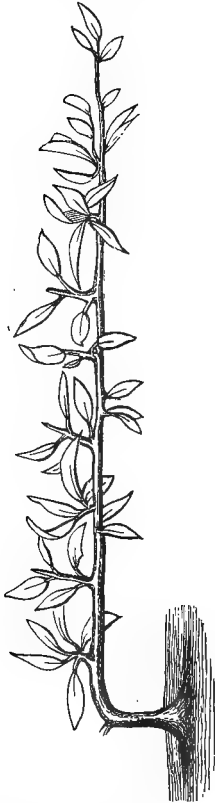

FIG. 26

angle to be quite exact, but, as a general rule, this angle may be adopted. If the shoots are not flexible enough to bend, plant the tree in a slanting position.

The principle of pruning given for double horizontal cordons must be followed in the cultivation of single oblique cordons. They will the first year after planting be found covered with bloom-spurs. Single oblique



FIG. 27.—A photograph of Doyenné du Comice.

cordons in rich and fertile soils will probably require root-pruning as well as spur-pruning, and, if necessary, this should be done every second year. The tree should not be taken up, but the spade pushed down at a sufficient distance from the stem to avoid injury to

the main roots, and the tree gently heaved. If a tap root has been made it should be cut. The proper time to perform this operation is near the end of October and any time afterwards to the middle or end of February; but it is better done in October and November, as many fresh roots will be formed after the operation, even during what are called the dead months of the year.

Single oblique cordons may be carried to the height of ten or twelve feet; in fact, there is no limit, except the will of the planter. A fresh string of wire may be added annually as the cordons increase in length. They may also be limited to the height of four or five feet.

Fig. 27 is from a photograph of an upright-trained tree, with five vertical cordons springing from a common base. Trees may be purchased already trained in this form, but the double horizontal cordon may at pleasure be changed into this form by selecting strong shoots at regular intervals, fastening them to stout stakes, and summer pinching them as practised for oblique cordons.

Fig. 28 is a fan cordon, and the advantage of the simple method of summer pinching will at once be seen. Instead of a wall being perforated all over with nails few only are required to fasten the shoots selected for cordons. This form may consist of five, seven, or more cordon branches. The symmetry of the tree should be the point most strictly attended to, a symmetrical tree

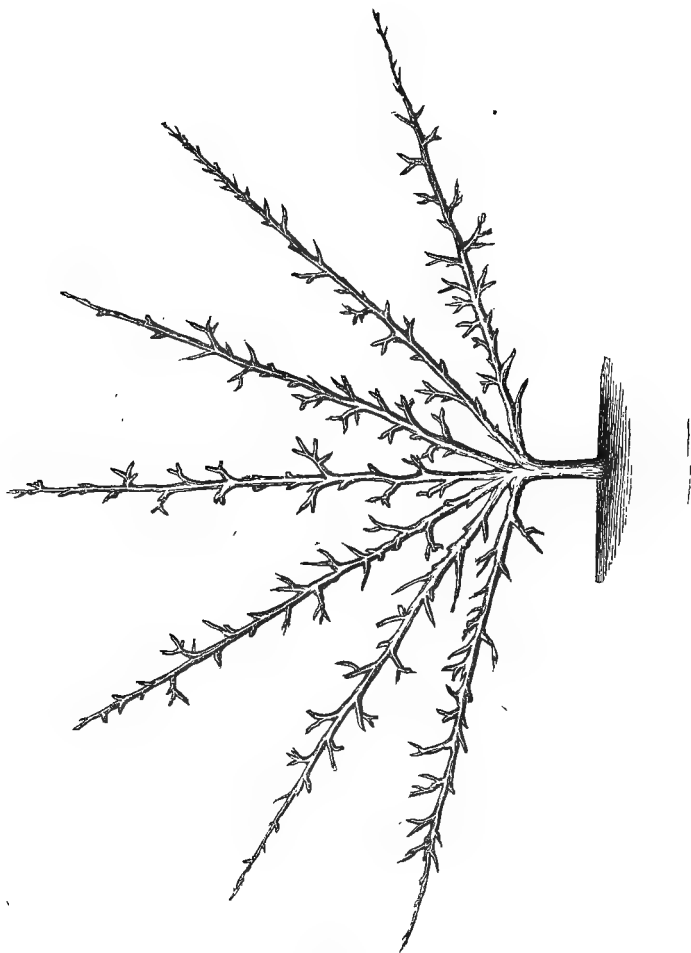

FIG. 28

being more pleasing to the eye than one irregularly shaped. The same method of pruning is required as for oblique cordons.

Fan cordons can be managed by an unscientific gardener, but to produce one well-shaped on the usual plan requires a skilful and practised hand. It is possible that in the northern and westerly districts peach and nectarine trees will produce too many unripened spurs, but probably by attention and strict thinning this difficulty will be surmounted. It is not yet sufficiently known that apricot fan-shaped trained trees may be made, by the most simple management of cordon training, most prolific and easily managed wall trees. The method is this: as soon as the tree has formed a perfect-shaped tree, no more shortening of shoots or 'laying in' of young should be practised, but every branch should be made into a cordon by summer pinching, i.e. nipping off early in June every side shoot to four or five leaves, leaving the end of the cordon shoot untouched till, say, February, when, if it be more than 30 inches in length, it may be shortened to 20 or 24 inches. Peaches, nectarines, and all other kinds of wall fruits may be grown after this cordon system, and if the walls be not very extensive, much room may be saved by adopting the five-branched upright cordon (fig. 27, p. 171).

With peaches and nectarines in rich soils it may be necessary to leave one shoot on each branch as an exhauster—an unpruned shoot—or to lift the tree

once in three or four years. I should add that the exhauster should be cut down in winter to three or four buds.

Fig. 29 is a double oblique cordon, formed by cutting down the dwarf tree to two buds, and proceeding as for oblique cordons.

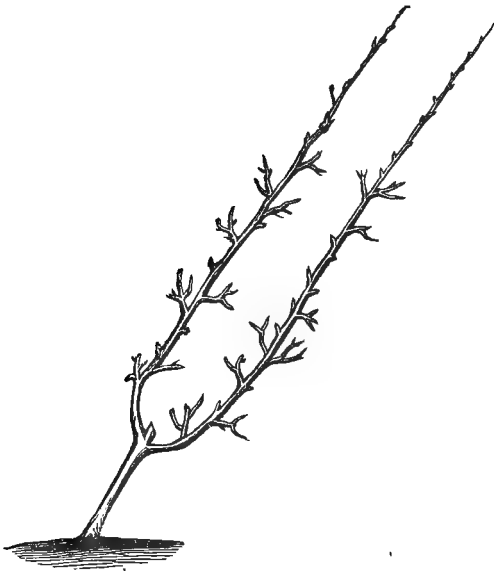
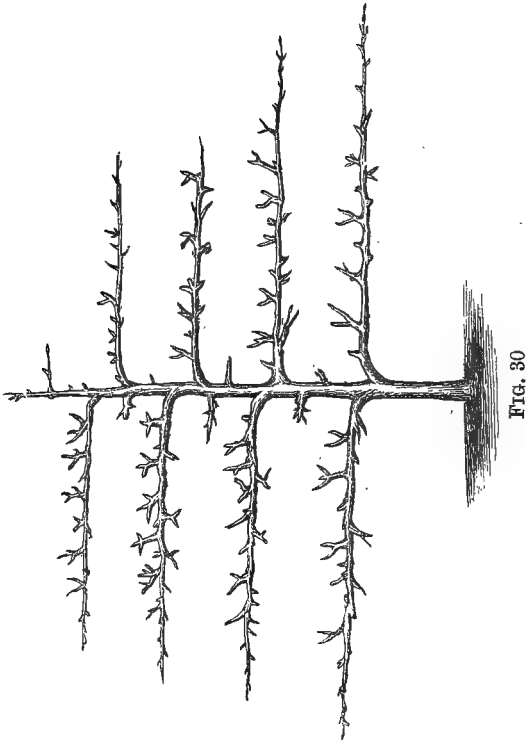

FIG. 29

Fig. 30 represents a compound horizontal cordon. This should have a central shoot and branches trained from it as nearly opposite as possible. This system has long been used for pears and apples, but not so generally for stone fruits. It is well adapted for

peaches, nectarines, apricots, cherries, and plums. All of these may be trained as compound horizontal cordons in the colder climate of Yorkshire.



A very skilful cultivator of fruit in Yorkshire has trained cordon peaches and nectarines with complete success, and to counteract the tendency of these fruit trees to produce much unripened wood, when under

cordon training, he leaves on every horizontal branch an upright shoot which he calls an exhauster. This shoot forms an outlet for the superfluous energy of the



FIG. 31

tree; and the fruit spurs, being deprived of the superabundance of the vital fluid, do not break into growth. This theory will be found to be very sound practice, and should be used wherever there is a ten-

dency on the part of the tree to produce many unripened spurs. This mode of training for the pear and apple is already well known; and when applied to peach and nectarine trees, the only deviation from established practice will be to treat every horizontal branch as a cordon, and to practise summer pinching instead of allowing gross upright shoots to be made.

Fig. 31 is a single vertical cordon in a pot; and if an orchard house or glass shed is available, these will be found very useful and interesting trees. Pear, apple, cherry, and plum trees may be potted into 10- or 12-inch pots, and moved into a glass shed, or, indeed, any shed open to the sun, while in bloom, and kept under cover until all danger from spring frost is past. They should then be removed to a border prepared for them—the warmer and more sheltered the better. The pots must be plunged to within one or two inches of the rim, stable litter partly decomposed and spread over the pots and the soil; as the trees will require watering they should be placed near water. One-year-old dwarf trees may be bought at a cheap rate and potted. The fruit will be produced in the second year after potting. The soil for the trees should consist of good, strong, calcareous loam mixed with a third of its bulk of decomposed manure. An old cucumber or melon bed may be used; or, if not convenient, stable manure thrown up and fermented for some time will answer very well. The soil must in all cases be made very firm and solid in the pot. The border or bed for their summer

quarters should be six feet wide ; this will take four rows of trees. This distance is perhaps the most convenient for pruning and watering, but it may be increased or diminished at the will of the cultivator.

Under this system trees which appear to be walking-sticks in the winter will become wonderfully fertile ; and if protection in spring can be afforded, the crop is almost certain. As it is possible and probable that during the summer some of the roots will have passed through the bottom of the pots into the soil beneath, it will be necessary, after the fruit is gathered and the trees are at rest, to detach them from their anchorage by taking up the pots and cutting off all the roots that protrude through the drainage hole of the pot. As this operation will break up the summer quarters of the trees, there will be no necessity to replace them at the distance requisite for their summer cultivation. They may be much more closely packed for their winter quarters, plunging them as mentioned before, and during winter covering the pots thickly with straw or stable litter. In this position they may be left without any further care or attention until the returning spring urges them again into fresh activity and fruitfulness.

The Compound Trellis. See diagram, p. 180.

The end posts A A, $3\frac{1}{2}$ by 5 inches of oak, 5 feet 6 inches out of ground, and 3 feet in ground, with blocks 2 feet long, B, and brace C to take the strain, with four rows of No. 13 galvanised wire strained by Raidisseurs, the first 14 inches from ground, and 1 foot apart.

FIG. 32

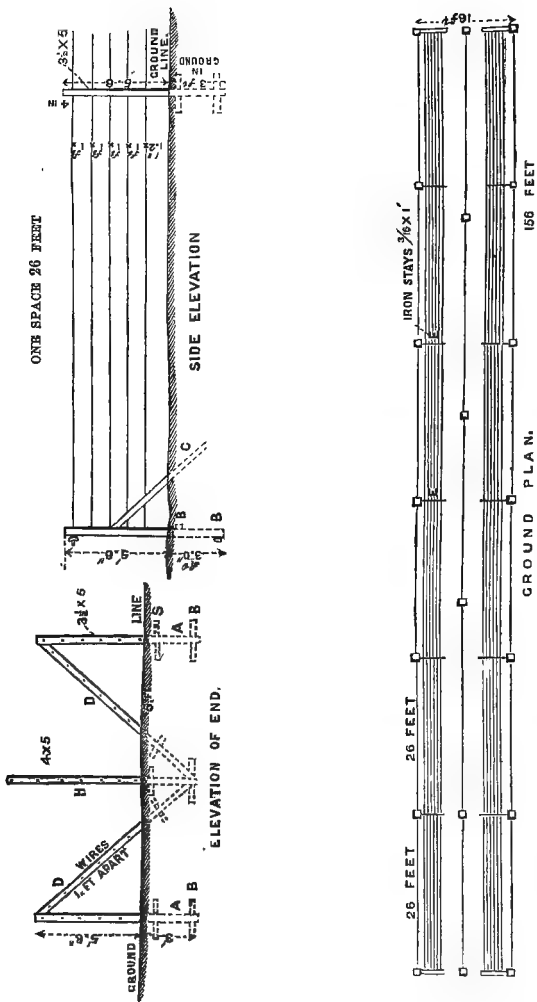

The top No. 7 strand wire is 4 inches from top, strained by screw.

At each end post a brace, 3 by 4 inches, is fixed, 5 feet 6 inches up and 5 feet from post, with intermediate stays of iron, E, $\frac{3}{16}$ inch by 1 inch; in these there are six rows of No. 13 wire, 1 foot apart, and strained the same way as the upright wires.

Middle tier, H, of posts, 7 feet 6 inches out of ground, and 3 feet in ground with stiff brace, are fixed about 35 feet apart, with five rows of No. 13 wire, first row 1 foot 4 inches from ground, three others 1 foot apart, and one between them and top strand, which is No. 7, and fixed 4 feet from top of post.

Length 156 feet, width 16 feet.

The plan of the compound trellis will, I hope, be understood by my readers. The two diagonal trellises D D and the outer trellises A A should be planted with upright cordon trees (see fig. 31). The centre trellis H may be planted with fan-trained trees, either plums or cherries, or, in favourable climates, with peaches, nectarines, and apricots. Plant fan-trained trees on the centre trellis, because they may be planted at some distance apart, 20 feet; the diagonal and the outer trellises plant with plums, pears on the quince stock, and apples on the Paradise stock.

The main object of a trellis of this kind is, of course, to afford protection during the spring, and this, I think, may be given in various ways. The stout wire on the top of the posts is intended to support either mats or

canvas ; as the protection is for a time only, mats will probably be the cheapest. If the protection is intended to last for some years, painted canvas will answer. As protectors for the outer rows of trees, I think straw mats, or hurdles covered with straw, will be the most economical.

For market purposes I should recommend planting Pitmaston Duchess, Doyenné du Comice, Louise Bonne of Jersey, Souvenir du Congrès, Durondeau, and possibly other large sorts of pears ; with good cultivation profitable results may be realised, the first outlay not being very considerable.

The following is an extract from the *Standard* :—

‘The paper which Mr. Barsley read last evening at the meeting of the Society of Arts upon the cultivation of fruits is worthy of the most serious attention. The annual value of the fruits imported into this country is £6,000,000, and of this £2,000,000 is for apples and other hardy fruits which we could grow with advantage here. There is no crop more profitable than fruits, and apple and pear trees, if not planted too closely, admit of vegetables being grown beneath them, so that their produce may be regarded as almost pure profit. And yet only some 40,000 acres of land are used for market gardens throughout the country. Mr. Barsley pointed out that the railway embankments of England represent about 200 square miles, some of which are admirably adapted for fruit culture. Allowing only a third as suitable, it would yet double the present area of

orchards. The lecturer urged that landowners could do nothing more profitable than plant fruit trees, for these soon begin to pay a fair return upon the outlay, and continue to increase in value until they attain a maximum, at which they will remain for many years. Fruit in summer is at once wholesome and refreshing, and the promotion of fruit culture would have a value even as a temperance measure. The large sums paid for hardy fruits, like those paid for foreign eggs and fowls, which could be equally well and very profitably grown in this country, are so much absolutely lost to the country. The subject is one which we hope to see further ventilated at agricultural and farmers' meetings, for it is one of real and national importance.'

SEEDLING PEARS

I HAVE for many years consumed much fruitless time in the painful and tedious process of watching and waiting for the fruits of seedling pears, whose fruition will consume a good fifteen years of a man's life, hoping against hope, as tree after tree was condemned to the axe; but that my reward would come in good time I never doubted, and my perseverance has been rewarded by the success of the 'Conference' pear, which I submitted to the severe and practical criticism of the Committee of the National Pear Congress of October 1885, the name of

‘Conference’ being given by the Committee as a memento of the meeting, being one of the few seedling English pears exhibited at this remarkable gathering. It is singular that it was raised from the baking pear ‘Léon le Clerc de Laval,’ a few pips of which I planted in idleness, my condemned seedlings being raised from pears of the highest excellence. ‘Conference’ is large and of excellent quality, and will always be readily identified by the peculiar salmon colour of the flesh. I may hope that for a century to come it will be one of the Standard English pears.

‘Parrot,’ another of my seedlings, raised from the Gansel’s late Bergamot, was, in the opinion of the Committee, destined to become a very popular pear; the fruit is bergamot-shaped, of a brilliant colour, of fine quality, and of excessive fertility; no other pear of the same class was to be found among the numerous exhibits.

The Committee of the Pear Congress held at the Royal Horticultural Society’s Gardens, Chiswick, during October 1885, selected the following new pears for classification and introduction among the sorts already well known; all are of the highest quality for excellence of flavour, size, and hardiness; they grow equally well on the pear or quince stock, and are specially adapted for walls, pyramids, bushes, or cordons:—

Beurré Giffard	August
Clapp’s Favourite	August
Summer Beurré d’Aremberg (Rivers) .	September

Madame Treyve	September
Beurré Dumont	Oct. Nov.
Pitmaston Duchess	Oct. Nov.
President d'Osmanville	Oct. Nov.
Madame André Leroy	Oct. Nov.
Conference (Rivers)	Oct. Nov.
Emile d'Heyst	November
Beurré d'Anjou	Nov. Dec.
Marie Benoist	January
Beurré de Jonghe	January
Passe Crassanne	Jan. Feb.
Duchesse de Bordeaux	Jan. Feb.
Olivier de Serres	February
Nouvelle Fulvie	February
L'Inconnu	Feb. March

The following were selected and recommended by the Committee for the 'Orchard' or for the 'Market Garden':—

Beacon (Rivers)	Aug. Sept.
Fertility (Rivers)	Sept. Oct.
Souvenir du Congrès	Sept. Oct.
Marie Louise d'Uccle	October.
Durondeau	October.
Conference (Rivers).	November

All these are hardy, very fertile, and of good flavour and brilliant colour; and grow well either on the pear or quince stock as standards, pyramids, or bushes.

APPENDIX II



INSECT PESTS

By H. SOMERS RIVERS]

THE following insects are the most injurious to fruit trees, though some parts of the country, particularly those with a heavy clay soil, seem to be almost wholly free from their attacks.

I. COLEOPTERA (Beetles).

The June Bug (*Phyllopertha horticola*) occasionally, when in great abundance, does much damage to the fruit trees, devouring their blossoms and leaves. The larva, a fat whitish grub, with the last segment of its body larger than the rest, lives underground, where it feeds on the roots of grasses and strawberries. The perfect insect is about half an inch long, and has reddish-brown elytra and dark-green head and thorax.

The Green Rose Chafer (*Cetonia aurata*). The larva of this species is like the last, only larger, and has the same food. The pupa is enclosed in a large cocoon, covered on the outside with pellets of earth. The beetle is about an inch long, of a beautiful metallic green, with whitish spots and streaks running across the elytra, and looking like cracks. It attacks the strawberry blossom,

eating off the anthers, and thus rendering the flowers abortive. Being a large species, this and the last-named beetle may be easily seen on the flowers and picked off by hand; or they may be caught with a bag net whilst flying. If the grubs are numerous, the soil should be turned over and hand-picked. A tame rook or seagull is the best remedy for those at the roots of the plants.

The weevils of the species *Rhynchites*, small metallic blue and copper-coloured beetles, pierce the tops of the shoots of various fruit trees, and lay their eggs in the hole, thus stopping the growth of the shoots. *R. cupreus* lays its eggs in the young plums, and then gnaws round the stem, so that the larva feeds in the blighted fruit.

The family of the *Otiorhynchidæ* contain three exceedingly destructive insects:

The Black Vine Weevil (*Otiorhynchus sulcatus*) is four or five lines in length, of a dull black colour.

The Clay-coloured Weevil (*O. picipes*), rather smaller than the preceding species, is of a reddish-brown colour, mottled with ashy scales.

The Red-legged Weevil (*O. tenebricosus*) is pitchy black and rather shining, with bright chestnut legs.

None of the species have wings, their wing-cases being soldered together. Their bodies are egg-shaped and convex, their beaks short.

The larvæ—legless, whitish, hairy maggots—live on the roots of the food plant of their parents, and are to be found from about August to the following spring.

The beetles seem to be almost universal feeders, attacking vines, apricots, nectarines, peaches, raspberries, strawberries, and nuts, also vegetables. They feed on the shoots, leaves, buds, and bark. The two first-named do great damage, especially to vines in hot-houses, of which they eat off the shoots, whilst their larvæ attack the roots. These weevils are night-feeders, hiding away by day, so that all holes, clods of earth, rubbish, &c., should be examined *carefully*; as they are the same colour as the soil, they are rather difficult to see. A very good plan is to provide them with places to hide under, in the shape of pieces of slate, sacking, wood, &c. When found they should be killed at once, either by dropping into boiling water or by the finger and thumb.

Another weevil which does a good deal of harm, especially in the cider counties, is the Apple-blossom Weevil (*Anthonomus pomorum*). The female attacks the unopened flower-buds of the apple, in which she makes a hole with her beak and lays a single egg, closing the opening after the operation. The bud grows, and the petals are of their normal colour; but, instead of opening, as the other blossoms, under the influence of the spring sun, it remains closed, and after a little time the petals wither and turn brown, the little, wrinkled, white maggot having eaten the anthers, pistil, and ovary of the flower. The larva turns to a rust-coloured pupa inside the withered bud. The beetle is reddish-brown; on the elytra is a V-shaped white mark on a pitchy-coloured patch. The bark of the infested trees should

be kept clean, and all the useless rough pieces removed. All rubbish, &c., round them should be cleared away, so as to give the beetles no hiding places. Shaking the trees over sheets spread below is a good remedy, as the beetles fall to the ground when frightened. Bands of cloth, plastered over with a mixture of tar and cart-grease and tied round the trunks of the trees in April and May, will catch the female as she is going up to lay her eggs.

The Nut Weevil (*Balaninus nucum*) is a very small, brownish beetle, easily recognised by its long and slender beak. The female pierces the soft young nut-shell by means of this beak, and lays an egg in the hole; this hatches into a small, fat, white grub with a much wrinkled skin, which feeds on the kernel. The nut usually falls to the ground early, and the grub, when full-fed, gnaws a hole through the shell, buries itself in the ground, and turns to a whitish-coloured pupa. Nuts falling before their proper time should be collected and burnt before the grub has escaped. The beetle is to be seen about the nut bushes in the beginning of the summer. The pupa may be killed by stirring the surface soil under the trees, which exposes some of them to the weather and buries others too deep for them to be able to get up to the surface again.

The Shot-borer (*Xyleborus dispar*) is a small beetle, one-eighth of an inch long, of a pitchy-brown colour, with a cylindrical body and a very large thorax, which has done much injury to fruit trees on the Continent and in America by boring its tunnels into the stems so

as to interfere with the passage of the sap, and clear out some of the central pith. It is rare in this country. A good preventative to their attacks is said to be soft soap, reduced to the consistence of thick paint by the addition of a strong solution of washing soda in water, and applied to the bark on a warm morning, so as to allow it to dry well.

II. HYMENOPTERA (Bees, Ants, Sawflies, &c.).

The Gooseberry and Currant Sawfly (*Nematus ribesii*) is of a yellow or orange colour, the head and thorax being marked with black. The four wings are transparent and iridescent, the fore ones measuring about half an inch across, from tip to tip. The female fly first appears about April, and lays her eggs along the midrib and large veins of the gooseberry and currant leaves. The larva is bluish-green with black dots, the segment behind the head and the last but one a deep yellow, the head and last segment black. They may be seen clasping the edges of the leaves with their forelegs, while the last half of their bodies is turned up in the air. They do great damage to the leafage, and often cause much loss. When full-fed they crawl down the stems of the bushes and turn to pupæ underground. There are several broods during the summer, the late ones remain in the larval state underground in their cocoons through the winter, and turn to pupæ and then to perfect insects the following spring. The caterpillars on the bushes should be hand-picked as soon as seen. The bushes may also be dusted with flowers of sulphur,

soot, &c., while the dew is on the leaves, so that the dust sticks on well. The ground under the bushes should be dressed with gas lime before forking it over in the spring, or the surface soil may be removed in the autumn, and buried in a hole dug for the purpose. It should be replaced by the soil from the hole and manure.

The Slugworm is the larva of the Pear Sawfly (*Selandria atra*), also known as *Tenthredo cerasi*, *Eriocampa limacina*. It is a lumpy, blackish grub, about half an inch long, largest towards the head end, and covered with a black slime which exudes from its skin. It devours the upper surface of the leaves of the pear and cherry, leaving the veins and lower skin, which causes them to turn brown and fall. They emit a sickening odour when in large numbers. At their last moult, they cast their black skin and become buff-coloured and wrinkled. The larvæ turn to pupæ in the autumn, pass the winter underground in that state, and appear as sawflies about July.

These are stout-bodied, shining, black little flies; their front wings, measuring about half an inch from tip to tip, are membranous, netted, and often stained with black. The larvæ should be dusted with quicklime or gas lime, a second application closely following the first, as they are able to throw off the first by exuding their slime. The trees may also be syringed with strong soapsuds, tobacco water, &c., and cleansed with pure water afterwards, or the larvæ may be hand-picked. The ground under the trees may be treated

for these pupæ in the same way as for the gooseberry sawfly. The sawfly may be caught by shaking the trees over a sheet.

Wasps (*Vespa vulgaris*) cause no little damage by eating the plums, pears, apples, &c. Their nests should be found, tar poured down the hole, and a spit of earth put over the mouth, after dark when they are all at home. The combs should be dug out about a day or so afterwards and destroyed.

Ants climb up peach and nectarine trees when in bloom, and eat off the anthers of the flowers. A broad band of chalk, renewed at intervals, drawn round the stem of the tree, stops them from getting up, as the crumbling chalk affords them no foothold.

III. LEPIDOPTERA (Moths).

The Currant Clearwing (*Sesia tipuliformis*). The larvæ of this moth live inside the shoots of the currant, feeding on the pith and thus injuring them, and causing the leaves to die. They are whitish, with a darker dorsal line, and a pale-brown head. The perfect insect much resembles a gnat. The span of the wings is under an inch. Both wings are transparent, and tinged with yellow towards the margin, which is black; there is a central orange-black spot on the forewings. The head is black, the thorax black with a yellow stripe on each side, and abdomen black with three yellowish rings. It is to be seen in June. Withered shoots, noticed on the bushes in the summer, should be cut off and burnt, if the larvæ or their galleries have

been found by the examination of one or two of them. All the winter prunings should also be burnt.

The Wood Leopard (*Zeusera aesculi*). The larva of this and the following moth feed in the trunks of many trees, including the apple, pear, plum, and walnut, boring large holes into them, and often killing the tree. The best method of killing them is to thrust a strong wire up the hole, and if the end has wet whitish matter on it when drawn out again, the larva has been reached. Paraffin oil, tobacco water, &c., may be injected up the holes with a sharp-nozzled syringe. The brown pupæ found in cocoons, made of little bits of wood, at the mouths of the holes in May, June, and July, should be destroyed. The full-grown larva of the present insect is about an inch and a half long, yellow, with raised shining black spots. There is a black horny plate on the segment behind the head, and a black patch on the anal segment. The moth is large and sluggish, and may be found on palings and trunks of trees. Its wings have a span of two to two and three-quarter inches, and are semi-transparent, white with numerous blue-black spots, which are less distinct on the hind wings. The thorax is white, spotted with black, and the abdomen grey.

The Goat Moth (*Cossus ligniperda*). The remarks on the damage done by the larva of the last species apply also to the larva of this. It is about three inches long when full grown, and is a sort of dirty yellowish or flesh colour, with a broad dark reddish

stripe along its back. The moth measures between three and four inches across the fore wings, which are pale brown mottled with whitish, and marked with short, irregular, wavy, transverse lines. The hind wings are of a pale smoky colour, with similar but indistinct markings. The thorax is grey, marked across with darker, and the abdomen alternately ringed with brown and grey. It is found, from June to September, in the same places as the wood leopard.

The Figure of 8 Moth (*Diloba caerulocephala*). The larva of this moth, called the 'Bluehead,' feeds on the leaves of the plum, apple, &c. It is about two inches long when full fed, smoky green above, and yellowish-green below, with a yellow interrupted dorsal stripe, and a yellow stripe on each side below the spiracles; head blue, spotted with black, as are all the segments of the body. They spin cocoons formed of bits of bark, &c., in which they turn to reddish-brown pupæ, on the twigs and stems of the trees. The moth comes out about September. The fore wings measure about an inch and a quarter across, and are greyish-brown, with two small white kidney-shaped spots in the middle of each, resembling the figure 8. The hind wings are brownish. The caterpillars easily drop off the trees, so that shaking them over sheets and collecting those that fall is the best method of destroying them. They may also be sprayed with Paris green, &c.

The Buff-tip Moth (*Pygæra bucephala*). The larva of this species sometimes does serious damage to the

foliage of the nut, feeding also on the lime, elm, &c. It is about an inch and three-quarters long when full grown, yellow, with a black head and black lines, composed of short marks, running from head to tail. There is a transverse orange band on each segment, and there are scattered silky hairs over the whole larva. The brown pupa is to be found at the foot of the food tree, either just below the ground or amongst the fallen leaves. The fore wings of the moth have a span of over two inches, and are purplish-grey, with rusty-coloured and black markings, the tip with a pale ochreous or buff patch; the hind wings are yellowish-white. The best ways of destroying the larva are to shake it down and hand-pick it.

The Lackey Moth (*Gasteropacha neustria*). The brightly-coloured larvæ of this species are injurious to the foliage of the apple and also other fruit trees. They are about an inch and a half long when full fed, bluish-grey, with two black eyelike spots on the head, two black spots with a scarlet space between them on the next segment, and three scarlet or orange stripes along each side of the body, the two lowest being divided by a blue stripe. It is hairy, the hairs being dark brown above, and golden brown towards the legs. When, about May, they first come out of the eggs, which are fixed in bands round the twigs of the food tree, and pass through the winter, the larvæ are small, black, and hairy, and spin large web nests on the trees, in which they live together, going out from them to feed.

They disperse before they become full fed, and afterwards spin a cocoon of moderately firm texture, intermixed with a sulphur-coloured powder. The moth appears about August. Its fore wings measure about an inch and a half from tip to tip. The colour varies from pale ochreous to sandy red. The fore wings have two transverse brown streaks across the middle, between which the colouring is sometimes somewhat darker. The nests should be cut from the trees when the larvæ are in them, on a wet day or early in the morning, and destroyed immediately.

The Gold-tail Moth (*Porthesia auriflua*) is a satiny white moth, with a brownish-black spot on each of the fore wings, and a yellow tuft of hair at the extremity of its abdomen. It measures a little over an inch across the wings. It is found in August. The larva feeds on the leaves of the apple, &c., and is occasionally very abundant. It is black with a whitish dorsal stripe, interrupted by small humps on the fifth, sixth, and twelfth segments; the reddish line along each side of this stripe has a row of white dots along it, and there is another reddish line above the legs. It occurs in May and June. It is destroyed by hand-picking and washes, like the other orchard larvæ.

The Magpie or Currant Moth (*Abraxas grossulariata*). The larva of this moth, called a 'looper,' from the loop which it makes with its body when walking, sometimes appears in great numbers on the leaves of the gooseberry and currant, and nearly strips the

bushes of them. It is cream-coloured, with black spots all over, and two large black dorsal spots on each segment; there is a reddish-orange stripe along each side over the spiracles; the whole of the second segment and the under side of the third and fourth, and of the four last segments, is also reddish-orange. It is hatched in August or September, feeds for a little while, and then passes through the winter, either sheltered under the leaves on the ground, or spins some leaves together and hangs in them from the twigs, to which they are attached by silk threads. It appears again with the new leaves, and it is then that it does most damage. About June they spin a slight transparent cocoon, attached to the twigs of the bushes, or to palings, &c., in which they change to yellow pupæ, which afterwards become shining black with orange-coloured rings. The moth appears in July and August; it has a very sluggish flight, frequently flying by day, and may be easily captured. The wings measure about two inches across, and are white with several rows of black spots. The fore wings have an orange blotch at the base, and a slender orange band beyond the middle. The head is black, the thorax orange, with a large black spot in the middle, and the abdomen orange, with five rows of black spots. The markings are very variable. The fallen leaves should be removed from below the bushes in the winter, and burnt, a thin film of the surface soil being also skimmed up with them; the bushes should be also examined for those which have

spun the leaves up. The caterpillars may be destroyed in the spring by hand-picking and dusting the leaves with quicklime, soot, &c., when the dew is on them, so as the powder sticks. In the winter, the ground under the bushes should be dressed with gas lime.

The V Moth (*Halia wavararia*). The looper caterpillar of this moth is pale green with black spots, and four wavy yellowish-white lines on the back, and a yellow line over the spiracles. It is found on currant and gooseberry bushes in May, and not unfrequently strips these of their leaves. The moth is a little over an inch across the wings, pale grey with a faint violet tinge; the fore wings have a black V-like mark near the centre. It is found in July. The same remedies may be employed as for the magpie moth.

The Winter Moth (*Cheimatobia brumata*) is perhaps the best known and most injurious of our insect pests. The male moth measures a little over an inch across the fore wings, which are greyish-brown, with several indistinct, wavy, darker transverse lines; the hind wings are greyish-white. The female is incapable of flight, having only very short rudimentary wings, which are dusky-grey, with two transverse lines on the fore, and one on the hind wings. Her legs are long, and her abdomen very large, giving her the appearance of a spider. Her supply of eggs runs up to about 250. She appears about the end of October, and creeps up the stems of the trees to lay her eggs on the buds or twigs, and particularly in the crevices of the bark.

The batches of eggs look rather like patches of greyish mould. The larvæ vary, being sometimes green, sometimes brown, striped with whitish along the back. They attack everything: buds, flowers, foliage, and growing fruit, and, when in great numbers, leave the tree brown and scorched-looking. They are full fed about the end of May or beginning of June, and turn to pupæ below the surface of the ground at the foot of the trees. The fact of the female having such a lot of eggs shows the great importance of preventing her from laying them; this is done by 'sticky-banding' the trees. A strip of cloth or brown paper is tied closely round the trunks of the trees, and some sticky substance smeared on it. Cart-grease mixed with equal proportions of Stockholm tar is perhaps the best. The bands must be examined frequently, and the captured insects removed. They should be renewed when necessary, and should be begun in good time. The caterpillars may be syringed with various washes, such as dilute solutions of soft soap, quassia chips, paraffin, &c., when they are young and have not protected themselves by drawing the leaves together. When they are nearly full fed, they may be shaken down on to sheets spread below. Gas lime forked a few inches into the soil between the end of June and October will destroy the pupæ. These remedies also apply to the Mottled Umber moth, the description of which follows.

The Mottled Umber (*Hybernia defoliaria*). The male of this moth measures about an inch and three-

quarters across the fore wings, which are pale ochreous with dark-brown transverse bands; there is a dark spot in the middle of each wing. The hind wings are paler, and, like the fore, are sprinkled over with small dots. The female is entirely apterous, dark brown, with two dark spots on each segment. They appear about October. The looper larva is reddish-brown on the back, bordered by a narrow black stripe on each side, and bright yellow below. It is very injurious to the various fruit trees.

The March Moth (*Anisopteryx Aescularia*) is another moth with an apterous female, whose larva is injurious to fruit trees. The female is brown, with an anal tuft of hair. The male measures an inch and a half across the wings. These are fuscous, with various darker or paler transverse bands and lines; the hind wings are lighter, with a zigzagged line across them. They appear in March, and lay their eggs in bands round the twigs. The larva is green, marbled with darker, a white line along each side, and a pale spiracular line. Where practicable, the ends of the twigs should be examined in March, and the bands of eggs destroyed. The female may be caught by sticky-banding the trees.

The Codlin Moth (*Carpocapsa pomonella*). The larva of this little moth lives in the inside of apples and pears, chiefly the former, causing them to fall prematurely, when they are known as 'worm-eaten.' The moth lays an egg in the eye of the newly-formed fruit, from which the grub hatches, and eats its way

into the apple. It passes by the core, and makes for the stem end, where it bores a hole out of which to throw its excrement; this done, it turns back again and gets to the core, where it feeds on the pips, and thus causes the apple to fall. After this has happened, the grub leaves the apple and crawls up a neighbouring tree, where, having found a convenient place in the rough bark, &c., it spins a cocoon. It is a whitish, hairy grub, about half an inch long, with a black head, and eight spots on each segment. It remains in the larval state for several weeks, and then changes to a pupa, which passes through the winter. The moth measures about half an inch across the wings, which are grey, with numerous darker transverse lines; at the bottom corner is a brownish-red spot, with paler markings on it, and edged with coppery. All the fallen apples should be collected at once and destroyed. An artificial resting-place may be made for the grub to change to a pupa, by tying bands of cloth, paper, &c., round the tree trunks, undoing and examining them from time to time.

The Red Plum Grub is the larva of *Carpocapsa funebrana*, an allied species to the last. The grub is pale red, with a black head; the second segment is yellowish-brown. It goes to work in the same way as the last, causing the plum to drop prematurely. The same remedies may also be applied to it as to the last. The moth is smaller than the codlin moth, measuring only half an inch across the fore wings. These are grey,

clouded with smoky grey; at the bottom angle is an indistinct spot edged with shining pale grey, and with four black dots in it.

The Small Ermine (*Hyponomeuta padellus*). The larvæ of this little moth are exceedingly destructive to the foliage of various fruit trees. They are about half an inch long, of a dirty grey colour, changing to dirty yellow when full grown, with black spots; they live gregariously, spinning webs, from which they go out to feed. When full fed they change to pupæ inside their web, spinning a slight cocoon. The moth appears in July. It measures about three-quarters of an inch, or under, across the fore wings, which are white tinged with grey, sometimes quite grey, with three rows of black dots; the hind wings are lead colour, with long fringes. The colours are very variable. The nests should be cut off when the larvæ or pupæ are inside, and destroyed. The trees and nests may also be syringed with soft soap, mixed as thickly as practicable, and a little paraffin added.

The Pear-blister Moth (*Lyonetia Clerckella*). The larvæ of this minute moth attack the leaves of the pear, sometimes also of the apple and cherry, in the inside of which they live, making mines, which appear as long, serpentine, blister-like lines and patches. The larva is pale green, with a rusty black-coloured head. There are two broods of them in the year—one from the end of May till the end of July, and another in September and October. They go down to the ground

when full fed, and turn to pupæ under the clods of earth and amongst the fallen leaves. The perfect insect from the first brood appears from June to August, and from the second in November. Some of these last appear to hibernate and come out again in April. The fore wings measure only one third of an inch across, and are whitish, with a longitudinal fuscous blotch beyond the middle, and a deep black spot on the apex. Sometimes the fore wings are suffused with a bronzy colour, concealing nearly all the markings. All leaves and rubbish should be carefully raked up from below the trees and burnt, in order to destroy the pupæ. The leaves where the mines are observed should be picked off and destroyed with the grubs in them.

IV. HOMOPTERA (Aphides, Scale Insects, &c.).

The different aphides are too variable in colour and form to describe without entering minutely into the subject. We have chiefly to deal with the apple (*A. mali*), the plum (*A. pruni*), and the cherry aphid (*A. cerasi*), the two first being chiefly greenish and the last black, and are known as the green fly and the black fly. They pierce the leaves and shoots of the trees with their beaks, and do much damage by drawing-off the sap, whilst they exude a sweet gummy matter, known as 'Honeydew,' which falls on the other leaves and makes them dirty and unhealthy. The best way to deal with them is with washes of soft soap and quassia, tobacco water, &c.; the shoots may either be brushed with a painter's brush dipped in the mixtures

or else syringed with them. The prunings should always be carefully destroyed.

The American Blight, Woolly Aphis (*Schizoneura lanigera*), infests the apple, and may be recognised by the white cottony or woolly-looking growth on the insect, whence one of its names. This aphid is chiefly to be found in neglected orchards, where it collects in the cracks in the bark, &c., of the trees. The washes of soap recommended for the other aphides may also be used successfully for this species.

The Mussel Scale (*Mytilaspis pomorum*), so called from its resemblance to a minute mussel scale, attacks many different kinds of trees, but particularly the apple. The *scales* are not the insects themselves, but a covering by which the female, a whitish grublike insect, is sheltered, and under which she lays her eggs and then dies. The male is a minute two-winged fly. The young ones which hatch from these eggs are very small, flat, and whitish. They have eyes, antennæ or feelers, a rostra or beak, and six legs, and run about actively for a short time before they settle down, fix themselves on to the bark, and after a time change to pupæ. They damage the young shoots by inserting their rostra and sucking away the sap, also injuring the cells of the shoot. The scales should be removed by lathering the shoots with soft soap and then scraping them with a blunt knife. It is best done in the spring, as then the larvæ are also killed.

The Oyster Scale (*Diaspis ostreæformis*) is another

little brown scale, taking its name from the resemblance to a miniature oyster shell. It attacks the pear, and should be destroyed in the same way as the mussel scale.

The Orange-tree Scale (*Lecanium hesperidum*) should be treated in the same manner.

The White Woolly Currant Scale (*Pulvinaria ribesice*) has only been lately observed in England, though common on the Continent. The scale itself is dark-greyish brown. It exudes a white woolly matter, which forms a nest for its eggs. The larvæ are orange-coloured, and, like those of the other scales, run about on the plants for a little time before settling down. They attack the black, white, and red currants, the injury arising from the same causes as that done by the other scale insects. The same remedy may be employed as for the mussel scale.

Having now come to the end of our list of insects, mention must be made of two injurious little animals belonging to the order of the Acarina or Mites, of the class Arachnida.

The Red Spider (*Tetranychus telarius*) is an exceedingly small oval mite, with four pairs of legs, two pointing forwards and two backwards. Its colour varies from yellowish white to reddish. It is very injurious to the leaves of the plum and other fruit trees, spinning a white and shiny web on the under side, and making them assume a yellowish, marbled appearance on the upper surface. Hot dry weather seems to be most favourable to them; therefore the trees should be

well syringed with water, which operation also renders them more healthy. The best wash for syringing or brushing the infested leaves is made by taking four ounces of sulphuret of lime, and two ounces of soft soap to a gallon of water; the first two ingredients must be well mixed, and then the water gradually added, the mixture being stirred all the time, when a uniform fluid is obtained. It should be used warm.

The Currant-gall Mite (*Phytoptus ribis*). These microscopic mites lodge in large numbers in the leaf buds of the black currant and cause them to swell, giving rise to an abortive growth of the bud, or sometimes destroying it altogether. The mite is long and cylindrical in shape, with the skin transversely wrinkled and with several large bristles: the four legs are placed under the fore part of the body. When it has once established itself it is extremely difficult to eradicate. Attacked shoots should be cut off and burnt. The bushes should be pruned closely in the autumn and the prunings burnt. In very bad cases the bushes should be rooted up and burnt.

In conclusion I may say that insectivorous birds, such as the warblers and tits, are of great service in destroying these pests, killing them where we should often be unable to reach them, and should be encouraged as much as possible.

NOTE.—A receipt for a quassia wash will be found at p. 143.

INDEX

APP

- Apple, American blight, cure for, 76
- as wall trees, 98
 - burr knot stock, 72
 - bushes on paradise stock, 79
 - bushes for a market garden, 83
 - dormant beds, to notch, 75
 - double lateral cordon, 92
 - doucin stock, 71
 - in pots, 73
 - pommier de paradis, 73
 - pyramid, summer pinching of, 77
 - pyramidal, on crab, 100
 - quadruple cordon, 92
 - root-pruning of, 74
 - selection of sorts, 78, 79, 81, 82
 - summer pinching of bushes, 77
 - single lateral cordons, 87
 - to keep hares from, (*note*) 81
 - vertical cordon, 97
- Apricot, pyramidal, 119
- Canker, 150
- Cherry, as bushes, 109
- biennial removal of, 117
 - cure for aphid, (*note*) 115

INS

- Cherry, double-grafting of, 114
- on the common stock, 116
 - on the mahaleb stock, 109
 - pruning of, 112
 - pyramidal, 113
 - selection of sorts, 114, 119
 - summer pinching of, 111
 - vertical cordons, 115
- Cordon training, 164
- Currant, pyramidal, 119
- Diagonal single cordons, 48
- Double grafting of fruit trees, 130
- Dwarf walls, proper distance for trees, 40
- Figs, as half-standards and bushes, 121
- Filberts, as standards, 120
- Fruit trees, advantages of root pruning of, 59
- biennial removal of, 125
 - distances to plant, 146
- Glass fruit ridge, 91
- Ground vinery, 151-160
- Insect pests, 186

MAR

- Market garden bush apple trees, 83
- Medlar, pyramidal, 119
- Moss on trees, to destroy, (*note*) 125
- Old fruit-trees, root-pruning of, 57
- Peach border, how to prepare, 136
- on dwarf walls, 42
- Pear, as a hedge, 53
- as bushes on the quince stock, 20
- biennial root-pruning on wall trees, 44
- budding with fruit buds, (*note*) 7
- dormant buds, to notch, 7
- double-grafted, (*note*) 32
- espalier on quince stocks, 43
- for dwarf walls, 40
- gathering the fruit, 66
- keeping fruit in a greenhouse, 69
- mature pyramid, 8
- number of fruit on, 2
- ornamental pyramids of, 20
- planting, 61
- proper time to plant, 2
- protecting wall trees, 137

STR

- Pear, pruning, 5-13
- pyramid on the pear stock, 54
- root-pruning of, on the pear stock, 56
- root-pruning on quince, 13
- semi-pyramids for walls, 32
- shortening leading shoots, 8-13
- sorts for bushes, 23
- pyramids, 17
- sorts for upright cordons, 32
- summer pinching, 8
- top-dressing, 56
- to store for winter, 68
- under glass, 35
- upright cordon training, 28
- upright cordons for trellises, 32, 33
- upright cordons for walls, 32
- young pyramid, 5
- Plum, as bushes, 105
- as cordons, 106
- on sloe, 103
- pyramidal, 102
- selection of sorts, 104
- Pyramidal fruit trees, summer pinching of, 9-11
- planting, (*note*) 61
- Standard orchard trees, 139
- Strawberries in ground vinery, 158

The following Publications, sold also by Messrs. LONG-
MANS & CO., 39 Paternoster Row, can be had per
post from THOMAS RIVERS & SON, Sawbridge-
worth, at the following rates:—

THE

ROSE-AMATEUR'S GUIDE.

Edited and arranged by T. FRANCIS RIVERS.

Containing the History and Culture of Roses, with Descriptions of a
few Select Varieties, Culture of Roses in Pots, &c.

ELEVENTH EDITION.

4s.

THE

MINIATURE FRUIT GARDEN

OR,

DWARF FRUIT-TREE CULTURE IN SMALL GARDENS.

Edited and arranged by T. FRANCIS RIVERS.

With Hints for the Cultivation of the Pear grafted on the Quince
Stock; the Cherry on the Cerasus Mahaleb, or Perfumed Cherry; and
the Apple on the Paradise Stock.

TWENTIETH EDITION.

4s. ; post-free, 4s. 3d.

THE CONGRESS PAPERS, 1s.
P

THOMAS RIVERS & SON,
THE NURSERIES,
SAWBRIDGEWORTH.

THE DESCRIPTIVE AND ILLUSTRATED
CATALOGUE OF FRUITS.

3*d.* post-free.

CONTAINING A DESCRIPTION OF THE SORTS OF FRUITS
NAMED IN 'THE MINIATURE FRUIT GARDEN.'

THE DESCRIPTIVE
CATALOGUE OF ROSES.

Post-free.

The Nurseries extend over more than 100 acres of land exclusively devoted to the cultivation of Fruit Trees and Roses, the soil being eminently adapted for this purpose. The climate produces a hardy constitution in all Fruit Trees and Roses, and they will bear removal to any part of the United Kingdom without injury.

The Nurseries are near the Harlow and Sawbridge-
worth Stations on the Great Eastern Railway.

The Orchard Houses contain Specimen Trees on Fruit during the greater part of the Summer.

THOMAS RIVERS & SON,
SAWBRIDGEWORTH, HERTS.

The following varieties of Fruits have been raised from seed by Mr. RIVERS, and can be recommended by him for cultivation. A full description of each sort is given in the Catalogue of Fruits by Messrs. RIVERS & SONS, Sawbridgeworth, which can be had on application, post-free for 3d.

PEARS.

Beacon.
Dr. Hogg.
Fertility.
Magnate.
Princess.

Summer Beurré d'Arem-
berg.
St. Swithin's.
Conference.
Parrot.

EARLY RIVERS' CHERRY.

NECTARINES.

Advance.
Albert Victor.
Byron.
Chaucer.
Darwin.
Dryden.
Goldoni.
Humboldt.
Improved Downton.

Lord Napier.
Milton.
Newton.
Pine Apple.
Rivers' Orange.
Spenser.
Stanwick Elruge.
Victoria.
White Rivers.

PEACHES.

Albatross.

Alexandra Noblesse.

Condor.

Crimson Galande.

Dagmar.

Dr. Hogg.

Early Alfred.

Early Beatrice.

Early Leopold.

Early Louise.

Early Rivers.

Early Victoria.

Gladstone.

Golden Eagle.

Goshawk.

Lady Palmerston.

Large Early Mignonne.

Magdala.

Osprey.

Princess of Wales.

Rivers' Early York.

Sea Eagle.

The Nectarine Peach.

PLUMS.

Archduke.

Autumn Compote.

Blue Prolific.

Bittern.

Curllew.

Early Transparent Gage.

Red Transparent Gage.

Early Favourite.

Early Rivers.

Grand Duke.

Heron.

Late Transparent Gage.

Golden Transparent
Gage.

Late Prolific.

Late Rivers.

Monarch.

Mallard.

Rivers' Early Damson.

Stint.

Sultan.

The Czar.

