

©  
SF523  
H794  
1905

ALBERT R. MANN  
LIBRARY  
NEW YORK STATE COLLEGES  
OF  
AGRICULTURE AND HOME ECONOMICS  
AT  
CORNELL UNIVERSITY



EVERETT FRANKLIN PHILLIPS  
BEEKEEPING LIBRARY

CORNELL UNIVERSITY LIBRARY



3 1924 081 073 714

[Issue, 10,000, May, 1905.]

New Zealand Department of Agriculture.

JOHN D. RITCHIE, *Secretary.*

## DIVISIONS OF BIOLOGY AND HORTICULTURE.

T. W. KIRK, F.L.S., GOVERNMENT BIOLOGIST, CHIEF OF DIVISIONS.

BULLETIN No. 5.

# BEE - CULTURE.

- I. The Use of Comb-foundation.
- II. Ripening Extracted Honey.
- III. Foul Brood.
- IV. The Large Bee-moth.
- V. Apiculture in relation to Agriculture.

By ISAAC HOPKINS, BEE EXPERT.

ILLUSTRATED.

HON. T. Y. DUNCAN, MINISTER FOR AGRICULTURE.



WELLINGTON.

BY AUTHORITY: JOHN MACKAY, GOVERNMENT PRINTER.

1905.

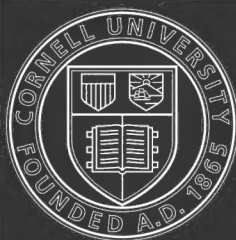

## Cornell University Library

The original of this book is in  
the Cornell University Library.

There are no known copyright restrictions in  
the United States on the use of the text.

[Issue, 10,000, May, 1905.]

New Zealand Department of Agriculture.

JOHN D. RITCHIE, *Secretary.*

## DIVISIONS OF BIOLOGY AND HORTICULTURE.

---

T. W. KIRK, F.L.S., GOVERNMENT BIOLOGIST, CHIEF OF DIVISIONS.

---

BULLETIN No. 5.

## BEE - CULTURE.

- I. The Use of Comb-foundation.
- II. Ripening Extracted Honey.
- III. Foul Brood.
- IV. The Large Bee-moth.
- V. Apiculture in relation to Agriculture.

By ISAAC HOPKINS, BEE EXPERT.

ILLUSTRATED.

---

HON. T. Y. DUNCAN, MINISTER FOR AGRICULTURE.

---



WELLINGTON.

BY AUTHORITY: JOHN MACKAY, GOVERNMENT PRINTER.

—  
1905,  
M W

@  
SF 523  
H 794  
1905

@ 79426

## NOTE.

---

Department of Agriculture,  
Divisions of Biology, Horticulture, and Publications,  
H.M. Customs Building,  
Wellington, 27th May, 1905.

THE necessity for the appointment of a Bee Expert has been urged in my reports from year to year. It was therefore with great pleasure I received intimation of the engagement of Mr. Isaac Hopkins as Apiarian.

The attached articles are the first from his pen as Government Bee Expert. They will prove of great interest and also instructive to beekeepers.

The illustrations of comb are from original photographs, taken specially for Mr. Hopkins.

T. W. KIRK.









## BULLETIN No. 5.

# BEE-CULTURE.

### I. ON THE USE OF COMB-FOUNDATION.

So far as I have yet been among our beekeepers, I have found, with few exceptions, almost a total absence of knowledge concerning the full economic value of comb-foundation. Its use at the present time is chiefly confined to providing "guide-combs," which consist of narrow strips fastened along the under-sides of the top bars of the movable frames of the hive, to insure the bees building their combs within the frames. The bees are thus left free to construct nearly the whole of their combs, of whatever kind they may choose, worker or drone, or, as is usual, some of both.

The success of modern bee-culture hinges almost entirely in the first place on securing complete control over the breeding, and this can only be obtained by compelling the bees to build whatever kind of comb is desired. Under natural conditions, or when in hives and allowed freedom to construct their combs, they invariably build a goodly proportion of drone-comb, which is subsequently utilised for breeding drones. This accounts for the large number of drones to be seen in box hives, or where no attempt has been made to control breeding. Drones, as most people are aware, are non-producers—that is to say, they do not gather honey, or even do any work in the hives. They are physically incapable, but they consume a large quantity of food gathered by the workers, and where many are present the yield of honey from that hive, and consequently the profit, will be considerably curtailed. The breeding of drones, therefore, when honey is the chief object should be restricted as much as possible, and this can only be accomplished successfully with a minimum of trouble by making the fullest use of worker-comb foundation.\*

The difference between worker and drone comb is in the size of the cells, the former measuring slightly over five to the inch, and the latter a little over four. The proportions are shown in

---

\* A sufficient number of drone-cells will always be built round the ends and bottoms of the sheets of foundation.

Plate II. Drones can only be bred in the larger and workers in the smaller cells. The comb-foundation obtained from manufacturers is invariably impressed with the bases of worker-cells, so that it is impossible, unless by accident some portion has stretched, for the bees to build other than worker-comb on it. The illustrations will make this clear. Plate I. shows a perfect worker-comb built out on a full sheet of comb-foundation, while Plate II. exhibits the result of the breaking-away of a portion and the stretching of another portion due to careless fixing of what was originally a full and perfect sheet of worker-comb foundation. These are very interesting reproductions from photographs taken specially for the purpose of this article. To the right of Plate II. can be seen where the bees took advantage of the accident to build drone-comb, and also where on the upper left centre the original worker-cells have stretched and been utilised for breeding drones. At the lower right-hand corner of Plate I. a small portion of the original sheet of comb-foundation upon which the comb is built can be distinctly seen.

Securing control over breeding is not the only advantage gained by a free use of comb-foundation. For instance, a fair swarm of, say, 5 lbs. weight hived upon ten sheets of comb-foundation in a Langstroth hive will have in twenty-four hours, in an average season, several of the sheets partially worked out and a goodly number of eggs deposited in the cells, and in thirty-six hours the queen can henceforward lay to her full extent. In from a week to nine days (depending upon the weather) the whole ten sheets will be worked out into worker-combs, and a great deal occupied with brood and honey, and the hive will then be ready for the top or surplus honey super. In twenty-two or twenty-three days young worker-bees will begin to emerge, and from this on the colony will grow rapidly in strength from day to day.

Contrast this favourable condition of things with what takes place when only narrow strips of comb-foundation are furnished. It will take under the same conditions a similar swarm from four to five weeks to fill the hive with comb, and then there will be a large proportion drone-comb, which is the very thing to guard against. Consider what the difference in time alone will make in the profitable working of a hive, especially in a short season. Then, again, with regard to the difference in the initial expense between using full sheets and strips, which seems to influence many beekeepers in favour of the latter system: Even in that there is a gain in favour of the method I am advocating. For instance, the cost of filling the ten frames with sheets of best comb-foundation would be (with expenses of getting them added) about 4s., and with strips—say, two

sheets—10d.: an apparent saving in the first instance of 3s. 2d. We must then consider the matter from another point of view.

The consensus of opinion among the most experienced beekeepers is that there is an expenditure of about 12 lbs. of honey in making 1 lb. of wax—that is, the bees consume that quantity of honey before secreting 1 lb. of wax. The ten sheets of comb-foundation weigh  $1\frac{1}{2}$  lbs. and cost 4s. For this there would have to be an expenditure of 18 lbs. of honey, which at the low price of 3d. per pound is 4s. 6d., so that there is a saving of 6d. in favour of the full sheets, to say nothing about all the other advantages gained.

I trust I have now made the matter clear enough to influence all our beekeepers in favour of making the fullest use possible of comb-foundation.

## II. RIPENING EXTRACTED HONEY.

That all honey should be thoroughly ripe when sent to market goes without saying, otherwise it will sooner or later ferment and become useless for table purposes, and injure future sales of the same brand. It is not an uncommon thing to find honey going bad after being on the market a short time, to the loss of the merchant and producer. Quite recently I saw a line of 2 lb. tins of honey condemned through fermentation and sent to auction. The tins bore the label of a well-known beekeeper, and the result, no doubt, will be that his honey will be avoided in future, in that district at least. All beekeepers I have visited so far appear to realise the importance of ripening honey, but less than half a dozen had the proper apparatus for doing so.

Nectar or honey when first gathered contains a variable quantity of water, usually ranging from 18 to 23 per cent., according to the weather. Mr. Otto Hehner, F.I.C., F.C.S., public analyst, and analyst to the British Beekeepers' Association, in a lecture before that body some years ago stated, "Essentially, honey consists of water and of sugar. Of the water I need say but little except that I have found it to vary in quantity from 12 to 23 per cent., the normal proportion being from 18 to 21 per cent. When the percentage falls below 18 the honey is generally very hard and solid; when it is higher than 21 it is frequently quite or almost clear."

Honey even in its ripened state, as will be seen, contains some water. When first gathered, if it contains, as it usually does, too much, the bees after storing it allow the honey-cells to remain open

until the surplus moisture has evaporated, when they are capped or sealed by the bees, and the honey so capped is then considered ripe and fit for market. The length of time the honey-cells may remain uncapped depends entirely on the state of the weather when the honey was stored. I have known them to be open for several days, and in very dry, warm weather I have seen the cells being capped directly they were filled.

The ripening of honey within the hive always appeared to me to be a mechanical process—that is to say, a process carried on by the heat of the hive, and not due to any particular manipulation on the part of the bees, so that it could be equally well done outside as within the hive. I have always acted on this belief with very satisfactory results. Instead of waiting until the bees had capped the whole of the cells, I have commenced to extract directly the bees started scaling the upper cells of the combs and finished the ripening in my tanks. It is not difficult to realise the enormous saving effected by this method in a large apiary during the season. The bees instead of secreting wax for capping the cells are at liberty to act as field workers, the combs are quickly available again for refilling, and plenty of working-room is always assured, which will tend to keep down swarming.

#### RIPENING-TANKS.

The most effective method of ripening honey is to expose as large a surface as possible to a warm, dry atmosphere. The “tanks” generally in use at the present time, so far as I have seen, consist of tin cylinders about 18 in. in diameter by 36 in. deep, similar to the cylinder of a two-comb honey-extractor, and these have been usually covered with a cloth or lid “to keep out bees and dust.” As I have pointed out, it is simply impossible for honey to ripen under those conditions. The tank is too deep and the surface too small. The body of honey set to ripen should never be more than 15 in. or 16 in. deep, while showing as much surface as possible. A tank 6 ft. long by 4 ft. wide and 18 in. deep, with a centre division, would hold, when filled up to 2 in. from the top, about 2,500 lbs. of honey. A long, wide, shallow tank in similar proportions to the above is the proper utensil for ripening honey. (See illustration.)

Even when the honey is not removed from the hive until it is capped by the bees it is necessary to have such a tank to properly clarify the honey. No matter what pains are taken to strain the honey so as to clear it of all foreign substance, very fine particles of wax will remain or run into the tank with the honey. If the body of the latter is shallow the fine specks of wax and pollen, hardly discernible, will rise to the surface, forming a scum, which,

when skimmed off, leaves the honey in the very best condition for market.

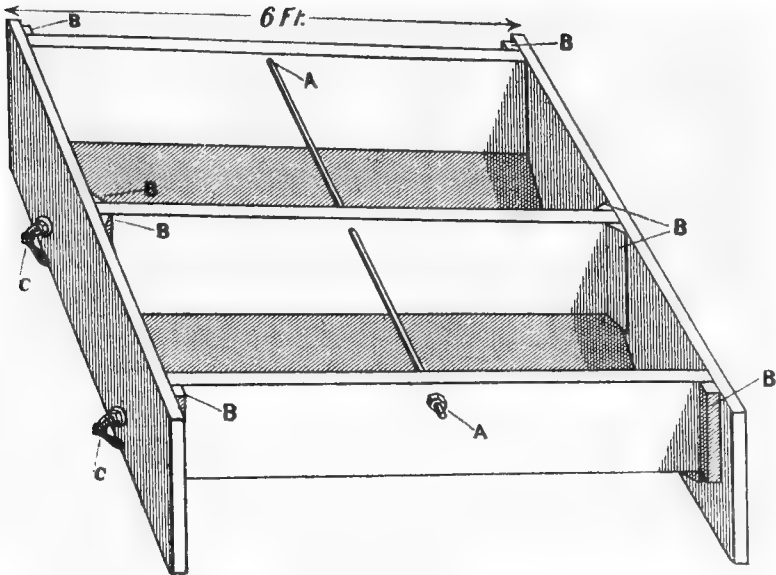

FIG. 1. DOUBLE HONEY-RIPENING-TANK.

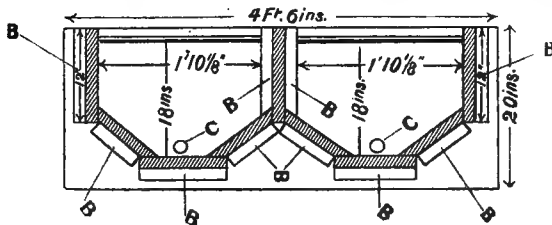

FIG. 2. SECTIONAL VIEW OF SAME.

Fig. 1 represents a honey-ripening tank, 6 ft. long, 4 ft. wide, and 18 in. deep, outside measurements, capable of holding about 1,250 lbs. of honey in each compartment. It should be made of  $1\frac{1}{2}$  in. timber, and lined with good stout tin.

In Figs. 1 and 2 the letters refer to the same parts. A, A, iron strengthening-rod, with screw-nut; B, B, battens  $2\frac{1}{4}$  in. wide by 1 in. thick, against which the boards of the tank are nailed; C, C, honey cut-off taps.

I must also bring forward another point of considerable importance—that is, that the honey from each day's extracting as it is run into the tank should be left undisturbed until ready to be run off into tins or other vessels for market. It is most unwise to run two or more days' extracting together in same tank, as the frequent disturbance of the honey is both against its clarifying and ripening properly. The tanks I recommend are divided along the centre

of their length (as shown in illustration), so that two days' extracting can be run separately into the one tank, and they may be made to any proportions suitable to the beekeepers' needs, but they should not be of greater depth than the figures already given.

The specific gravity of average-ripened honey, which may be obtained by the use of a hydrometer, is usually given at 1.350, though I have had it as high as 1.488, or nearly half again as heavy as water. But for the average beekeeper it will be sufficient for him to decide that the honey is ripe enough to run off as soon as it shows signs of "clouding"—that is, granulating.

In conclusion, the beekeeper, working for extracted honey, should have a bee-tight, yet well-ventilated, honey-room, in a warm and sunny situation, large enough to do all his extracting and tinning in, and a ripening tank or tanks such as I have described, which should never be covered except when out of use.

### III. "FOUL BROOD" (*Bacillus alvei*, Cheshire) AND ITS TREATMENT.

The germ disease of "foul brood" has evidently caused more or less trouble to beekeepers from very early historical times. References are made to some such disease before the Christian era by Aristotle in his works on husbandry, which no doubt was what we now know as "foul brood." It is quite possible that the disease was not so troublesome in former times, as the facilities for its spreading were few compared with what they have been during the last twenty-five or thirty years. The trade in bees and queens that has accompanied the expansion of modern bee-culture, and their consequent transportation from district to district, and from country to country, is accountable, no doubt, for the universal extent of its ravages at the present time. When or where it first made its appearance in New Zealand is not known so far as I am aware, but I do know that "foul brood" was very prevalent in some districts—notably in Taranaki, Hawke's Bay, and Poverty Bay—before 1880.

Very little, if anything, was known or understood concerning this disease in New Zealand before the dissemination of modern bee literature about that time, consequently it had not been recognised previously by our beekeepers. The loss caused by "foul brood" during the intervening years in this colony has been enormous, and calls for serious consideration. We have everything in our favour—



climate and bee-forage second to none in the world. We raise some of the very finest honey in the world, and there is nothing but this disease to prevent the beekeeping industry in this country from developing into a very extensive business. We have the honey at our feet and the animals for gathering it, yet until some measures are devised to prevent disease running rampant through the colony, as is the case at present, we cannot profit to the full by these advantages.

#### STATE LEGISLATION.

The difficulty of individual beekeepers dealing successfully with "foul brood," so easily propagated and spread abroad from apiary to apiary, lies in the carelessness and often wilfulness of many so-called beekeepers who (as I have frequently pointed out in my writings), in utter disregard of advice given them by more careful men, will persist in leaving lying about old boxes with their combs in which diseased colonies have died, for other bees to enter and so to carry away disease-germs, and occasionally having stray swarms in the same infected boxes, only to propagate and spread the disease, and to finally perish as the others did before them. It is absolutely necessary and just that the careful beekeeper should be protected from his careless neighbour, and the only way this can be done is by State legislation, which shall control and compel the careless man to take such steps as will prevent the propagation and spread of disease in and from his apiary. The sale of diseased bees, or implements that have been used in a diseased apiary before being thoroughly disinfected, or the transportation of diseased bees to or from any district, should not be allowed.

#### SYMPTOMS OF "FOUL BROOD."

Healthy brood in the larvæ stage—that is, before it is sealed or capped—presents a clear pearly whiteness, but when attacked by "foul brood" it rapidly changes to light buff, then to brown, coffee-and-milk colour, and finally to black, at which stage nothing is to be seen in the cell but a flattish scale-like substance when examined closely. It is, however, when the brood has been attacked after it has advanced to the pupa period of its existence—that is, when it has been capped over—that the novice is better able to detect the presence of "foul brood."

In the early stage of an attack a capped cell here and there will appear somewhat different from the surrounding healthy brood. Instead of the cappings or seals being bright, full, and of convex form, characteristic of healthy brood, they will be of a dull blackish-brown colour, and flat or sunken, an indication that the cells contain

dead pupæ. The disease rapidly spreads to surrounding cells and combs if allowed to take its course, till finally no brood can hatch, and the colony succumbs. On opening some of the cells a thin glue-like coffee-coloured mass will be noticed, which on the insertion of a splinter of wood will adhere to the point, and can be drawn rope-like for some little distance out of the cells. This is one of the most distinctive features of "foul brood," and where present is generally considered conclusive of the disease. Later on this glue-like substance dries up into the before-mentioned black scale-like body.

Other symptoms are "pin-holes" and ragged perforations in the cappings of the cells, clearly shown in Plates III. and IV., and a very disagreeable smell resembling heated glue or tainted meat, which can be very often detected at some yards away from a badly infected hive, especially in close weather. The characteristic odour cannot easily be detected in the earliest stages, even when an infected comb is placed close to the nose, but some slight difference can be noticed between that and healthy comb at all times.

#### OTHER DISEASES IN COMPARISON WITH "FOUL BROOD."

"Chilled brood"—that is, brood which has died from cold or neglect—has sometimes, through some of the symptoms appearing similar to "foul brood," been taken for the latter. Cheshire says the discoloration in the larvæ of "chilled brood" is usually a change to grey, and not to brown, as in "foul brood." He also says that the characteristic odour of "foul brood" is absent.

What is termed "pickled brood" is due to a fungus, and is only mildly contagious. The brood is always watery, and turns black. The ropiness and odour of "foul brood" is absent, and the same may be said of "black brood," which is jelly-like in consistency. I have seen "chilled brood," but not "pickled brood" or "black brood."

"Scalded brood". The dead brood in this case has a very moist and heated appearance, as though it had been parboiled; it rapidly becomes putrid, and in this condition has an exceedingly offensive smell. "Scalded brood" may readily be mistaken by a novice for "foul brood," as I have known on two or three occasions. The cause is excessive heat and insufficient ventilation. It may also be brought about by confining brood in hives while transporting them to a distance. On this account all brood should be removed from hives about to be closed for more than a few hours, and then they should be well ventilated.

## TREATMENT OF "FOUL BROOD."

The drug treatment for the cure of "foul brood" so strongly recommended by Cheshire and others, who claimed to have been successful, has, after about a quarter of a century's trial under all conditions, been almost universally condemned. I have no reason to doubt that in the hands of scientific men like the late Mr. Cheshire cures can be effected by drugs. What we have to consider, however, is not what the scientific man can accomplish by any particular method, so much as what effective treatment is there that will come within the accomplishment of the average beekeeper? What is known as the "starvation" plan, brought so prominently forward of late years by Mr. McEvoy, answers to this, and it has been found to be the most successful generally of any treatment yet tried. Mr. McEvoy, in fact, claims to have cured thousands of diseased colonies by the starvation method, and it is now almost the only one adopted.

It is by no means new, for in 1885 Mr. D. A. Jones, of Canada, who was at that time one of the most extensive beekeepers in the world, advocated the plan in a little work he published on "Foul Brood: its Management and Cure," and it was afterwards known as "Jones's starvation plan." Mr. Cowan, editor and proprietor of the *British Bee Journal*, in reviewing the work in December of the same year, pointed out that "as far back as 1767 one J. G. Seydel, and in 1775 J. C. Voight, recommended similar treatment." Bonner in 1789, and Della-Roux in 1790, were both practising it, while Quinby in 1865, in his book, gives it as "the only effectual cure."

*The Jones Method.*

The treatment given in his work was to shake the bees from the infected combs into an empty box, and to close the top and entrance with wire cloth; then to place the box of bees in some dark place (a cellar if possible), turning the box on its side so as the wire cloth is at the side to allow air to pass through. Darkness and a cool temperature are important, as also that all the bees should be equally filled with honey. They are to remain where deposited until they show signs of hunger. This they will do in from four to six days, and they must be carefully watched after the third day, as they are liable to die very quickly. When sufficiently starved, which is known by some of the bees dropping down and crawling about in a slow, quiet manner, they are shaken in front of a hive prepared with some combs, and are allowed to run in just the same as a swarm. If there is no food in the combs the bees should be fed. The combs from infected hives should be melted into wax and the frames boiled for some minutes.

*The McEvoy Treatment.*

It may be mentioned that Mr. McEvoy is Foul Brood Inspector of Ontario, Canada, and has the credit of having had a wider experience in the treatment of "foul brood" than any man living. He says, "In the honey season, when the bees are gathering freely, remove the combs *in the evening*, and shake the bees into their own hive. Give them frames with comb-foundation starters on, and let them build combs for four days. The bees will make the starters into comb during the four days and store the diseased honey in them which they carried from the old combs. Then *in the evening of the fourth day* take out the new combs and give them comb-foundation [Full sheets—I. H.] to work out, and then the cure will be complete."

He further adds, "By this method of treatment all the diseased honey is removed from the bees before the full sheets of foundation are worked out. Where you find a large quantity of nice brood with only a few cells of 'foul brood' in the most of your colonies, and have shaken the bees off for treatment, fill two hives full with these combs of brood, and then place one hive of brood on the other, and shade this tiered-up brood from the sun until the most of it has hatched; then, *in the evening*, shake these bees into a single hive and give them frames with comb-foundation starters on and let them build comb for four days; then, *in the evening of the fourth day*, take out the new comb and give them comb-foundation to work out to complete the cures. After the brood is hatched out of the old combs the latter must be made into wax or burned, together with all the new combs made out of starters during the four days, on account of the diseased honey that would be stored in them. . . . All the curing or treating of diseased colonies should be done in the evening, so as not to have any robbing, or cause any bees from the diseased colonies to mix and go in with the bees of sound colonies."

It will be noticed that Mr. McEvoy says nothing about confining the bees to the hive during the first process as in Jones's plan, nor does he advocate giving a clean hive or disinfecting the old one, which most beekeepers consider a very necessary precaution to take.

While on my rounds I examined a colony at an apiary in Hawke's Bay, on the 17th February last, which had been badly infected with disease and treated in the previous November, and out of some thirty-two colonies in the same apiary it was certainly one of the strongest when I saw it. Instead, however, of following the McEvoy plan closely, the bees were shaken off the frames down in front of a clean,

empty kerosene-case placed on the old stand, and on the fourth day after, changed into a clean hive furnished with full sheets of comb-foundation. While at the apiary I assisted in treating another in the same way. I am well aware that some years ago the owner of the same apiary was near giving up beekeeping in despair owing to "foul brood," but he is now well satisfied to continue, having practically mastered the disease by his treatment.

#### TREATMENT RECOMMENDED.

During the course of my rounds I have discussed the subject of treatment of "foul brood" with quite a number of our leading and most extensive beekeepers (to whom I acknowledge my indebtedness for their valuable assistance), who have had many years' experience in dealing with the disease, and who have by care and perseverance been able to master it, in so far that it now gives them but little anxiety. They, however, never relax their watchfulness for symptoms, and treatment at once follows their first appearance, as a matter of course. They were unanimous in their opinion that the only certain and effective treatment that will suppress and cure the disease is the starvation method, and there are only very trifling differences in some of the details in their mode of carrying it out.

The following remarks practically convey the gist of their several opinions and my own experience, and I have full confidence in recommending to our New Zealand beekeepers the following slight modifications of the McEvoy treatment.

In the spring, after the weather has become warm and settled, and honey being stored freely, and before much breeding is in progress (some time in November), is the most suitable time to deal with diseased colonies. Two good reasons may be advanced for this: First, because the disease in its earlier stages is more readily detected in spring; and, secondly, because the colonies treated at that time have an opportunity of recovering and becoming strong before the main honey-flow sets in. Treatment may also be carried out at any time during the honey season, but there must of necessity be greater sacrifice than when done in spring.

Keep a sharp look-out when going through the hives in early spring and mark any containing disease for treatment later on. Be cautious not to disturb the affected colonies more than can be avoided until time for treatment, lest robbing should take place. Where the disease is in an advanced stage and the colony very weak, it will be more safe and profitable to destroy the bees by sulphur or other means, and to melt the combs into wax or burn them *at once*. The

hive, frames, and bottom board should be either disinfected or burned as soon as possible before other bees get near them.

To avoid the risk of the bees decamping, as they are liable to do when suddenly deprived of their combs, especially in spring, the queen may be caged just previous to the operation, and the cage suspended between the frames after the operation and until the bees are again changed on the fourth day, when she may be released in the new hive. It is not absolutely necessary to cage the queen except as a precautionary measure. Examine the bees towards the close of the third day, and if many have fallen from the cluster feed them at once, either with frames of *clean* honey from healthy stocks or with sugar-syrup. Food should also be given when the weather is unfavourable at this time for gathering honey. Carry out all such operations *in the evening* when the other bees are quiet; get through as quietly and speedily as possible, and take care the diseased bees do not have an opportunity to enter other hives.

#### FOOD AND FEEDING.

Frames of honey from healthy colonies may be given, but if there be any doubt feed with sugar-syrup, made by adding half a pint of water to each 1 lb. of sugar used, and bringing it to the boiling-point; stir for the first few minutes till all the sugar is dissolved; when cool it will be ready for use. Empty, clean combs make capital feeders. They may be filled by placing them at an angle in a large milk-dish or a similar vessel and pouring in the syrup from a small strainer held 1 ft. or 1 ft. 3 in. above them. The falling syrup drives the air from the cells and takes its place. After filling them the combs should be suspended until they are free from drip, when they will be ready for use. In the absence of empty combs, syrup may be given in any of the ordinary feeders sold by hive-manufacturers, placed above the frames, turning a corner of the mat up to make a passage for the bees. It is advisable to put on an empty half-story body for convenience while using a feeder above the frames. Feeding should always be done late in the evening to prevent excitement and robbing.

#### DISINFECTING HIVES.

I certainly, in all cases, strongly recommend disinfecting hives and other implements that have been in contact with diseased colonies. In fact, I think it a good plan to do so with everything at the end of each season as a precautionary measure, whether "foul brood" is present or not.

The hives should be well scraped free from propolis, and the

scrapings burned ; then brush them with a solution of carbolic acid—1 oz. of acid (Calvert's No. 5) to 4 quarts of water well mixed—taking care the solution does not come in contact with the hands. Let the hives remain exposed to the air for several days before using them.

#### IV. THE LARGE BEE OR WAX MOTH (*Galleria mellonella*, Linn.).

This moth, so far as I am aware, has only quite recently made its appearance in New Zealand, brought here probably from Australia, where it is said to have been introduced from Europe about the year 1880. The larvæ or grubs of the moth were first sent to me by Messrs. H. Betts and Son, of Okaiawa, near Mount Egmont, in the early part of 1904, and I had no difficulty in recognising them as the larvæ of the large moth, having previously seen similar grubs in boxes with bees imported from Europe.

During my recent visit to the Okaiawa district I discovered the moth and grubs in three different apiaries a considerable distance apart from each other, so that it may be taken for granted the moth has now established itself in this colony. I have not yet seen it in any other district. In each of the hives where I found the moth the colony was very weak—a long way below the normal strength—which would, no doubt, account for its getting a footing ; in no case did I find it in colonies of normal strength. A favourite haunt of the grub is on the top of the frames under the mat, or where there are two mats it will get in between them. They are to be found there chiefly in the daytime, where they apparently hide from the bees, and attack the combs at night ; but when the colony becomes very weak the grubs show no such fear and attack the combs at all times.

It is the larvæ or grubs of the moth which prove so destructive to the combs, burrowing through them under the protection of strong silken galleries which they spin around themselves secure from the bees as they advance in their work of destruction. Eventually the combs are completely destroyed, and fall, a mass of web and cocoons, to the bottom of the hive (see Plate V.).

#### ITS HABITS AND NATURAL HISTORY.

The moth itself, which is usually to be seen during warm summer evenings flitting about the hives, watching for an opportunity to lay its eggs within or near the entrances, can readily discover weak colonies, when it does not hesitate to enter the hives, and thus the

grubs eventually get a footing, from which they are seldom or never dislodged by the bees.

Mr. Sidney Oliff, Government Entomologist for New South Wales, when writing some time ago on the natural history of this moth, said, "With us in New South Wales the first brood of moth appears in the early spring, from caterpillars which have passed the winter in a semi-dormant condition within the walls of their silken coverings, and only turned to pupæ or chrysalids upon the approach of warm weather. These winter (or hibernating) caterpillars feed very little, and usually confine their wanderings to the silken channels which they have made for themselves before the cool weather sets in. Upon the return of the desired warmth the caterpillars spin a complete cocoon for themselves and turn to the chrysalis stage, and in from ten days to a fortnight the perfect moth appears. The moth then lays its eggs in any convenient spot, such as the sides and bottoms of the frames, on the walls of the hive itself, or on the comb. In each case I have had an opportunity of observing the process, the moth chose the sides of the frames, as near to the brood combs as possible, the young larvæ having a decided preference for this comb. The larvæ having once made their appearance, which they usually do in from eight to ten days after the laying of the eggs, their growth is exceedingly rapid, the average time before they are ready to assume the chrysalis stage being only some thirty days. The average duration of the chrysalis period is about a fortnight, so it can easily be seen with what great capabilities for rapid reproduction we have to deal. As we have said, the number of generations, or broods, which develop in a season—*i.e.*, between early spring and late autumn—varies with locality and climate; but it may be worth while to record that, in my opinion, we have sufficient evidence to prove the existence of four broods in the Sydney district under ordinary circumstances."

The average length of the grub is about 1 in., and "when first hatched it is pale yellow with a slightly darker head, and of a greyish flesh-colour when full-grown, with a dark reddish-brown head." The length of the moth is about  $\frac{3}{4}$  in., "has reddish brown-grey forewings, which are distinctly lighter in colour towards the outer or hinder margins."

#### REMEDIES.

It has been frequently remarked, and no doubt with a considerable amount of truth, that the moth is only the enemy of the careless beekeeper—intending to convey the idea that with care and attention there need be no fear of it doing damage in the apiary. A colony of bees at its normal strength is practically proof against all its enemies, but the box-hive beekeeper who



cannot control his bees has the most to fear from this moth, for when once it gets into a box hive there is no means of getting rid of it without cutting out all the combs, which in such a case would practically mean the destruction of the colony. On the other hand, the up-to-date beekeeper with movable-frame hives, and who follows the golden rule of beekeeping—viz., keeping all colonies strong—has nothing whatever to fear from the moth or any other enemies of the bee.

Italian bees can protect themselves against the large moth better than the common or black bees, therefore on this account alone it is advisable to cultivate these in preference to the others.

#### FUMIGATING COMBS.

It is not only the combs within the hives that are liable to be attacked by the moth, but they become a prey to the latter wherever they happen to be unprotected. No combs or pieces of combs should be allowed to lie about; when they are of no further service they should be melted into wax at once. Spare combs should always be stored in a place of safety from the moth, and inspected frequently. On the first sign of grubs they should be fumigated, and a few days after should undergo a second fumigation. When there are not many to do they may be suspended in empty hives about 1 in. apart, and the latter piled one on the other, taking care that the junctions of the boxes are made smoke-tight by pasting a strip of paper round them. The top box of the pile should contain no frames. Into this place an old iron saucepan containing live wood-embers, and on to these throw a couple of handfuls of sulphur, close the cover securely and keep closed for a couple of days. In a large apiary it is best to have a small room fitted up for the purpose. Two or three pounds of sulphur will be sufficient for a large room.

#### V. APICULTURE IN RELATION TO AGRICULTURE.\*

The benefits derived by both agriculturists and horticulturists from the labours of the bee are now very generally understood and

---

\* This paper, which constituted the nineteenth chapter of the third edition of my "Australasian Bee Manual" (now out of print), was an attempt, and I have reasons for believing a successful attempt, to clear up several misunderstandings that had arisen in the minds of some farmers who had come to regard the working of neighbours' bees on their pasturage as detrimental to themselves, and to prove on the contrary that it is really to their interests to encourage beekeeping. Shortly after the paper was first published the subject was brought prominently forward in consequence of the action taken by a farmer in the United States to claim damages from a neighbouring beekeeper for alleged injury done to his grazing-sheep by trespassing(?) bees. Needless to say, he lost his case. The paper has been extensively quoted in several American bee journals, and described as a "unique and valuable addition to bee literature" I trust it may still serve a good purpose in this country where it first appeared.

acknowledged ; but still cases do sometimes occur, though rarely, of farmers objecting to the vicinity of an apiary, and complaining of bees as “ trespassers,” instead of welcoming them as benefactors.

#### ARE BEES TRESPASSERS ?

It is not, perhaps, surprising that at first a man should imagine he was being injured in consequence of bees gathering honey on *his land*, to be stored up elsewhere, and for the use of other parties ; he might argue that the honey belonged by right to him, and even jump at the conclusion that there was so much of the *substance of the soil* taken away every year, and that his land must therefore become impoverished. It is true that if he possessed such an amount of knowledge as might be expected to belong to an intelligent agriculturist, working upon rational principles, he should be able, upon reflection, to see that such ideas were entirely groundless. Nevertheless the complaint is sometimes made, in a more or less vague manner, by persons who ought to know better ; and even bee-keepers appear occasionally to adopt an apologetic tone, arguing that “ bees do more good than harm,” instead of taking the much higher and only true stand by asserting that bees, while conferring great benefits on agriculture, *do no harm whatever*, and that the presence of an apiary on or close to his land *can be nothing but an advantage to the agriculturist*.

#### BENEFICIAL INFLUENCE OF BEES ON AGRICULTURE.

We have already in Chapter III. dwelt upon the value of the intervention of bees in the cross-fertilisation of plants, and can here only refer the reader for further information to the works of Sir J. Lubbock and of Darwin. The latter, in his work on “ Cross and Self Fertilisation of Plants,” gives the strongest evidence as to the beneficial influence of bees upon clover-crops. At page 169, when speaking of the natural order of leguminous plants, to which the clovers belong, he says, “ The cross-seedlings have an enormous advantage over the self-fertilised ones when grown together in close competition ” ; and in Chapter X., page 361, he gives the following details of some experiments, which show the importance of the part played by bees in the process of cross-fertilisation :—

*Trifolium repens* (White Clover).—Several plants were protected from insects, and the seeds from ten flower-heads on these plants and from ten heads on other plants growing outside the net (which I saw visited by bees) were counted, and the seeds from the latter plants were very nearly ten times as numerous as those from the protected plants. The experiment was repeated in the following year, and twenty protected heads now yielded only a single abortive seed, whilst twenty heads on the plants outside the net (which I saw visited by bees) yielded 2,290 seeds,

as calculated by weighing all the seeds and counting the number in a weight of two grains.

*Trifolium pratense* (Purple Clover).—One hundred flower-heads on plants protected by a net did not produce a single seed, whilst one hundred on plants growing outside (which were visited by bees) yielded 68 grains weight of seed; and as eighty seeds weighed 2 grains the hundred heads must have yielded 2,720 seeds.

Here we have satisfactory proof that the effect of cross-fertilisation brought about by bees upon the clovers and other plants growing in meadows and pasture lands is the certain production of a large number of vigorous seeds, as compared with the chance only of a few and weak seeds if self-fertilisation were to be depended upon. In the case of meadow-cultivation it enables the farmer to raise seed for his own use or for sale, instead of having to purchase it, while at the same time the nutritious quality of the hay is, as we shall see further on, improved during the process of ripening the seed. In the case of pasture lands, such of those vigorous seeds as are allowed to come to maturity and to fall in the field will send up plants of a stronger growth to take the place of others that may have died out, or to fill up hitherto-unoccupied spaces, thus tending to cause a constant renewal and strengthening of the pasture. The agriculturist himself should be the best judge of the value of such effects.

The beneficial effect of the bees' visits to fruit-trees has been well illustrated by Mr. Cheshire in the pages of the *British Bee Journal*, and by Professor Cook in his article upon "Honey Bees and Horticulture" in the *American Apiculturist*. In fact, even those who complain of bees cannot deny the services they render; what they contest is the assertion that *bees do no harm*.

#### CAN BEES HARM THE SOIL OR THE CROPS?

is then the question to be considered. The agriculturist may say, "Granting that the visits of bees may be serviceable to me in the fertilisation of my fruit or my clover, how will you prove that I am not obliged to pay too high a price for such services?" For the answer to such a question one must fall back upon the researches of the agricultural chemist, which will furnish satisfactory evidence to establish the two following facts: First, that saccharine matter, even when assimilated and retained within the body of a plant, is not one of the secretions of vegetable life which can in any way tend to exhaust the soil, being made up of constituents which are furnished everywhere in superabundance by the atmosphere and rain-water, and not containing any of the mineral or organic substances supplied by the soil or by the manures used in agriculture; and, secondly, that in the form in which it is appropriated by bees, either

from the nectaries of flowers or as honeydew from the leaves, it no longer constitutes a part of the plant, but is in fact an excrement, thrown off as superfluous, which if not collected by the bee and by its means made available for the use of man would either be devoured by other insects which do not store honey, or be resolved into its original elements and dissipated in the air.

The foregoing statements can be supported by reference to authorities which can leave no doubt as to their correctness—namely, Sir Humphrey Davy in his “Elements of Agricultural Chemistry,” written more than fifty years ago, and Professor Liebig in his “Chemistry in its Application to Agriculture and Physiology,” written some ten years later, and the English version of which is edited by Dr. Lyon Playfair and Professor Gregory. These works, which may be said to form the foundation of a rational system of agriculture, were written with that object alone in view, and the passages about to be quoted were not intended to support any theory in favour of bee-culture or otherwise; they deal simply with scientific truths which the layman can safely follow and accept as true upon such undeniable authority, although he may be incapable himself of following up the processes which have led to their discovery or which prove their correctness.

#### SACCHARINE MATTER OF PLANTS NOT DERIVED FROM THE SOIL.

Liebig, when describing the chemical processes connected with the nutrition of plants, informs us (at page 4\*) that—

There are two great classes into which all vegetable products may be arranged. The first of these contain nitrogen; in the last this element is absent. The compounds destitute of nitrogen may be divided into those in which oxygen form a constituent (starch, lignine, &c.) and those into which it does not enter (oils of turpentine, lemon, &c.)

And at page 141 that—

Sugar and starch do not contain nitrogen; they exist in the plants in a free state, and are never combined with salts or with alkaline bases. They are compounds formed from the carbon of the carbonic acid and the elements of water (oxygen and hydrogen).

Sir Humphrey Davy had already stated that, “according to the latest experiments of Gay Lussac and Thenard, sugar consists of 42·47 per cent. of carbon and 57·23 per cent. of water and its constituents.” Now, Liebig in several parts of his work shows that the carbon in sugar and all vegetable products is obtained from carbonic acid in the atmosphere; and that “plants do not exhaust the carbon of the soil in the normal condition of their growth; on the contrary, they add to its quantity.”

---

\* The edition to which reference is made is the fourth, published 1847.

### DERIVED FROM THE ATMOSPHERE AND RAIN-WATER.

The same authority shows that the oxygen and hydrogen in these products are derived from the atmosphere and from rain-water; and that it is only the products containing nitrogen (such as gluten or albumen in the seeds or grains), and those containing mineral matter (silex, lime, aluminium, &c.), which take away from the soil those substances that are required to be returned to it in the shape of manures. The saccharine matter once it is secreted by the plant and separated from it is even useless as a manure. Liebig says on this head, page 21,—

The most important function in the life of plants, or, in other words, in their assimilation of carbon, is the separation—we might almost say the generation—of oxygen. No matter can be considered as nutritious or as necessary to the growth of plants which possesses a composition either similar to or identical with theirs, because the assimilation of such a substance could be effected without the exercise of this function. The reverse is the case in the nutrition of animals. Hence such substances as sugar, starch, and gum, themselves the products of plants, cannot be adapted for assimilation; and this is rendered certain by the experiments of vegetable physiologists, who have shown that aqueous solutions of these bodies are imbibed by the roots of plants and carried to all parts of their structure, but are not assimilated; they cannot therefore be employed in their nutrition.

### NECTAR OF PLANTS INTENDED TO ATTRACT INSECTS.

The secretion of saccharine matter in the nectaries of flowers is shown to be one of the normal functions of the plant, taking place at the season when it is desirable to attract the visits of insects for the purposes of its fertilisation. It may then be fairly asserted that the insect when it carries off the honey from any blossom it has visited is merely taking with it the fee or reward provided by nature for that special service.

### SOMETIMES THROWN OFF AS SUPERFLUOUS.

There are, however, occasions when considerable quantities of such matter are thrown off or exuded by the leaves, which effect is taken to indicate an abnormal or unhealthy condition of the plant. At pages 106 and 107 of Liebig's book (speaking of an experiment made to induce the rising sap of a maple-tree to dissolve raw sugar applied through a hole cut in the bark) he shows (in a passage already quoted at page 86) that,—

When a sufficient quantity of nitrogen is not present to aid in the assimilation of the substances destitute of it, these substances will be separated as excrements from the bark, roots, leaves, and branches

In a note to this last paragraph we are told that—

Langlois has lately observed, during the dry summer of 1842, that the leaves of the linden-tree became covered with a thick and sweet liquid in such quantities that for several hours of the day it ran off the leaves like drops of rain. Many kilograms might have been collected from a moderate-sized linden-tree.

And further on, at page 141, he says,—

In a hot summer, when the deficiency of moisture prevents the absorption of alkalies, we observe the leaves of the lime-tree, and of other trees, covered with a thick liquid containing a large quantity of sugar; the carbon of the sugar must without doubt be obtained from the carbonic acid of the air. The generation of the sugar takes place in the leaves, and all the constituents of the leaves, including the alkalies and alkaline earths, must participate in effecting its formation. Sugar does not exude from the leaves in moist seasons, and this leads us to conjecture that the carbon which appeared as sugar in the former case would have been applied in the formation of other constituents of the tree in the event of its having had a free and unimpeded circulation.

These quotations will probably be considered sufficient to justify the assertion that the gathering of the honey from plants can in no possible way tend to exhaust the soil, or affect its fertility. There is no difference of opinion amongst scientific men as to the sources from which the saccharine matter of plants is derived. Since Liebig first put forward his views on that subject, as well as with regard to the sources from which the plants derive their nitrogen, the principles of agricultural chemistry have been studied by the most eminent chemists, some of whom combated the views of Liebig on this latter point (the source of nitrogen and its compounds), and Liebig himself seems to have modified his views on that point; but there has been no difference of opinion about the saccharine matter, as to which Liebig's doctrine will be found given unaltered in the latest colonial work on the subject, MacIvor's "Chemistry of Agriculture," published at Melbourne a few years ago.

#### SUPERFLUOUS NECTAR EVAPORATED IF NOT TAKEN BY INSECTS.

That the nutritive quality of the plants in any growing crop is not diminished by the abstraction of honey from their blossoms would appear to be evident from the fact already referred to, that those plants have actually thrown off the honey from the *superfluity* of their saccharine juices, as a matter which they could no longer assimilate. There would appear, on the other hand, to be good reason to believe that the plants themselves become daily *more* nutritive during the period of their giving off honey—that is, from the time of flowering to that of ripening their seeds. This is a point upon which, I believe, all agricultural chemists are not quite agreed, but the testimony of Sir H. Davy is very strong in favour of it. In

the appendix to his work already quoted, he gives the results of experiments made conjointly by himself and Mr. Sinclair, the gardener to the Duke of Bedford, upon nearly a hundred different varieties of grasses and clovers. These were grown carefully in small plots of ground as nearly as possible equal in size and quality; equal weights of the dried produce of each cut at different periods, especially at the time of flowering and at that of ripened seeds, were "acted upon by hot water till all their soluble parts were dissolved; the solution was then evaporated to dryness by a gentle heat in a proper stove, and the matter obtained carefully weighed, and the dry extract, supposed to contain the nutritive matter of the plants, was sent for chemical analysis." Sir H. Davy adds his opinion that this "mode of determining the nutritive power of grasses is sufficiently accurate for all the purposes of agricultural investigation." Further on he reports, "In comparing the compositions of the soluble products afforded by different crops from the same grass, I found, in all the trials I made, the largest quantity of truly nutritive matter in the crop cut when the seed was ripe, and the least bitter extract and saline matter, and the most saccharine matter, in proportion to the other ingredients, in the crop cut at the time of flowering." In the instance which he then gives, as an example, the crop cut when the seed had ripened showed 9 per cent. *less* of sugar, but 18 per cent. more of mucilage and what he terms "truly nutritive matter" than the crop cut at the time of flowering. From this it would follow that during the time a plant is in blossom and throwing off a superfluity of saccharine matter in the shape of honey the assimilation of true nutritive matter in the plant itself is progressing most favourably. In any case it is clear that the honey, being once exuded, may be taken away by bees or any other insects (as it is evidently intended to be taken) without any injury to the plant, by which it certainly cannot be again taken up, but must be evaporated if left exposed to the sun's heat.

#### QUESTION AS TO GRAZING-STOCK.

There is, however, a plea put in by the agriculturist on behalf of his grazing-stock, and one which he generally seems to consider unanswerable. He says, "Even if it be admitted that the removal of the honey from my farm is neither exhausting to the soil nor injurious to the plants of the standing crops, still it is so much fattening-matter which might be consumed by my stock if it had not been pilfered by the bees."

Now, it may at once be admitted that honey consists to a great extent of fattening-matter, though it may be allowable to doubt

whether in that particular form it is exactly suitable as food for grazing-cattle. Although it is quite true that the saccharine matter assimilated in the body of a plant tends to the formation of fat in the animal which eats and digests that plant, still one may question the propriety of feeding the same animal on pure honey or sugar. We may, however, waive that view of the subject, as we shall shortly see that it is only a question of such homœopathically small doses as would not be likely to interfere with the digestion of the most delicate grazing-animal, any more than they would considerably increase its weight. Admitting, therefore, that every pound of honey of which the grazing-stock are deprived by bees is a loss to the farmer, and therefore to be looked upon as a set-off to that extent against the benefits conferred by the bees in other ways, it will be necessary to consider to what extent it is possible that such loss may be occasioned.

#### QUANTITY OF HONEY FURNISHED BY PASTURE LAND.

In the first place, it must be recollected that a large proportion—in some cases the great bulk—of the honey gathered by bees is obtained from trees, as, for instance, the linden in Europe, the bass-wood and maple in America, and in this country the forest trees, nearly all of which supply rich forage for the bee, and everywhere from fruit-trees in orchards. A large quantity is gathered from flowers and flowering shrubs reared in gardens; from clover and other plants grown for hay, and not for pasture; and even in the field there are many shrubs and flowering plants which yield honey, but which are never eaten by cattle. Pastures, therefore, form but a small part of the sources from which honey is obtained; and in dealing with this grazing question we have to confine our inquiries to clovers and other flowering plants grown in open pastures, and such as constitute the ordinary food of grazing-stock. In order to meet the question in the most direct manner, however, let us assume the extreme case of a large apiary being placed in a district where there is nothing else but such open pastures, and growing only such flowering plants as are generally eaten by stock. Now, the ordinary working-range of the bee may be taken at a mile and a half from the apiary on all sides, which gives an area of about 4,500 acres for the supply of the apiary; and if the latter consists of a hundred hives, producing an average of 100 lb. of honey, there would be a little more than 2 lb. of honey collected off each acre in the year; or, if we suppose so many as two hundred hives to be kept at one place, and to produce so much as 10 tons of honey in the season, the quantity collected from each acre would be 4 lb. to 5 lb.



PROPORTION POSSIBLY CONSUMED BY STOCK.

Let us next consider what proportion of those few pounds of honey could have found its way into the stomachs of the grazing-stock if it had not been for the bees. It is known that during the whole time the clover or other plants remain in blossom, if the weather be favourable, there is a daily secretion of fresh honey, which, if not taken at the proper time by bees or other insects, is evaporated during the midday heat of the sun. It has been calculated that a head of clover consists of fifty or sixty separate flowers, each of which contains a quantity not exceeding one five-hundredth part of a grain in weight, so that the whole head may be taken to contain *one-tenth* of a grain of honey at any one time. If this head of clover is allowed to stand until the seeds are ripened it may be visited on ten or even twenty different days by bees, and they may gather on the whole one, or even two, grains of honey from the same head, whereas it is plain that the grazing-animal can only eat the head once, and consequently can only eat one-tenth of a grain of honey with it. Whether he gets that one-tenth grain or not depends simply on the fact whether or not the bees have exhausted that particular head on *the same day just before it was eaten*. Now, cattle and sheep graze during the night and early morning, long before the bees make their appearance some time after sunrise; all the flowering plants they happen to eat during that time will contain the honey secreted in the evening and night-time; during some hours of the afternoon the flowers will contain no honey, whether they have been visited by bees or not; and even during the forenoon, when the bees are not busy, it is by no means certain that they will forestall the stock in visiting any particular flower. If a field were so overstocked that every head of clover should be devoured as soon as it blossomed, then, of course, there would be nothing left for the bees; but if, on the other hand, as is generally the case, there are always blossoms left standing in the pasture, some of them even till they wither and shed their seeds, then it must often happen that after bees shall have visited such blossoms ten or even twenty times, and thus collected one or even two grains of honey from one head, the grazing-animal may, after all, eat that particular plant and enjoy his one-tenth of a grain of honey just as well as if there had never been any bees in the field. If all these chances be taken into account it will be evident that out of the 4 lb. or 5 lb. of honey assumed to be collected by bees from one acre of pasturage probably not one-tenth, and possibly not even one-twentieth, part could under any circumstances have been consumed by the grazing-animals—so that it becomes a question of *a few ounces* of fattening-matter, more or less, for all the stock fed

upon an acre during the whole season ; a matter so ridiculously trivial in itself, and so out of all proportion to the services rendered to the pasture by the bees, that it may be safely to be left out of consideration altogether.

#### BEEKEEPING AS A BRANCH OF FARMING.

There is still one point which may possibly be raised by the agriculturist or landowner : " If the working of bees is so beneficial to my crops, and if such a large quantity of valuable matter may be taken, in addition to the ordinary crops, without impoverishing my land, why should I not take it instead of another person who has by right no interest in my crop or my land ? " The answer to this is obvious. It is, of course, quite open to the agriculturist to keep any number of bees he may think fit ; only, he must consider well in how far it will pay him to add the care of an apiary to his other duties. No doubt every one farming land may with advantage keep a few stands of hives to supply his own wants in honey ; the care of them will not take up too much of his time, or interfere much with his other labours ; but if he starts a large apiary with the expectation that it shall pay for itself, he must either give up the greater portion of his own time to it or employ skilled labour for that special purpose ; and he must recollect that the profits of beekeeping are not generally so large as to afford more than a fair remuneration for the capital, skill, and time required to be devoted to the pursuit. In any case, he cannot confine the bees to work exclusively on his own property, unless the latter is very extensive. When such is the case, he may find it greatly to his advantage to establish one or more apiaries to be worked under proper management, as a separate branch of his undertaking ; but in every case, whether he may incur or share the risks of profit and loss in working an apiary or not, the thing itself can only be a source of unmixed advantage to his agricultural operations, and consequently if he does not occupy the ground in that way himself he should only be glad to see it done by any other person.





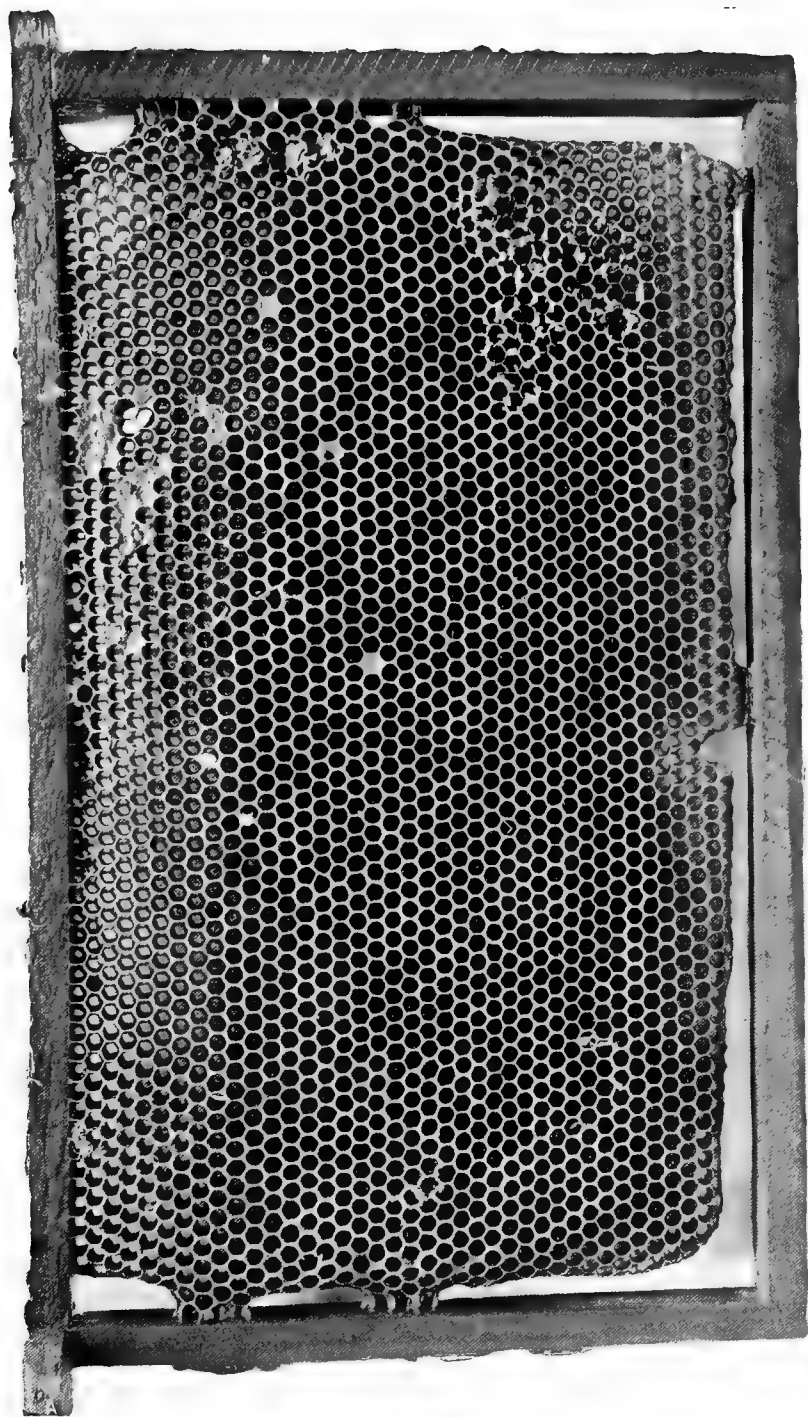

PLATE I. WORKER-COMB, BUILT OUT ON A SHEET OF WORKER-COMB FOUNDATION. (ORIGINAL)

[Photo. by R. Watrond.]



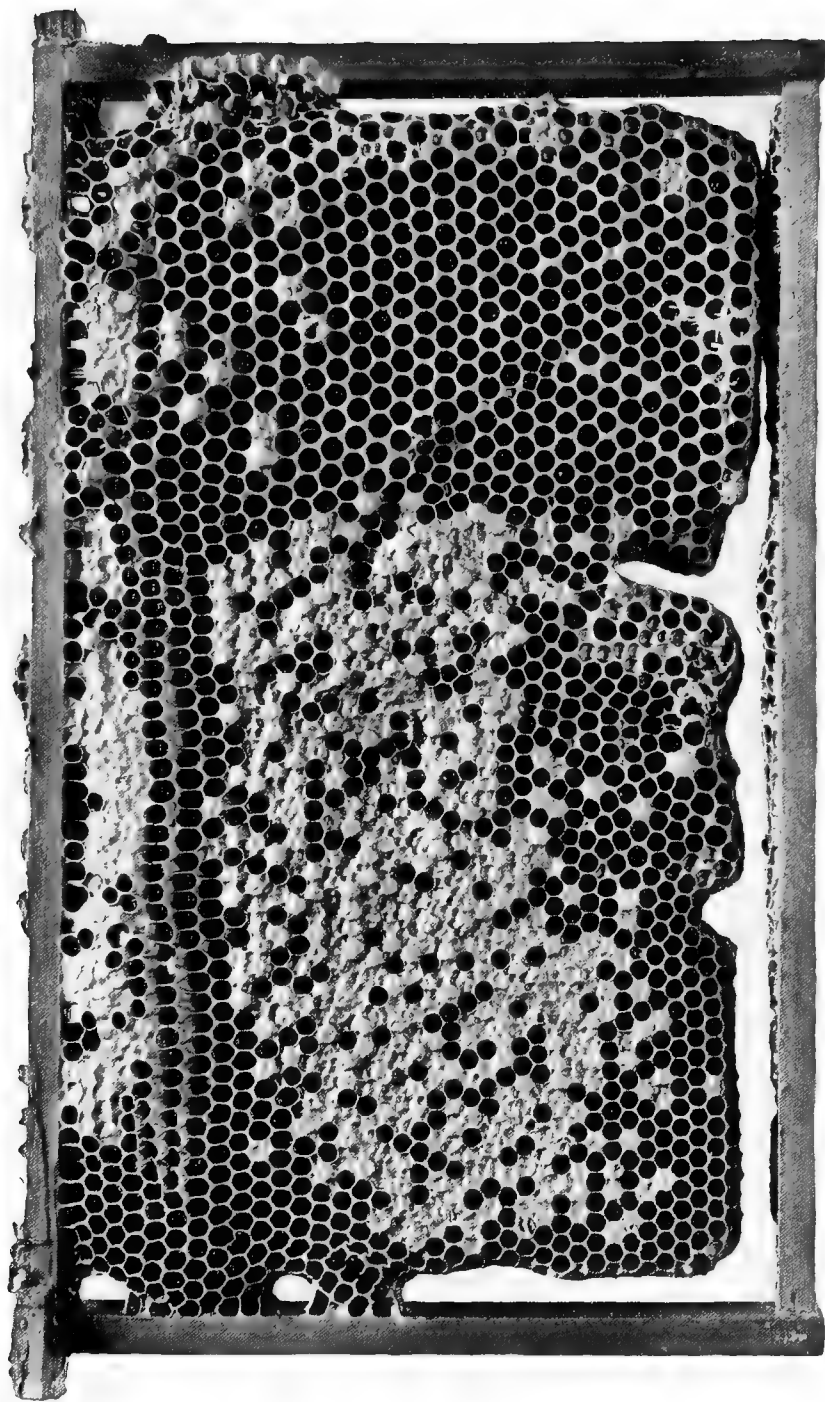

PLATE II. COMB SHOWING DRONE-CELLS TO THE RIGHT AND UPPER LEFT CENTRE, AND DISEASED ("FOUL BROOD") WORKER-CELLS IN THE REMAINDER. (ORIGINAL)

*Bee-culture.*

[Photo. by R. Watrond.]





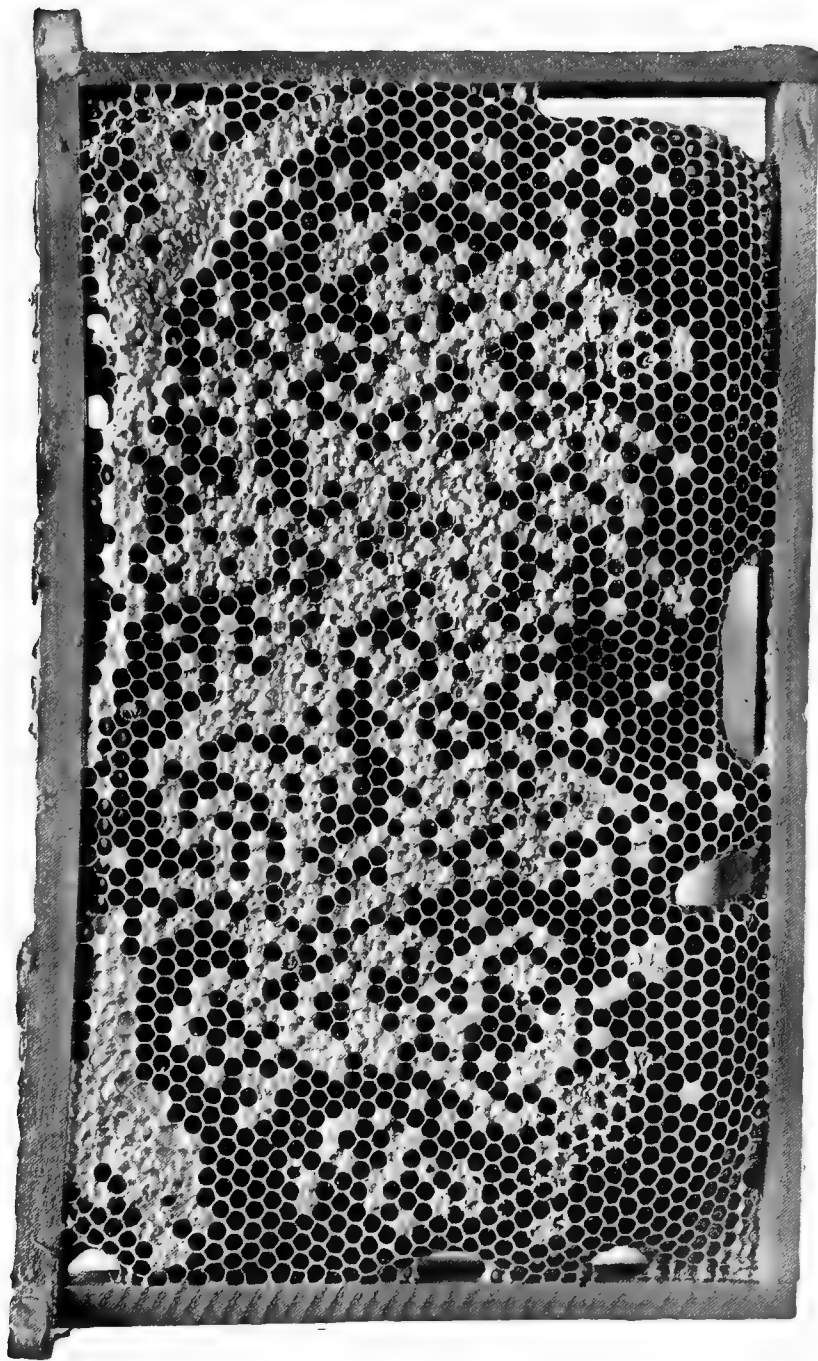

PLATE III. COMB INFECTED WITH 'FOUL BROOD' (*Bacillus alvei*) IN AN ADVANCED STAGE. (ORIGINAL.)

*Bee-culture.*

[Photo. by R. Watrond.]



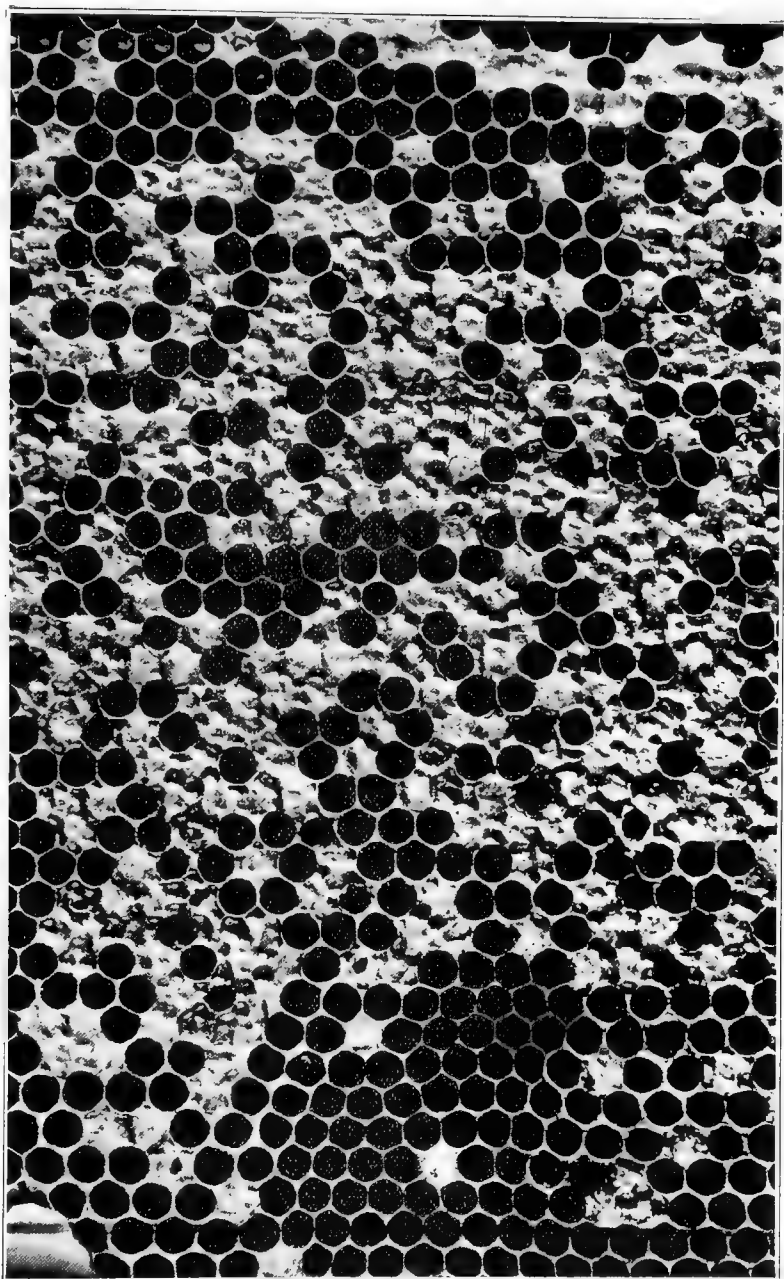

PLATE IV. A PORTION OF THE DISEASED COMB SHOWN IN PLATE III., ENLARGED TO NATURAL SIZE.  
*Bee-culture.*]





PLATE V. COMB ATTACKED AND NEARLY DESTROYED BY LARGE WAX-MOTH (*Galleria mellonella*). (ORIGINAL.)  
[Photo. by Mr. Ross.]  
*Bee-culture.*]









First Edition, 10,000 May, 1905. Second Edition,  
Revised and Enlarged, 10,000, December, 1907.

New Zealand Department of Agriculture.

*JOHN D. RITCHIE, Secretary.*

DIVISION OF BIOLOGY AND HORTICULTURE.

*T. W. KIRK, F.L.S., Government Biologist, Chief of Division.*

BULLETIN No. 5.

**BEE - CULTURE.**

- I. Practical Advice.
- II. Apiculture in Relation to Agriculture.

By ISAAC HOPKINS, APIARIST.

ILLUSTRATED.

---

The Hon. **ROBERT McNAB**, Minister for Agriculture.

---



WELLINGTON.

BY AUTHORITY: JOHN MACKAY, GOVERNMENT PRINTER.

1907.



First Edition, 10,000, May, 1905. Second Edition,  
Revised and Enlarged, 10,000, December, 1907.

New Zealand Department of Agriculture

*JOHN D. RITCHIE, Secretary*

DIVISION OF BIOLOGY AND HORTICULTURE.

*T. W. KIRK, F.L.S., Government Biologist, Chief of Division.*

BULLETIN No. 5.

# BEE - CULTURE.

I. Practical Advice.

II. Apiculture in Relation to Agriculture.

By ISAAC HOPKINS, APIARIST.

ILLUSTRATED.

---

The Hon. ROBERT McNAB, Minister for Agriculture.

---



WELLINGTON.

BY AUTHORITY: JOHN MACKAY, GOVERNMENT PRINTER,

1907.



# CONTENTS.

## PRACTICAL ADVICE.

	Page
I. The Use of Comb-foundation .. .. .	1
II. The Ripening and Maturing of Honey .. .. .	3
Amount of Moisture in Honey .. .. .	3
Testing Honey for Ripeness .. .. .	4
Specific Gravity of Honey .. .. .	4
Tests made .. .. .	4
Method of Testing .. .. .	5
Honey Vinegar .. .. .	6
Ripening Honey inside and outside the Hive .. .. .	6
Ripening and Maturing Tanks .. .. .	8
Size of Honey-tanks .. .. .	9
E. W. Alexander's Honey-tank .. .. .	10
Heating the Honey-house at Night .. .. .	10
III. Dealing with Thick Honey .. .. .	11
Flora from which Thick Honey is gathered .. .. .	12
Making the Best of the Difficulty .. .. .	12
Honey-press .. .. .	12
IV. Diseases of Bees and their Treatment .. .. .	14
Foul-brood .. .. .	14
Pickle-brood .. .. .	19
Chilled, Overheated, and Starved Brood .. .. .	19
Palsy or Paralysis .. .. .	19
V. The Large Bee or Wax Moth .. .. .	20
"The Apiaries Act, 1907" .. .. .	22
A Cheap Frame Hive .. .. .	23
VI. Spring Feeding of Bees .. .. .	25
The Cause of Starvation .. .. .	25
When and how to feed .. .. .	26
Feeders .. .. .	26

## APICULTURE IN RELATION TO AGRICULTURE.

Are Bees Trespassers? .. .. .	27
Beneficial Influence of Bees on Agriculture .. .. .	27
Can Bees harm the Soil or the Crops? .. .. .	29
Saccharine Matter of Plants not derived from the Soil .. .. .	29
Derived from the Atmosphere and Rain-water .. .. .	30
Nectar of Plants intended to attract Insects .. .. .	30
Sometimes thrown off as superfluous .. .. .	31
Superfluous Nectar evaporated if not taken by Insects .. .. .	32
Question as to Grazing stock .. .. .	33
Quantity of Honey furnished by Pasture Land .. .. .	33
Proportion possibly consumed by Stock .. .. .	34
Beekeeping as a Branch of Farming .. .. .	35



## PREFACE TO SECOND EDITION.

---

THE increasing demand for instruction in bee-culture consequent upon the rapid expansion of the industry throughout the Dominion has necessitated the issue of a second edition of this Bulletin.

The matter contained in the first edition has been revised and largely added to, and several other subjects of importance are dealt with in this edition.

Beekeepers will be interested in learning that since the Bulletin was in print I have received from Dr. E. F. Phillips, in charge of the Division of Apiculture, United States Department of Agriculture, a report upon specimens of diseased combs collected from the extreme ends of New Zealand, and forwarded by myself to him. The results of the investigation go to prove that we have the milder or "American" form of foul-brood, and not the dreaded "black-brood" prevalent in Europe. Dr. Phillips says, "You are, then, able to say that American foul-brood exists in New Zealand, and that it is caused by *Bacillus larvæ*."

It will be well to note when reading section 9 of the Apiaries Act (page 23) that the Act came into force on the 14th September, 1907.

I. HOPKINS.







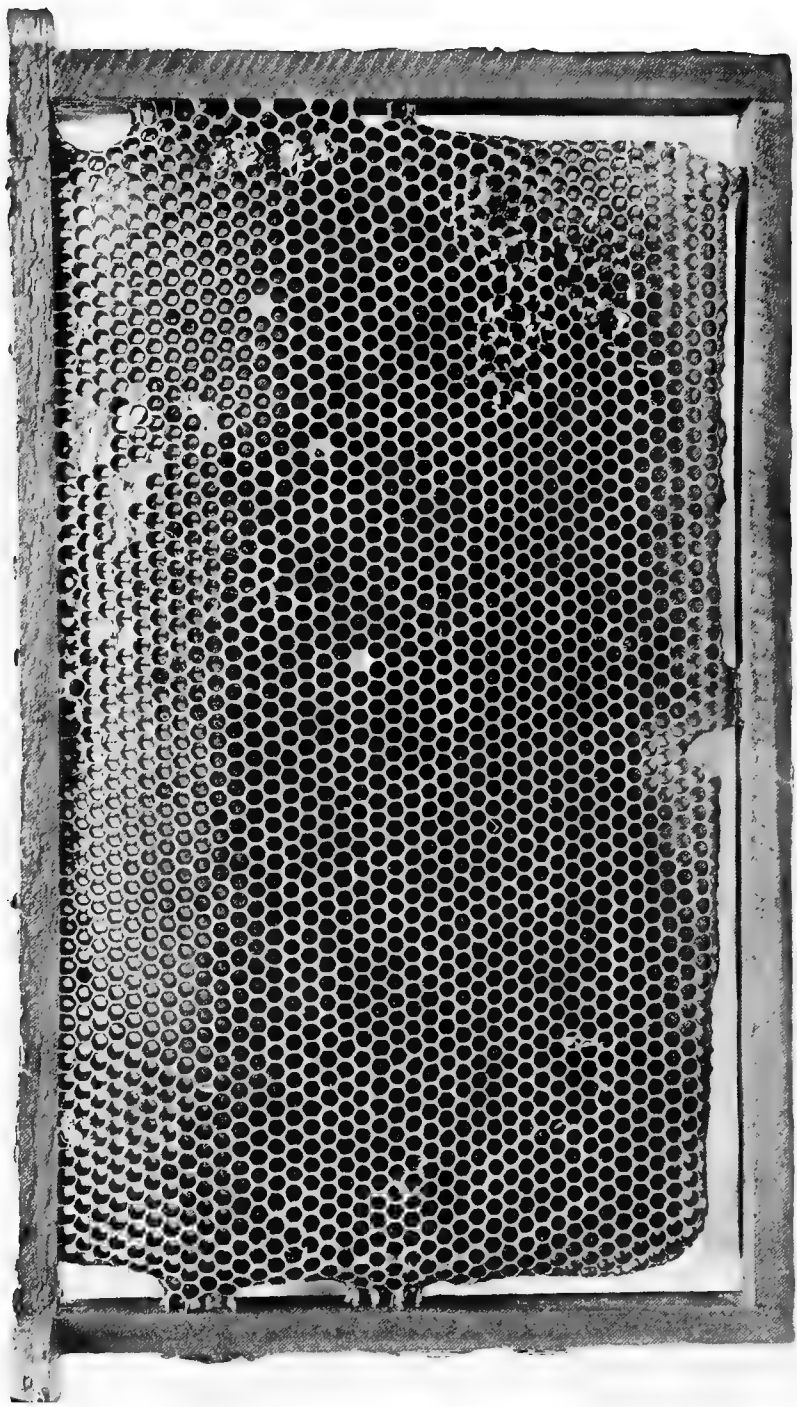

PLATE I. WORKER-COMB, BUILT OUT ON A SHEET OF WORKER-COMB FOUNDATION. (ORIGINAL.)  
[Photo. by R. Waldron.]  
*Bee culture.*]



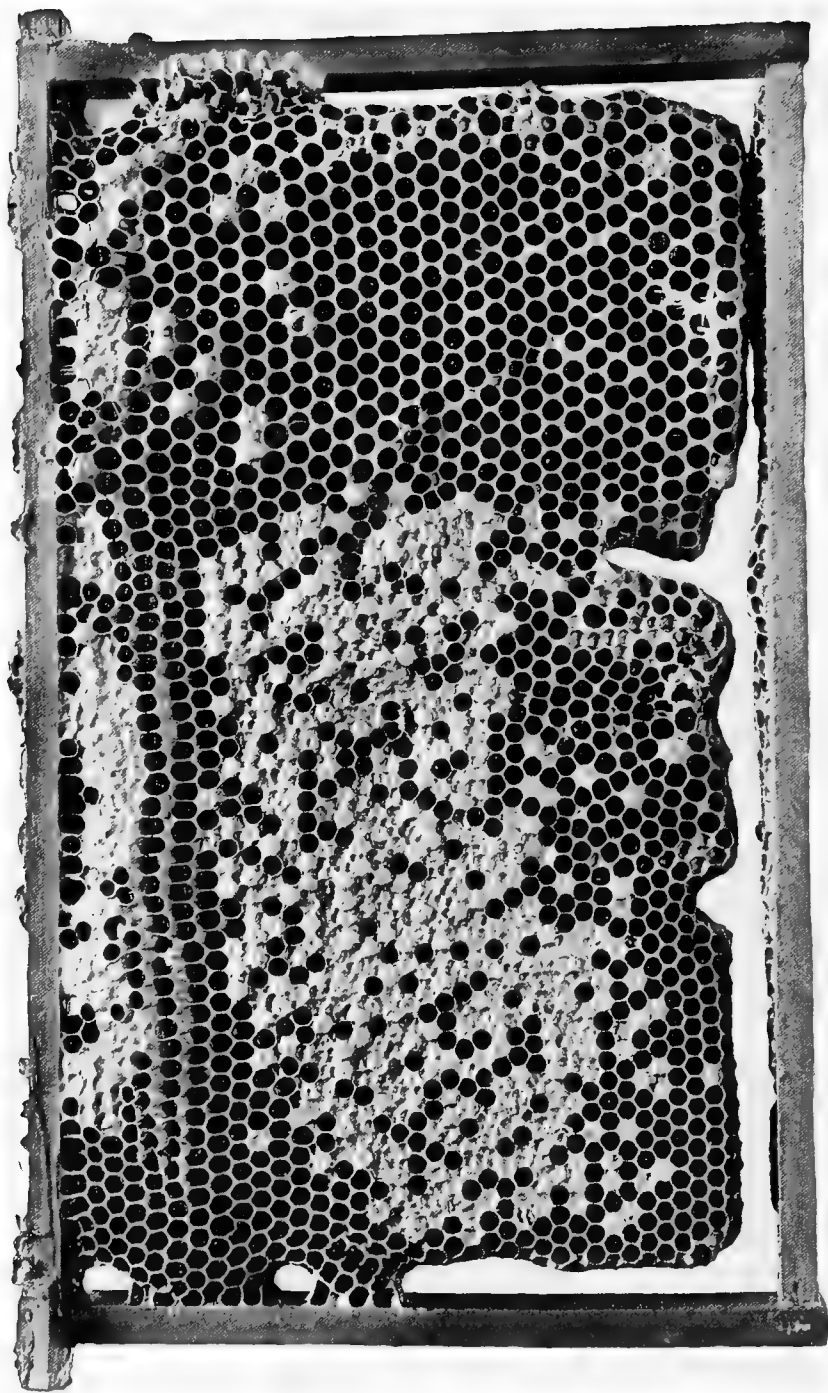

PLATE II. COMB SHOWING DRONE-CELLS TO THE RIGHT AND UPPER LEFT CENTRE, AND DISEASED  
("FOUL BROOD") WORKER-CELLS IN THE REMAINDER. (ORIGINAL.)

[Photo. by R. Watrond.]

# BEE-CULTURE.

---

## I. PRACTICAL ADVICE.

---

### I. THE USE OF COMB-FOUNDATION.

---

THE success of modern bee-culture hinges almost entirely in the first place on securing complete control over the breeding, and this can only be obtained by compelling the bees to build whatever kind of comb is desired. Under natural conditions, or when in hives and allowed freedom to construct their combs, they invariably build a goodly proportion of drone-comb, which is subsequently utilised for breeding drones. This accounts for the large number of drones to be seen in box hives, or where no attempt has been made to control breeding. Drones, as most people are aware, are non-producers—that is to say, they do not gather honey, or even, so far as we know, do any work in the hives. They are physically incapable, but they consume a large quantity of food gathered by the workers, and where many are present the yield of honey from that hive, and consequently the profit, will be considerably curtailed. Some drones are needed for the impregnation of young queens, but it is found in practice that a sufficient number for this purpose will be bred, even when the breeding of them is restricted as much as possible, by making the fullest use of worker-comb foundation.

The difference between worker and drone comb is in the size of the cells, the former measuring slightly over five to the inch, and the latter a little over four. The proportions are shown in Plate II. Drones can only be bred in the larger and workers in the smaller cells. The comb-foundation obtained from manufacturers is invariably impressed with the bases of worker-cells, so that it is impossible, unless by accident some portion has stretched, for the bees to build other than worker-comb on it. The illustrations will make this clear. Plate I shows a perfect worker-comb built out on a full sheet of comb-foundation, while Plate II exhibits the result of the breaking-away of a portion and the stretching of

another portion due to careless fixing of what was originally a perfect sheet of worker-comb foundation. These are very interesting reproductions from photographs taken specially for the purpose of this bulletin. To the right of Plate II can be seen where the bees took advantage of the accident to build drone-comb, and also where on the upper left centre the original worker-cells have stretched and been utilised for breeding drones. At the lower right-hand corner of Plate I a small portion of the original sheet of comb-foundation upon which the comb is built can be distinctly seen.

Securing control over breeding is not the only advantage gained by a free use of comb-foundation. For instance, a fair swarm of, say, 5 lb. weight hived upon ten sheets of comb-foundation in a Langstroth hive will have in twenty-four hours, in an average season, several of the sheets partially worked out and a goodly number of eggs deposited in the cells, and in thirty-six hours the queen can henceforward lay to her full extent. In from a week to nine days (depending upon the weather) the whole ten sheets will be worked out into worker-combs, and a great deal occupied with brood and honey, and the hive will then be ready for the top or surplus honey super. In twenty-two or twenty-three days young worker-bees will begin to emerge, and from this on the colony will grow rapidly in strength from day to day.

Contrast this favourable condition of things with what takes place when only narrow strips of comb-foundation are furnished. It will take under the same conditions a similar swarm from four to five weeks to fill the hive with comb, and then there will be a large proportion drone-comb, which is the very thing to guard against. Consider what the difference in time alone will make in the profitable working of a hive, especially in a short season. Then, again, with regard to the difference in the initial expense between using full sheets and strips, which seems to influence many beekeepers in favour of the latter system: Even in that there is a gain in favour of the method I am advocating. For instance, the cost of filling the ten frames with sheets of best comb-foundation would be (including the expenses of getting them) about 4s., and with strips—say, two sheets—10d.: an apparent saving in the first instance of 3s. 2d. We must then consider the matter from another point of view.

The consensus of opinion among the most experienced beekeepers is that there is an expenditure of about 12 lb. of honey in making 1 lb. of wax—that is, the bees consume that quantity of honey before secreting 1 lb. of wax. The ten sheets of comb-foundation weigh  $1\frac{1}{2}$  lb. and cost 4s. For this there would have to be an expenditure of 18 lb. of honey, which, at the average wholesale price of 4d. per lb., is 6s., so that there is a saving of 2s. in favour of the full sheets, to say nothing about all the other advantages gained.

This shows clearly enough the advantage of making the fullest use possible of comb-foundation.

## II. THE RIPENING AND MATURING OF HONEY.

---

All honey should be thoroughly ripened and matured before being placed upon the market; otherwise it will rapidly deteriorate, to the injury of the producer and the industry generally. All beekeepers are fully aware of and admit this; nevertheless, occasionally unripe honey finds its way to the markets, eventually to be condemned through fermentation. In the absence, however, of any reliable method for deciding when honey is ripe, beekeepers are not wholly blamable for being mistaken on this point.

### AMOUNT OF MOISTURE IN HONEY.

Nectar or honey when first gathered contains a variable quantity of water, usually ranging from 18 to 23 per cent., according to the weather. Mr. Otto Hehner, F.I.C., F.C.S., public analyst, and analyst to the British Beekeepers' Association, in a lecture before that body some years ago stated, "Essentially, honey consists of water and of sugar. Of the water I need say but little except that I have found it to vary in quantity from 12 to 23 per cent., the normal proportion being from 18 to 21 per cent. When the percentage falls below 18 the honey is generally very hard and solid; when it is higher than 21 it is frequently quite or almost clear."

In Thorpe's "Dictionary of Applied Chemistry," page 286, the maximum, minimum, and average amount of moisture in twenty-five samples of honey examined are given as follows: Maximum, 23.26 per cent.; minimum, 12.43 per cent.; and the average of the twenty-five, 19.3 per cent.

Honey containing an excess of moisture is unripe and bound sooner or later to ferment, but when such moisture is reduced below a certain percentage the honey is said to be ripe, and it will in that condition keep good for any length of time. There is in the Agricultural Museum at Wellington a sample over sixteen years old, in splendid condition. At what point the "excess" of moisture commences we have no definite knowledge. The different works available contain no guidance on the question.

It is extraordinary that, considering the importance of the subject the ripening and maturing of honey has never been discussed in bee literature—at any rate, in the best that has appeared for over thirty years. We have had volumes of vague statements and assertions by correspondents in the various bee journals, but nothing of value.

### TESTING HONEY FOR RIPENESS.

My former experience as a honey-merchant brought me into contact with all sorts and conditions of beekeepers, and all sorts and conditions of honey—in its qualities of ripeness and unripeness. I then realised the need there was that beekeepers should have some simple but reliable method of testing honey for its ripeness before putting it up for the market. It was frequently very difficult to decide whether honey was ripe or not while it was in liquid form; and to-day the same difficulty obtains, demanding every effort to remove it.

It is beyond the accomplishment of the average beekeeper to determine the exact amount of moisture a given sample of honey contains, neither is it necessary, as we shall be able to arrive in time at the knowledge we require by very simple means—that is, through the density or specific gravity of the article. A very great number of tests must be carried out before anything approaching a reliable standard of the specific gravity for ripe honey of different varieties can be established.

### SPECIFIC GRAVITY OF HONEY.

Previous to carrying out, recently, a series of tests of a number of samples of honey (which I shall explain directly) I consulted several works in hope of getting some assistance from them, but was disappointed. The *British Bee Journal* for December, 1885, contained the only item on this matter in all my bee literature. The then editor, in reply to a correspondent, gave figures from different works representing the specific gravity of honey, ranging from 1·261 to 1·450, and then suggested taking the mean of these figures—viz., 1·355—“as a conventional standard for ripe honey,” admitting, at the same time, that “clover honey in a dry season is found to be 1·370.” This was a very haphazard way of deciding so important a question. Thorpe’s work, already referred to, gives, on page 287, a range from 1·439 to 1·448 as the specific gravity of honey; another equally well-known work gives from 1·425 to 1·429 for “virgin honey”—whatever that may be—and from 1·415 to 1·422 for “honey from old bees”(?) ; and the “*Encyclopædia Britannica*” gives 1·410. The foregoing figures, instead of affording any assistance, are, on the contrary, rather misleading with regard to the actual density of ripe honey.

### TESTS MADE.

Some little time since I purchased from grocers in the ordinary way twenty tins of different varieties and grades of honey, and tested them very carefully for their specific gravity with a Twaddell’s and a Fletcher’s hydrometer. Before testing, the condition of each sample was noted, in order to compare the specific gravity with its appearance. Eleven



samples ranged from 1·400 to 1·430, with an average of nearly 1·413, while the remaining nine ranged from 1·350 to 1·390. Those above 1·410 were very firm and dry before testing, and the whole twenty samples were granulated. Those from 1·400 to 1·410 appeared to be well ripened, but were not so firm as the others; there was a marked difference in those below 1·400, which were soft and moist. My opinion is that the first-mentioned were thoroughly ripe and would keep any length of time; the second lot, ranging from 1·400 to 1·410, were, as I said, well ripened and fit for the market; while all the samples registering below 1·400 were very doubtful regarding their keeping-qualities—one at 1·385 had already begun to ferment. These figures will be valuable for comparison with those of future tests. I am keeping a portion of each sample sealed to test by time. It was very noticeable that the better the honey the higher was its specific gravity.

In addition to these tests Mr. Robert Gibb, of Tukurau, Southland, honorary secretary of the Southland Beekeepers' Association, at my request collected samples of honey from different parts of Southland, and made seven tests, of which I have full particulars. Six of the samples ranged from 1·420 to 1·450 in their specific gravity by Twaddel's hydrometer, and are described generally as "clover honey, granulated very hard, fine grain and flavour, thoroughly ripened." The seventh sample is described as of "poor quality compared with the others, and doubtful as to its keeping-qualities, granulated, but soft; specific gravity, 1·402."

I have no doubt that we shall find that honey from the same district and apiary varies considerably in its specific gravity according to the season, just as it does in quality.

#### METHOD OF TESTING.

Each sample was liquefied by slow heat in a closed vessel (to prevent the moisture evaporating) placed in a water bath. It was then reduced to a temperature of about 60° Fahr., poured into a test-glass and the hydrometer inserted (see Fig. 2). The hydrometer will gradually sink until it finally registers the specific gravity. In the case of honey being too dense to be treated in this manner weigh up, say, 8 oz. of honey, then add the same weight of warm water, and thoroughly mix; when reduced to 60° Fahr. it will be ready for testing. Supposing, for instance, the hydrometer then gives 1·190, by adding 190 it will give 1·380, which will be the specific gravity of the honey.

The cost of the appliances is a mere nothing compared with the importance of making tests, as every beekeeper should assist in arriving at a reliable standard for ripe honey. A Twaddel's hydrometer (Fig. 1), or two instruments with a range from 1·350 to 1·400 in one and 1·400 to 1·450 in the other, with a suitable test-glass and thermometer, cost about 7s. 6d. or 8s.

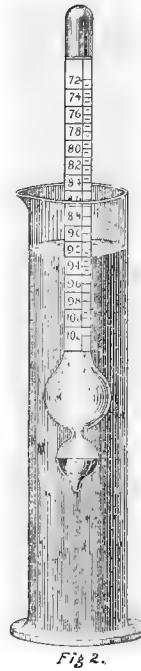
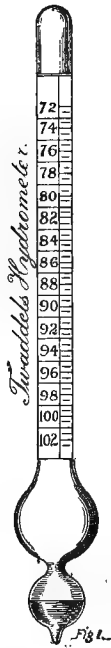

The instrument is made with various scales, according to the density of the liquid to test which it is required.

Each degree is equal to 5 degrees specific gravity ; for example, 80 degrees Twaddell is equal to 1.400 sp. g. as  $80 \times 5 = 400 + 1000 = 1.400$  sp. g.

### TESTING STRENGTH OF LIQUID FOR MAKING HONEY VINEGAR.

The washings of cappings (when there are any), the skimmings and washings of the tanks, honey-extractors, &c., broken honey-combs, and other odds and ends of honey need not be wasted ; all can be utilised in the making of vinegar or mead, or both. A hydrometer comes in very useful here again to test the strength of the liquid. For vinegar there should not be more than  $1\frac{1}{4}$  lb. of honey to each gallon of water, the specific gravity of which is 1.040, so that when the honey cannot be weighed the hydrometer will at once show whether the strength is right, instead of depending on guesswork.

### RIPENING HONEY INSIDE AND OUTSIDE THE HIVE.

This subject has caused no end of controversy in the bee journals, but chiefly by those bitterly opposed to any other method of ripening honey

than within the hive. Although I have closely followed most of the writers on this side of the question, I have failed entirely to discover anything beyond mere assertions that their method is the right one, and all others wrong. No proof by tests or experience of both methods has been adduced to support their assertions, so that to a close observer they have been valueless. On the other hand, we have the experience and testimony of some very eminent beekeepers who have practised with great success and advantage the ripening of honey outside the hive.

#### RIPENING INSIDE THE HIVE.

This can readily be done, and is, no doubt, the best plan for those who are not prepared to exercise great care—that is, who are somewhat careless. All that is needed is to leave the honey in the hive until all the cells are sealed or capped over before removing the comb for extracting. The capping of the honey-cells denotes that the contents are ripe—that is, that the surplus moisture has been evaporated, which in my opinion is all that takes place. The time required for this depends in a great measure on the state of the weather and the condition of the honey when stored; it may be several days before the honey is capped, or in dry warm weather only a few hours after the cells are filled. Even honey that is ripened in the hive should remain in a shallow tank after extracting, to mature before tinning it—but more of this later.

#### RIPENING OUTSIDE THE HIVE.

If there were no disadvantages in the foregoing process, or no other method of reaching the same end without disadvantages attached to it, we should, as a matter of course, have to follow it; but I maintain we can ripen our honey equally as well outside as within the hive, and by so doing effect an enormous saving of time, labour, and material, and secure a larger crop of honey. Nothing has yet been brought forward to refute the theory that the ripening of honey, as previously stated, is simply a mechanical process—evaporating the surplus moisture by means of heat, whether inside or outside the hive.

In the season of 1883–84, after much thought, I determined to give the process a trial, and had shallow tanks made, such as I recommend now. The crop was ten tons of clover honey, none of which was more than partially capped on the upper parts of the combs, and plenty was not capped at all when extracted. It was duly ripened and matured in my tanks, and finer honey I never had. It was sent to England and all over the colony, and gave no cause for complaint. I followed the same process with the same success all the time I was raising honey, including that raised at the Exhibition Apiary, 1907.

It gave me much pleasure some seven months after the publication of the first edition of this bulletin, wherein I had suggested the adoption

of this process, to find that the well-known E. W. Alexander, one of the most extensive and experienced beekeepers in the world, was working on the same method. His articles on the subject in *Gleanings*, early in 1906, created quite a sensation among beekeepers in America, some of whom rather fiercely criticized him and his method, and in reply he wrote, "But I do say that the man who has had experience, and has the necessary storage-tanks, can ripen his honey after the bees commence to cap it so that it will be just as good as if left with the bees all summer. In this way we not only get twice the amount, but we save our bees much labour and waste of honey in capping it over, and ourselves at least half the work in extracting." I may add that by ripening honey outside the hive swarming can be better kept under control.

During a heavy flow of honey when it is left in the hive to ripen it is necessary to keep adding top boxes to take advantage of the flow, as the honey will be stored faster than it can be ripened. This means the providing of a large quantity of extra material and combs, at considerable cost. Each top box would be worth at least 2s. 6d., and the nine frames of comb at 1s. 3d. each, 11s. 3d., making a total of 13s. 9d.; and two of these extra boxes may sometimes be needed for each hive if full advantage is to be taken of the conditions mentioned.

#### RIPENING AND MATURING TANKS.

The most effective method of ripening and maturing honey is to expose a large surface of comparatively shallow mass to a warm, dry atmosphere. Many of the "tanks" in use at the present time consist of cylinders similar to those of a honey-extractor, about 18 in. or 20 in. in diameter, by 36 in. deep. These, besides being small, are wrong in principle—they are too deep, and the surface is too small. Even when the honey is allowed to ripen within the hive it is necessary to have shallow tanks to mature or clarify it, for, no matter how small in the mesh the strainer may be or how carefully the honey is strained, it is impossible to prevent very fine particles of wax and pollen-grains running from the extractor into the tank with the honey. If the body of the honey is deep these particles cannot rise to the surface as they do in a shallow tank, forming a scum, which, when skimmed off, leaves the honey in the very best form for market. Air-bubbles, which in themselves may contain moisture (and it is absolutely certain that honey containing air-bubbles quickly deteriorates), cannot rise or escape through a deep mass of honey.

With regard to the scum just mentioned, it is by no means uncommon to find an unpleasant-looking film, or layer, anywhere between  $\frac{1}{8}$  in. and  $\frac{1}{4}$  in. deep on the top of honey in tins sent into the market. This is the result of tinning it before it has been matured and skimmed,

probably in most cases through not having a suitable tank for the purpose. Honey, like other commodities, must be put upon the market in its most attractive form if we wish to encourage the demand for it.

### SIZE OF HONEY-TANKS.

I prefer tanks not deeper than 20 in., and they should not, even when working on a large scale, exceed 24 in., but with regard to superficial area the only limit need be the convenience or requirements of the user. Mr. E. W. Alexander (whom it is a pleasure to quote) is using deeper tanks, but he finds them too deep, and recommends shallower ones.

For an apiary of, say, two hundred colonies, two such tanks as the double tank illustrated would in most cases answer the purpose. There is a great advantage in dividing the tanks into compartments, so that the honey from each day's extracting may be left undisturbed until it has matured and is ready to run into tins. It is unwise to run two or three days' extracting into the same tank, as the frequent disturbance is against the honey maturing properly.

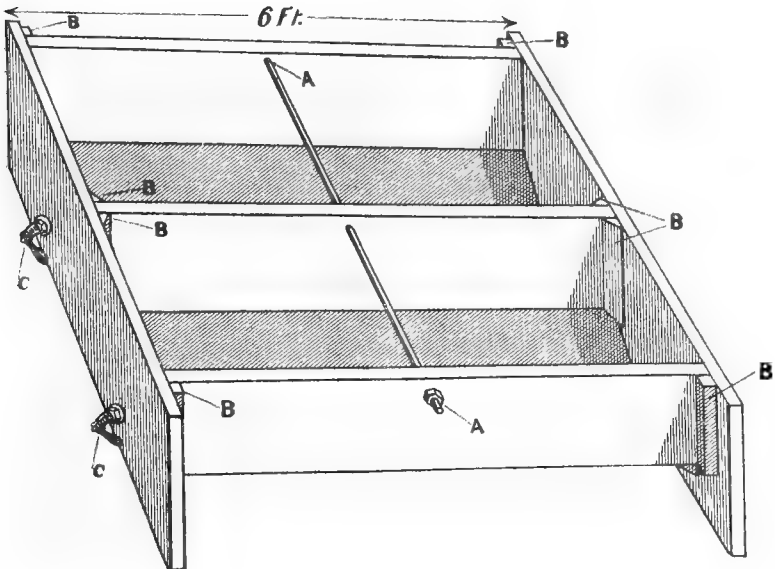

FIG. 1. DOUBLE HONEY-RIPENING TANK.

(Not drawn to scale.)

Fig. 1 represents a honey-ripening tank, 6 ft. long, 4 ft. wide, and 20 in. deep, outside measurements, capable of holding about 1,250 lb. of honey in each compartment. It should be made of  $1\frac{1}{4}$  in. timber, and lined with good stout tin.

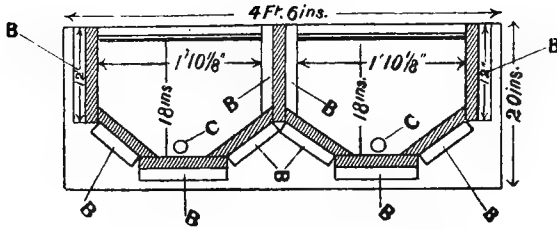

FIG. 2. SECTIONAL VIEW OF SAME.

In Figs. 1 and 2 the letters refer to the same parts. A, A, iron strengthening-rod, with screw-nut; B, B, battens  $2\frac{1}{2}$  in. wide by 1 in. thick, against which the beards of the tank are nailed; C, C, honey cut-off taps.

The illustrations, so far as the measurements are concerned, represent the tanks in use at the Government experimental apiaries, and, in whatever size may be considered desirable, something near the same proportions are advisable, and at most not more than 24 in. deep.

#### E. W. ALEXANDER'S HONEY-TANK.

The following illustration represents one of Mr. Alexander's honey-tanks, which is portable, and holds something near 5,000 lb., but, as I said before, he considers its depth too great.

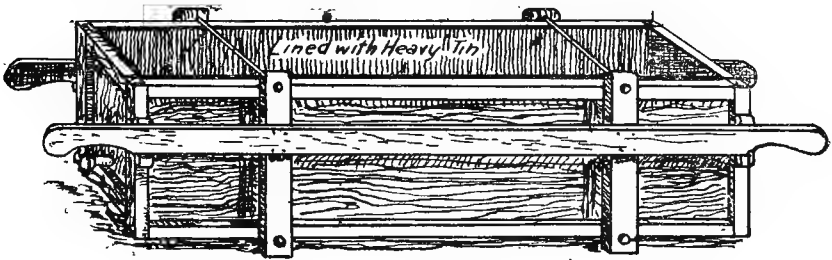

ALEXANDER'S STORAGE AND EVAPORATING TANK.

#### HEATING THE EXTRACTING-HOUSE AT NIGHT.

It has been suggested by experienced beekeepers that as the temperature frequently falls very low at night during the extracting season, causing the honey to partially crystallize prematurely in the tank, it would be advisable to adopt some means of keeping up the temperature on such occasions by artificial heat until the honey is matured, a suggestion I agree with. One of the modern oil-stoves would answer the purpose well, providing it does not cause a smell that would taint the honey, and the cost of heating would be very small.

## REMARKS.

The object of the foregoing chapter is to bring about a condition of things generally whereby we shall have a reliable system for preparing and placing on the market our honey in its best form, in place of the haphazard imperfect manner in vogue among many beekeepers at the present time. Our most careful apiarists give this matter their greatest attention, but every beekeeper should adopt a proper system, and so bring credit to himself and to the industry.

With regard to the remarks on ripening honey outside the hive, no doubt some beekeepers will differ from them; but they should remember that what I have said is based not upon theory, but upon actual practical experience. It remains, however, for each individual beekeeper to please himself as to whether he will ripen his honey outside or inside the hive; but the question is of such vast economical importance in the matter of profit and loss that it will be well for all to give both systems a trial and decide for themselves.

---

### III. DEALING WITH THICK HONEY.

---

One of the few serious drawbacks beekeepers in certain districts have to contend with occasionally is thick honey—that is, honey that is too dense to extract from the combs in the ordinary way. I say “occasionally,” because fortunately it is not met with every season, except, it may be, in apiaries situated near heavy bush, or where little else than flax or tea-tree abounds, in which case it would be folly to attempt to raise extracted honey.

Now and again beekeepers in the Waikato districts suffer considerable loss, and are put to extra trouble through the storage of thick honey, although in the midst of clover country. The same occurs in a few other districts in the colony. There are some parts—notably, nearly the whole of the country north of Auckland—where the honey is continuously of so dense a nature that the honey-extractor is of no use whatever. Such country is not suitable for bee-farming, as only comb-honey can be raised there, and the demand for this is limited, while it is too fragile to be sent to distant markets with profit.

## FLORA FROM WHICH THICK HONEY IS GATHERED.

It is still an open question with many of the Waikato beekeepers, as to the particular flora from which the thick honey is gathered, but I am inclined to the opinion of one of the oldest and most experienced apiarists in the district—Mr. Joseph Karl—that it is gathered from tea-tree blossoms. There are two varieties of this plant—one known as “red” tea-tree, from the colour of the wood, and the other “white.” They frequently grow together, and the blossoms are much alike in appearance, but a difference can be distinguished on close inspection. I have seen the hive-bee working on the “red” variety, but never on the white—the little native bee works on the latter. In warm, dryish seasons—what may be termed good clover seasons—there is no trouble with thick honey, but in wet, unfavourable seasons, like that of 1906–7 in the Waikato, the difficulty is very serious, owing, no doubt, to the clover yielding very little honey and the bees being forced to the tea-tree or other forage. Waikato beekeepers may console themselves with the fact that the tea-tree scrub is rapidly disappearing from the country, and clover pastures taking its place.

## MAKING THE BEST OF THE DIFFICULTY.

For the benefit of the many beekeepers who meet with the same drawback, I will describe the practice followed by Mr. G. S. Pearson, of Hamilton, Waikato, president of the Waikato Beekeepers' Association, which is that generally followed in the district.

The storing of thick honey commences early in the season, but ceases as soon as the weather is favourable for gathering clover honey. Should this latter condition not come about, the first continues and gives trouble. Should there be a comparatively small quantity of thick honey stored, but more than is needed for immediate use as food, the combs when sealed are removed and stored away for the bees' future use, every particle of extractable honey is taken from the hives to the end of the season, and the thick honey returned for winter stores. Should, however, there be more of the latter than can be utilised in this way, as there frequently is, it is put through the honey-press.

## HONEY PRESS.

(See Plate VI.)

Mr. Pearson's press is similar to those in general use in the Waikato. It is, as can be seen, an ordinary single cheese-press of the latest design, with screw and compound lever, fitted up for the purpose required.

The “receiver,” into which the honey runs as the combs are pressed (shown at bottom of Fig. 2), is 20½ in. square and 6 in. deep, outside



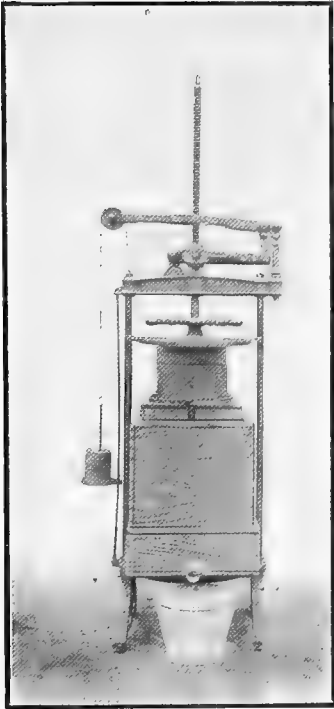

1 In Operation.

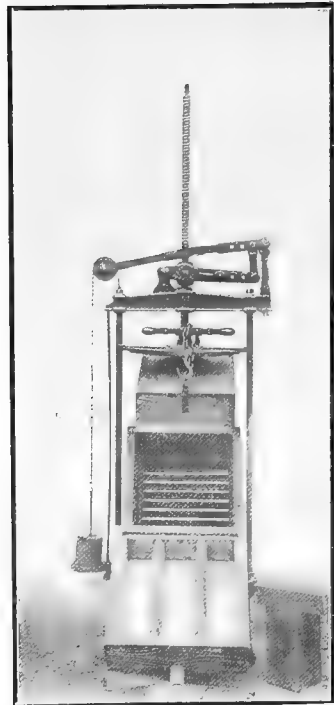

2. Dismantled, showing Parts.

PLATE VI. CHEESE-PRESS CONVERTED INTO HONEY-PRESS.

*Bee-culture.*]



measurement, formed of 6 in. by 2 in. boards. Two 6 in. by 2 in. bearers are nailed across the inside, as shown, at equal distances from the sides, and are chamfered on tops. They are to help bear the weight of the body when under pressure. A  $1\frac{1}{2}$  in. batten is nailed around the top edge to act as a stop, inside of which the lower edge of the body fits when in place. The bottom should be of 1 in. or  $1\frac{1}{4}$  in. timber, and should be leakage-proof, and the honey should be free to run from each compartment to the spout.

The "body" (shown in centre of Fig. 2) is 18 in. square and  $15\frac{1}{2}$  in. deep, outside measurement. Battens 3 in. by  $\frac{3}{4}$  in., chamfered on upper edge, are nailed on edge across the bottom 1 in. apart, and in the opposite direction or at right angles to the bearers in the receiver. Fillets  $\frac{5}{8}$  in. square are nailed vertically  $\frac{3}{4}$  in. apart all round the inside, and over these and the battens on bottom galvanised wire netting of  $\frac{1}{2}$  in. mesh is fastened, and small fillets are nailed over raw edges at the joints and around the top edge.

The "follower" (shown in upper part of Fig. 2, just under the screw) is a large box 6 in. deep, a trifle smaller than the inside dimensions of the body in the square. The top and bottom should each be in one piece, and before nailing on the top a bearer the full depth should be nailed across the centre. The whole of the follower is made of sound 1 in. timber. A chain with hook and strap is attached to each side for the purpose of drawing it out of the body after use, and the body should be secured from below to keep it in place when lifting the follower. The two blocks on the ground in Fig. 2 are 6 in. square and 12 in. long in one case, and 6 in. by 3 in. and 12 in. long in the other. These are shown in place on top of follower in Fig. 1.

Pressing: Before the combs to be pressed are put into the body, sufficient cheese-cloth is placed in the latter to hold the combs and lap over the top under the follower. The latter is then placed in position, and the screw brought into play. As the screwing proceeds the arm of the compound lever rises, and when full pressure is on it can be left, as the lever then acts and retains the pressure till the arm falls to its lowest point.

Mr. Pearson states that one man pressed out 75 lb. honey in an hour and a half. He also remarked that, if fitting up another press, he would make the receiver 4 in. deep instead of 6 in., and the body 13 in. instead of  $15\frac{1}{2}$  in. deep.

The press without the fittings cost, when new, about £5, but a second-hand one in good order may often be got for much less.

Pressed honey is not nearly so good as that extracted in the ordinary way. It is not of so high a grade in the first place, and the flavour is not improved by pressing. Honey to be pressed should be thoroughly ripe before removal from the hive—that is, all capped over, as it is so dense that there would be little chance of getting rid of any surplus moisture afterwards.

## IV. DISEASES OF BEES AND THEIR TREATMENT.

---

The hive-bee (*Apis mellifica*), like all other animals, especially those under domestication, is subject to several diseases, some fortunately of minor importance. The most injurious are those which attack and destroy the brood, thus preventing the normal development of young bees, and of which, when allowed to run their course, the inevitable result is the rapid decline and ultimate extermination of the colonies affected.

### FOUL-BROOD.

The most pernicious of bee-diseases is what we know as "foul-brood" (*Bacillus alvei*), a germ disease of a very infectious nature, and only too familiar to the majority of beekeepers. It is, without doubt, the greatest drawback to successful bee-culture known at the present time, and seems to be prevalent in all countries where bee-culture is followed.

### HISTORICAL.

Without delving into the history of foul-brood deeply, it may be mentioned that Aristotle mentions some bee-disorders in his works on husbandry, and it is quite likely that he was familiar with this disease. Schirach seems to have known it well, for in his "History of Bees" (1769) he gave it the name of "foul-brood" ("Bacteria of the Apiary"). It has occupied the attention of a number of investigators at different times, with the view of discovering its cause and cure, but hitherto with comparatively small results, though some headway has been made of late in checking and curing it by careful treatment. It is quite possible that the disease was not so troublesome in former times as now, as the facilities for its spreading were few compared with what they have been during the last thirty years. The trade in bees and queens that has accompanied the expansion of modern bee-culture, and their consequent transportation from district to district, and from country to country, is accountable, no doubt, for the universal extent of its ravages at the present time. When or where it first made its appearance in New Zealand is not known so far as I am aware, but I do know that foul-brood was very prevalent in some districts—notably in Taranaki, Hawke's Bay, and Poverty Bay—before 1880.



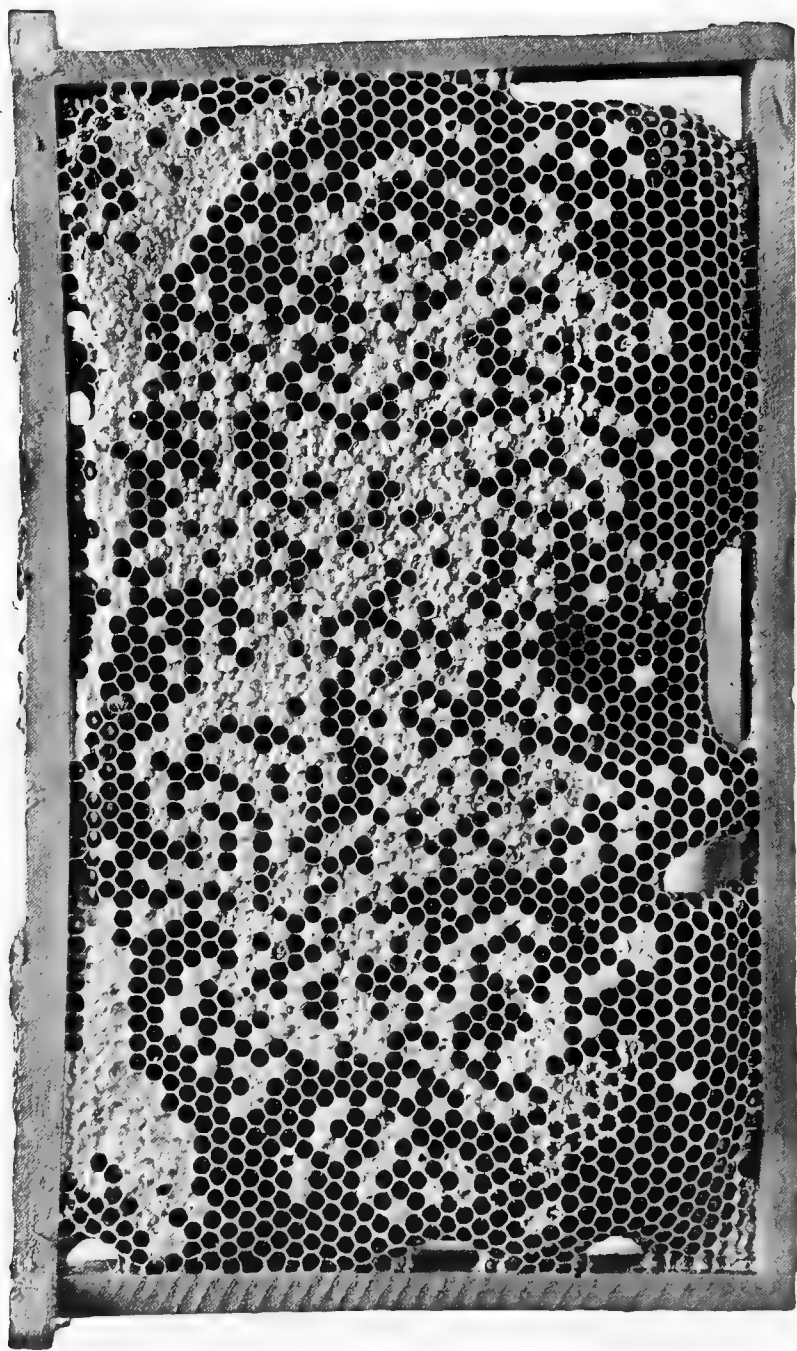

PLATE III. COMB INFECTED WITH "FOUL BROOD" (*Bacillus alvei*) IN AN ADVANCED STAGE.  
(ORIGINAL.)

*Bee-culture.*]

[Photo. by E. Walrand.]



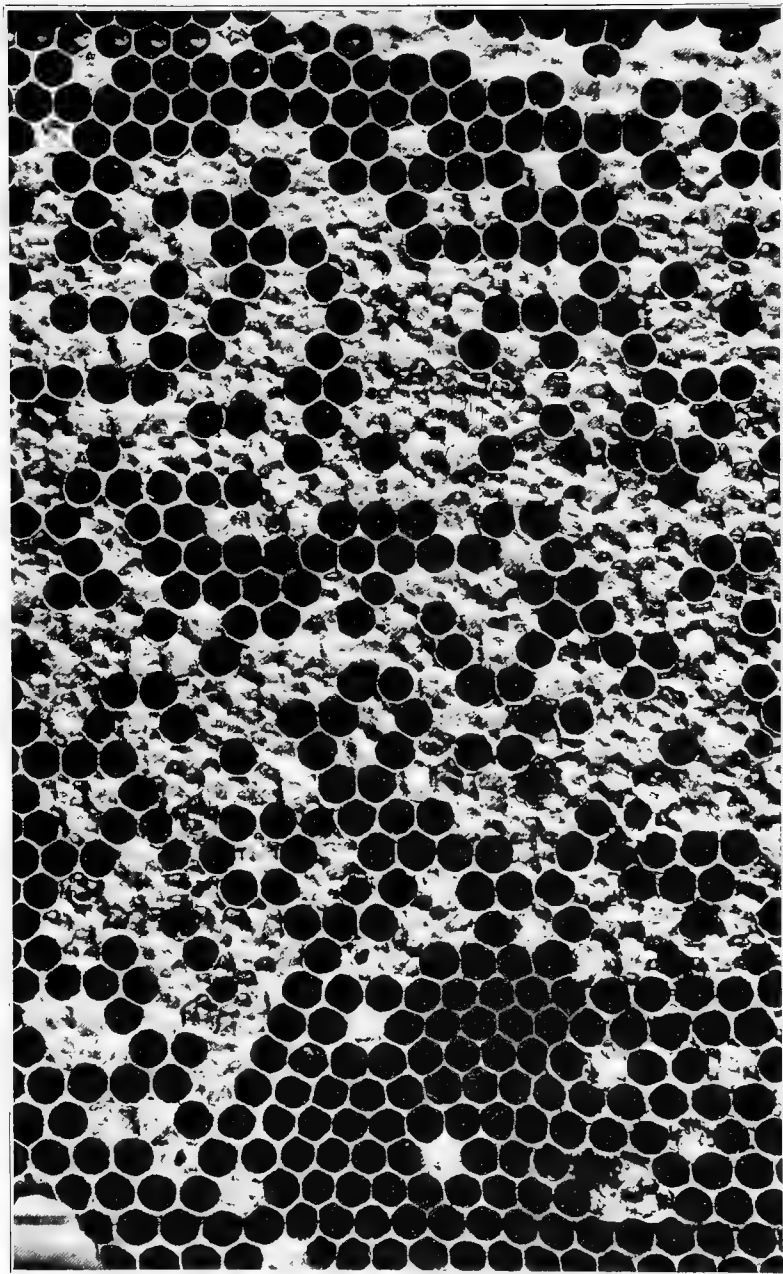

PLATE IV A PORTION OF THE DISEASED COMB SHOWN IN PLATE III, ENLARGED TO NATURAL SIZE.  
*Bee-culture.*]



## CURRENT INVESTIGATIONS.

The Department of Agriculture of the United States of America is taking the lead and carrying out a great work just now in the investigation of bee-diseases. At the latter part of 1906 the Department issued a pamphlet of some forty-five pages, entitled "The Bacteria of the Apiary," in which some startling announcements were made, quite upsetting the results of many previous investigations. The statements were challenged by some able men, and this has put the American authorities on their mettle, with the good result that they are now prosecuting their investigations more thoroughly than ever, and, whatever may be the outcome of them, the beekeeping world must benefit more or less.

## STATE LEGISLATION.

The economic value of the beekeeping industry is being generally recognised in all countries, and the knowledge of the losses sustained through the disease has caused an energetic movement in the direction of stamping it out if possible, or, at all events, to bring it more under control. The good resulting from the action of the Canadian Government in this respect has given a great impetus to legislation on the same lines in other countries. The necessity for forcing careless beekeepers to either stamp out the disease from their apiaries or give up beekeeping is now recognised everywhere, including New Zealand, where foul-brood in the past has caused incalculable loss from one end of the colony to the other.

## SYMPTOMS OF FOUL-BROOD.

As the treatment is the same in either case, we need not feel concerned as to any distinction of germs, or whether we have in New Zealand the European or the American foul-brood. Experienced beekeepers know our own disease when they see it, and that is sufficient at present. The following description of the symptoms is given for the benefit of beginners :—

Healthy brood in the larva stage—that is, before it is sealed or capped—presents a clear pearly whiteness, but when attacked by foul-brood it rapidly changes to light buff, then to brown, coffee-and-milk colour, and finally to black, at which stage nothing is to be seen in the cell but a flattish scale-like substance when examined closely. It is, however, when the brood has been attacked after it has advanced to the pupa period of its existence—that is, when it has been capped over—that the novice is better able to detect the presence of foul-brood.

In the early stage of an attack a capped cell here and there will appear somewhat different from the surrounding healthy brood. Instead of the cappings or seals being bright, full, and of convex form, characteristic of healthy brood, they will be of a dull blackish-brown colour, and flat or sunken (see Plate II), an indication that the cells contain dead pupæ. The disease rapidly spreads to surrounding cells and combs, if allowed to take its course, till finally no brood can hatch, and the colony succumbs. On opening some of the cells a thin glue-like coffee-coloured mass will be

noticed, which on the insertion of a splinter of wood will adhere to the point, and can be drawn rope-like for some little distance out of the cells. This is one of the most distinctive features of foul-brood, and where present is generally considered conclusive of the disease. Later on this glue-like substance dries up into the before-mentioned black scale-like body.

Other symptoms are "pin-holes" and ragged perforations in the cappings of the cells, clearly shown in Plates III and IV, and a very disagreeable smell resembling that of heated glue or tainted meat, which can be sometimes detected at some yards away from a badly infected hive, especially in close weather. The characteristic odour cannot easily be detected in the earliest stages, even when an infected comb is placed close to the nose, but some slight difference can be noticed between that and healthy comb at all times.

#### TREATMENT OF FOUL-BROOD.

Treatment by drugs, so prominent at one time, has all but universally been abandoned as useless. Mr. S. Simmins, a well-known English bee-keeper and the author of "A Modern Bee-farm," still swears by the Izal treatment, but after giving it a thorough trial at the Ruakura Apiary in the season of 1906-7, my assistants reported that it utterly failed to cure, but, like other well-known drugs, it seemed to check it a little. Except for disinfecting hives and appliances, I do not recommend the use of drugs in the apiary.

#### THE STARVATION CURE.

The so-called "starvation" method for treatment of foul-brood or brood-diseases is now recognised as the most effective, and has been universally adopted by leading beekeepers. Where the disease is so far advanced as to have left few bees in the colony, then it will be safest to destroy everything that has been in contact with it by fire: "tinkering" with such a colony would be both useless and dangerous.

Treatment may be successfully undertaken at any time when honey is being freely stored. When going through the hives in spring make a note of those showing signs of diseased combs (which are readily detected at that time), for treatment later on, and be very careful that robbing is not started. When the honey season has set in, keeping the bees busy, treatment should begin. All operations in this connection should be carried out in the evening, when the bees are quiet.

Prepare a clean hive and bottom board with narrow starters of comb-foundation in the frames. Remove the infected hive and stand to one side, and put the prepared one in its place, prop up the front about an inch, lay a sack near the entrance, and shake and brush the bees as quietly as possible close to the entrance, and when finished remove every vestige of the infected hive away where bees cannot get at it. The combs, if not too badly infected, may be melted into wax, or, if insufficient in quantity for that purpose, they, with their frames, had better be burned right away and the ashes buried. The hive, bottom board, and cover,

if sound and worth saving, should be cleaned and thoroughly disinfected with a strong solution of carbolic acid or izal.

On the evening of the fourth day following, the necessary number of frames for the hive should be furnished with full sheets of comb-foundation, to be exchanged with those the bees have been working on. This can be done by removing the frames one at a time, shaking the bees back into the hive, and inserting the others. The comb built on the starters during the four days may be cut out and melted up, and the frames disinfected.

The theory of this treatment is that during their four days' comb-building the bees use up all the infected honey contained in their honey-sacs when taken from their old hive, so that when shifted again at the end of the four days they start clean.

#### AFTER-INSPECTION.

In from three to four weeks, when the new brood begins to emerge, keep a look-out for any suspicious-looking brood-cells, and if any are seen cut them out at once, together with the adjoining cells. "Eternal vigilance" should be the watchword of every beekeeper who hopes to keep down disease.

#### TO PREVENT SWARMING OUT.

On rare occasions colonies swarm out during treatment, but this is not likely to occur when honey is being gathered freely. It can be guarded against by caging the queen for a few days, or by giving a wide entrance and placing queen-excluding zinc across.

#### SAVING HEALTHY BROOD.

When several colonies are to be treated and there is a large quantity of healthy brood in the combs, put a queen-excluding zinc honey-board over the frames of one of the least-affected hives, and put all the healthy brood above this to emerge. When this has been accomplished remove everything and treat the colony in the manner advised. The zinc prevents the queen making use of the affected combs while the brood is emerging.

#### AUTUMN TREATMENT.

When it is desired to treat colonies in the autumn *after brood-rearing has ceased*, just put the bees into clean hives provided with ample winter stores in the shape of frames of honey from clean colonies. The disease is not likely to reappear.

#### FEEDING AND DISINFECTING.

In all cases when treatment is going on and honey is not being stored freely, feed sugar-syrup liberally after shifting the bees on the fourth day. Mix half a pint of water with each pound of sugar used, stir well, and bring it to the boil; when cool it is ready. Always feed within the hive and in the evening.

Be sure to remove out of the way of the bees, and disinfect or burn, everything used during the operations of treatment; and a solution of izal should be kept for disinfecting the hands, knives, &c., after handling an infected colony. Directions are given on the bottles, and the solution will not harm the skin.

#### YOUNG QUEENS.

There can be little doubt that bees from young vigorous queens can better cope with disease than those bred from aged and weak mothers. It is therefore advisable to change the queens at the time of or shortly after treatment if those in the affected hives are not up to the mark; in any case it is profitable to do so if young queens can be obtained.

#### SUMMARY.

The following interesting items bearing upon foul-brood are taken from the "Summary" of the author of "The Bacteria of the Apiary":—

1. There are a number of diseased conditions which affect the apiary.
2. The disease which seems to cause the most rapid loss to the apiarist is European\*(?) foul-brood, in which is found *Bacillus alvei*—first isolated, studied, and named by Cheshire and Cheyne in 1885.
3. The distribution of *Bacillus alvei* in the affected hive is as follows:—
  - (a.) The greatest number of infecting germs are found in the bodies of dead larvæ.
  - (b.) The pollen stored in the cells of the foul-brood combs contains many of these infecting organisms.
  - (c.) The honey stored in brood-combs infected with this disease has been found to contain a few bacilli of this species.
  - (d.) The surface of combs, frames, and hives may be contaminated.
  - (e.) The wings, head, legs, thorax, abdomen, and intestinal contents of adult bees were found contaminated with *Bacillus alvei*.
  - (f.) *Bacillus alvei* may appear in cultures made from the ovary of queens from European(?) foul-brood colonies, but the presence of this species suggests contamination from the body of queen while cultures are being made, and has no special significance.

#### OTHER DISEASES.

The following description of symptoms of other diseases than foul-brood is taken partly from "The Bacteria of the Apiary," published in 1906 by the United States Department of Agriculture, and partly from "The Brood Diseases of Bees," by Dr. E. F. Phillips, of the same Department:—

---

\* I have queried this word, because there is a good deal of doubt at present as to the correctness of differentiating the disease common in Europe from that found in America.—I. H.

### PICKLE-BROOD.

“There is a diseased condition of the brood called by beekeepers ‘pickle-brood,’ but practically nothing is known of its cause. It is characterized by a swollen watery appearance of the larvæ, usually accompanied by black colour of the head. The larvæ usually lie on their backs in the cell, and the head points upward. The colour gradually changes from light yellow to brown after the larva dies. There is no ropiness, and the only odour is that of sour decaying matter, not at all like that of American foul-brood. In case the larvæ are capped over, the cappings do not become dark, as in the case of the contagious diseases, but they may be punctured. So far no cause can be given for this disease, and whether or not it is contagious is a disputed point. Usually no treatment is necessary beyond feeding during a dearth of honey, but in very rare cases when the majority of larvæ in a comb are dead from this cause the frame should be removed and a clean comb put in its place to make it unnecessary for the bees to clean out so much dead brood.”

### CHILLED, OVERHEATED, AND STARVED BROOD.

“Many different external factors may cause brood to die. Such dead brood is frequently mistaken, by persons unfamiliar with the brood diseases, for one or the other of them. Careful examination will soon determine whether dead brood is the result of disease or merely some outside change. If brood dies from chilling or some other such cause, it is usually soon carried out by the workers, and the trouble disappears. No treatment is necessary. Brood which dies from external causes often produces a strong odour in the colony, but wholly unlike that of American foul-brood—merely that of decaying matter. The colour of such brood varies, but the characteristic colours of the infectious diseases are usually absent, the ordinary colour of dead brood being more nearly grey.”

### PALSY OR PARALYSIS.

“The disease known to apiarists as palsy or paralysis attacks adult bees. The name is suggestive of the symptoms manifested by the diseased bees. A number of bees affected were received from apiaries in New York State in 1903; bacteriological examinations were made, and several species of bacteria were isolated and some experimental inoculations made, but no conclusions as to the cause of this disorder could be drawn from the results obtained.

“From a study of the normal flora of the bee it was soon found that there were quite a number of species of bacteria present. This fact stimulated a study of the normal flora. . . . From this point the work can be carried on with the hope that if the disease has a bacterium as an etiological factor it may be found.”

## V. THE LARGE BEE OR WAX MOTH (*Galleria mellonella*, Linn).

---

The first intimation of this moth's presence in New Zealand was when Messrs. H. Betts and Son, of Okaiawa, near Mount Egmont, in the early part of 1904, sent me some larvæ or grubs found in their hives, and which were strange to them. I had no difficulty in recognising them as the grubs of the large wax-moth, having seen them previously in boxes of bees imported from Italy. It is quite likely the eggs or grubs of the moth may have reached here from Australia with bees, as it is known that the moth has been plentiful there for more than a quarter of a century.

When going through the Egmont district in March, 1905, I discovered the moths in three different apiaries a considerable distance apart, showing that they were spreading. A beekeeper in the district, who had trouble with the moth when he commenced beekeeping and has since taken great interest in the matter, recently informed me that he had seen it in a good number of apiaries, but that it only causes trouble "in the cases of careless beekeepers, and where bees are kept in old box hives." He remarks, "Personally, I consider they can easily be kept under, but as long as we have careless beekeepers we shall have the large moth in Taranaki."

### WHERE THE GRUBS MAY BE FOUND.

A favourite haunt of the grubs is on the top of the frames under the mat, or where there are two mats they will get in between them. In the daytime they apparently hide from the bees, and at night attack the combs; but when the colony becomes very weak the grubs show no such fear, and attack the combs at all times.

It is the larvæ or grubs of the moth which prove so destructive to the combs, burrowing through them under the protection of strong silken galleries which they spin round themselves, secure from the bees as they advance in their work of destruction. Eventually the combs are completely destroyed, and fall, a mass of web and cocoons, to the bottom of the hive (see Plate V).

### HABITS AND NATURAL HISTORY.

The moth itself, which is usually to be seen during warm summer evenings flitting about the hives, watching for an opportunity to lay its

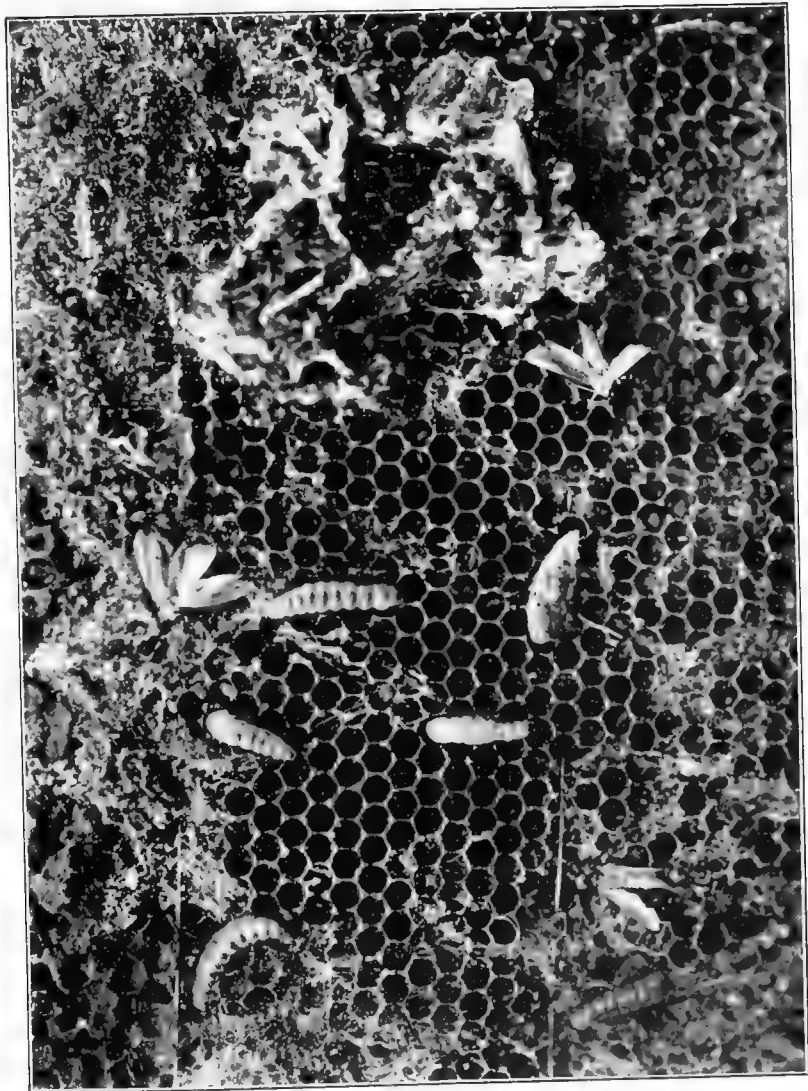

PLATE V. COMB ATTACKED AND NEARLY DESTROYED BY LARGE WAX-MOTH (*Galleria mellonella*).  
(ORIGINAL.)

[Photo. by Mr. Ross.]

*Bee-culture.*]







## FUMIGATING COMBS.

Not only the combs within the hives, but also any which may happen to be unprotected, are liable to be attacked by the moth. No combs or pieces of combs should be allowed to lie about; when they are of no further service they should be melted into wax at once. Spare combs should always be stored in a place of safety from the moth, and inspected frequently. On the first sign of moths or grubs they should be fumigated, and a few days afterwards they should undergo a second fumigation. When there are not many to do they may be suspended in empty hives about 1 in. apart, and the latter piled one on the other, taking care that the junctions of the boxes are made smoke-tight by pasting a strip of paper round them. The top box of the pile should contain no frames. Into this place an old iron saucepan containing live wood-embers, and on to these throw a couple of handfuls of sulphur, close the cover securely, and keep closed for a couple of days. In a large apiary it is best to have a small room fitted up for the purpose. Two or three pounds of sulphur will be sufficient for a large room.

## “ APIARIES ACT, 1907.”

The following is a digest of the Apiaries Act now in force:—

## INTERPRETATION.

2. In this Act, if not inconsistent with the context,—
  - “ Apiary ” means any place where bees are kept:
  - “ Beekeeper ” means any person who keeps bees or allows the same to be kept upon any land occupied by him:
  - “ Disease ” means foul-brood (*Bacillus alvei* and *Bacillus larvæ*), bee-moths (*Galleria mellonella* and *Achræa grizzella*), and any other diseases or pests from time to time declared by the Governor in Council to be diseases within the meaning of this Act:
  - “ Frame hive ” means a hive containing moveable frames in which the combs are built, and which may be readily removed from the hive for examination:
  - “ Inspector ” means any person appointed by the Governor as an Inspector under this Act.

## BEEKEEPER TO GIVE NOTICE OF DISEASE.

3. Every beekeeper in whose apiary any disease appears shall, within seven days after first becoming aware of its presence, send written notice thereof to the Secretary for Agriculture, at Wellington, or to any Inspector of Stock.

## POWERS OF INSPECTORS.

5. Any Inspector may enter upon any premises or buildings for the purpose of examining any bees, hives, or bee appliances, and if the same are found to be infected with disease he shall direct the beekeeper to forthwith take such measures as may be necessary to cure the disease; or, if in the opinion of the Inspector the disease is too fully developed to





Open, showing Frames.

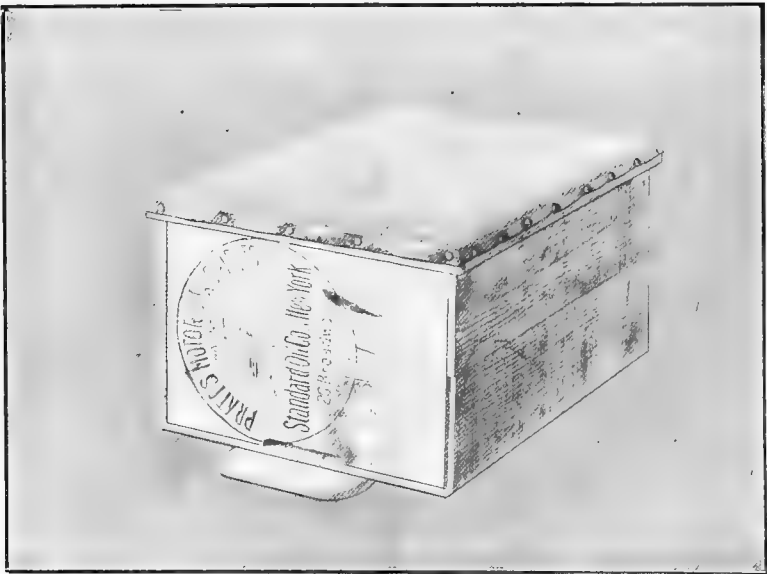

Closed.

PLATE VII.—FRAME HIVE CONSTRUCTED FROM KEROSENE-CASE.  
*Bee-culture.*]

[Face page 23.

be cured, he may direct the beekeeper within a specified time to destroy by fire the bees, hives, and appliances so infected, or such portions thereof as the Inspector deems necessary.

#### REMOVAL OF BEES TO NEW HIVES.

6. In any case in which it is found by an Inspector that the bee-combs in any hive cannot, without cutting, be separately and readily removed from the hive for examination he may direct the beekeeper to transfer the bees to a new frame hive within a specified time.

#### INSPECTOR'S DIRECTIONS TO BE OBEYED.

7. (1.) Every direction by an Inspector shall be in writing under his hand, and shall be either delivered to the beekeeper personally or sent to him by registered letter addressed to him at his last-known place of abode.

(2.) Every such direction shall be faithfully complied with by the beekeeper to whom it is addressed, and, in default of compliance within the time specified, the Inspector may within one month destroy or cause to be destroyed by fire, at the expense of the beekeeper, any bees, hives, and appliances found to be infected with disease.

#### INFECTED BEES, ETC., NOT TO BE KEPT OR SOLD.

8. No beekeeper shall—

- (a.) Keep or allow to be kept upon any land occupied by him any bees, bee-combs, hives, or appliances known by him to be infected by disease without immediately taking the proper steps to cure the disease; or
- (b.) Sell, barter, or give away any bees or appliances from an apiary known by him to be infected by disease.

#### FRAME HIVES TO BE USED.

9. No beekeeper shall, after the expiry of six months from the passing of this Act, keep or knowingly allow to be kept on any land occupied by him any bees except in a properly constructed frame hive.

#### OFFENCES.

10. Every person is liable to a fine not exceeding five pounds who—

- (a.) Obstructs an Inspector in the exercise of his duties under this Act, or refuses to destroy or to permit the destruction of infected bees or appliances;
- (b.) Fails to comply with any direction given under the provisions of this Act by any Inspector;
- (c.) Commits any other breach of this Act.

#### A CHEAP FRAME HIVE.

(See Plate VII.)

Though there may not be much gained in the long run by making any other than good substantial hives in the first place, there may be settlers to whom the question of a shilling or two extra per hive is a consideration. In such cases the following directions for making a cheap frame hive which will comply with the provisions of the Apiaries Act should be of service:—

Secure a complete kerosene case, and carefully knock off one of the broad sides; nail on the original cover, which will now form one of the sides. If the sides of the case are not level all round build them up level with fillets of wood. The inside depth should be 10 in. Next nail on at each end, half an inch below the inside upper edges of the case, to suspend the frames from, a fillet of wood  $\frac{3}{8}$  in. thick by  $\frac{3}{4}$  in. wide, and the length of the inside end of the case.

I would strongly recommend the purchasing of "Hoffman" frames from the manufacturers, as they require to be very accurately made, and are rather difficult to make by hand. If, however, it is desired to construct them make the top bar  $1\frac{5}{8}$  in. wide by  $\frac{3}{4}$  in. deep, and  $18\frac{3}{4}$  in. long. Shoulders should be cut out on ends  $\frac{7}{8}$  in. long, leaving a thickness of  $\frac{1}{4}$  in. to rest on the fillets. The ends should be  $8\frac{1}{2}$  in. long, the same width as the top bar, and  $\frac{3}{8}$  in. thick; bottom bar  $17\frac{1}{2}$  in. long,  $\frac{3}{4}$  in. wide, and  $\frac{1}{4}$  in. thick. There are ten frames, and as they only cost 1s. in the flat and about 10d. postage, or, say, a trifle over 2d. per frame, it may in many cases pay to purchase them.

An entrance  $\frac{3}{8}$  in. wide by 6 in. long should be cut out of the lower part of one end of the case, and a small alighting board be nailed on underneath, projecting from 2 in. to 3 in. in front. (See Plate VI.)

The cover can be made from the side knocked off, and should have small fillets, 1 in. wide, nailed on right round the edge, to overlap the body. Cover the top with ruberoid or other waterproof material, and let it overlap the edges. (See Plate VII.)

With regard to comb-foundation, see Chapter I.

Top or surplus honey boxes can be made in the same way, but will not require a bottom.

When setting them out for the bees the hives can be placed on four half-bricks, one at each corner; or, better, still, sink four beer-bottles neck downwards in the ground, and set the hive on these.

The cost of this outfit, if the settler makes frames and all, will be under 1s., after paying, say, 4d for the box; and if the frames are purchased, under 2s. 6d., and his own labour.

Mr. Stewart, of Crookston, Southland, had over 200 of such hives in use last season (1906-7), from which he secured between 11,000 lb. and 12,000 lb. of first-class honey.

---

## VI. SPRING FEEDING OF BEES.

---

Next in magnitude to the losses of bees which result from inattention to disease are those which occur in the spring months through starvation. Few but experienced beekeepers and those who suffer financially from losses realise how readily the food-supply may become exhausted after breeding is in full swing in spring. In my rounds hitherto I have found it a general complaint that numbers of colonies have died off in the spring. The owners did not know the cause, and when starvation was suggested they were quite surprised, as they "had left plenty of food in the hive the previous season," and it had never occurred to them that the supply might run short.

### THE CAUSE OF STARVATION.

Given a fair supply of stores in late autumn, when fixing the bees up for winter, a colony will use comparatively little during the winter months, but as soon as breeding begins in the latter part of July or early August the stores are largely drawn upon for feeding the brood, and unless nectar can be gathered to help them out, the stores will rapidly diminish. As a rule willows and other spring forage afford a good supply in fine weather, but the weather is frequently far from fine at that time—generally unsettled, and against the bees securing nectar. Take a case, for example, where the bees have come out of winter quarters with a fair supply of food in the hive, the weather fine, and some nectar is being brought in from the fields. Under these conditions, where there is a good queen, breeding will go ahead very rapidly, and in a short time there will be a big lot of brood to feed, and a large quantity of food needed. If at this time bad weather should set in and last for several days, preventing the bees gathering nectar, probably within a week pretty nearly all the reserve stores within the hive will be used up, and if the bees are not seen to before they arrive at this stage they will probably die of starvation. This is not a fancifully drawn case, but a real practical one, and shows just how such large losses occur in spring.

These remarks apply, but in a vastly less degree, to other seasons of the year.

### WHEN AND HOW TO FEED.

Experienced beekeepers can judge in a moment by the weight of the hive, without opening it, whether the supply of food is running short or not, and every beekeeper should learn to do this. By putting one foot on the back of the bottom board to keep it steady, and with one hand raising the back of the hive, one can get the weight at once, and after a little practice can judge to within 1 lb. the amount of honey inside. In this way a large number of hives can be examined in ten or fifteen minutes, and those needing food should be marked.

The safest and best food to give, unless frames of honey from known clean hives are available, is sugar-syrup. Make it as described in Chapter IV, under the heading of "Feeding and Disinfecting." Never purchase honey or accept it as a gift to feed your bees with—it is too risky, and to sterilise it would require two or three hours' boiling, which would be more trouble than the honey would be worth.

### FEEDERS.

There are several kinds of feeders advertised by those who cater for beekeepers. Clean, empty combs make excellent feeders, and they can be filled by placing them on an inclined board in a large milk-dish or other similar vessel, and pouring the syrup through a fine strainer held a foot or so above them. The force of the falling syrup expels the air from the cells, and the syrup takes its place. After filling, the combs should be suspended over a vessel (to catch the drip) before placing them in the hives.

There are "division-board" feeders to hang in the hive like frames, and others to place over the frames, such as the "Miller" and "Simplicity" feeders; also the "Alexander" feeder under the bottom board, either of which will answer the purpose, provided attention is given to replenishing the food when needed. The inexperienced should always feed *within the hive*, and in the evening.

Finally, remember that a little food given in the spring to tide the bees over a spell of bad weather will save them to give you a large return in honey later on, whereas neglect in this respect will result in their loss.





## II. APICULTURE IN RELATION TO AGRICULTURE.\*

---

THE benefits derived by both agriculturists and horticulturists from the labours of the bee are now very generally understood and acknowledged; but still cases sometimes occur, though rarely, of farmers objecting to the vicinity of an apiary, and complaining of bees as "trespassers," instead of welcoming them as benefactors.

### ARE BEES TRESPASSERS?

It is not, perhaps, surprising that at first a man should imagine he was being injured in consequence of bees gathering honey on his land, to be stored up elsewhere, and for the use of other parties; he might argue that the honey belonged by right to him, and even jump at the conclusion that there was so much of the substance of the soil taken away every year, and that his land must therefore become impoverished. It is true that if he possessed such an amount of knowledge as might be expected to belong to an intelligent agriculturist, working upon rational principles, he should be able, upon reflection, to see that such ideas were entirely groundless. Nevertheless, the complaint is sometimes made, in a more or less vague manner, by persons who ought to know better; and even beekeepers appear occasionally to adopt an apologetic tone, arguing that "bees do more good than harm," instead of taking the much higher and only true stand by asserting that bees, while conferring great benefits on agriculture, do no harm whatever, and that the presence of an apiary on or close to his land can be nothing but an advantage to the agriculturist.

### BENEFICIAL INFLUENCE OF BEES ON AGRICULTURE.

The value of the intervention of bees in the cross-fertilisation of plants is dwelt upon in Chapter III, "Australasian Bee Manual," third edition,

---

\* This paper, which constituted the nineteenth chapter of the third edition of my "Australasian Bee Manual," was an attempt, and I have reasons for believing a successful attempt, to clear up several misunderstandings that had arisen in the minds of some farmers who had come to regard the working of neighbours' bees in their pasturage as detrimental to themselves, and to prove on the contrary that it is really to their interests to encourage beekeeping. Shortly after the paper was first published the subject was brought prominently forward in consequence of the action taken by a farmer in the United States to claim damages from a neighbouring beekeeper for alleged injury done to his grazing sheep by trespassing(?) bees. Needless to say, he lost his case. The paper has been extensively quoted in several American bee journals, and described as a "unique and valuable addition to bee literature." I trust it may still serve a good purpose in this country, where it first appeared.—I.H.

and the reader is referred for further information to the works of Sir J. Lubbock and of Darwin. The latter, in his work on "Cross and Self Fertilisation of Plants," gives the strongest evidence as to the beneficial influence of bees upon clover-crops. At page 169, when speaking of the natural order of leguminous plants, to which the clovers belong, he says, "The cross-seedlings have an enormous advantage over the self-fertilised ones when grown together in close competition"; and in Chapter X, page 361, he gives the following details of some experiments, which show the importance of the part played by bees in the process of cross-fertilisation:—

*Trifolium repens* (White Clover).—Several plants were protected from insects, and the seeds from ten flower-heads on these plants and from ten heads on other plants growing outside the net (which I saw visited by bees) were counted, and the seeds from the latter plants were very nearly ten times as numerous as those from the protected plants. The experiment was repeated in the following year, and twenty protected heads now yielded only a single abortive seed, whilst twenty heads on the plants outside the net (which I saw visited by bees) yielded 2,290 seeds, as calculated by weighing all the seeds and counting the number in a weight of 2 grains.

*Trifolium pratense* (Purple Clover).—One hundred flower-heads on plants protected by a net did not produce a single seed, whilst one hundred on plants growing outside (which were visited by bees) yielded 68 grains' weight of seed; and, as eighty seeds weighed 2 grains, the hundred heads must have yielded 2,720 seeds.

Here we have satisfactory proof that the effect of cross-fertilisation brought about by bees upon the clovers and other plants growing in meadows and pasture-lands is the certain production of a large number of vigorous seeds, as compared with the chance only of a few and weak seeds if self-fertilisation were to be depended upon. In the case of meadow-cultivation it enables the farmer to raise seed for his own use or for sale, instead of having to purchase it, while at the same time the nutritious quality of the hay is, as we shall see further on, improved during the process of ripening the seed. In the case of pasture-lands, such of those vigorous seeds as are allowed to come to maturity and to fall in the field will send up plants of stronger growth to take the place of others that may have died out, or to fill up hitherto-unoccupied spaces, thus tending to cause a constant renewal and strengthening of the pasture. The agriculturist himself should be the best judge of the value of such effects.

The beneficial effect of the bees' visits to fruit-trees has been well illustrated by Mr. Cheshire in the pages of the *British Bee Journal*, and by Professor Cook in his articles upon "Honey Bees and Horticulture" in the *American Apiculturist*. (See also "Bulletin No. 18, Bee-culture," New Zealand Department of Agriculture.) In fact, even those who complain of bees cannot deny the services they render; what they contest is the assertion that bees do no harm.

### CAN BEES HARM THE SOIL OR THE CROPS?

is, then, the question to be considered. The agriculturist may say, "Granting that the visits of bees may be serviceable to me in the fertilisation of my fruit or my clover, how will you prove that I am not obliged to pay too high a price for such services?" For the answer to such a question one must fall back upon the researches of the agricultural chemist, which will furnish satisfactory evidence to establish the two following facts: First, that saccharine matter, even when assimilated and retained within the body of a plant, is not one of the secretions of vegetable life which can in any way tend to exhaust the soil, being made up of constituents which are furnished everywhere in superabundance by the atmosphere and rain-water, and not containing any of the mineral or organic substances supplied by the soil or by the manures used in agriculture; and, secondly, that in the form in which it is appropriated by bees, either from the nectaries of flowers or as honeydew from the leaves, it no longer constitutes a part of the plant, but is in fact an excrement, thrown off as superfluous, which if not collected by the bee and by its means made available for the use of man would either be devoured by other insects which do not store honey, or be resolved into its original elements and dissipated in the air.

The foregoing statements can be supported by reference to authorities which can leave no doubt as to their correctness—namely, Sir Humphrey Davy in his "Elements of Agricultural Chemistry," written more than seventy years ago, and Professor Liebig in his "Chemistry in its Application to Agriculture and Physiology," written some ten years later, and the English version of which is edited by Dr. Lyon Playfair and Professor Gregory. These works, which may be said to form the foundation of a rational system of agriculture, were written with that object alone in view, and the passages about to be quoted were not intended to support any theory in favour of bee-culture or otherwise; they deal simply with scientific truths which the layman can safely follow and accept as true upon such undeniable authority, although he may be incapable himself of following up the processes which have led to their discovery or which prove their correctness.

### SACCHARINE MATTER OF PLANTS NOT DERIVED FROM THE SOIL.

Liebig, when describing the chemical processes connected with the nutrition of plants, informs us (at page 4\*) that—

There are two great classes into which all vegetable products may be arranged. The first of these contain nitrogen; in the last this element

---

\* The edition to which reference is made is the fourth, published 1847.

is absent. The compounds destitute of nitrogen may be divided into those in which oxygen forms a constituent (starch, lignine, &c.) and those into which it does not enter (oils of turpentine, lemon, &c.)

And, at page 141, that—

Sugar and starch do not contain nitrogen; they exist in the plants in a free state, and are never combined with salts or with alkaline bases. They are compounds formed from the carbon of the carbonic acid and the elements of water (oxygen and hydrogen).

Sir Humphrey Davy had already stated that, “according to the latest experiments of Gay Lussac and Thenard, sugar consists of 42·47 per cent. of carbon and 57·23 per cent. of water and its constituents.” Now, Liebig in several parts of his work shows that the carbon in sugar and all vegetable products is obtained from carbonic acid in the atmosphere; and that “plants do not exhaust the carbon of the soil in the normal condition of their growth; on the contrary, they add to its quantity.”

#### DERIVED FROM THE ATMOSPHERE AND RAIN-WATER.

The same authority shows that the oxygen and hydrogen in these products are derived from the atmosphere and from rain-water; and that it is only the products containing nitrogen (such as gluten or albumen in the seeds or grains), and those containing mineral matter (silex, lime, aluminium, &c.), which take away from the soil those substances that are required to be returned to it in the shape of manures. The saccharine matter, once it is secreted by the plant and separated from it, is even useless as a manure. Liebig says on this head, page 21,—

The most important function in the life of plants, or, in other words, in their assimilation of carbon, is the separation—we might almost say the generation—of oxygen. No matter can be considered as nutritious or as necessary to the growth of plants which possesses a composition either similar to or identical with theirs, because the assimilation of such a substance could be effected without the exercise of this function. The reverse is the case in the nutrition of animals. Hence such substances as sugar, starch, and gum, themselves the products of plants, cannot be adapted for assimilation; and this is rendered certain by the experiments of vegetable physiologists, who have shown that aqueous solutions of these bodies are imbibed by the roots of plants and carried to all parts of their structure, but are not assimilated; they cannot, therefore, be employed in their nutrition.

#### NECTAR OF PLANTS INTENDED TO ATTRACT INSECTS.

The secretion of saccharine matter in the nectaries of flowers is shown to be one of the normal functions of the plant, taking place at the season when it is desirable to attract the visits of insects for the purposes of its fertilisation. It may, then, be fairly asserted that the insect, when it carries off the honey from any blossom it has visited, is merely

taking with it the fee or reward provided by nature for that special service.

### SOMETIMES THROWN OFF AS SUPERFLUOUS.

There are, however, occasions when considerable quantities of such matter are thrown off or exuded by the leaves, which effect is taken to indicate an abnormal or unhealthy condition of the plant. At pages 106 and 107 of Liebig's book (speaking of an experiment made to induce the rising sap of a maple-tree to dissolve raw sugar applied through a hole cut in the bark) he shows that,—

When a sufficient quantity of nitrogen is not present to aid in the assimilation of the substances destitute of it, these substances will be separated as excrements from the bark, roots, leaves, and branches.

In a note to this last paragraph we are told that—

Langlois has lately observed, during the dry summer of 1842, that the leaves of the linden-tree became covered with a thick and sweet liquid in such quantities that for several hours of the day it ran off the leaves like drops of rain. Many kilograms might have been collected from a moderate-sized linden-tree.

And further on, at page 141, he says,—

In a hot summer, when the deficiency of moisture prevents the absorption of alkalies, we observe the leaves of the lime-tree, and of other trees, covered with a thick liquid containing a large quantity of sugar; the carbon of the sugar must, without doubt, be obtained from the carbonic acid of the air. The generation of the sugar takes place in the leaves, and all the constituents of the leaves, including the alkalies and alkaline earths, must participate in effecting its formation. Sugar does not exude from the leaves in moist seasons, and this leads us to conjecture that the carbon which appeared as sugar in the former case would have been applied in the formation of other constituents of the tree in the event of its having had a free and unimpeded circulation.

These quotations will probably be considered sufficient to justify the assertion that the gathering of the honey from plants can in no possible way tend to exhaust the soil or affect its fertility. There is no difference of opinion among scientific men as to the sources from which the saccharine matter of plants is derived. Since Liebig first put forward his views on that subject, as well as with regard to the sources from which the plants derive their nitrogen, the principles of agricultural chemistry have been studied by the most eminent chemists, some of whom combated the views of Liebig on this latter point (the source of nitrogen and its compounds), and Liebig himself seems to have modified his views on that point; but there has been no difference of opinion about the saccharine matter, as to which Liebig's doctrine will be found given unaltered in the latest colonial work on the subject, MacIvor's "Chemistry of Agriculture," published at Melbourne a few years ago.

## SUPERFLUOUS NECTAR EVAPORATED IF NOT TAKEN BY INSECTS.

That the nutritive quality of the plants in any growing crop is not diminished by the abstraction of honey from their blossoms would appear to be evident from the fact already referred to, that those plants have actually thrown off the honey from the superfluity of their saccharine juices, as a matter which they could no longer assimilate. There would appear, on the other hand, to be good reason to believe that the plants themselves become daily more nutritive during the period of their giving off honey—that is, from the time of flowering to that of ripening their seeds. This is a point upon which, I believe, all agricultural chemists are not quite agreed, but the testimony of Sir H. Davy is very strong in favour of it. In the appendix to his work already quoted, he gives the results of experiments made conjointly by himself and Mr. Sinclair, the gardener to the Duke of Bedford, upon nearly a hundred different varieties of grasses and clovers. These were grown carefully in small plots of ground as nearly as possible equal in size and quality; equal weights of the dried produce of each, cut at different periods, especially at the time of flowering and at that of ripened seeds, were “acted upon by hot water till all their soluble parts were dissolved; the solution was then evaporated to dryness by a gentle heat in a proper stove, and the matter obtained carefully weighed, and the dry extract, supposed to contain the nutritive matter of the plants, was sent for chemical analysis.” Sir H. Davy adds his opinion that this “mode of determining the nutritive power of grasses is sufficiently accurate for all the purposes of agricultural investigation.” Further on he reports, “In comparing the compositions of the soluble products afforded by different crops from the same grass, I found, in all the trials I made, the largest quantity of truly nutritive matter in the crop cut when the seed was ripe, and the least bitter extract and saline matter and the most saccharine matter, in proportion to the other ingredients, in the crop cut at the time of flowering.” In the instance which he then gives, as an example, the crop cut when the seed had ripened showed 9 per cent. less of sugar, but 18 per cent. more of mucilage and what he terms “truly nutritive matter” than the crop cut at the time of flowering. From this it would follow that during the time a plant is in blossom and throwing off a superfluity of saccharine matter in the shape of honey the assimilation of true nutritive matter in the plant itself is progressing most favourably. In any case it is clear that the honey, being once exuded, may be taken away by bees or any other insects (as it is evidently intended to be taken) without any injury to the plant, by which it certainly cannot be again taken up, but must be evaporated if left exposed to the sun’s heat.

### QUESTION AS TO GRAZING STOCK.

There is, however, a plea put in by the agriculturist on behalf of his grazing stock, and one which he generally seems to consider unanswerable. He says, "Even if it be admitted that the removal of the honey from my farm is neither exhausting to the soil nor injurious to the plants of the standing crop, still it is so much fattening-matter which might be consumed by my stock if it had not been pilfered by the bees."

Now, it may at once be admitted that honey consists to a great extent of fattening-matter, though it may be allowable to doubt whether in that particular form it is exactly suitable as food for grazing cattle. Although it is quite true that the saccharine matter assimilated in the body of a plant tends to the formation of fat in the animal which eats and digests that plant, still one may question the propriety of feeding the same animal on pure honey or sugar. We may, however, waive that view of the subject, as we shall shortly see that it is only a question of such homœopathically small doses as would not be likely to interfere with the digestion of the most delicate grazing animal, any more than they would considerably increase its weight. Admitting, therefore, that every pound of honey of which the grazing stock are deprived by bees is a loss to the farmer, and therefore to be looked upon as a set-off to that extent against the benefits conferred by the bees in other ways, it will be necessary to consider to what extent it is possible that such loss may be occasioned.

### QUANTITY OF HONEY FURNISHED BY PASTURE-LAND.

In the first place, it must be recollected that a large proportion—in some cases the great bulk—of the honey gathered by bees is obtained from trees, as, for instance, the linden in Europe, the bass-wood and maple in America, and in this country the forest-trees, nearly all of which supply rich forage for the bee, and everywhere from fruit-trees in orchards. A large quantity is gathered from flowers and flowering shrubs reared in gardens; from clover and other plants grown for hay, and not for pasture; and even in the field there are many shrubs and flowering plants which yield honey, but which are never eaten by cattle. Pastures, therefore, form but a small part of the sources from which honey is obtained; and in dealing with this grazing question we have to confine our inquiries to clovers and other flowering-plants grown in open pastures, and such as constitute the ordinary food of grazing stock. In order to meet the question in the most direct manner, however, let us assume the extreme case of a large apiary being placed in a district where there is nothing else but such open pastures, and growing only such flowering-plants as are generally eaten by stock. Now, the ordinary

working-range of the bee may be taken at a mile and a half from the apiary on all sides, which gives an area of about 4,500 acres for the supply of the apiary; and if the latter consists of a hundred hives, producing an average of 100 lb. of honey, there would be a little more than 2 lb. of honey collected off each acre in the year; or, if we suppose so many as two hundred hives to be kept at one place, and to produce so much as 10 tons of honey in the season, the quantity collected from each acre would be 4 lb. to 5 lb.

#### PROPORTION POSSIBLY CONSUMED BY STOCK.

Let us next consider what proportion of those few pounds of honey could have found its way into the stomachs of the grazing stock if it had not been for the bees. It is known that during the whole time the clover or other plants remain in blossom, if the weather be favourable, there is a daily secretion of fresh honey, which, if not taken at the proper time by bees or other insects, is evaporated during the midday heat of the sun. It has been calculated that a head of clover consists of fifty or sixty separate flowers, each of which contains a quantity not exceeding one five-hundredth part of a grain in weight, so that the whole head may be taken to contain one-tenth of a grain of honey at any one time. If this head of clover is allowed to stand until the seeds are ripened it may be visited on ten or even twenty different days by bees, and they may gather, on the whole, one, or even two, grains of honey from the same head, whereas it is plain that the grazing animal can only eat the head once, and consequently can only eat one-tenth of a grain of honey with it. Whether he gets that one-tenth grain or not depends simply on the fact whether or not the bees have exhausted that particular head on the same day just before it was eaten. Now, cattle and sheep graze during the night and early morning, long before the bees make their appearance some time after sunrise; all the flowering plants they happen to eat during that time will contain the honey secreted in the evening and night-time; during some hours of the afternoon the flowers will contain no honey, whether they have been visited by bees or not; and even during the forenoon, when the bees are not busy, it is by no means certain that they will forestall the stock in visiting any particular flower. If a field were so overstocked that every head of clover should be devoured as soon as it blossomed, then, of course, there would be nothing left for the bees; but if, on the other hand, as is generally the case, there are always blossoms left standing in the pasture, some of them even till they wither and shed their seeds, then it must often happen that after bees shall have visited such blossoms ten or even twenty times, and thus collected one or even two grains of honey from one head, the grazing animal may, after all, eat that particular plant and enjoy his one-tenth of a grain of honey just as well as if there had never been any bees in the field.



If all these chances be taken into account it will be evident that out of the 4 lb. or 5 lb. of honey assumed to be collected by bees from one acre of pasturage probably not one-tenth, and possibly not even one-twentieth, part could under any circumstances have been consumed by the grazing animals—so that it becomes a question of a few ounces of fattening-matter, more or less, for all the stock fed upon an acre during the whole season; a matter so ridiculously trivial in itself, and so out of all proportion to the services rendered to the pasture by the bees, that it may be safely left out of consideration altogether.

### BEEKEEPING AS A BRANCH OF FARMING.

There is still one point which may possibly be raised by the agriculturist or landowner. "If the working of bees is so beneficial to my crops, and if such a large quantity of valuable matter may be taken, in addition to the ordinary crops, without impoverishing my land, why should I not take it instead of another person who has by right no interest in my crop or my land?" The answer to this is obvious. It is, of course, quite open to the agriculturist to keep any number of bees he may think fit; only, he must consider well in how far it will pay him to add the care of an apiary to his other duties. No doubt every one farming land may with advantage keep a few stands of hives to supply his own wants in honey—the care of them will not take up too much of his time, or interfere much with his other labours; but if he starts a large apiary with the expectation that it shall pay for itself, he must either give up the greater portion of his own time to it or employ skilled labour for that special purpose; and he must recollect that the profits of beekeeping are not generally so large as to afford more than a fair remuneration for the capital, skill, and time required to be devoted to the pursuit. In any case, he cannot confine the bees to work exclusively on his own property, unless the latter is very extensive. When such is the case, he may find it greatly to his advantage to establish one or more apiaries to be worked under proper management, as a separate branch of his undertaking; but in every case, whether he may incur or share the risks of profit and loss in working an apiary or not, the thing itself can only be a source of unmixed advantage to his agricultural operations, and consequently if he does not occupy the ground in that way himself he should be glad to see it done by any other person.









