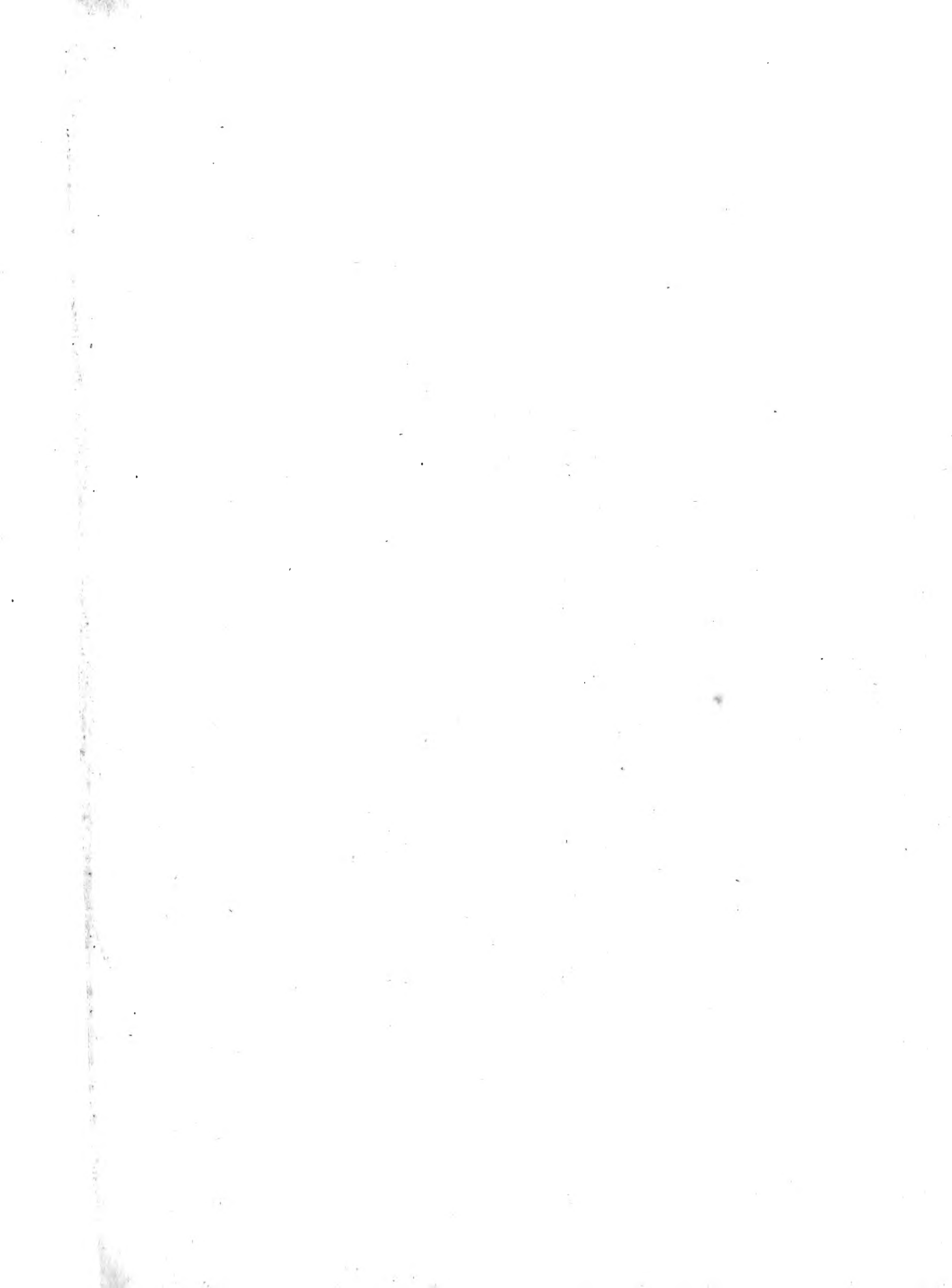


3 1761 07825110 5







Digitized by the Internet Archive
in 2010 with funding from
University of Toronto

<http://www.archive.org/details/cyclopaediaplates04rees>

THE
CYCLOPÆDIA;
OR,
Universal Dictionary
OF
ARTS, SCIENCES, AND LITERATURE.

PLATES. VOL. IV.
NAVIGATION — WRITING BY CIPHER.

THE
CYCLOPÆDIA;

OR,

UNIVERSAL DICTIONARY

OF

Arts, Sciences, and Literature.

BY

ABRAHAM REES, D.D. F.R.S. F.L.S. *S. Amer. Soc.*

WITH THE ASSISTANCE OF

EMINENT PROFESSIONAL GENTLEMEN.

ILLUSTRATED WITH NUMEROUS ENGRAVINGS,

BY THE MOST DISTINGUISHED ARTISTS.

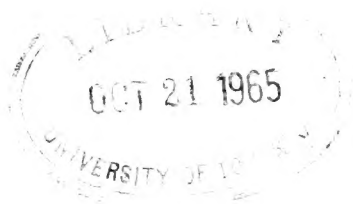
PLATES. VOL. IV.

NAVIGATION — WRITING BY CIPHER.

LONDON:

PRINTED FOR LONGMAN, HURST, REES, ORME, & BROWN, PATERNOSTER-ROW,
F.C. AND J. RIVINGTON, A. STRAHAN, PAYNE AND FOSS, SCATCHERD AND LETTERMAN, J. CUTHELL,
CLARKE AND SONS, LACKINGTON HUGHES HARDING MAJOR AND JONES, J. AND A. ARCH,
CADELL AND DAVIES, S. BAGSTER, J. MAWMAN, BLACK KINGSBURY PARBURY AND ALLEN,
R. SCHOLEY, J. BOOTH, J. BOOKER, SUTTABY EVANCE AND FOX, BALDWIN CRADOCK AND JOY,
SHERWOOD NEELY AND JONES, OGLE DUNCAN AND CO., R. SAUNDERS, HURST ROBINSON AND CO.,
J. DICKINSON, J. PATERSON, E. WHITESIDE, WILSON AND SONS, AND BRODIE AND DOWDING.

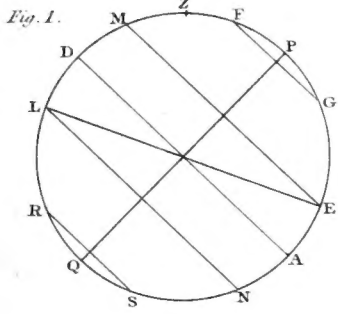
1820.



AE
5
R323
Plates
v.4

1016084

MERIDIAN



MERIDIONAL parts

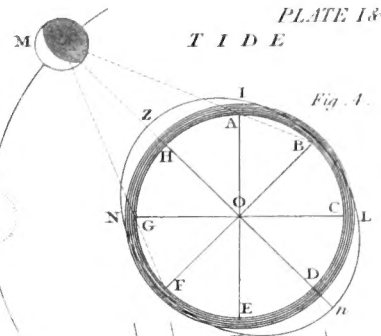
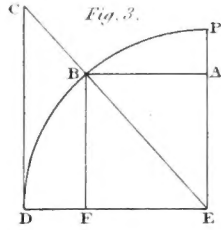
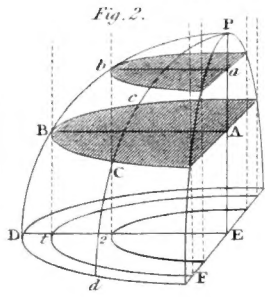


Fig. 5.

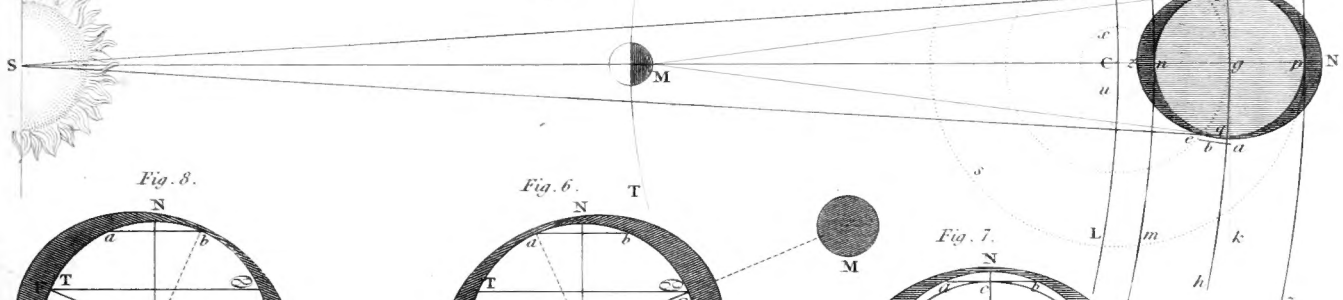


Fig. 8.

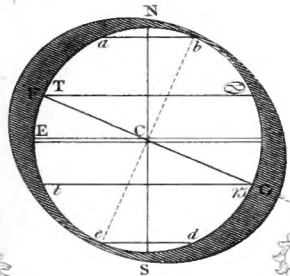


Fig. 6.

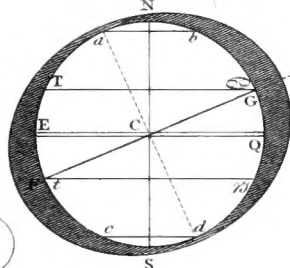


Fig. 7.

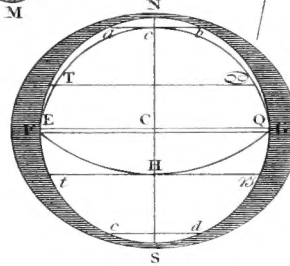
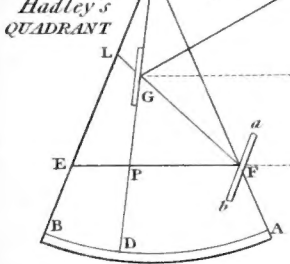


Fig. 2.



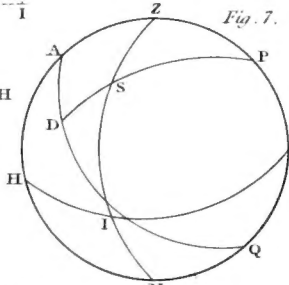
HADLEY'S QUADRANT

Fig. 3.



VARIATION

Fig. 7.



SINICAL QUADRANT

Fig. 4.

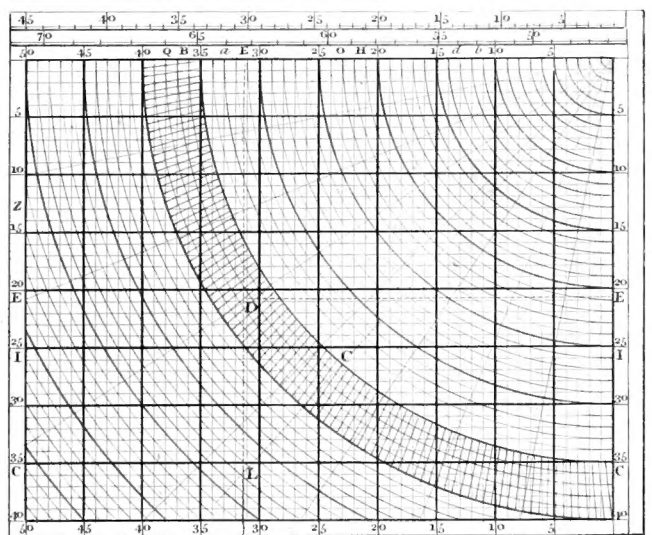


Fig. 8.

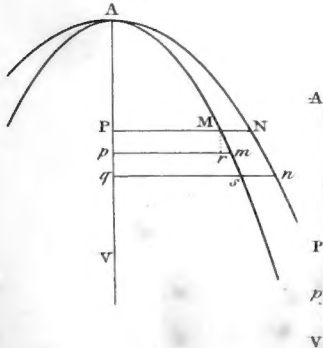


Fig. 9.

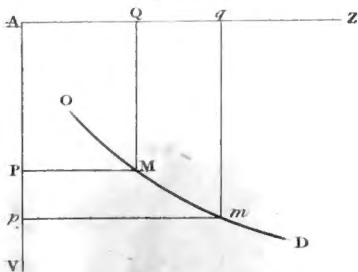


Fig. 5.

RHUMB Line

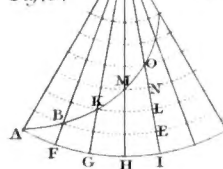
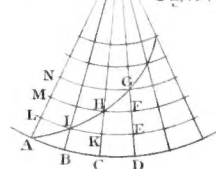
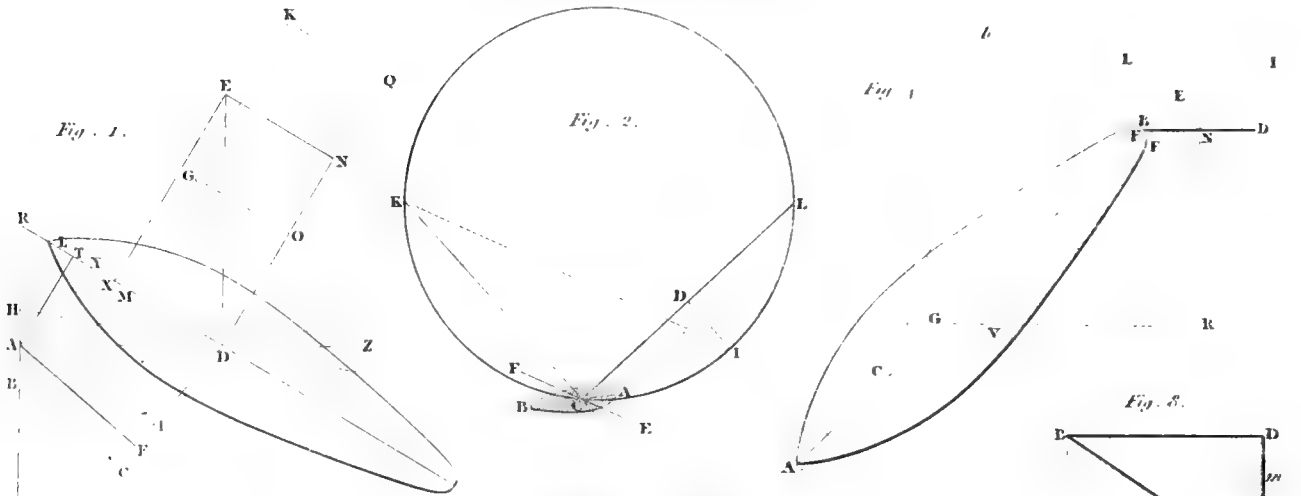


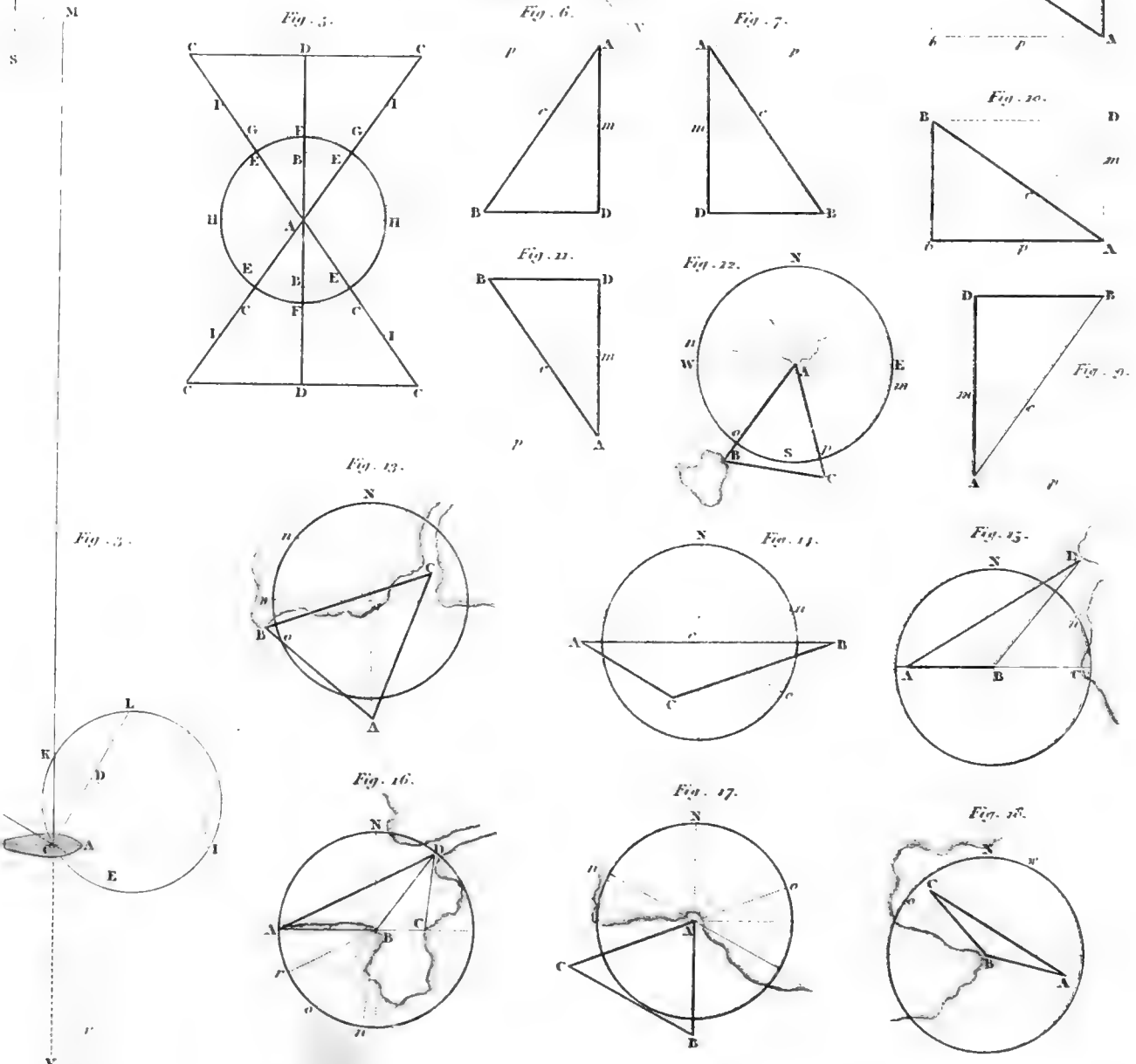
Fig. 6.



NAVIGATION
RUDDER AND SAILING.



Plain SAILING.



Plain SAILING.

Parallel SAILING.

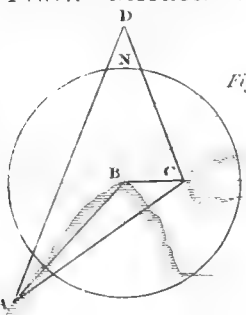


Fig. 19.

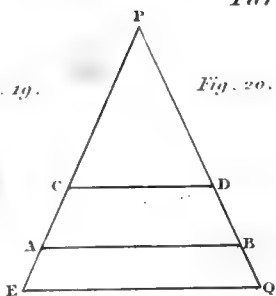


Fig. 20.

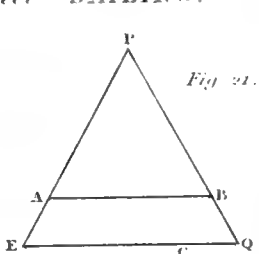


Fig. 21.

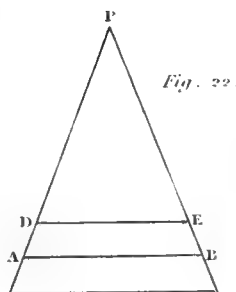


Fig. 22.

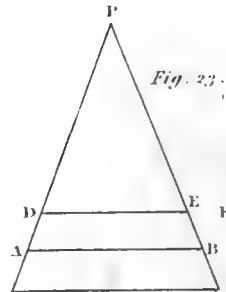


Fig. 23.

Mercator's SAILING.

Great Circle SAILING.

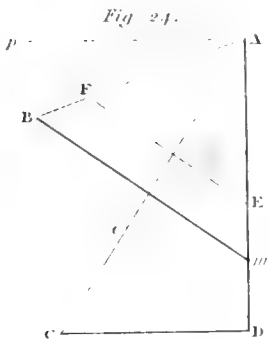


Fig. 24.

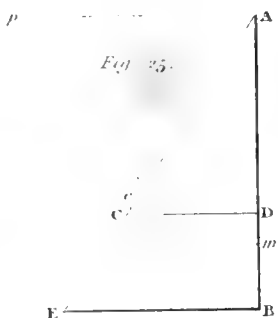


Fig. 25.

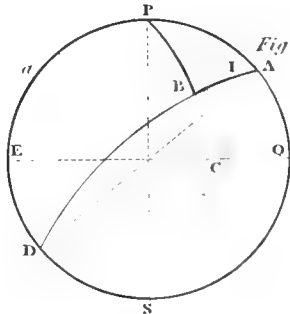


Fig. 26.

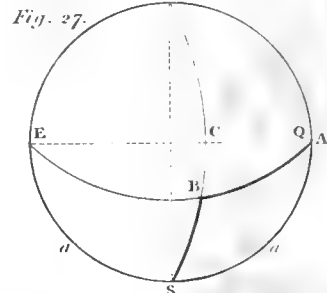


Fig. 27.

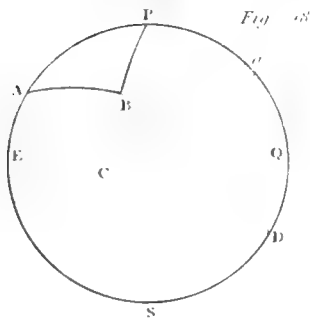


Fig. 28.

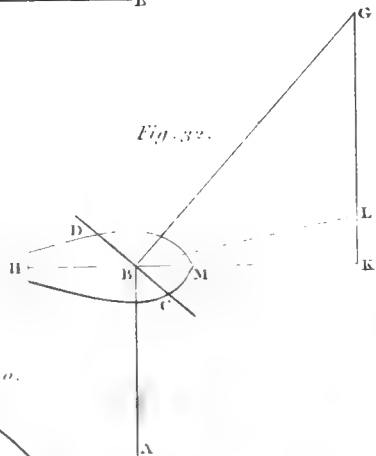


Fig. 29.

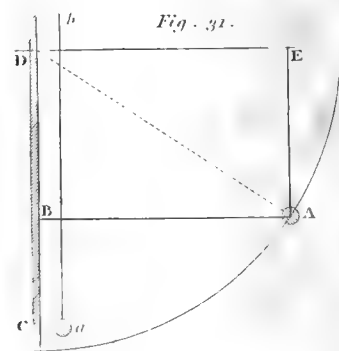


Fig. 30.

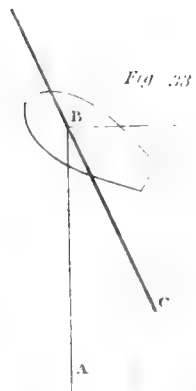


Fig. 31.

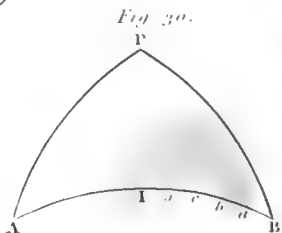


Fig. 32.

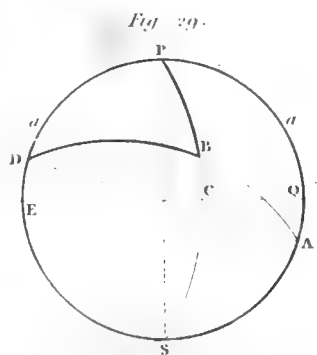


Fig. 33.

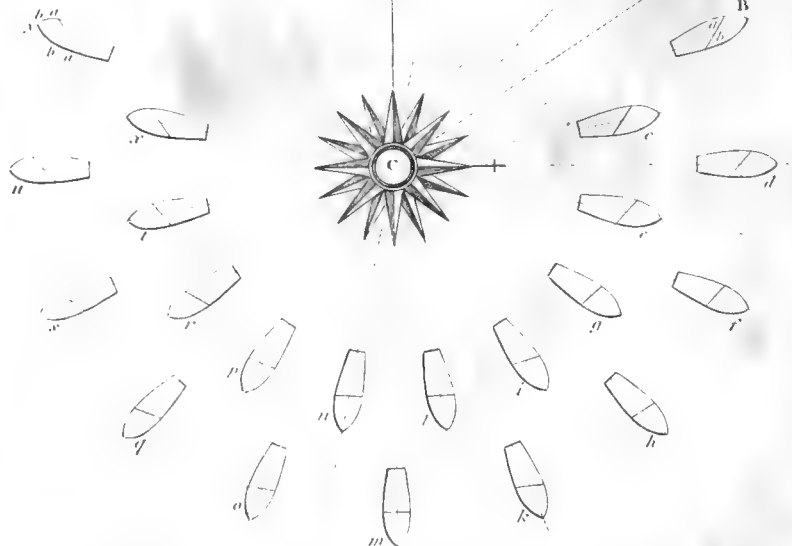


Fig. 34.

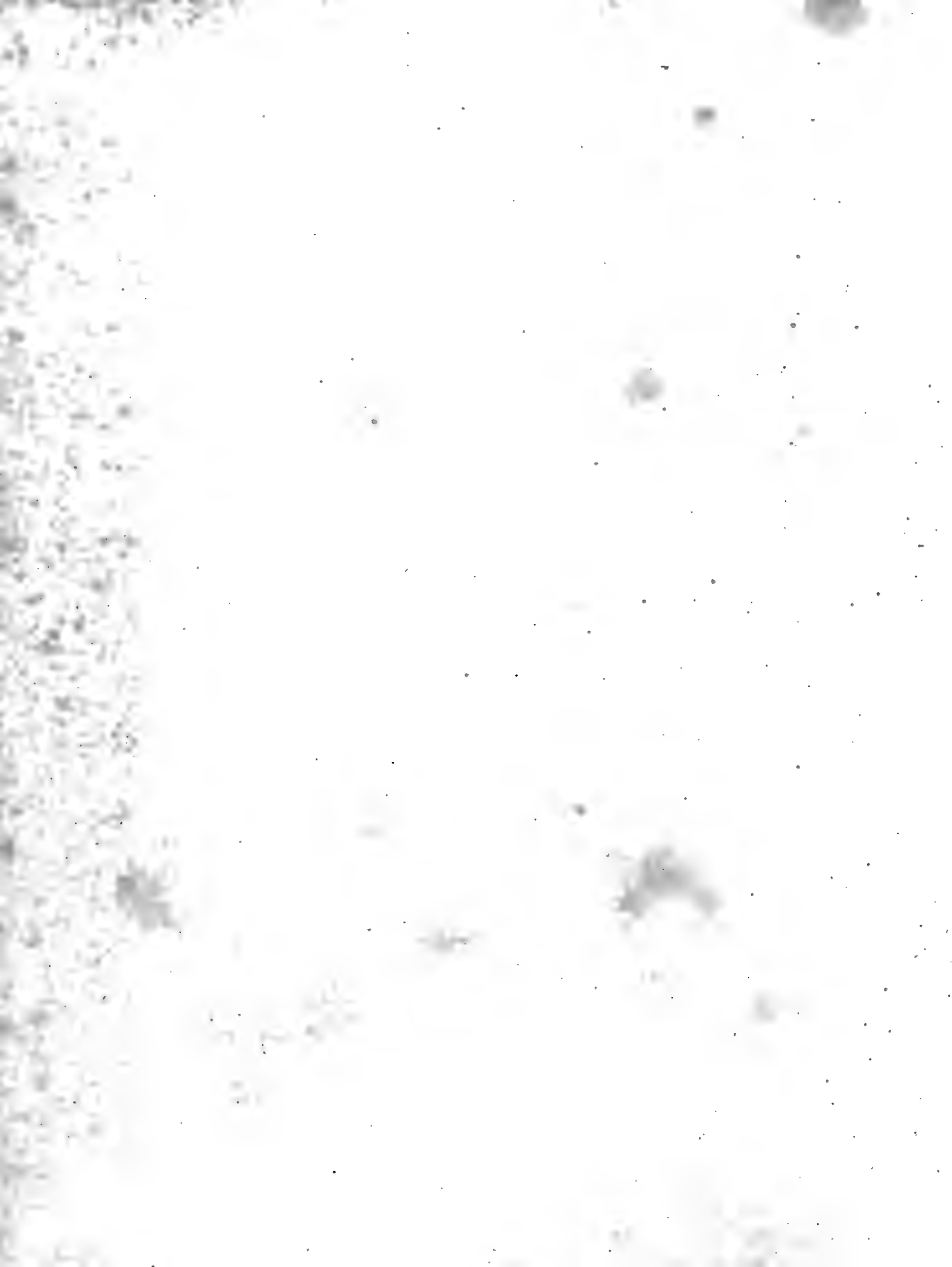


Fig. 1.

TRAVERSE SAILING

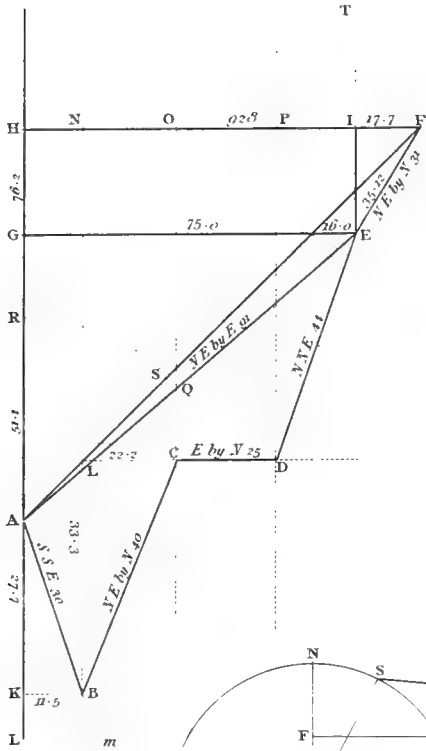
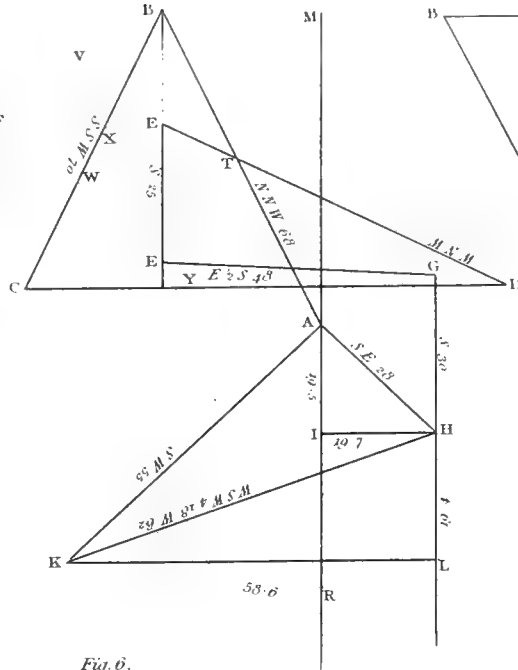


Fig. 2.



CURRENT SAILING

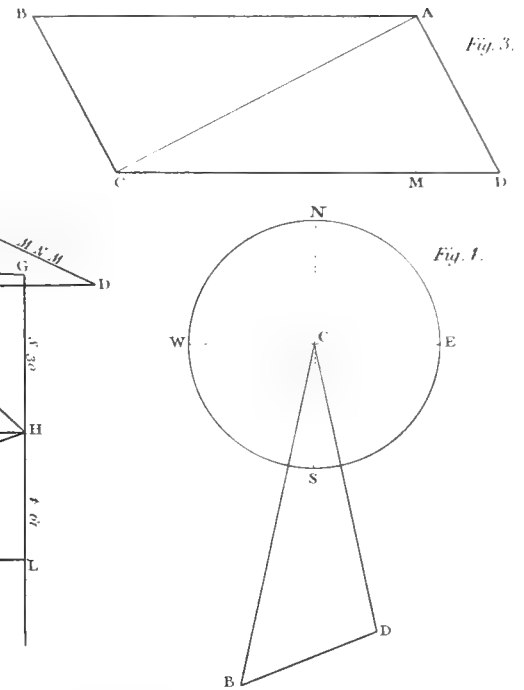


Fig. 6.

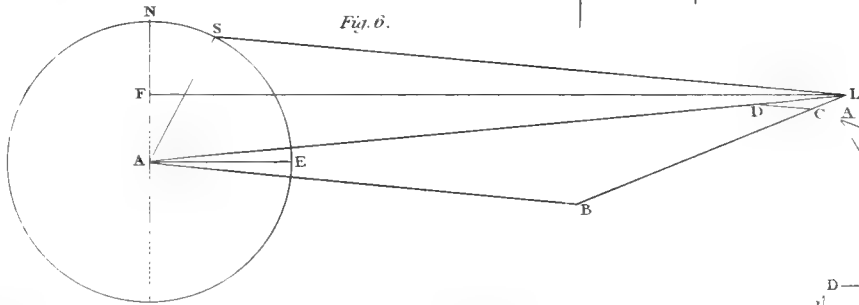
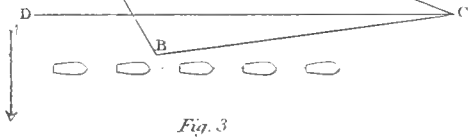
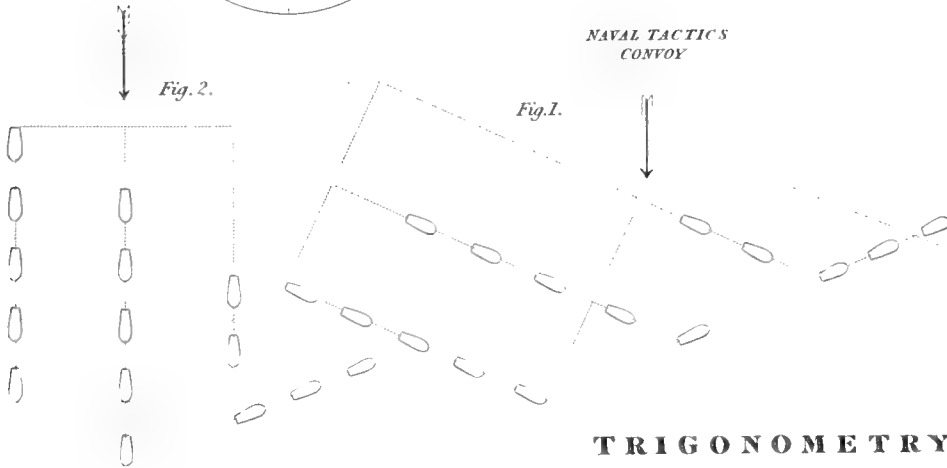


Fig. 5.

NAVAL TACTICS
CONVOY

Fig. 1.



TRIGONOMETRY

PLATE III.

Fig. 1.

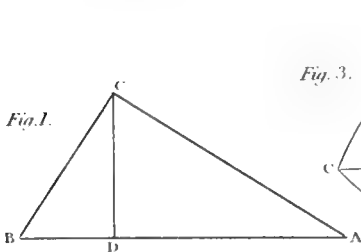


Fig. 3.

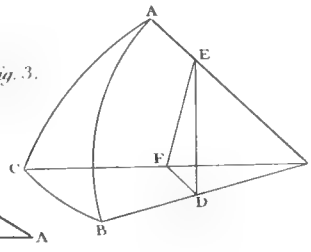


Fig. 2.

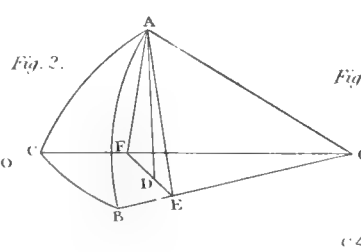


Fig. 4.

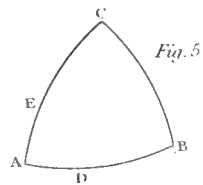
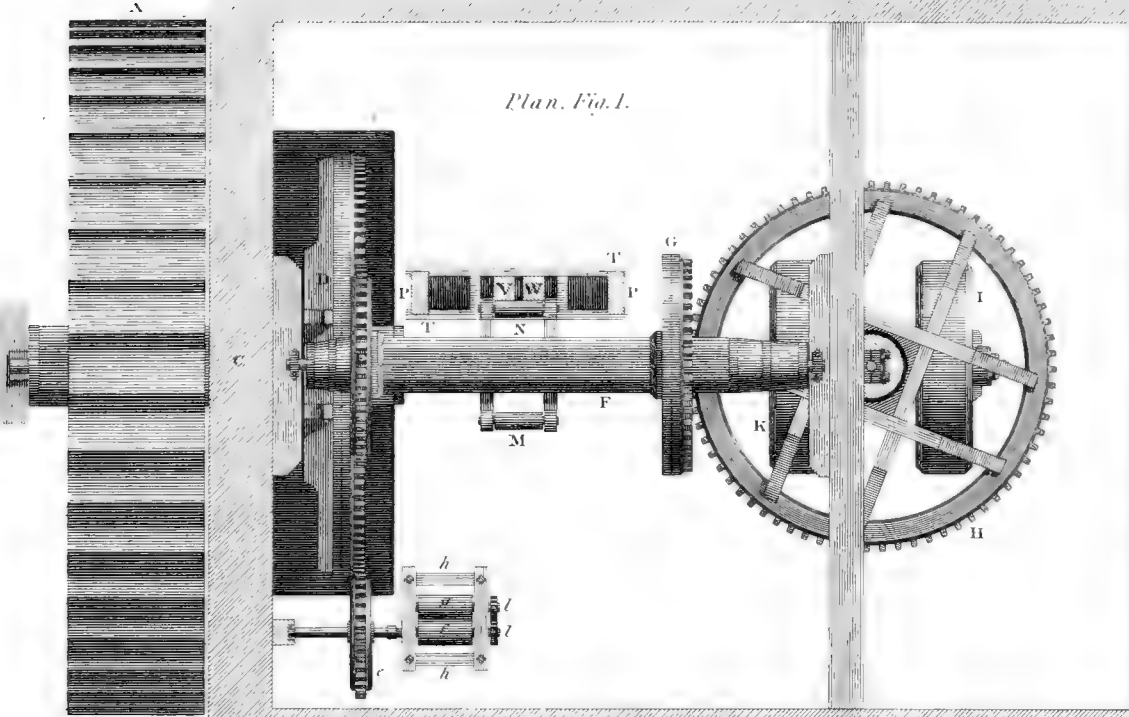


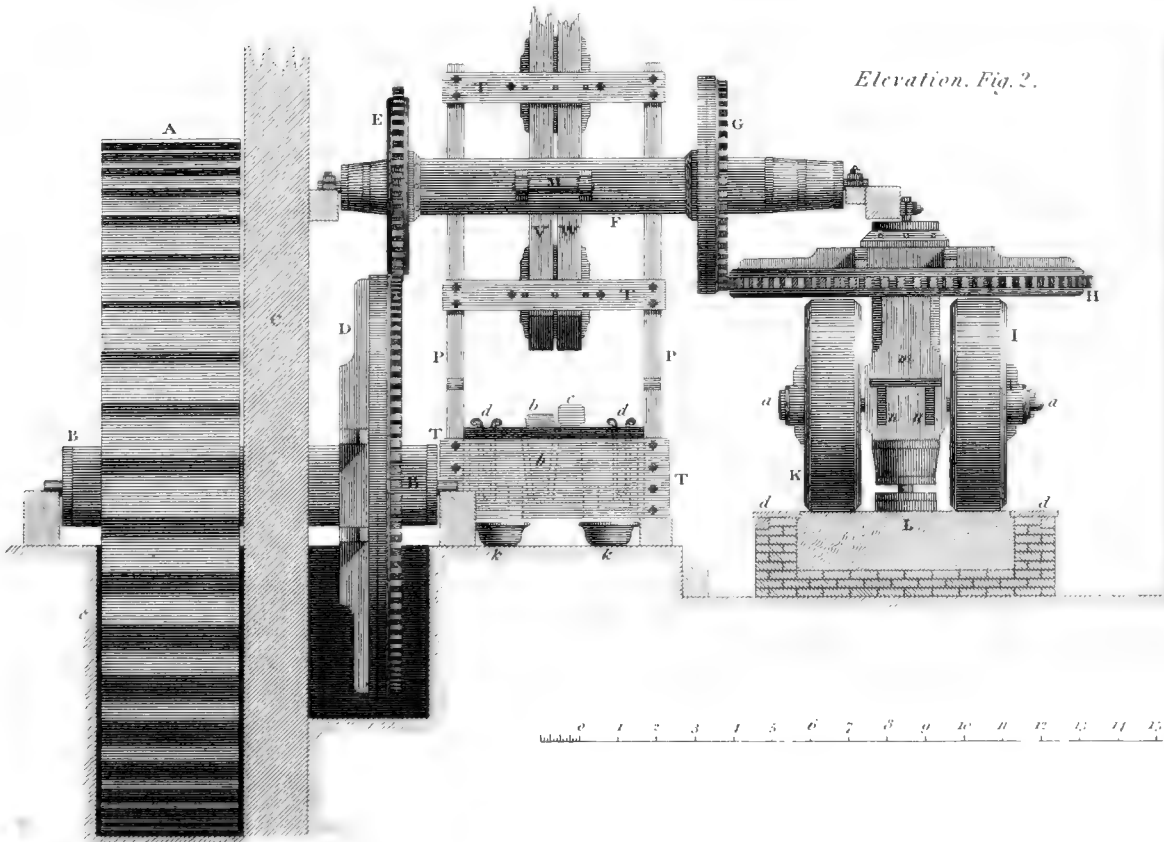
Fig. 5.

OIL MILL.
 BY MR SMEATON.

Plan, Fig. 1.



Elevation, Fig. 2.

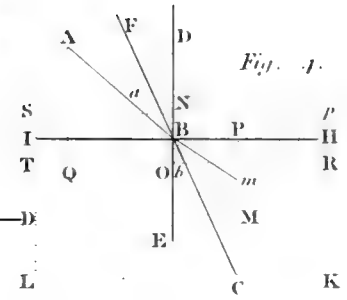
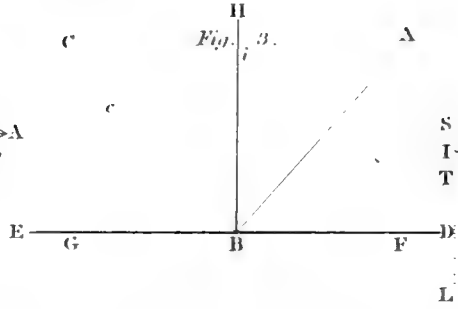
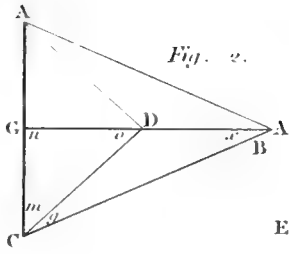
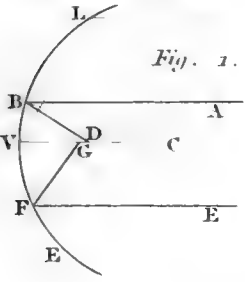


0 1 2 3 4 5 6 7 8 9 10 11 12 13 14 15 16 Feet.

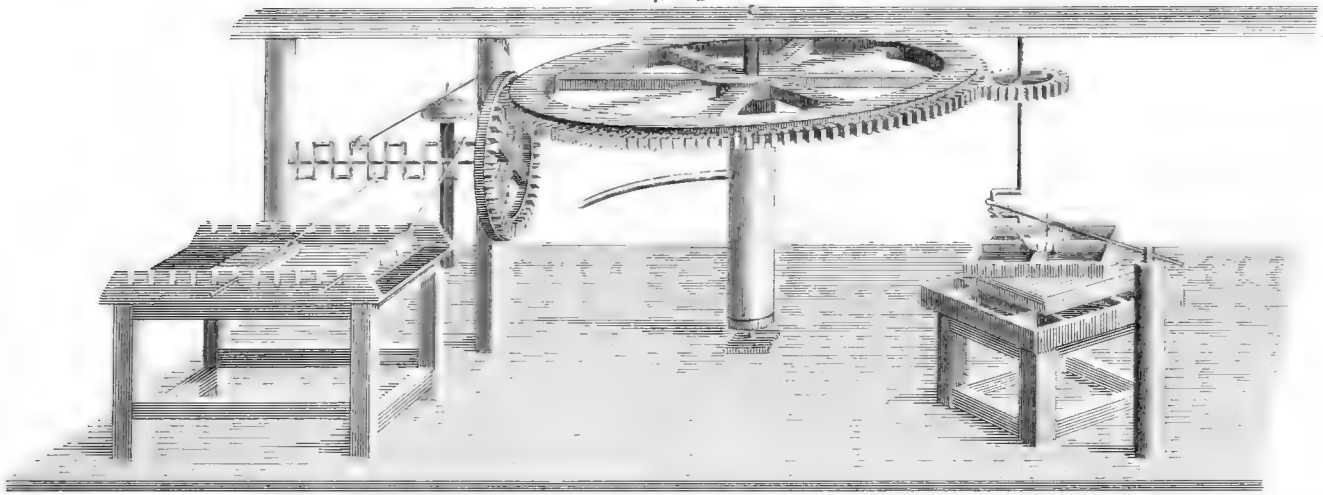


ABBERATION.

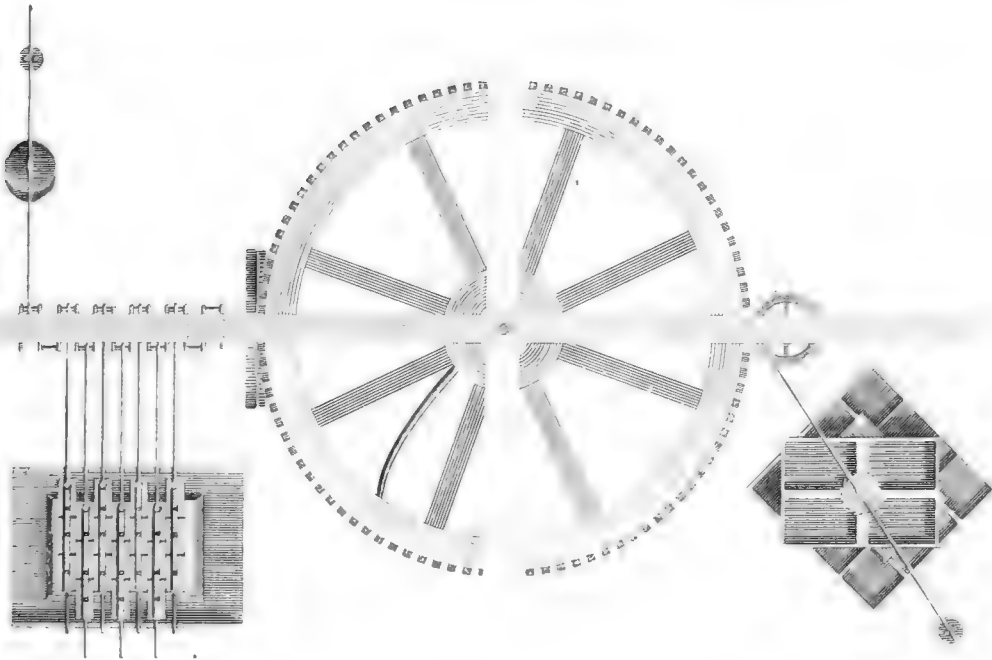
ANGLE.



BURROUGHS'S MACHINE, from a MODEL of the SOCIETY of ARTS, &c.
Fig. 5.



PLAN



PARKER'S BURNING LENS.

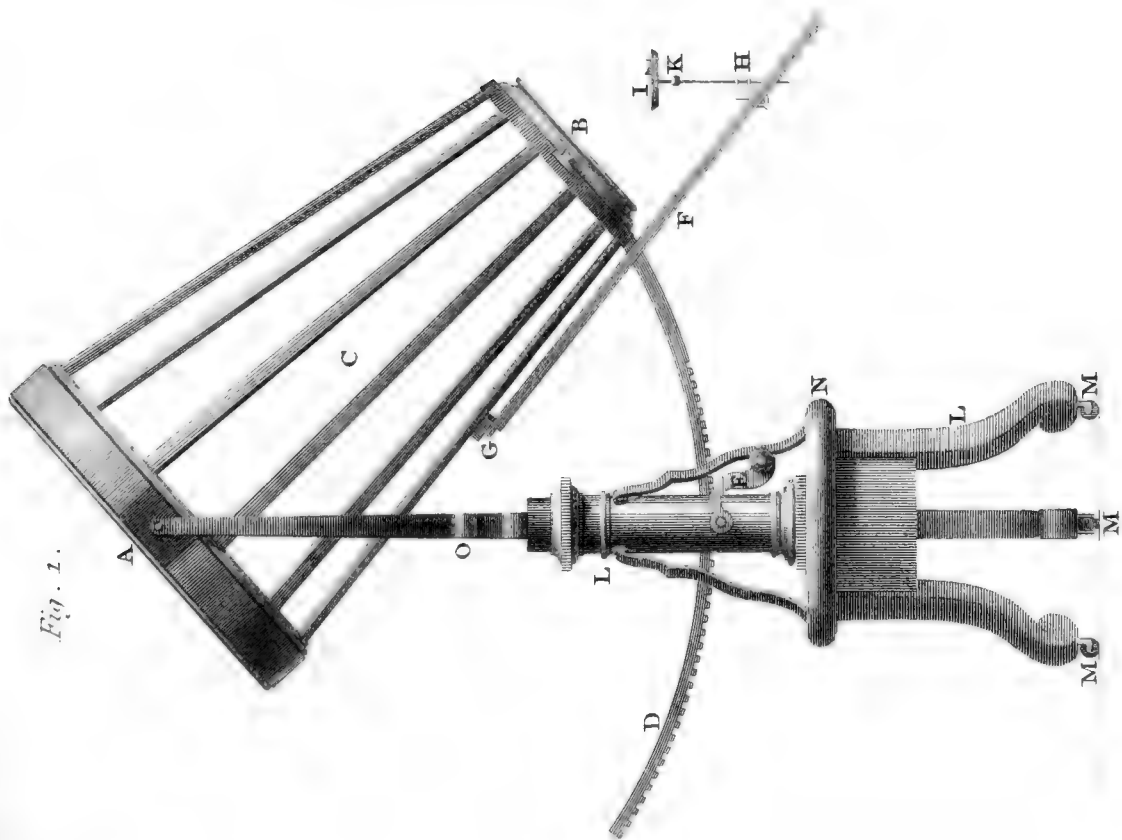


Fig. 1.

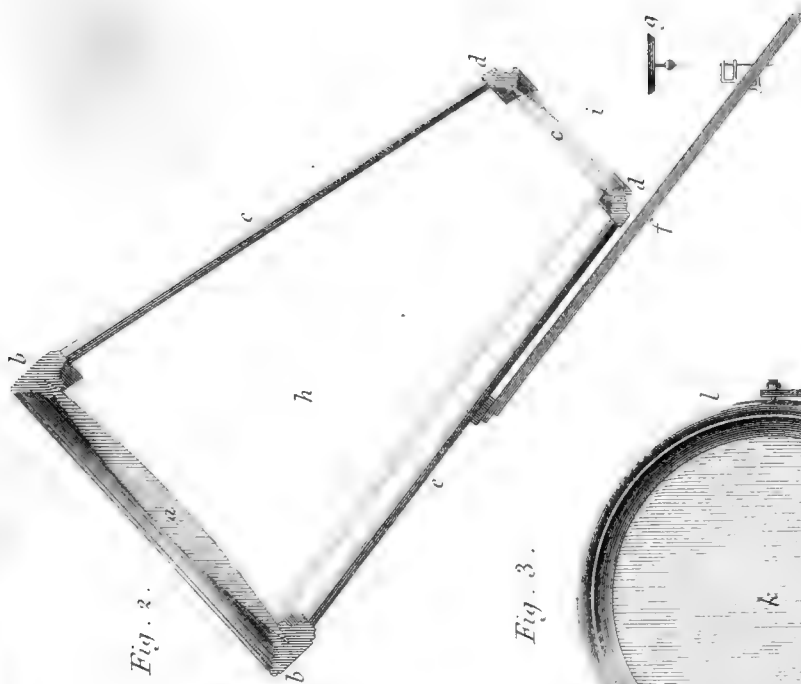
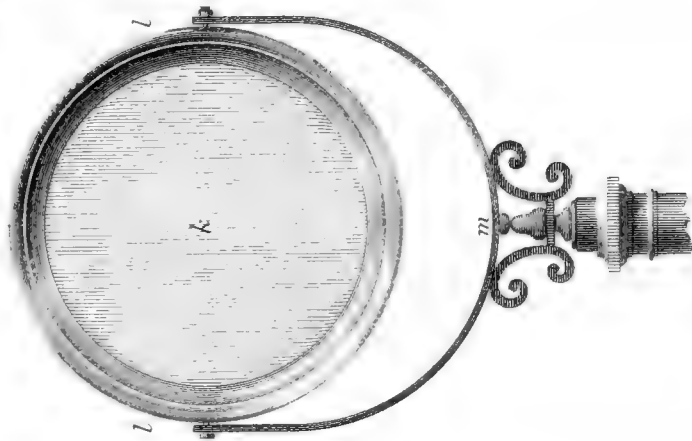


Fig. 2.

Fig. 3.





OPTICS.
CAMERA OBSCURA.

Fig. 1.

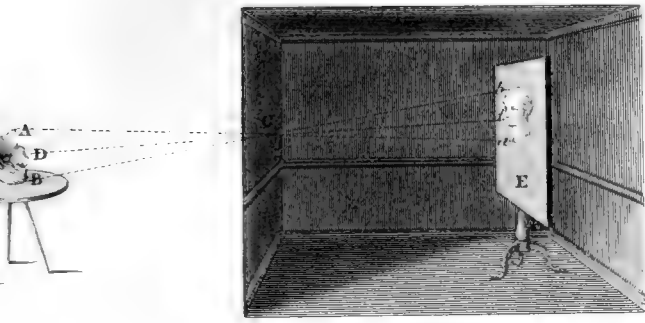


Fig. 2.

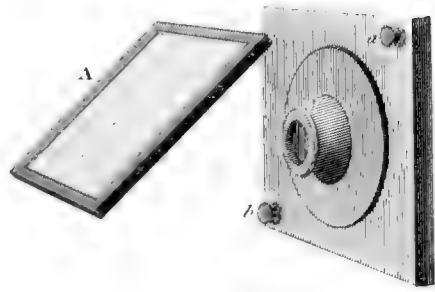


Fig. 3.



Fig. 4.

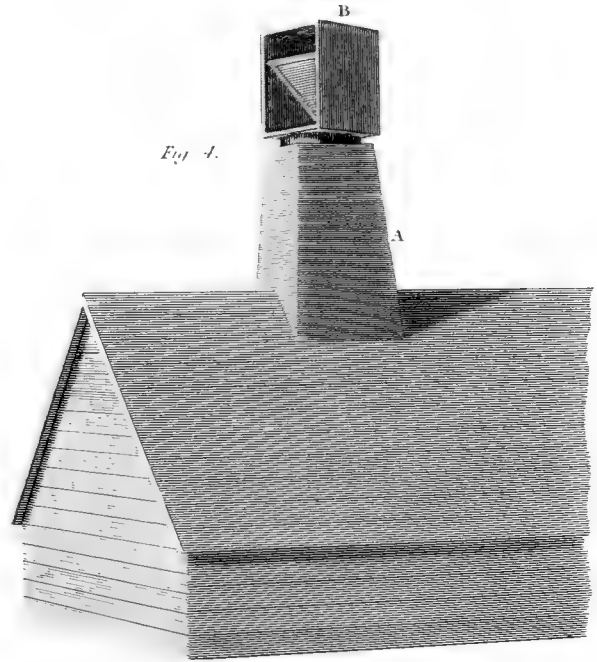


Fig. 5.

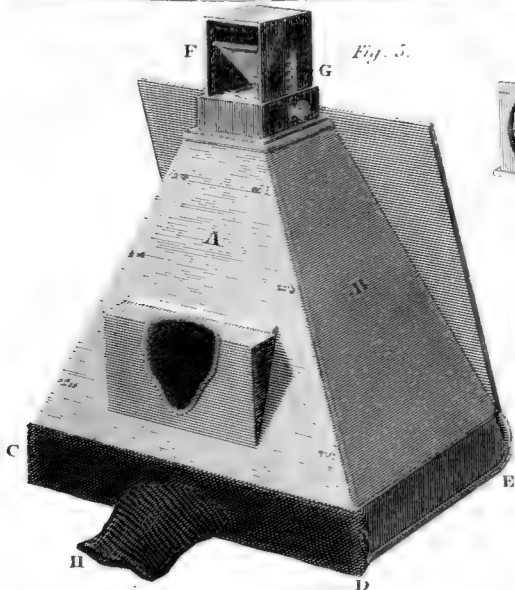
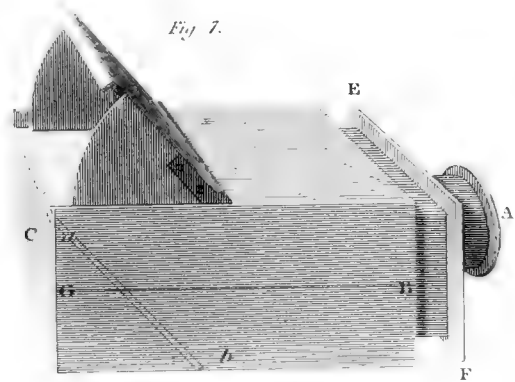
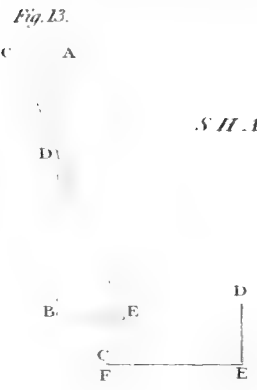
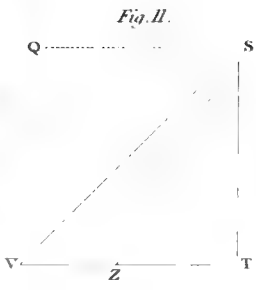
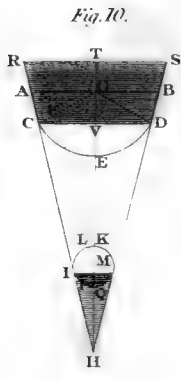


Fig. 6.



Fig. 7.





SHADOW



Fig. 12.

VISIBLE

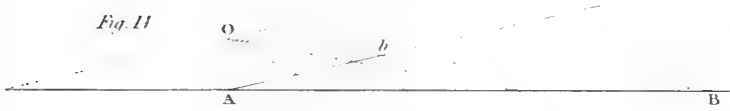


Fig. 11

VISION

DIOPTRICS

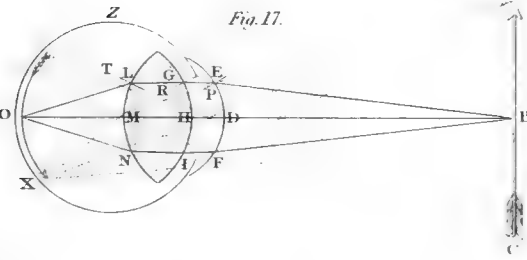


Fig. 17.



Fig. 2.

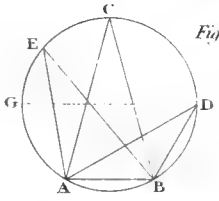
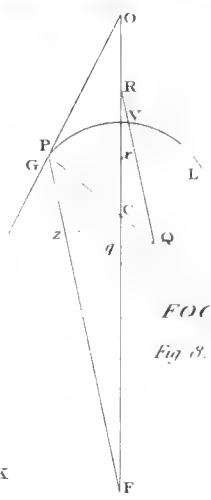


Fig. 15.



FOCUS

Fig. 8.

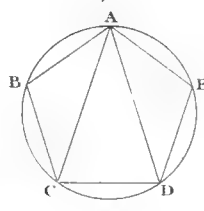


Fig. 10.

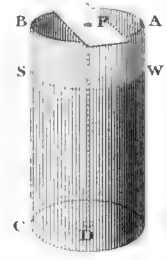
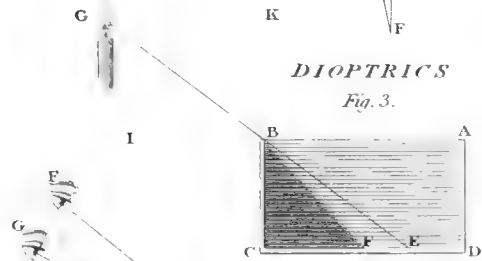


Fig. 3.



DIOPTRICS

Fig. 3.

LOOKING GLASS

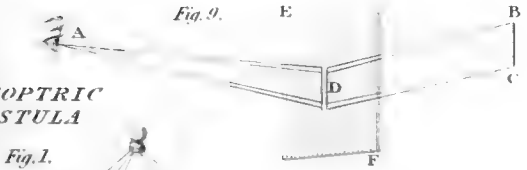


Fig. 9.

CATOPTRIC CISTULA

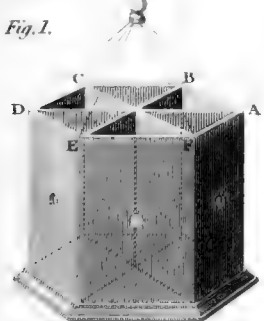


Fig. 1.

CATOPTRICS and DIOPTRICS



Fig. 1.

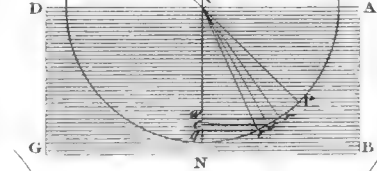
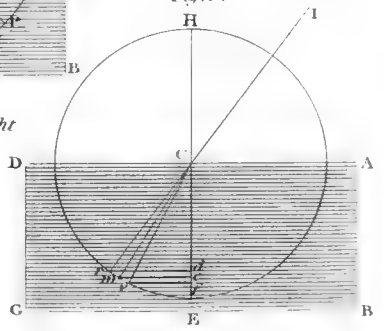


Fig. 7.

Fig. 6.



DISPERSION of Light

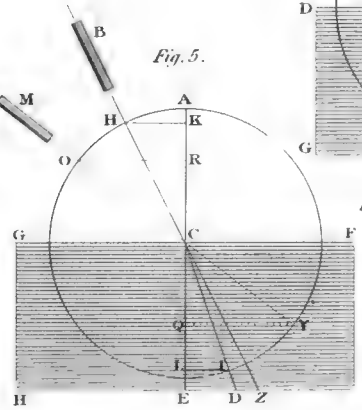


Fig. 5.

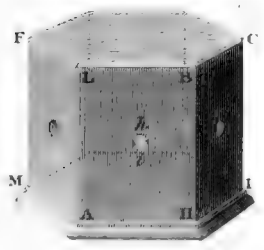


Fig. 2.



GRINDING.

Virtual FOCUS.

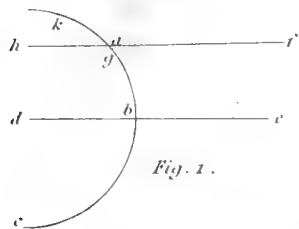


Fig. 1.

Fig. 2.

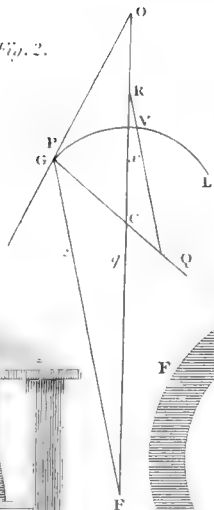


Fig. 7.

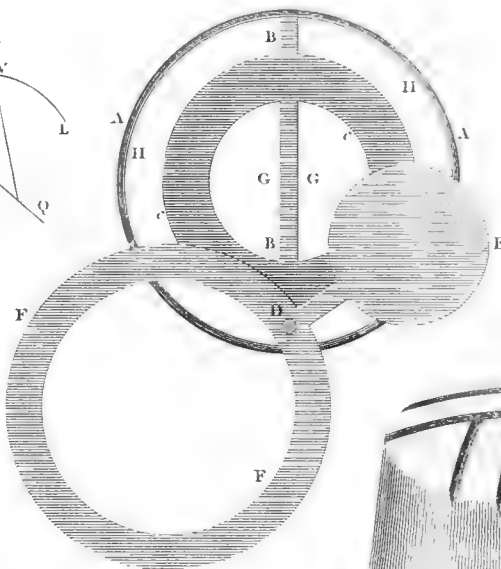


Fig. 4.

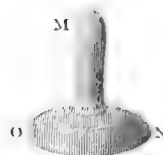


Fig. 3.

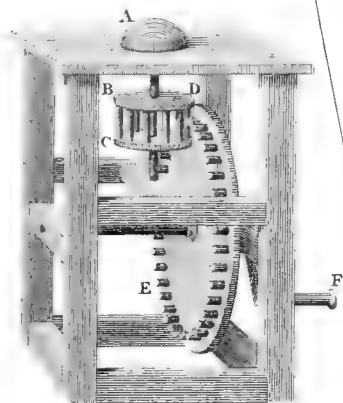


Fig. 6.

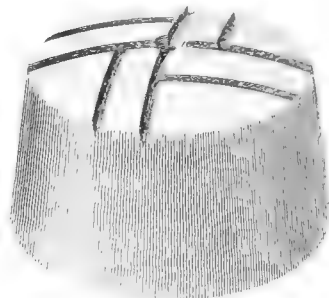
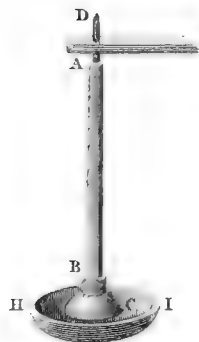


Fig. 5.



OPTICS.

LENS.

Fig. 5.

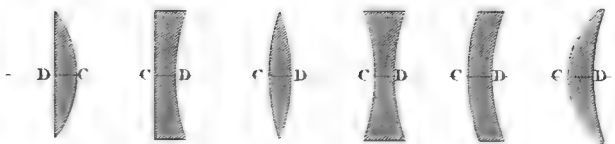


Fig. 6.

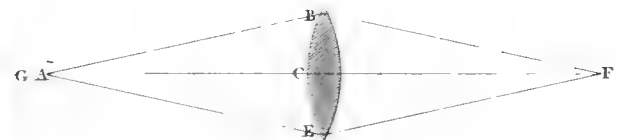


Fig. 7.

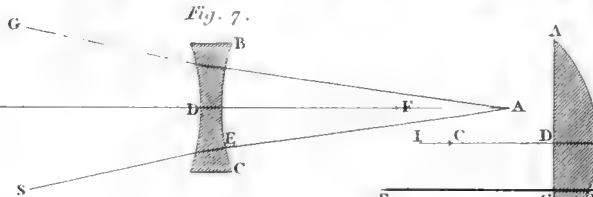


Fig. 8.

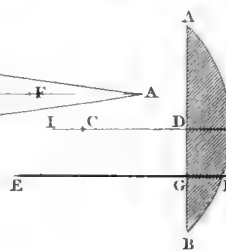


Fig. 9.

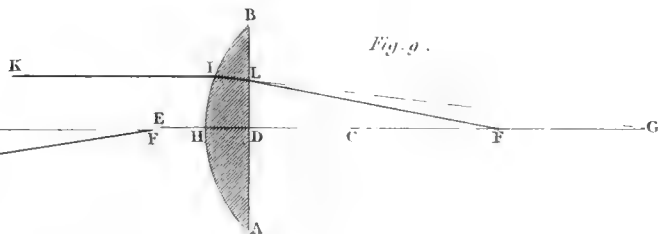


Fig. 10.

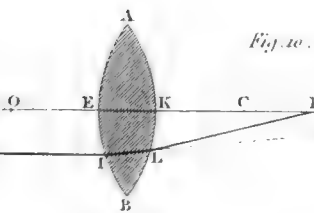
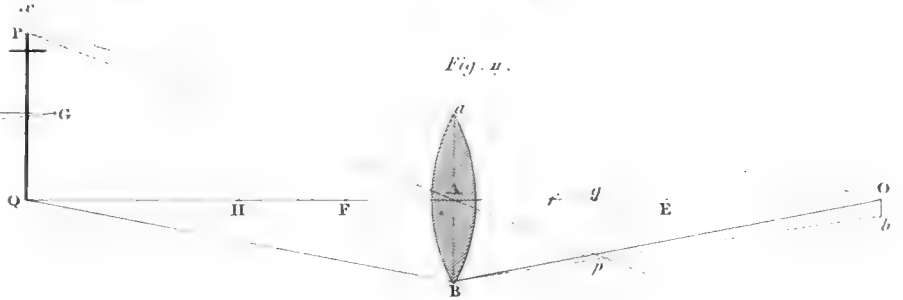


Fig. 11.



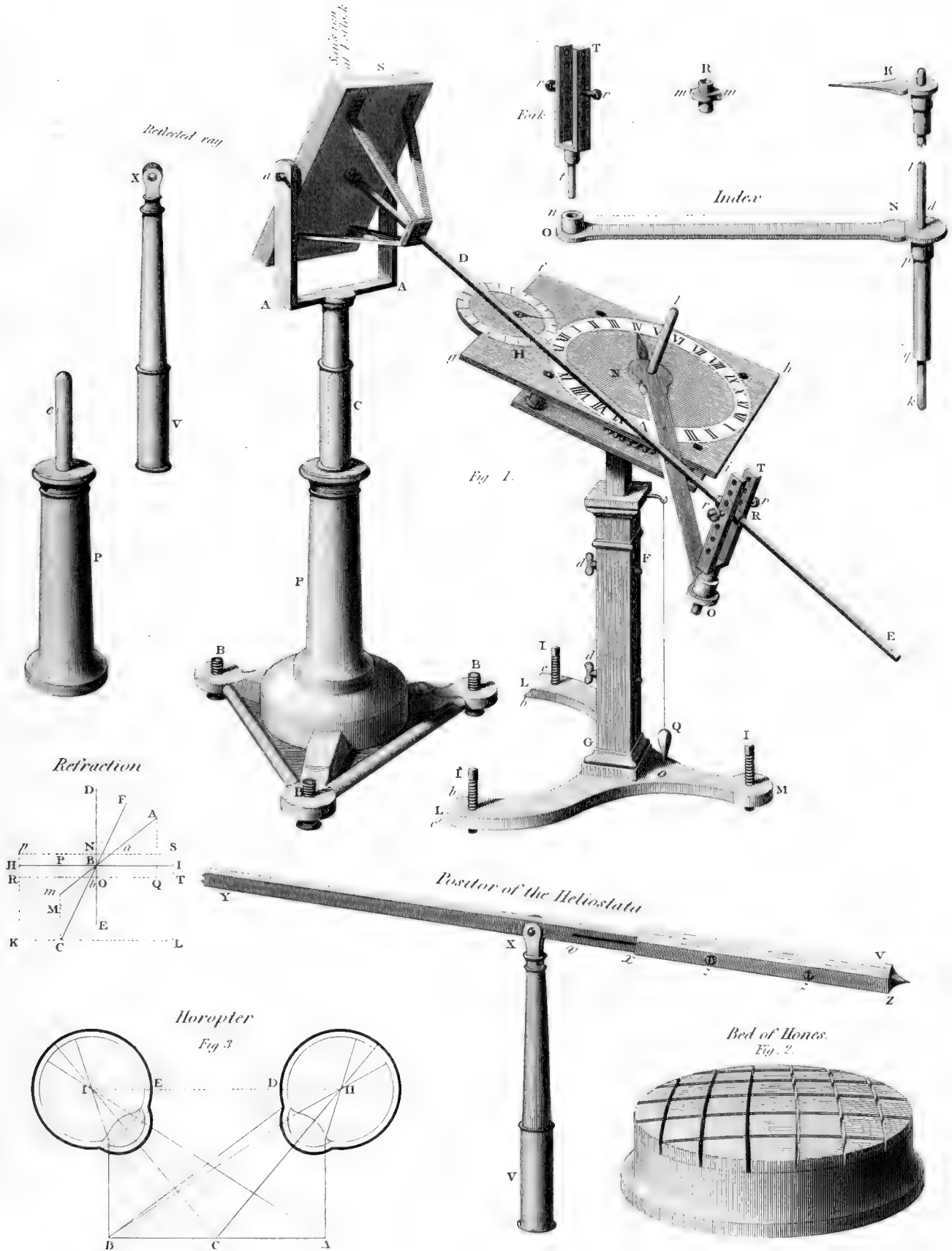


Fig. 1.

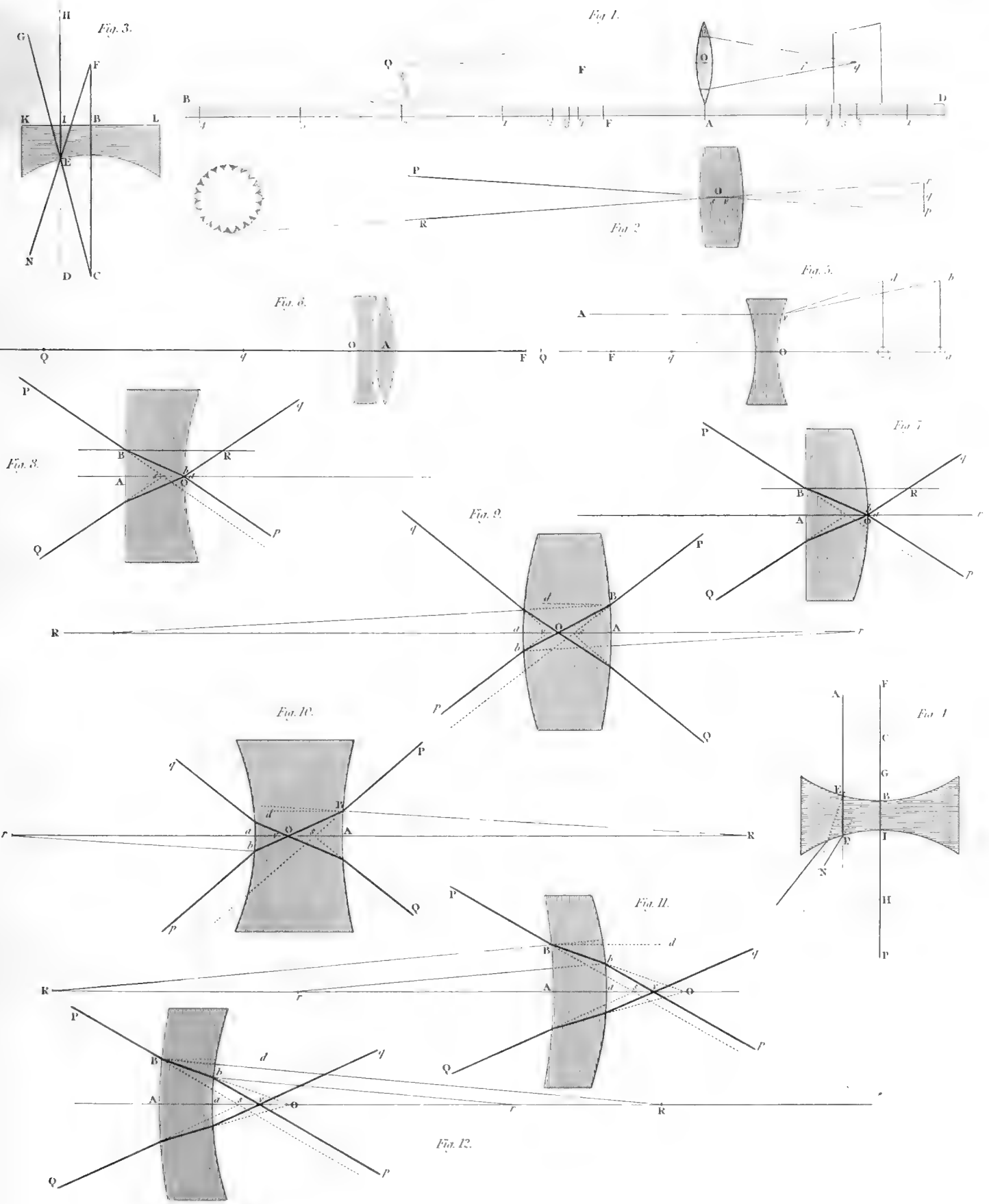
Postior of the Heliostata

Bed of Nones.
Fig. 2.

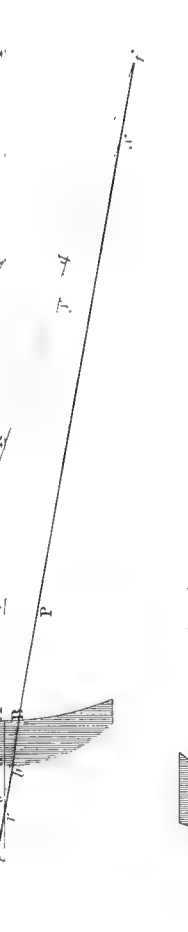
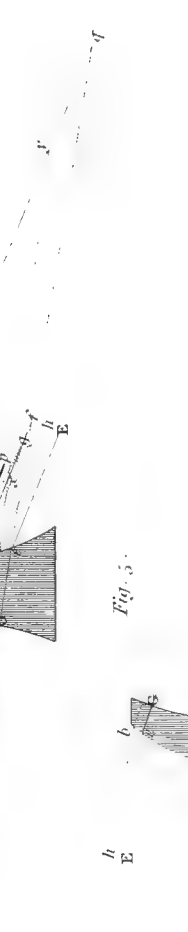
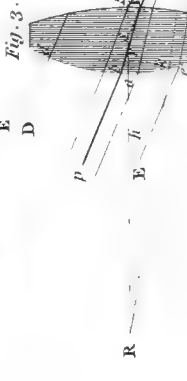
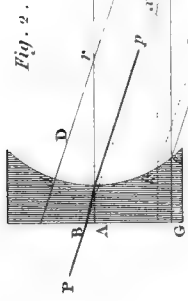
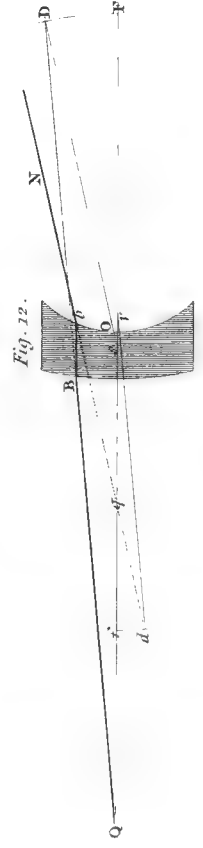
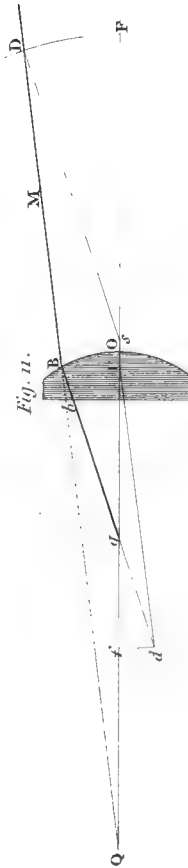
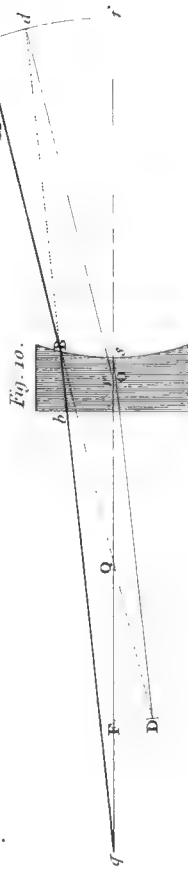
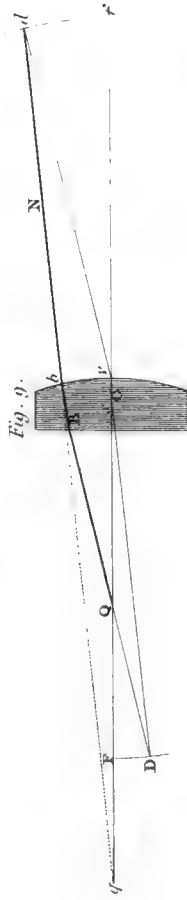
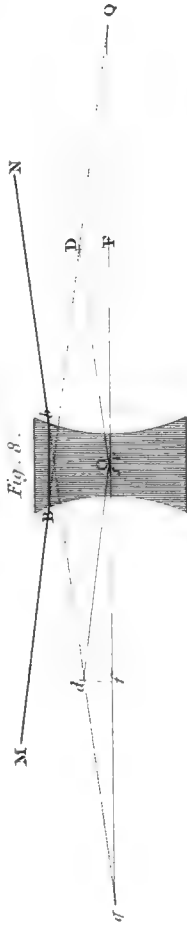
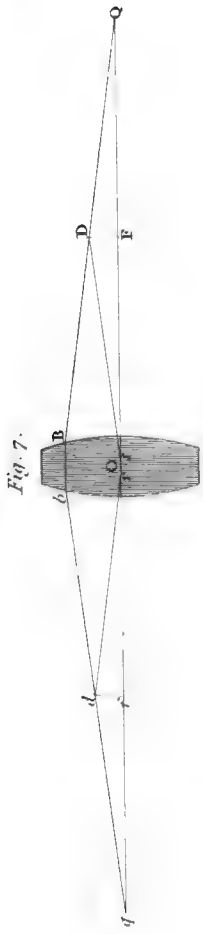
Heliometer
Fig. 3.

Retraction

Refracted ray



LENS.



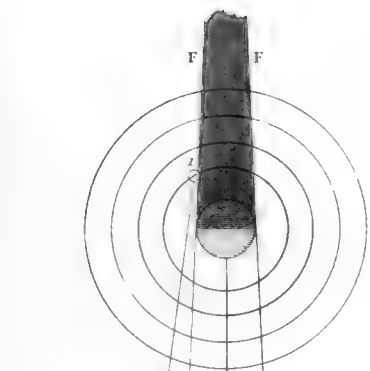


Fig. 1.

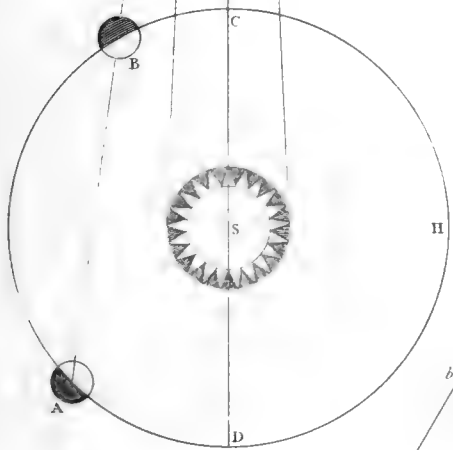


Fig. 2.

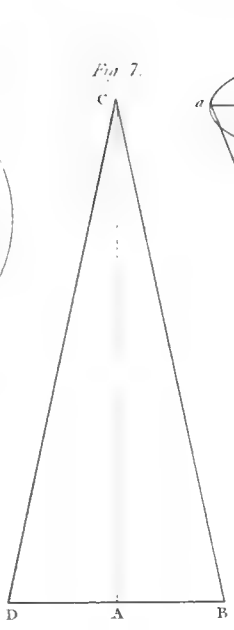


Fig. 3.

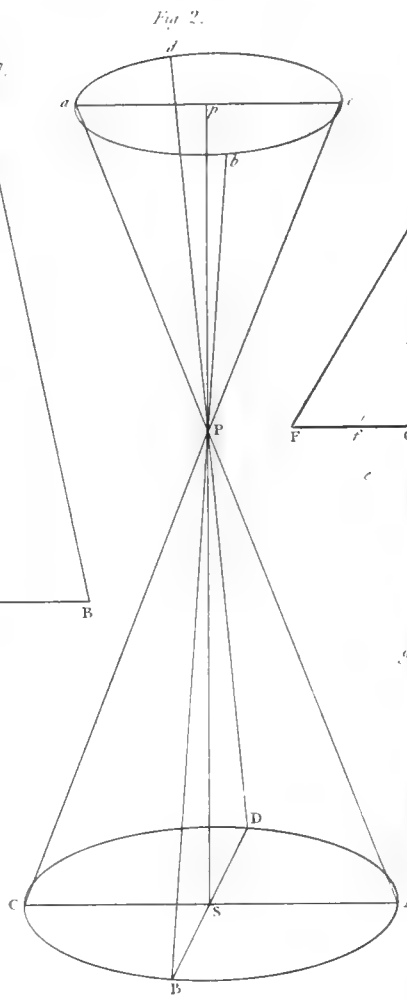


Fig. 4.

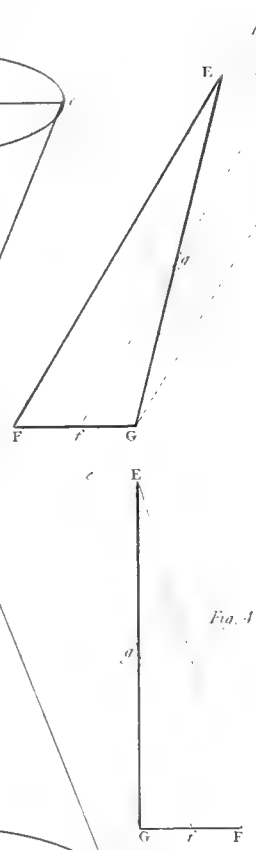


Fig. 5.

Fig. 6.

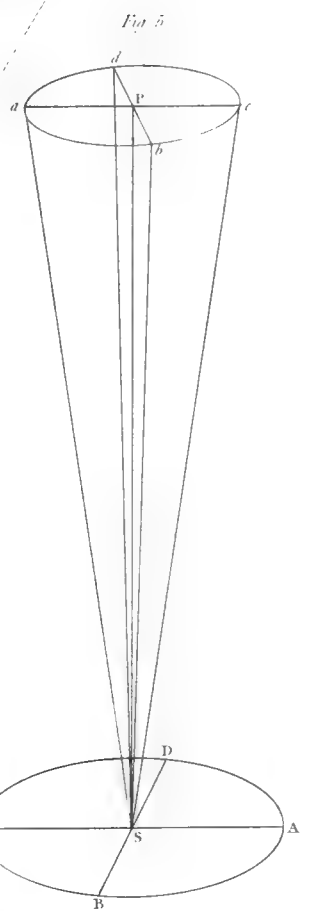


Fig. 7.

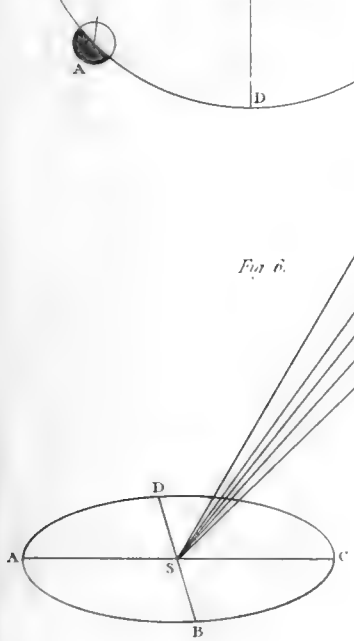


Fig. 8.

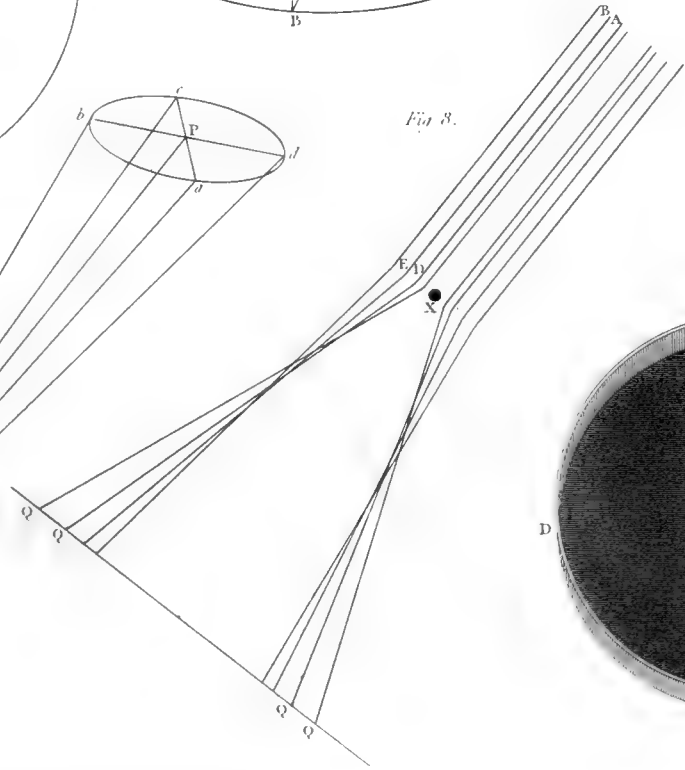


Fig. 9.

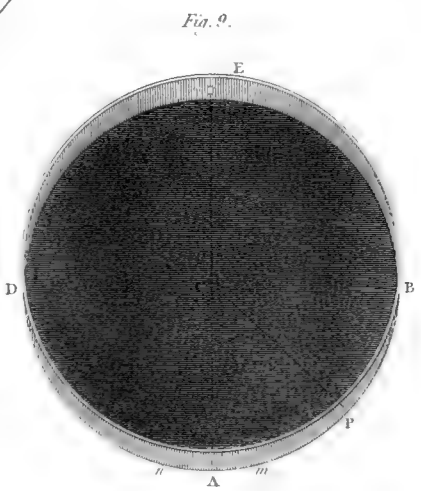


Fig. 10.



Fig. 1.

Magic Lantern.

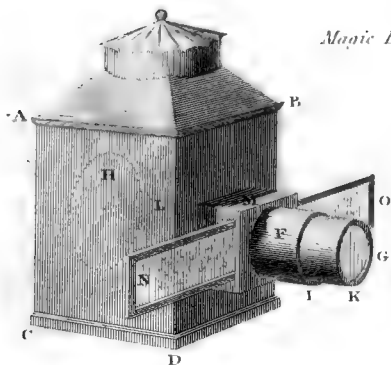


Fig. 2.

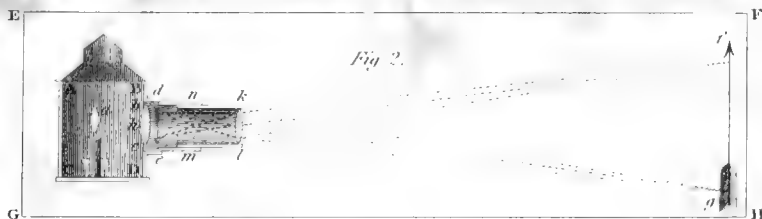
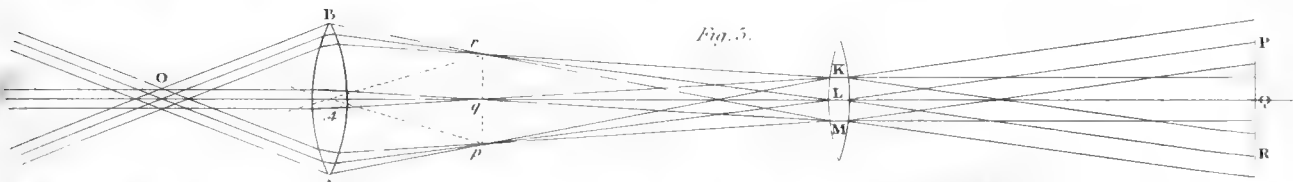
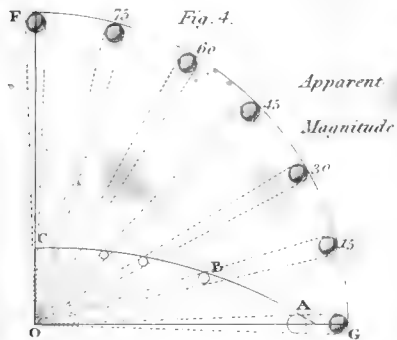


Fig. 5.



MICROMETER.

Fig. 4.



Apparent Magnitude

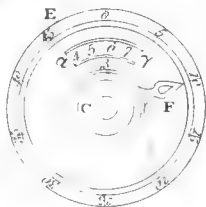


Fig. 8.

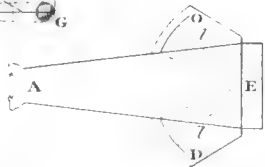
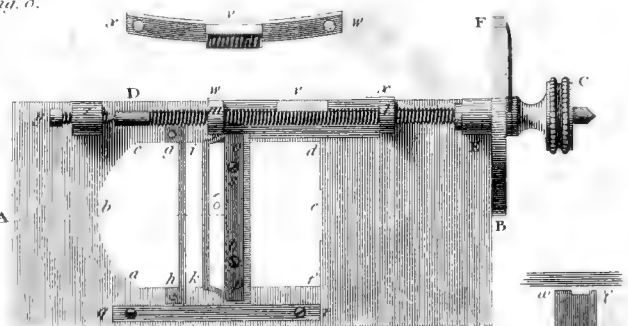


Fig. 3.

Fig. 6.

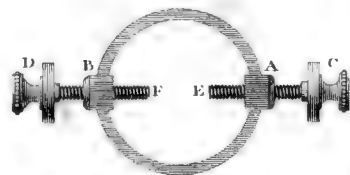


Fig. 7.

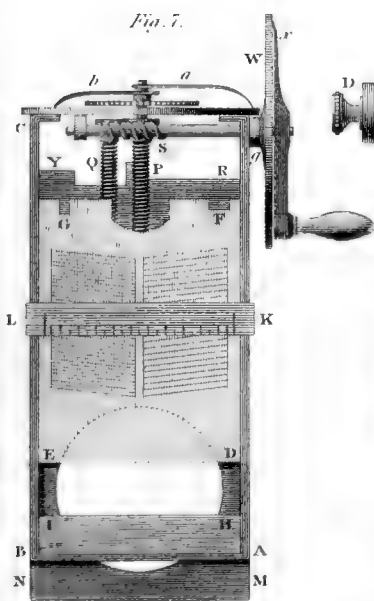


Fig. 9.

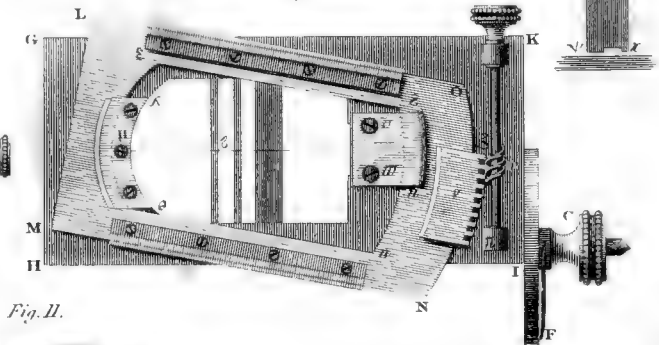


Fig. 11.

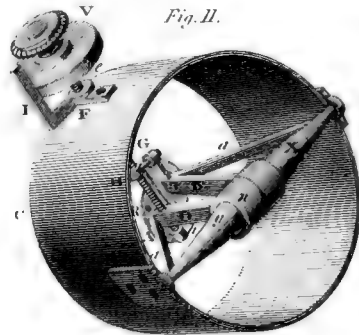
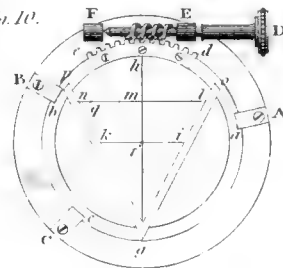


Fig. 10.

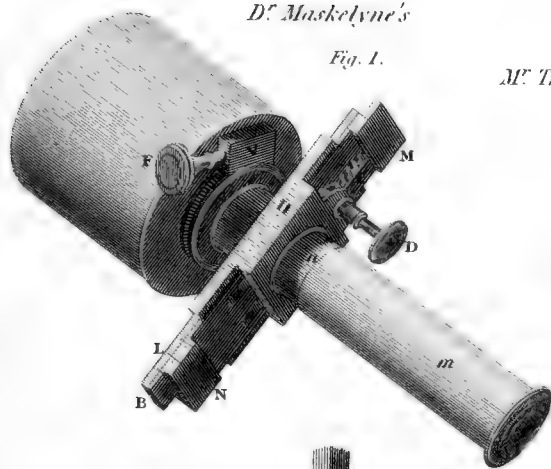




MICROMETER.

D. Maskelyne's

Fig. 1.



M. Troughton's

Fig. 2.

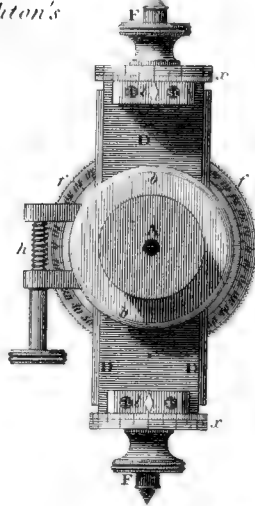


Fig. 3.

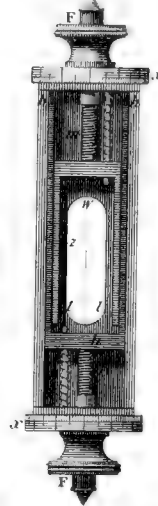
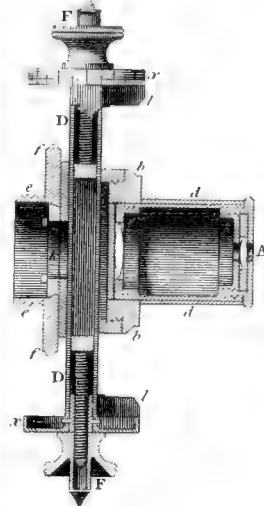


Fig. 4.



D. Herschel's Lamp Micrometer.

Fig. 5.

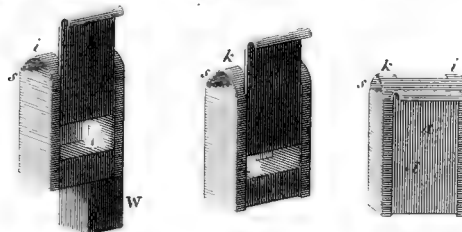
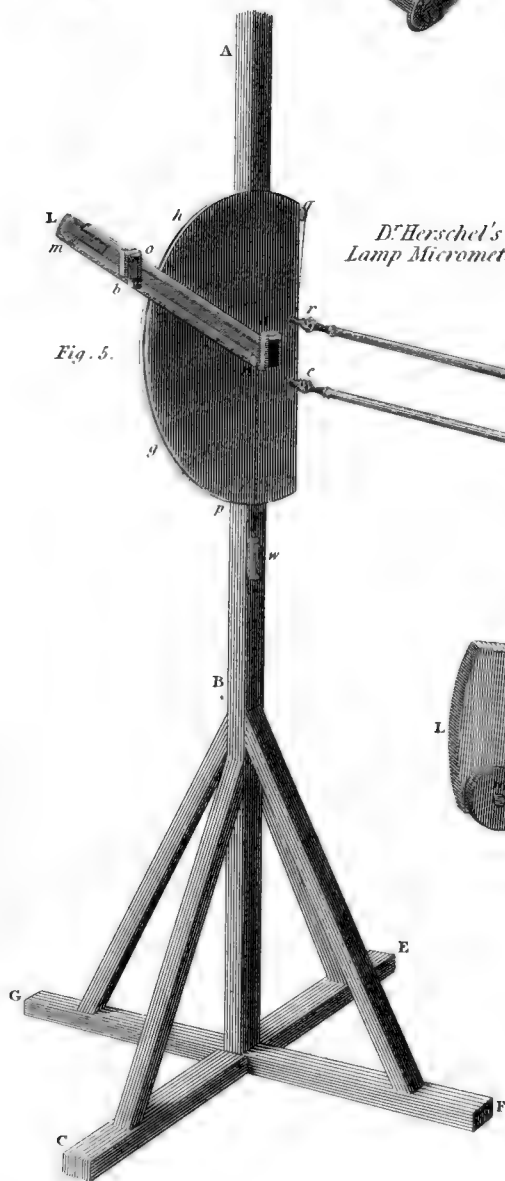


Fig. 6.

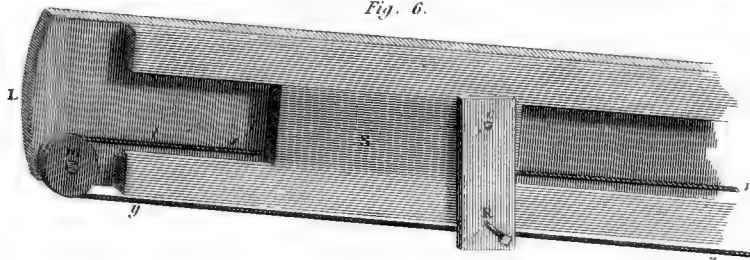
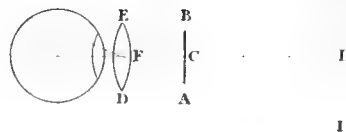


Fig. 10.



OPTICS.
MICROSCOPE Single.

Fig. 1.

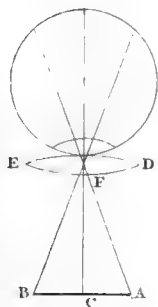


Fig. 3.

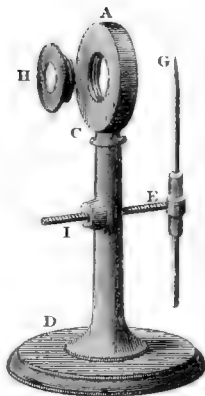


Fig. 2.

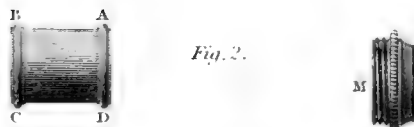


Fig. 4.

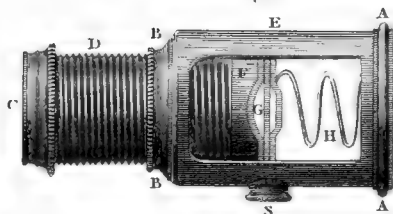
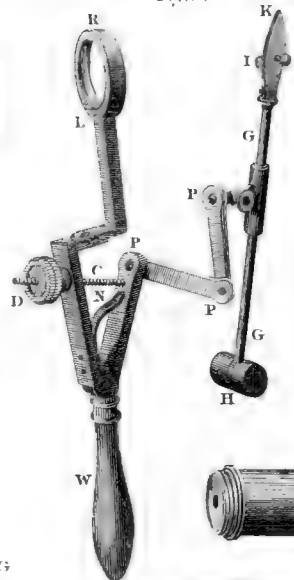


Fig. 5.



K H I

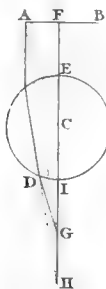


Fig. 6.

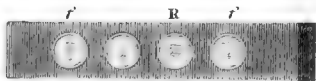


Fig. 12.

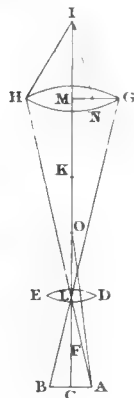


Fig. 7.



Fig. 10.

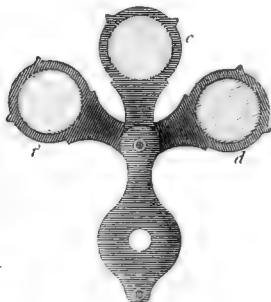


Fig. 9.

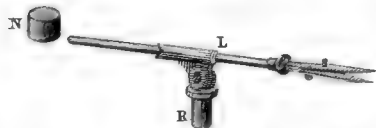
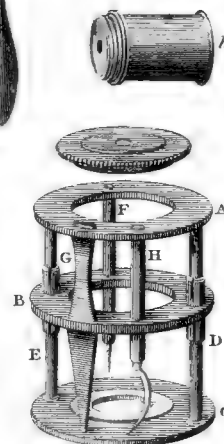


Fig. 8.

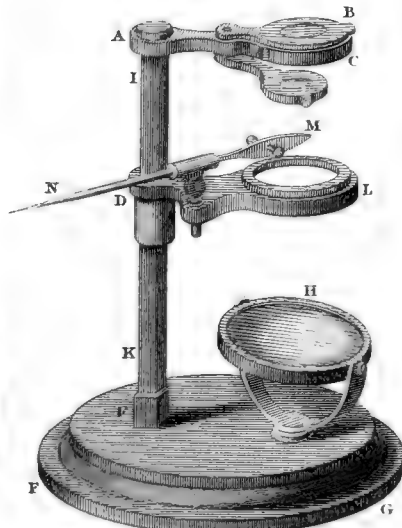
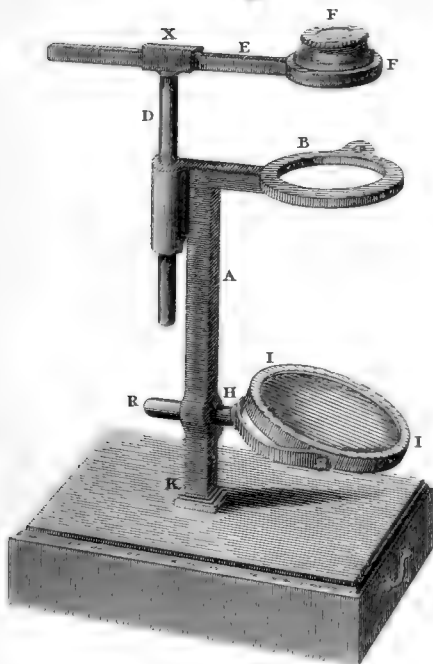
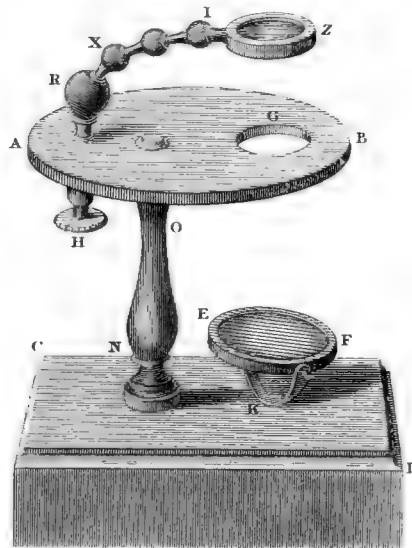


Fig. 11.





OPTICS.
MICROSCOPES.

Marshall's.
Fig. 1.

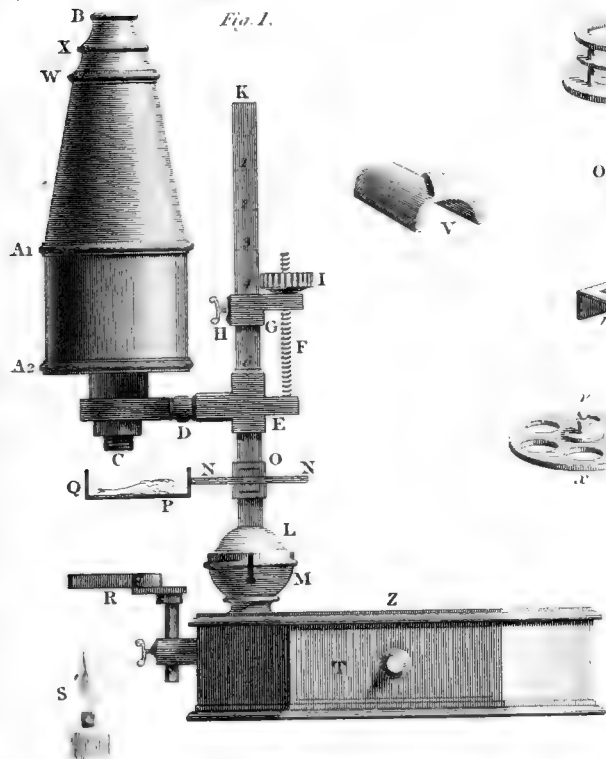
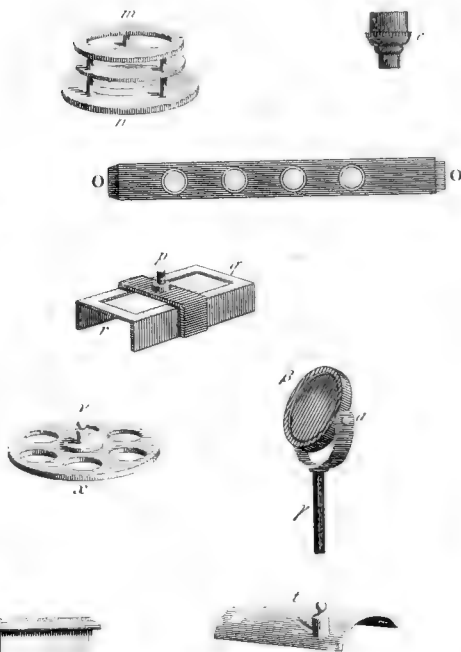


Fig. 2



Gullpepper's.

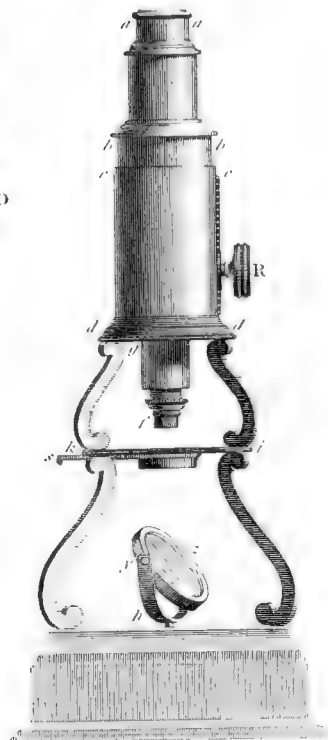


Fig. 4

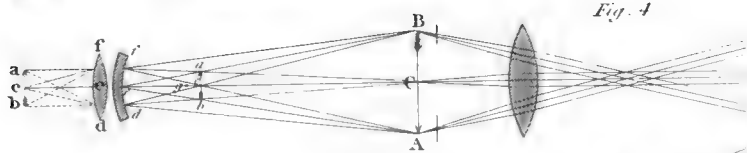


Fig. 3.

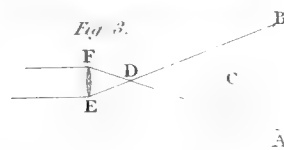
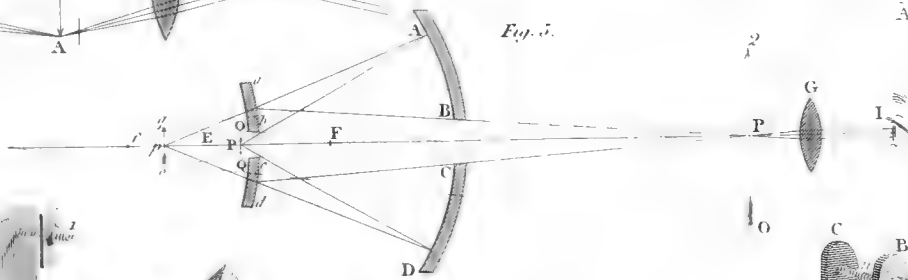


Fig. 5.



Solar Microscope.
Fig. 6.

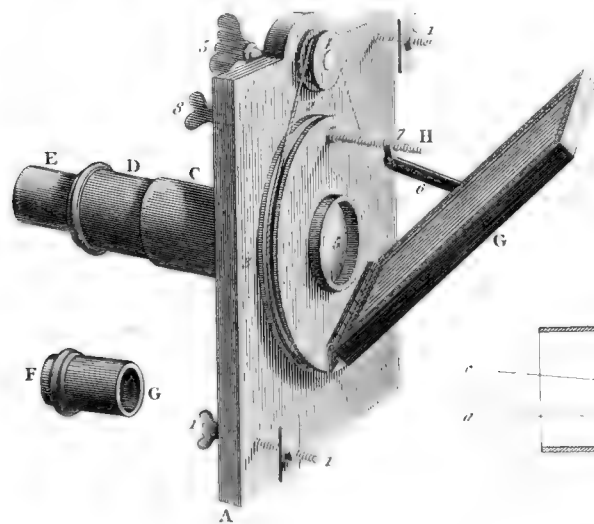


Fig. 8.

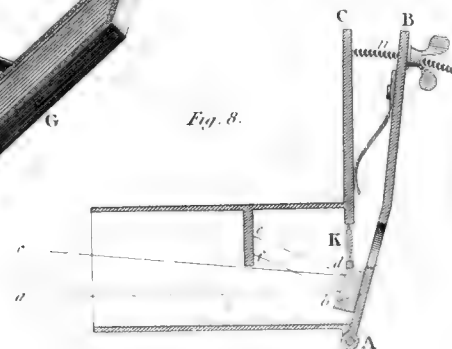
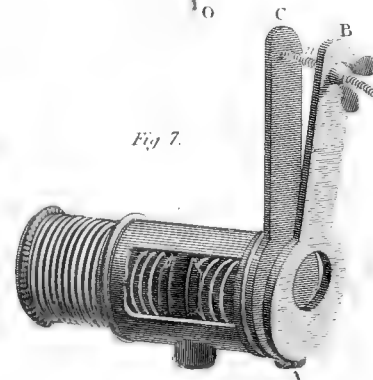
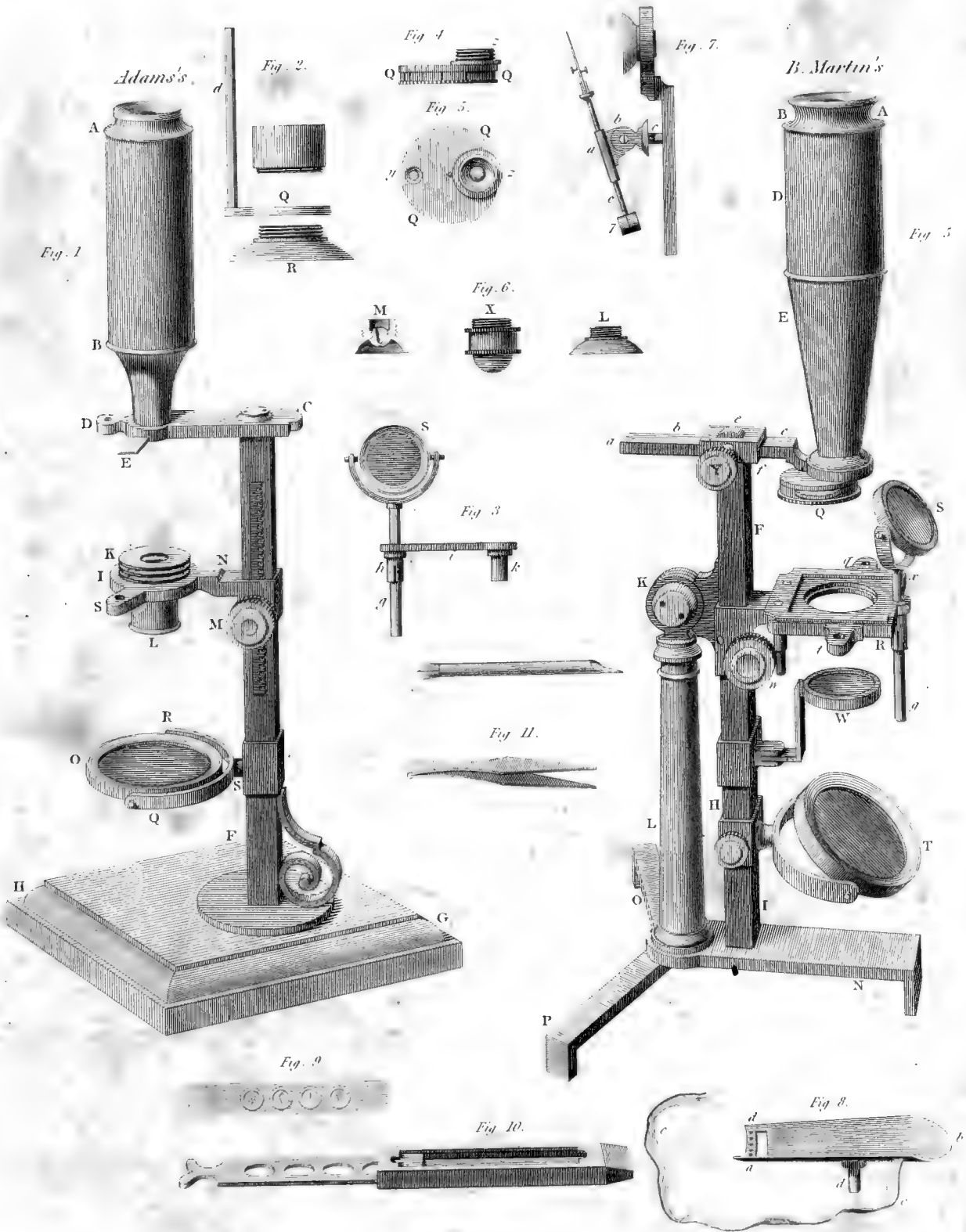


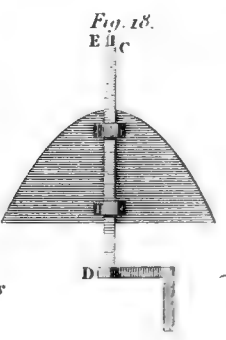
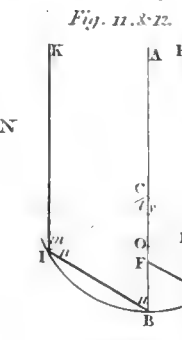
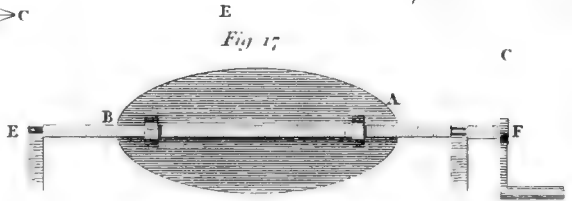
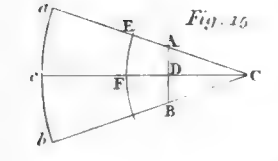
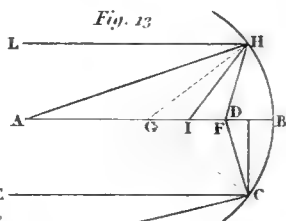
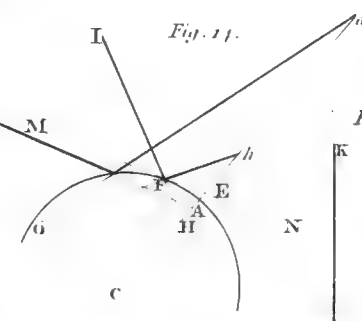
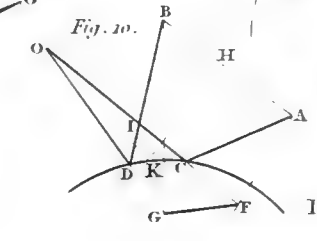
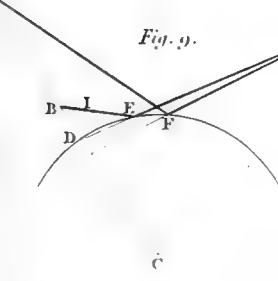
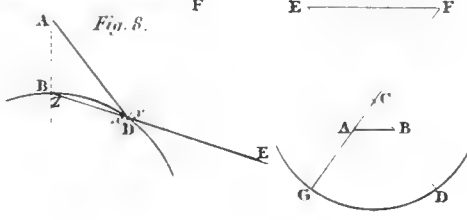
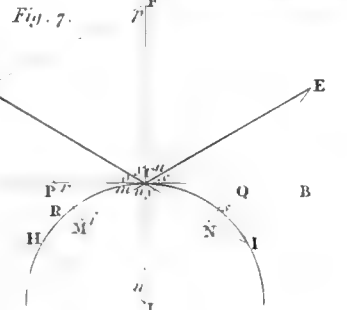
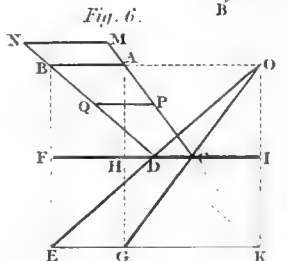
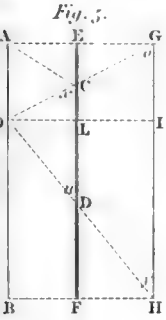
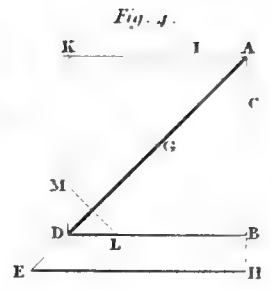
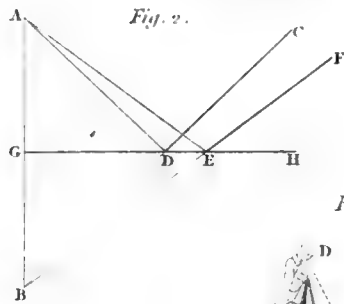
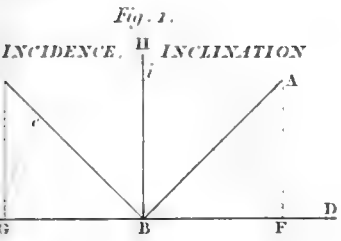
Fig. 7.



OPTICS.
Compound MICROSCOPE.

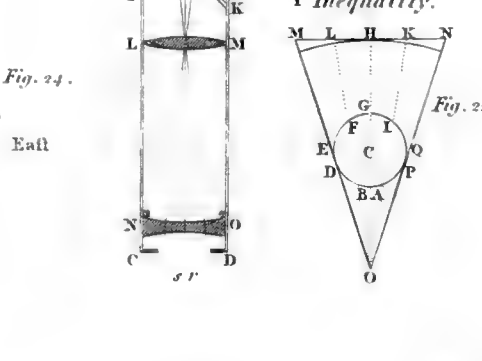
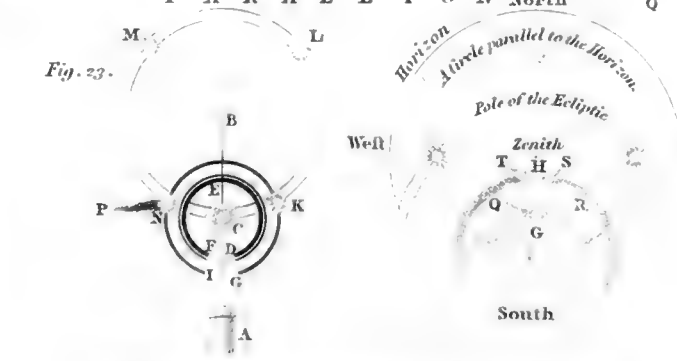
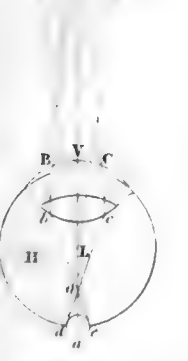
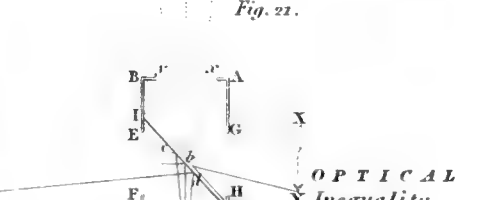
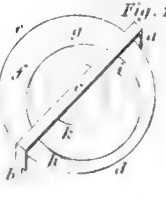
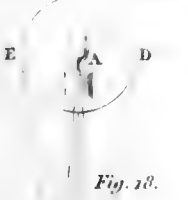






USCÆ Volitantes.

Centering OBJECT Glass.





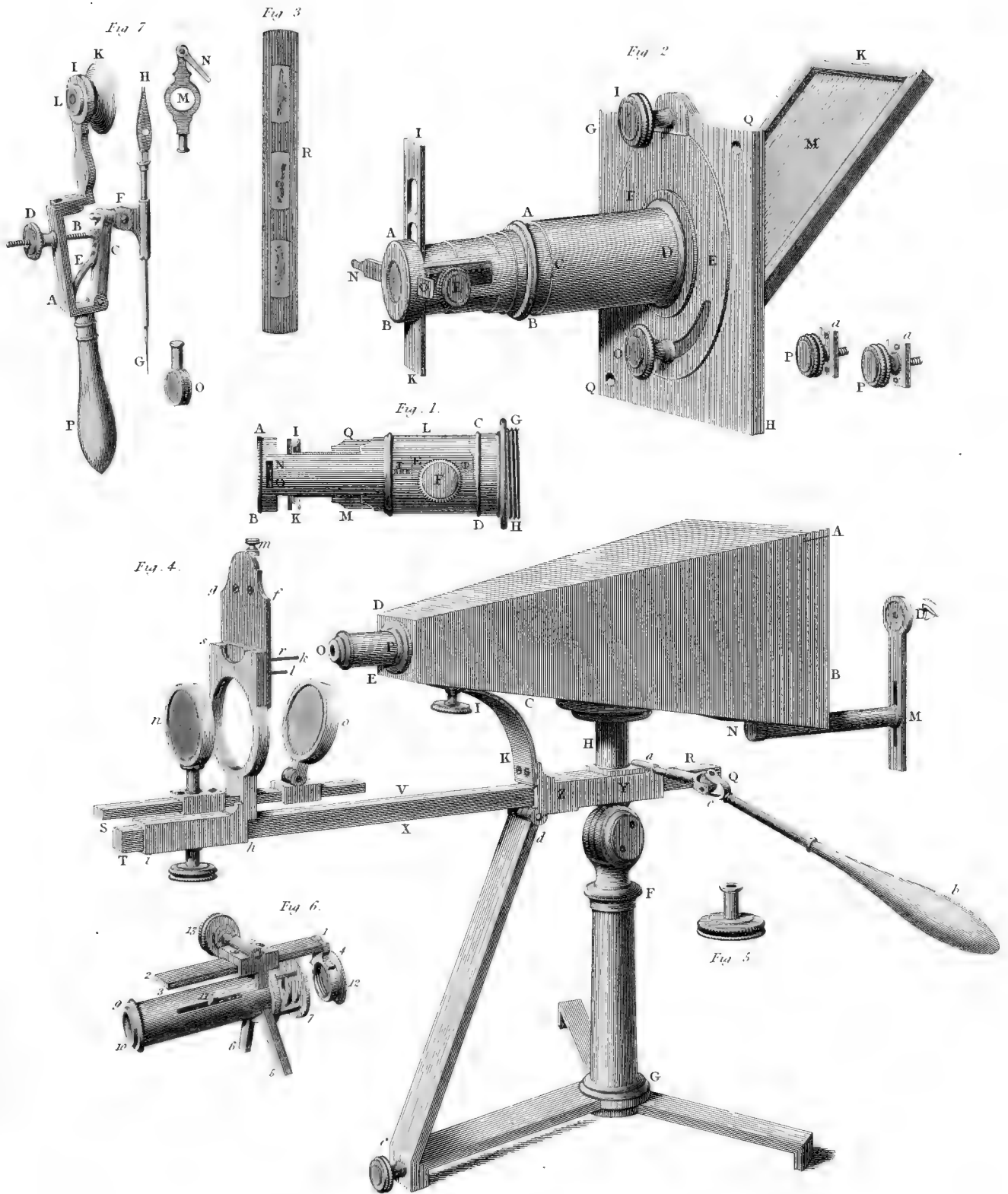


Fig. 5.

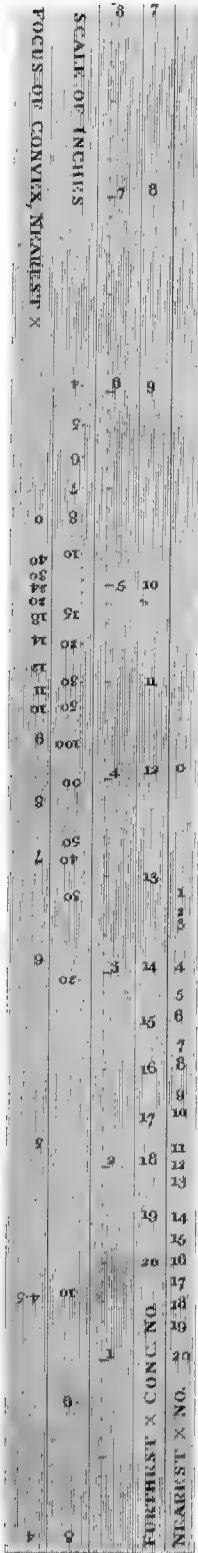


Fig. 1.

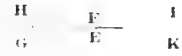


Fig. 2.

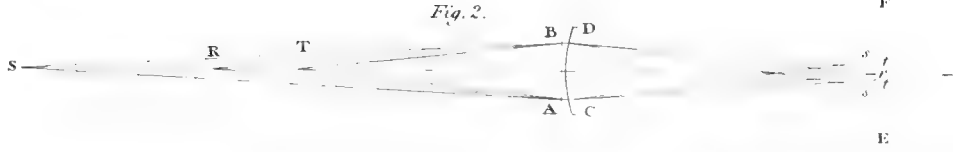


Fig. 3.

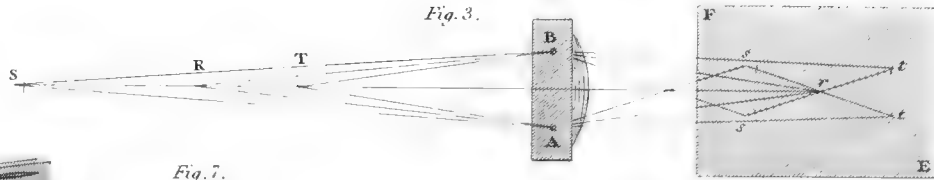


Fig. 7.

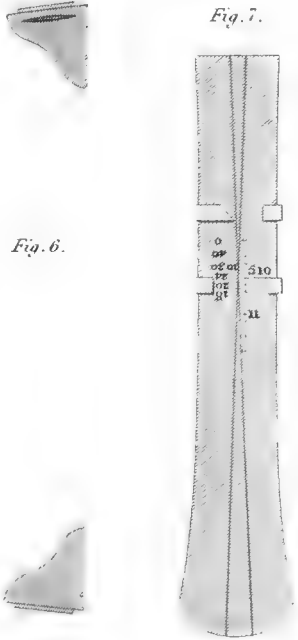


Fig. 6.



Fig. 9.

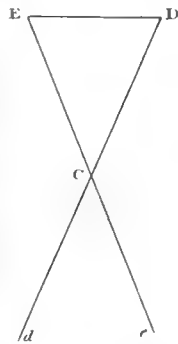


Fig. 13.

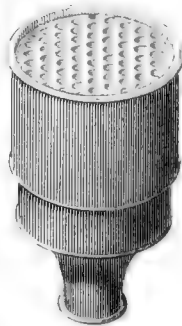


Fig. 10.

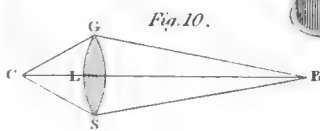


Fig. 11.

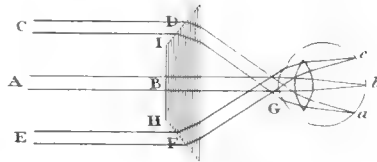


Fig. 12.

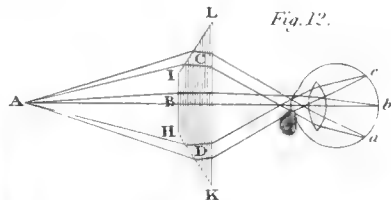


Fig. 4.

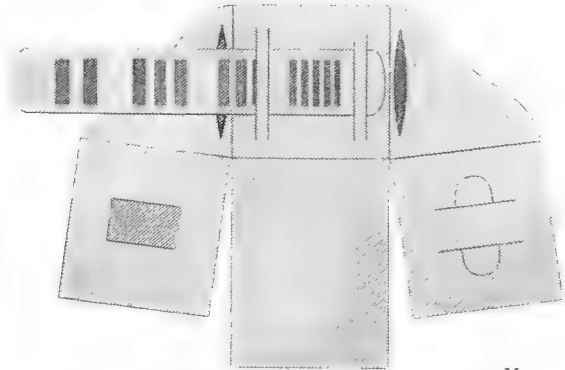


Fig. 12.

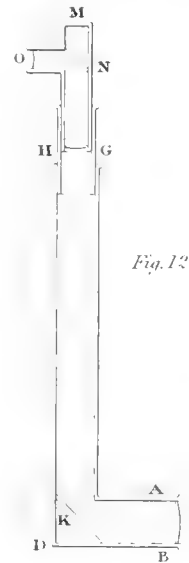


Fig. 15.

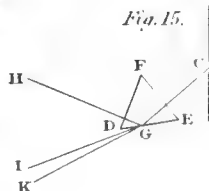
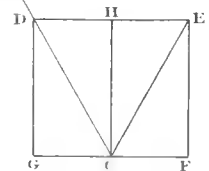


Fig. 14.





R Fig. 1.

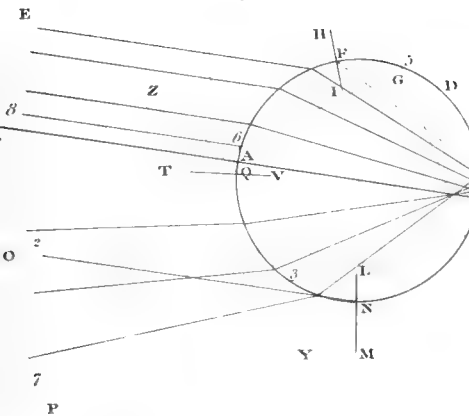


Fig. 2.

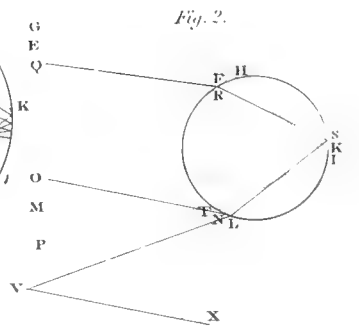


Fig. 4.

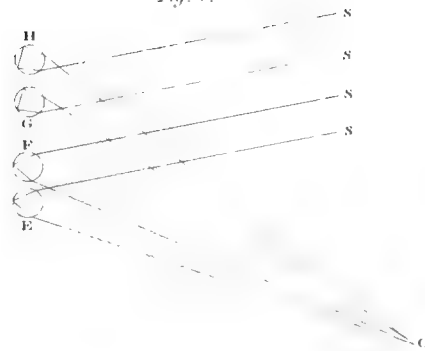


Fig. 6.

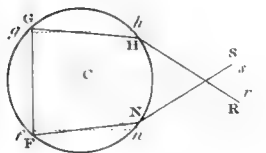


Fig. 7.

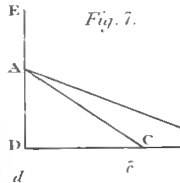


Fig. 3.

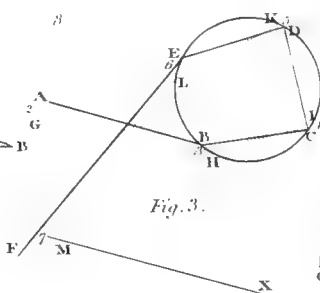


Fig. 8.

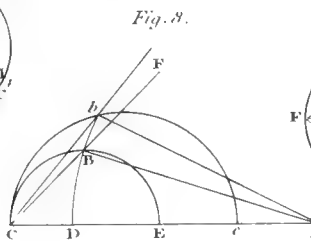


Fig. 5.

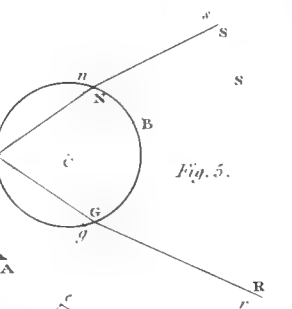


Fig. 11.

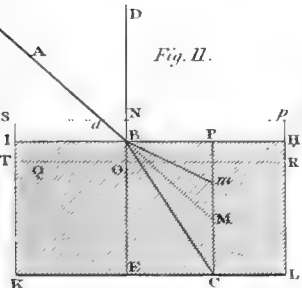


Fig. 10.

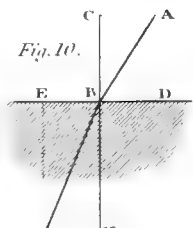


Fig. 9.

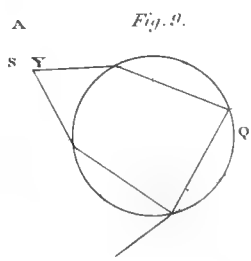


Fig. 12.

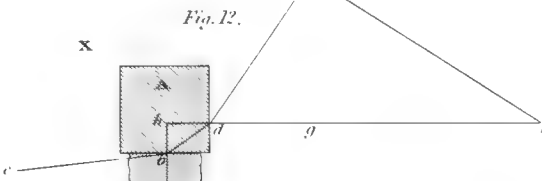


Fig. 13.

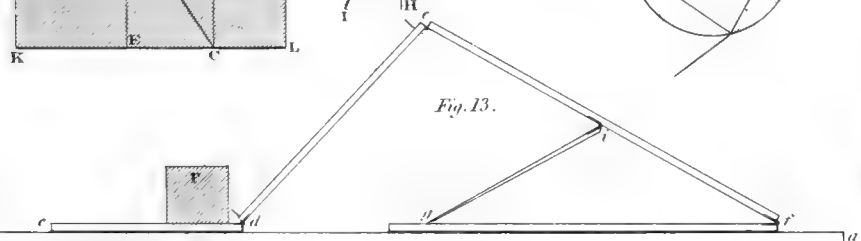


Fig. 14.

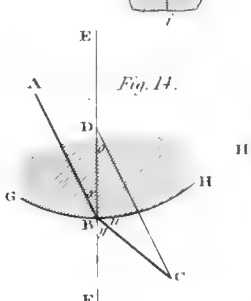


Fig. 15.

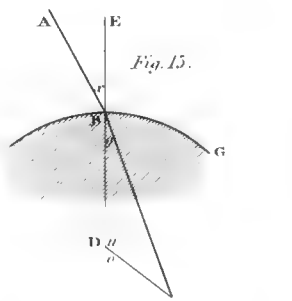


Fig. 16.

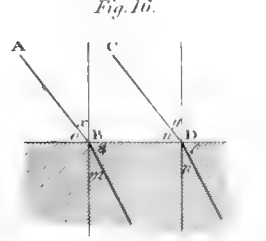


Fig. 17.

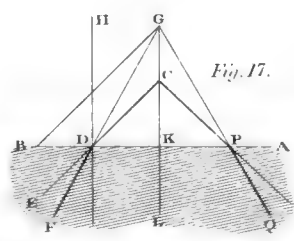


Fig. 18.

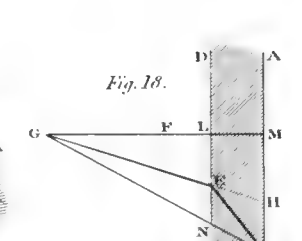


Fig. 19.

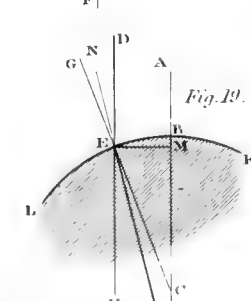


Fig. 20.

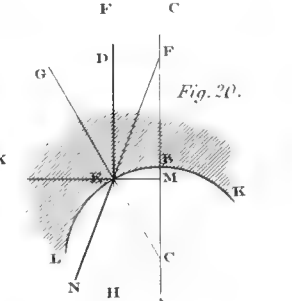


Fig. 22.

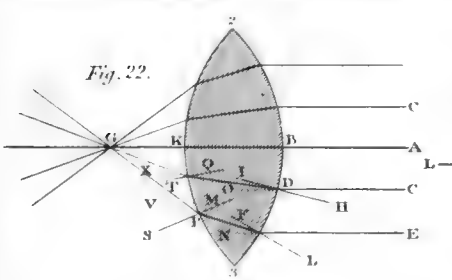


Fig. 23.

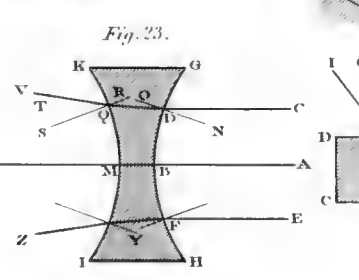


Fig. 24.

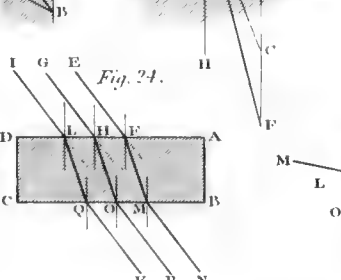


Fig. 21.

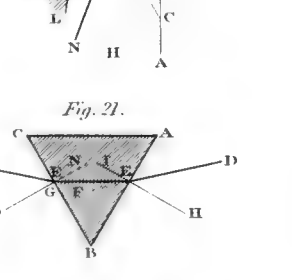


Fig. 1. & 2.

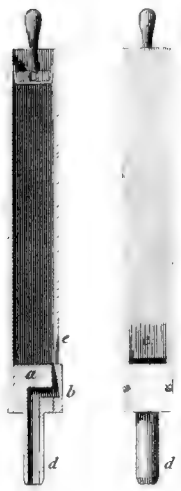


Fig. 3. & 4.

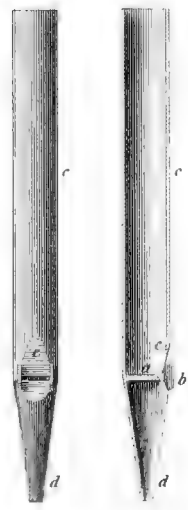


Fig. 5. & 6.

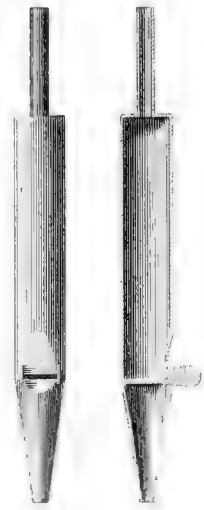


Fig. 7.



Fig. 8. & 9.

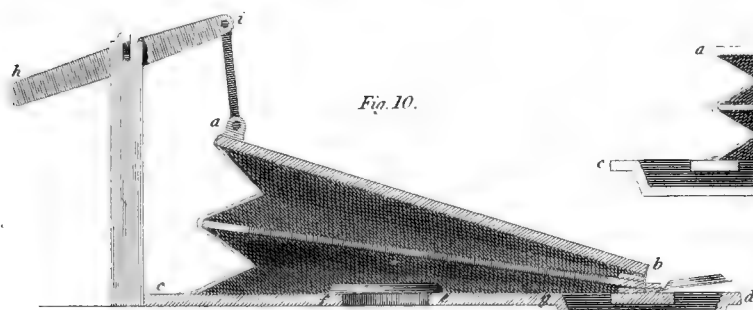
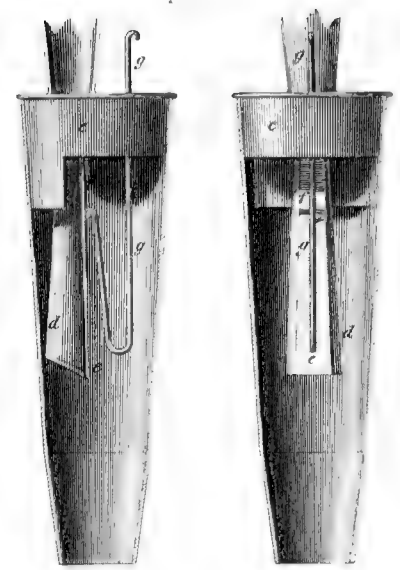


Fig. 10.

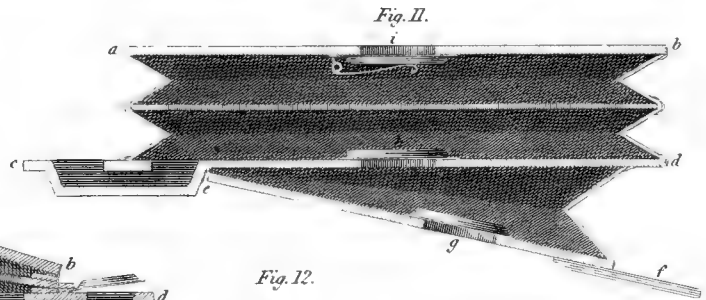


Fig. 11.

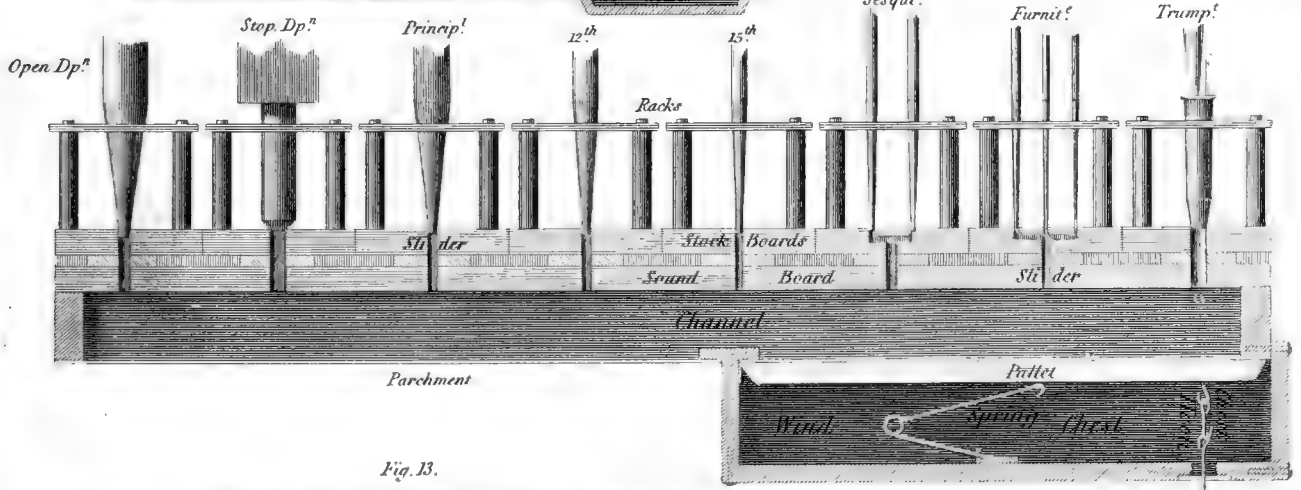
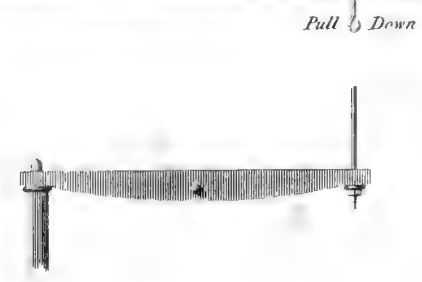
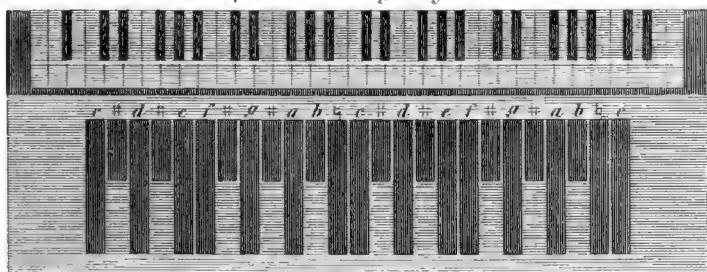


Fig. 12.

Fig. 13.

Relative position of the finger keys & Pedals.





Interior Profile of an English Church ORGAN.

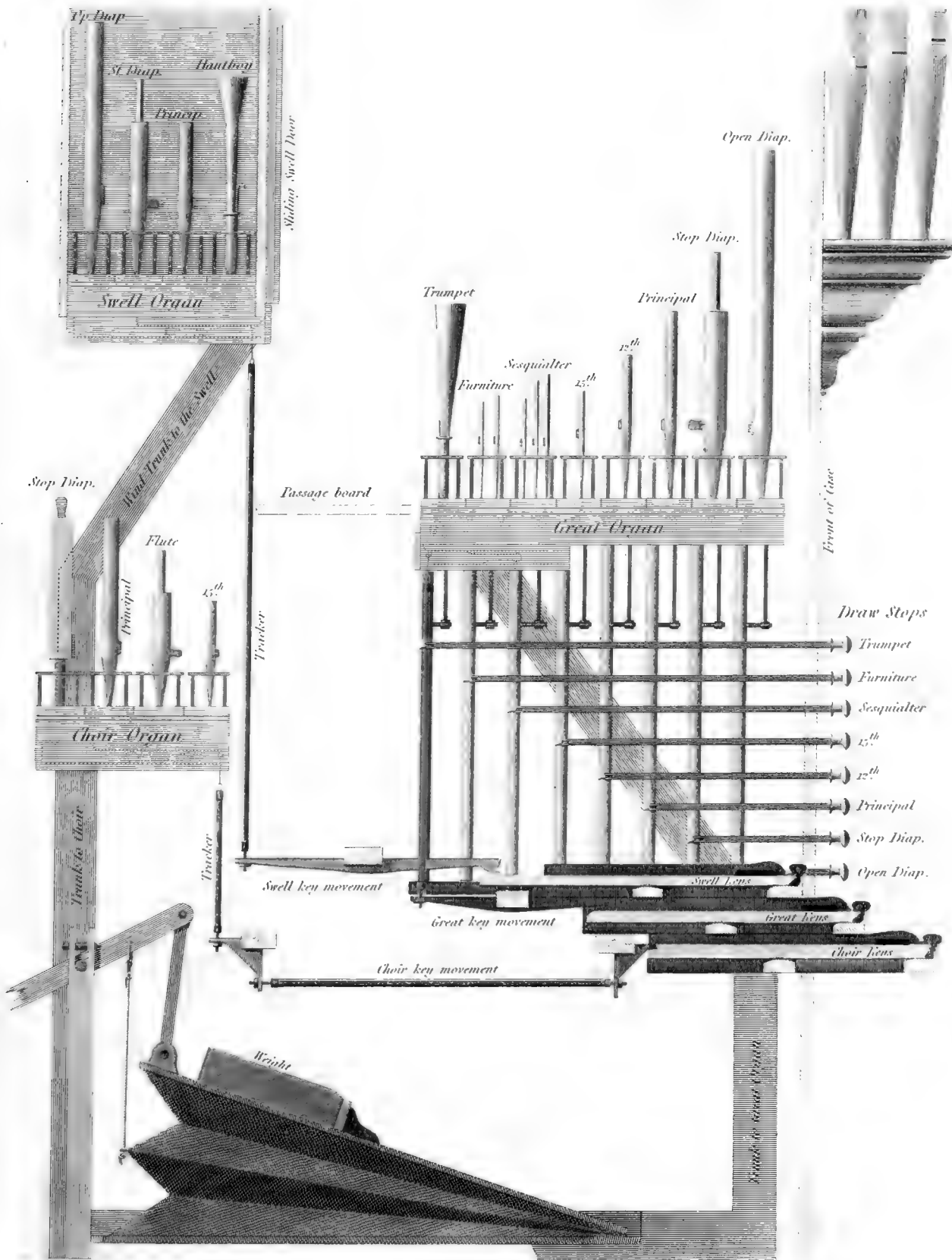




Fig. 4.

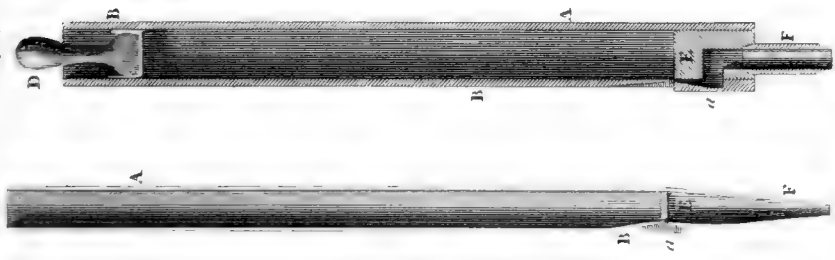


Fig. 3.



Fig. 1.

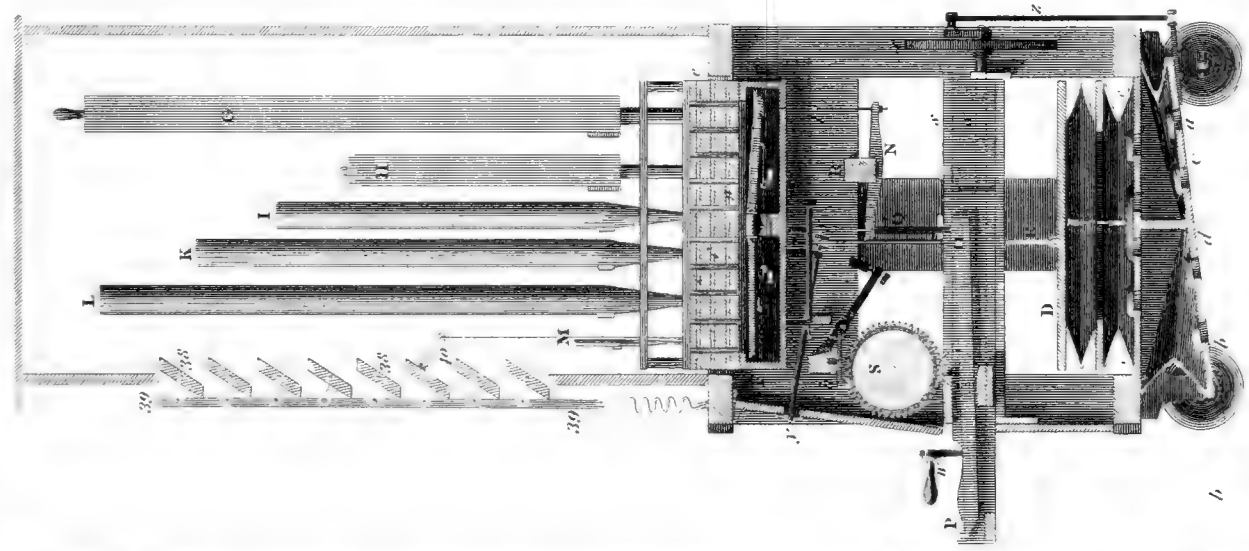


Fig. 2.

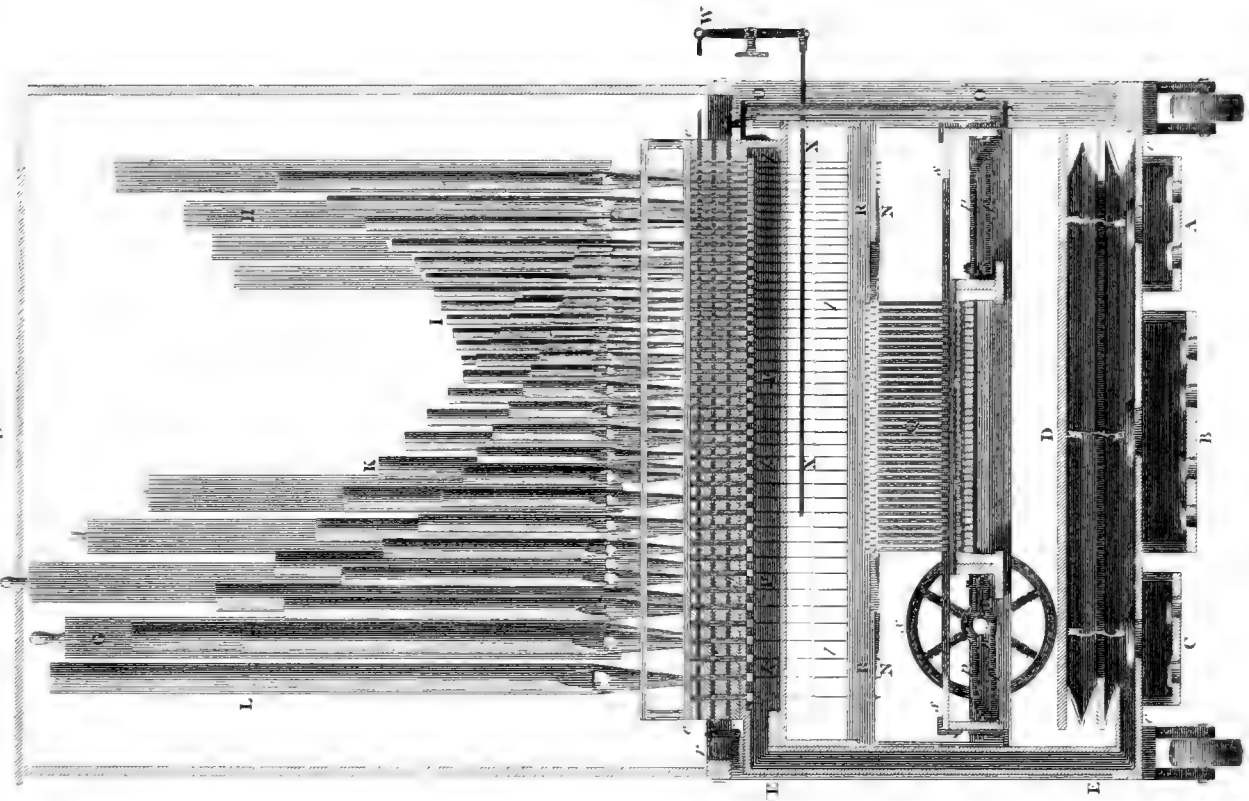
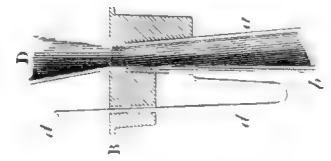


Fig. 5.



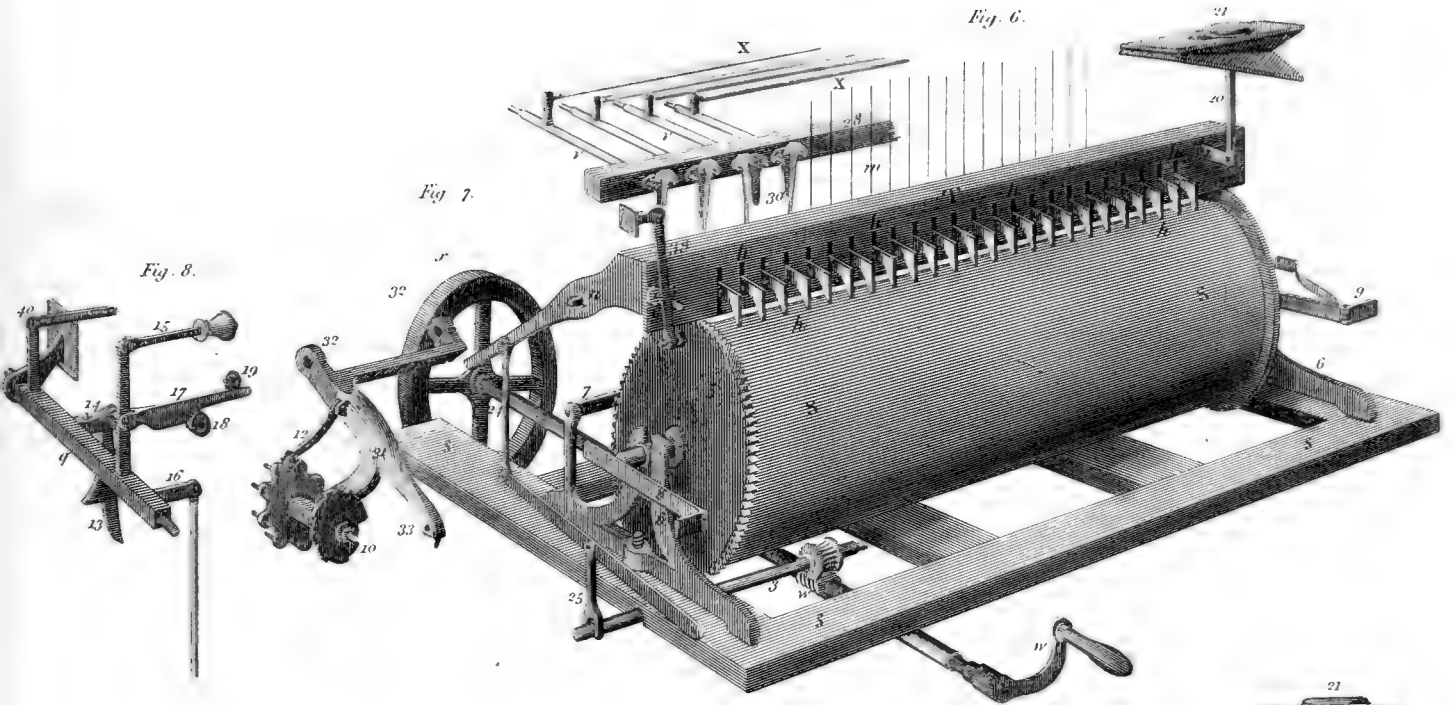


Fig. 7.

Fig. 6.

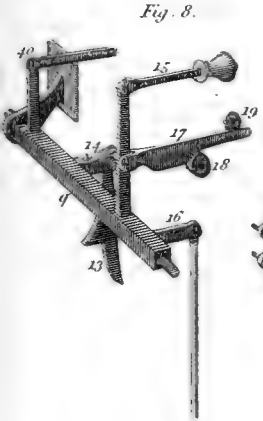


Fig. 8.

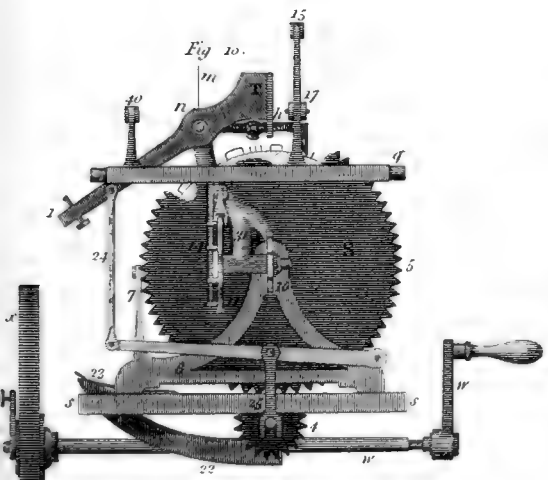


Fig. 10.

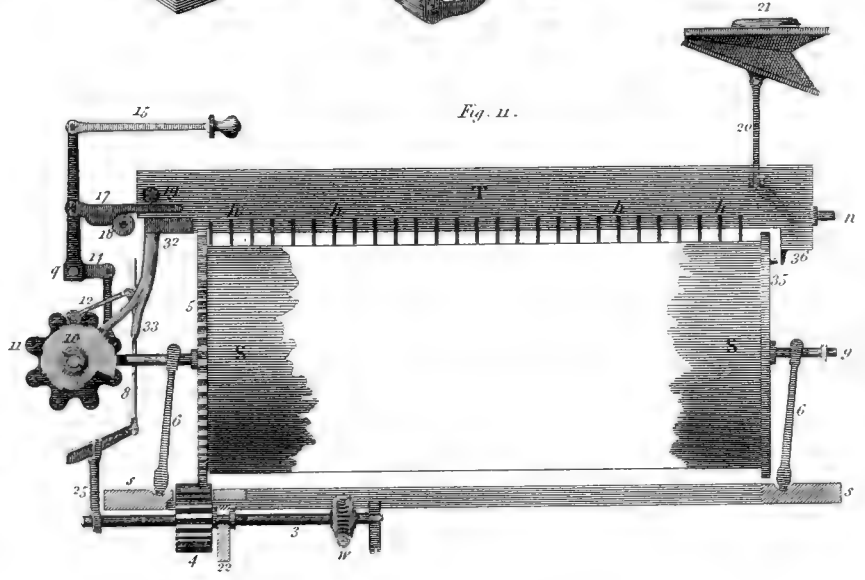


Fig. 11.

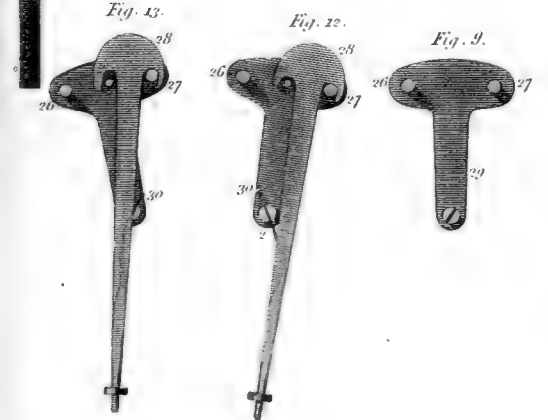


Fig. 12.

Fig. 9.

Fig. 13.

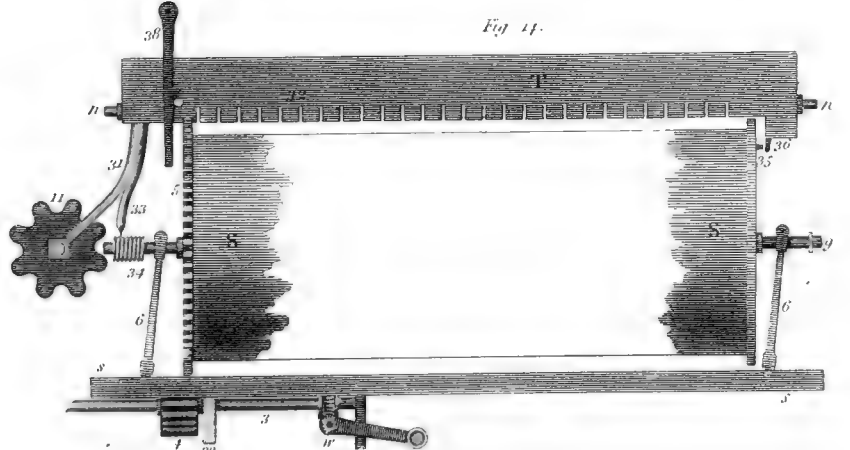


Fig. 14.



FIG. 1.



FIG. 2.

Apollo Belvidere



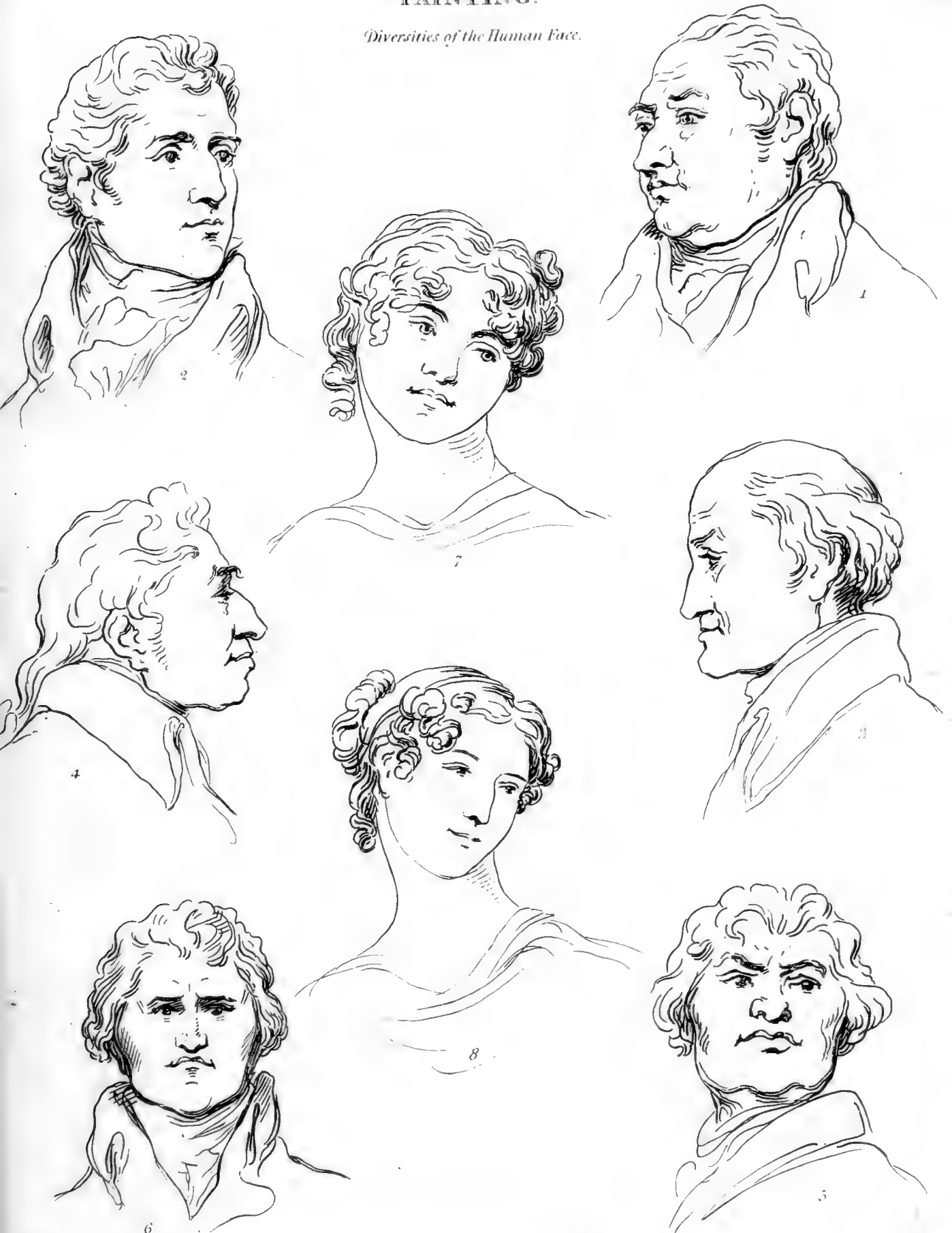
FIG. 3.

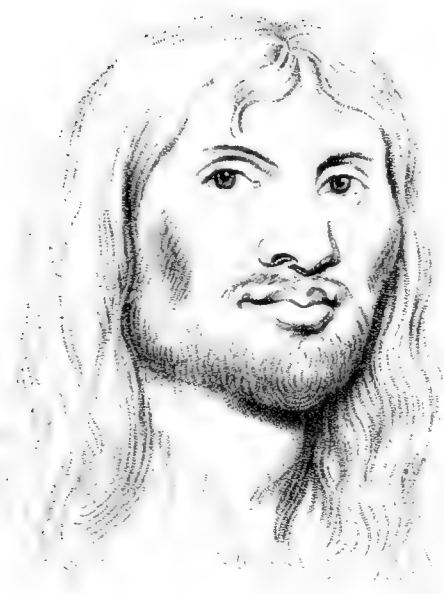


FIG. 4.

Venus de Medicis

Diversities of the Human Face.





*American
Nootka Sound*



European



*Asiatic
Palestine*



*Asiatic
Chinese*



*African
Hottentot*

Fig. 2. N° 1.

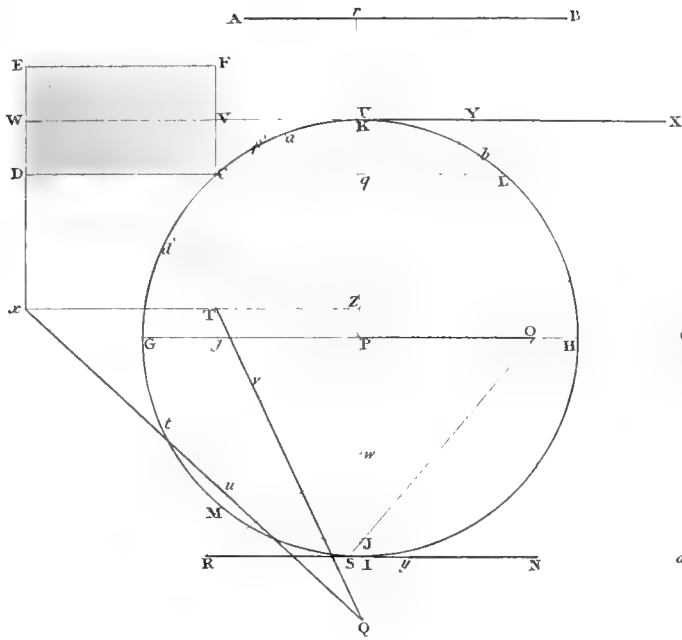


Fig. 2. N° 5.

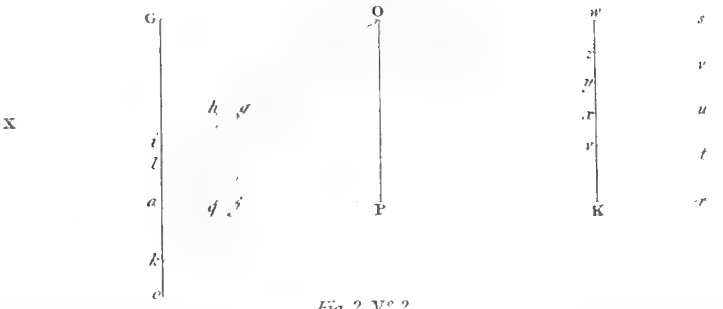


Fig. 2. N° 2.

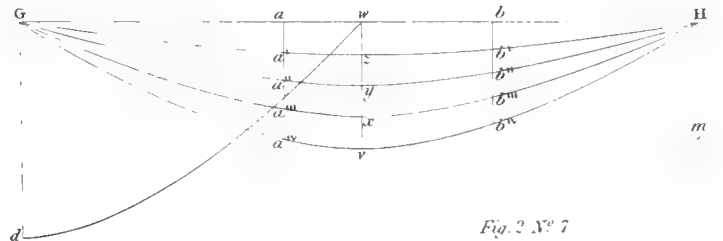


Fig. 2. N° 7.

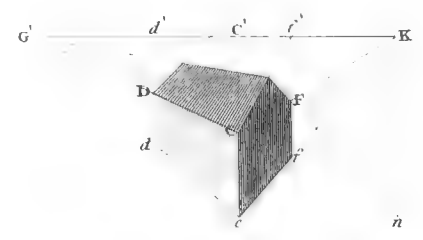


Fig. 1.

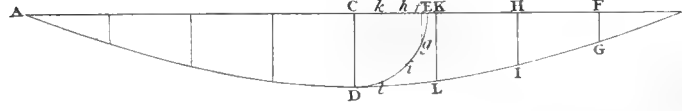


Fig. 3.

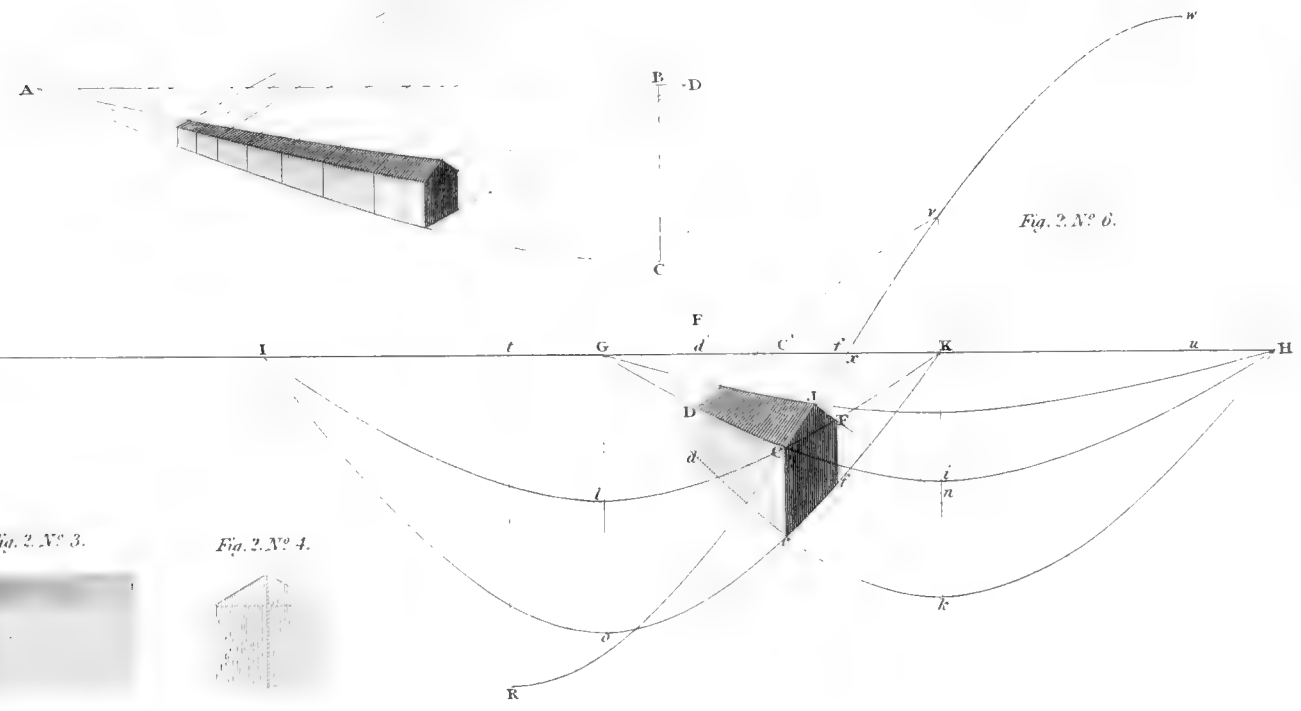
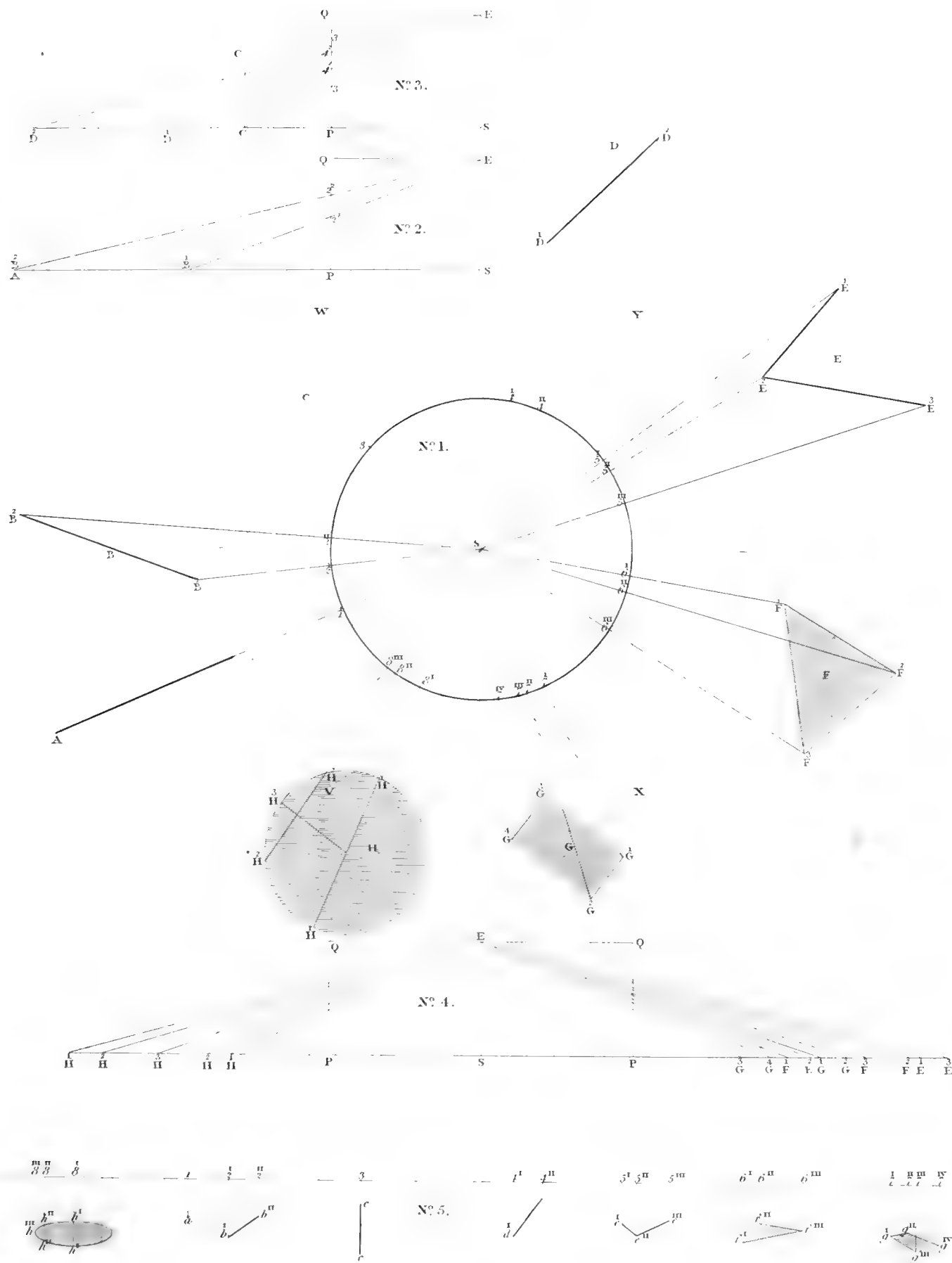


Fig. 2. N° 3.

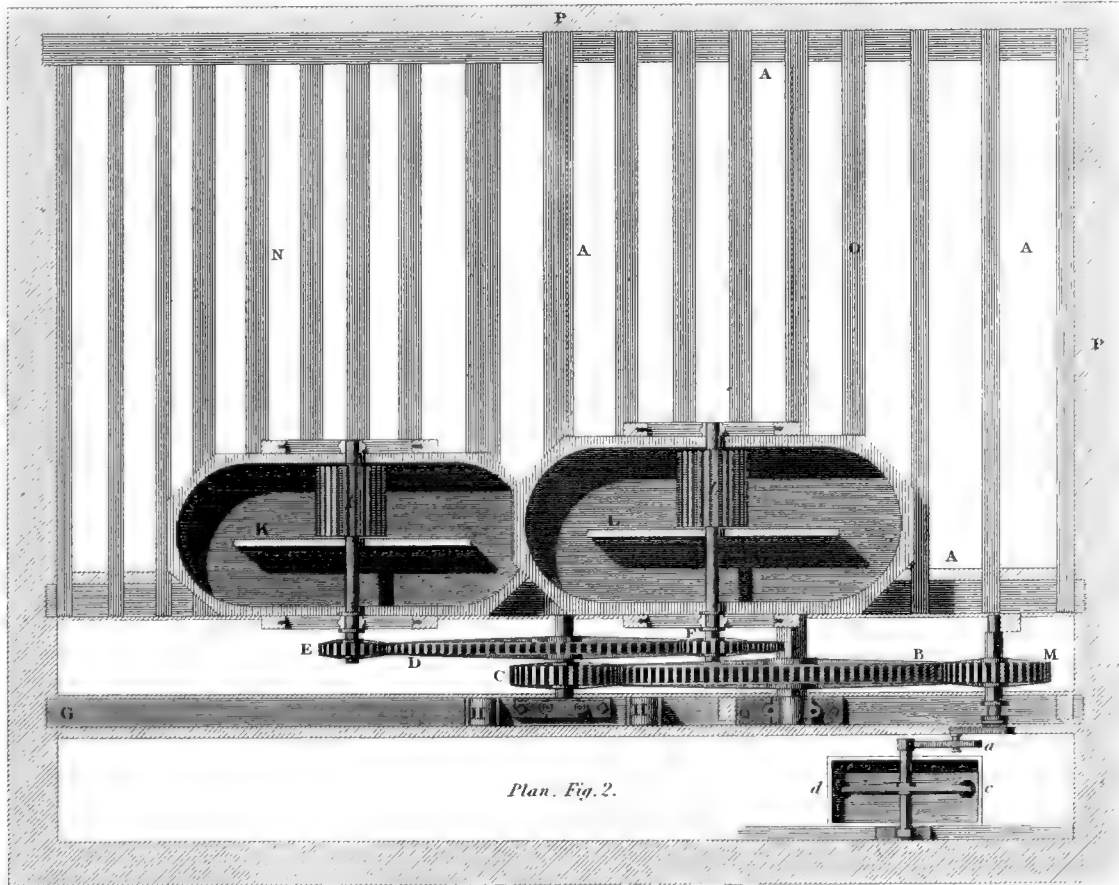
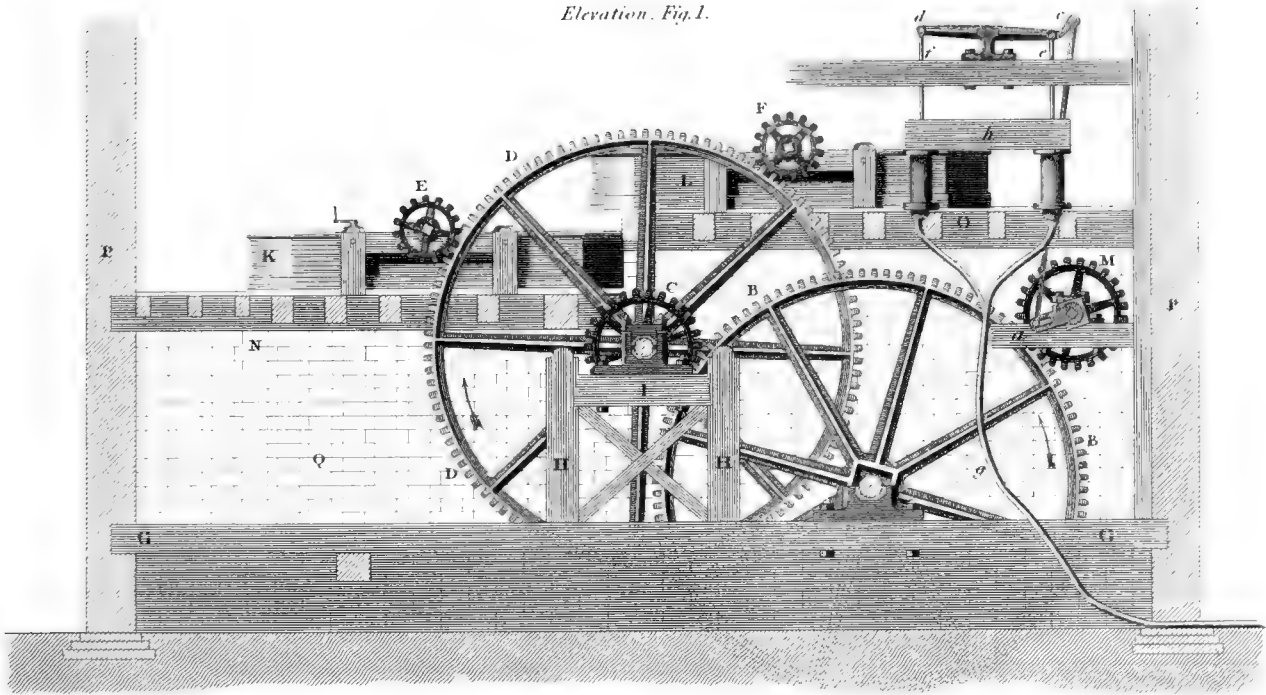


Fig. 2. N° 4.





Elevation. Fig. 1.



Plan. Fig. 2.

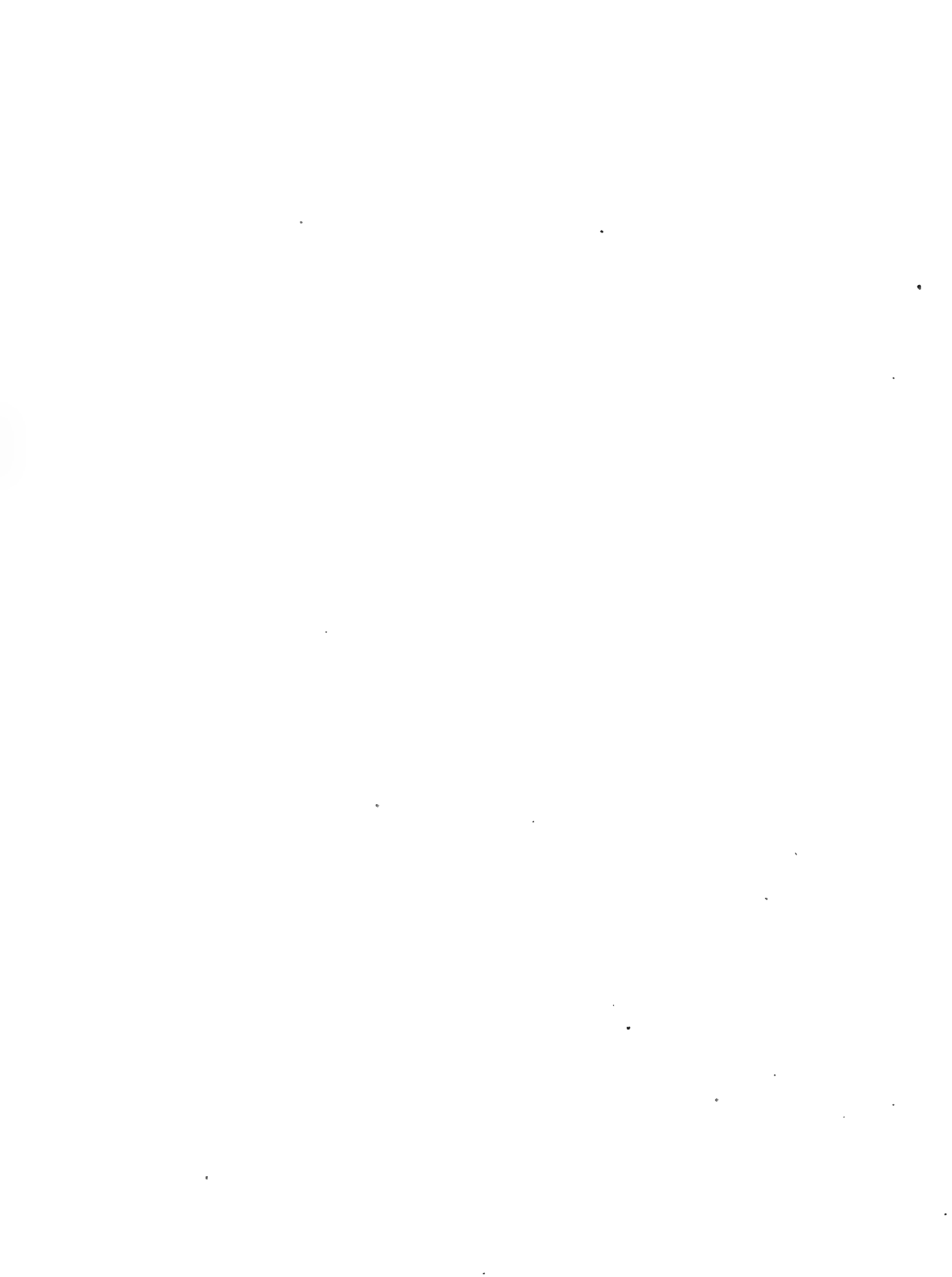


Fig. 5.

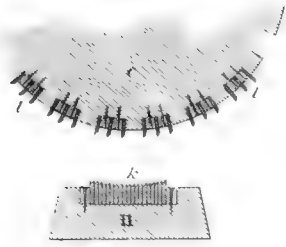


Fig. 4.

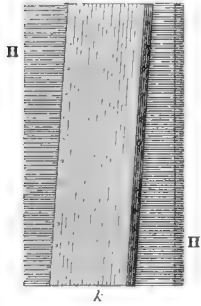


Fig. 1. Section of an Engine.

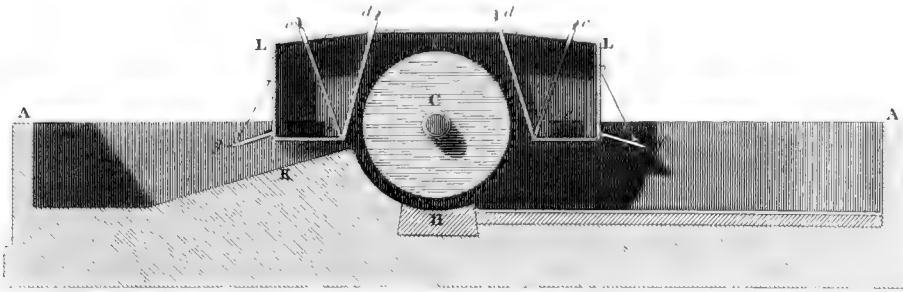


Fig. 2.

Plan

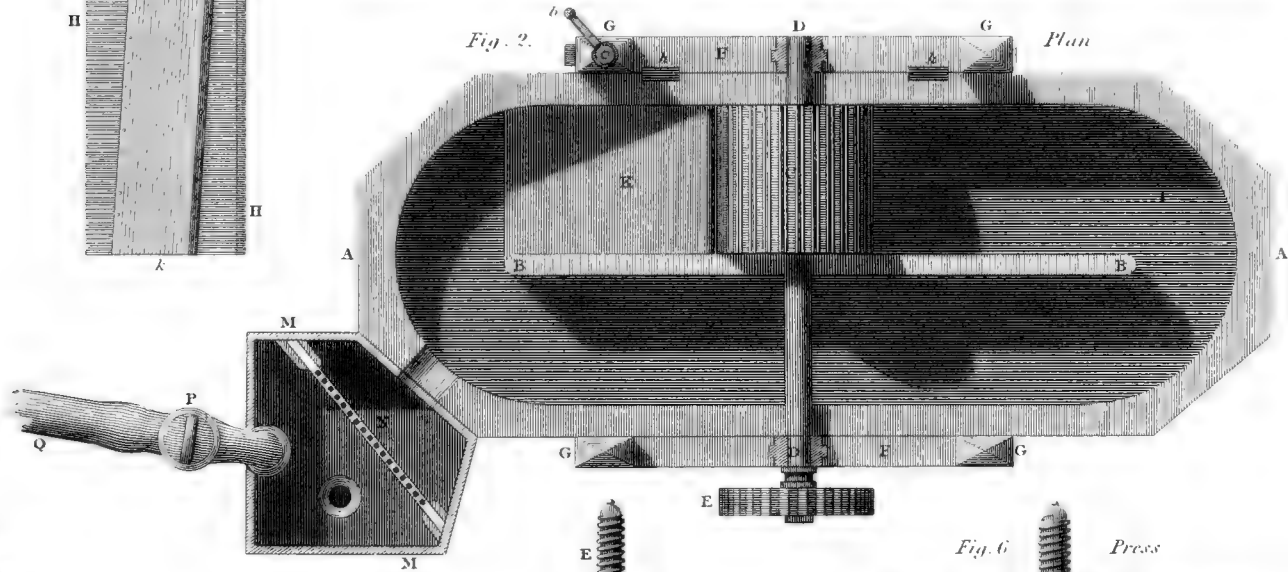


Fig. 3.

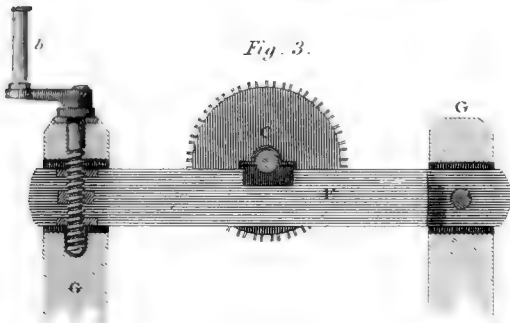


Fig. 7.

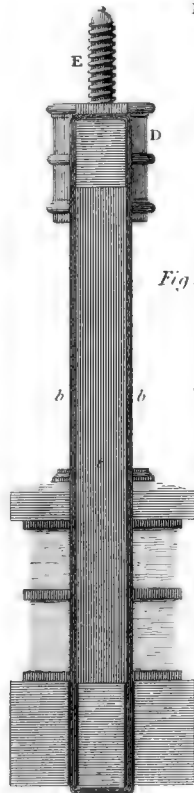
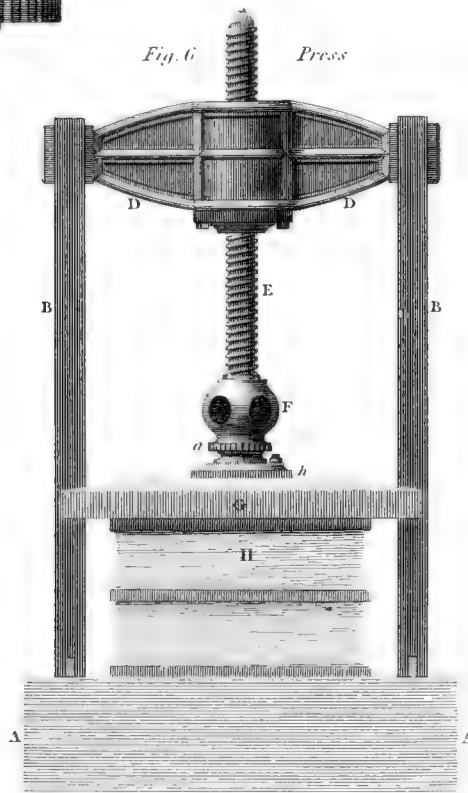
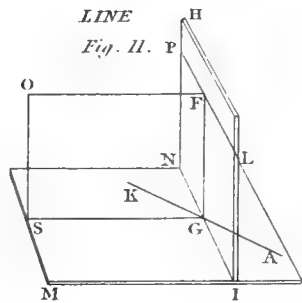
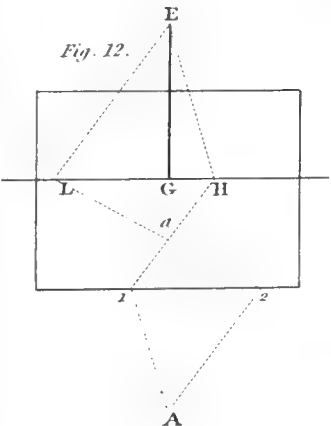
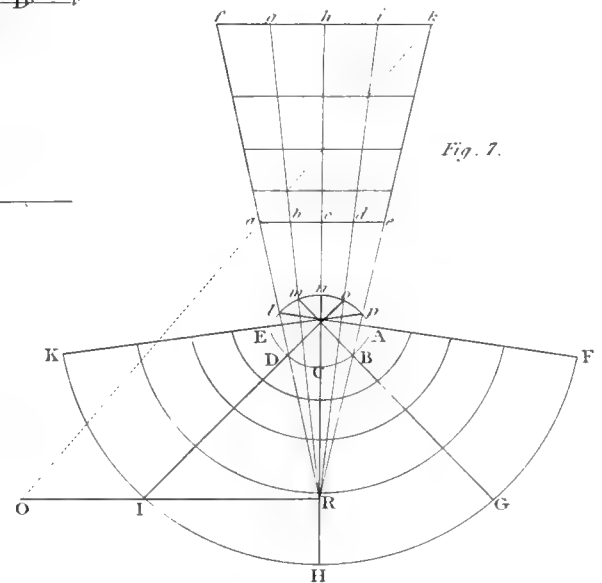
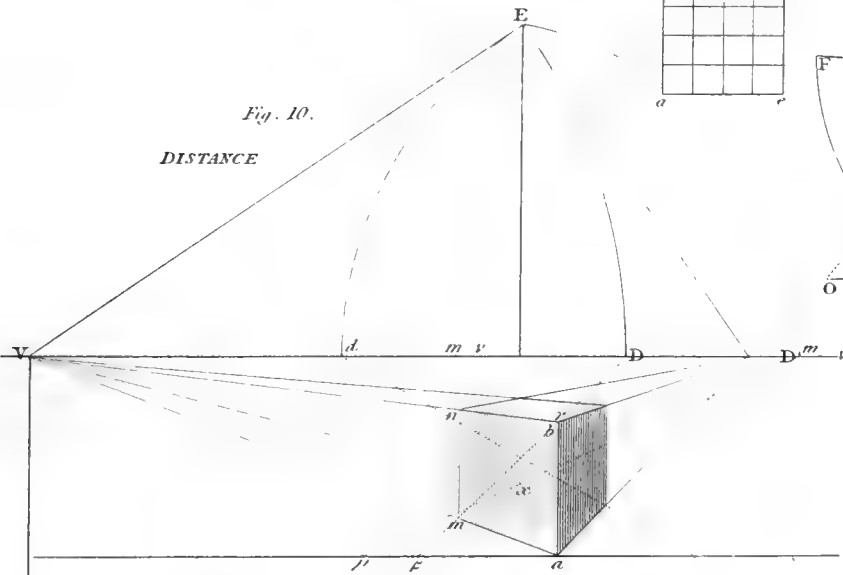
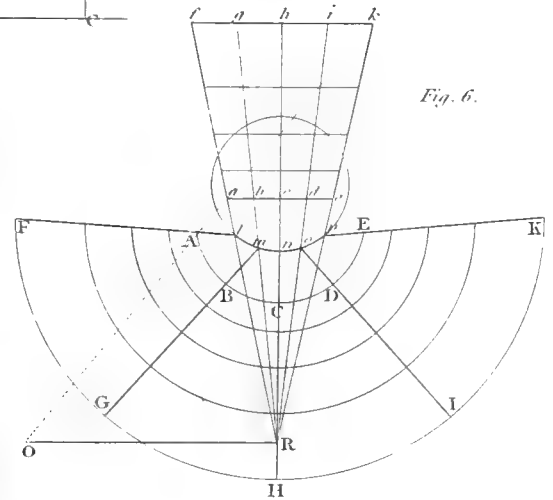
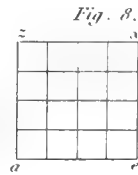
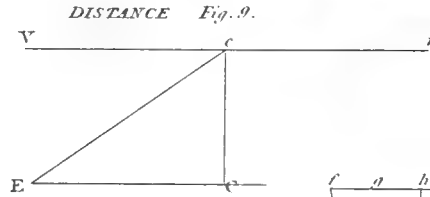
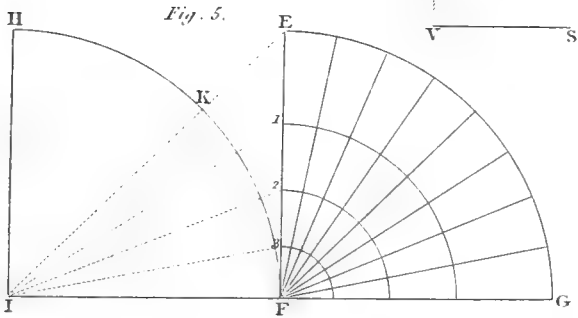
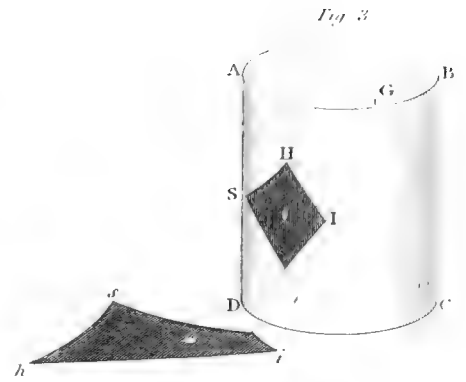
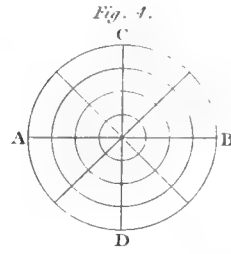
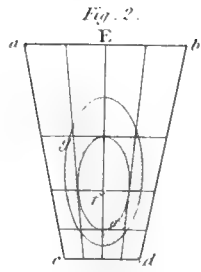
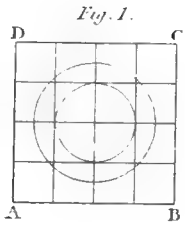


Fig. 6. Press



PERSPECTIVE.

ANAMORPHOSIS.



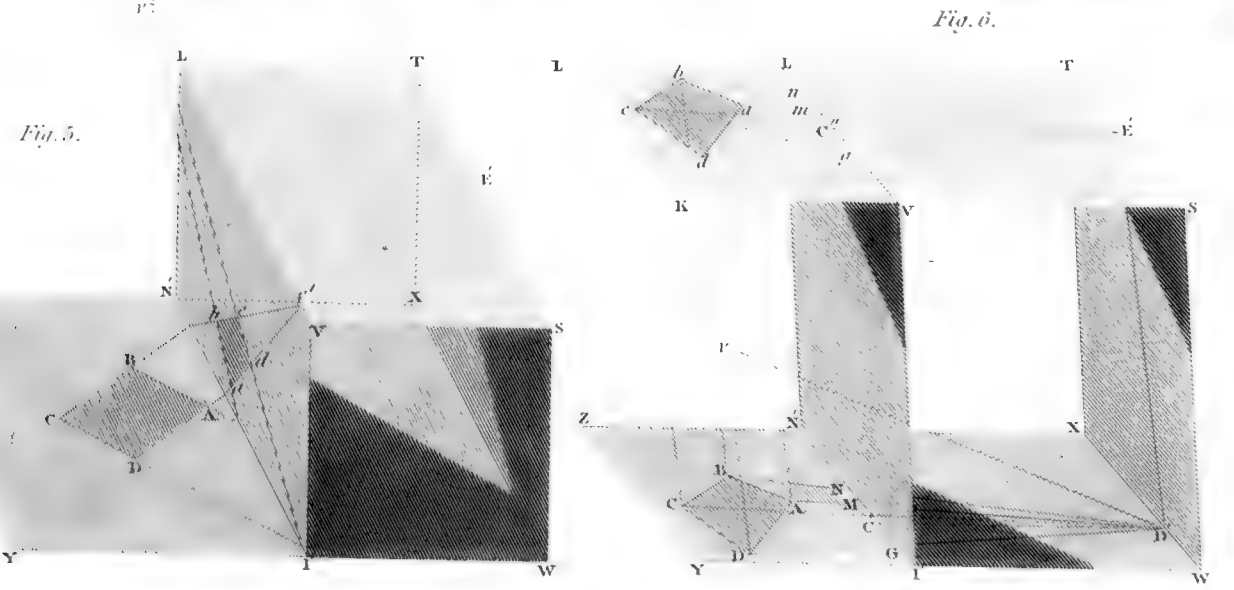
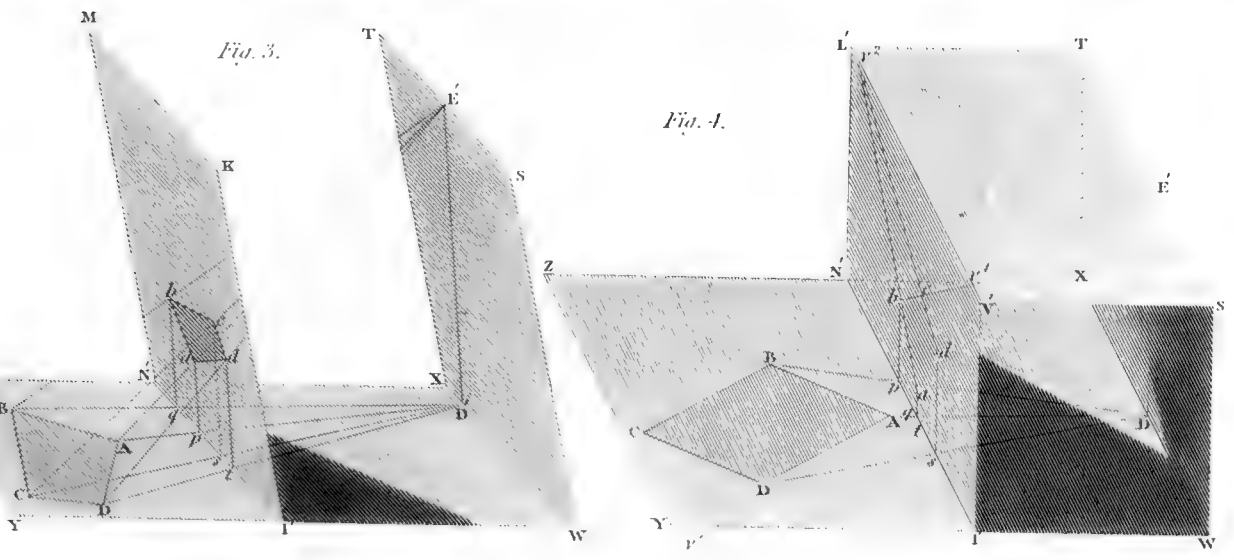
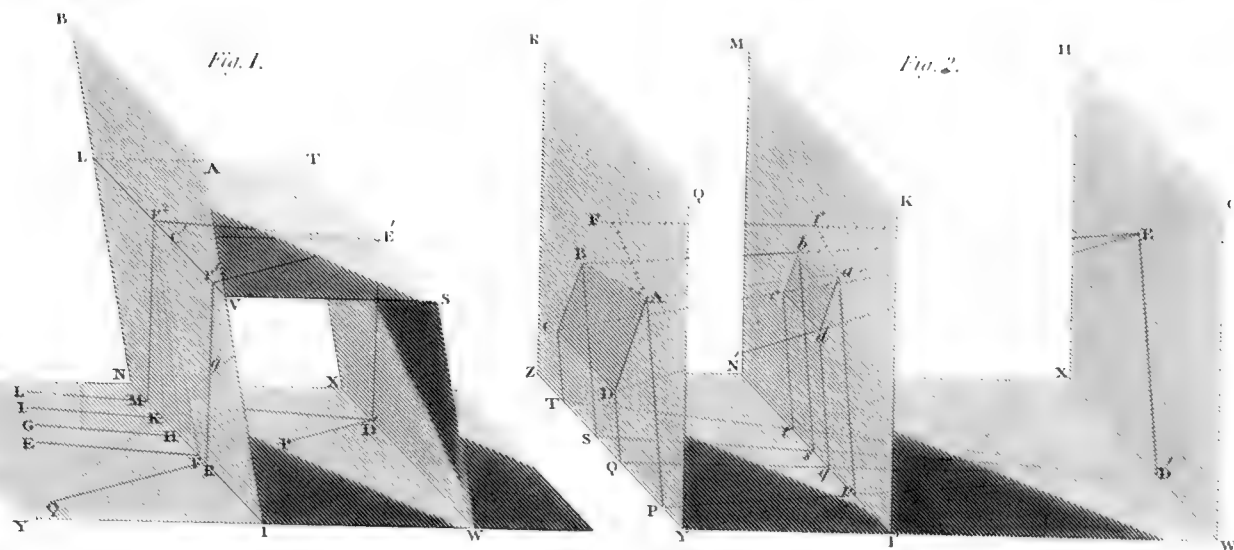


Fig. 2.

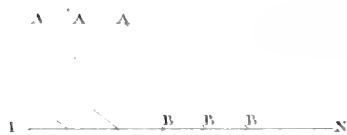


Fig. 3.

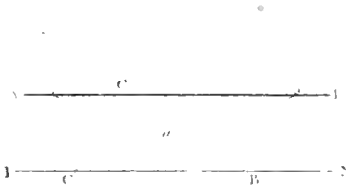


Fig. 4.

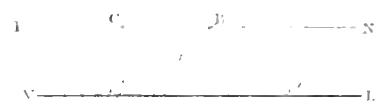


Fig. 1.

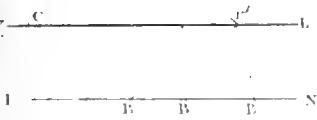


Fig. 5.

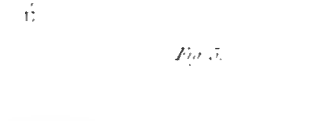


Fig. 6.



Fig. 7.

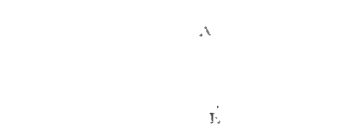


Fig. 8.

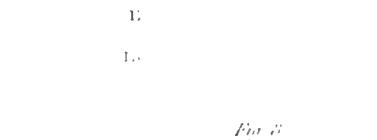


Fig. 9.

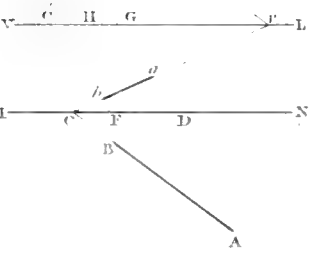


Fig. 10.

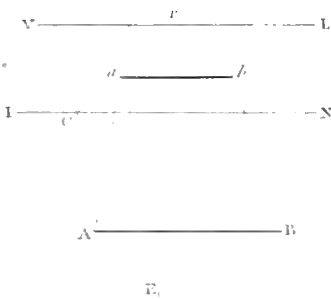


Fig. 11.

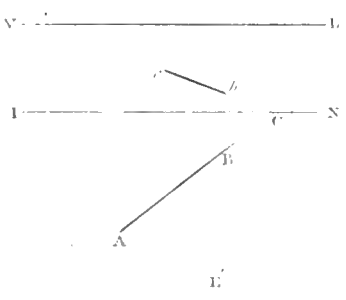


Fig. 12.

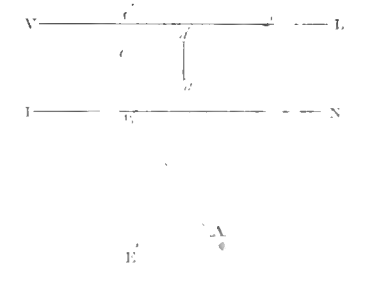


Fig. 13.

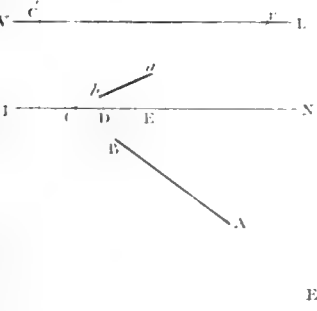


Fig. 14.

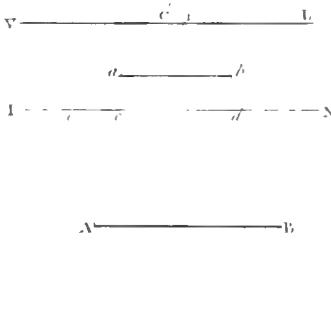
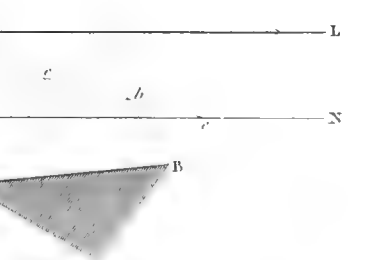
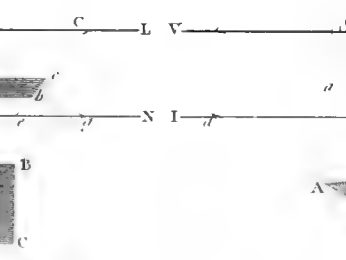
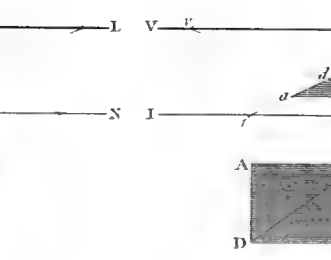
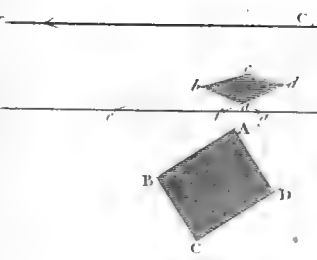
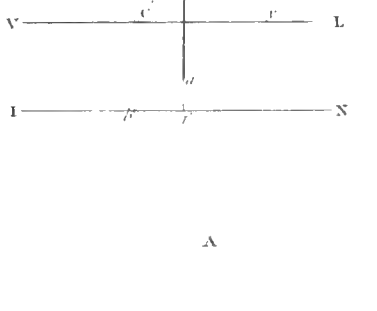
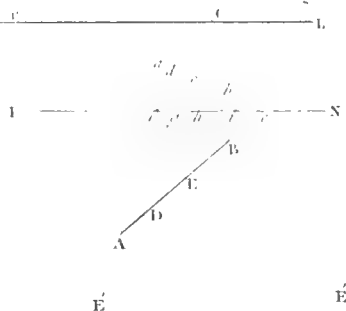
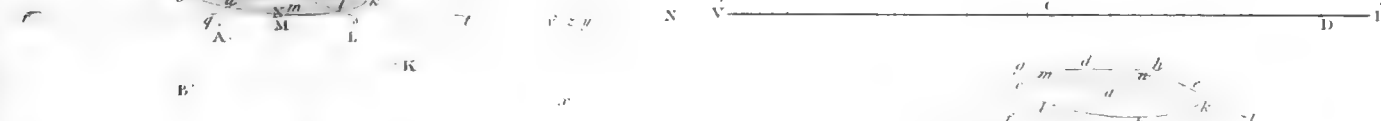
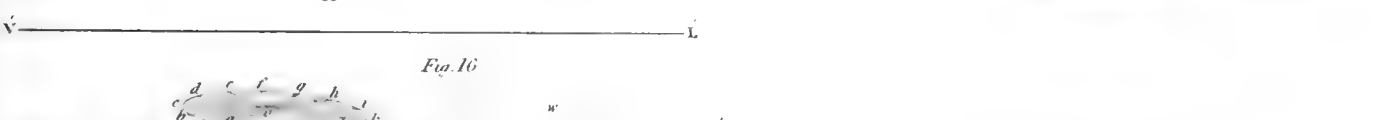
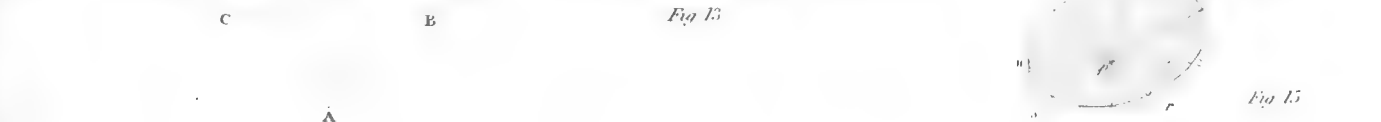
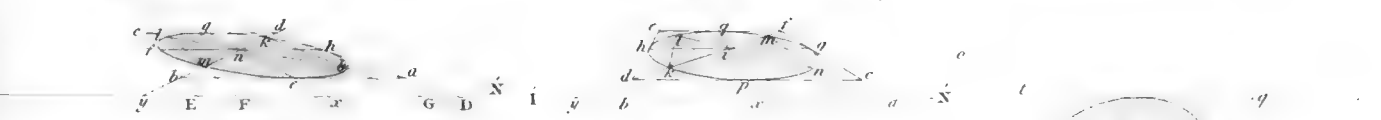
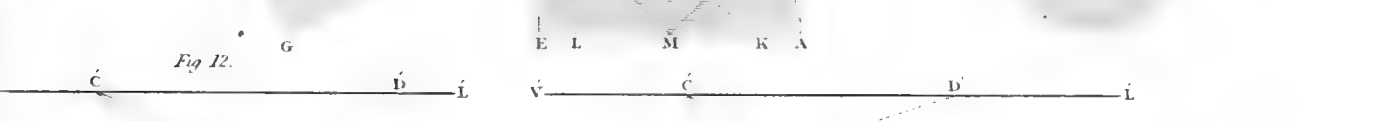
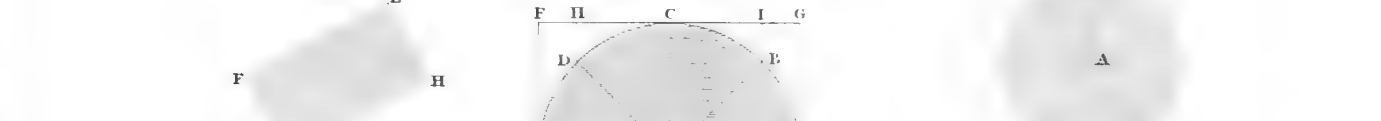
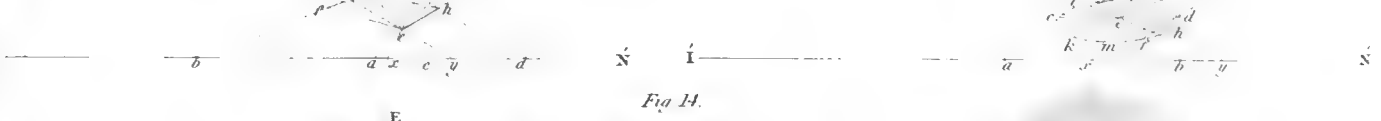
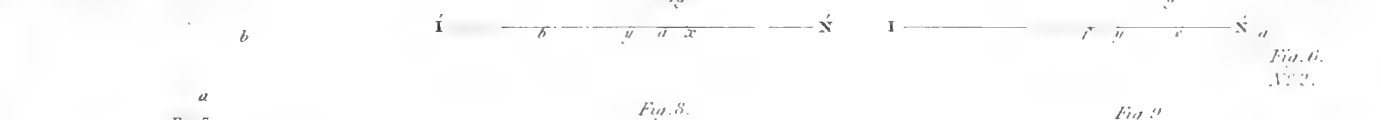
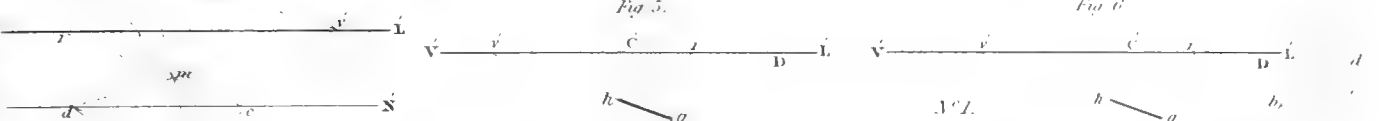
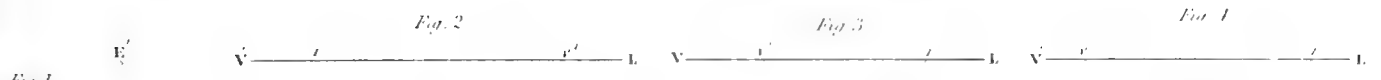
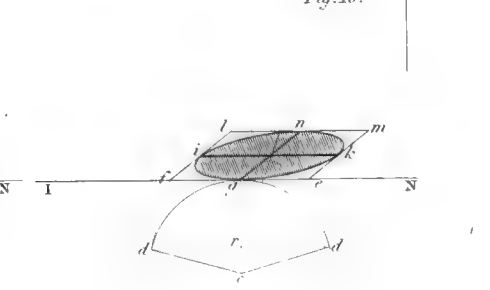
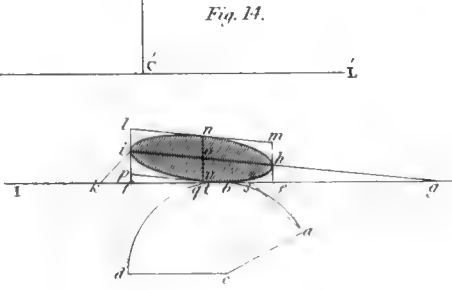
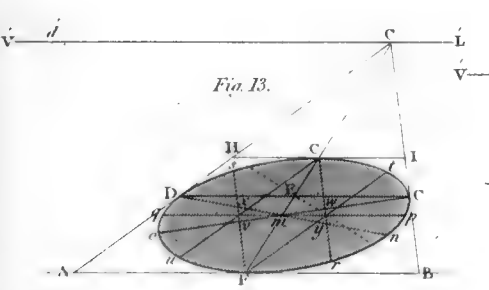
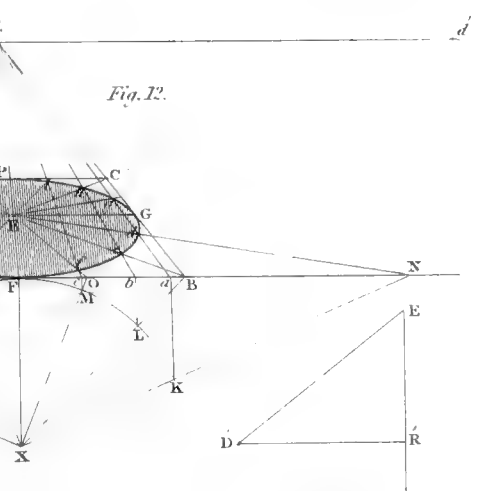
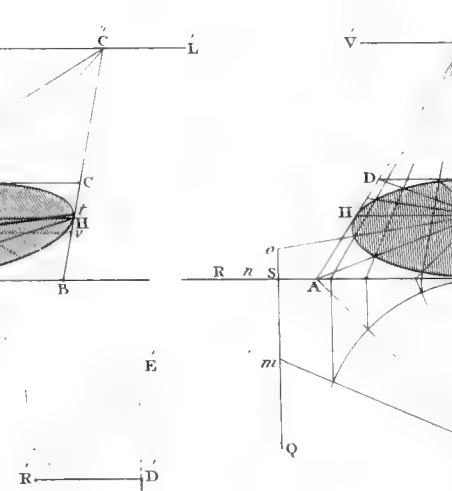
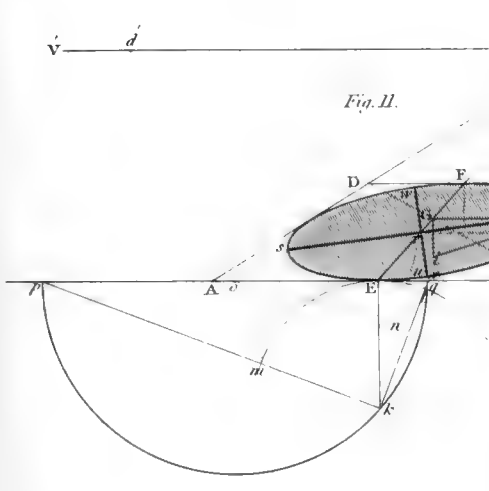
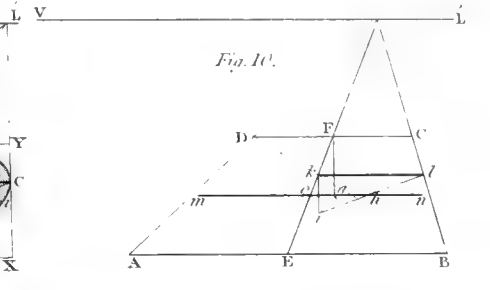
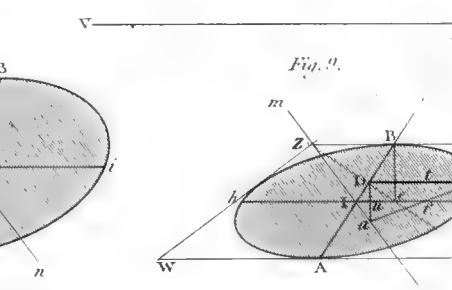
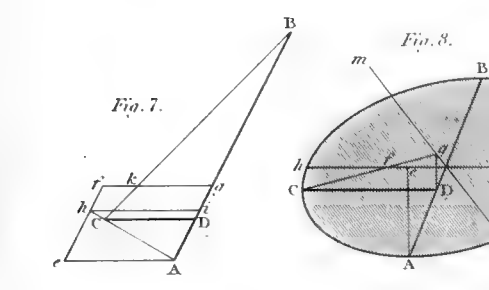
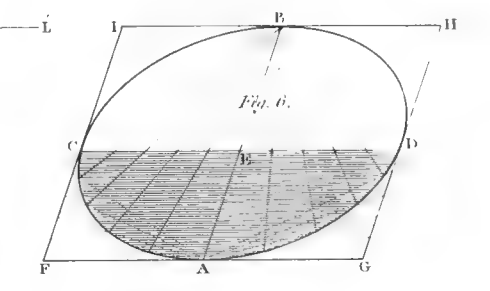
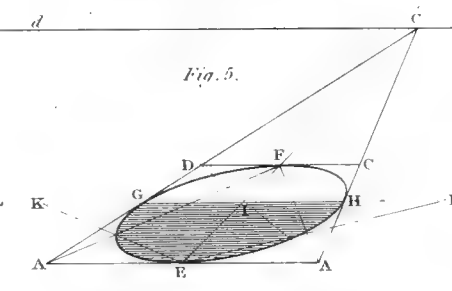
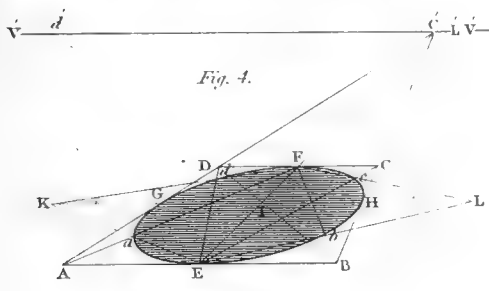
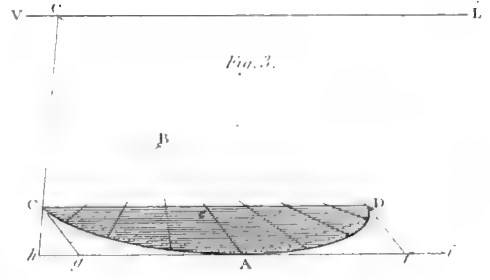
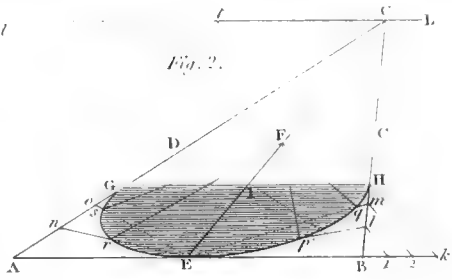
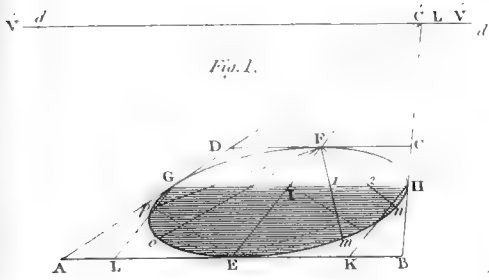


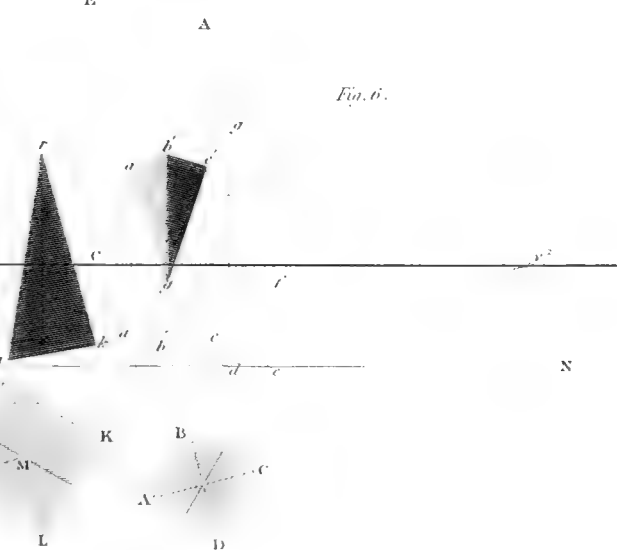
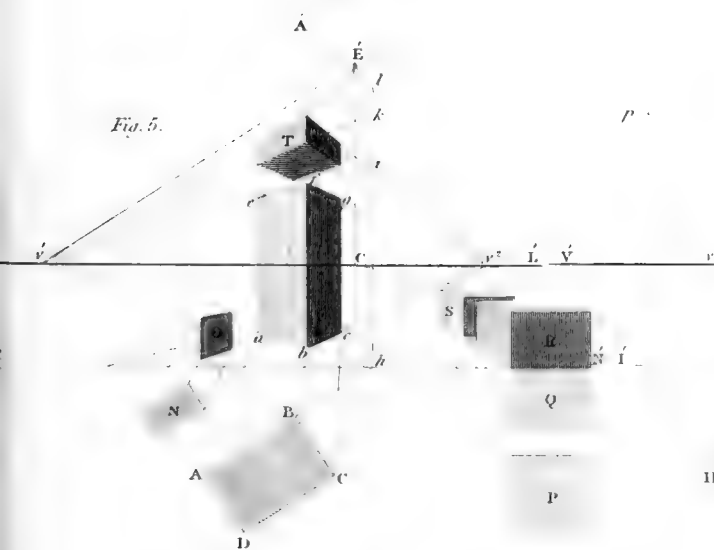
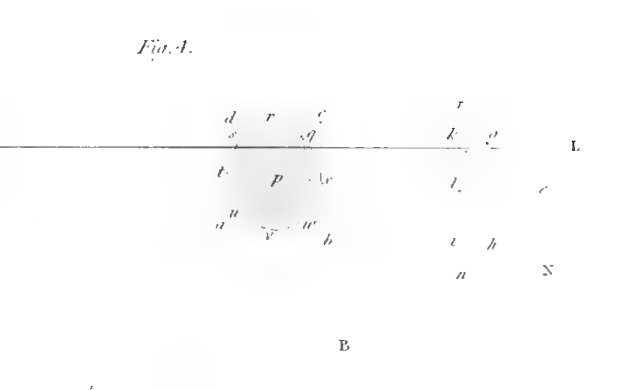
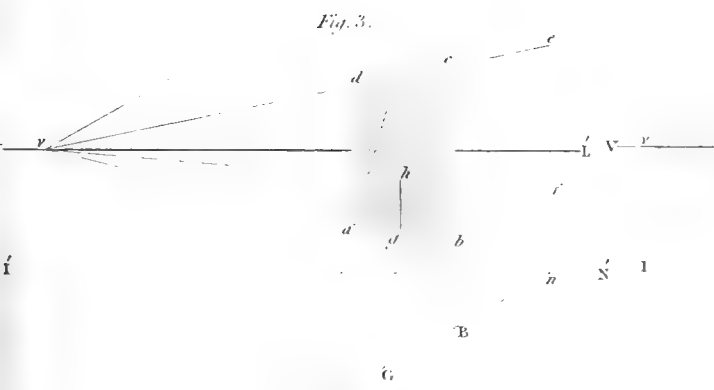
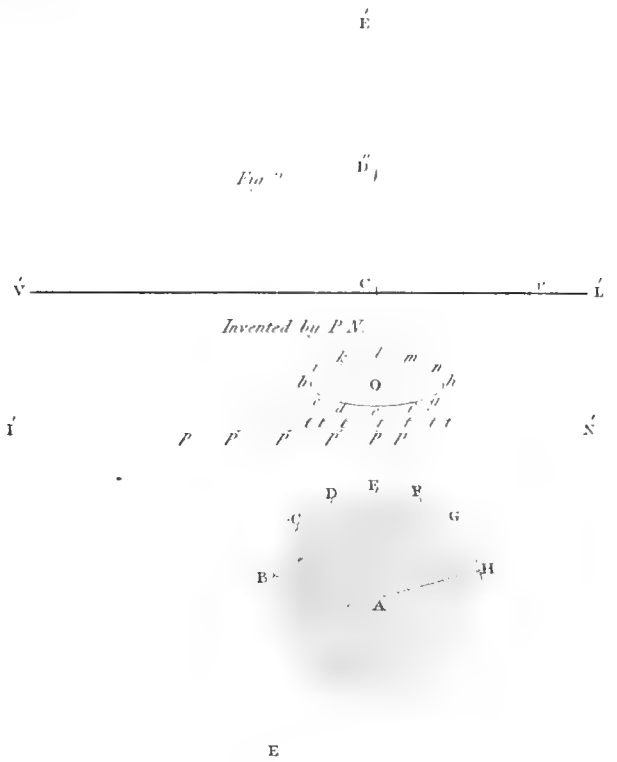
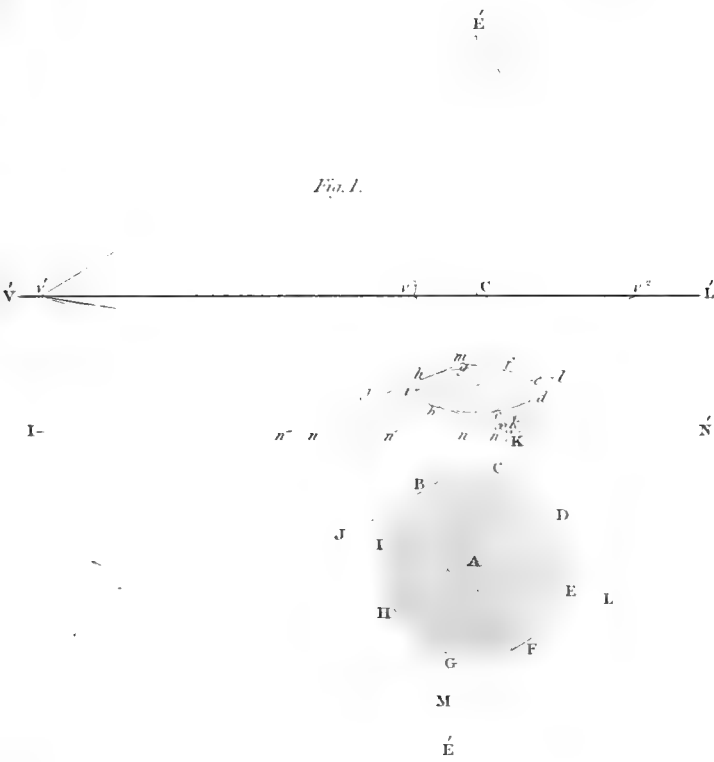
Fig. 15.













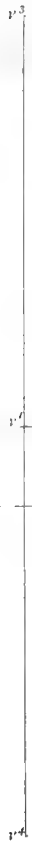


Fig. 1. N° 1.

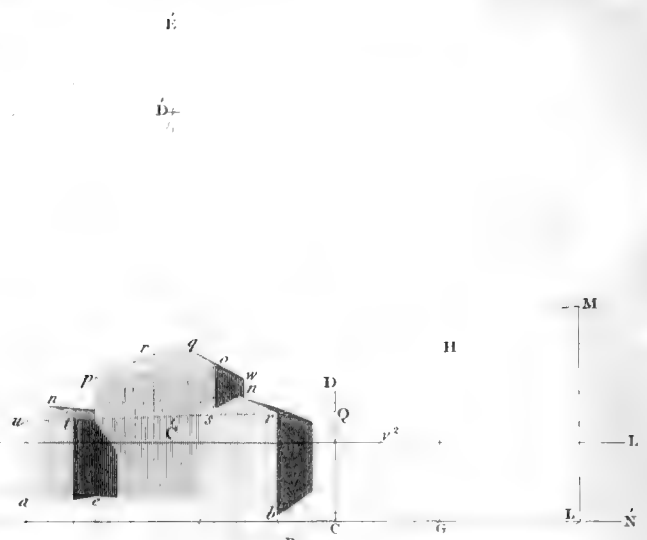


Fig. 1. N° 3.



Fig. 1. N° 2.

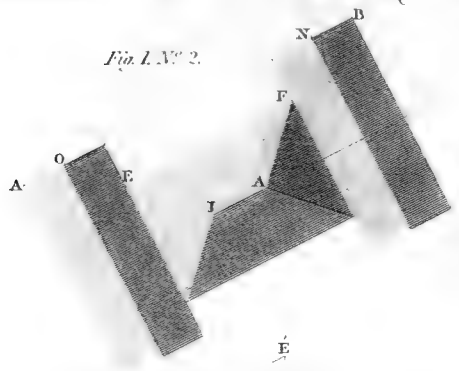


Fig. 2. N° 4.

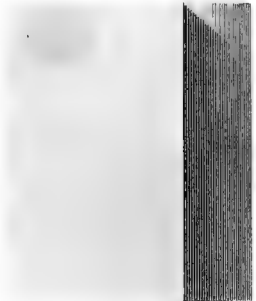


Fig. 2. N° 1.

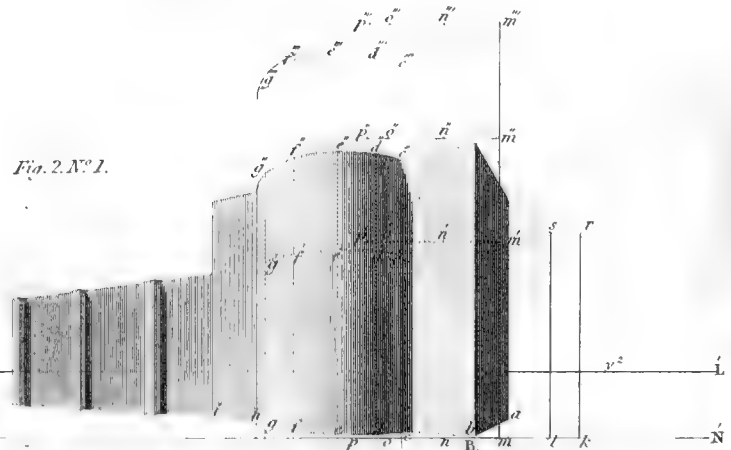


Fig. 2. N° 3.

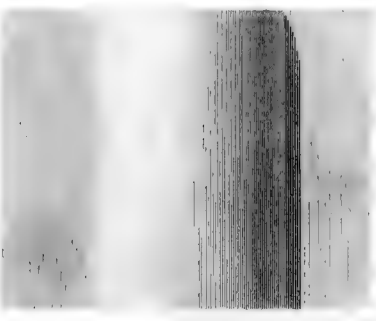
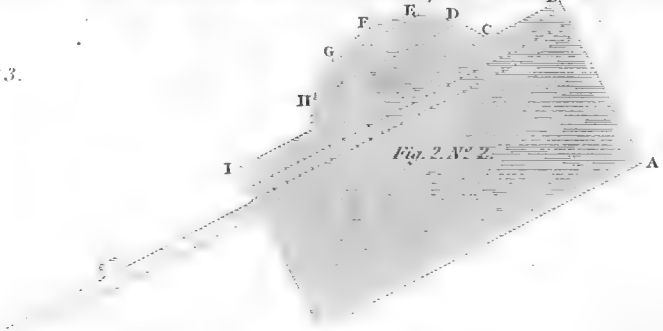


Fig. 2. N° 2.



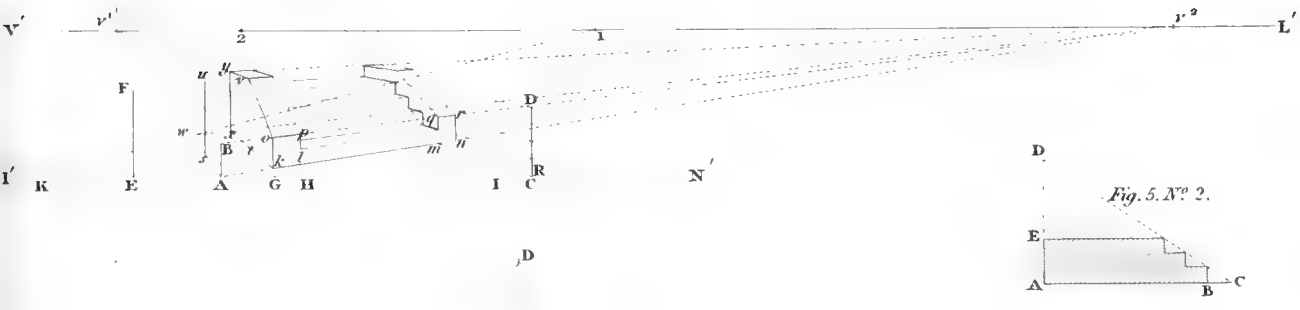
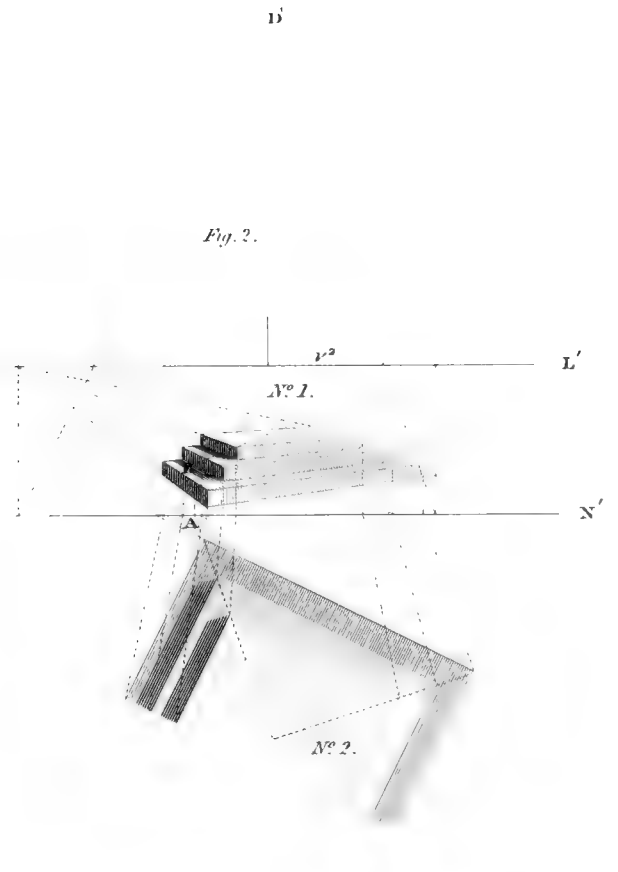
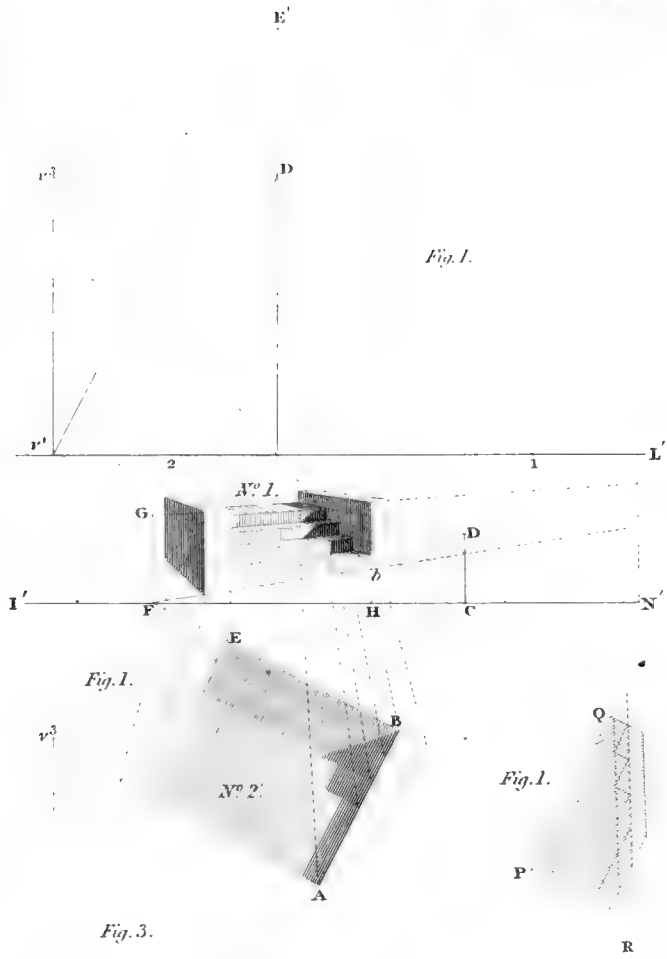


Fig. 4. N° 1.

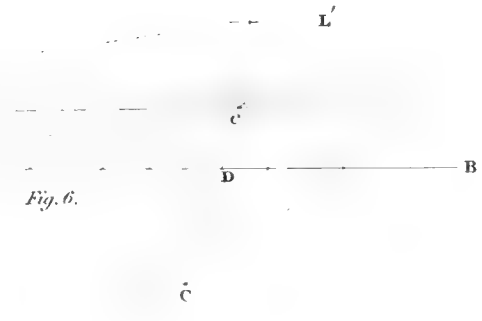
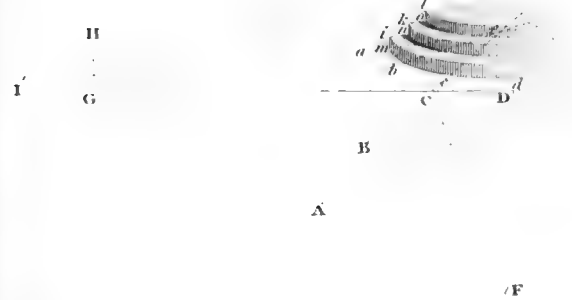


Fig. 6.



Fig. L. N^o 1.

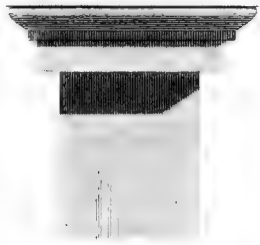


Fig. L. N^o 2.

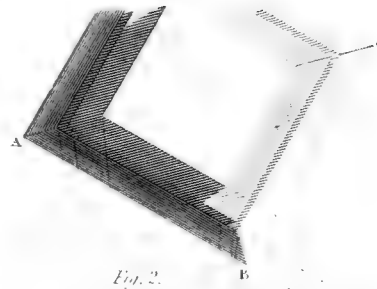
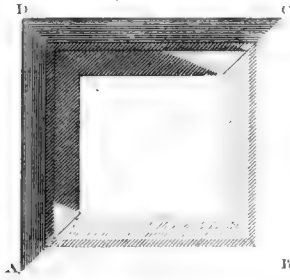


Fig. 2.

Y I O R H

Fig. 1.

Improved by P. Nicholson.

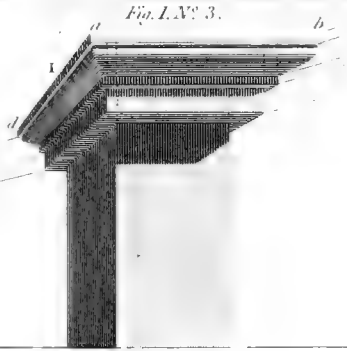
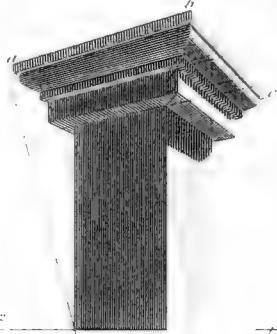


Fig. L. N^o 3.

F I m

G

W T Q O
X Y
U S
K P



M L P D Z

N
L
K H
G E

Improved by P. Nicholson.

Fig. 3.



Invented by Nicholson.

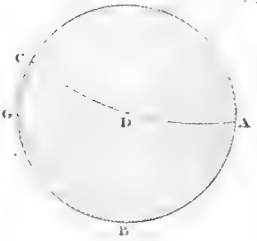
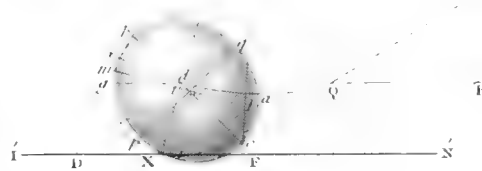


Fig. 4.
Invented by P. Nicholson.

V C G L N



I D X D F N

Fig. 5.

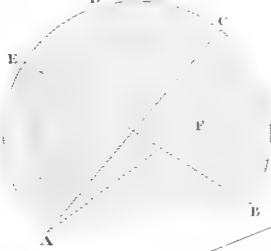


Fig. 6. N^o 1.
Invented by P. Nicholson.

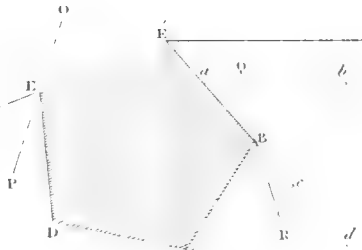


Fig. 7.

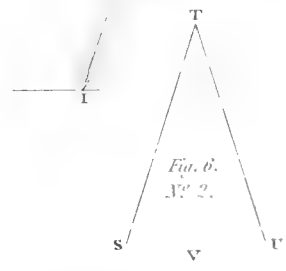
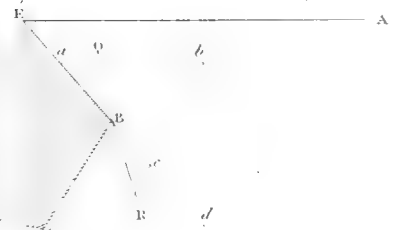
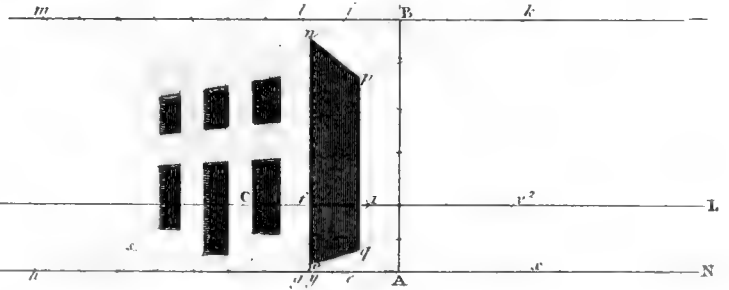
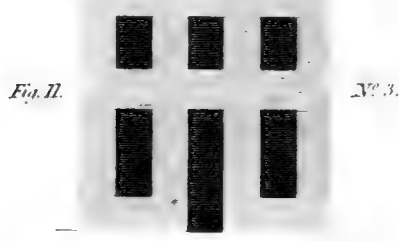
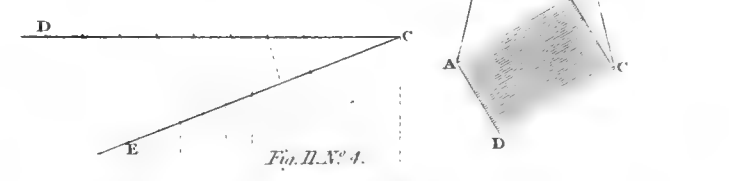
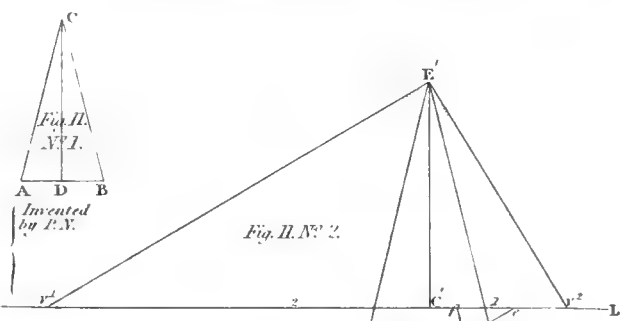
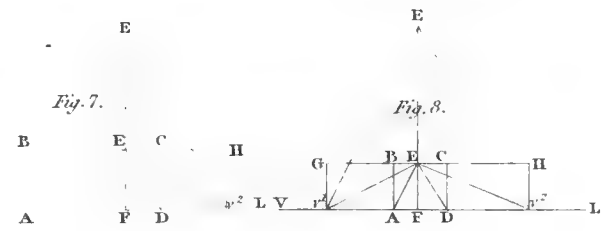
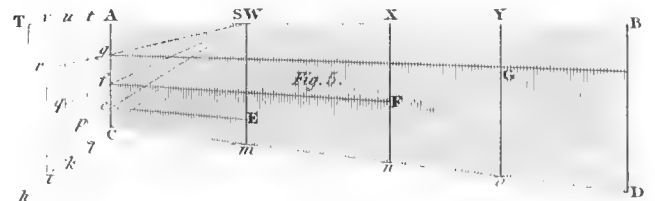
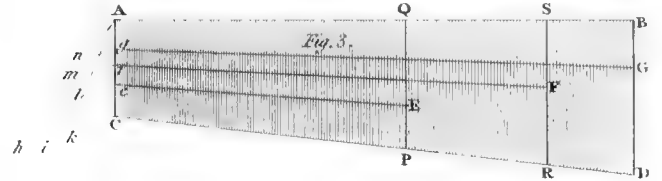
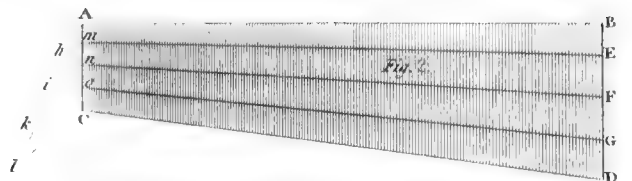
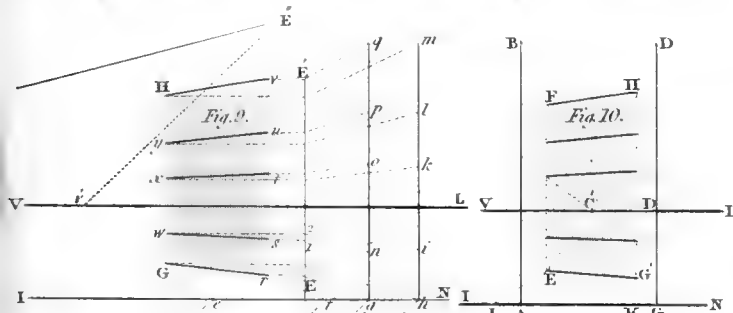
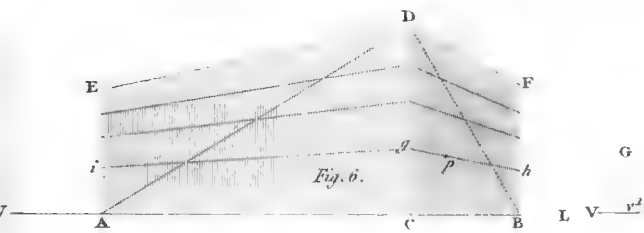
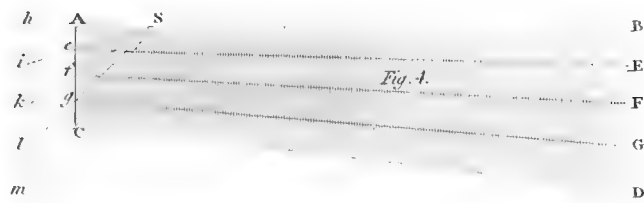
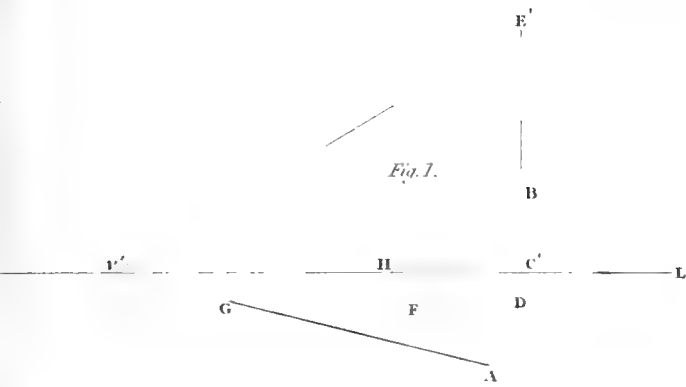
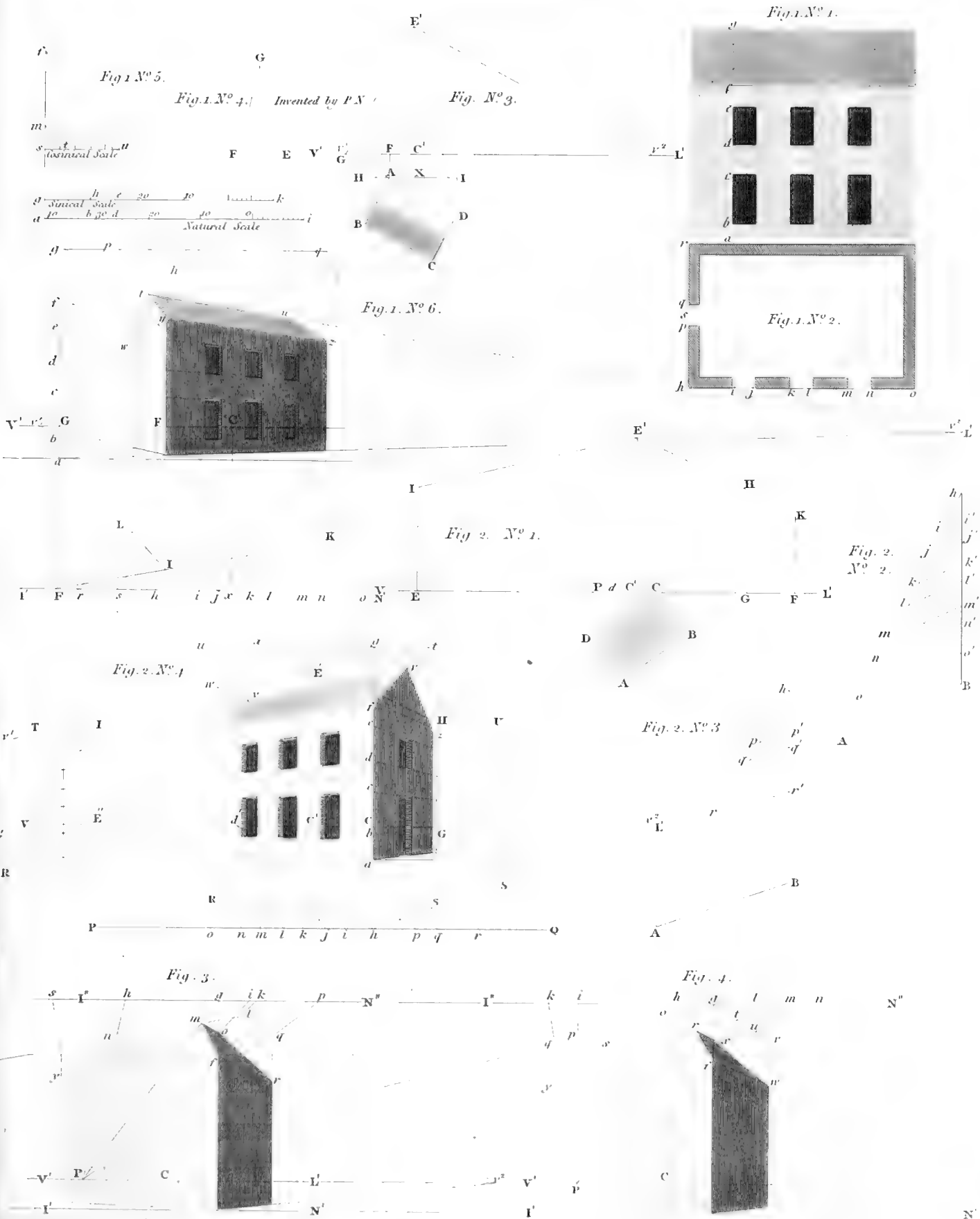


Fig. 8.
N^o 2.







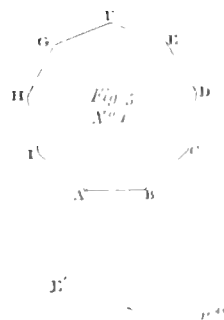
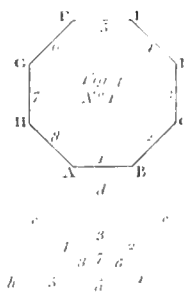
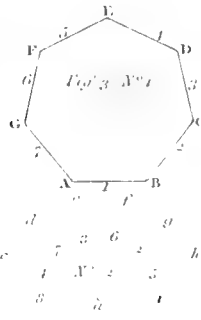
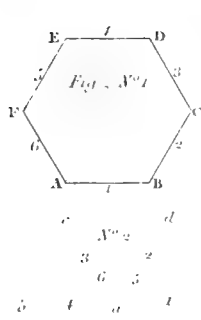
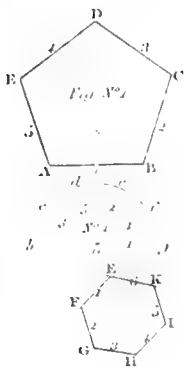


Fig. 6.

Fig. 7.

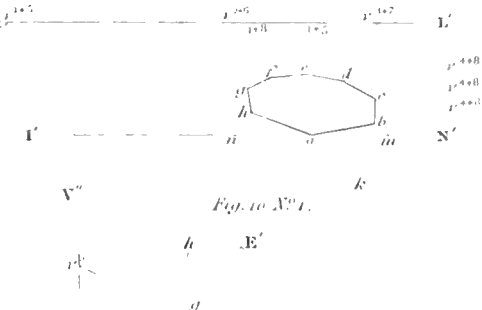
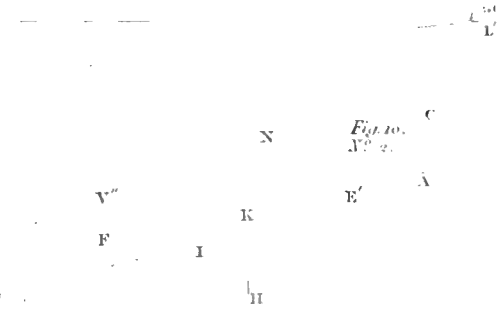
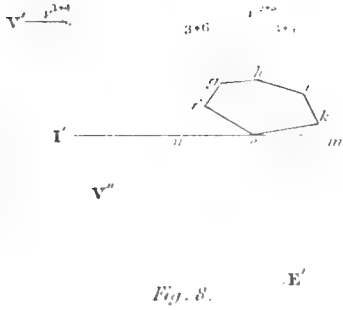


Fig. 8.

Fig. 10.

Fig. 10.

Fig. 9.

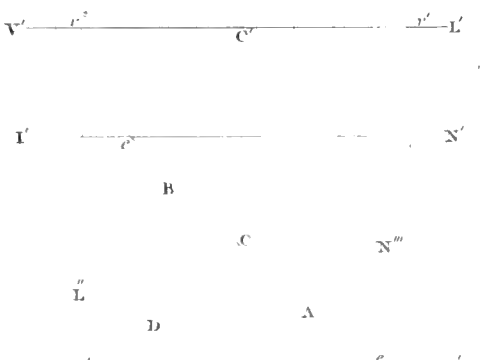
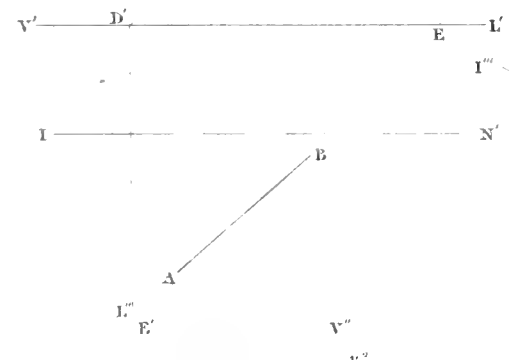
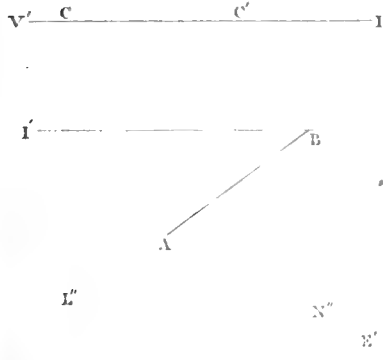


Fig. 11.

Fig. 12.

Fig. 13.

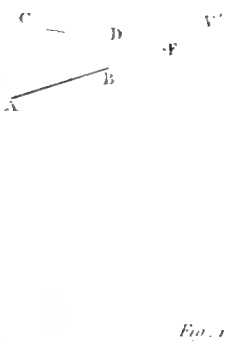


Fig. 14.

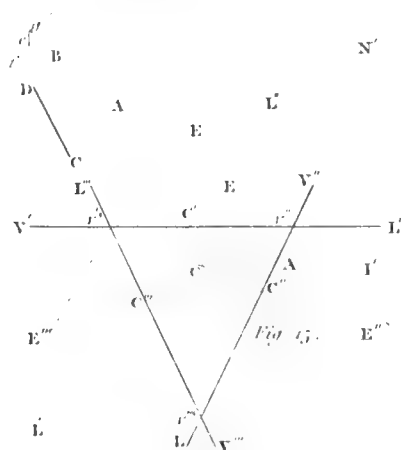


Fig. 15.

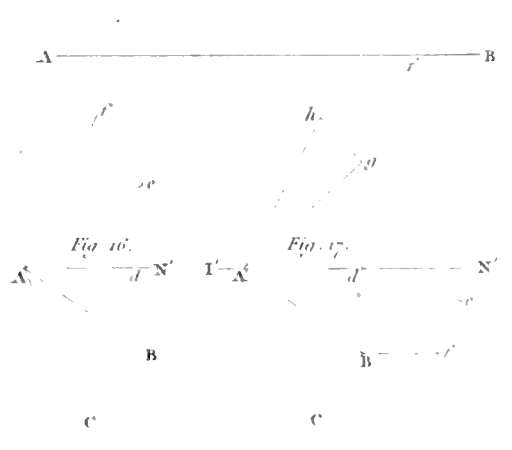


Fig. 16.

Fig. 17.

Fig. 1.

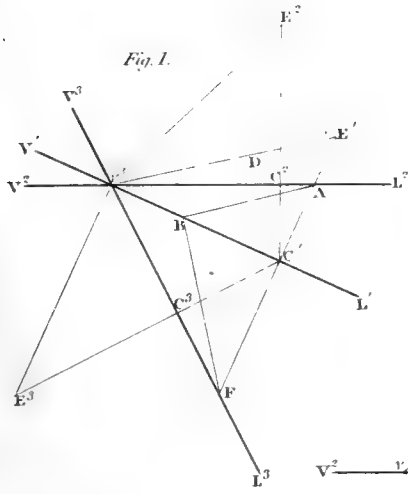


Fig. 2.

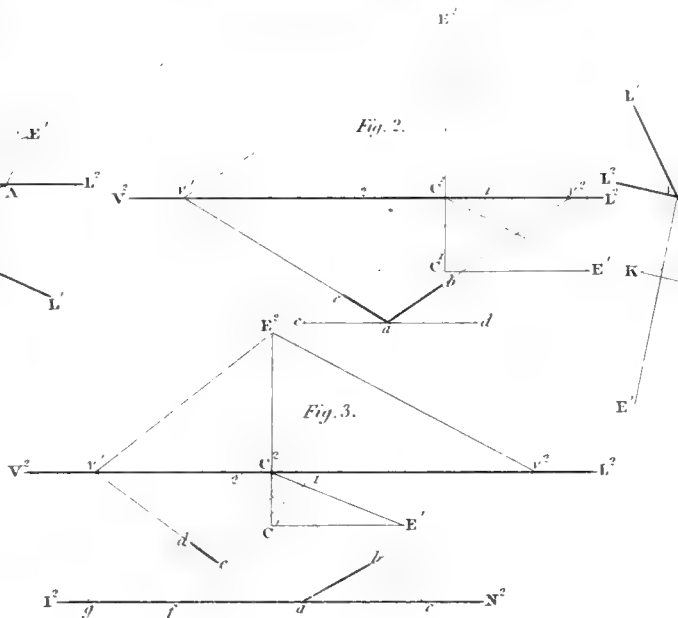


Fig. 1.

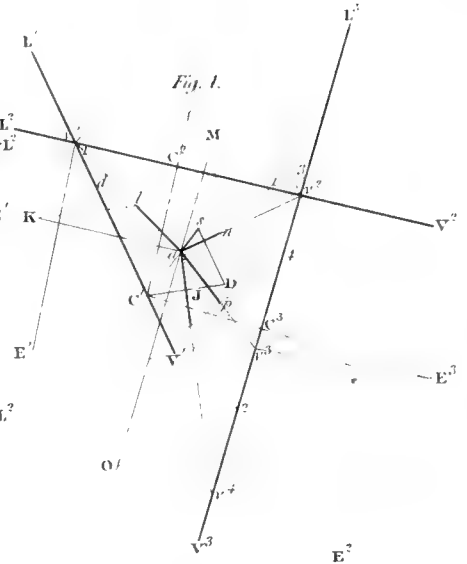


Fig. 3.

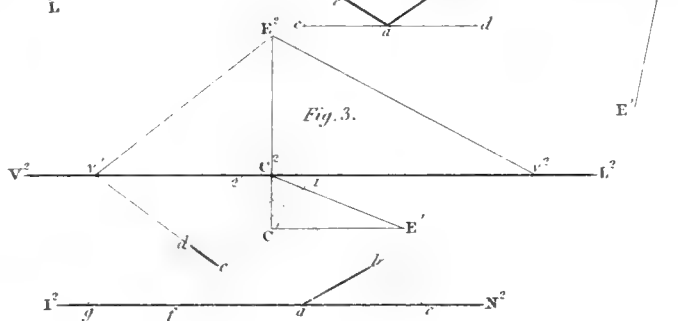


Fig. 5.

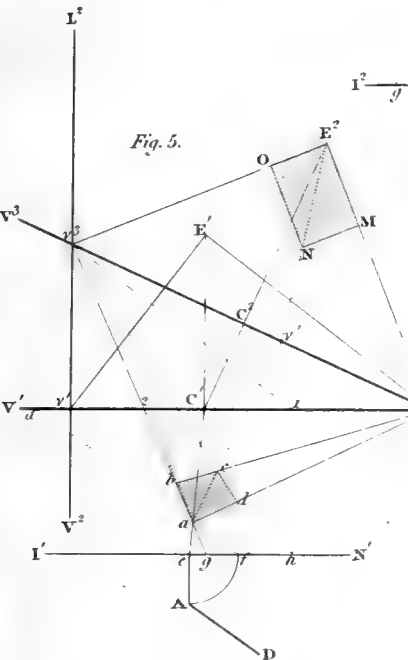


Fig. 6.

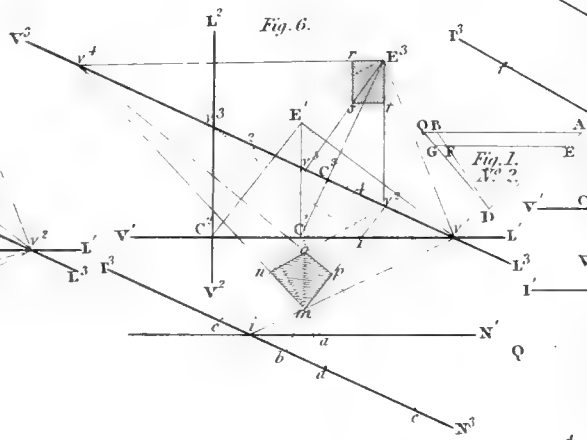


Fig. 7. N° 1.

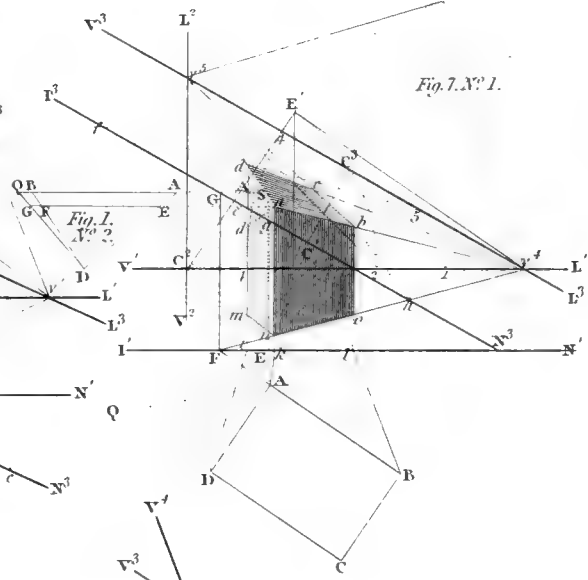


Fig. 8.

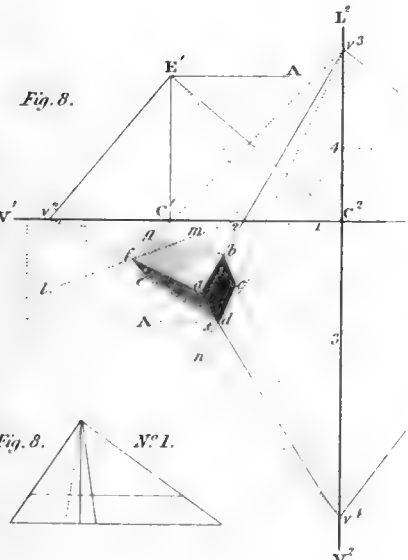


Fig. 9.

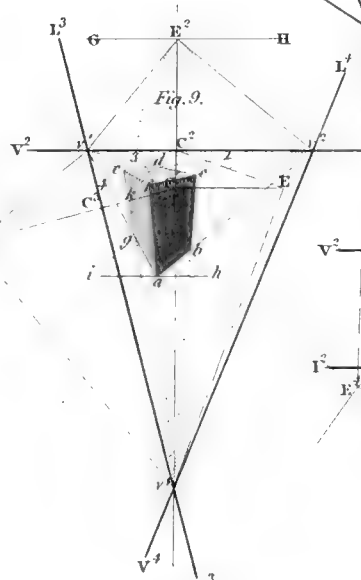


Fig. 10.

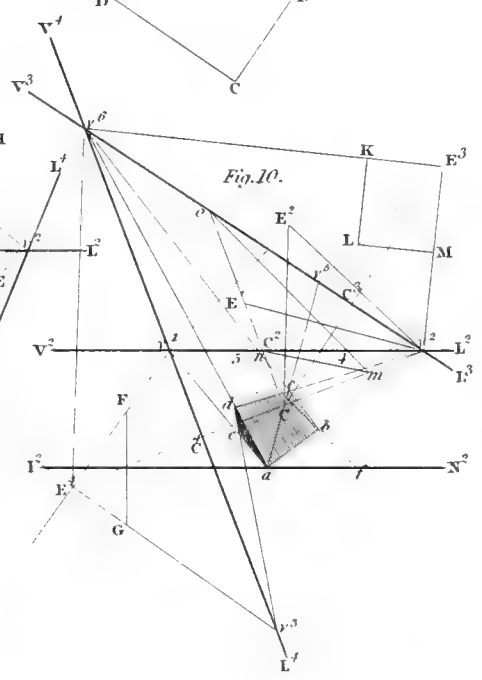
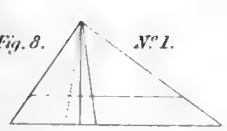
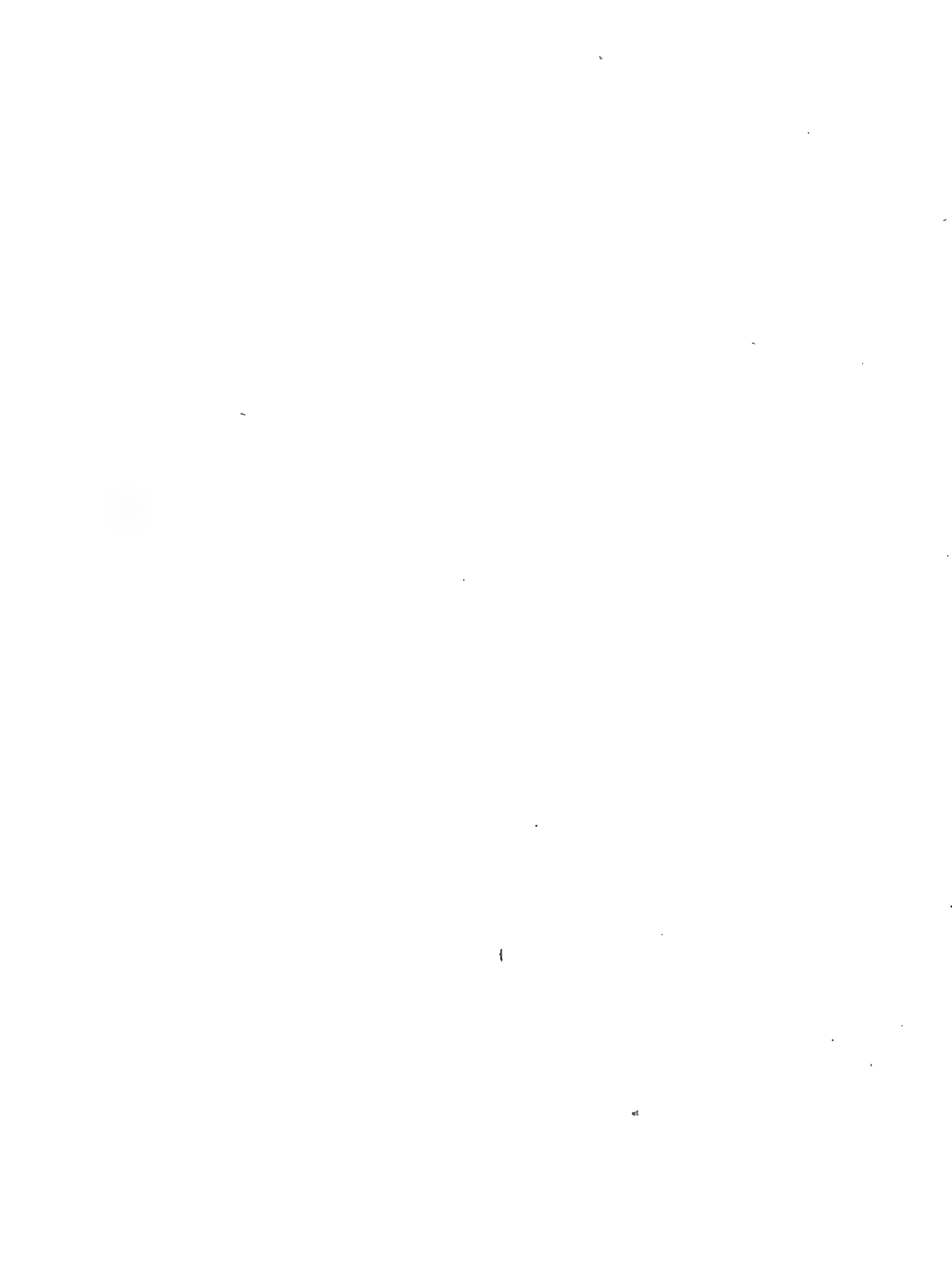


Fig. 8. N° 1.





PLANETARY MACHINES.

COMETARIUM.

Fig. 1.

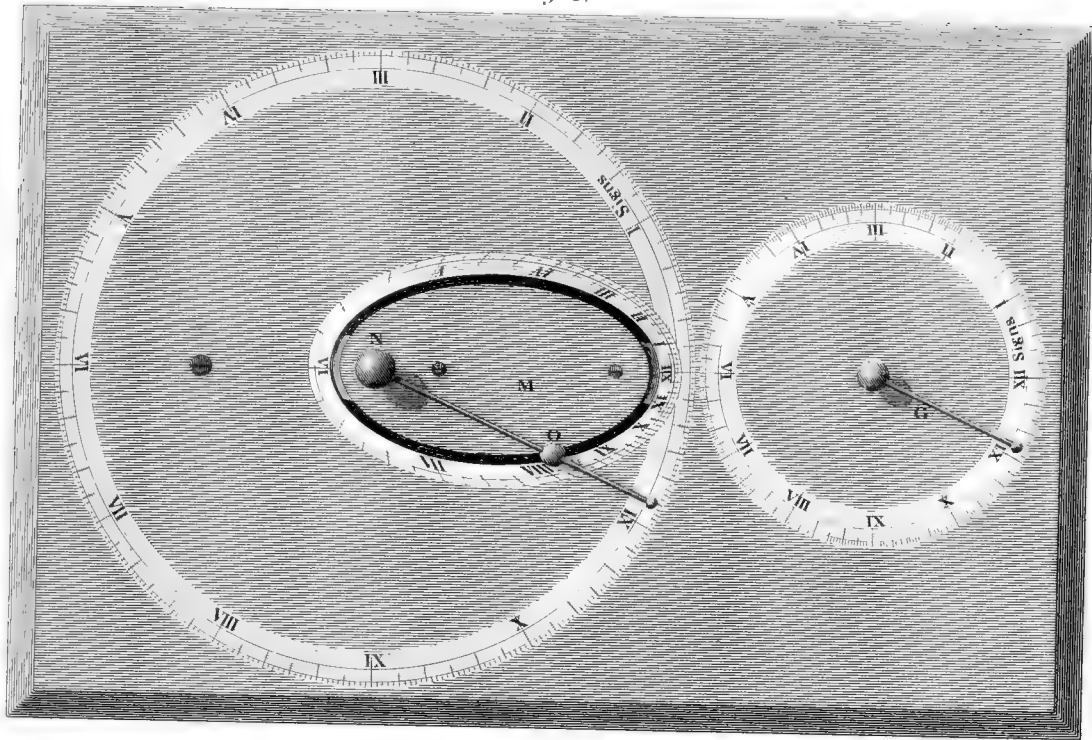
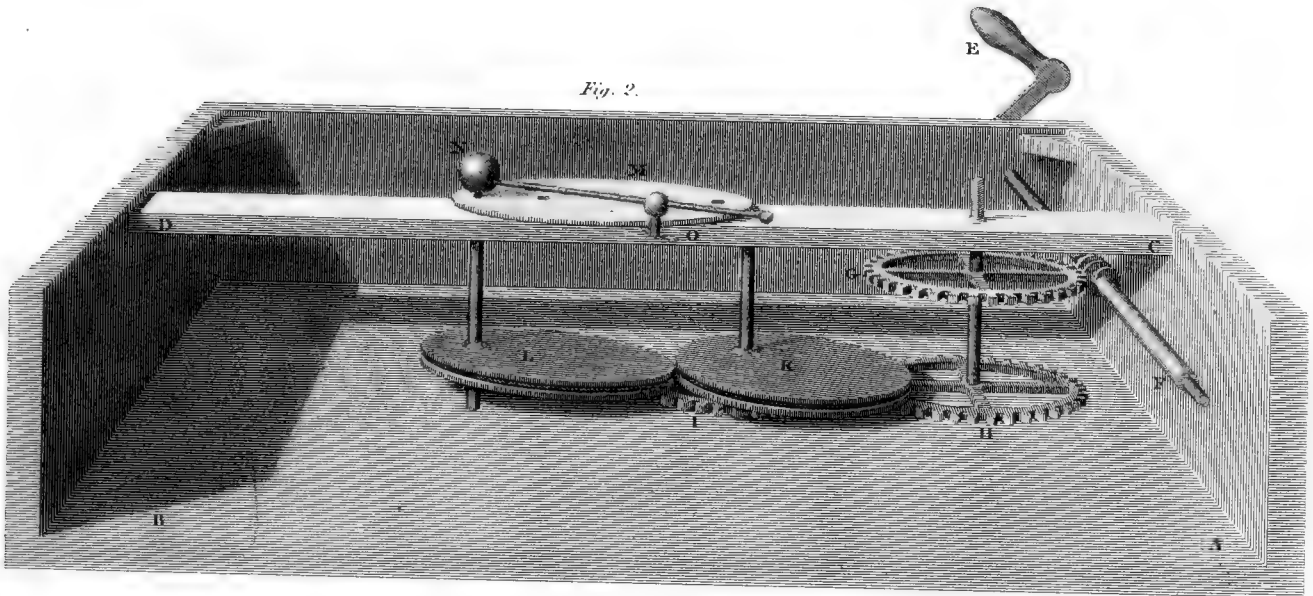


Fig. 2.



COMETARIUM,
by W. Jones.

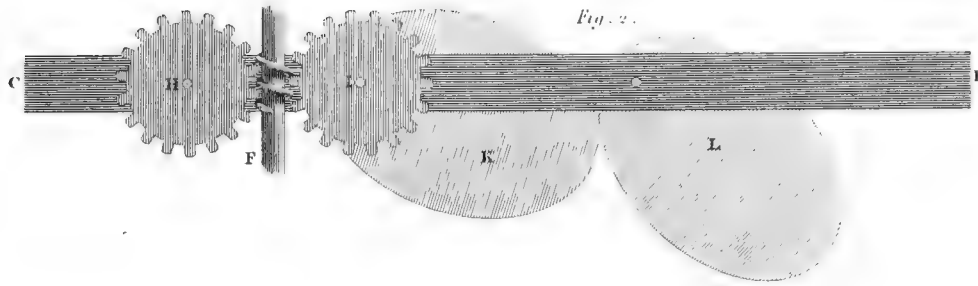


Fig. 2.

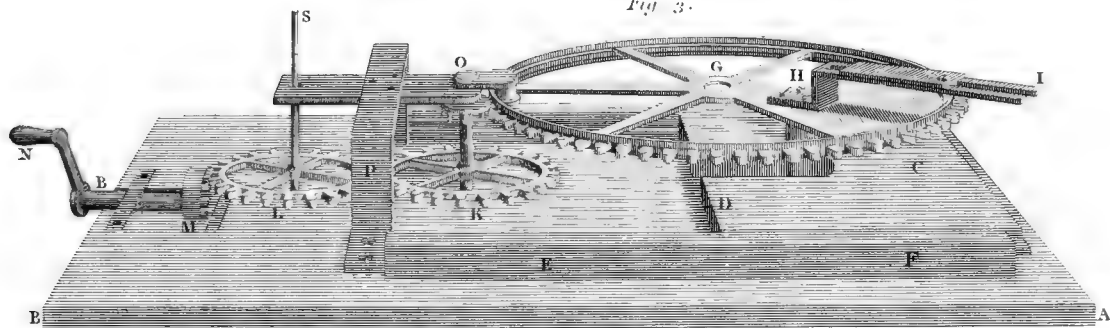


Fig. 3.

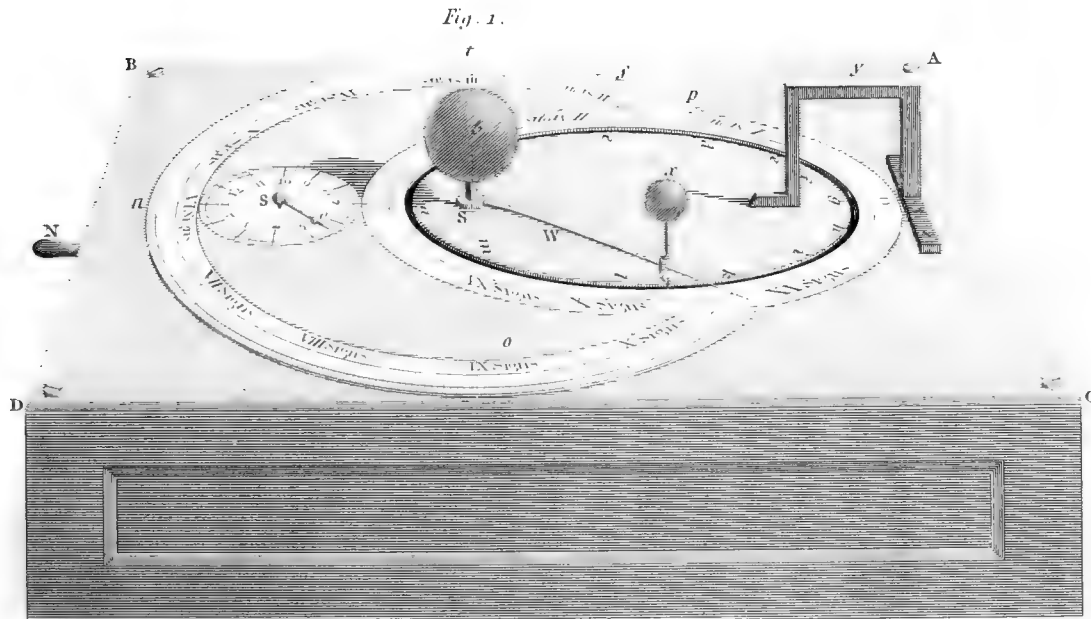


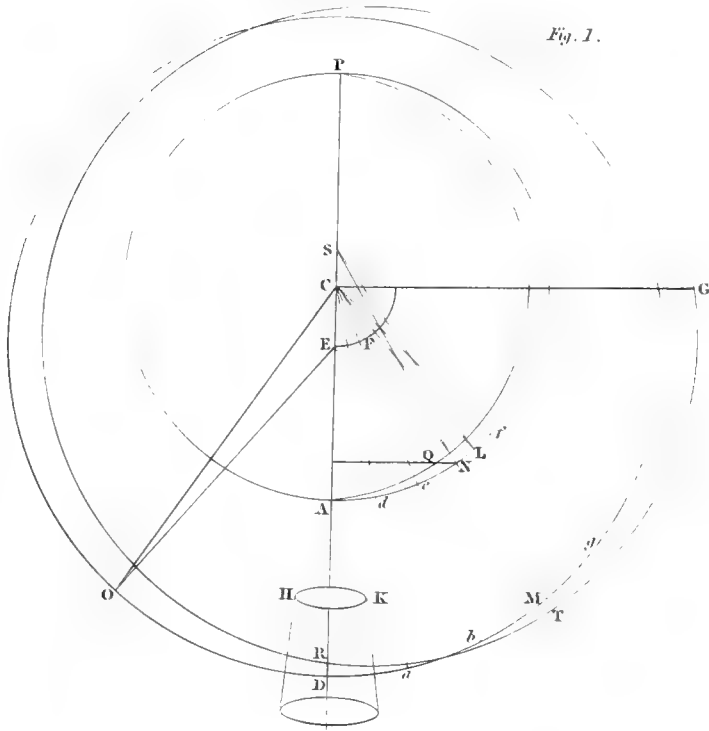
Fig. 1.



PLANETARY MACHINES.
EQUATION MECHANISM OF A PLANET'S ORBIT.

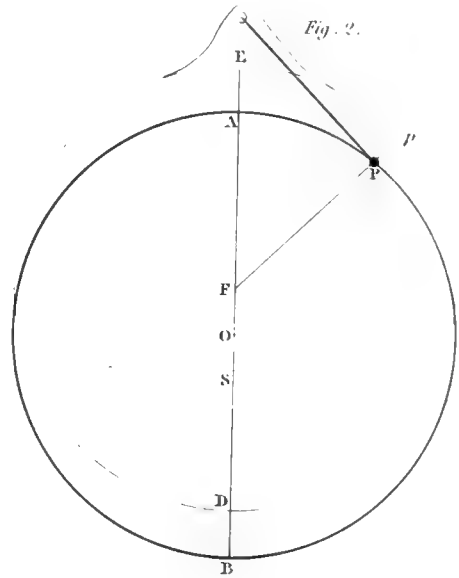
By *M^r Huygens.*

Fig. 1.



By *M^r Jos. Priestley.*

Fig. 2.



By the *Rev^d W. Pearson.*

Fig. 4.

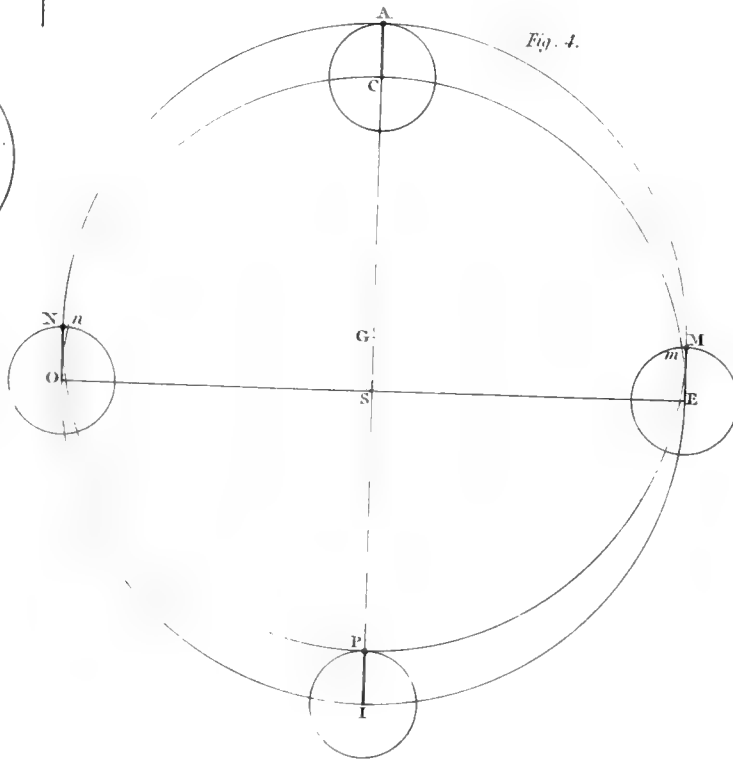


Fig. 5.

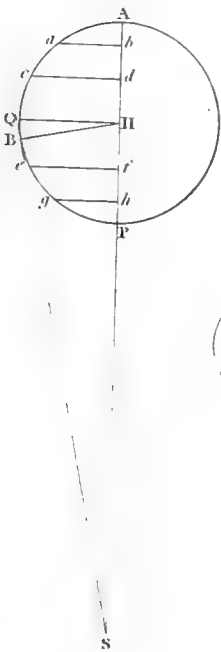
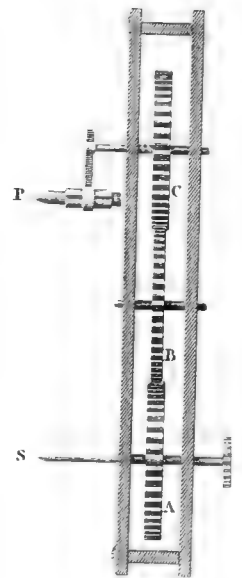
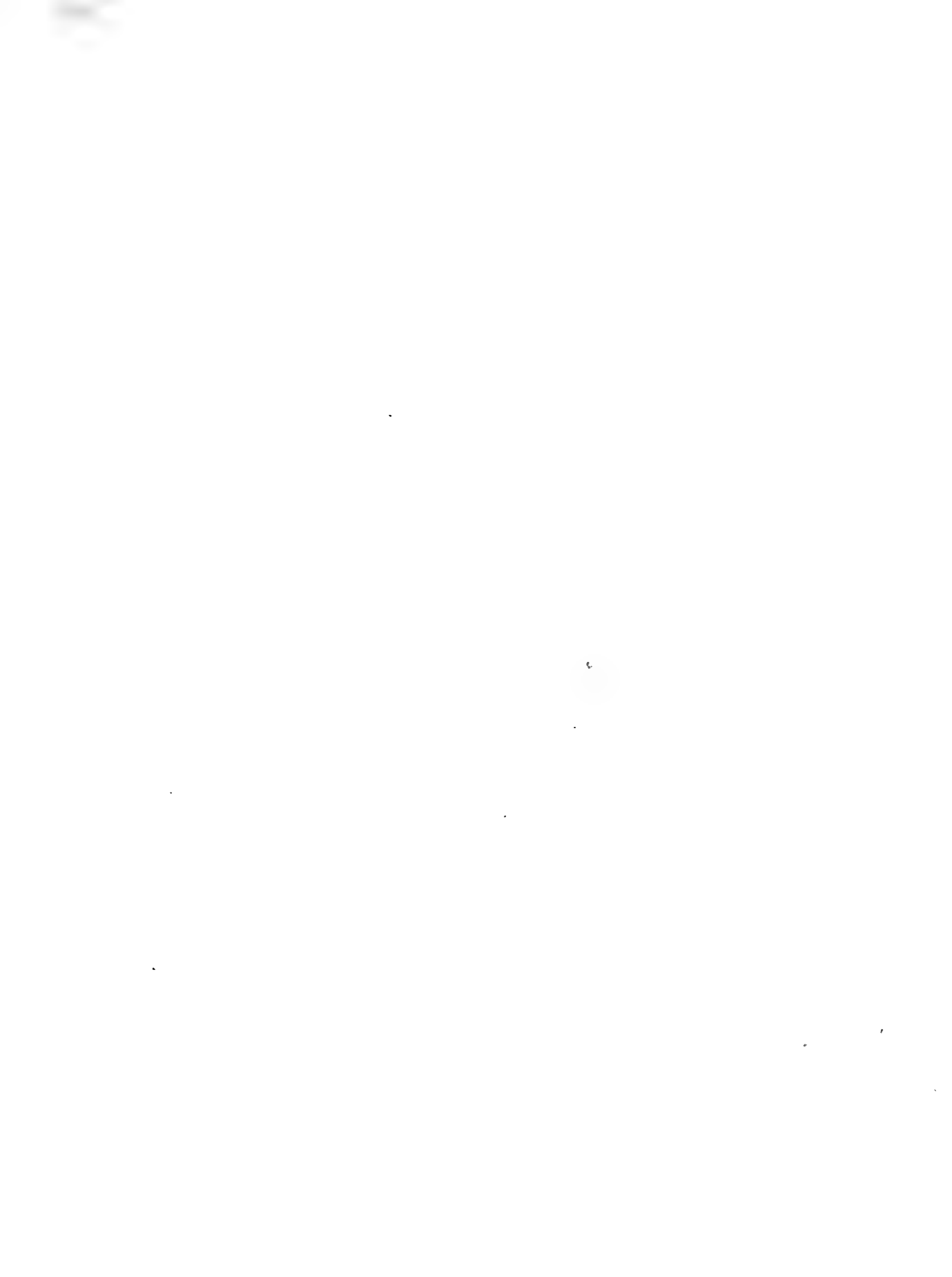


Fig. 3.





PLANETARY MACHINES,
 EQUATION MECHANISM OF A PLANET'S ORBIT.
 By the Rev.^d W. Pearson.

Fig. 1.

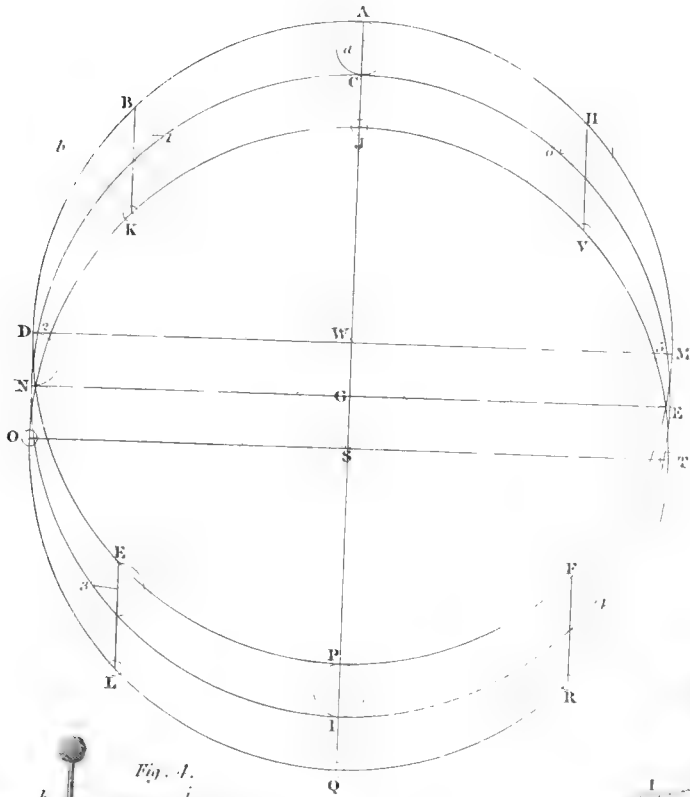


Fig. 2.

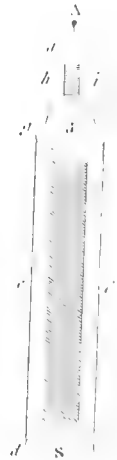


Fig. 1.

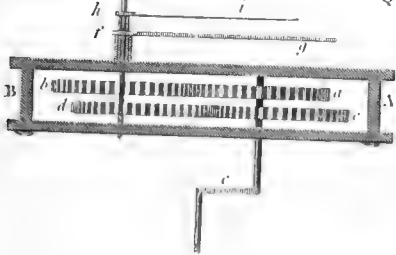


Fig. 3.

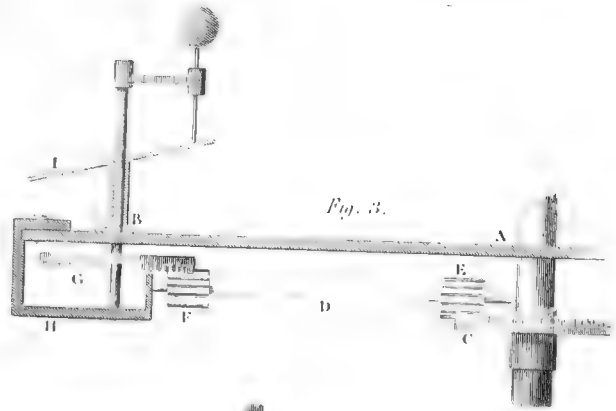


Fig. 5.

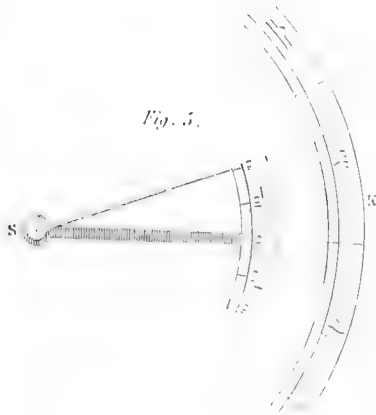
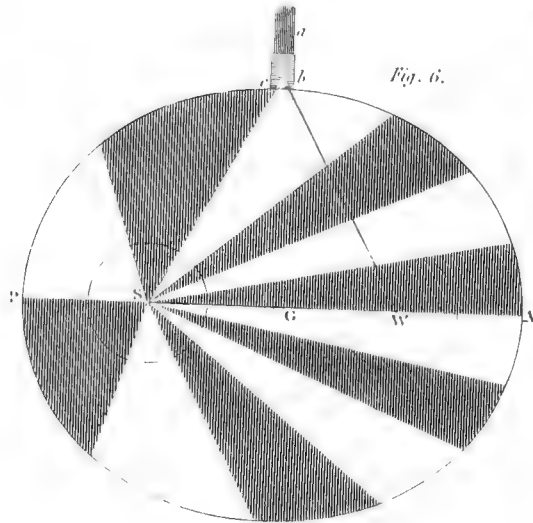
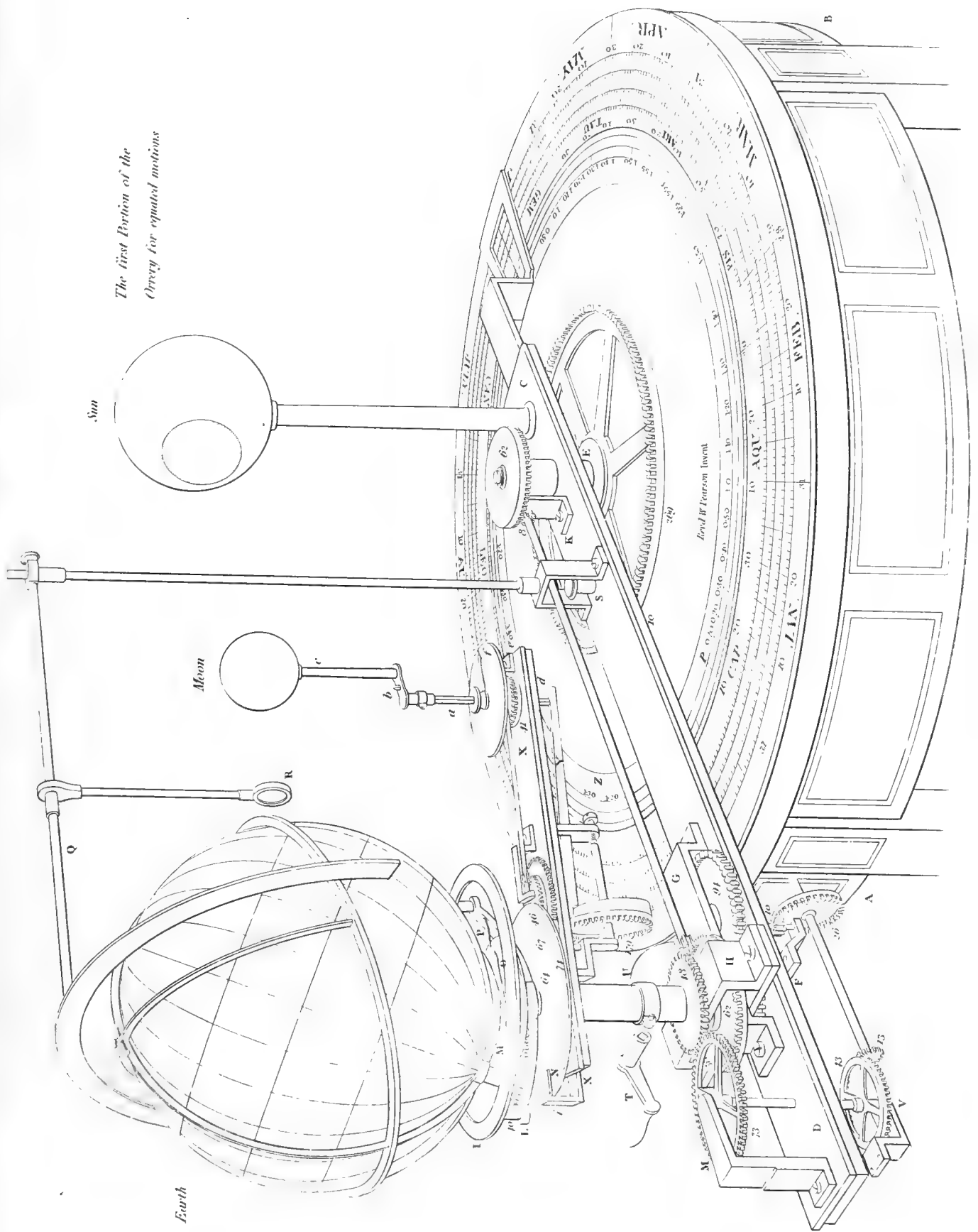
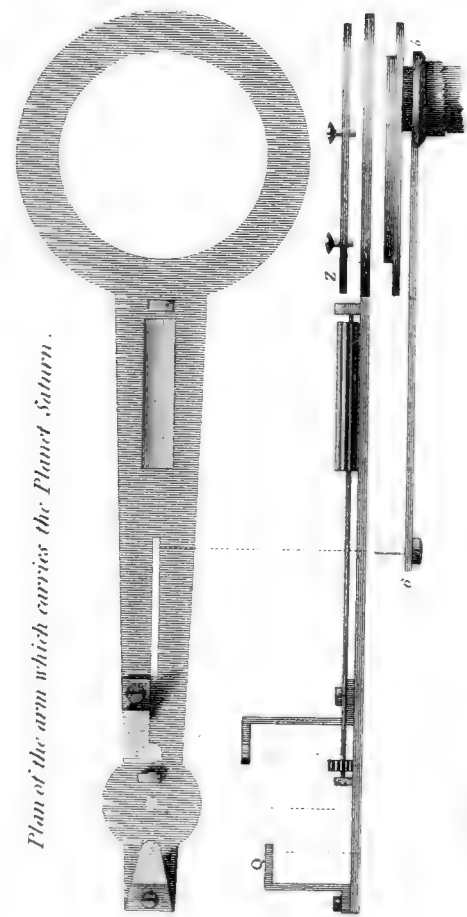
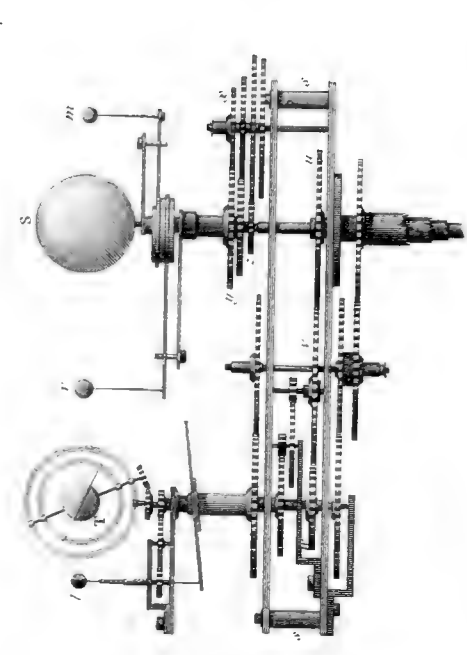
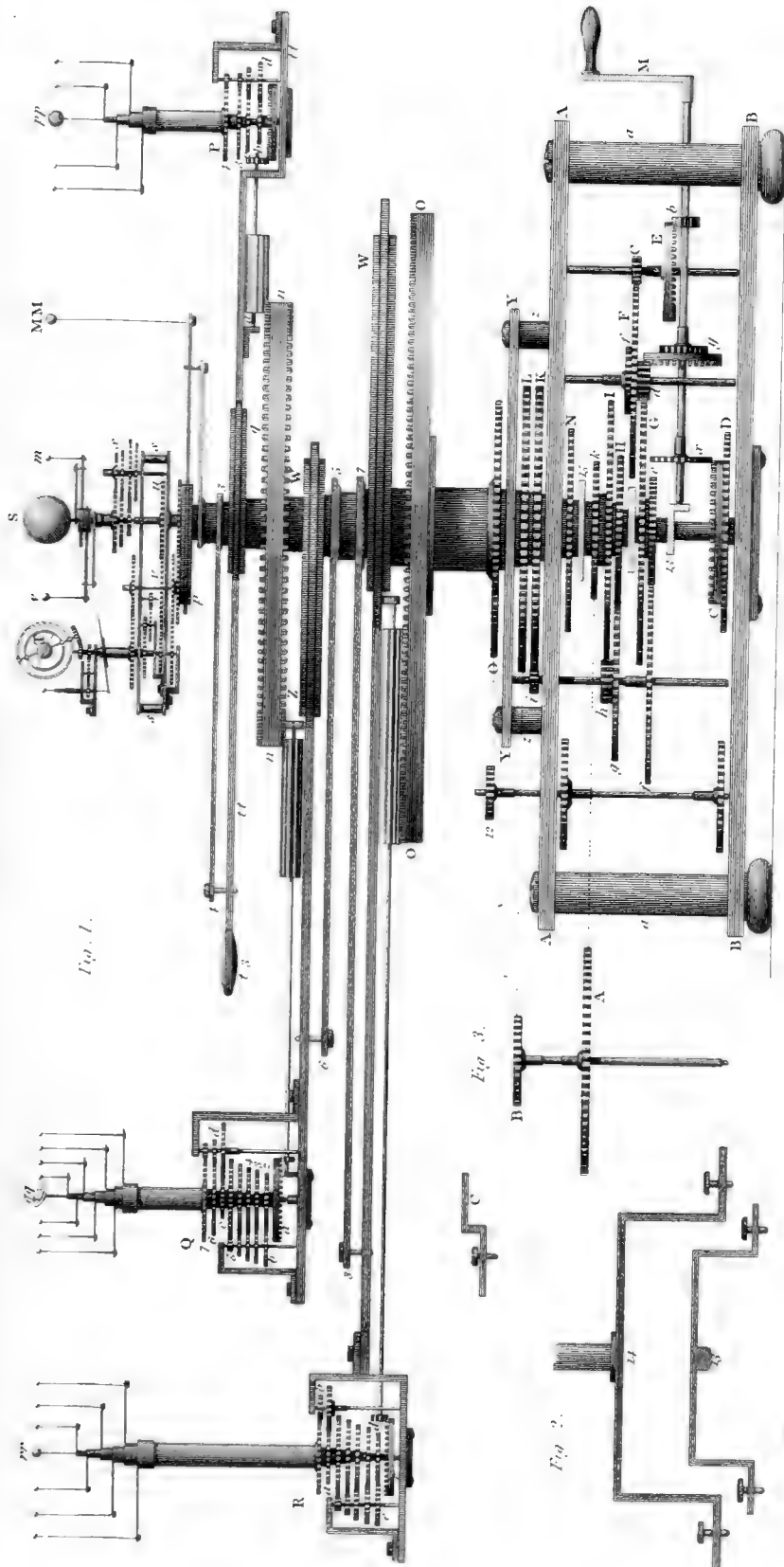


Fig. 6.



The first Portion of the
Orrey for equated motions





Plan of the arm which carries the Planet Saturn.

Section of the improved ORRERY for mean motions.

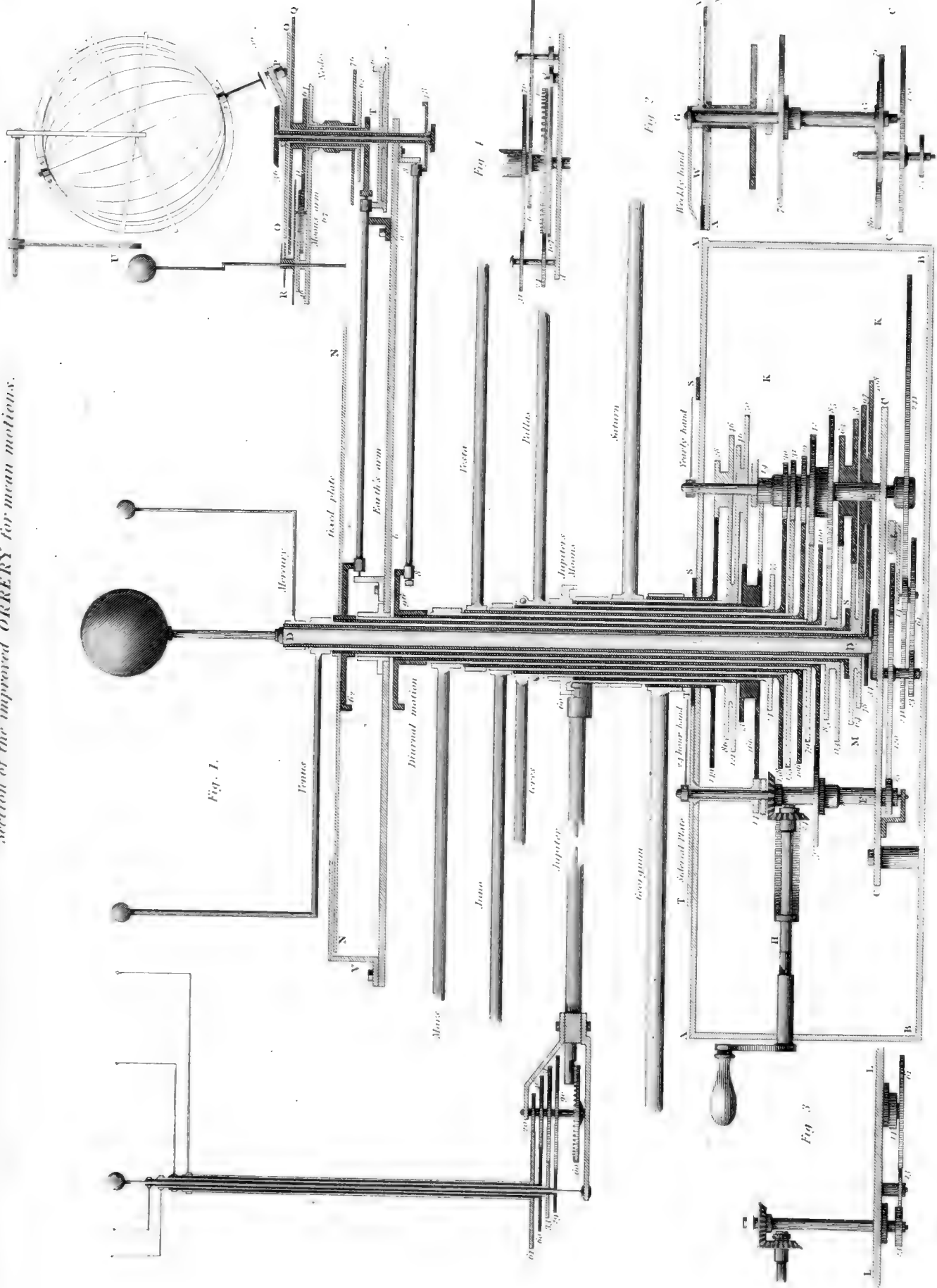


Fig. 1.

Fig. 2.

Fig. 3.

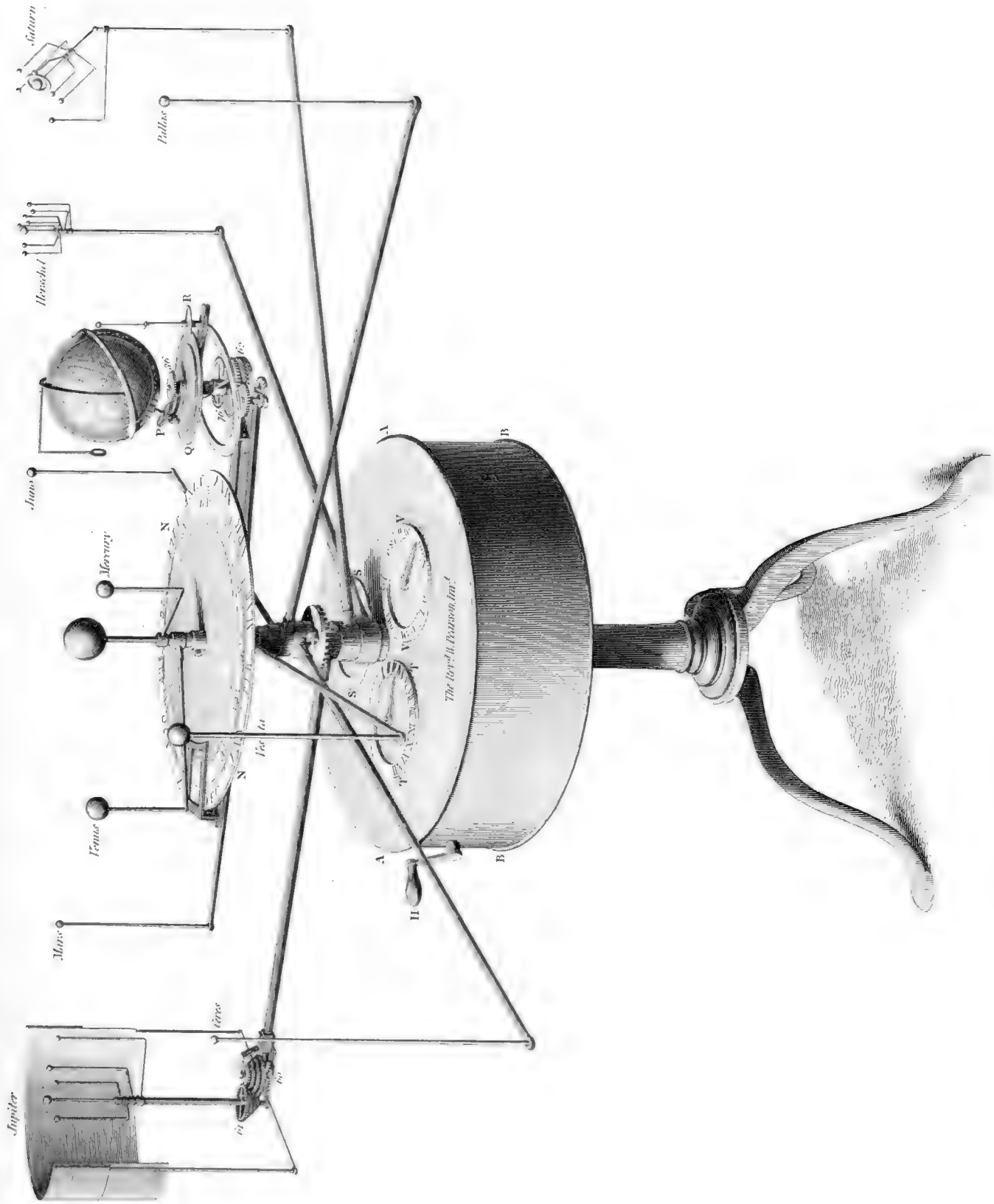
J. Ivory del. scul.

R. Fidler fecit.

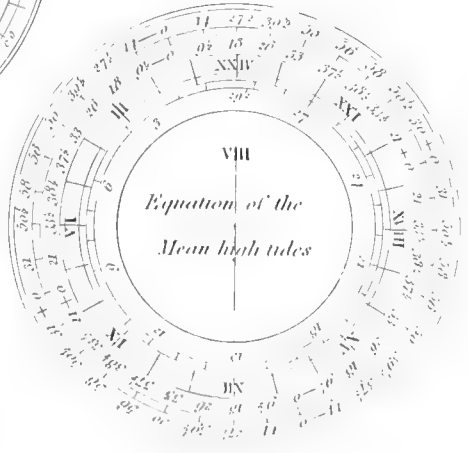
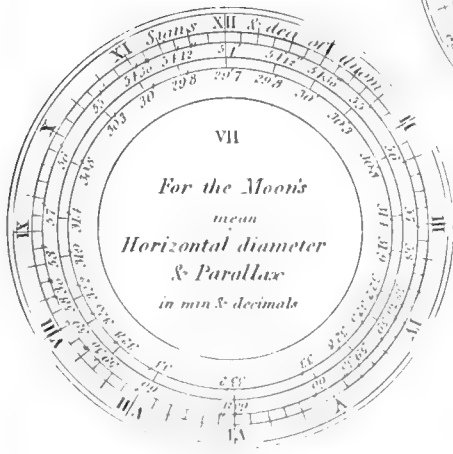
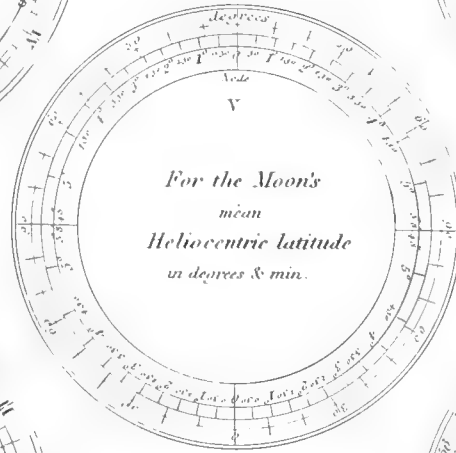
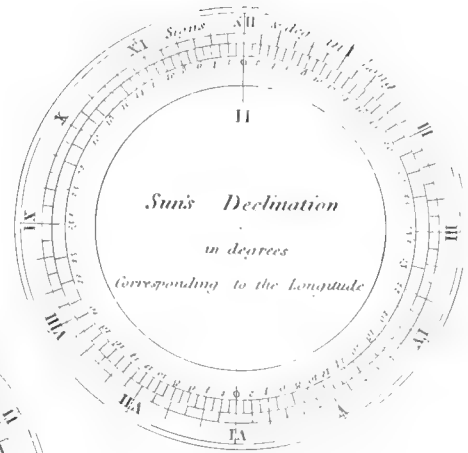
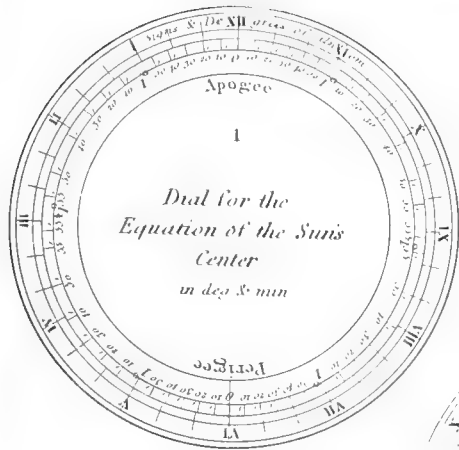
Published as the Act directed, 1855, by Longman, Hurst, Ross, Orme & Brown, Paternoster Row.

W. & A. G. & Co. Lith.

Prospective view of the improved ORRERY for moon motions.



*Dials graduated for shewing
different planetary Phenomena
[see Orrey]*



PLANETARIUM

of the Royal Institution by M. Pearson.

Common PLANETARIUM.

Fig. 1.

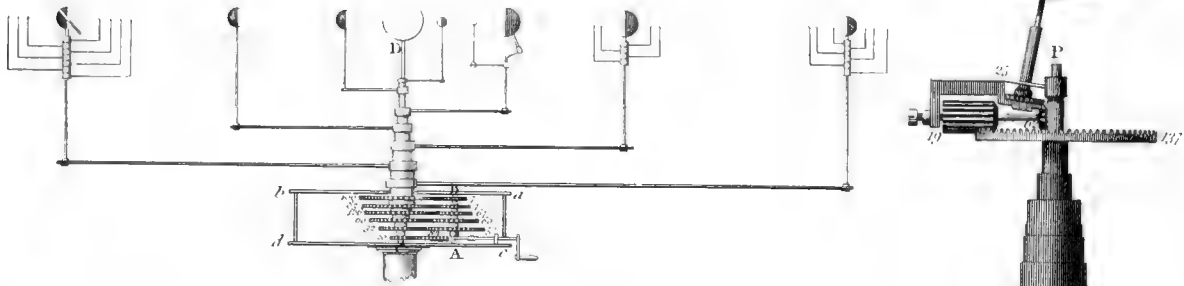


Fig. 1.

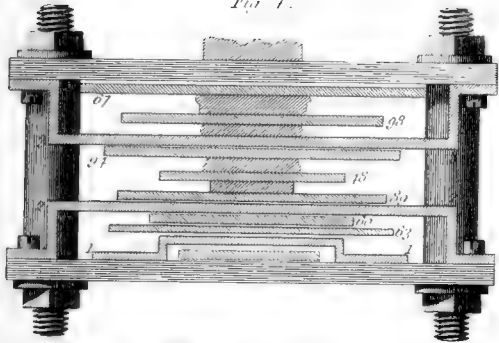


Fig. 3.

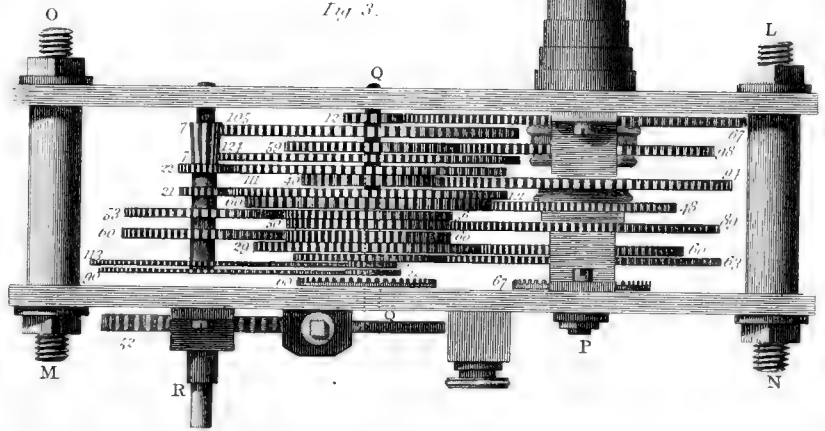
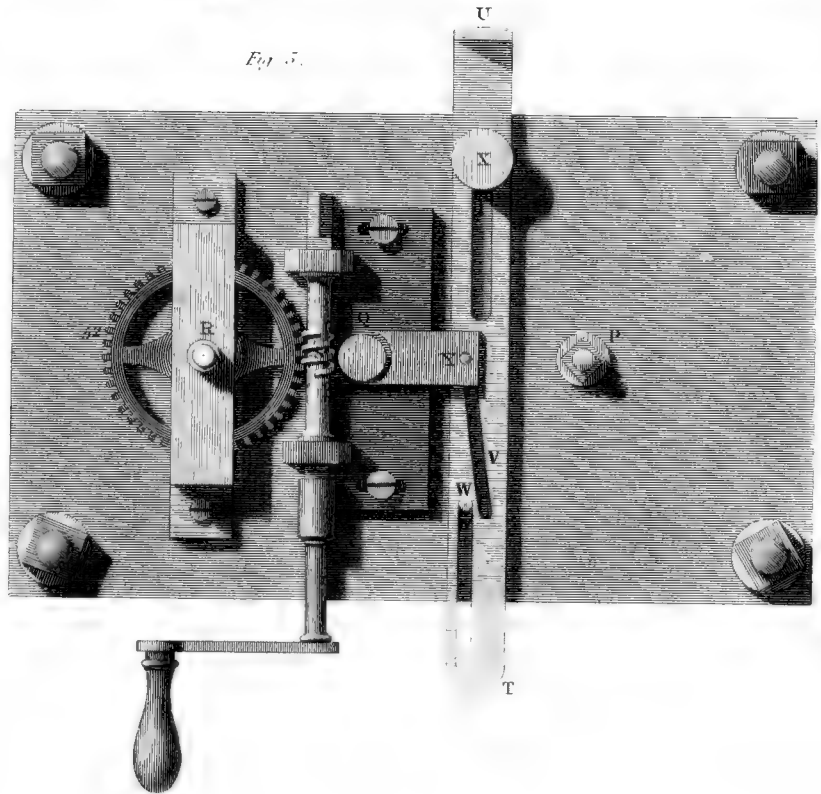


Fig. 2.



Fig. 5.



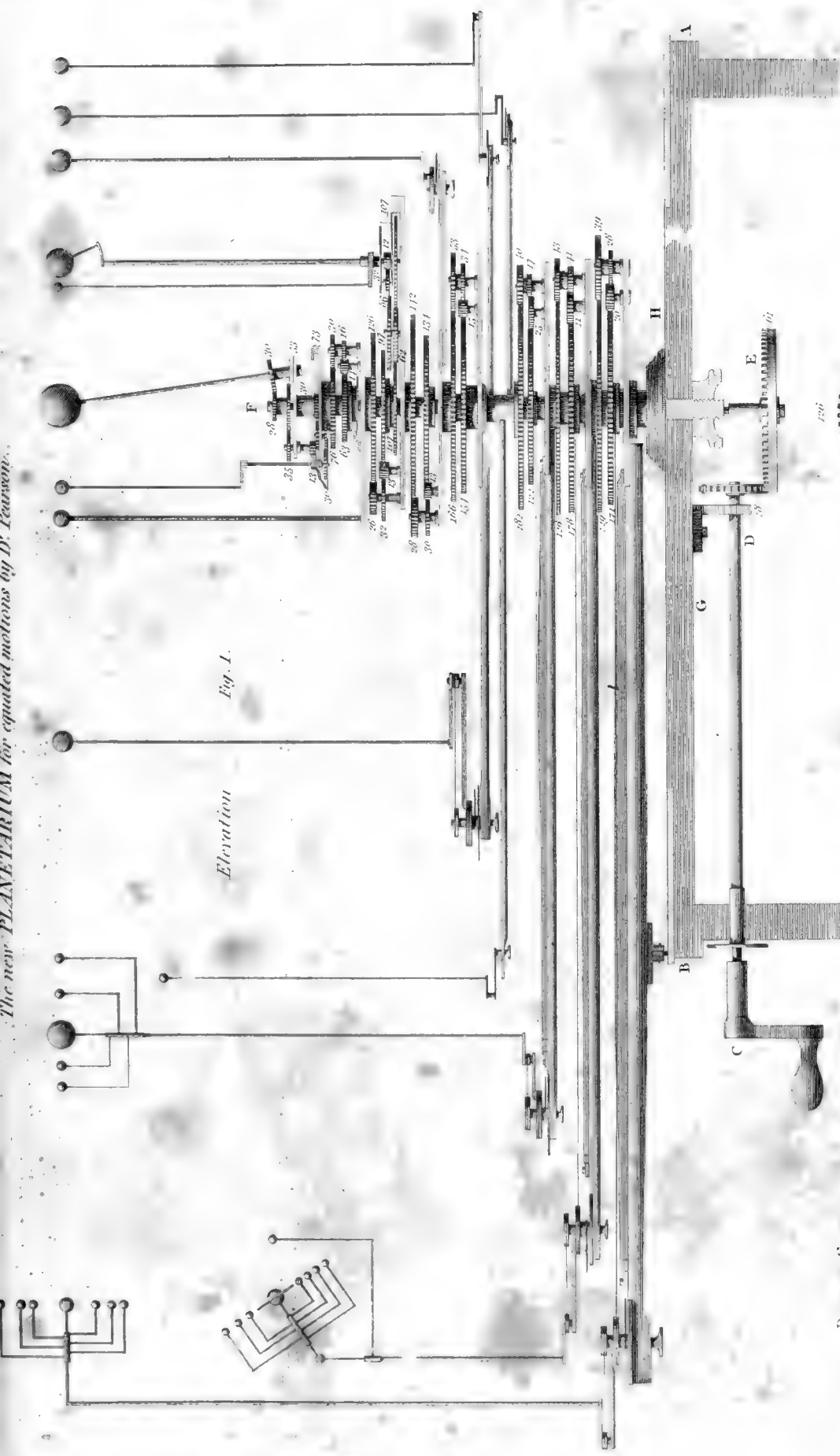


Fig. 1. Elevation

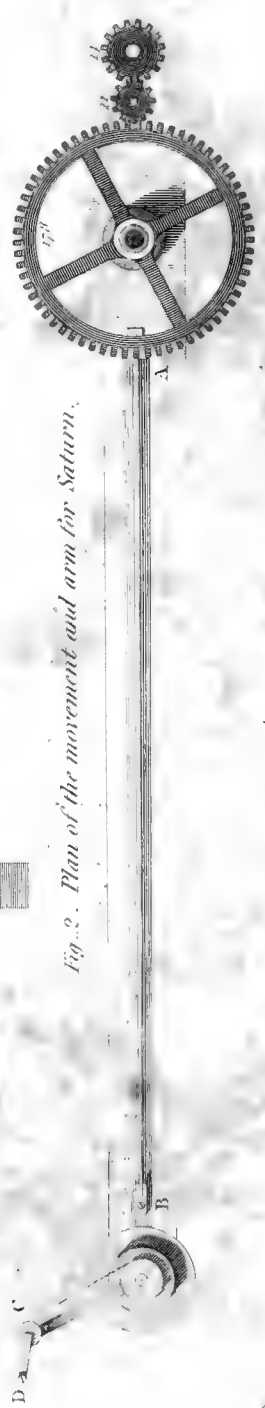
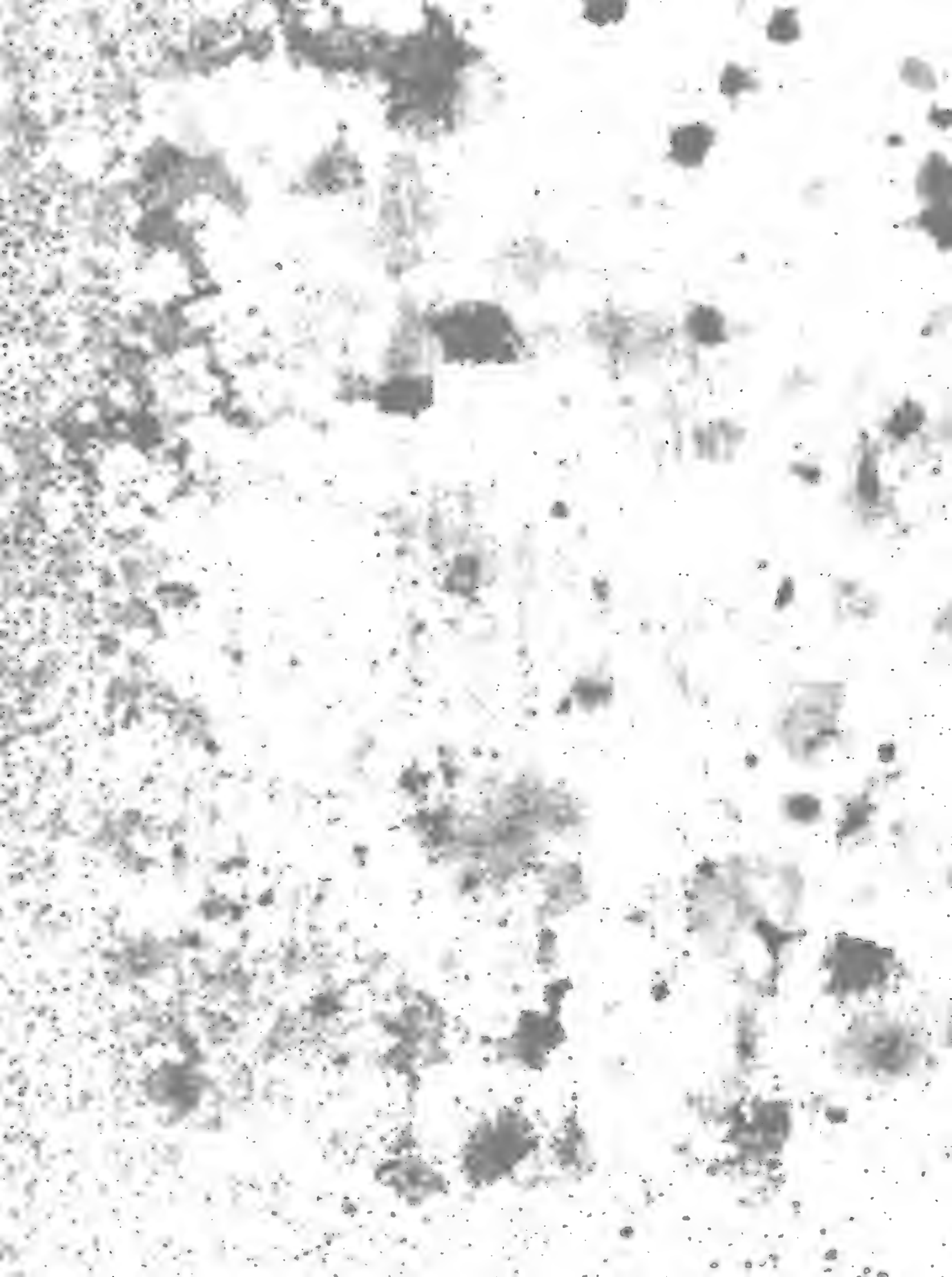


Fig. 2. Plan of the movement and arm for Saturn.



SATELLITE MACHINES.

Fig. 3.



Configuration of Satellites. Ap. 1. 1853. at 10.^b
Fig. 4.



SATELLITE Machine by Roemer.

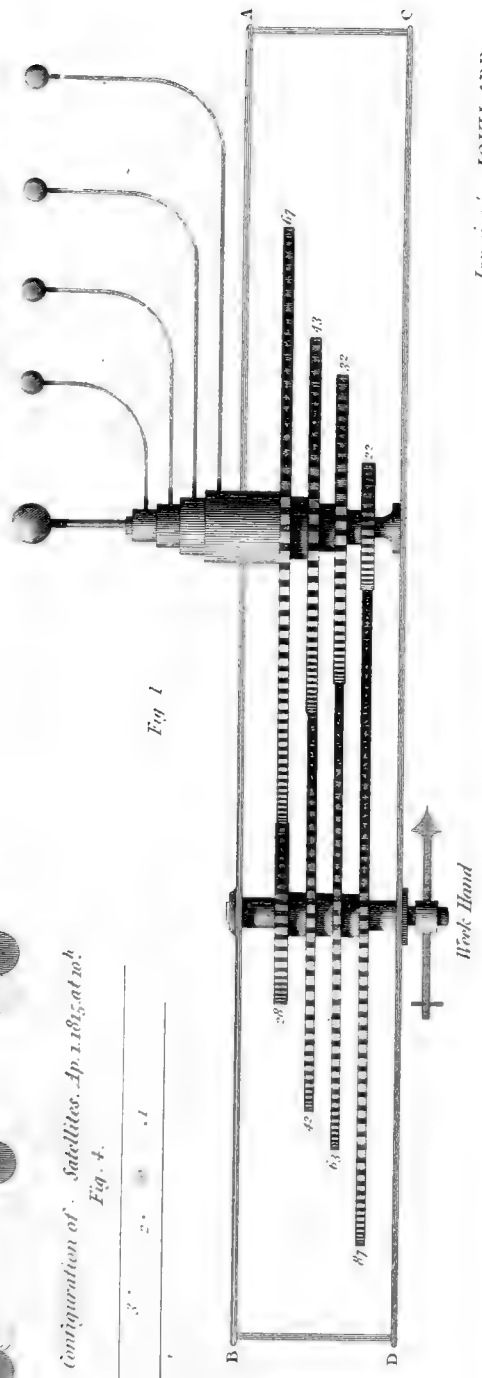


Fig. 1

JANVIER'S JOYLLABE.

SATELLITAN by The Rev. Wm PEARSON.

Fig. 2.

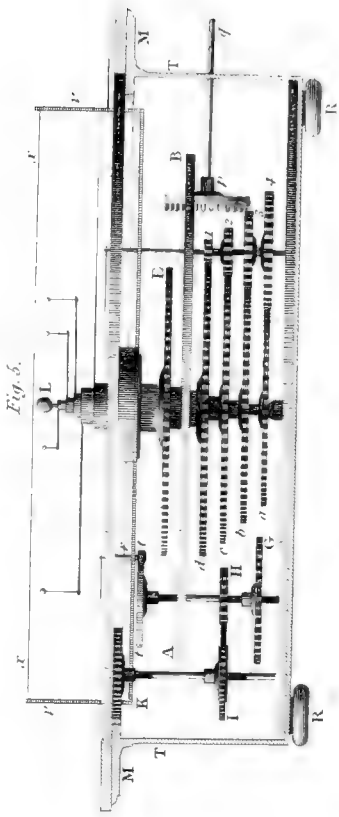
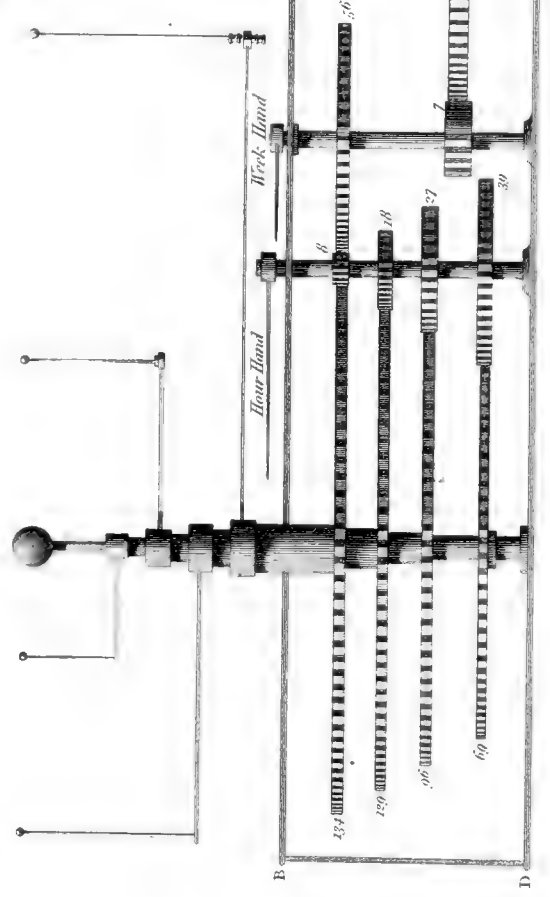


Fig. 5.

*Rev^d W. Pearson's
large Machine
for Jupiter's Satellites*

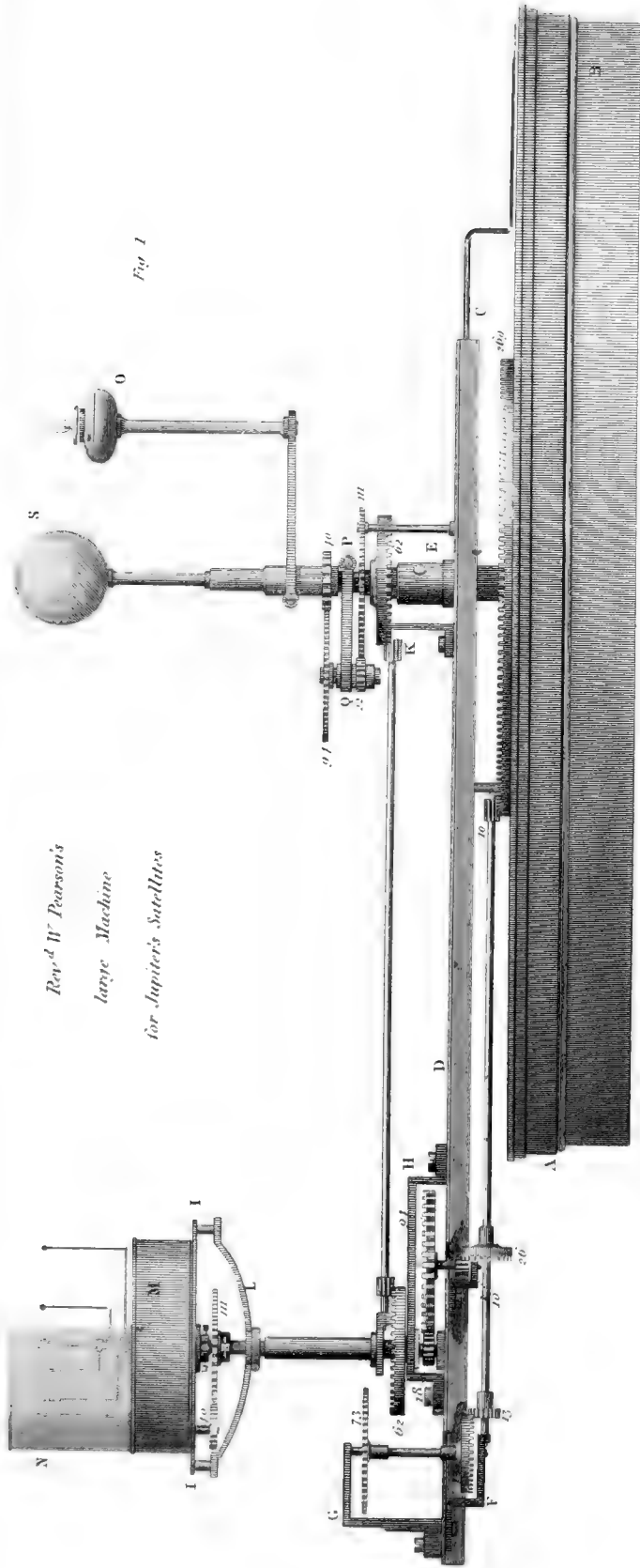


Fig 1

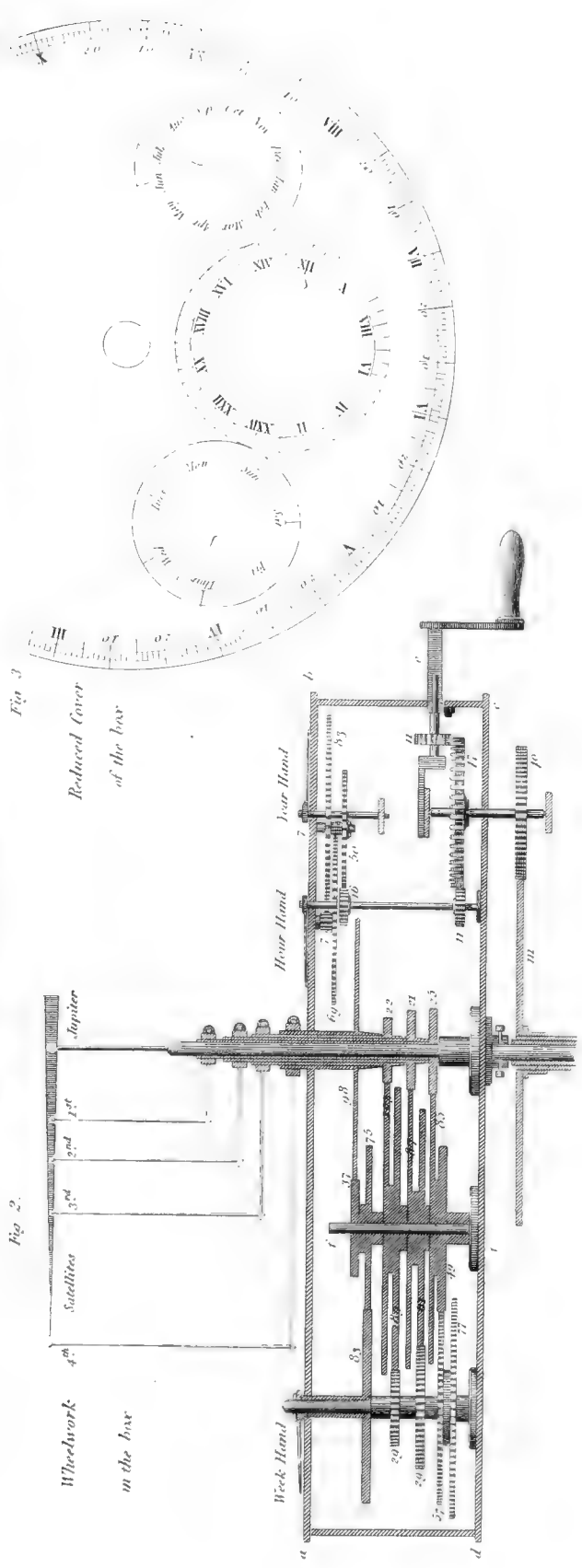


Fig 3

Fig 2

PLANING.

M. Bramah's Planing Machine.

Fig. 6.

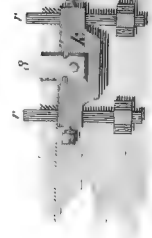


Fig. 7.

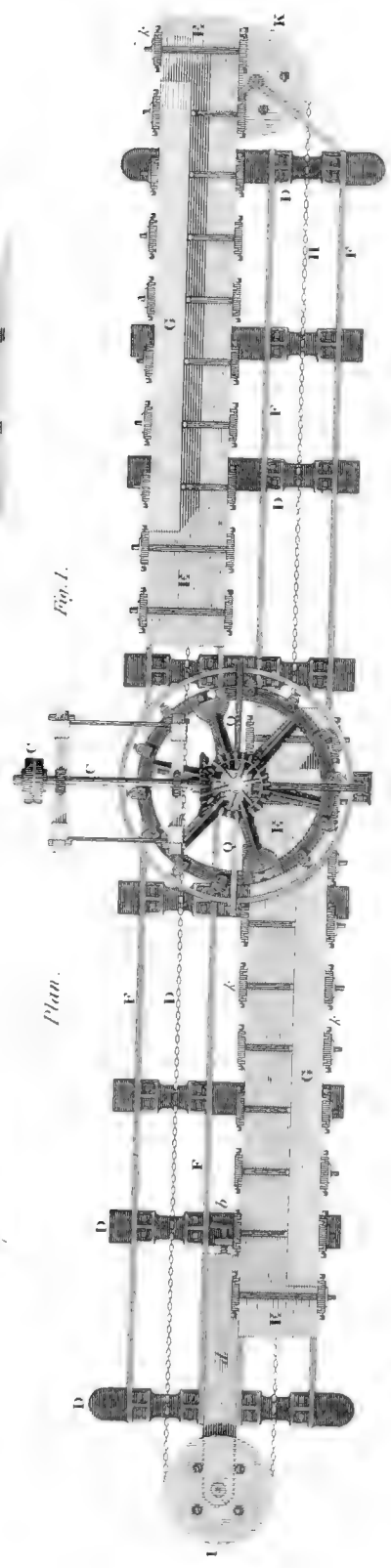


Fig. 1.

Plan.

Fig. 4.



Fig. 3.

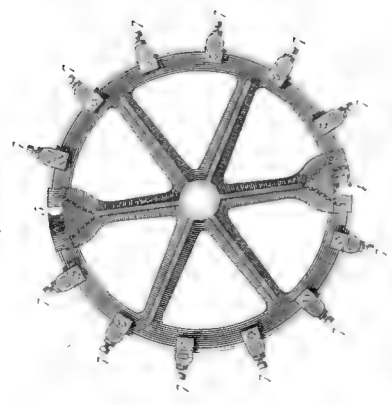


Fig. 5.

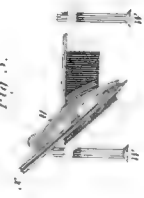
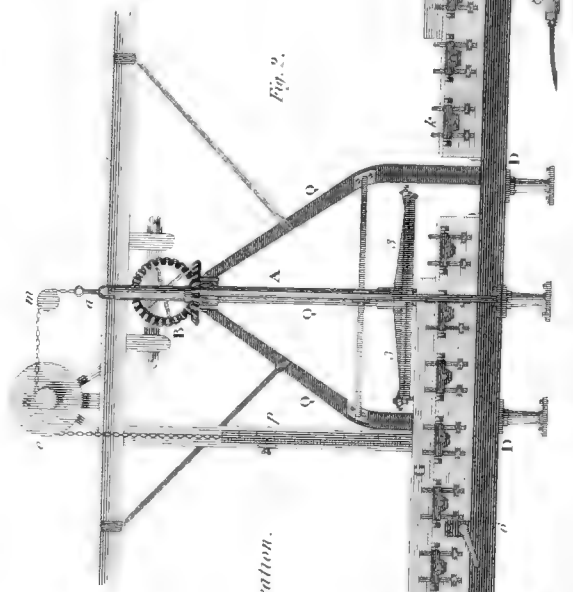


Fig. 2.



Elevation.





Cross Section,
Fig. 9.

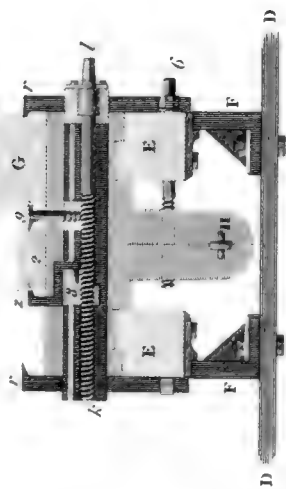
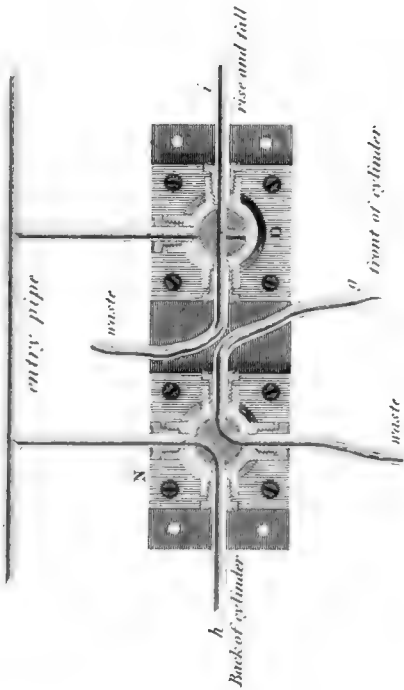


Fig. 12.



Cylinder
Fig. 10.

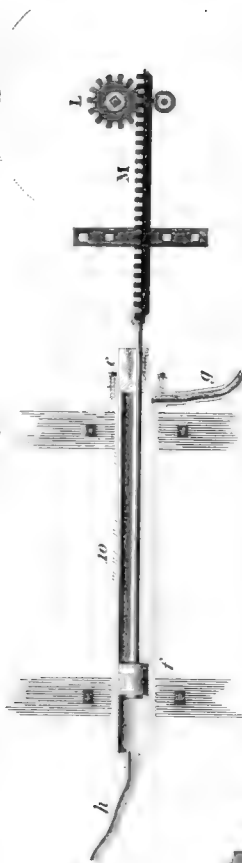
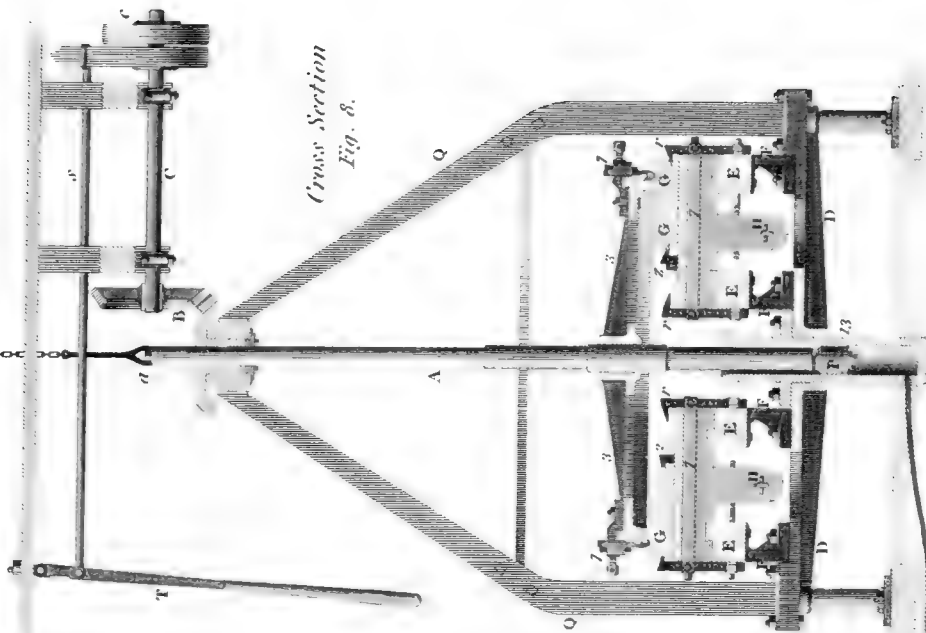


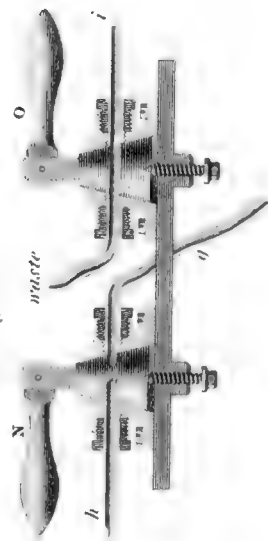
Fig. 13.



Cross Section
Fig. 8.



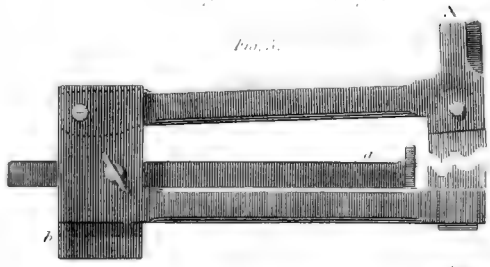
Cocks,
Fig. 11.



Back of cylinder,
waste
front of cylinder

PLATED MANUFACTURE.

Bit Swage for mountings.



Common Swage.

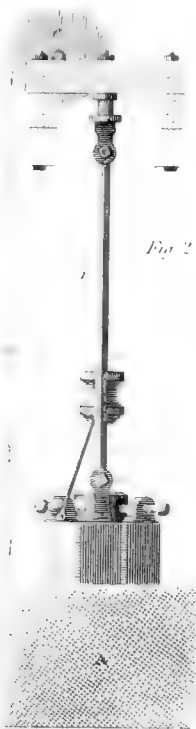
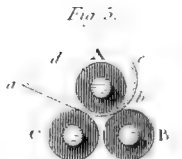
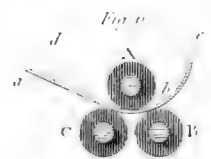
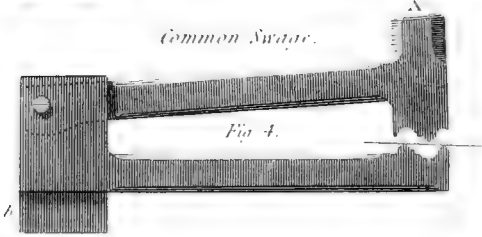


Fig. 2

Die Stamp.

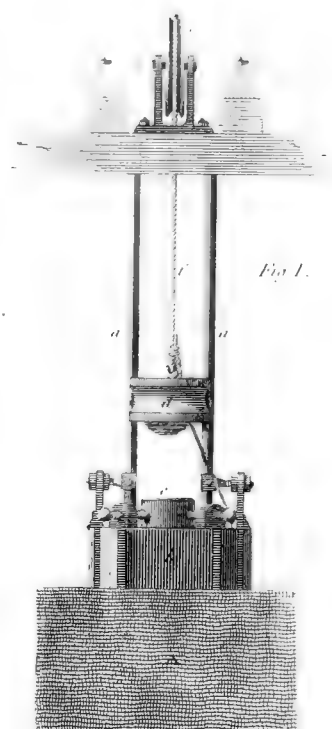


Fig. 1.

Embossing Punches.

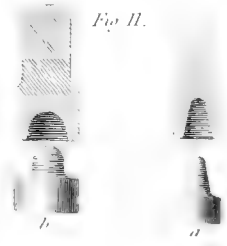


Fig. 11.

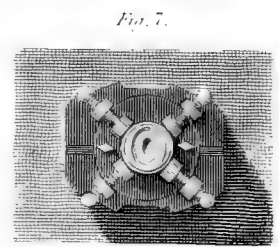


Fig. 7.

Furnace.

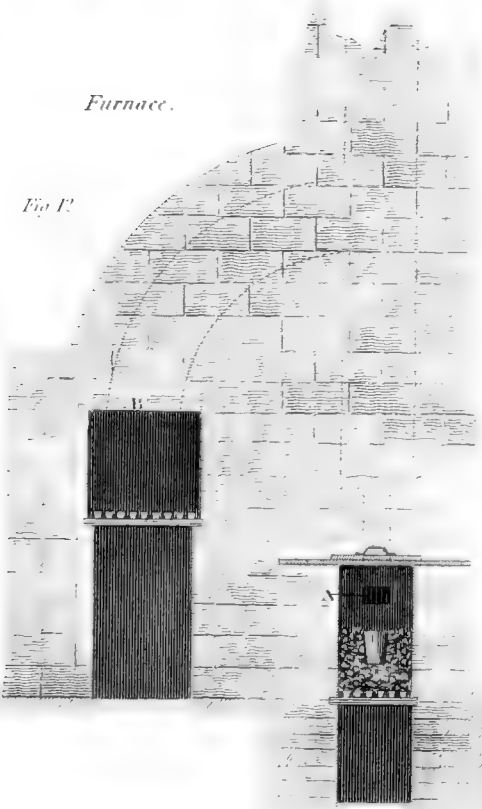


Fig. 12.

Grooved Rollers for heads &c.

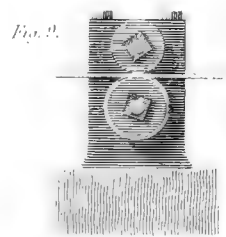


Fig. 9.

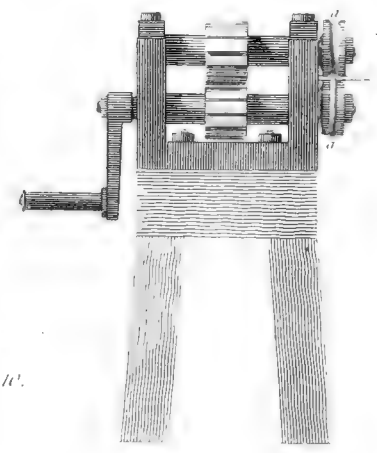


Fig. 8.



Fig. 10.

AEROSTATION

ECLIPSE

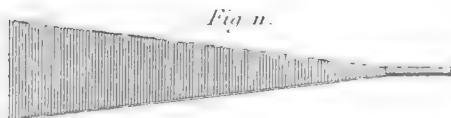
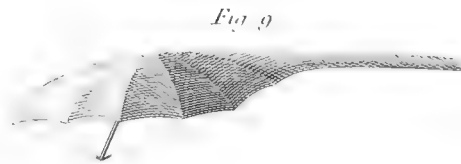
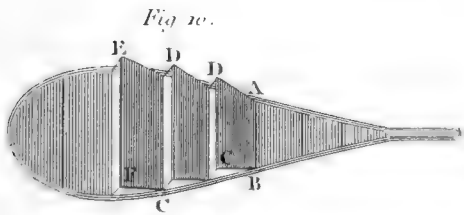
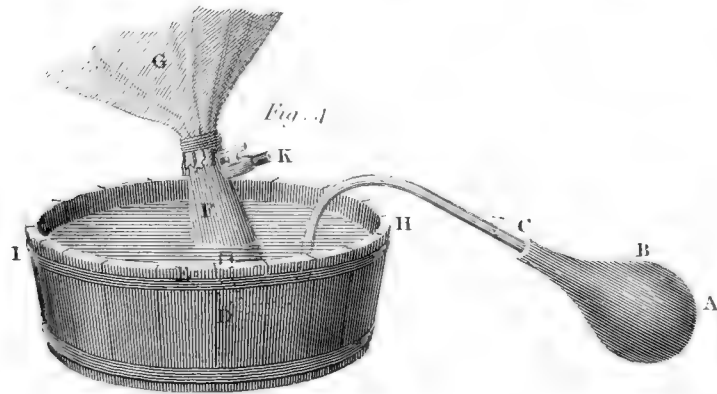
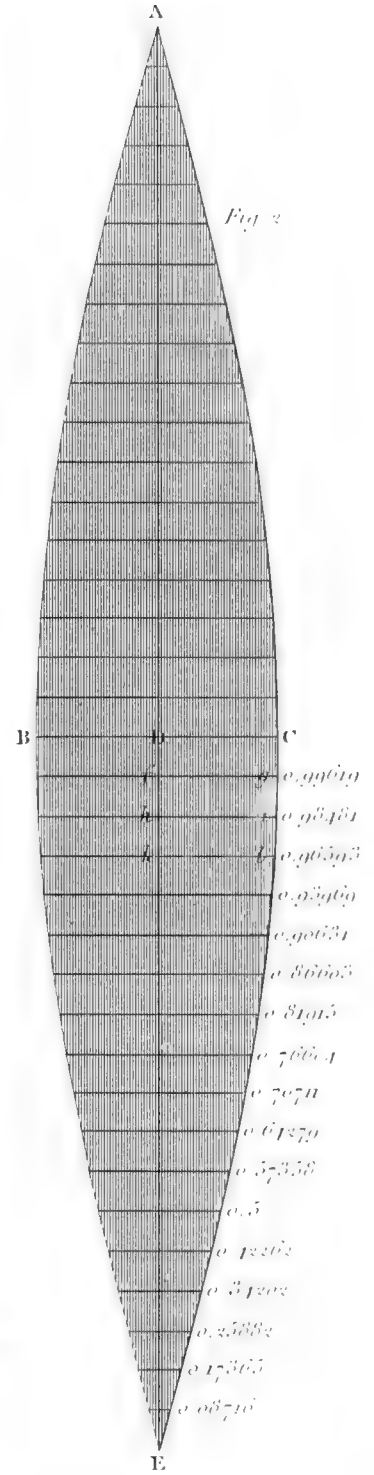
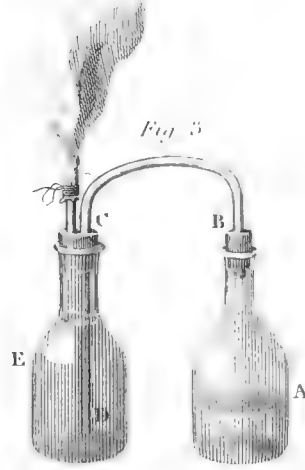
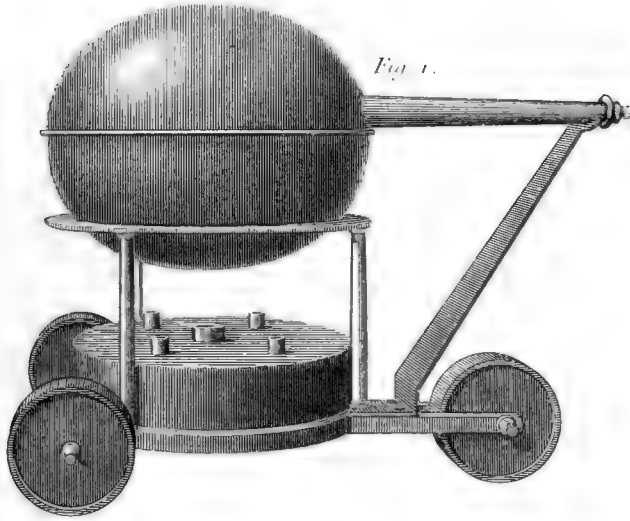
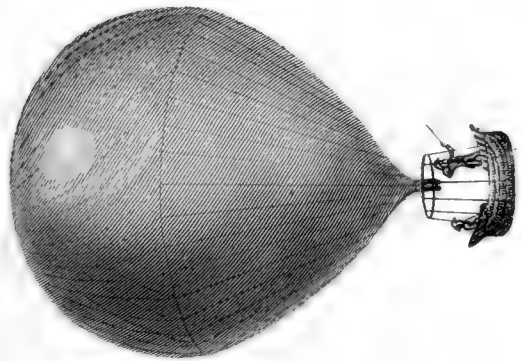


Fig. 8.



PNEUMATICS.

AEROSTATION.

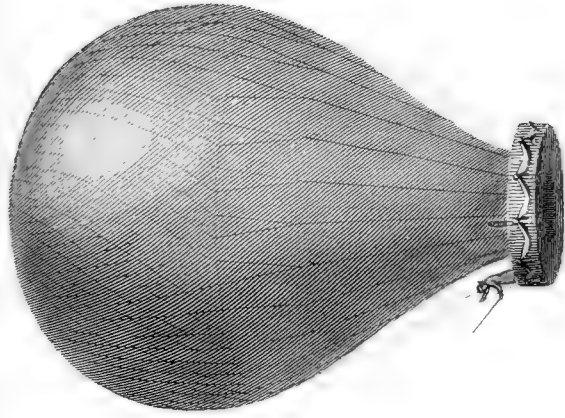


Fig. 6.

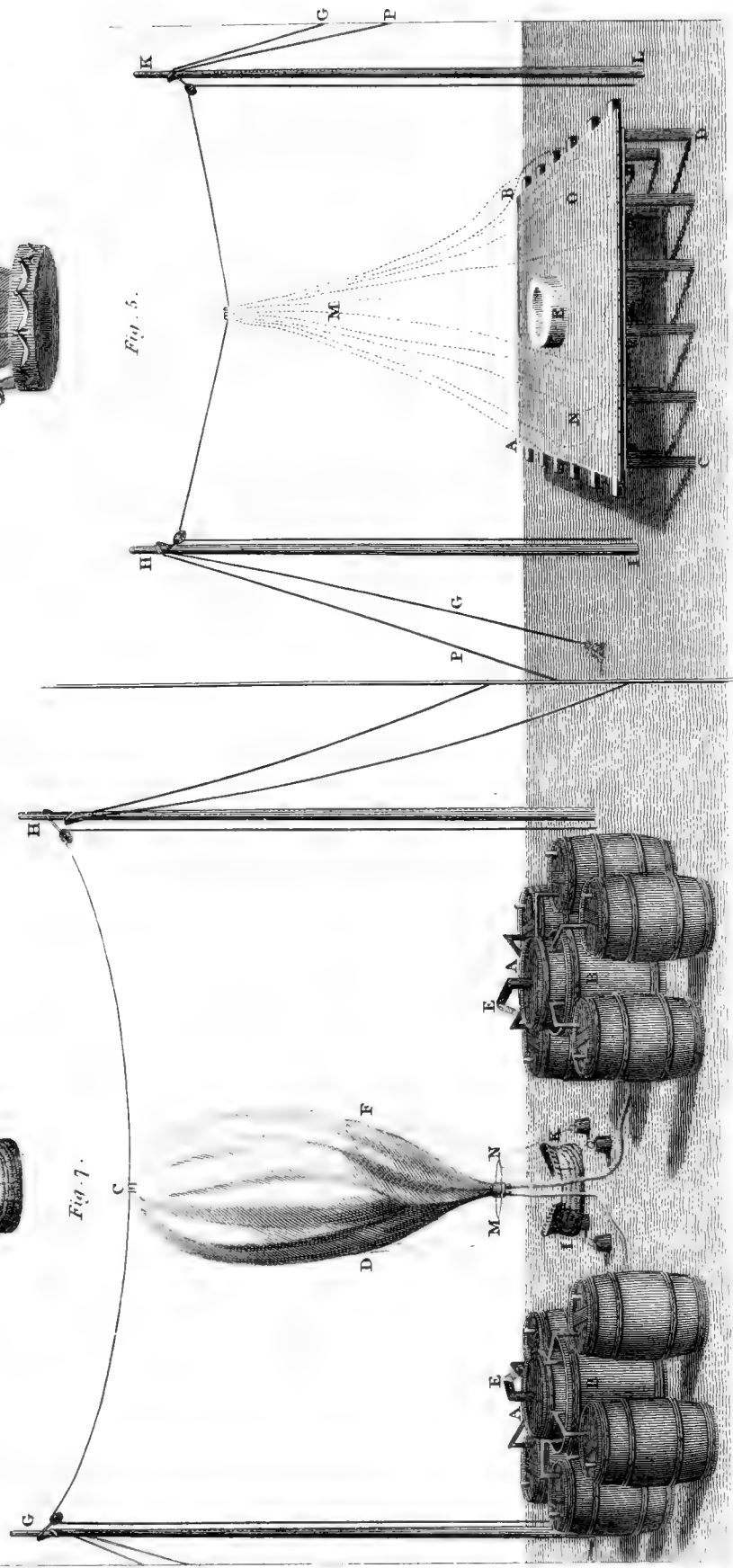
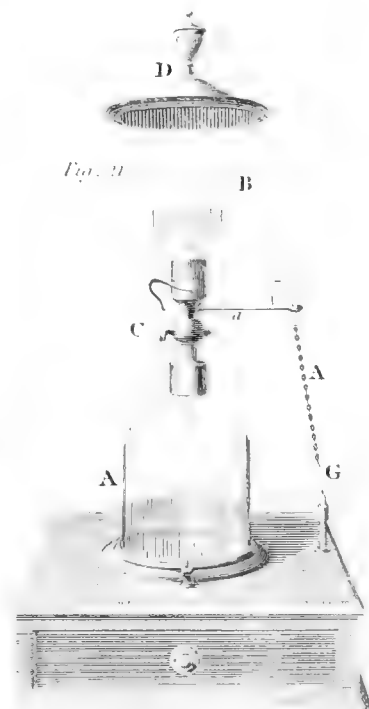
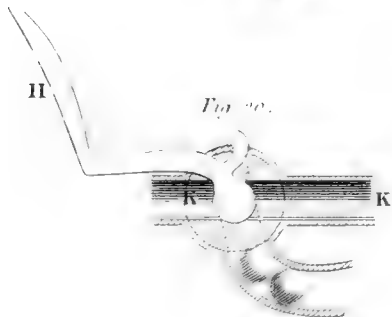
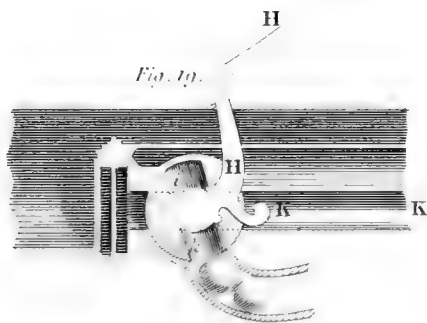
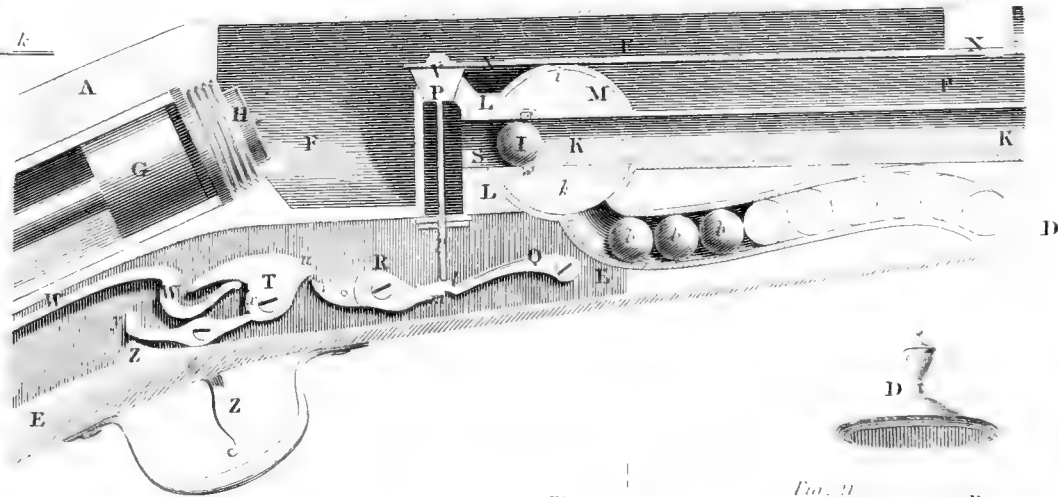
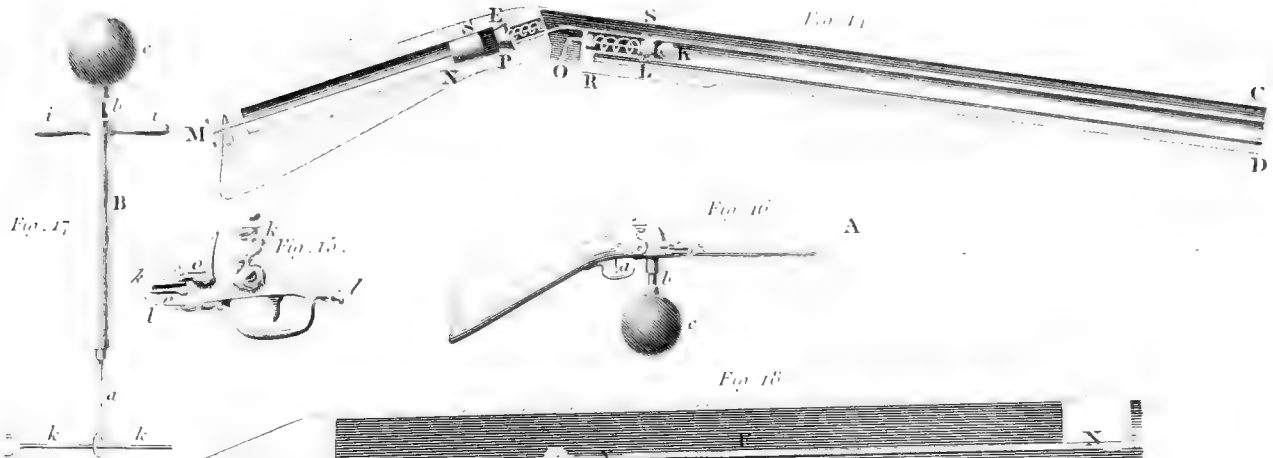


Fig. 5.

Fig. 7.

Published as the Act directed, Oct. 3, 1863, by Longman & Reed, Patentee & Rev.

Approved by W. L. Lowry.



AIR-Pump and Experiments on AIR.

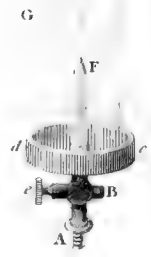
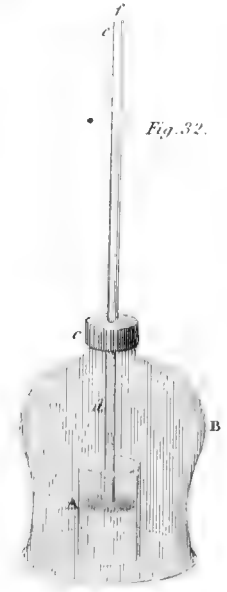
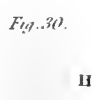
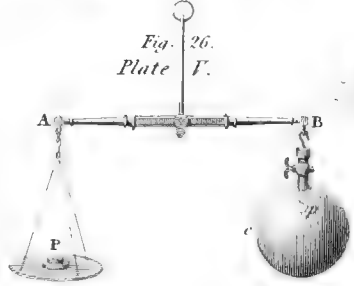
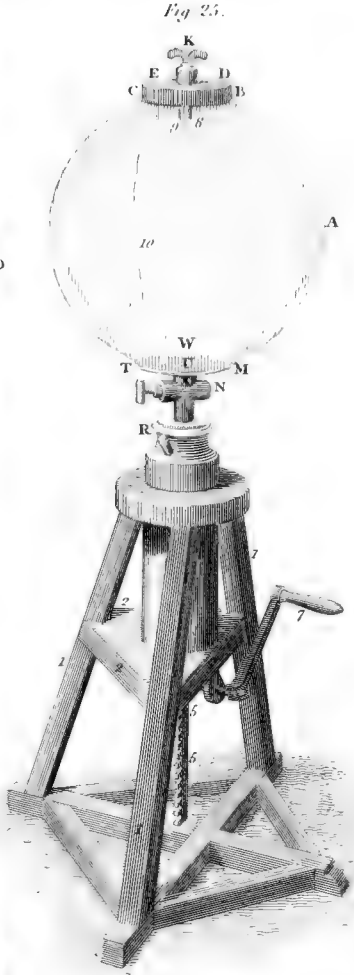
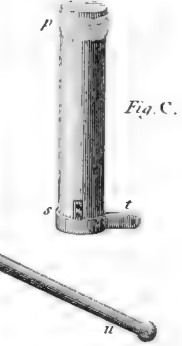
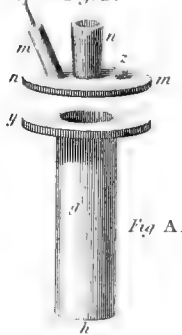
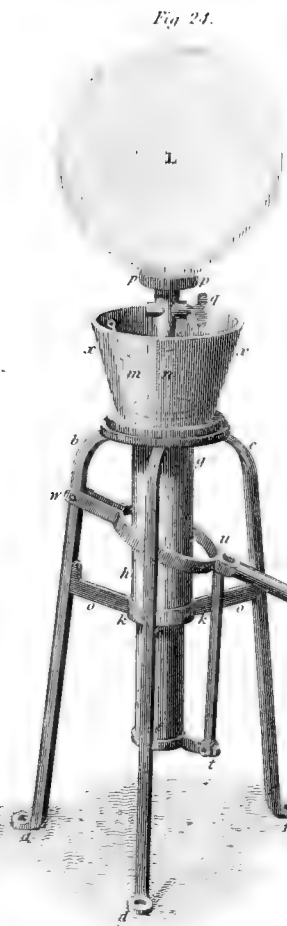


Fig. 35.



Fig. 36.



Fig. 37.

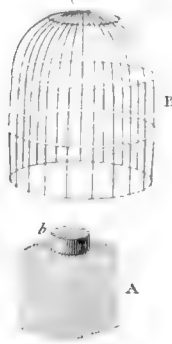


Fig. 39.

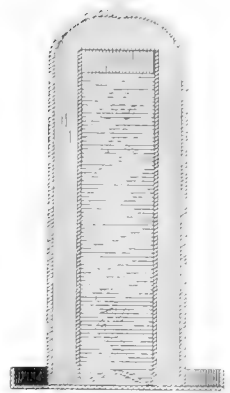


Fig. 38.

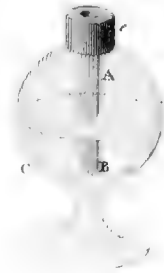


Fig. 33.

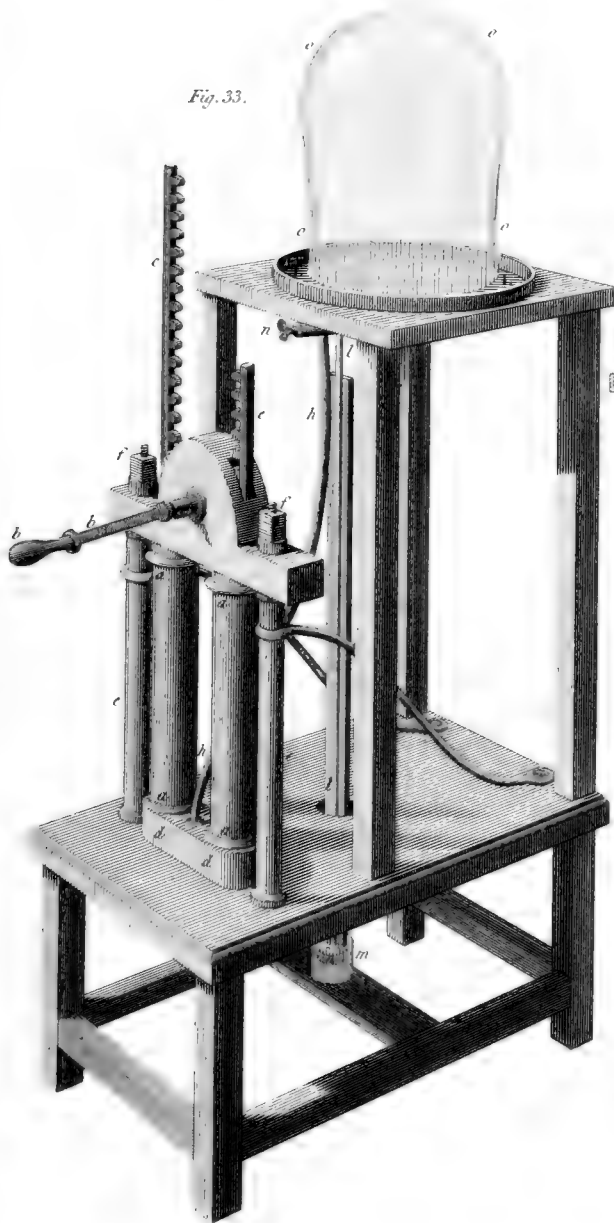


Fig. 40.



Fig. 42.

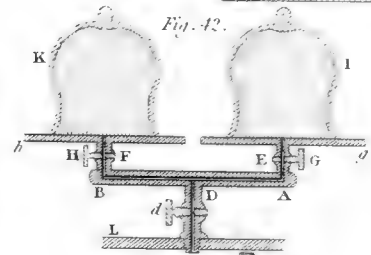


Fig. 43.

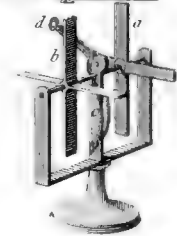


Fig. 41.

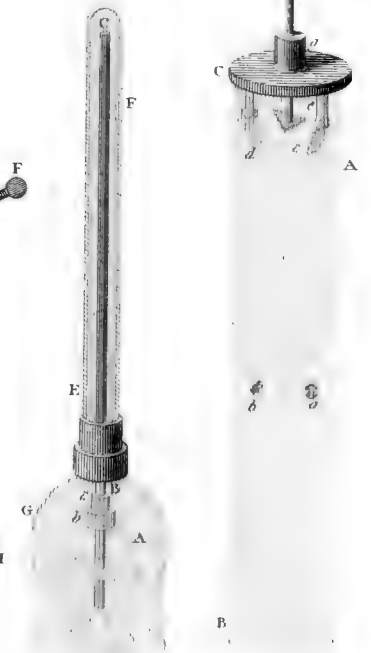


Fig. 34.

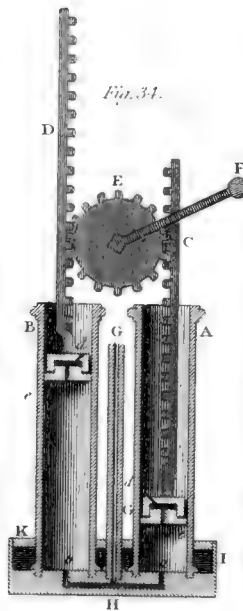


Fig. 44.



AIR PUMP.

Smeaton's

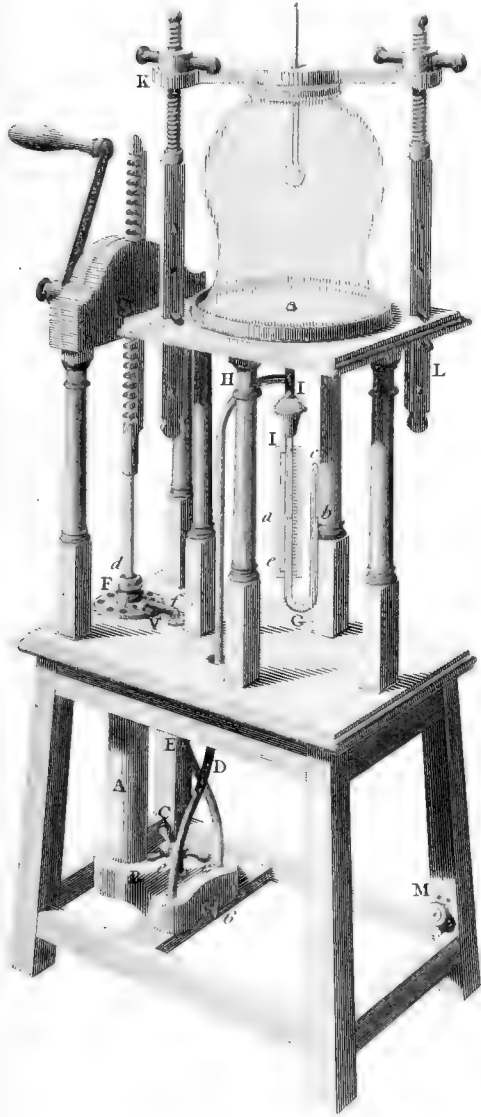


Fig. 45.

Nairne's

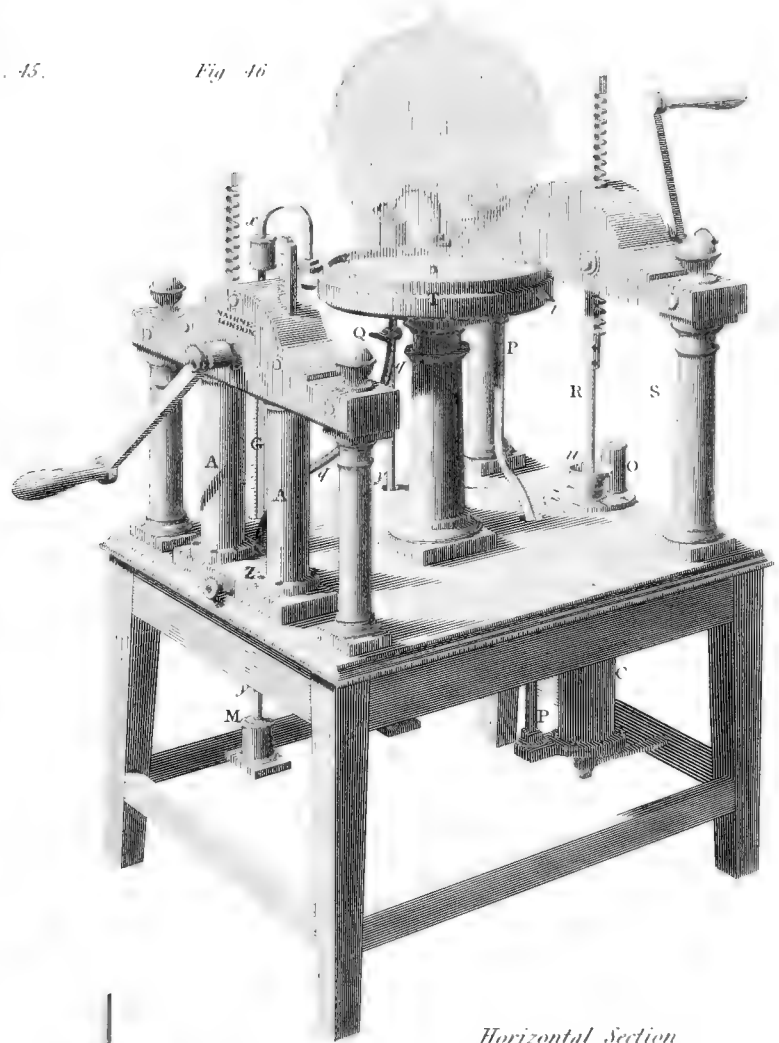


Fig. 46.

Horizontal Section

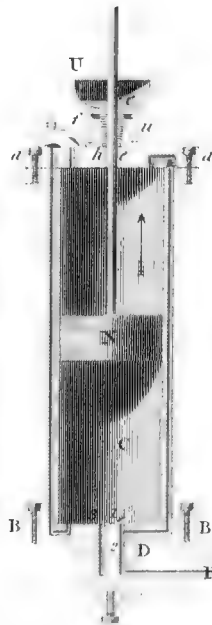


Fig. 47.

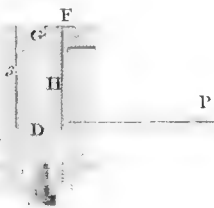


Fig. 48.

Fig. B.B.



Fig. 49.



AIR PUMP &c.

Fig. 48.

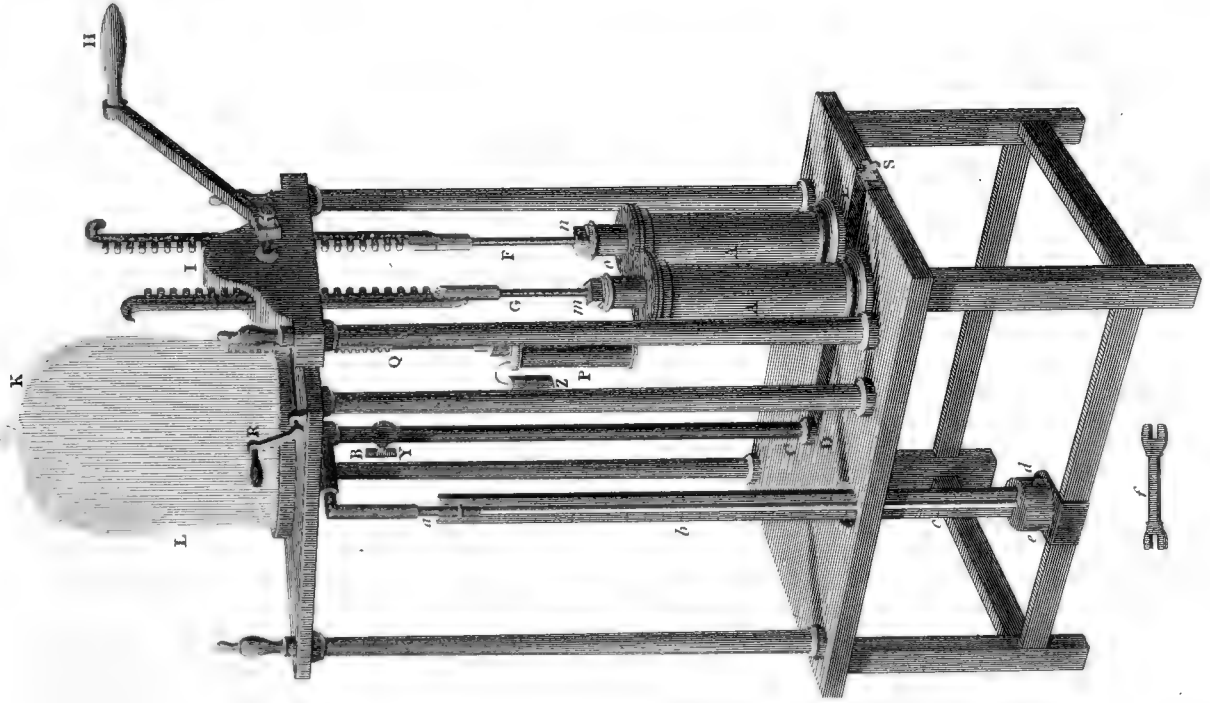


Fig. 54.

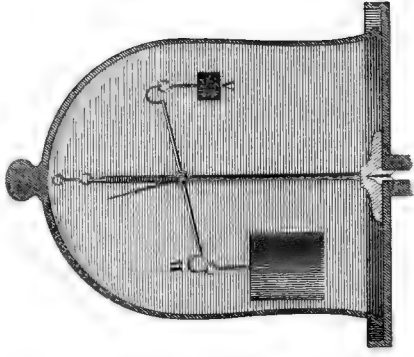


Fig. 55.

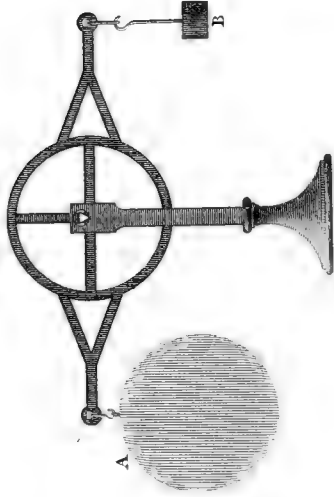


Fig. 49.

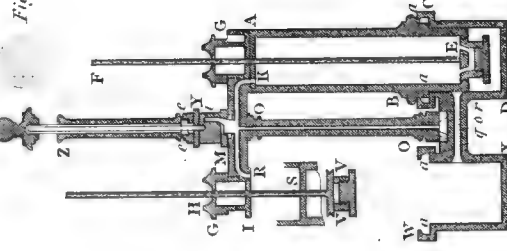


Fig. 50.

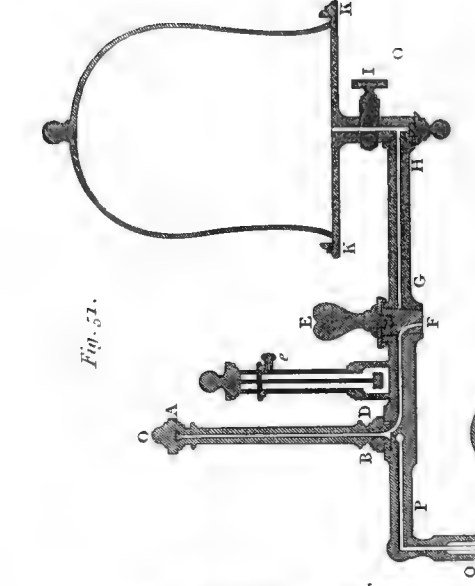


Fig. 51.

Fig. 52.

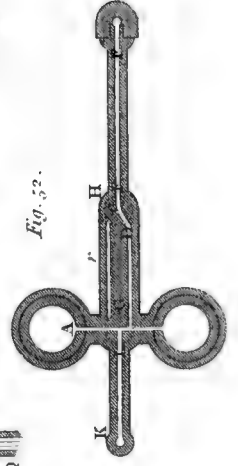


Fig. 53.



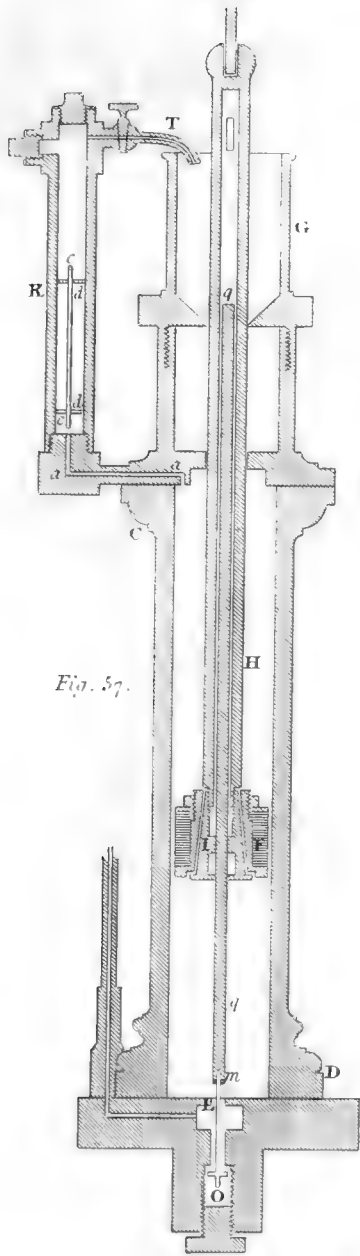


Fig. 57.

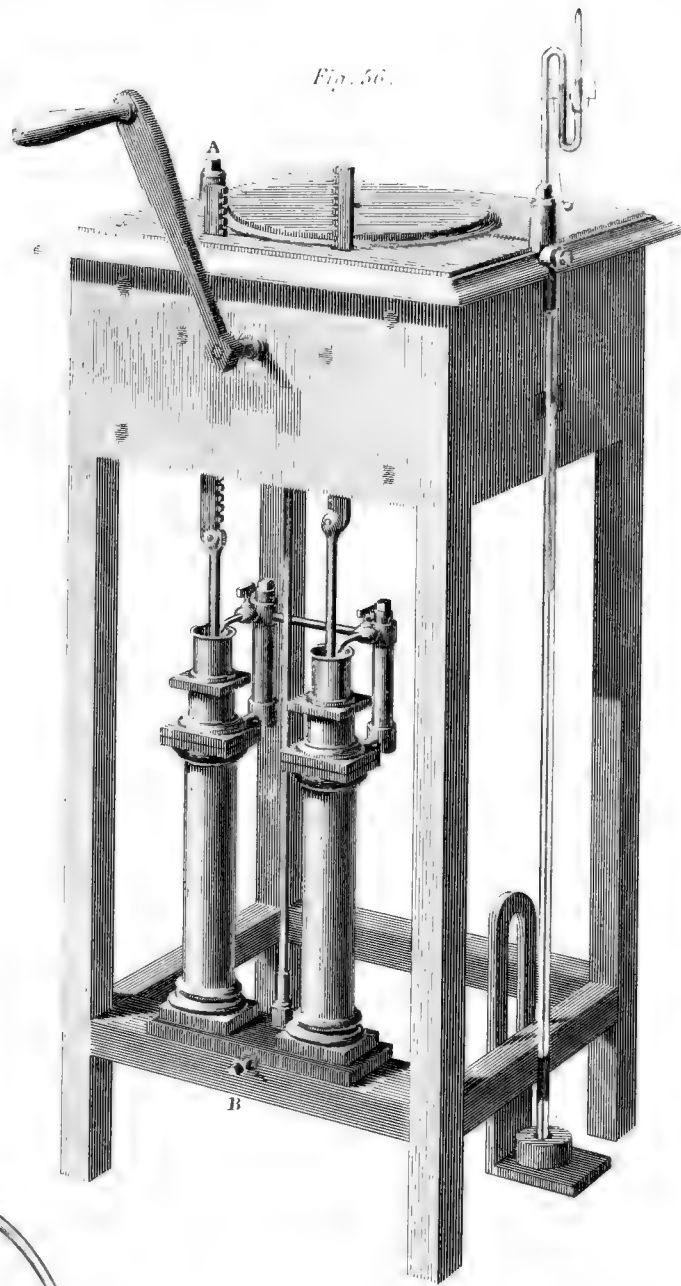


Fig. 56.

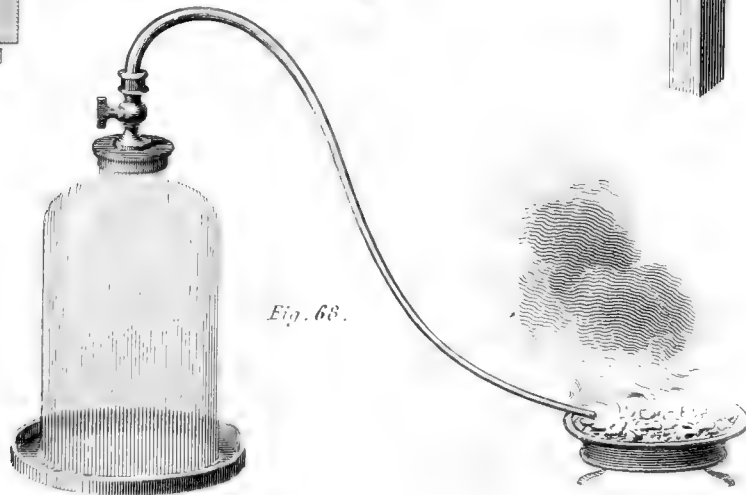
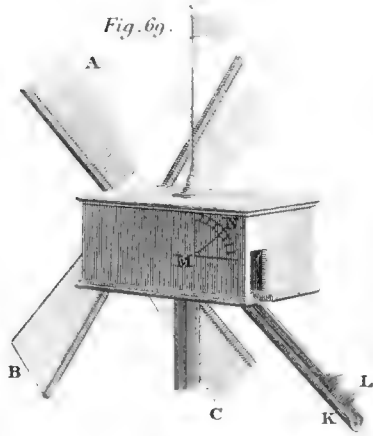
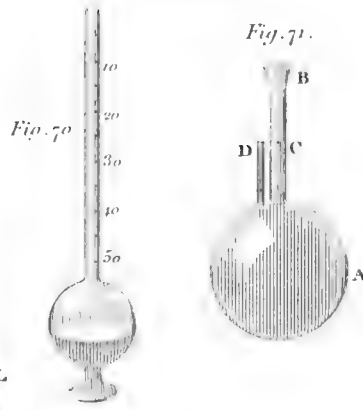


Fig. 68.

ANEMOMETER.



BAROMETER.



ATMOSPHERE.



BACCHUS.



CUTHBERTSON'S AIR PUMP.

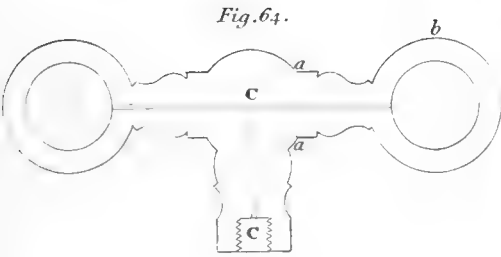
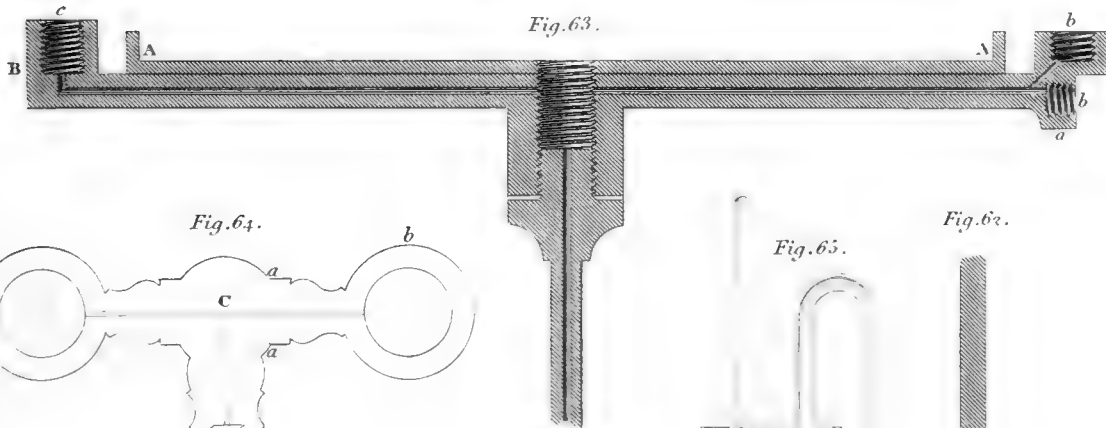


Fig. 62.



Fig. 66.

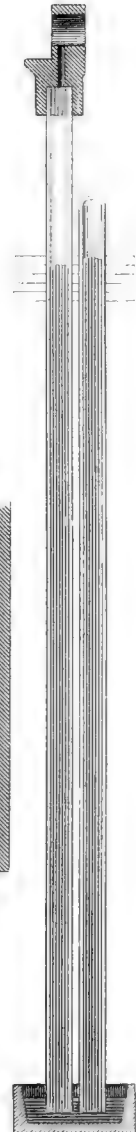


Fig. 58.

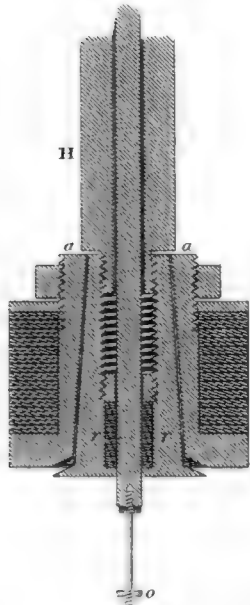


Fig. 61.



Fig. 60.

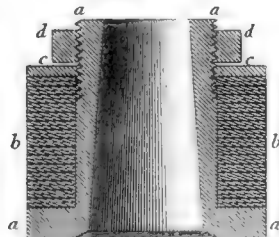
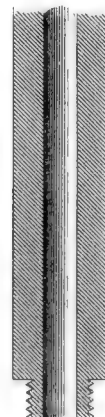
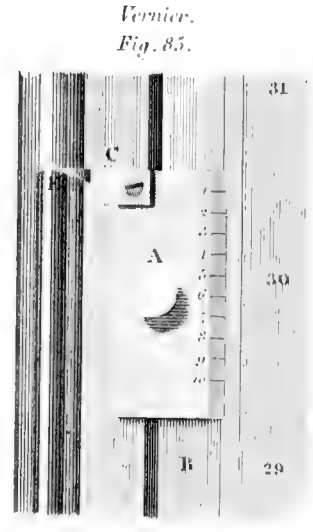
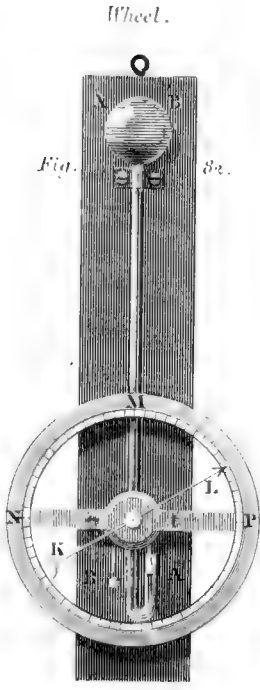
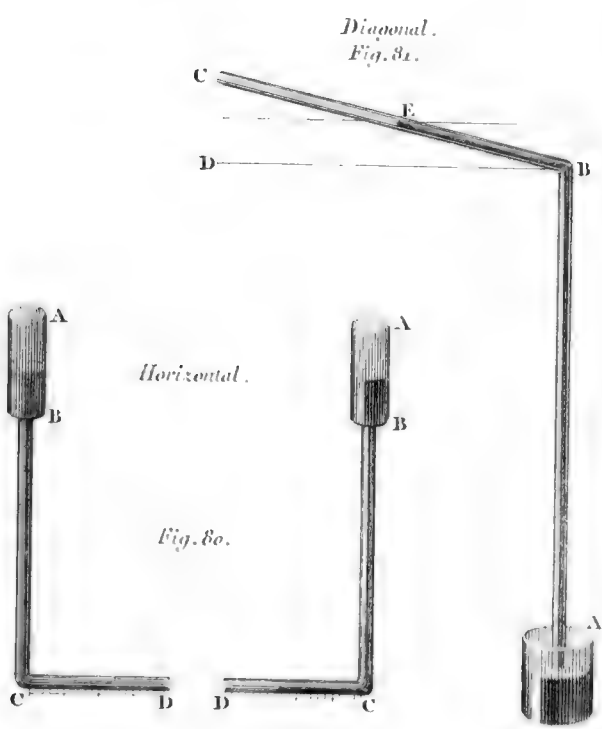
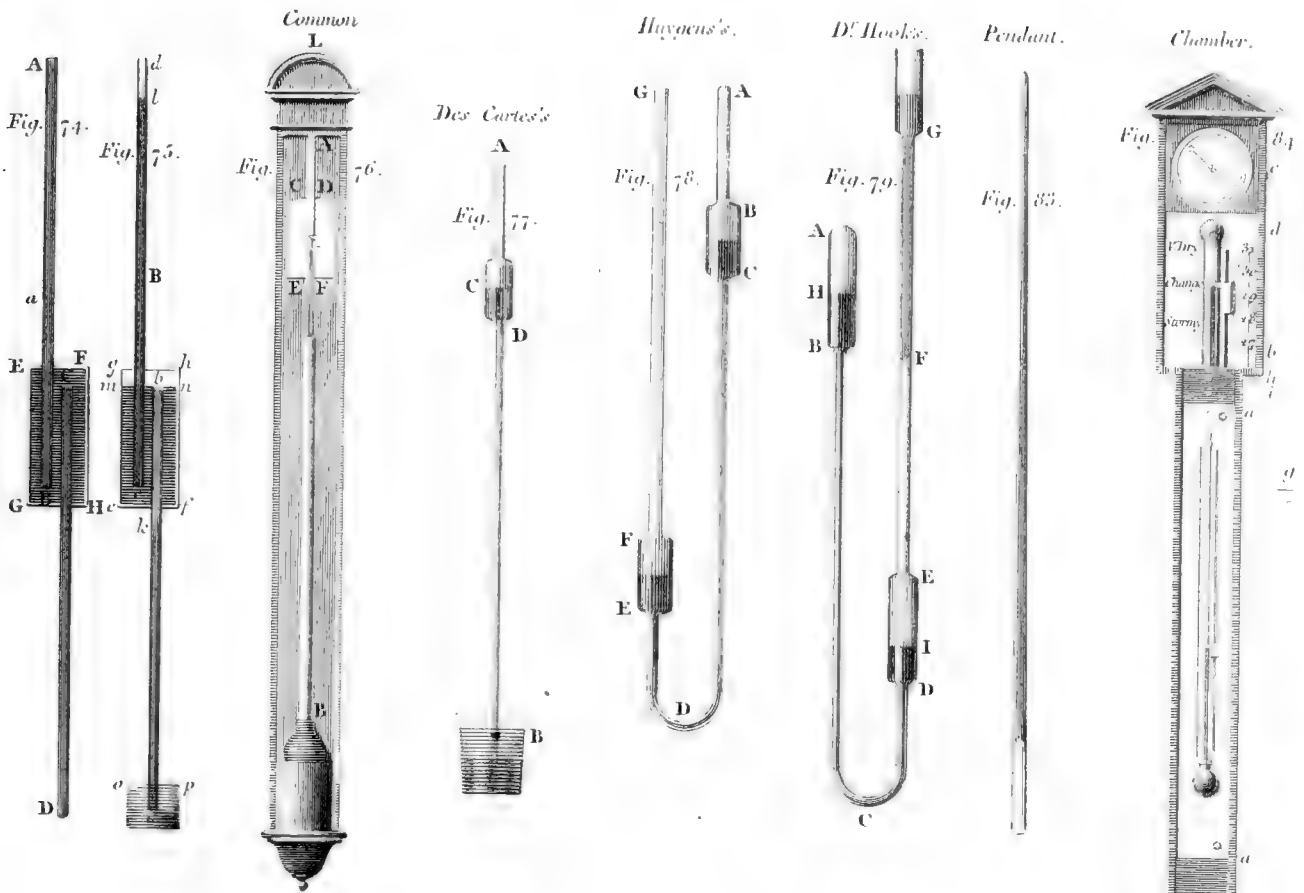


Fig. 59.

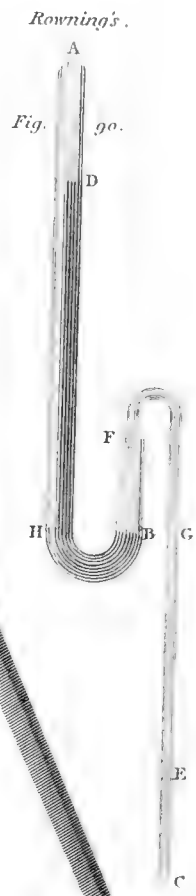
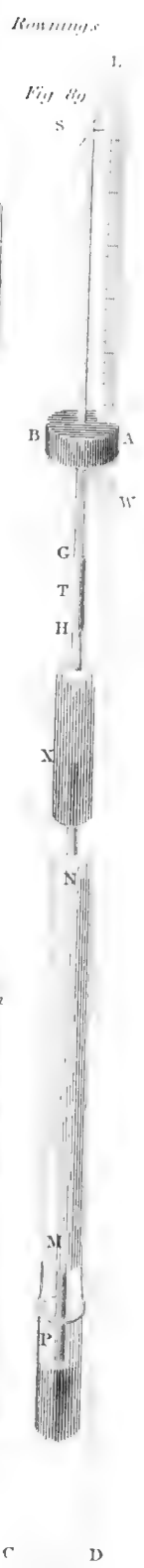
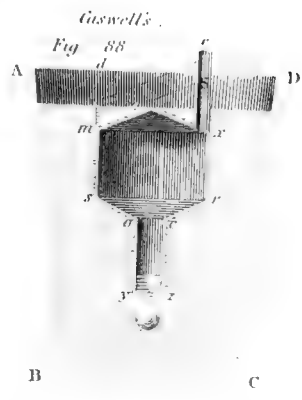
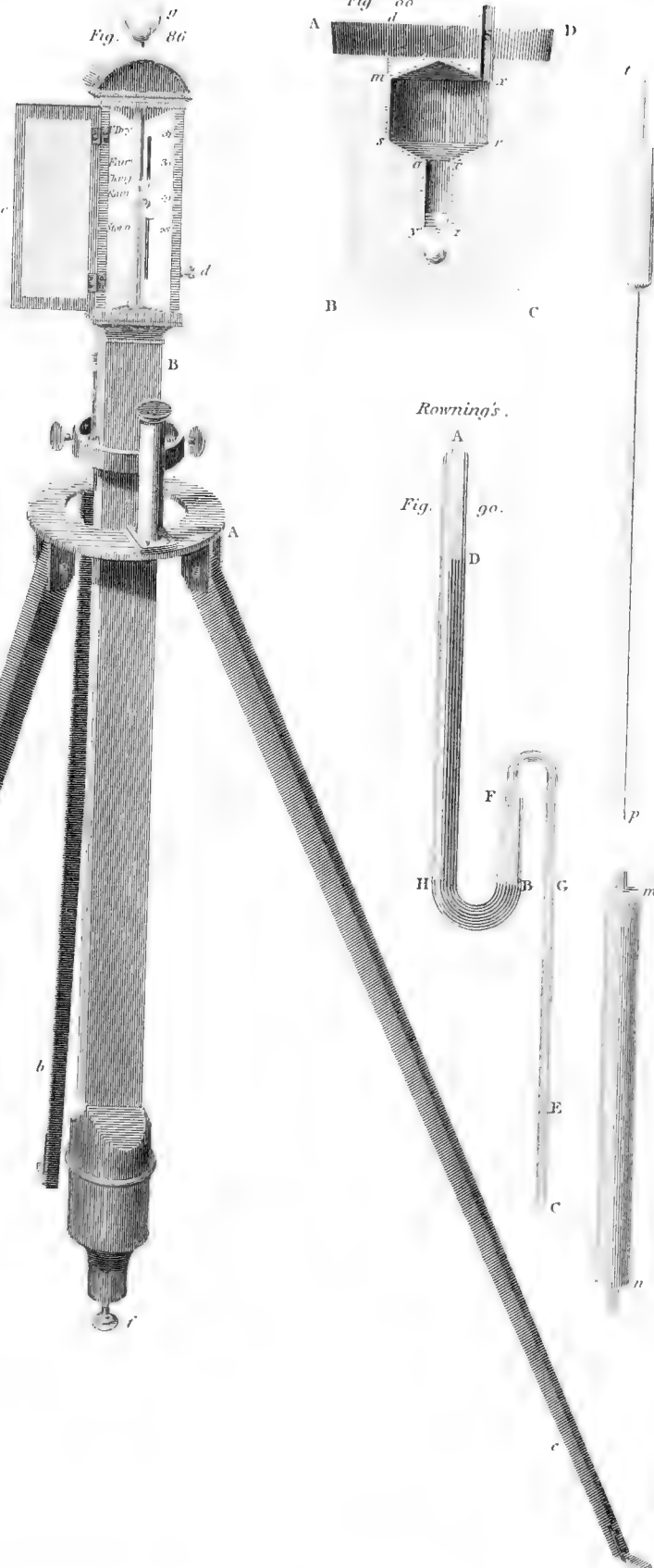


BAROMETER.



BAROMETER.

Marine





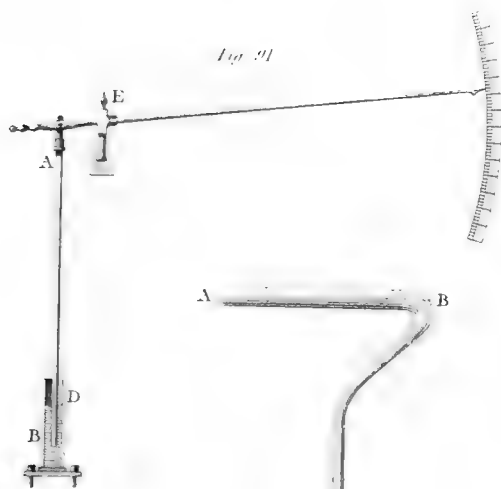


Fig. 91

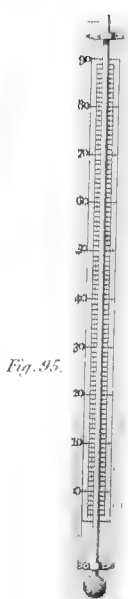
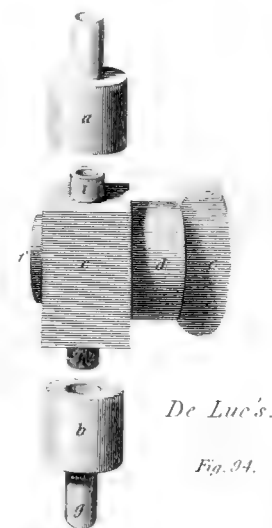


Fig. 95.



De Luc's.

Fig. 94.

Keith's.

Fig. 92.

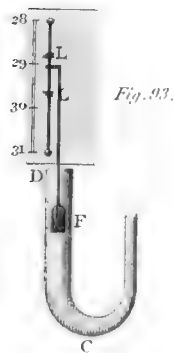


Fig. 93.



Hamilton's.

Fig. 26.

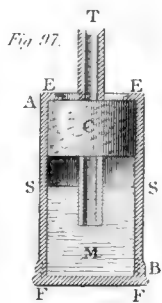


Fig. 97.

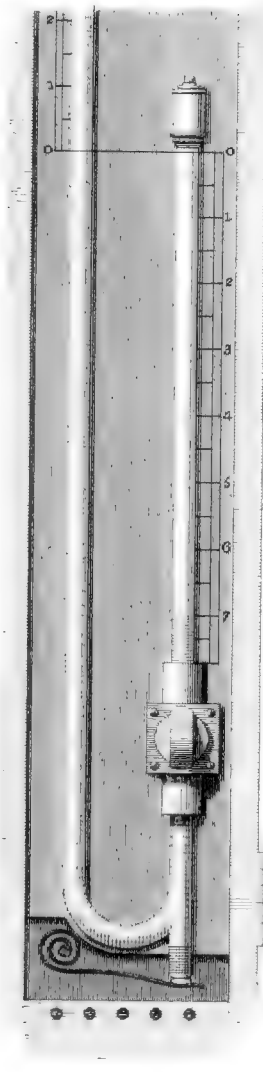


Fig. 98.

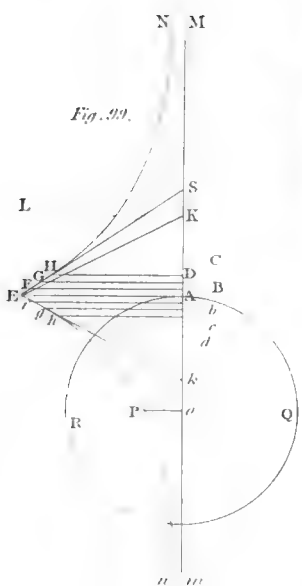
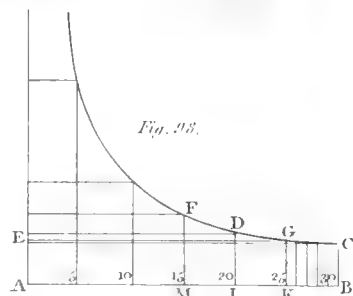
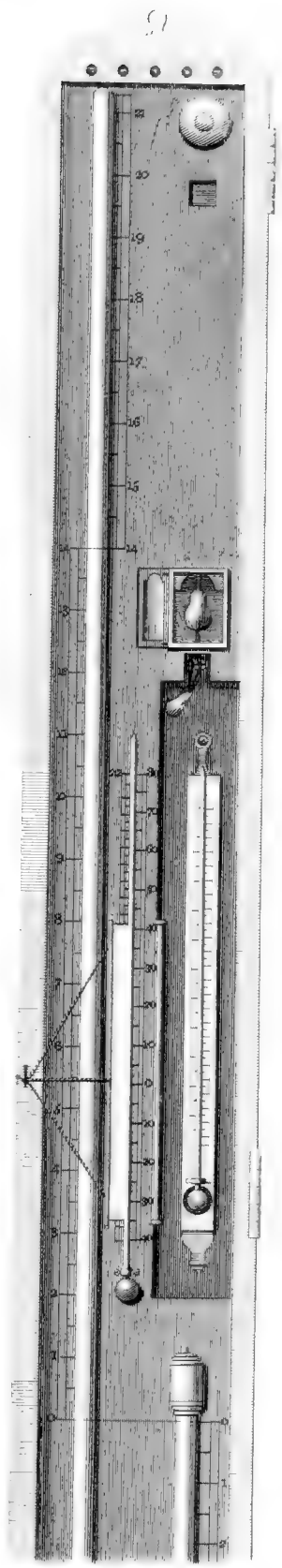


Fig. 99.



91

BAROMETER.

Fig. 104.

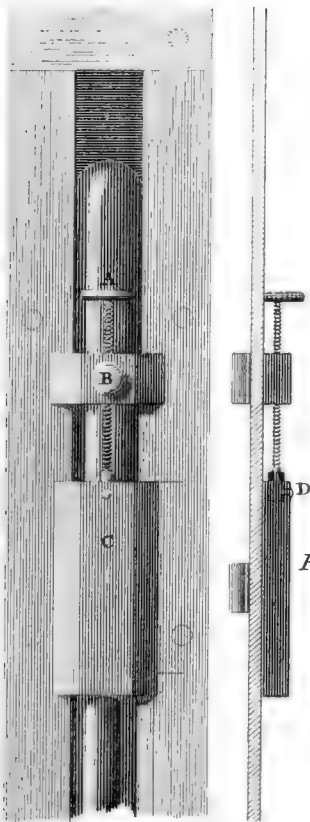


Fig. 105.

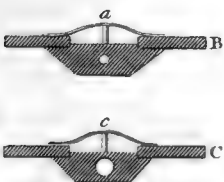


Fig. 102

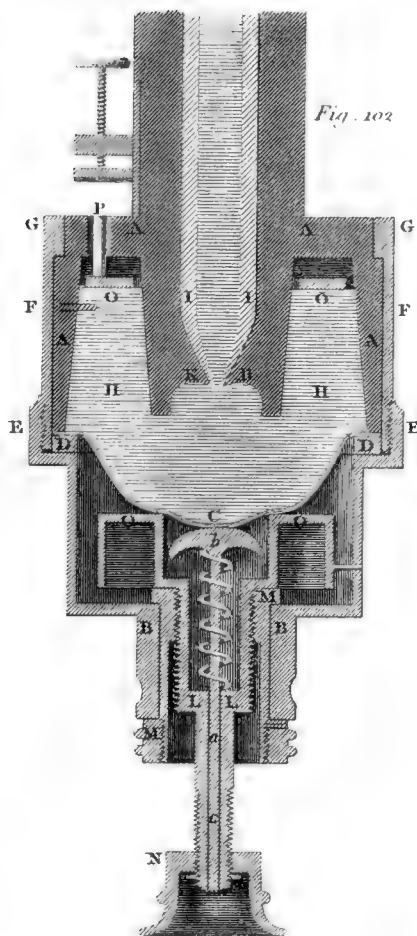


Fig. 101

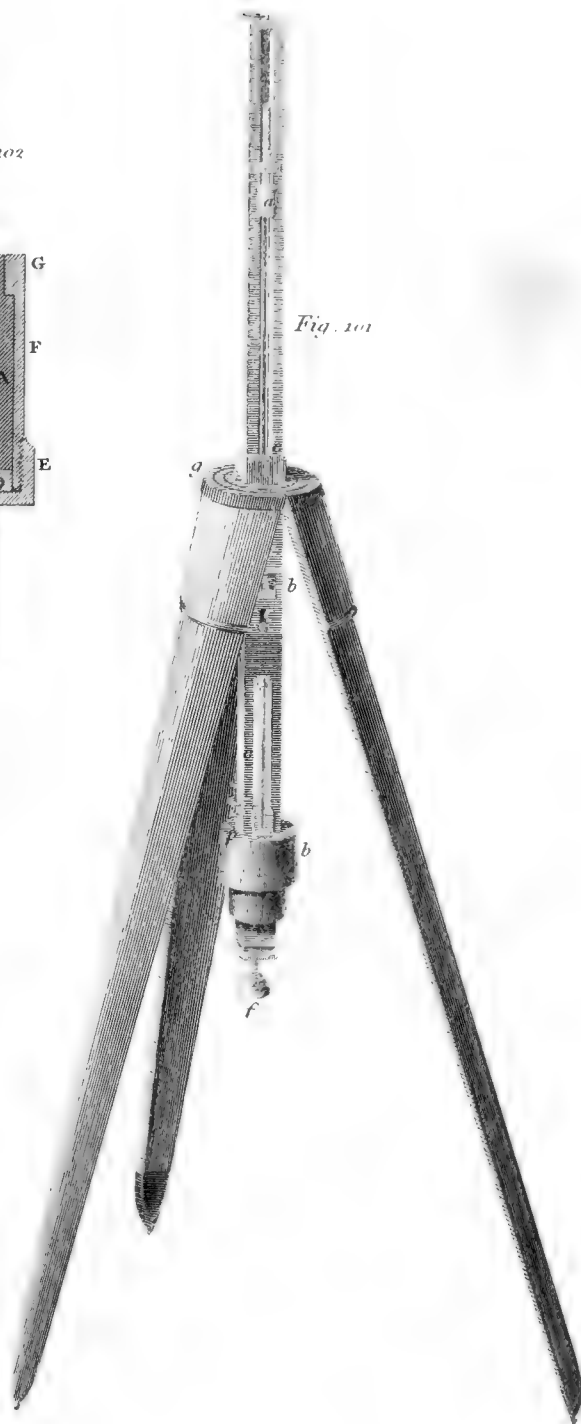


Fig. 103.

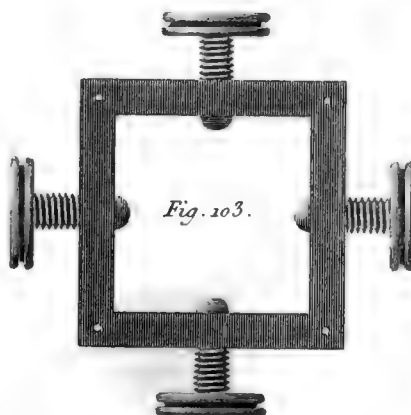


Fig. 100.



Fig. 107.

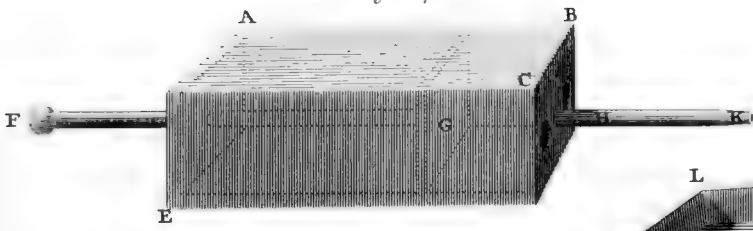


Fig. 109.

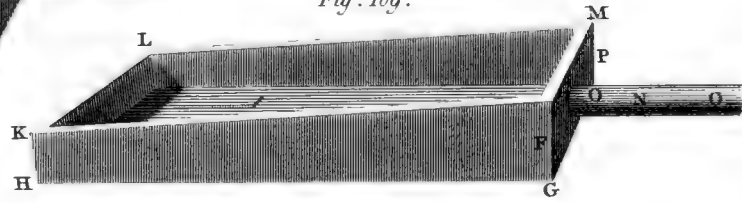


Fig. 108.

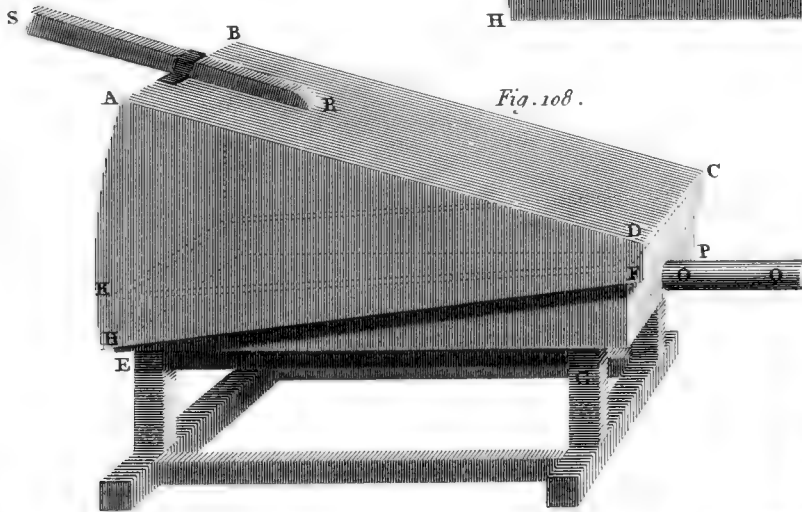


Fig. 110.

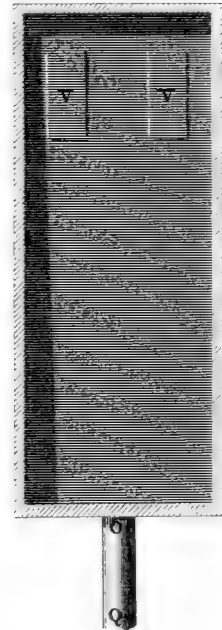


Fig. 111.

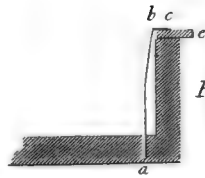


Fig. 112.

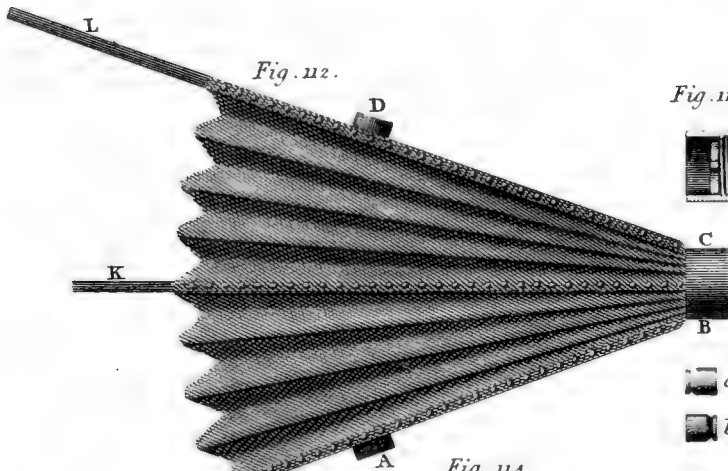


Fig. 117.



Fig. 116.



Fig. 115.

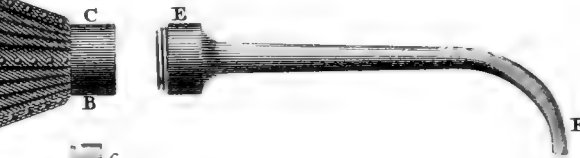


Fig. 114.



Fig. 113.

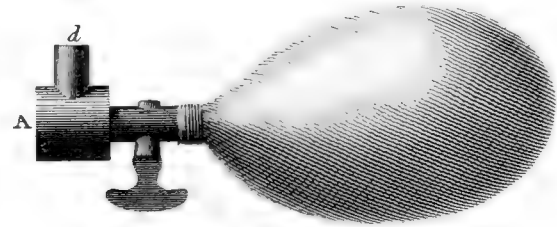
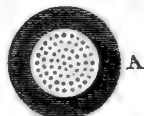
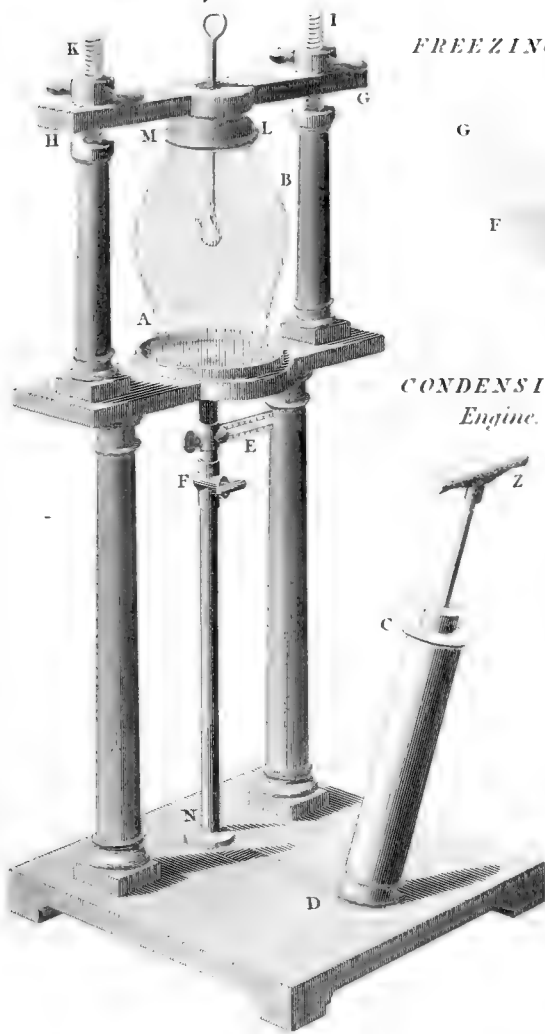
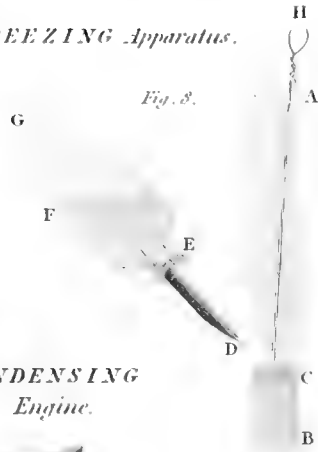


Fig. 3.



FREEZING Apparatus.

Fig. 8.



PEAR Gage.

Fig. 4.



CONDENSER'S.



Fig. 2.



Fig. 1.

GAGE of Condenser.



Fig. 6.

Fig. 5.

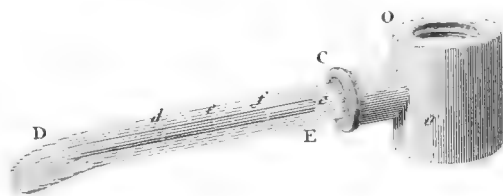


Fig. 7.



FREEZING.

Fig. 4.

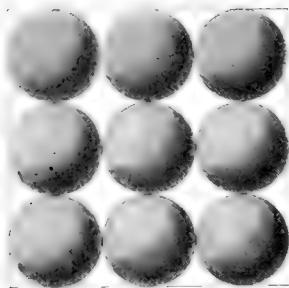


Fig. 5.

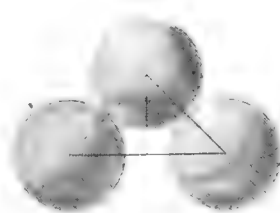


Fig. 6.

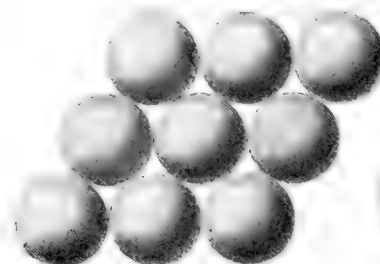
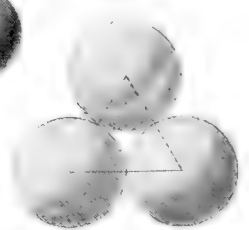


Fig. 7.



PNEUMATICS.
PYRMONT WATER.

Fig 1



Fig 2



Fig 3



Fig 5

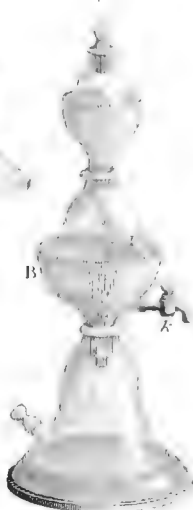


Fig 6

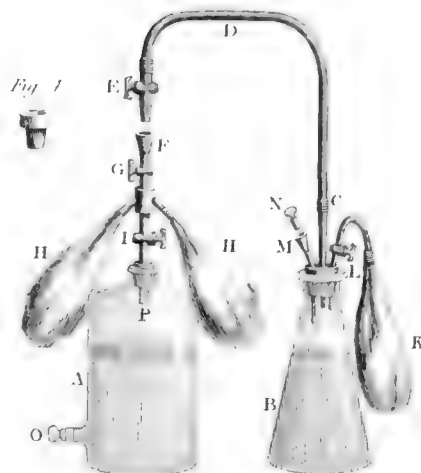
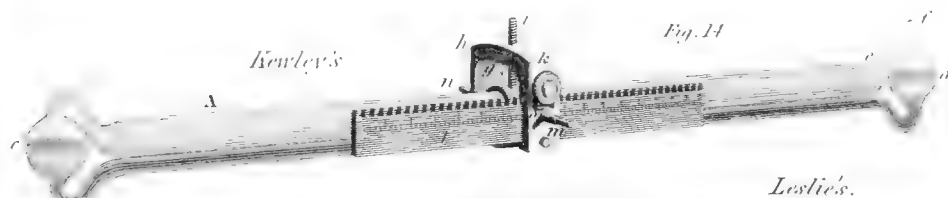
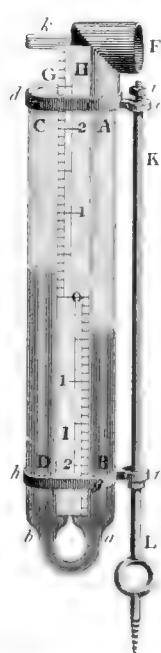


Fig 7



Lind's WIND GAGE.

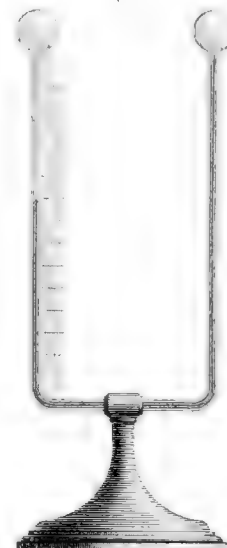
Fig 9



THERMOMETER



Leslie's
Fig 13



Martin's WIND GAGE.

Fig 11

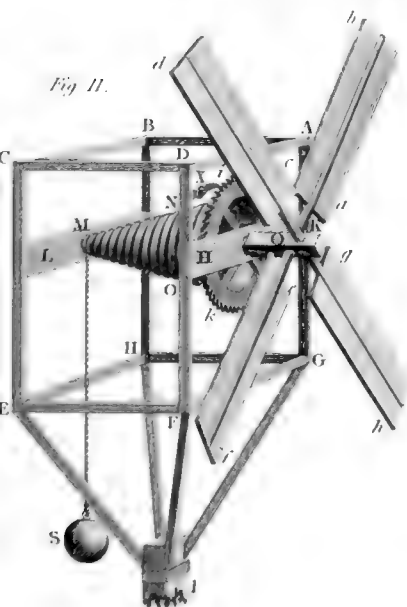


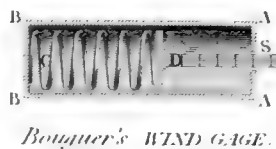
Fig 10



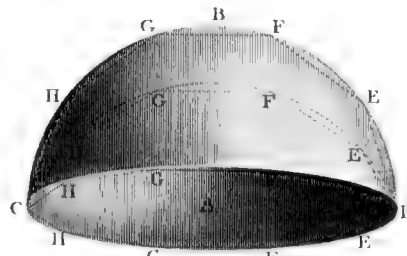
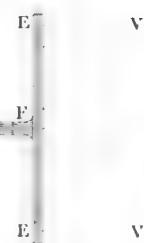
WHISPERING PLACE.

Fig 8

Fig 12



Bouguer's WIND GAGE.



TIHERMOMETER.

Fig. 1.

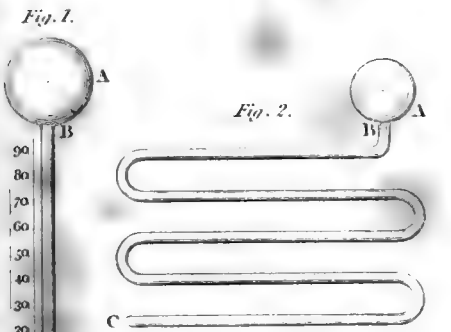


Fig. 2.

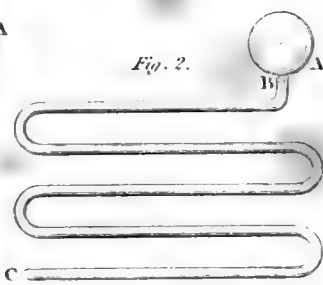


Fig. 3.



Fig. 6.

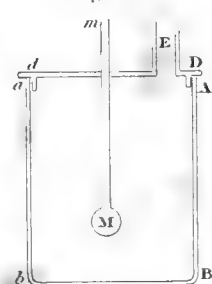


Fig. 5.

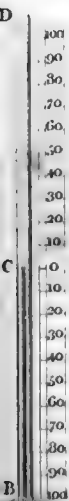


Fig. 7.

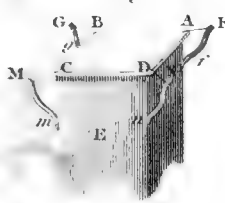


Fig. 10.

Fig. 9.



Fig. 8.

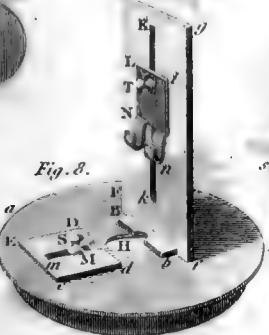


Fig. 16.



112																							112
108	80				61																		108
104					60																		104
100																							100
96					59																		96
92	70		100	99																			92
88					58																		88
84																							84
80	60																						80
76					57																		76
72																							72
68	50				56																		68
64																							64
60					55																		60
56	40																						56
52					54																		52
48																							48
44	30				53																		44
40																							40
36					52																		36
32	20																						32
28					51																		28
24																							24
20	10				50																		20
16																							16
12					49																		12
8	0																						8
4					48																		4
0																							0
Fahrenheit	I	II	III	IV	V	VI	VII	VIII	IX	X	XI	XII	XIII	XIV	XV								
	Florence																						
	Paris																						
	De la Haye																						
	Amontons																						
	Fahrenheit																						
	Poleni																						
	Micromere																						
	De Lisle																						
	Quequius																						
	R.Society																						
	Newton																						
	Fowler																						
	Hales																						
	Edinburgh																						

Fig. 11. Height of Barometer.

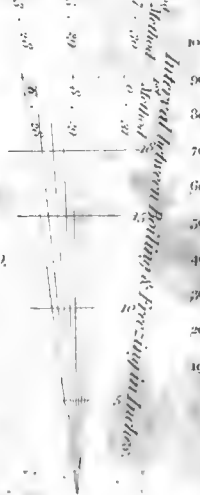


Fig. 12.

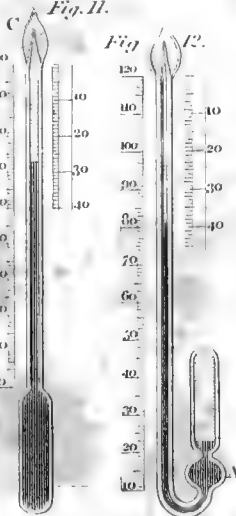


Fig. 13.

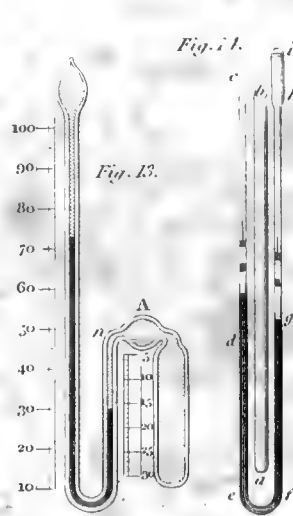


Fig. 15.





PNEUMATICS.
VENTILATOR.

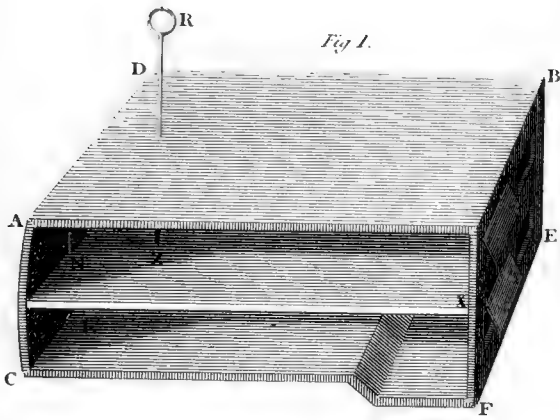


Fig. 1.

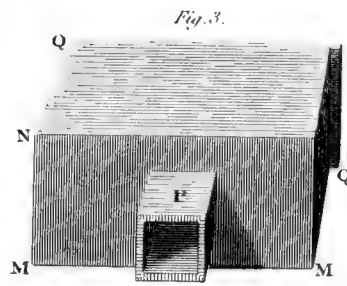


Fig. 3.

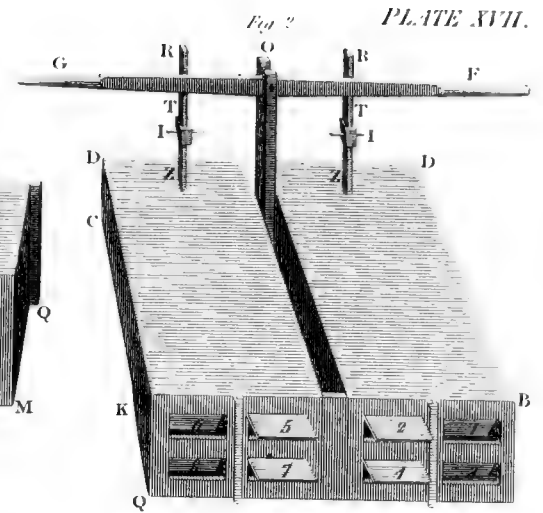


Fig. 2.

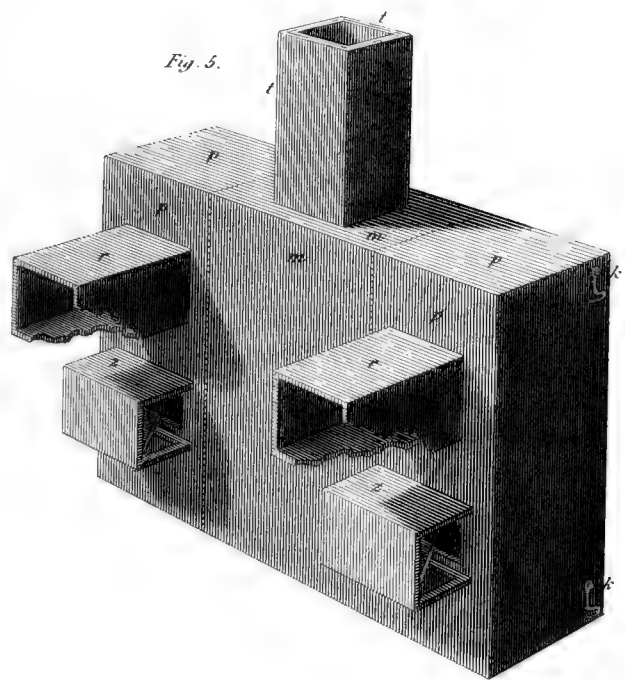


Fig. 5.

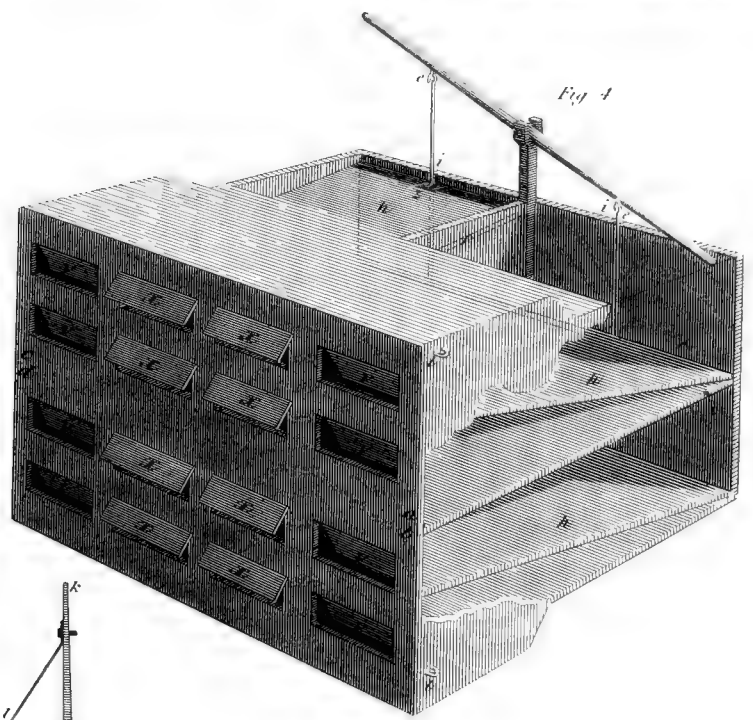


Fig. 4.

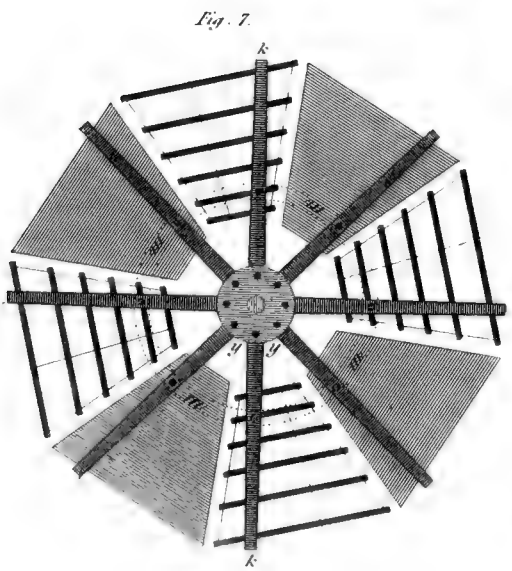


Fig. 7.

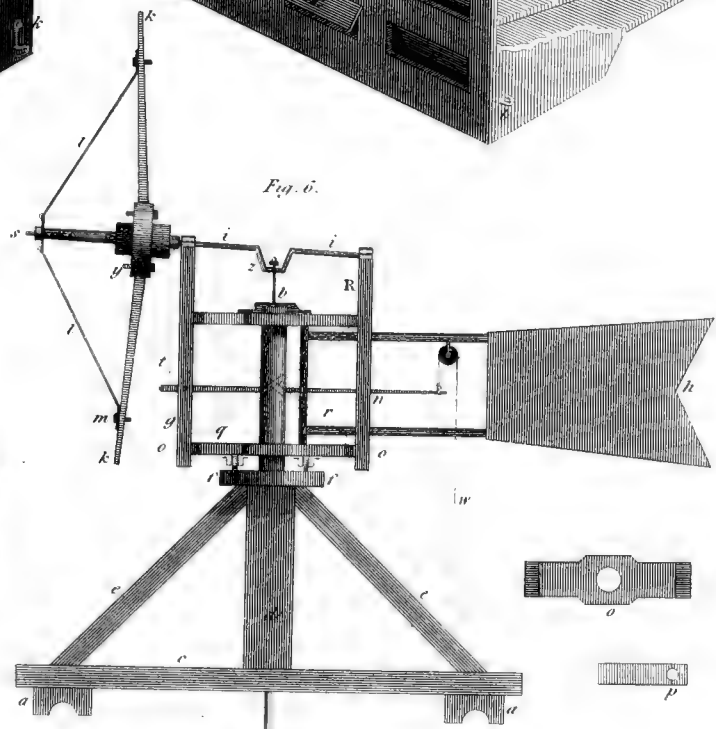


Fig. 6.

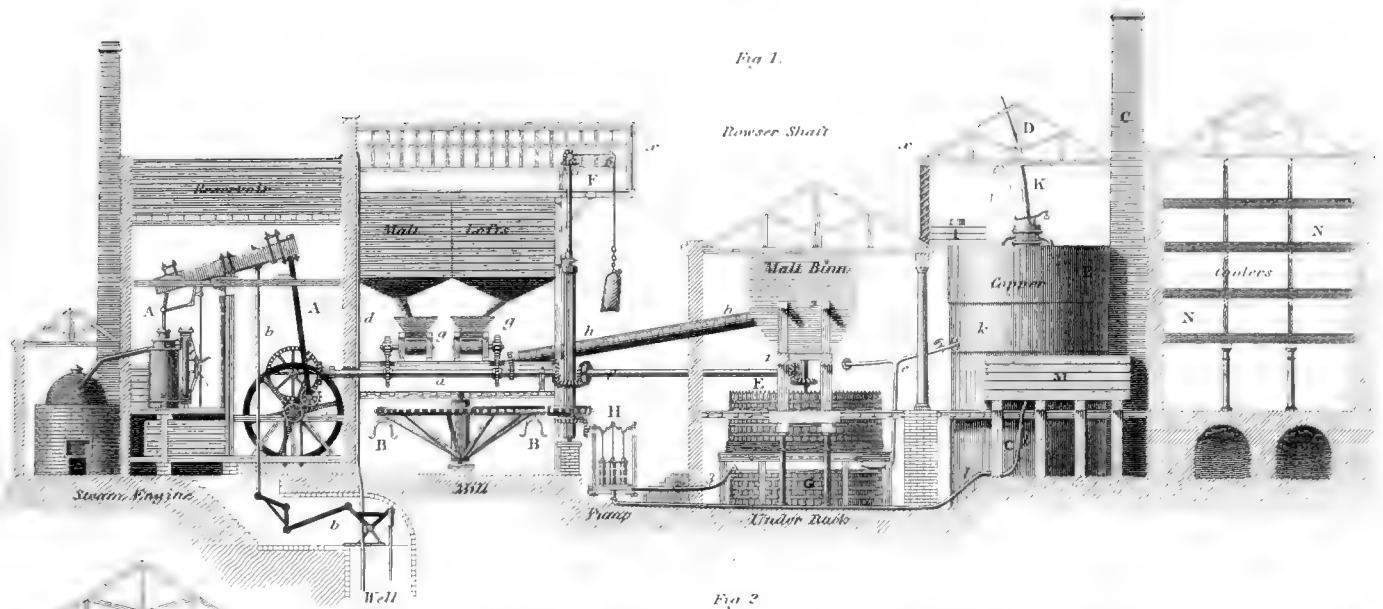


Fig 1.

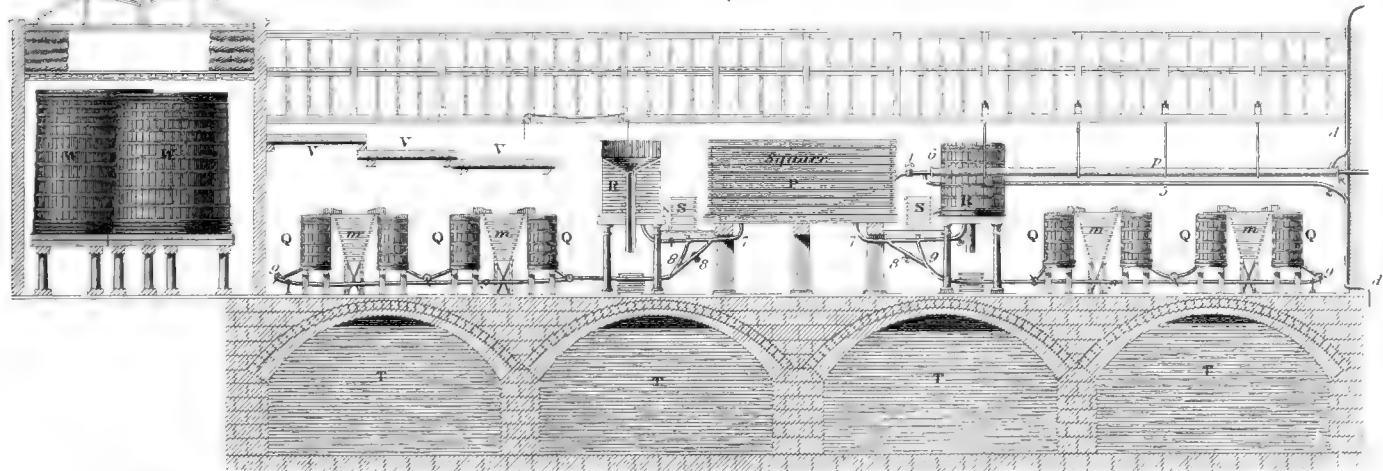


Fig 2

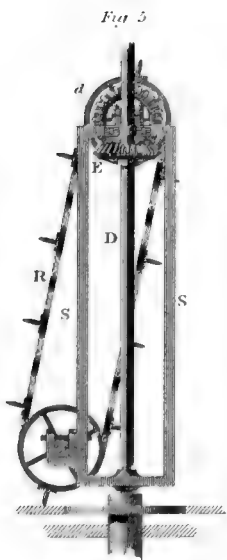


Fig 5

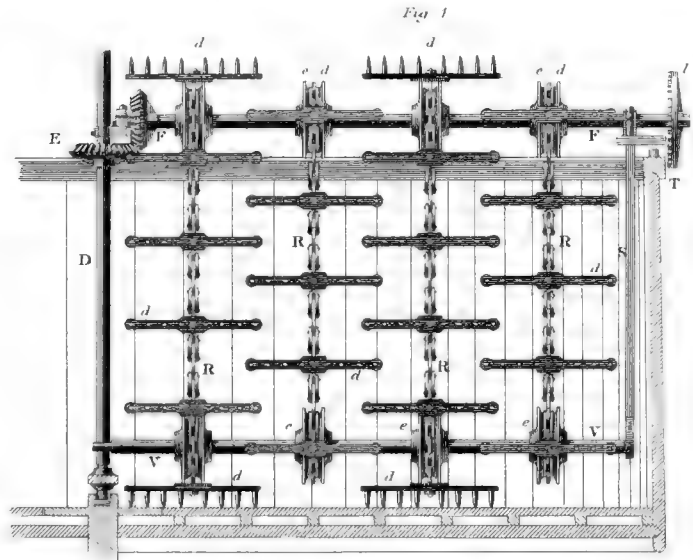


Fig 1

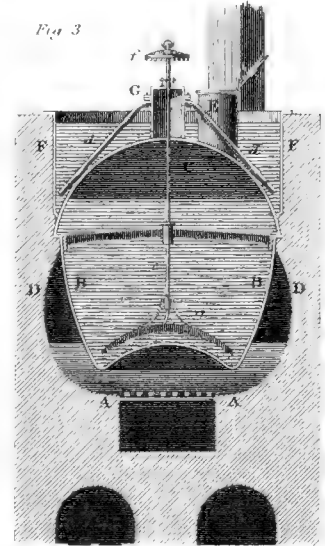
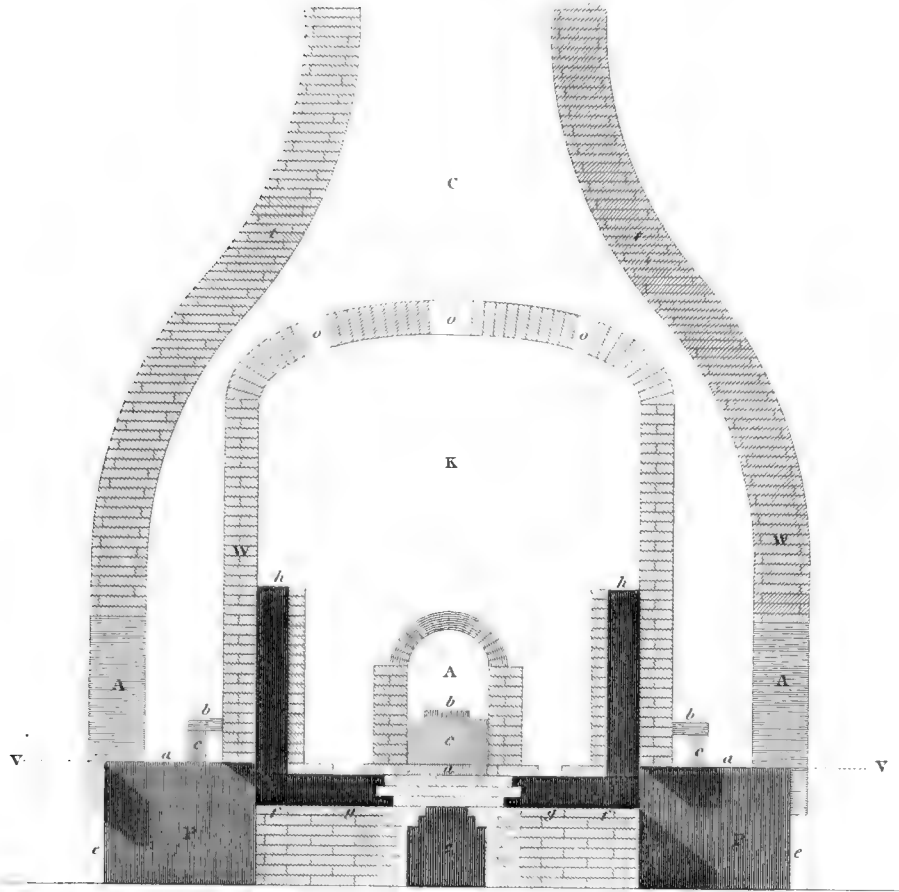


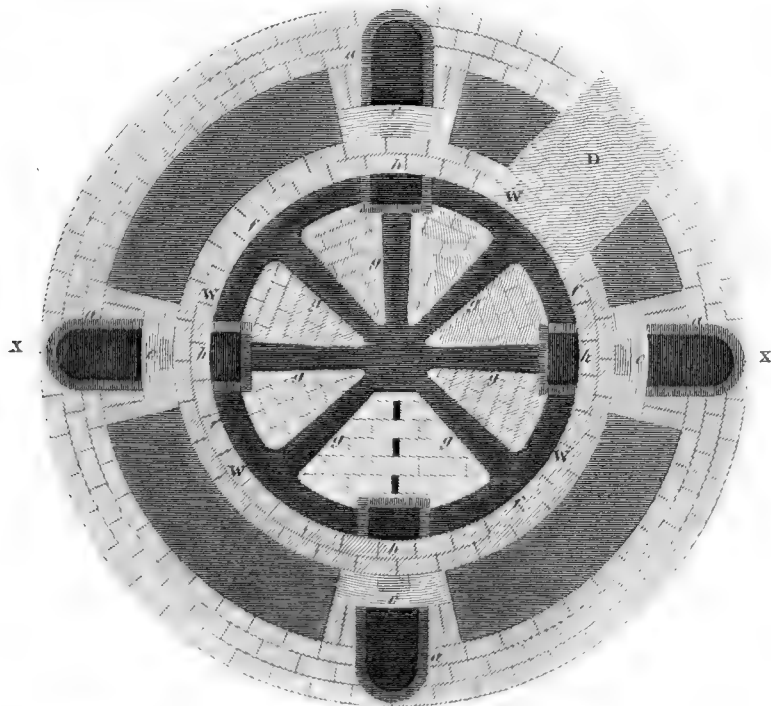
Fig 3

POTTERY

Vertical Section.



Horizontal Section





M^r BRAMAH'S HYDROSTATIC PRESS.

Fig. 3. Plan.

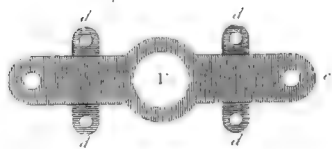


Fig. 4. Plan.

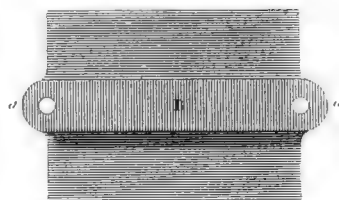
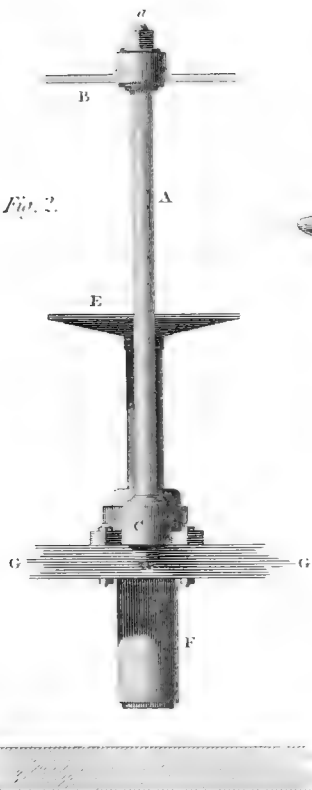
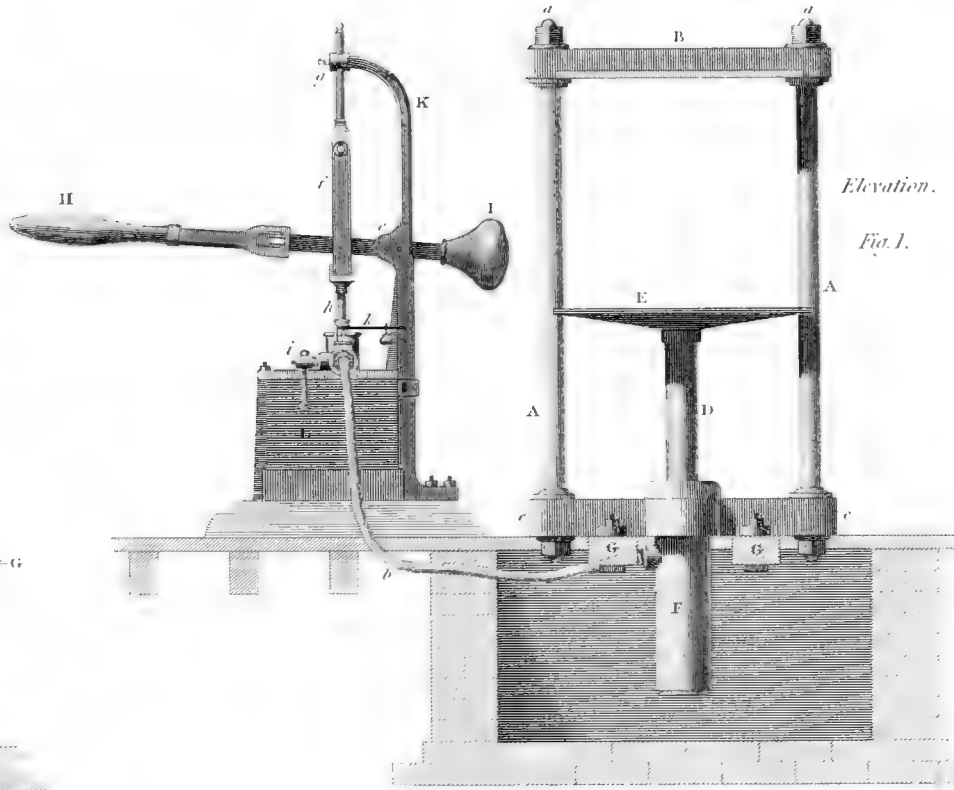


Fig. 2.



Elevation.

Fig. 1.



Sections of the

Cylinder

Fig. 5.

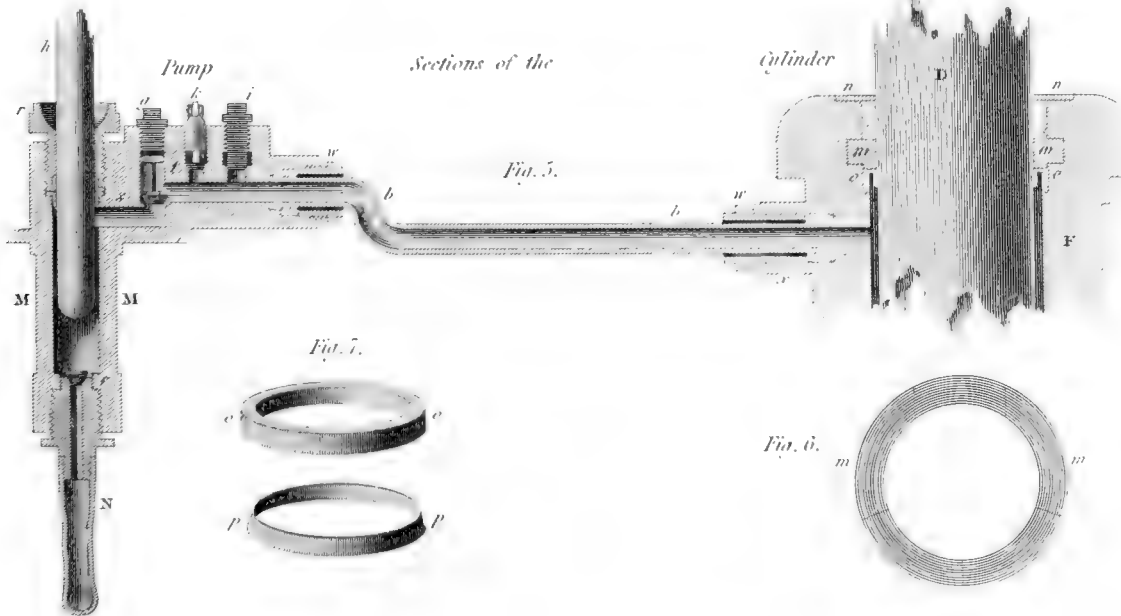


Fig. 7.

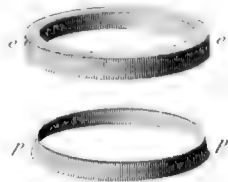


Fig. 6.

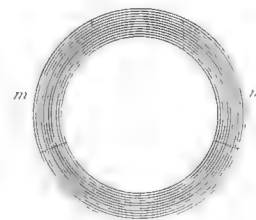


Fig. 3. Plan

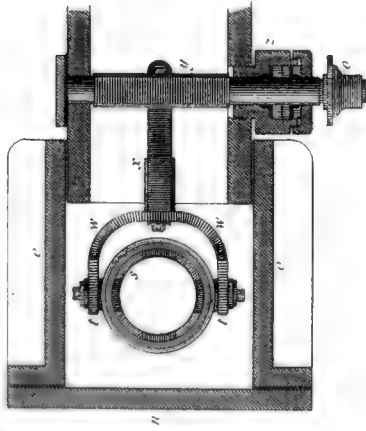


Fig. 4.

Section of the Valve

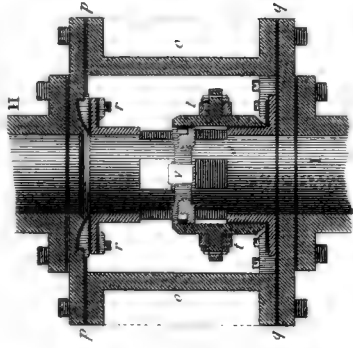


Fig. 5. Section

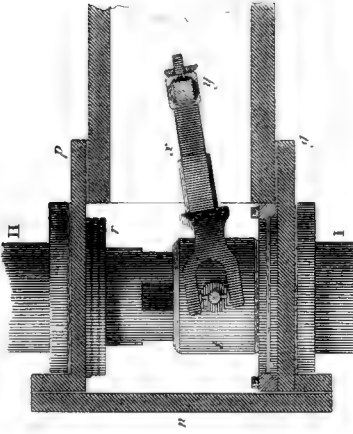
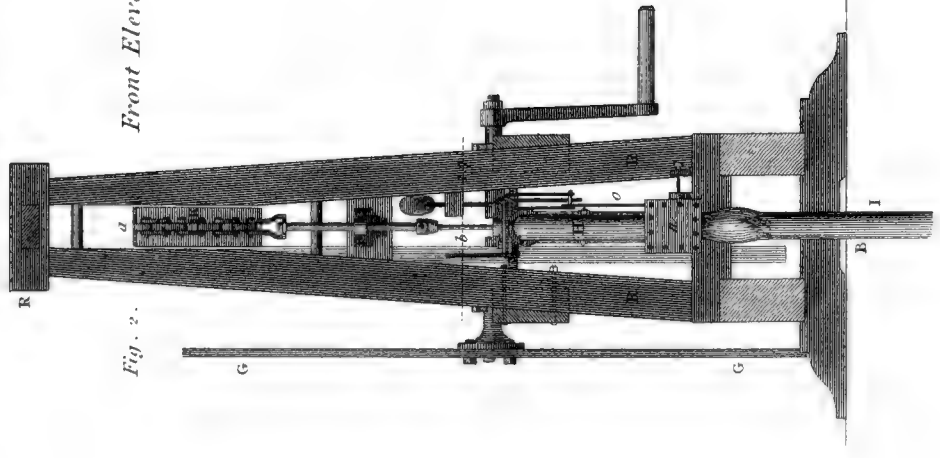
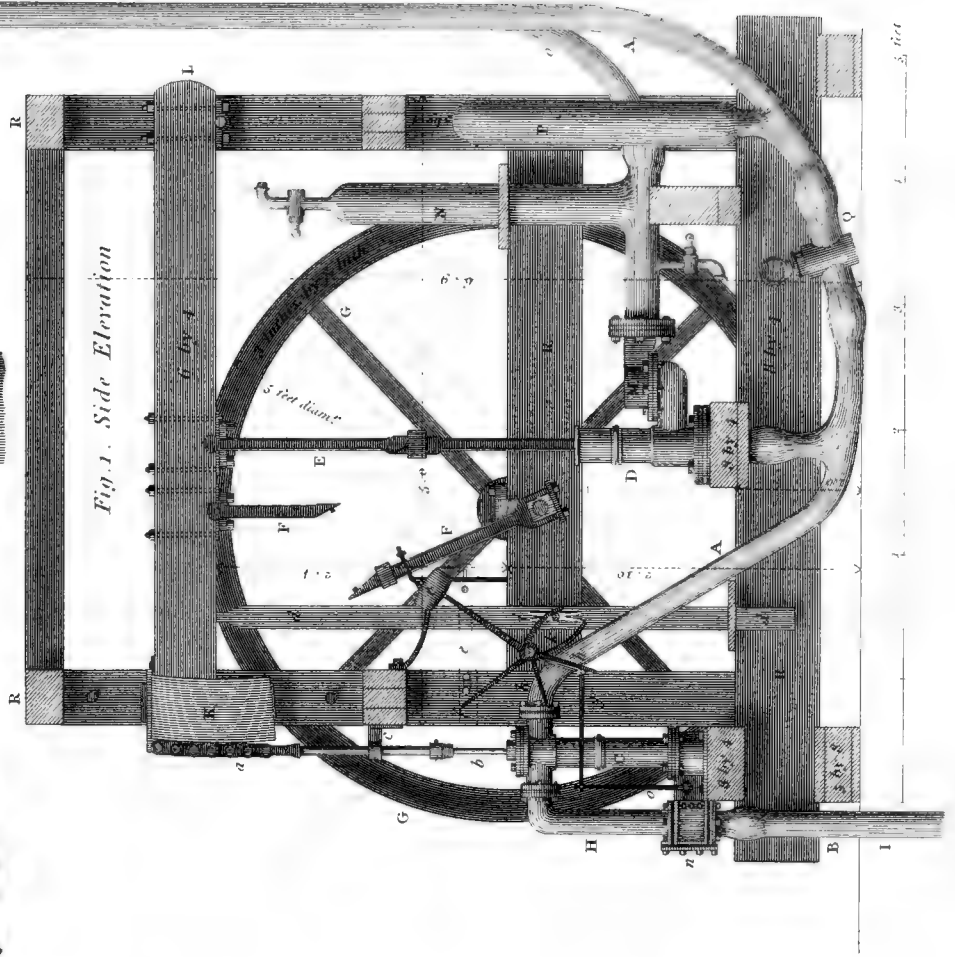


Fig. 2.

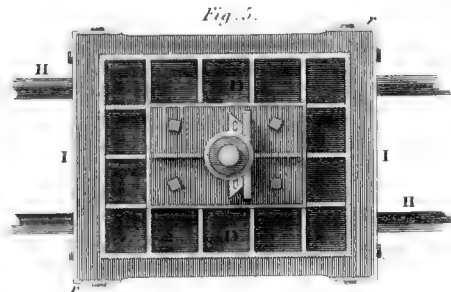
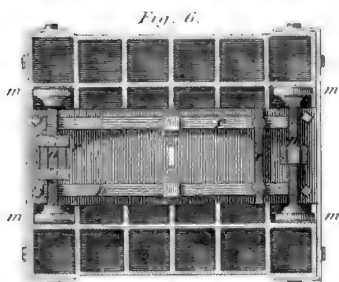
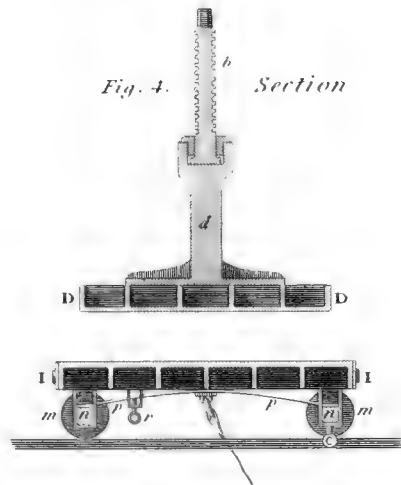
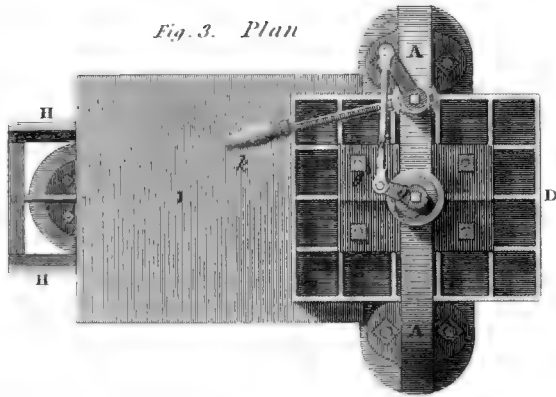
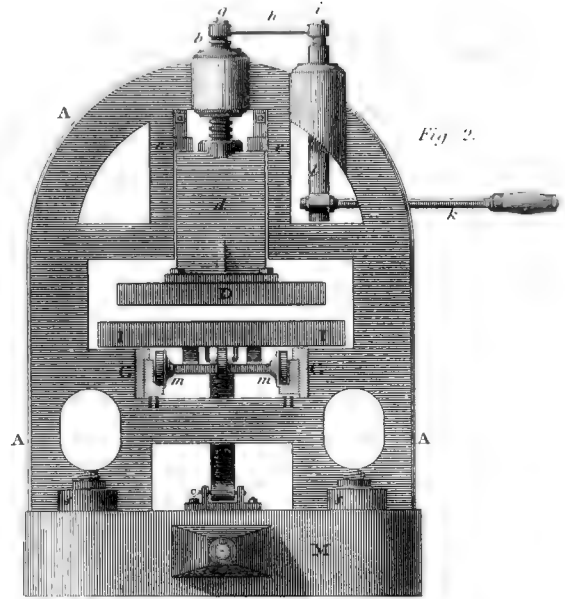
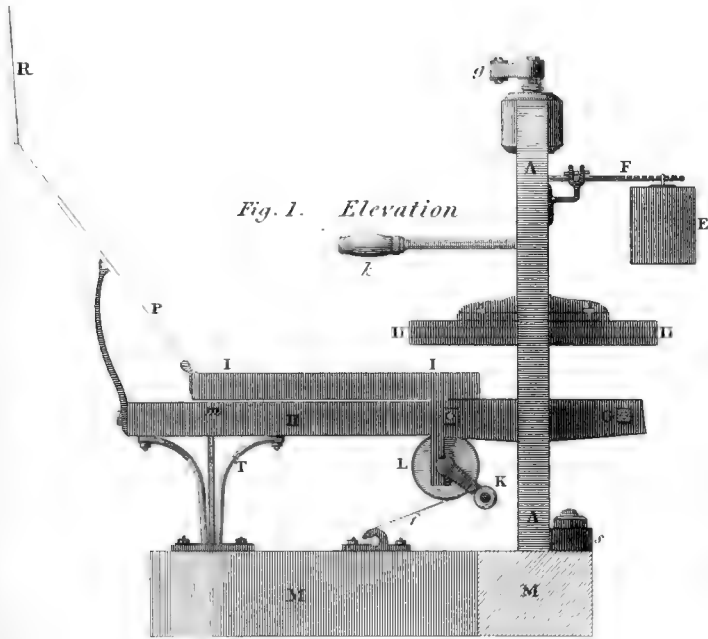


Front Elevation

Fig. 1. Side Elevation



The STANHOPE or IRON PRESS.



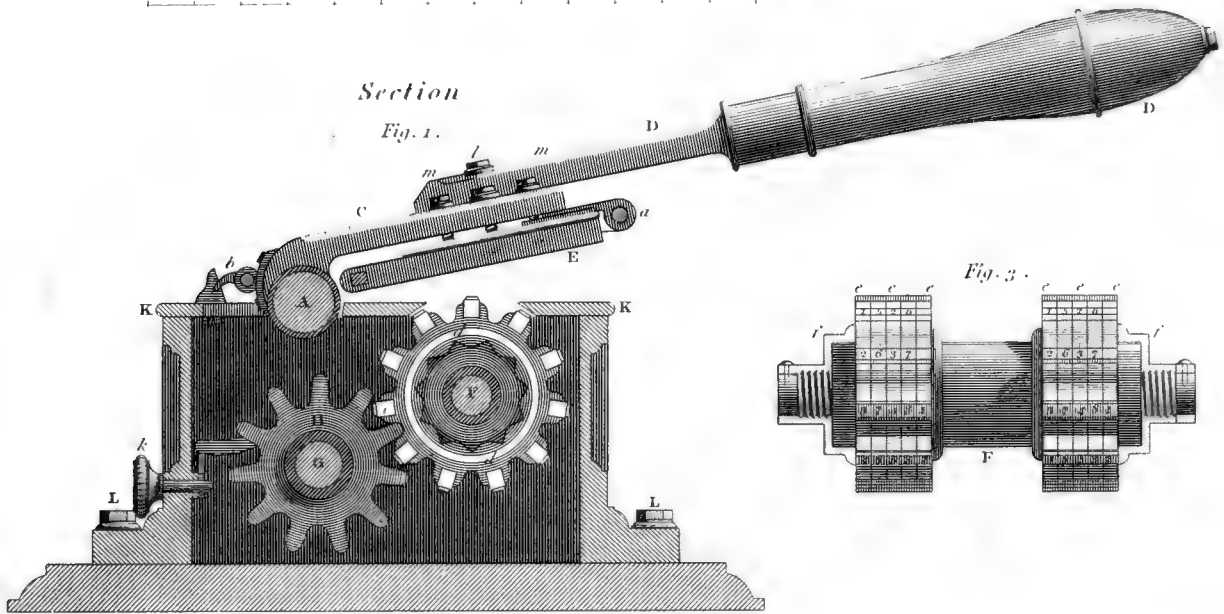


M^r Bramah's Bank note Printing machine.

1 2 3 4 5 6 7 8 9 10 11 12 Inches

Section

Fig. 1.



Plan

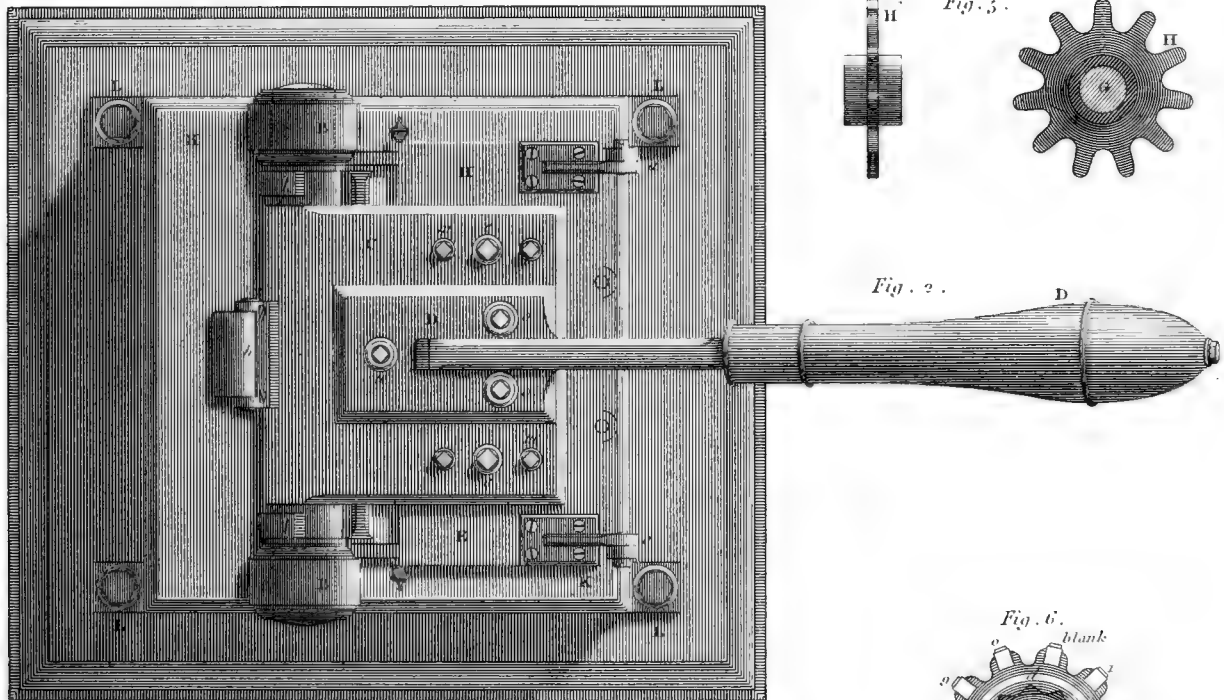


Fig. 3.

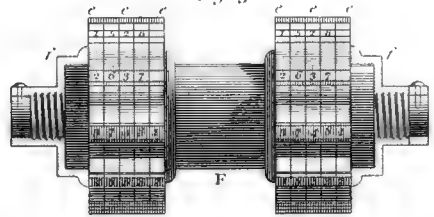


Fig. 5.

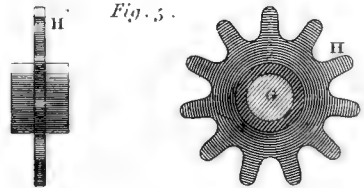


Fig. 2.

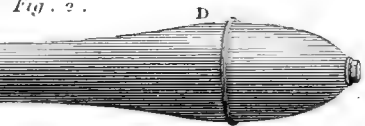


Fig. 6.

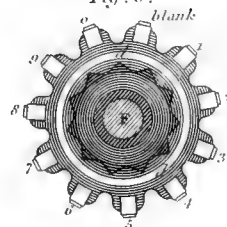
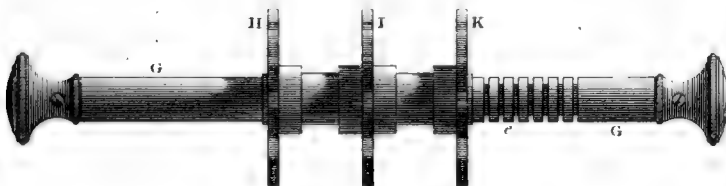
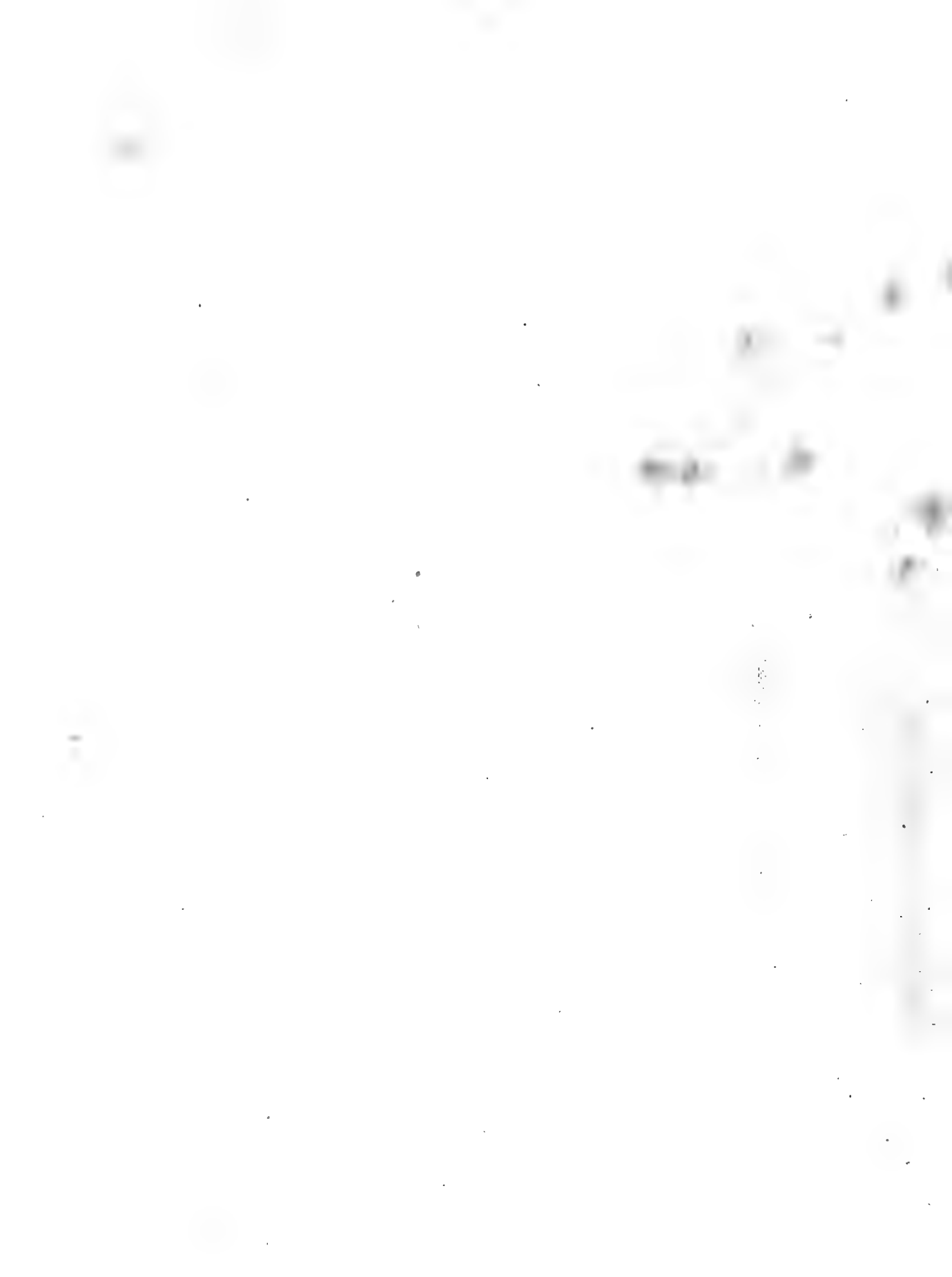


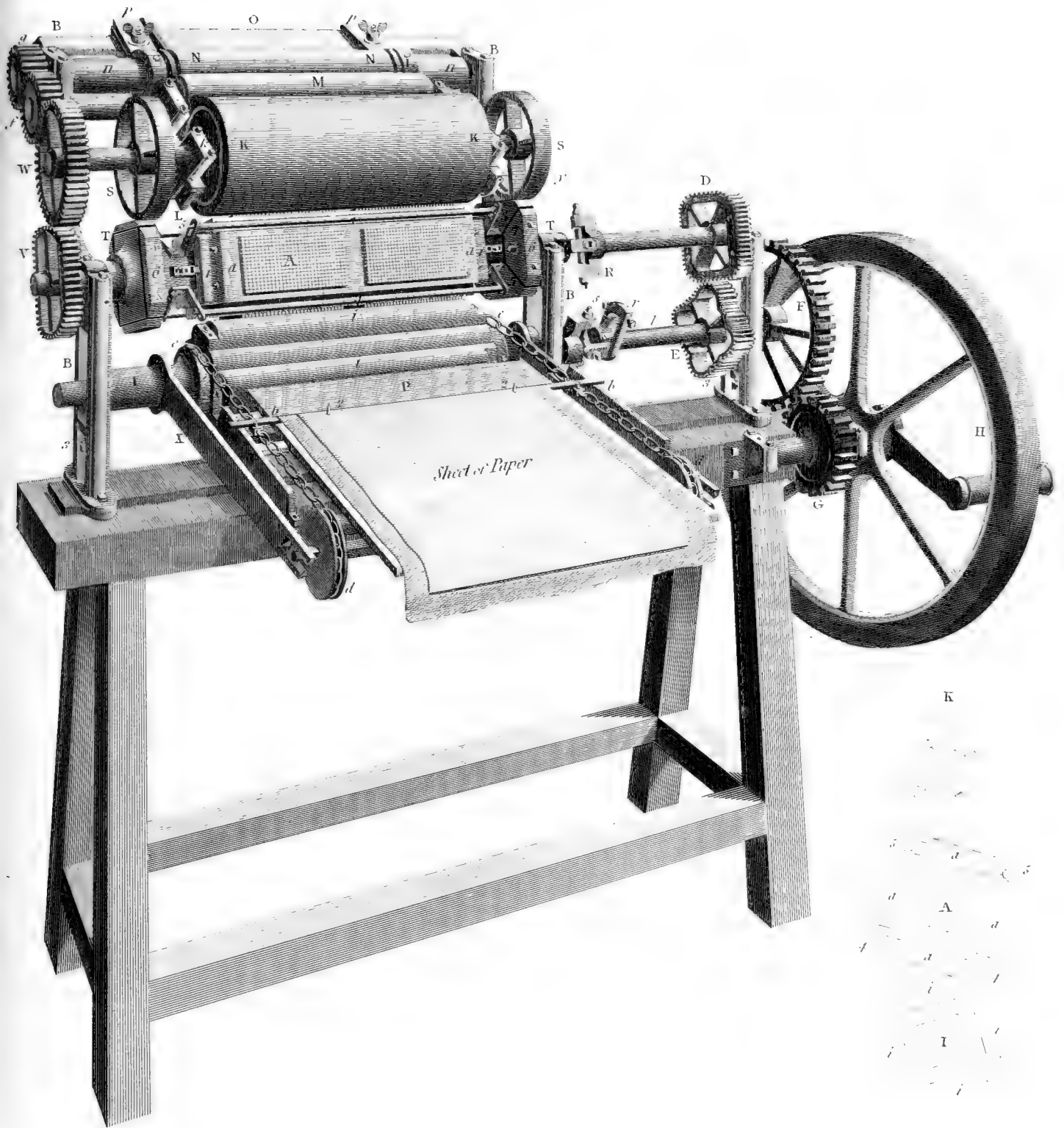
Fig. 4.





PRINTING .

Messrs Bacon & Donkin, PRINTING MACHINE.



Prospective View of a Common PRINTING PRESS.

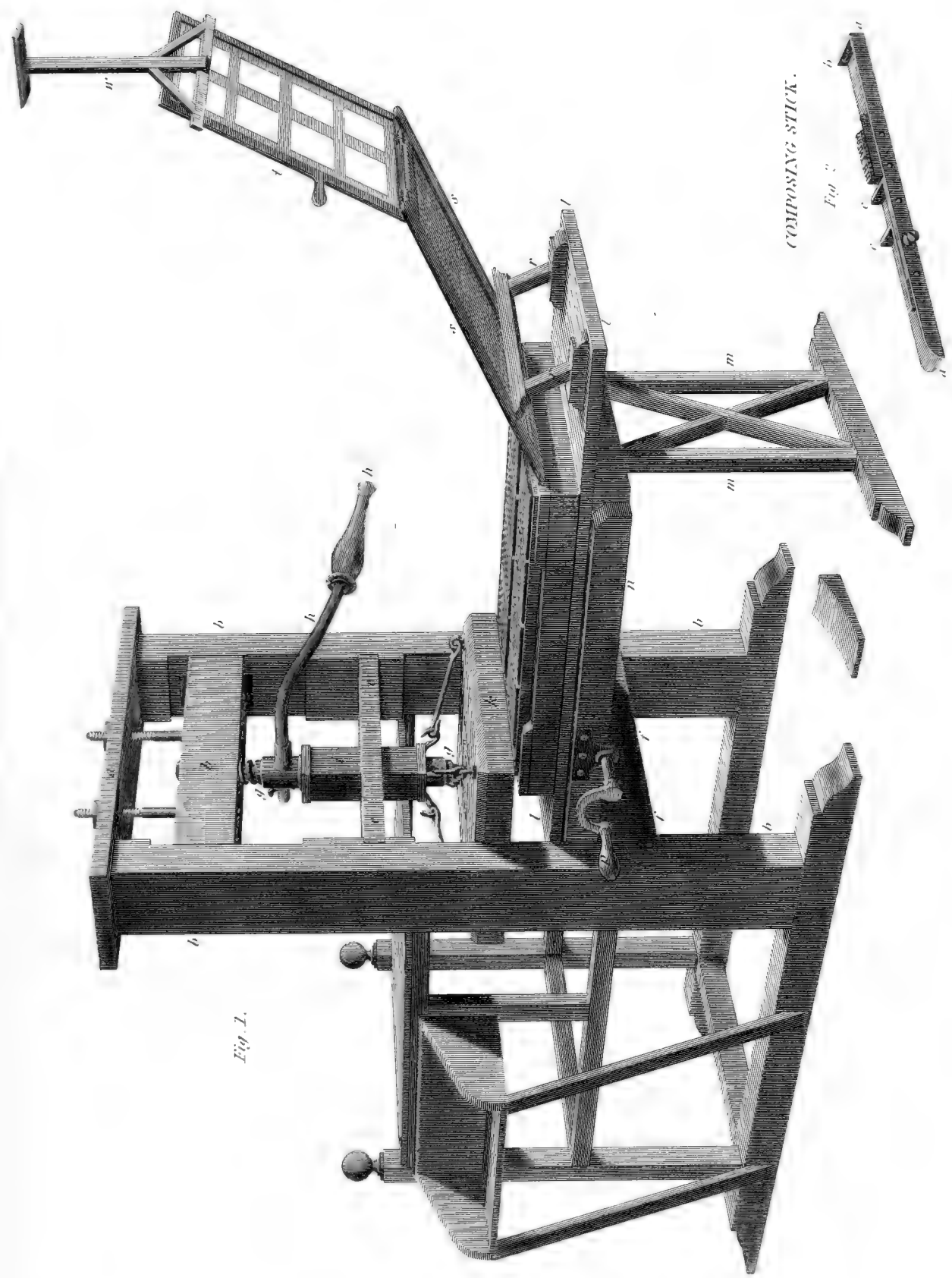


Fig. 1.

COMPOSING STICK.

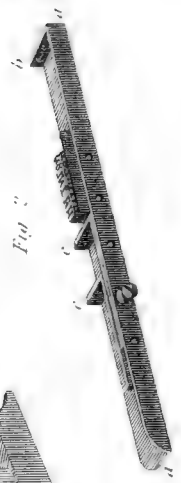
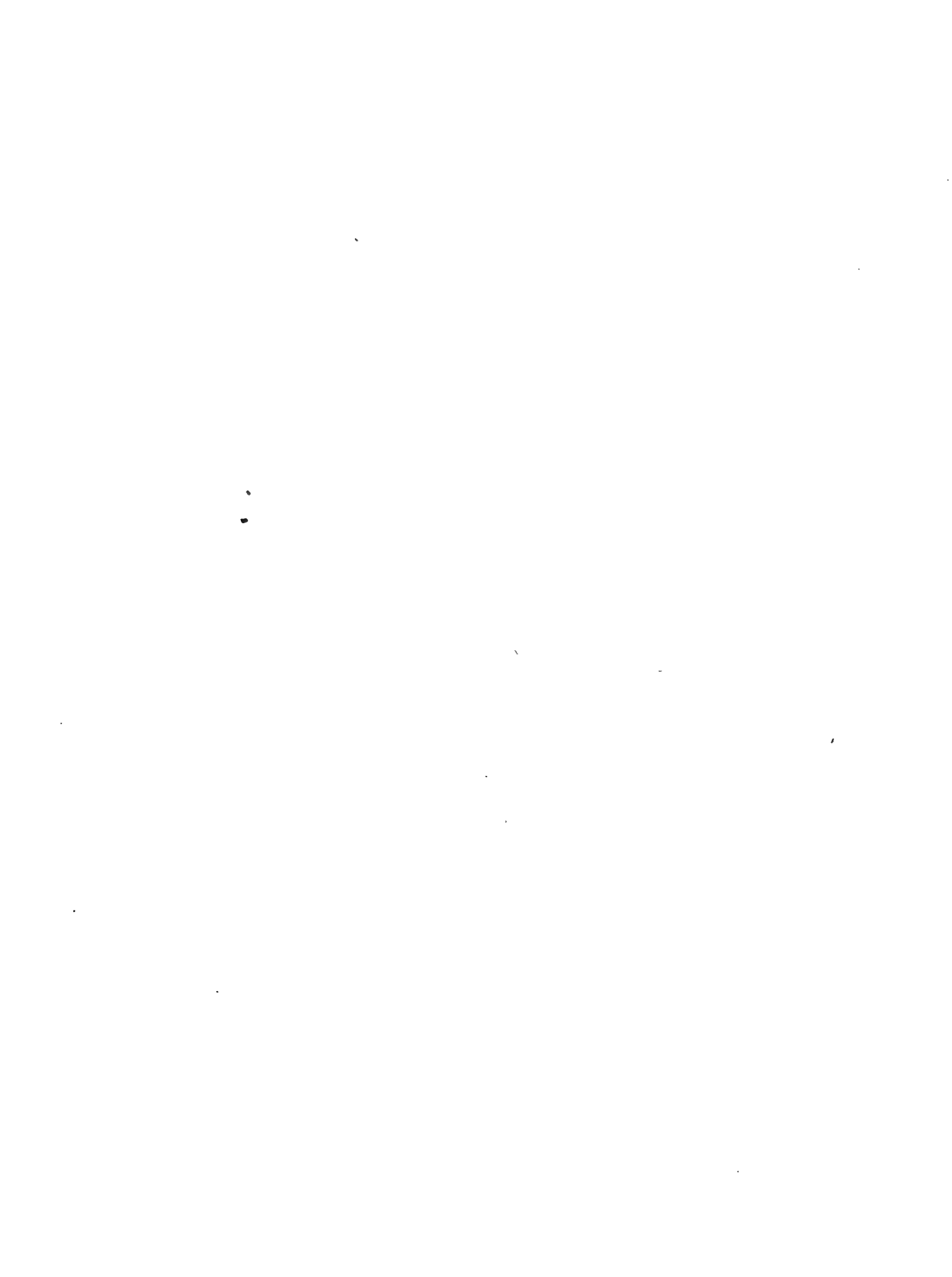
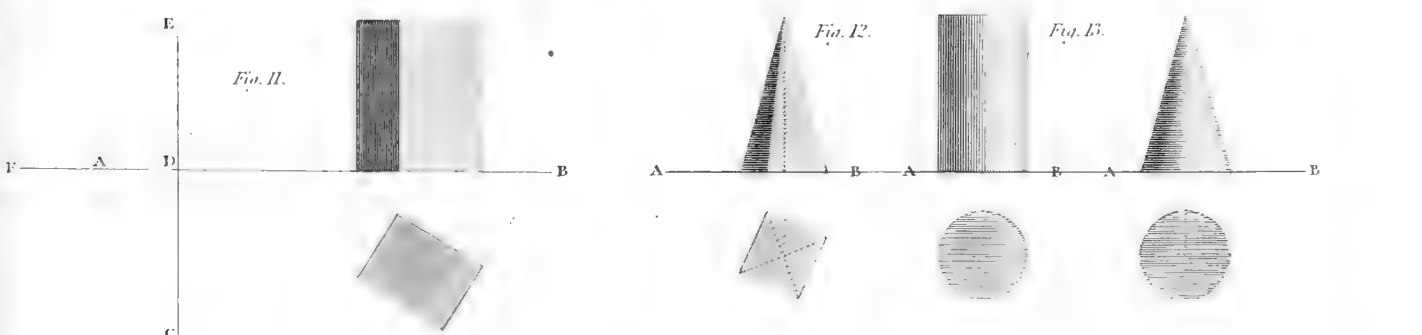
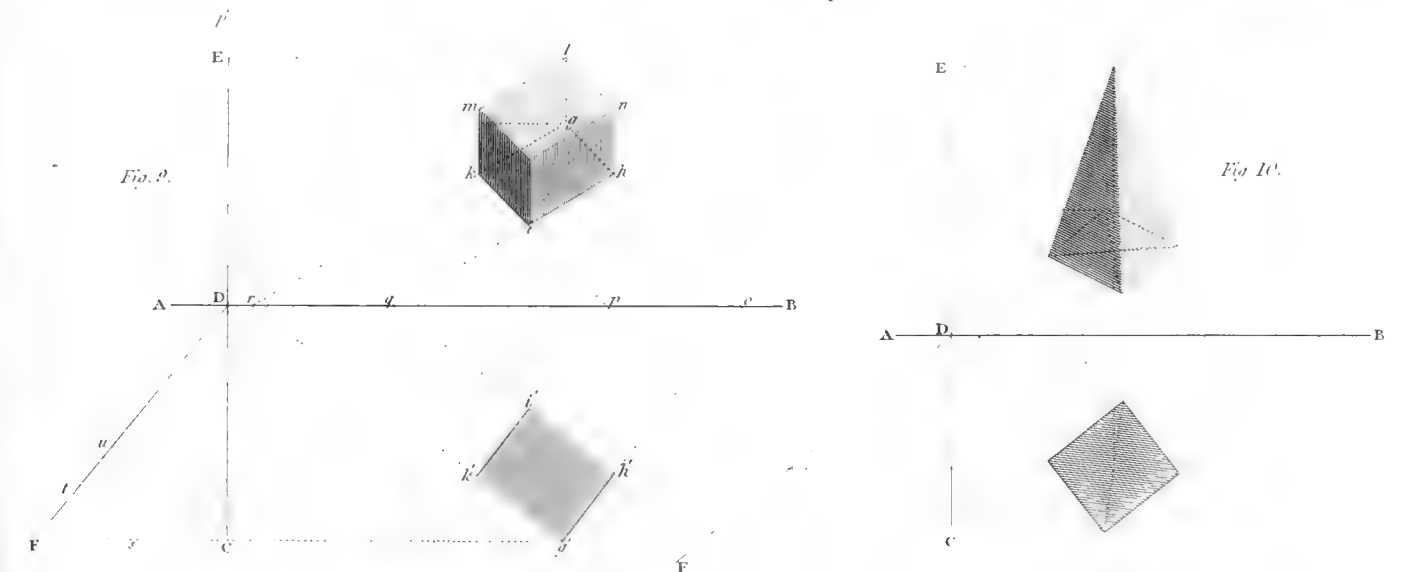
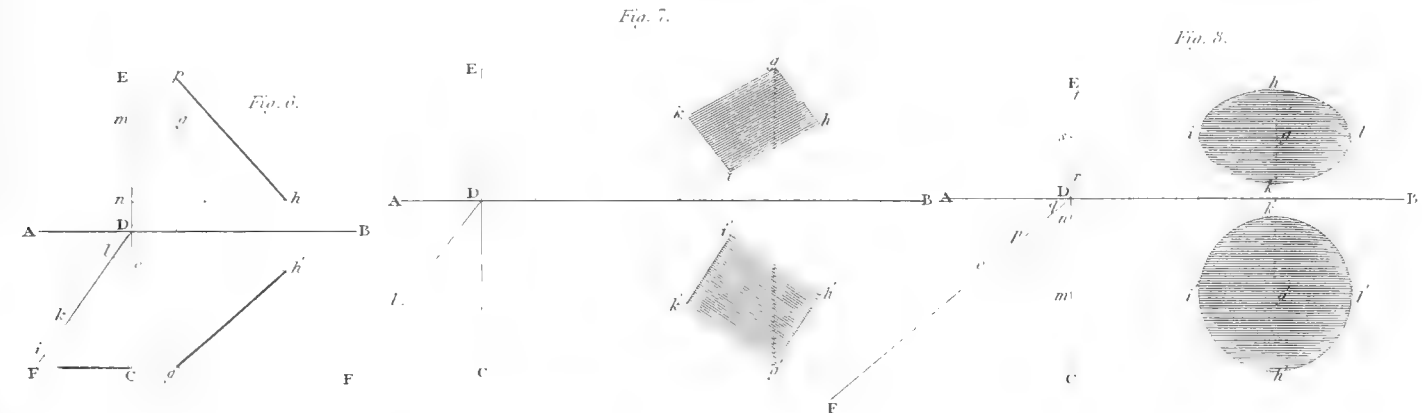
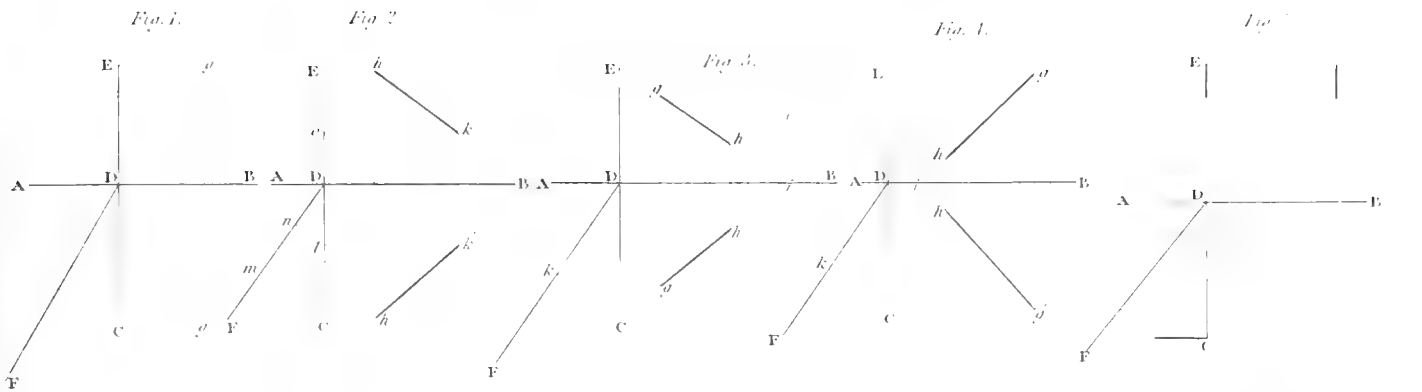
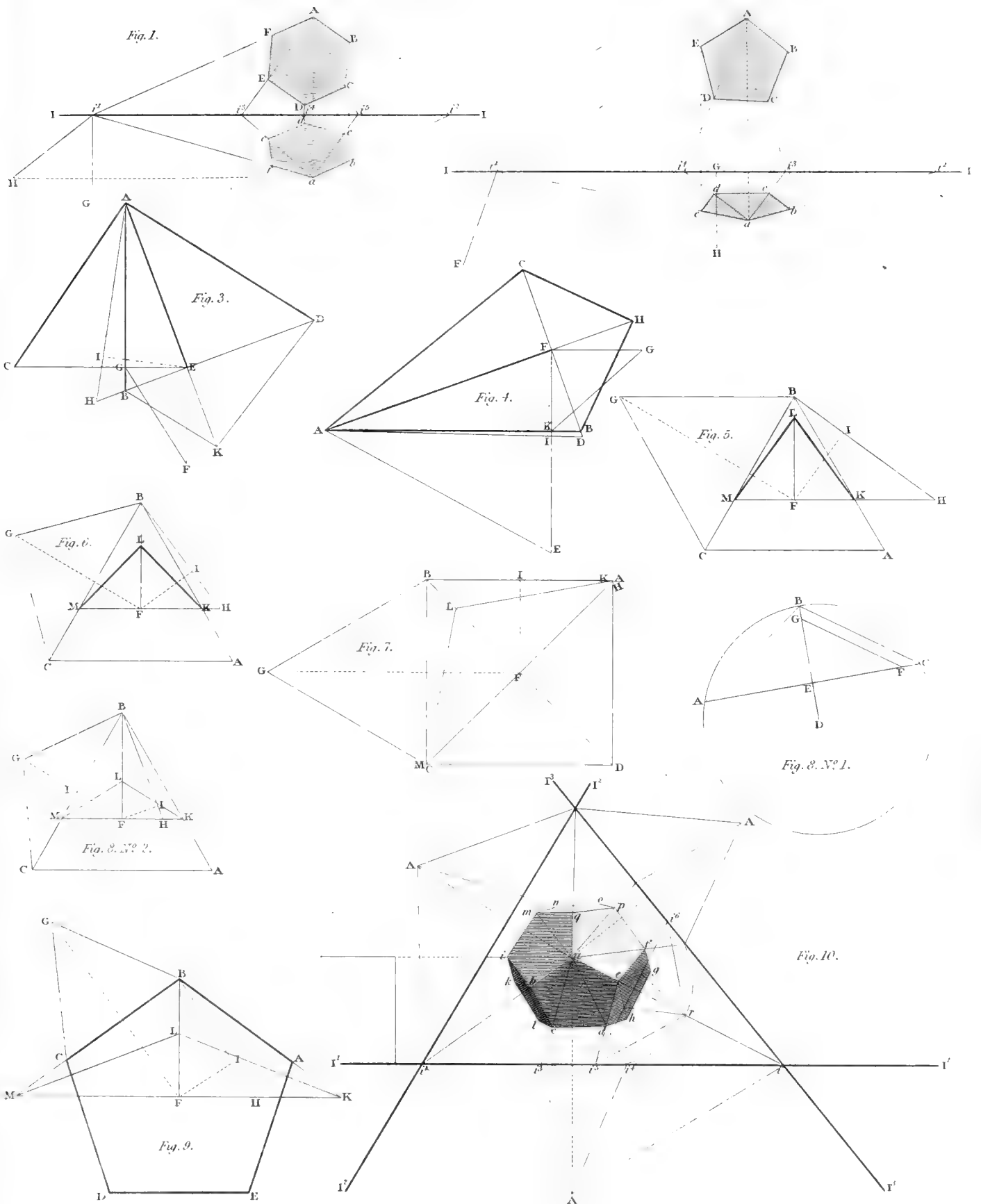
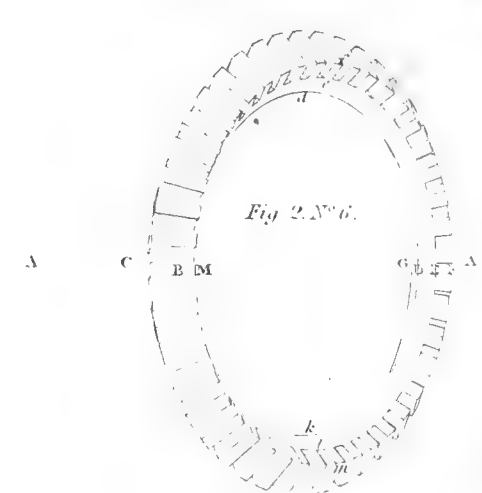
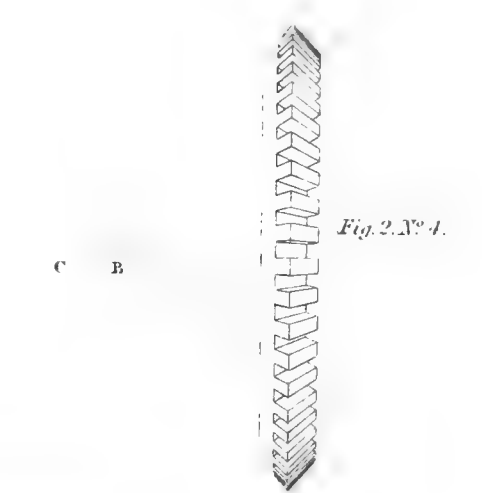
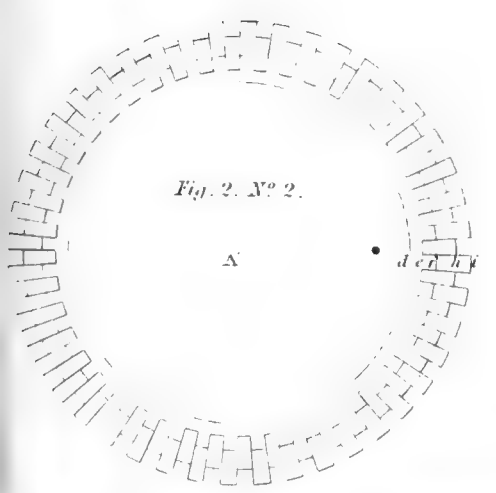
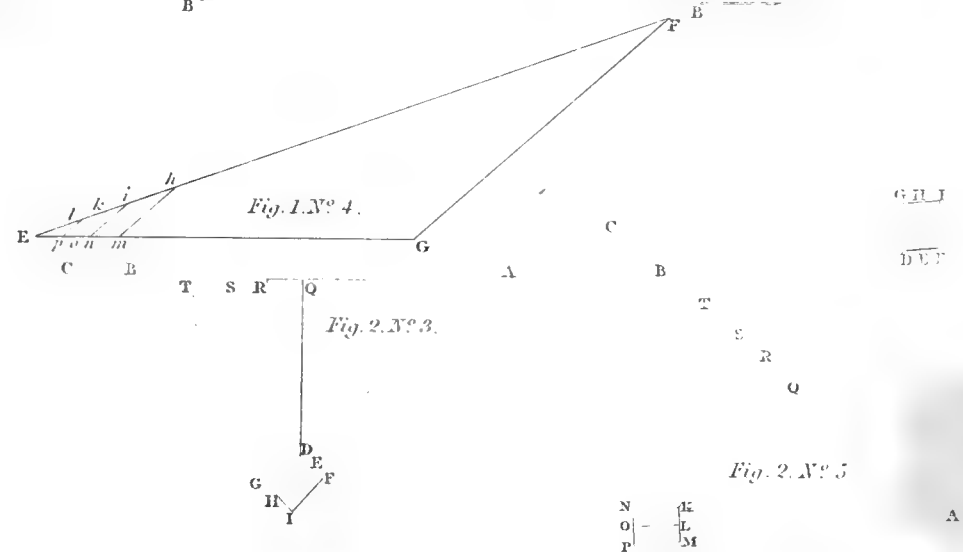
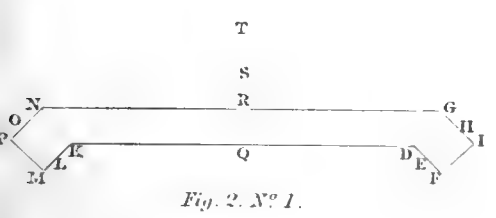
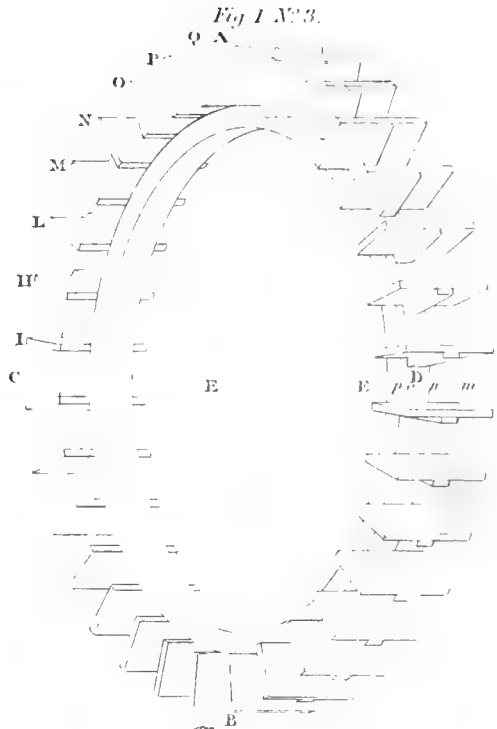
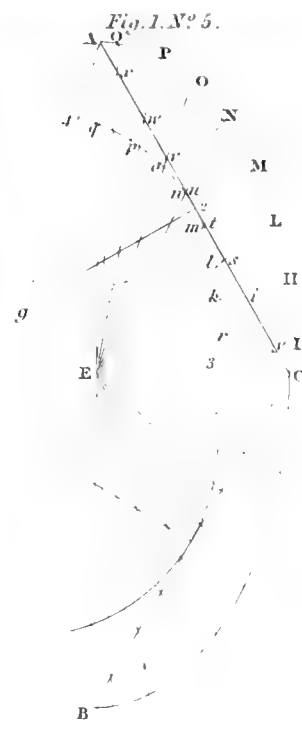
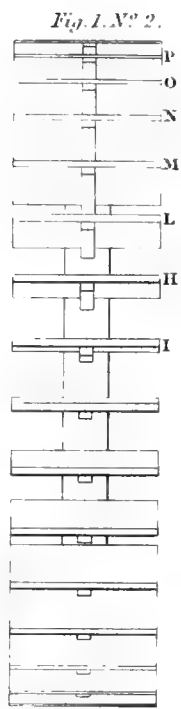
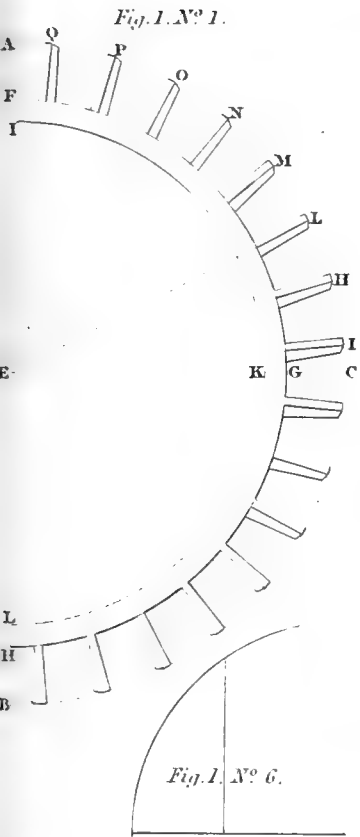


Fig. 2.









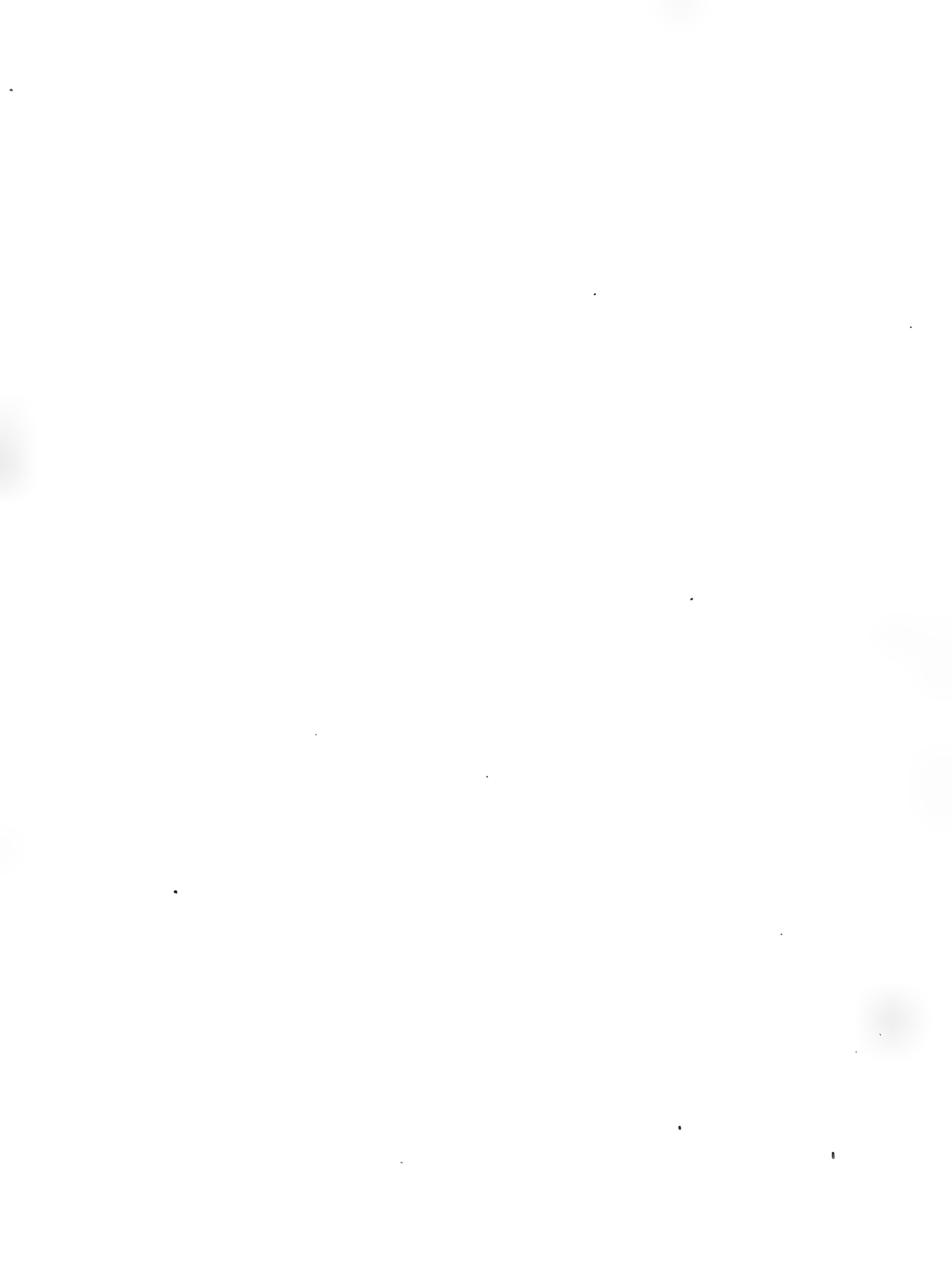


Fig. 1.

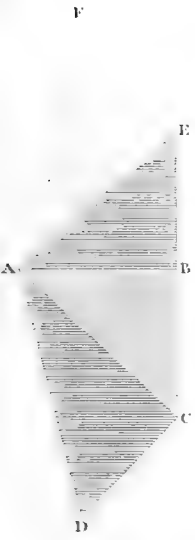


Fig. 1. N° 2.



Fig. 1. N° 3.

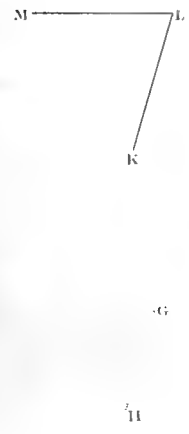


Fig. 2.

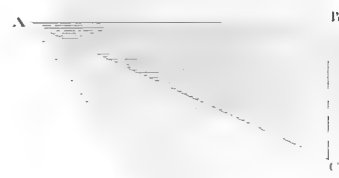


Fig. 3.

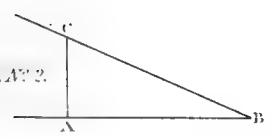
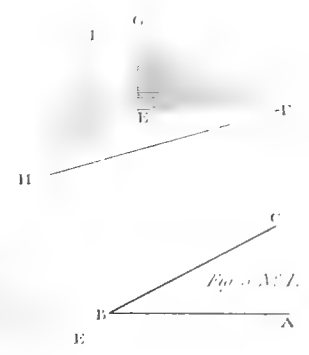


Fig. 1. N° 3.

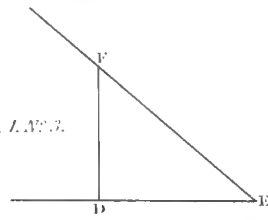


Fig. 4.

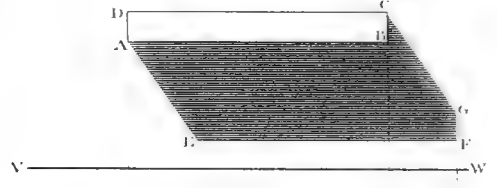
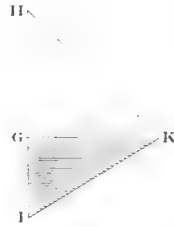


Fig. 5.

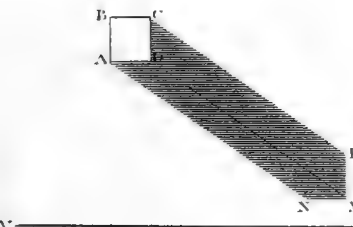
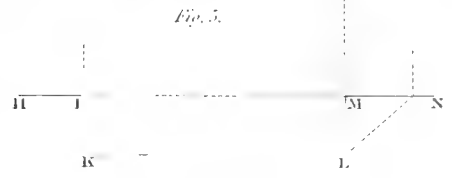


Fig. 6.

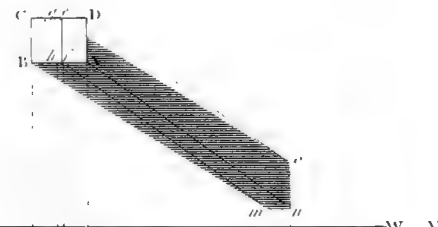


Fig. 7.

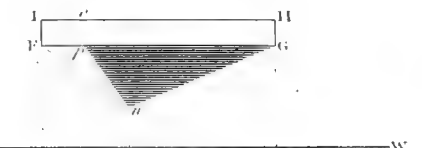


Fig. 8.



Fig. 9.

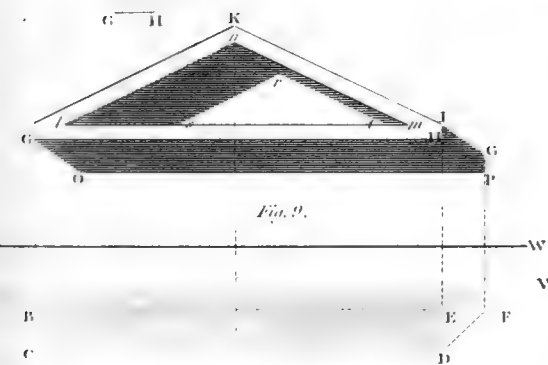


Fig. 10.

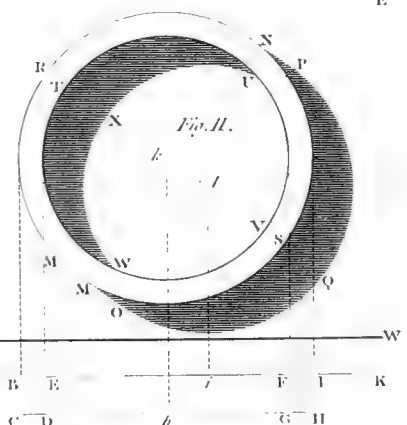
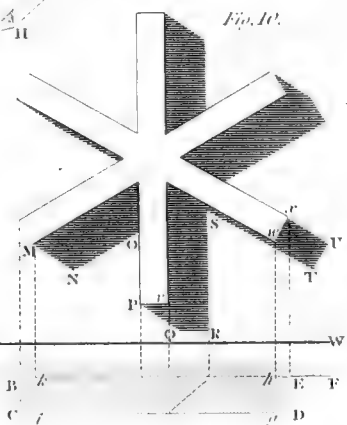
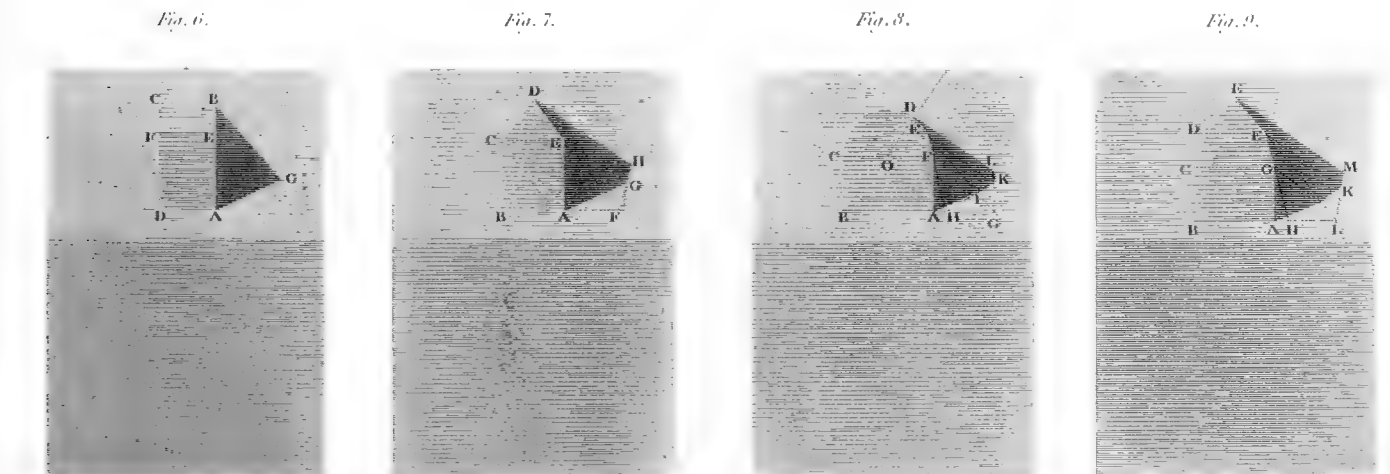
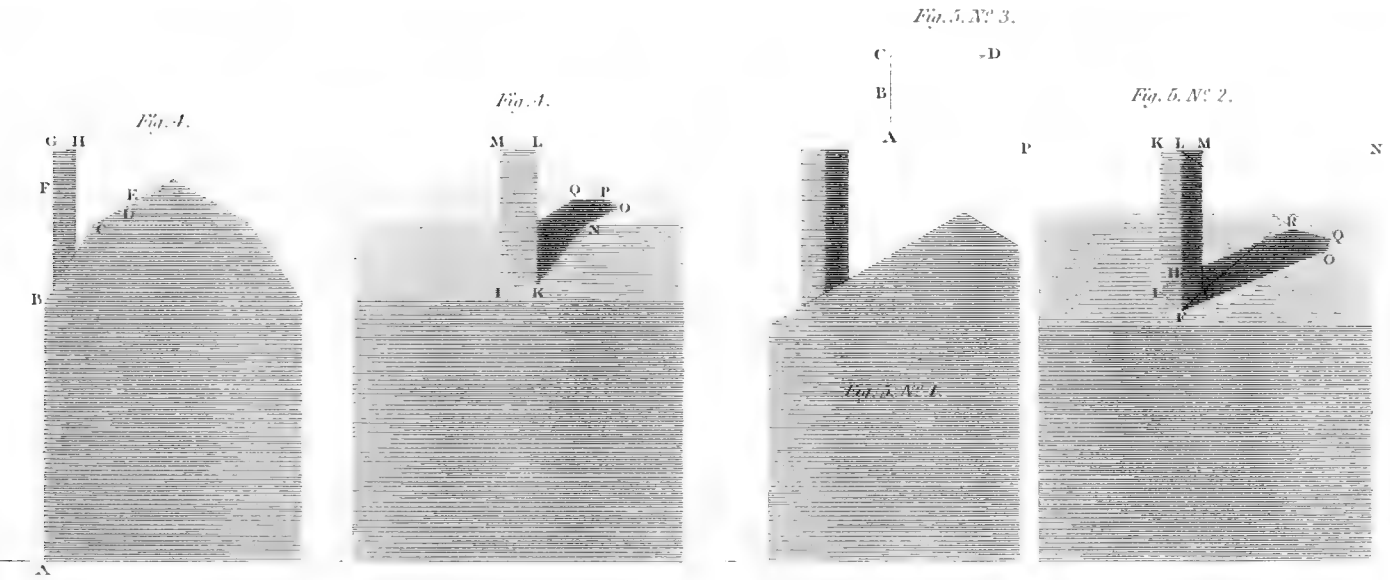
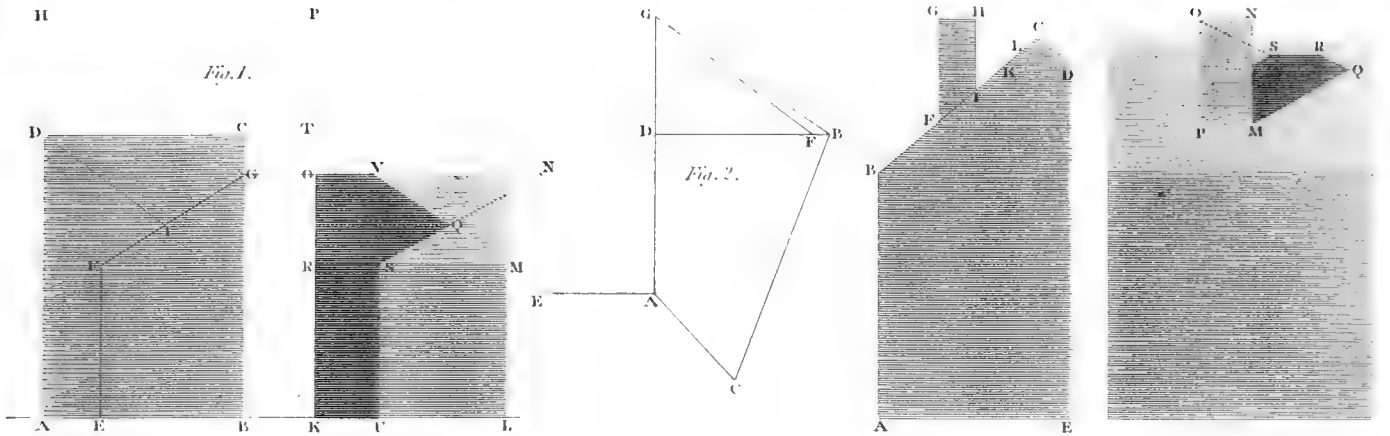


Fig. 11.



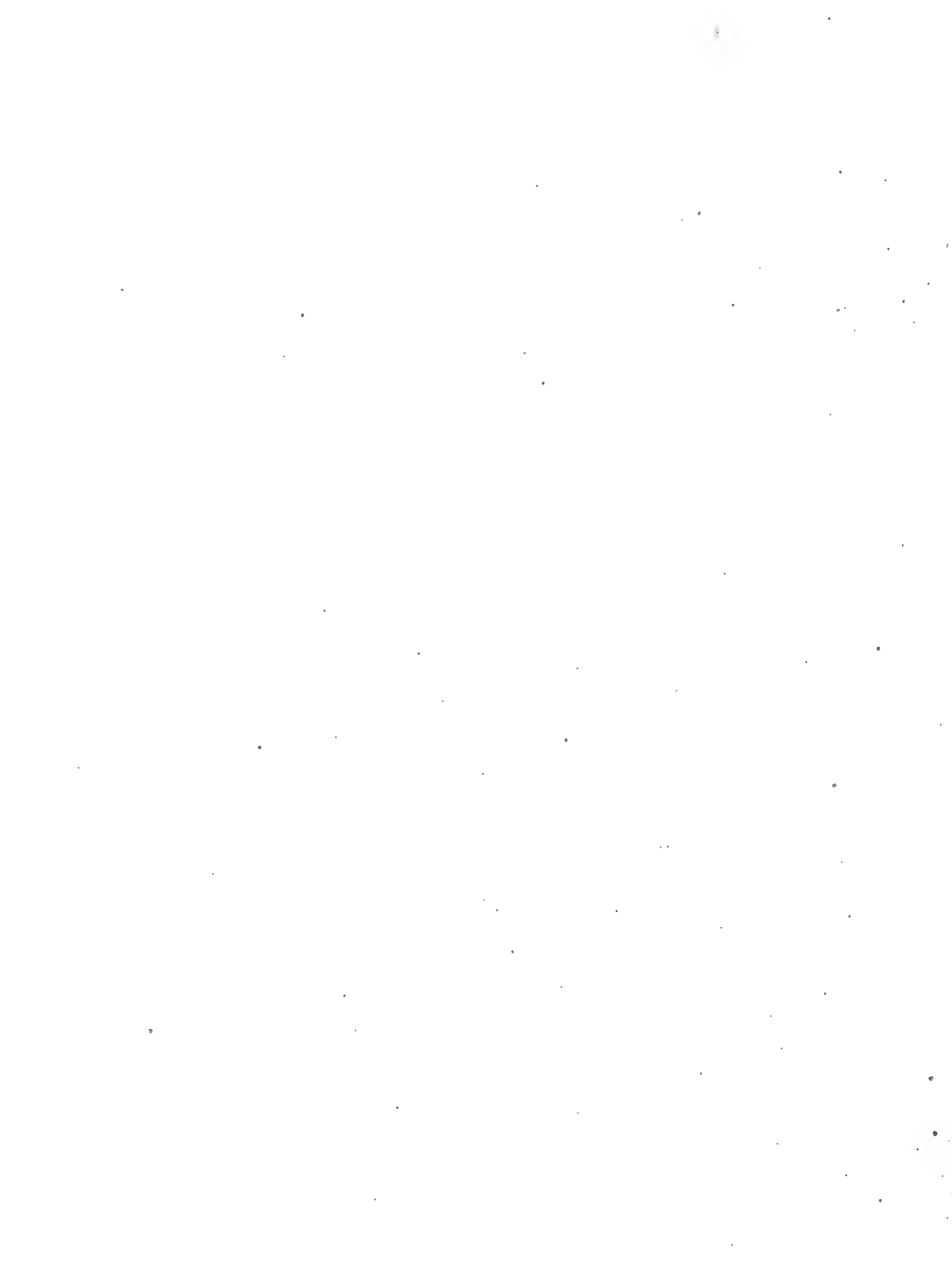


Fig. 1.

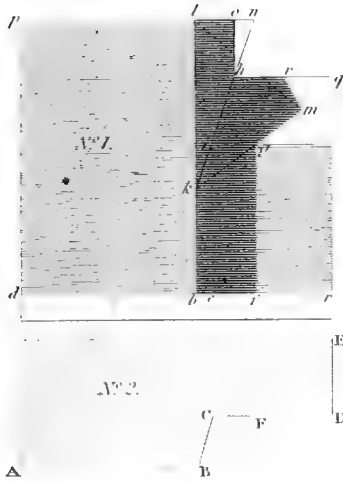


Fig. 2.

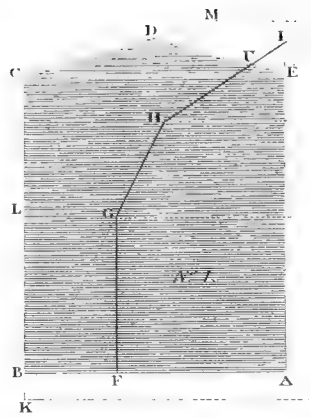


Fig. 3.

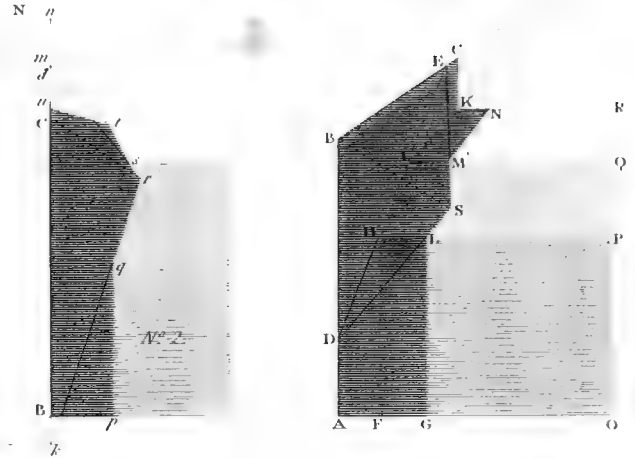


Fig. 4.

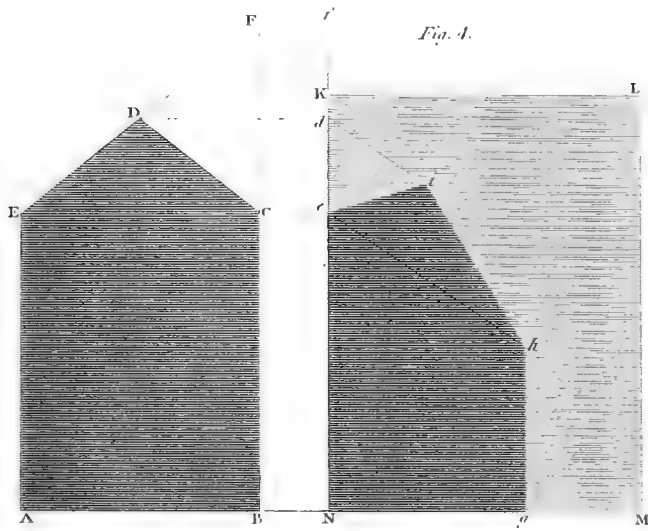


Fig. 5.

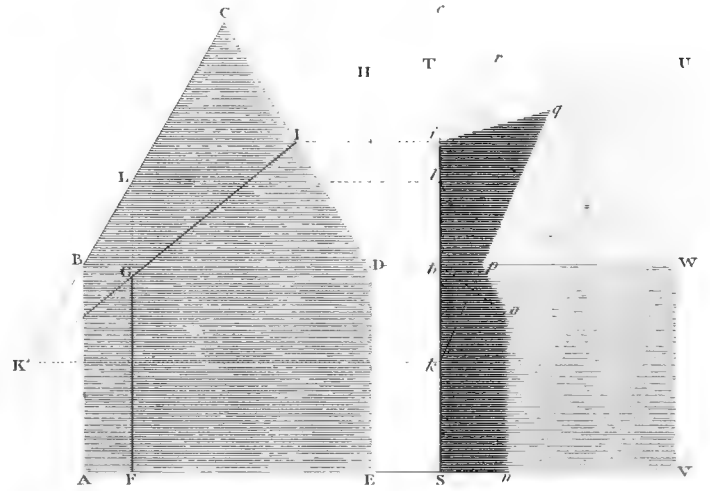


Fig. 6. N° 1.

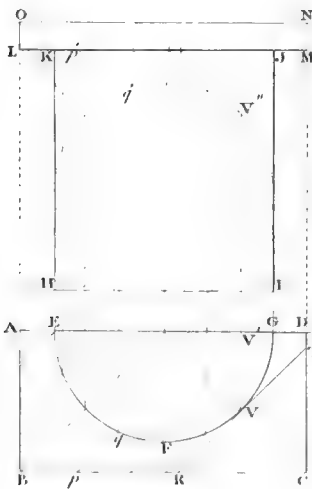


Fig. 6. N° 2.

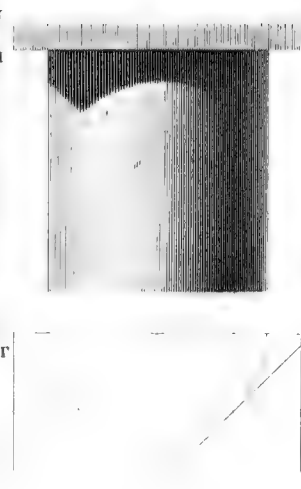


Fig. 7. N° 1.

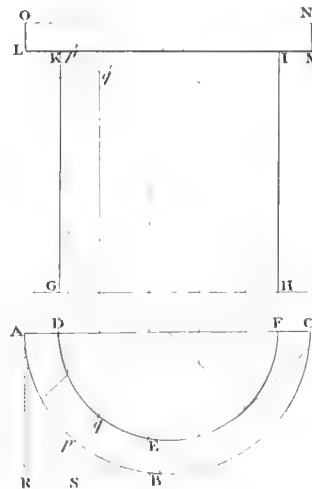
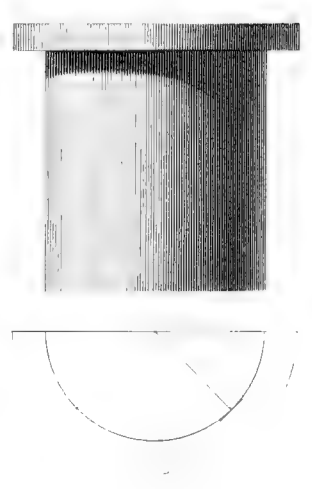


Fig. 7. N° 2.



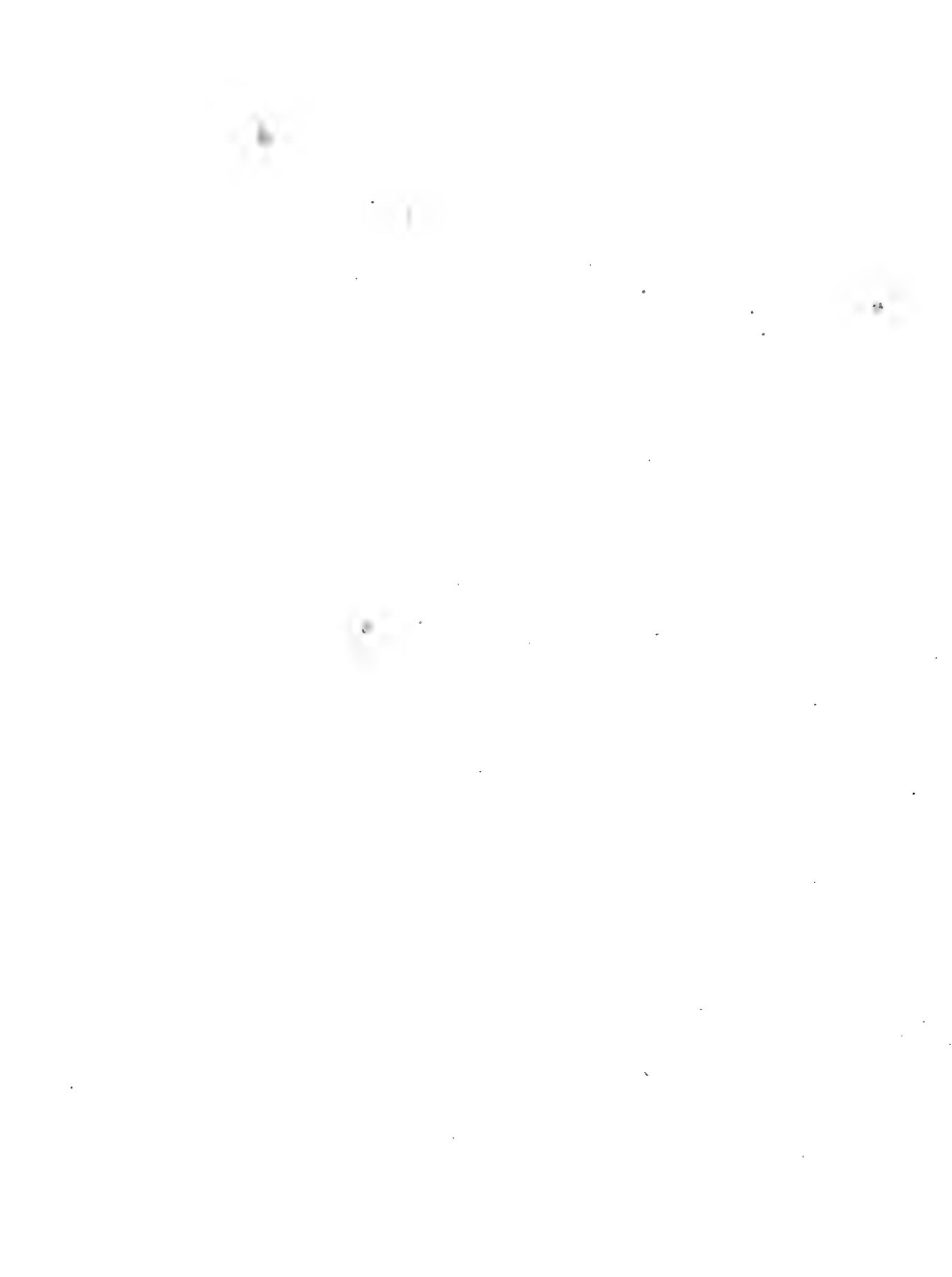


Fig. 1.

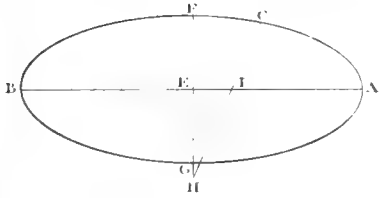


Fig. 1.

S



Fig. 2.

Fig. 3.

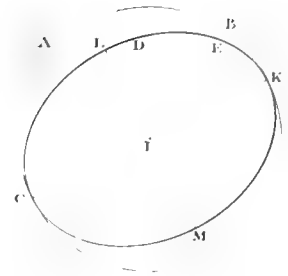


Fig. 6.

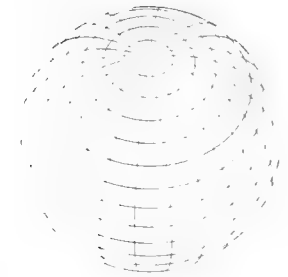


Fig. 9.

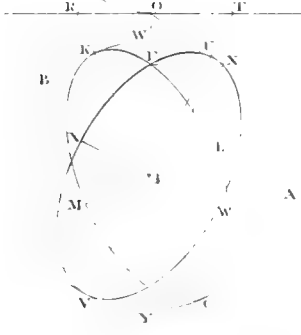


Fig. 7.

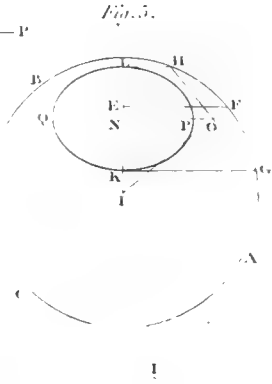


Fig. 5.

Fig. 8.

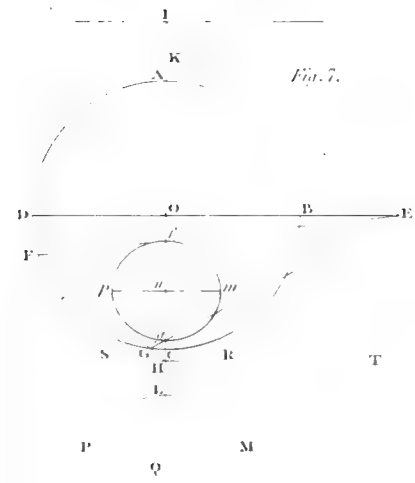


Fig. 10.

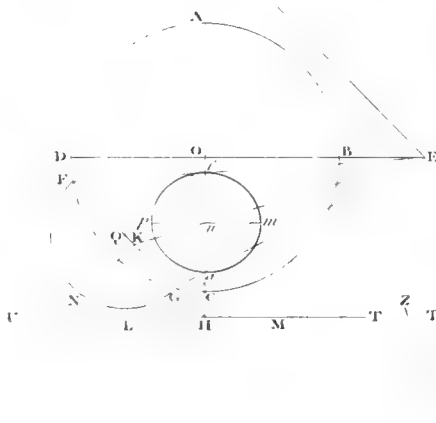


Fig. 11.

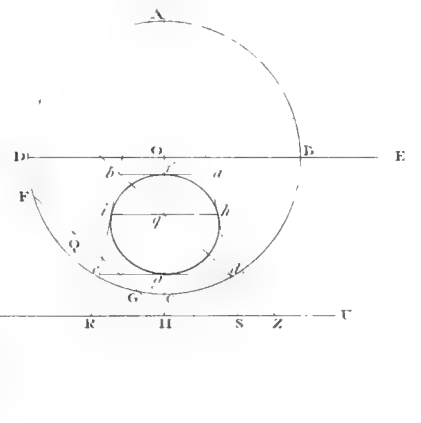


Fig. 12.

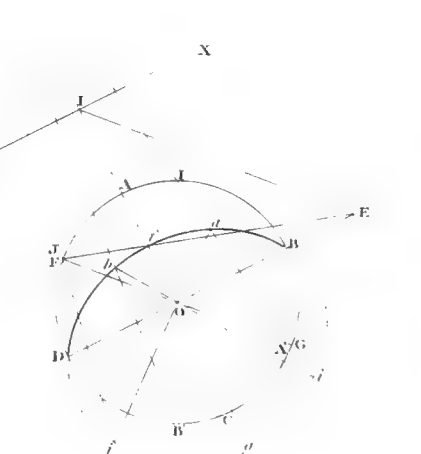
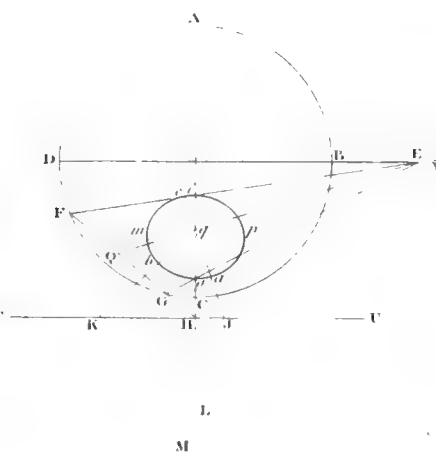
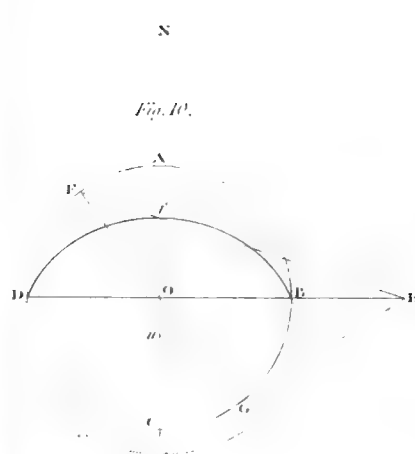


Fig. 1.

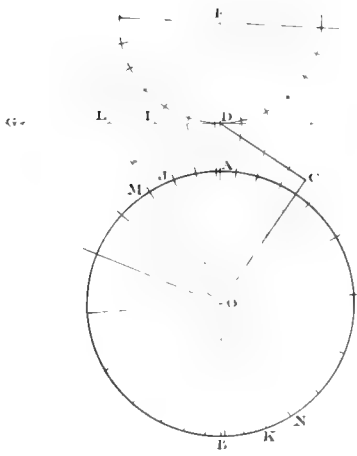


Fig. 2.

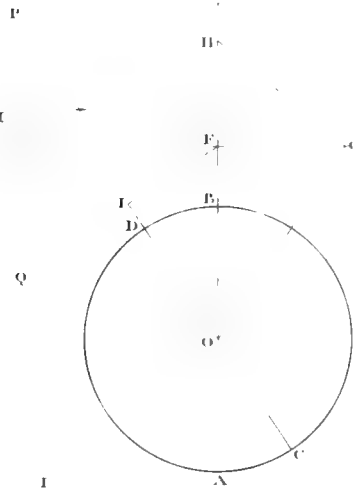


Fig. 3.

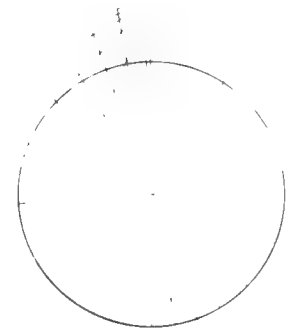


Fig. 4.

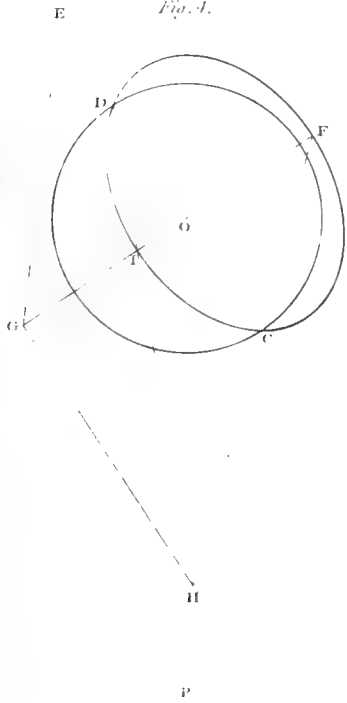


Fig. 5.

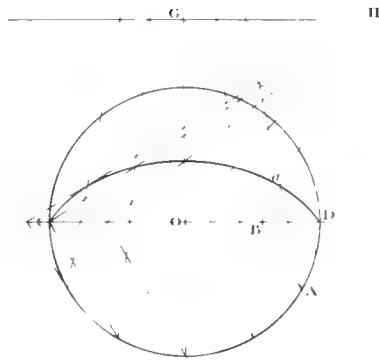


Fig. 6.

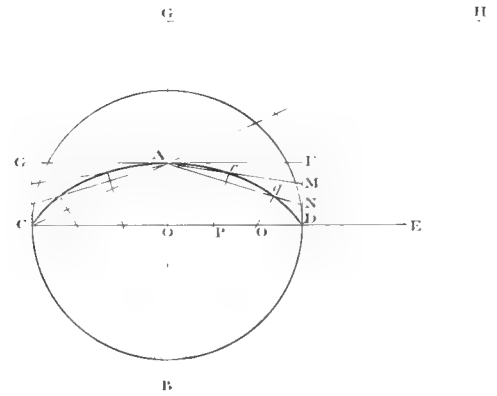


Fig. 7.

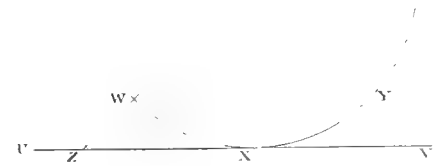


Fig. 8.

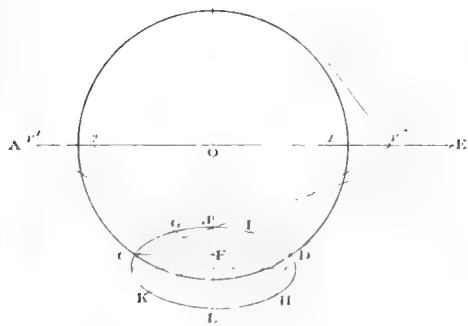


Fig. 9.

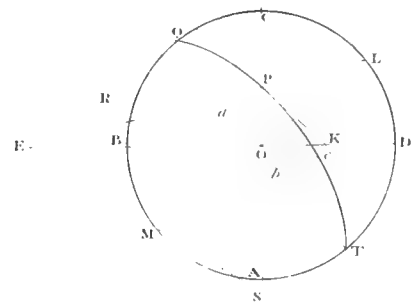
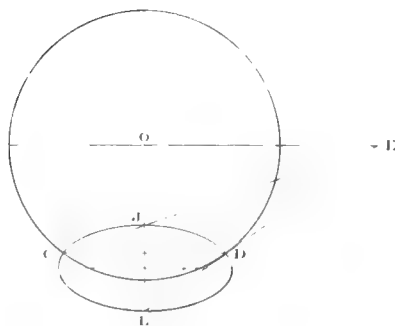


Fig. 1.

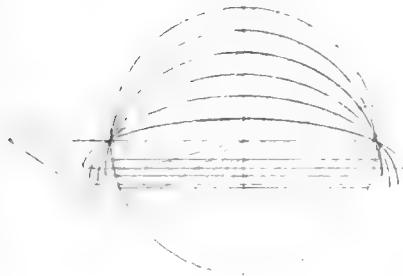


Fig. 2.

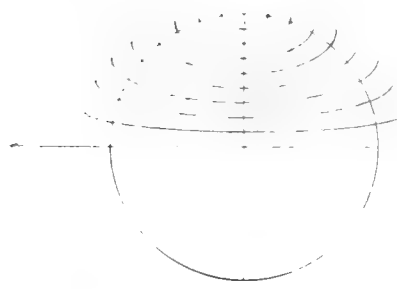


Fig. 3.

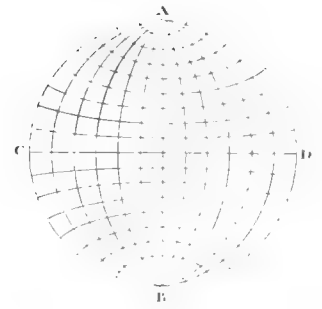


Fig. 4.

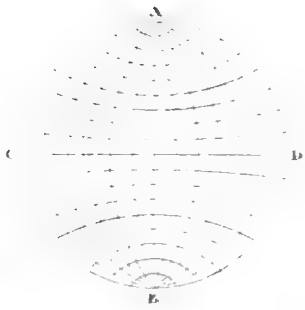


Fig. 5.

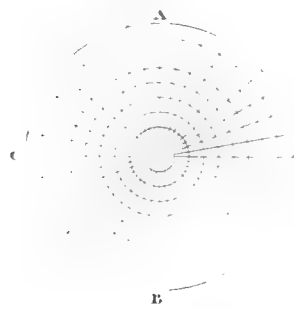


Fig. 6.



Fig. 7.



Fig. 8.

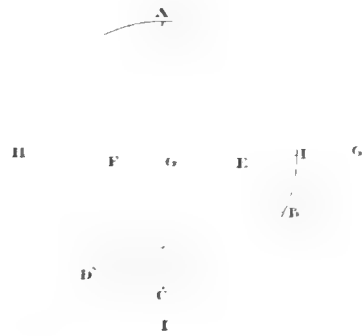


Fig. 9.

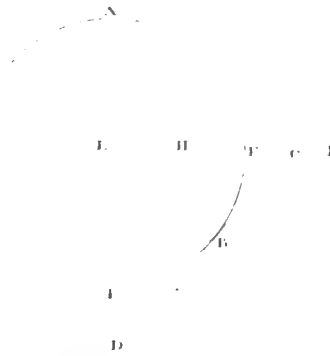


Fig. 10.



Fig. 11.

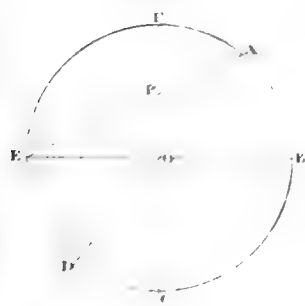


Fig. 12.

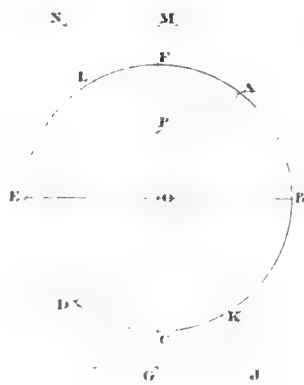


Fig. 13.

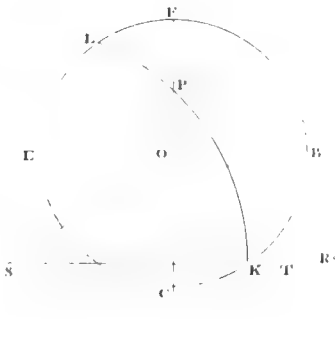
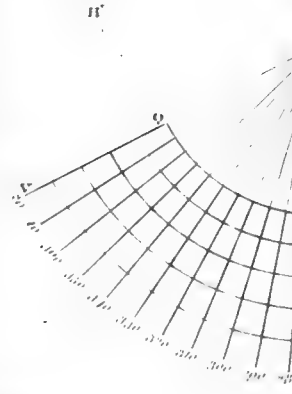
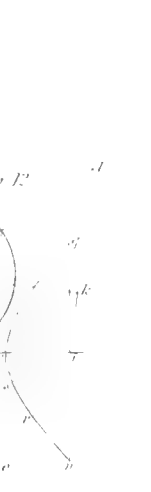
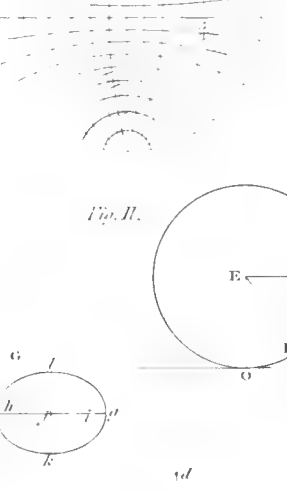
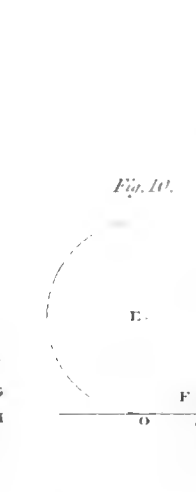
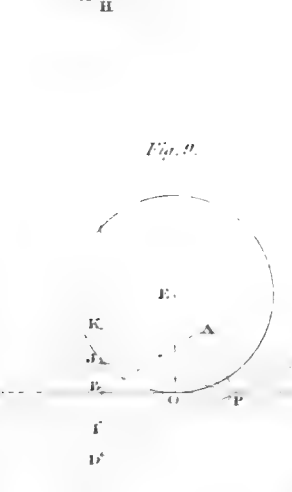
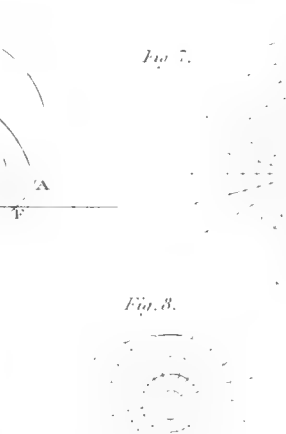
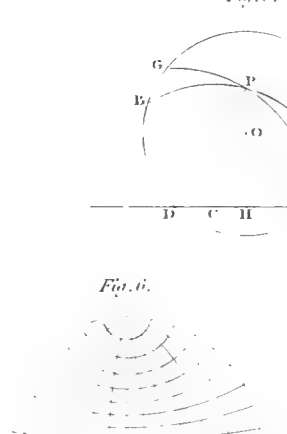
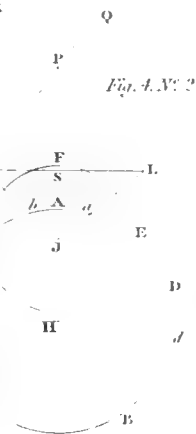
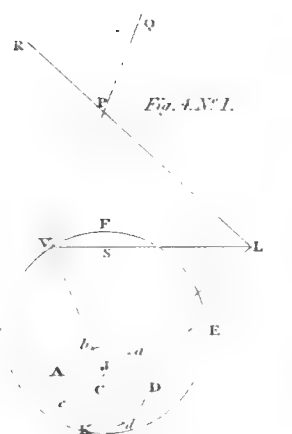
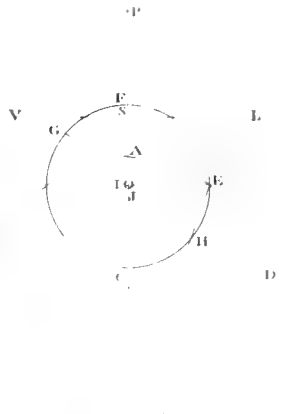
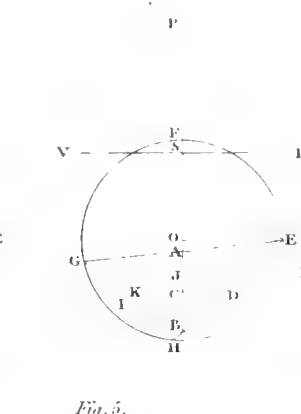
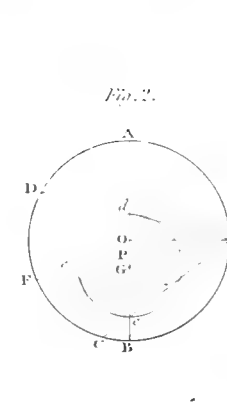
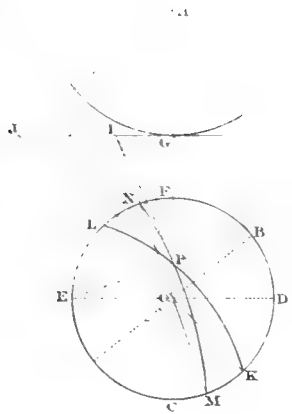


Fig. 14.





PROPORTIONAL COMPASSES.

Fig. 1.

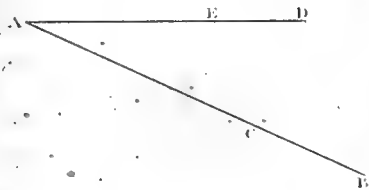


Fig. 2.

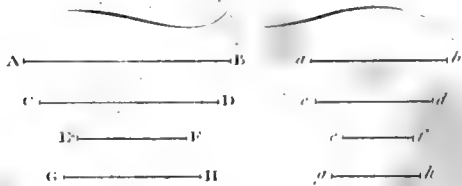


Fig. 3.

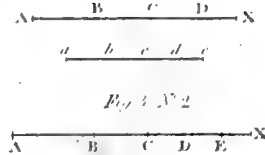


Fig. 7.

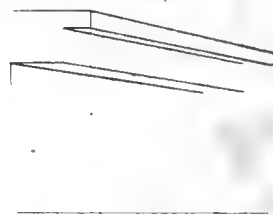


Fig. 4.

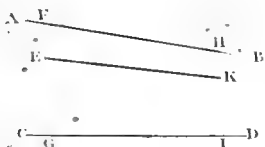


Fig. 5.

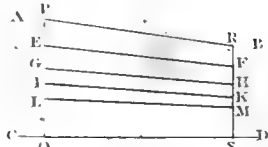


Fig. 6.

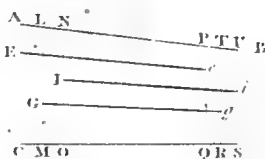


Fig. 12.

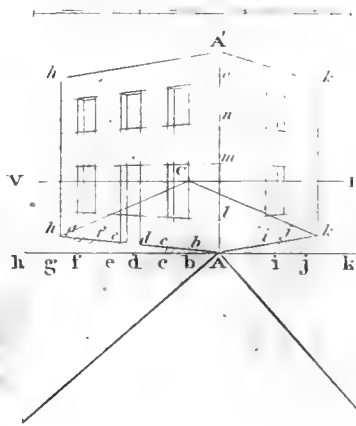


Fig. 13.

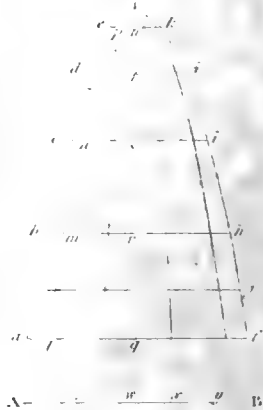


Fig. 8.

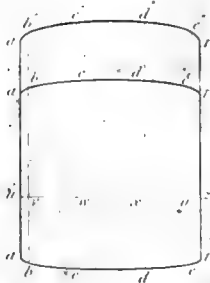


Fig. 9.

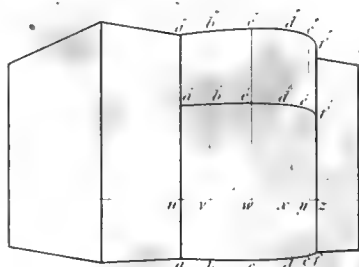


Fig. 14.

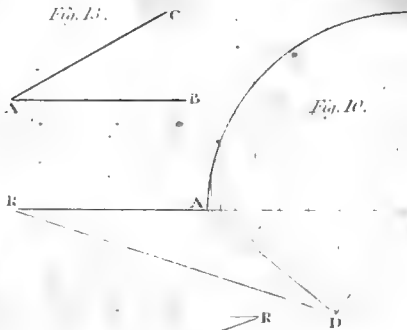


Fig. 11.

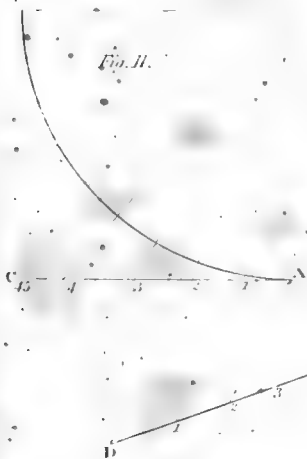


Fig. 10.



Fig. 14.

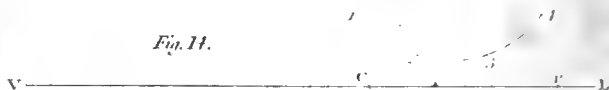


Fig. 16.

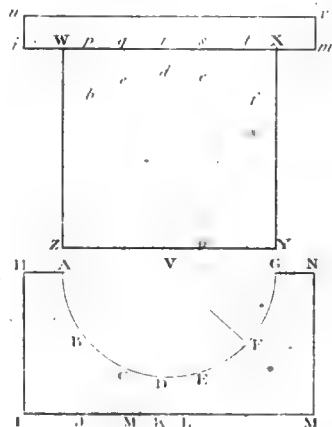


Fig. 17. N^o 1.

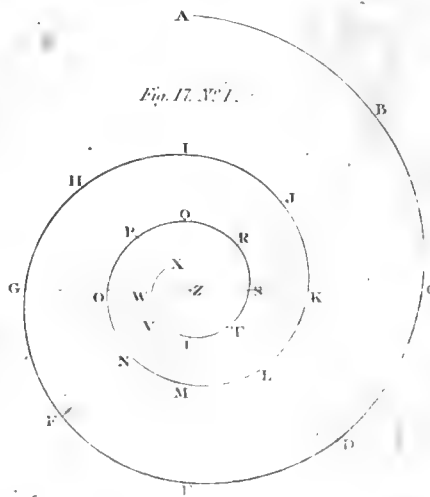


Fig. 17. N^o 2.



Fig. 15. N^o 1.

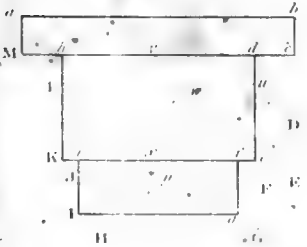
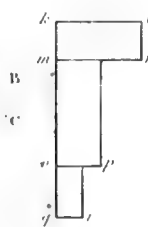
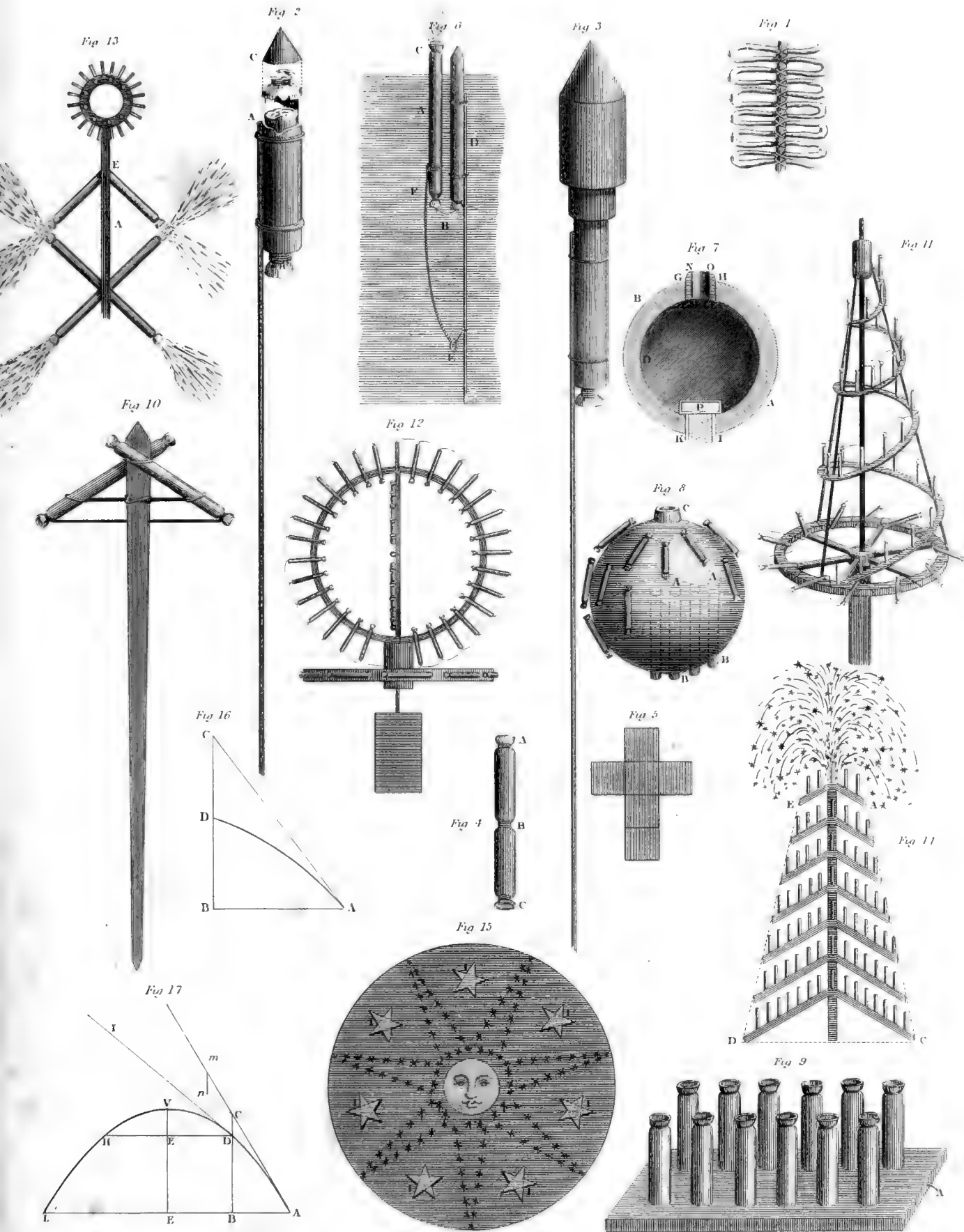


Fig. 15. N^o 2.





PYROTECHNY



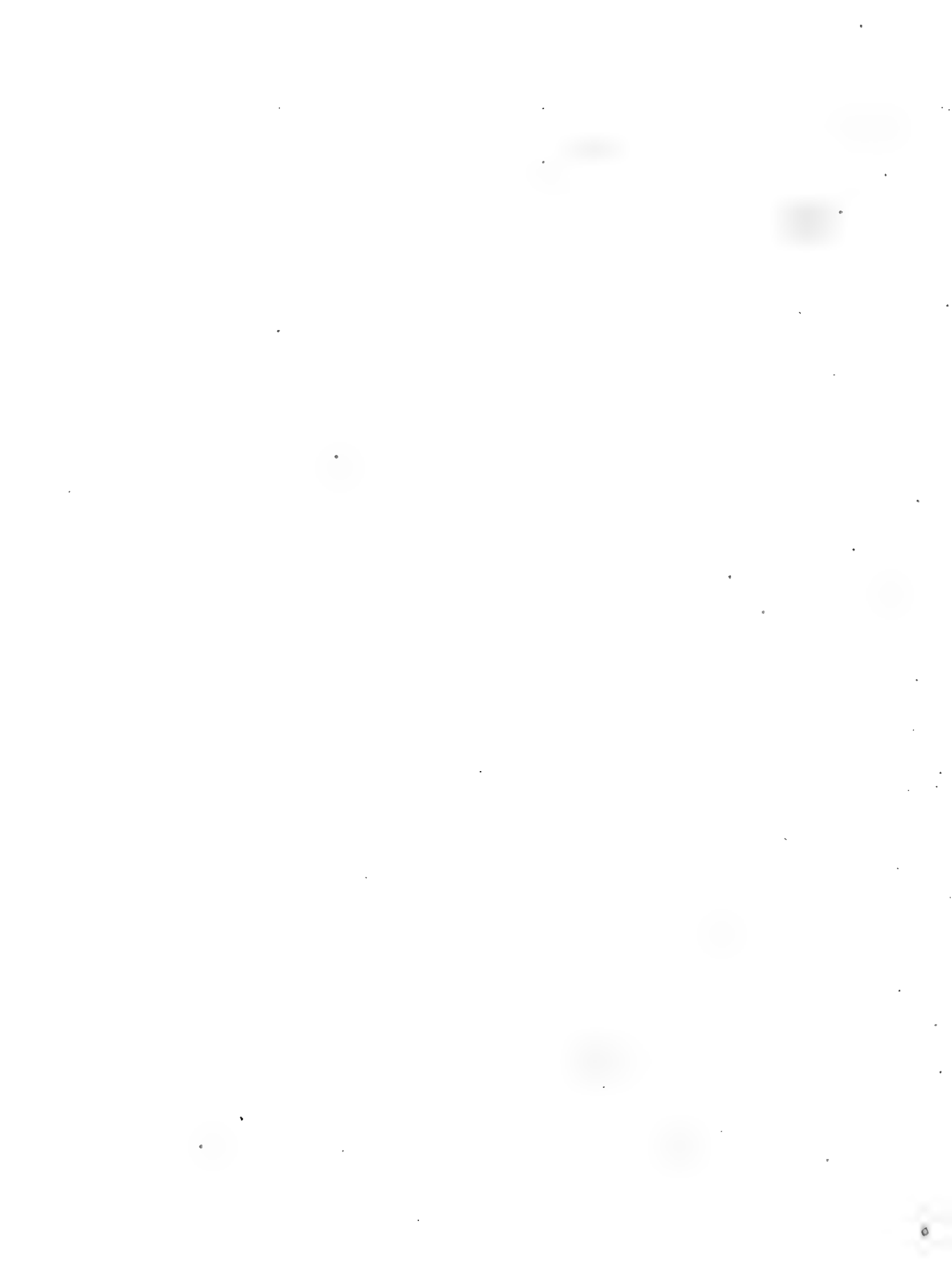


Fig. 1.

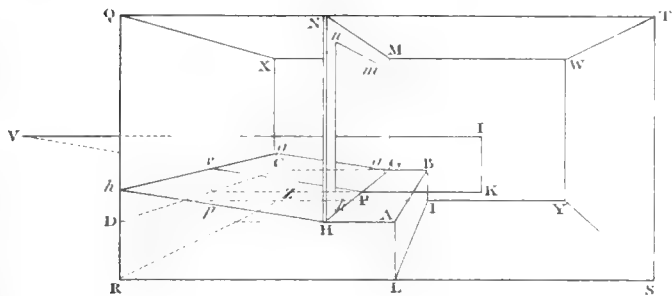


Fig. 2.

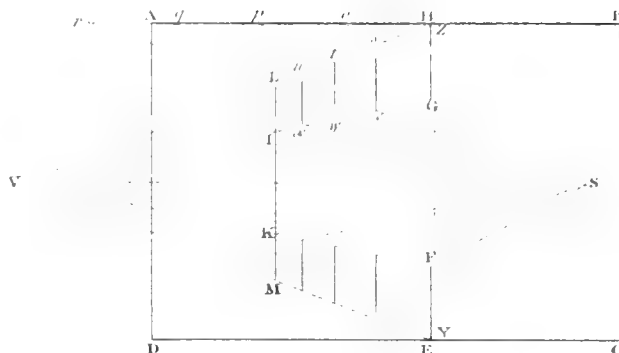


Fig. 5.

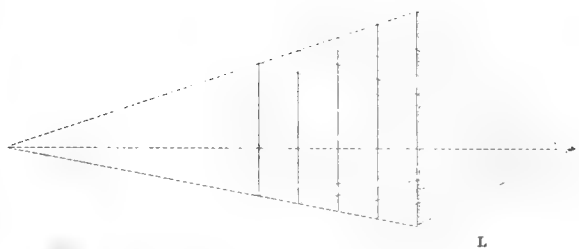


Fig. 3.

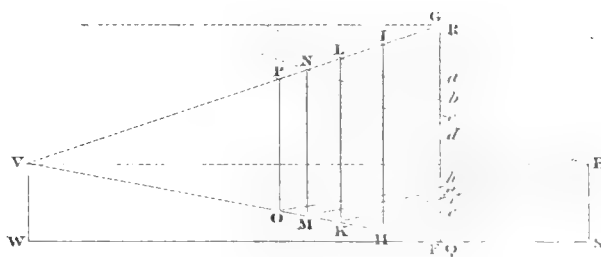


Fig. 8.

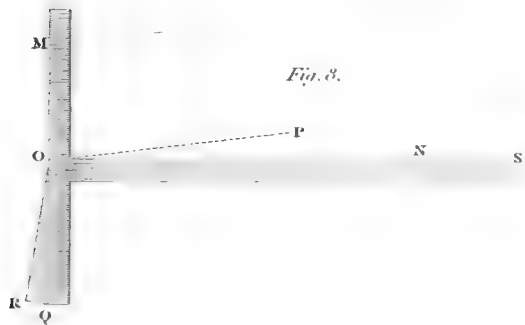


Fig. 6.

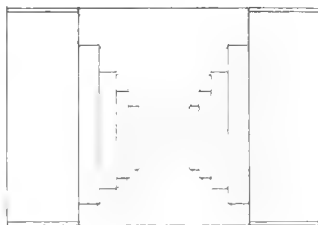


Fig. 4.

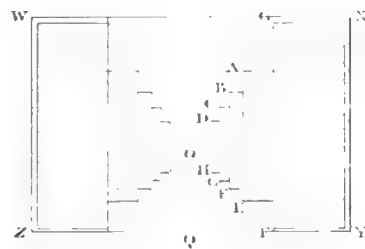


Fig. 9.

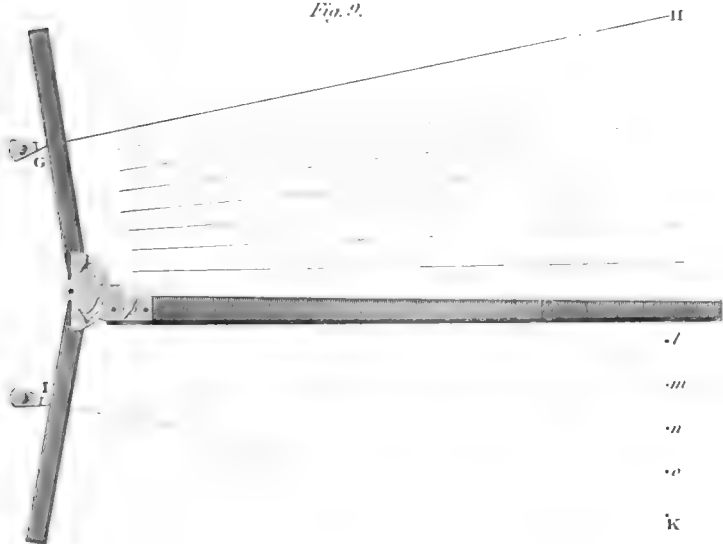


Fig. 10.

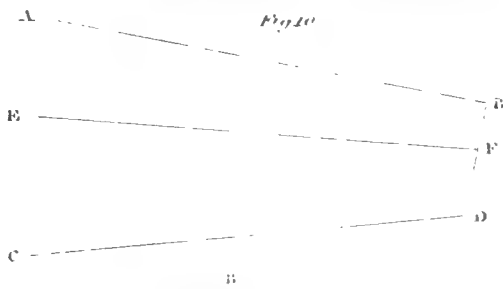
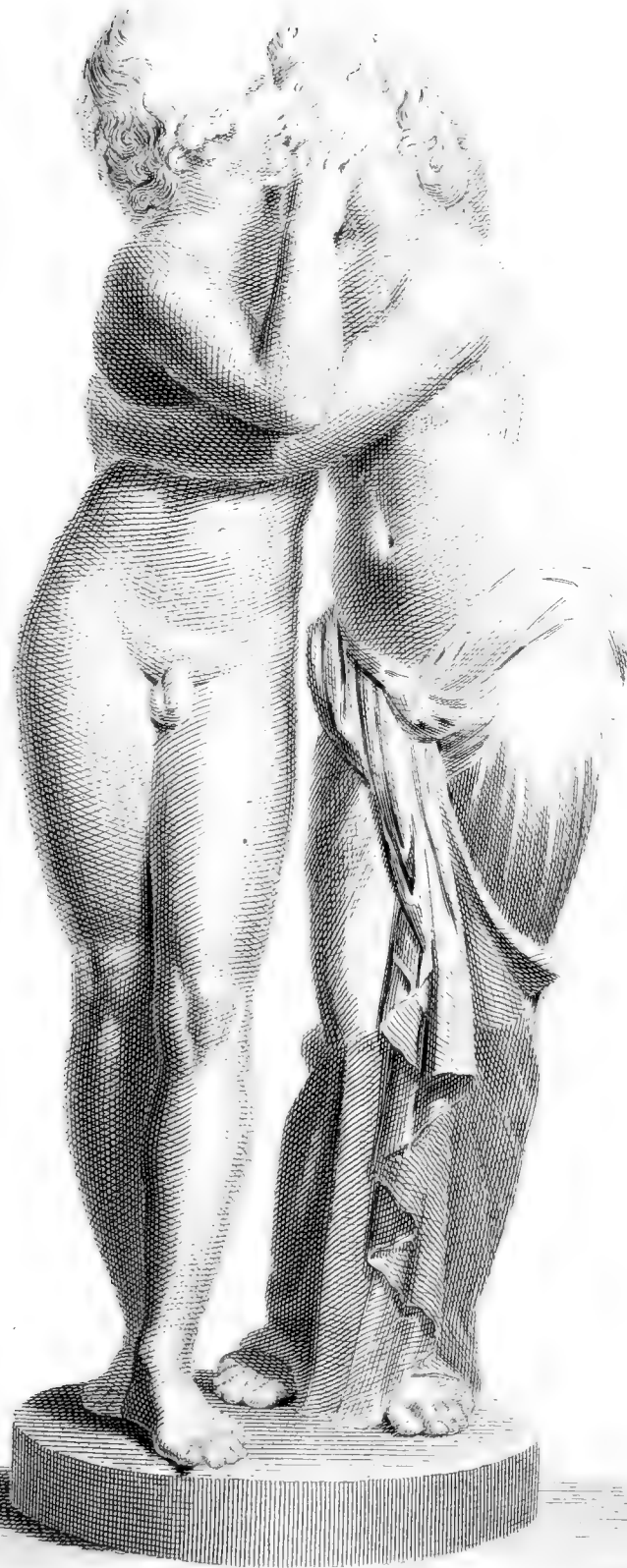


Fig. 7.

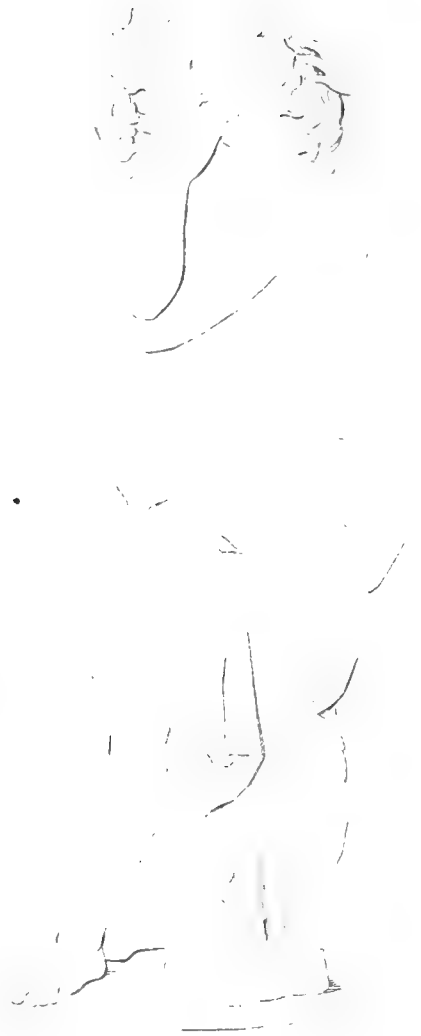




Drawn by H. Howard.

Engraved by R.R. Currier.

FROM AN ANTIQUE MARBLE GROUP OF CUPID & PSYCHE, IN THE CAPITOL.



THE GROUP OF CUPID & PSYCHE SEEN IN DIFFERENT VIEWS
STATUES.



Hercules of Dodona, from a small bronze.



Capitulum of Paucitulos, British Museum Co.



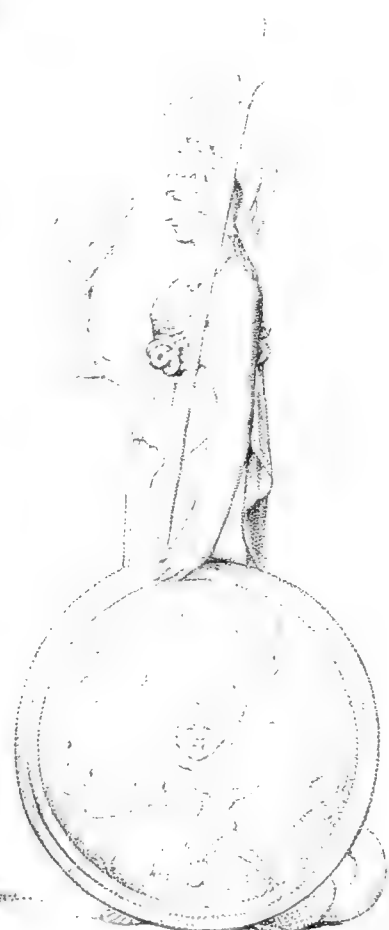
Minerva of Diprion & Scyllis in the Villa Albani



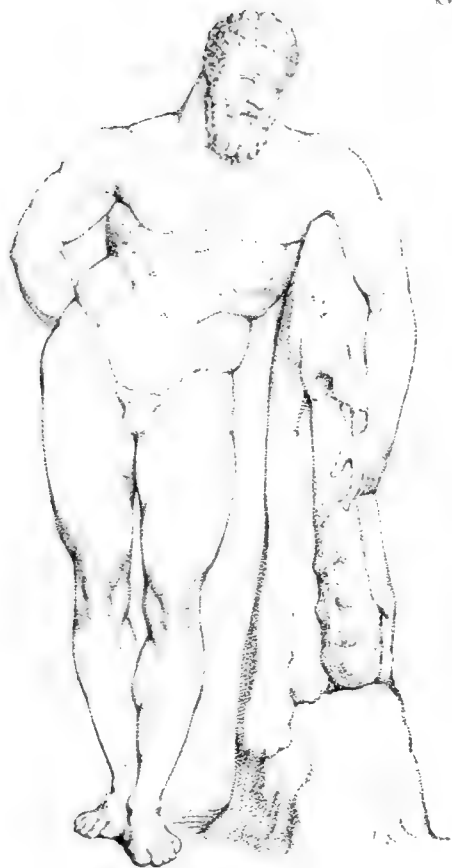
Venus of Praxiteles, Perriers Statues.



Jupiter Olympius. See Pausanias, Ancient Statues, Coins & Gems.



Minerva of the Acropolis in Athens. See Hunt's Coins.



Hercules Farnese



Phocion



Demetrius

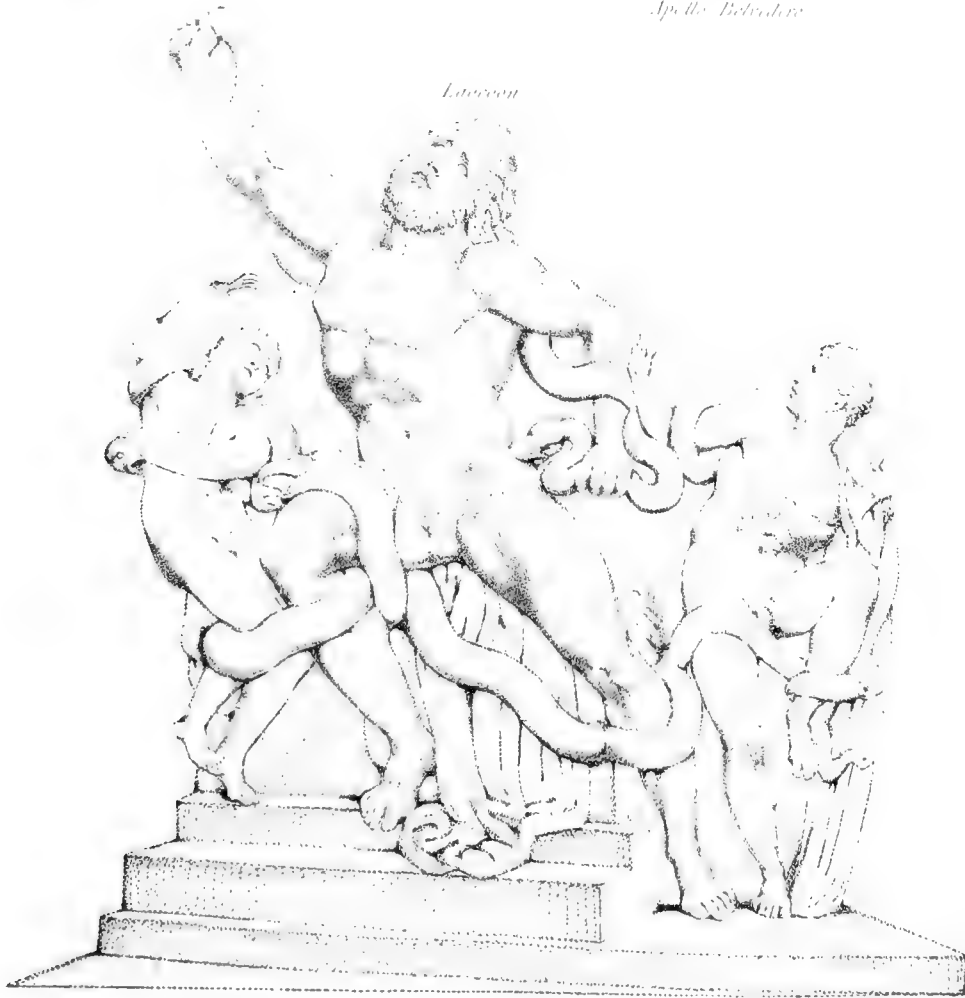




Venus de Medici



Apollo Belvedere



Laocöon



Durgā Slaying Mahishasura, a Hindu group.



An Etruscan Patera, in the British Museum



A Colossal Statue, at Thebes



Persian Sculpture, at Persepolis.



A Chinese Statue.



Persian Sculpture, at Persepolis.

Fig 5

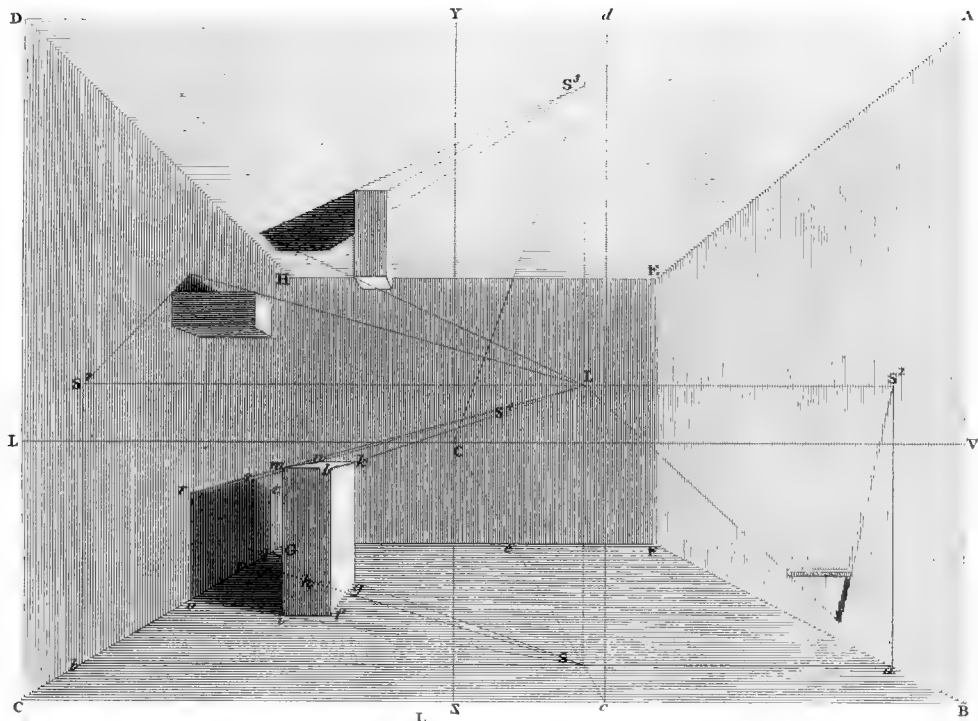


Fig 1.

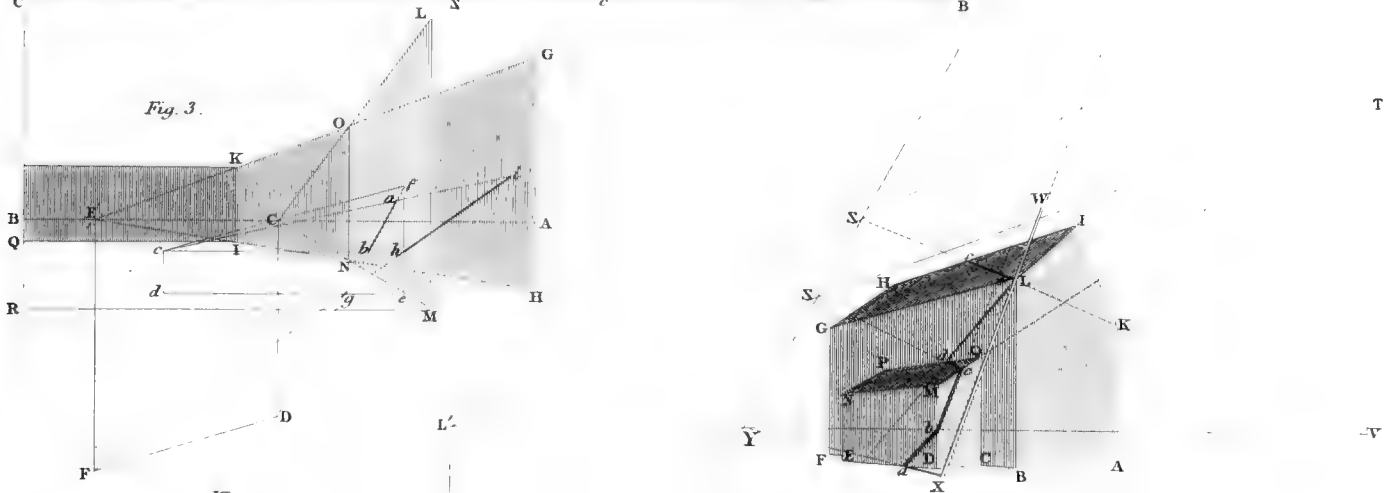


Fig 3.

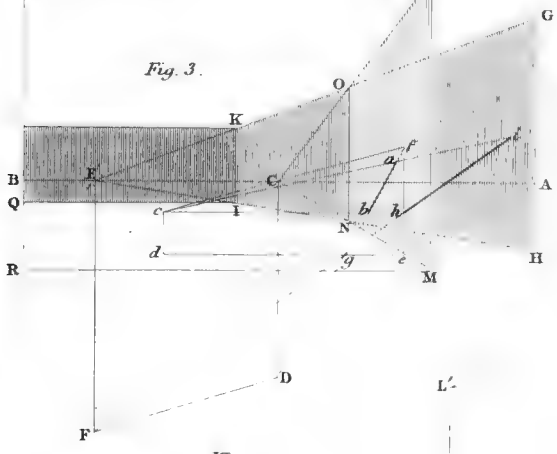


Fig 4.

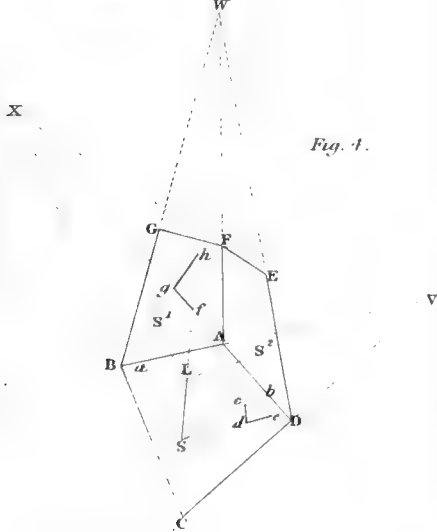
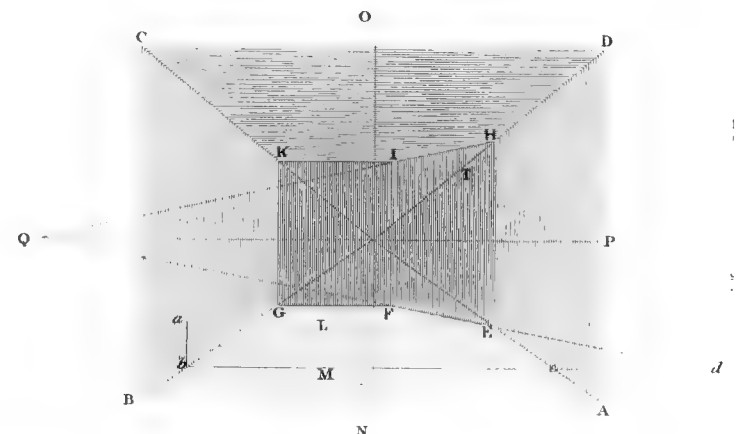
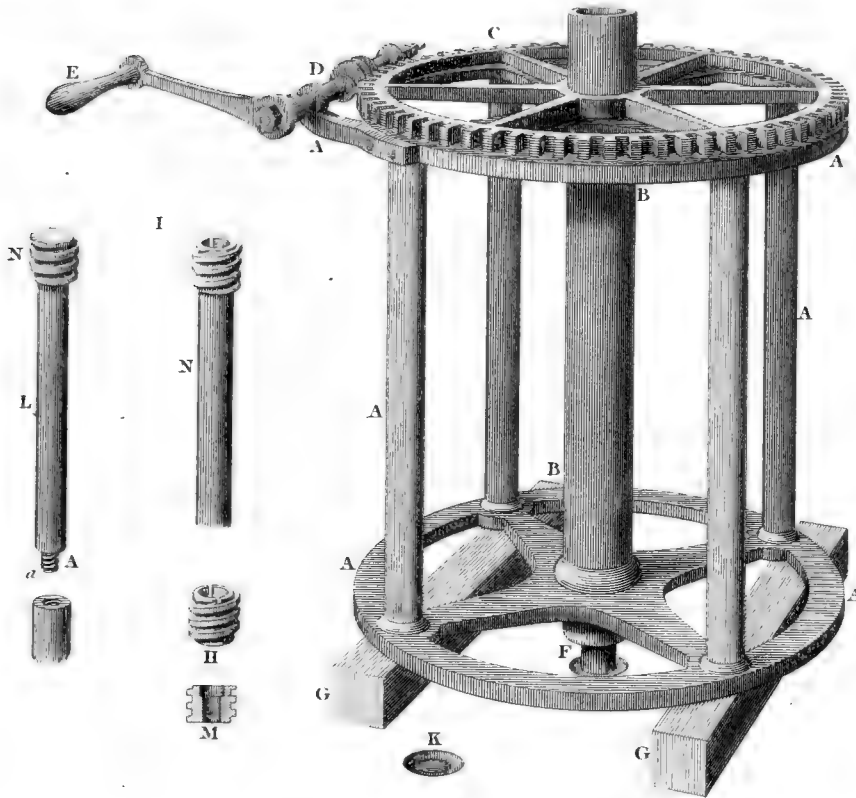


Fig 2.



Capt. Bolton's machine for drawing Bolts.

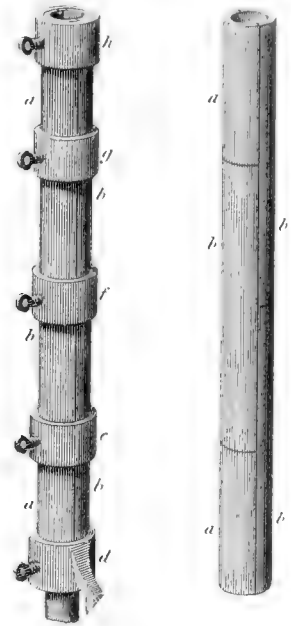
Fig. 1.



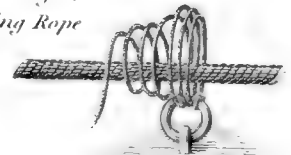
Phillips's tubes for driving bolts.

Fig. 3.

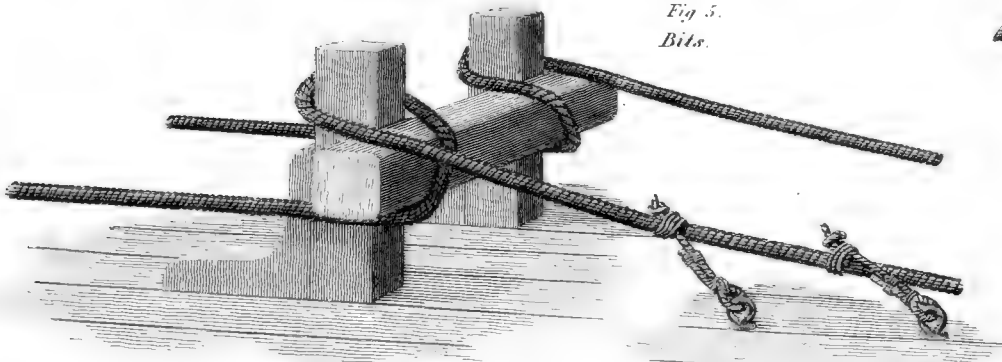
Fig. 2.



*Fig. 4.
Ring Rope*



*Fig. 5.
Bits.*



*Fig. 5.
Application of the Messenger.*



Fig. 7

Nippers.

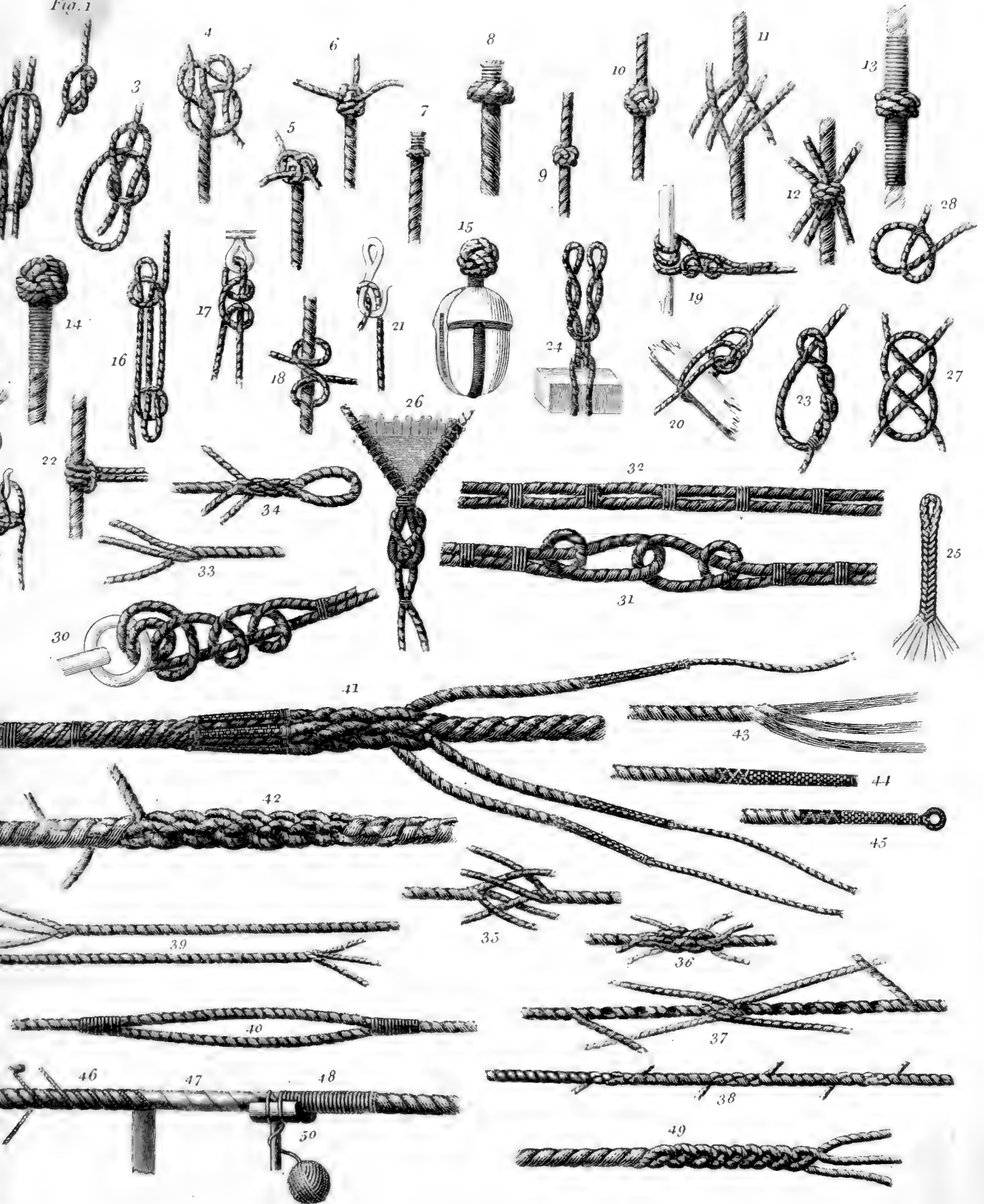
Fig. 6.





RIGGING.

Fig. 1



Del.

T. Milton scul.

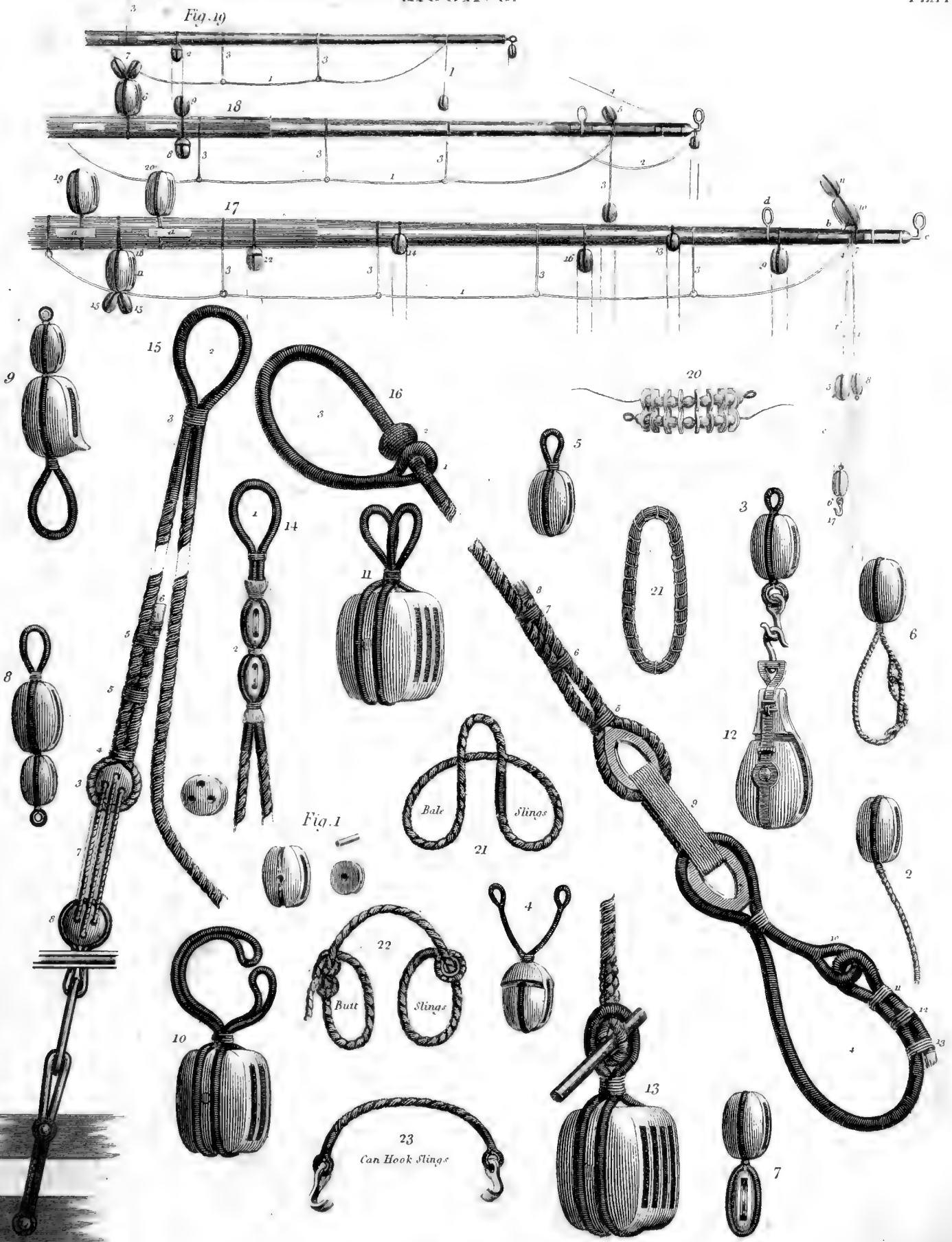


Fig. 1

Bale Slings

Butt Slings

Can Hook Slings



FIG 1.

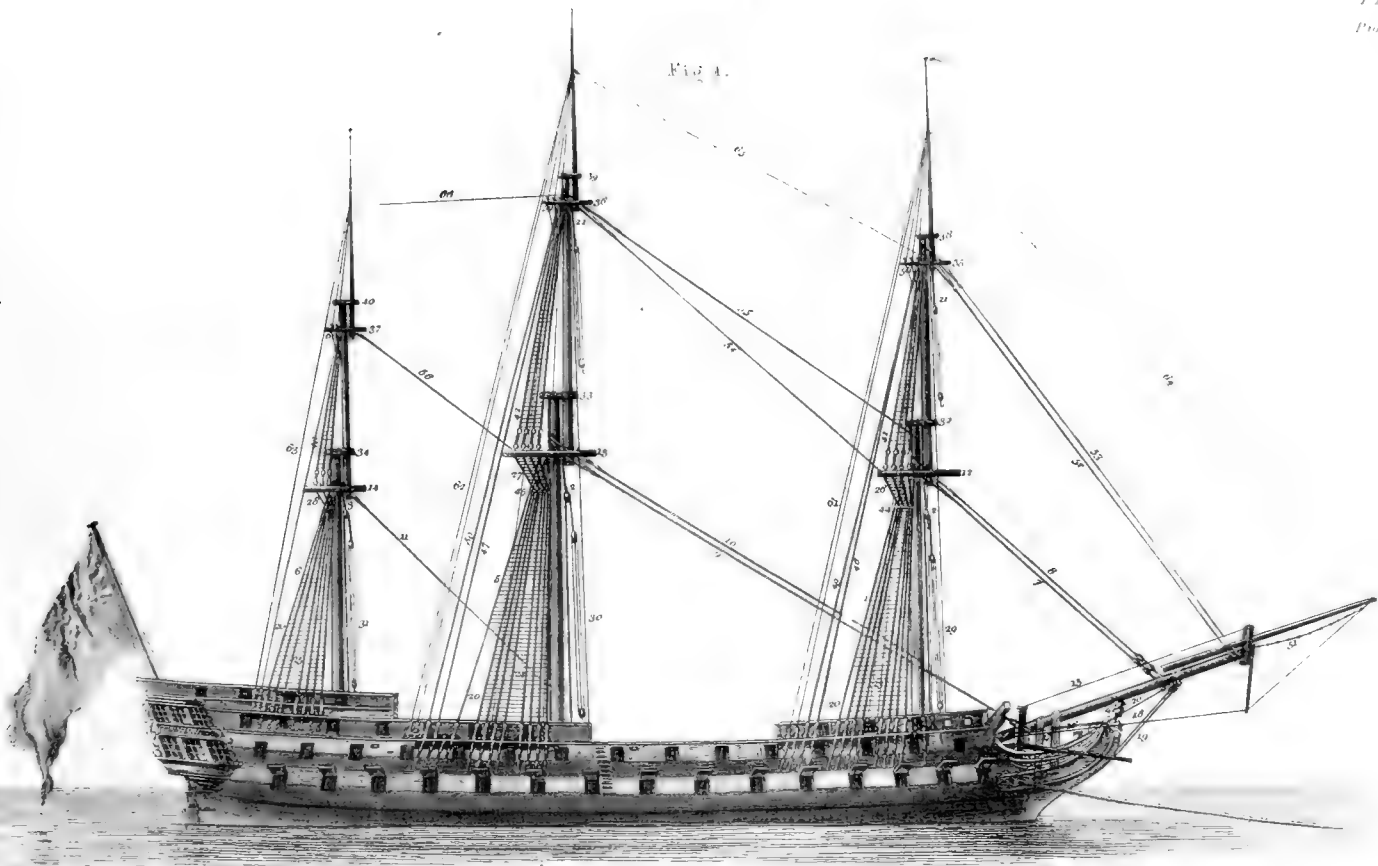
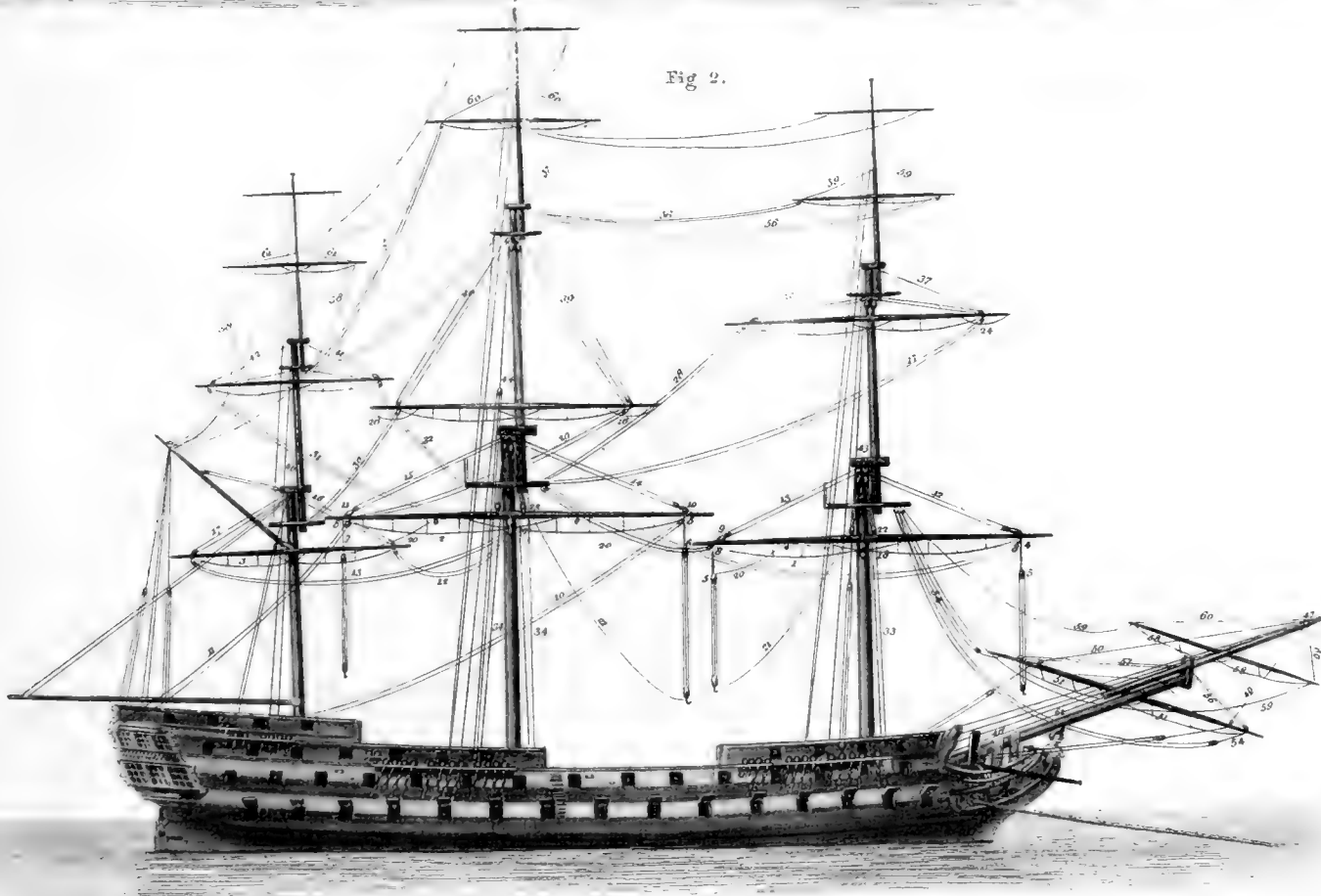


Fig 2.



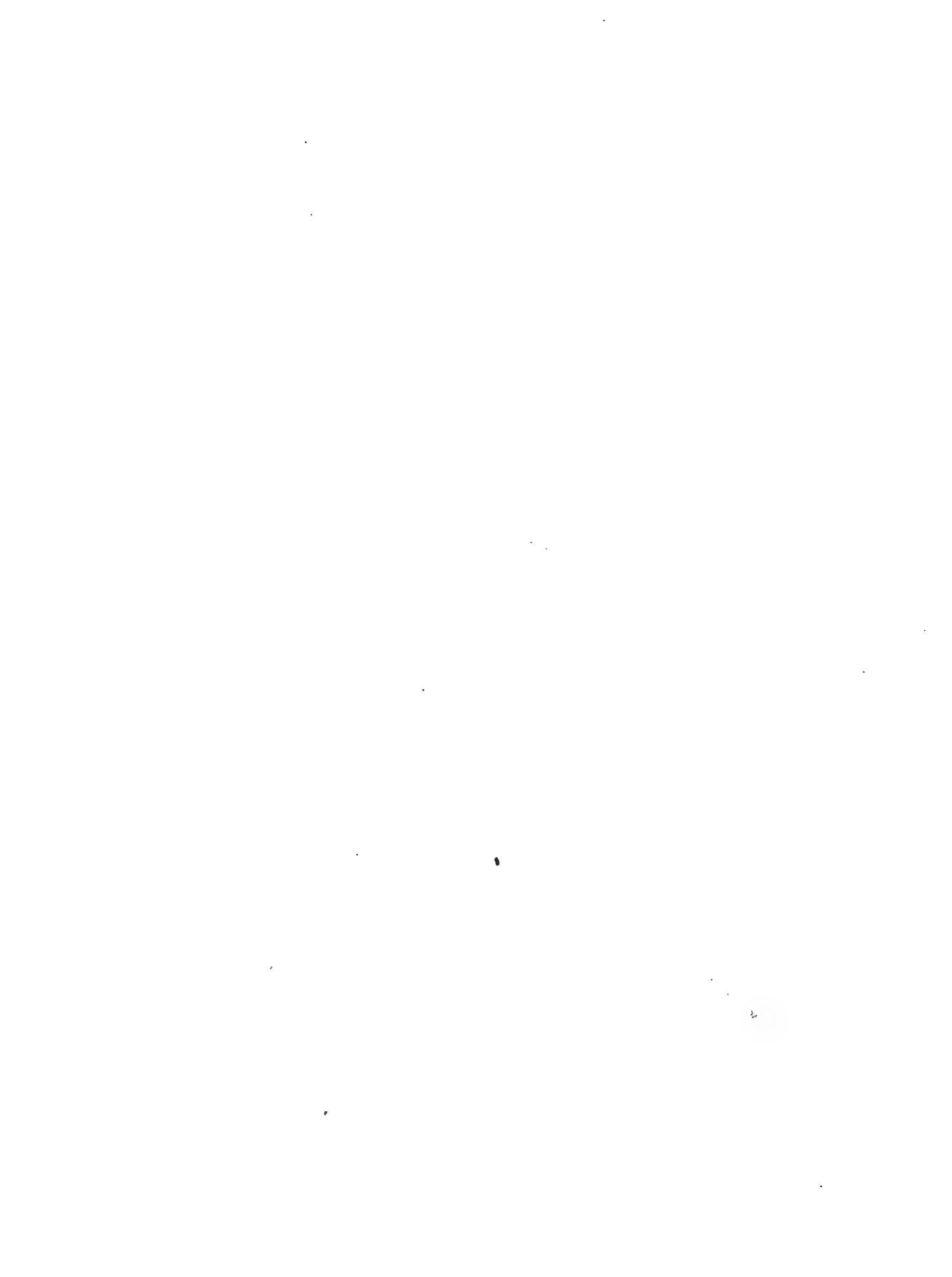


Fig 1

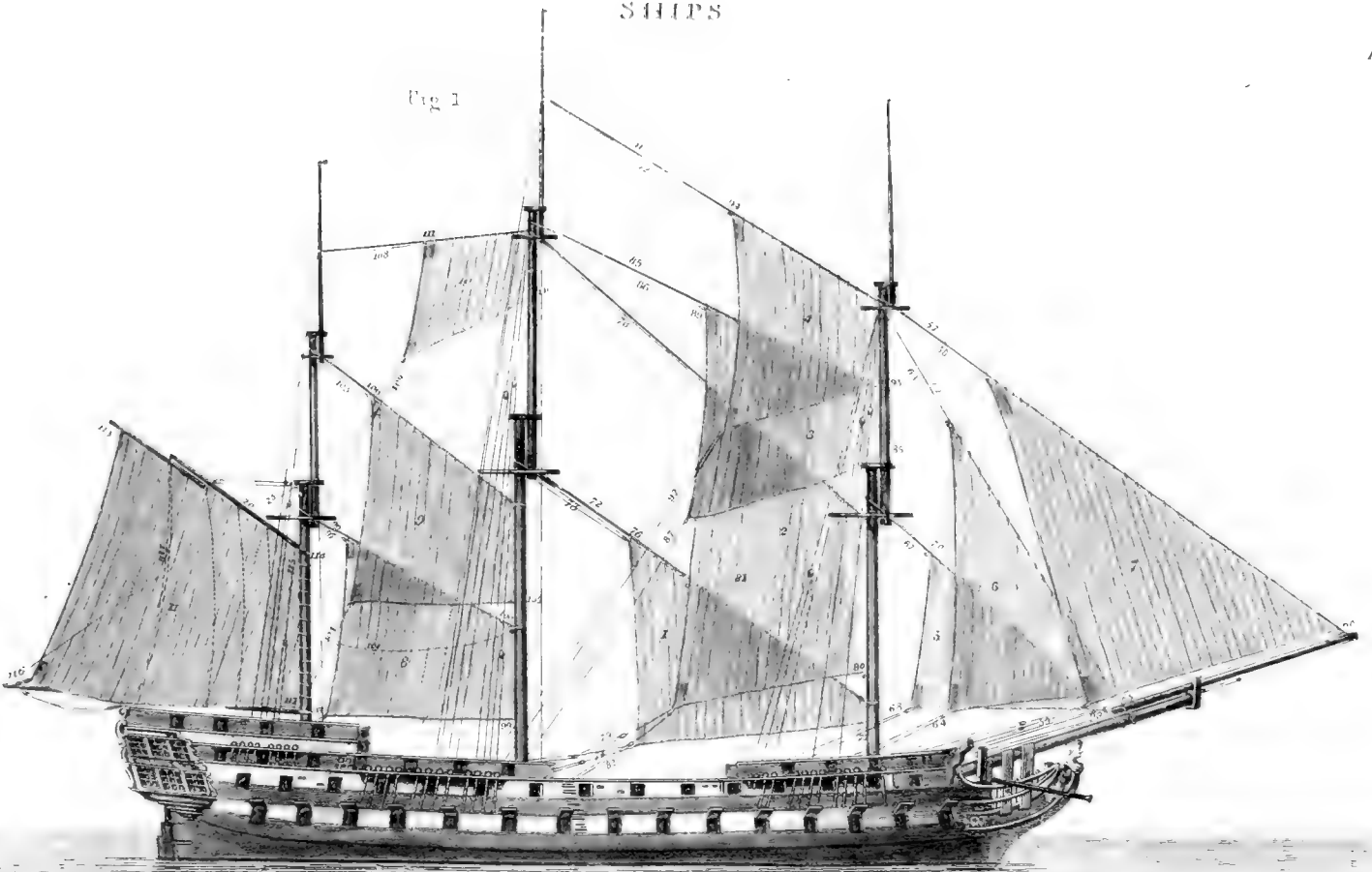
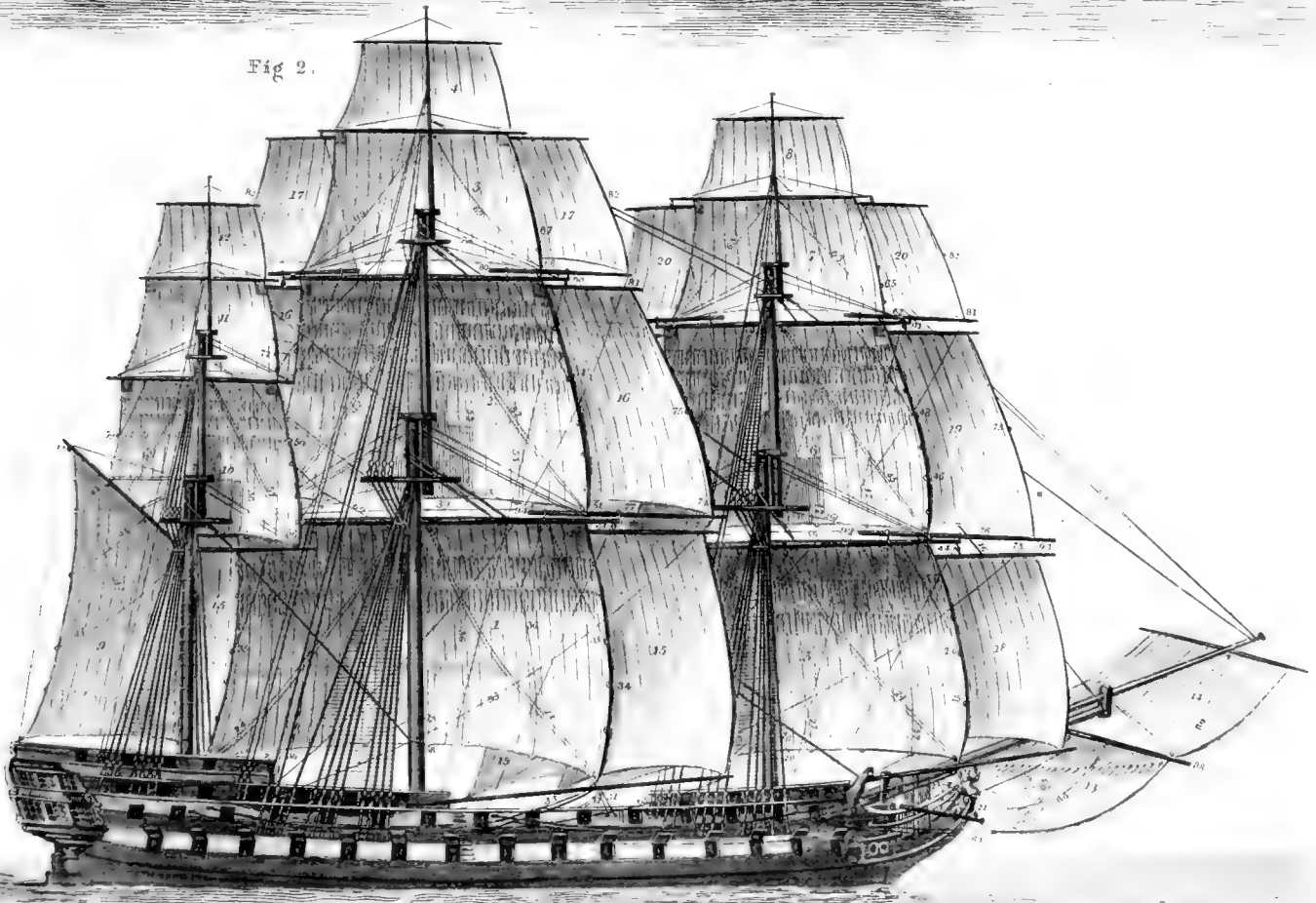


Fig 2.



British Men of War.

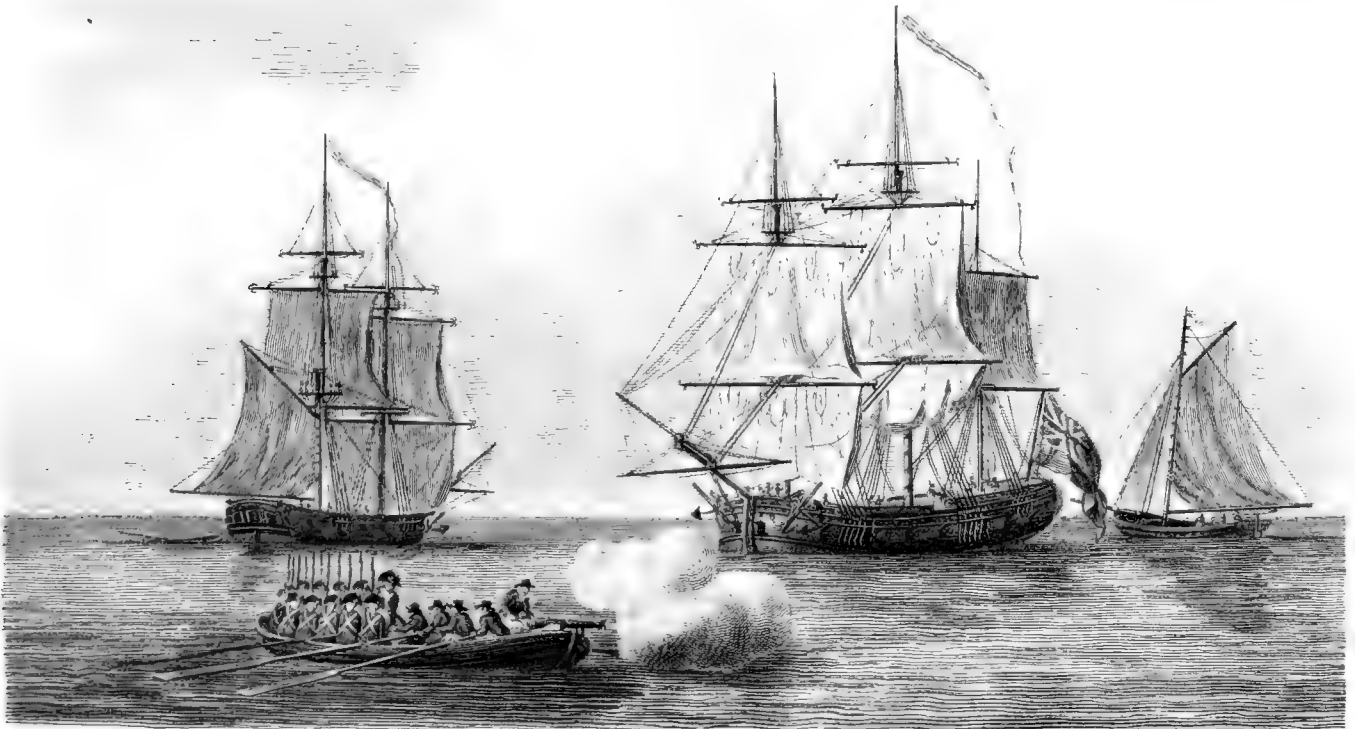


First Rate.

Man of War's Barge.

Seventy four.

Lugger.

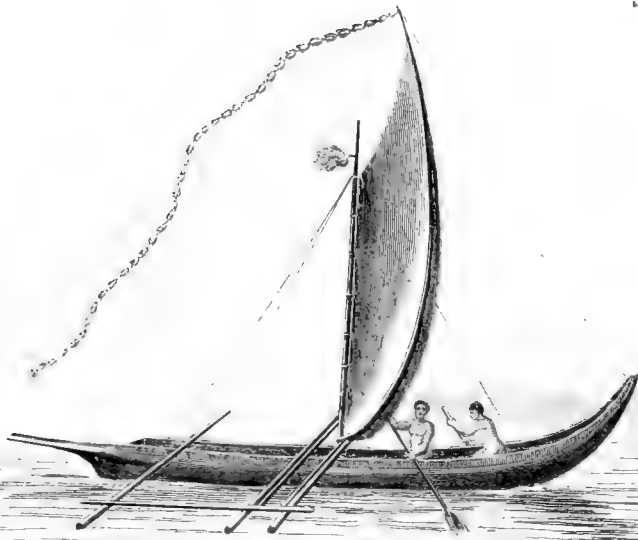


Fire Brig.

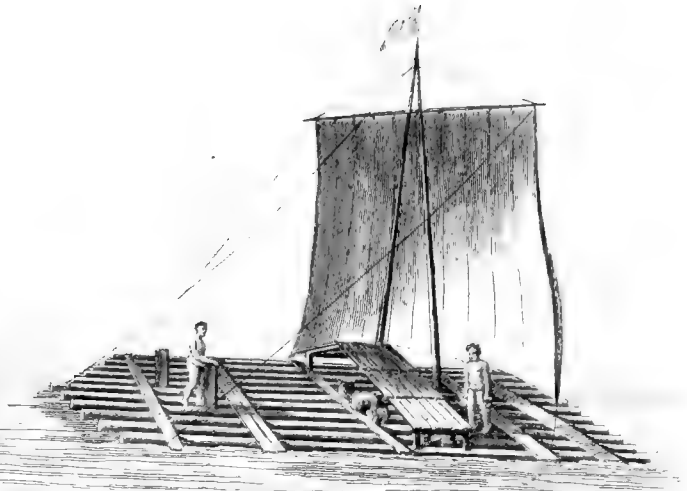
Flat Bottomed Boat.

Gun Vessel (*the Wolverine.*)

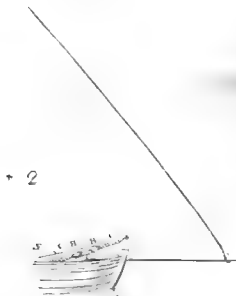
Man of War's Long Boat.



Pabie



Balza



Life Boat

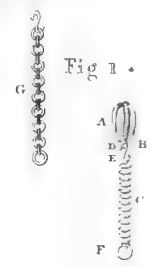
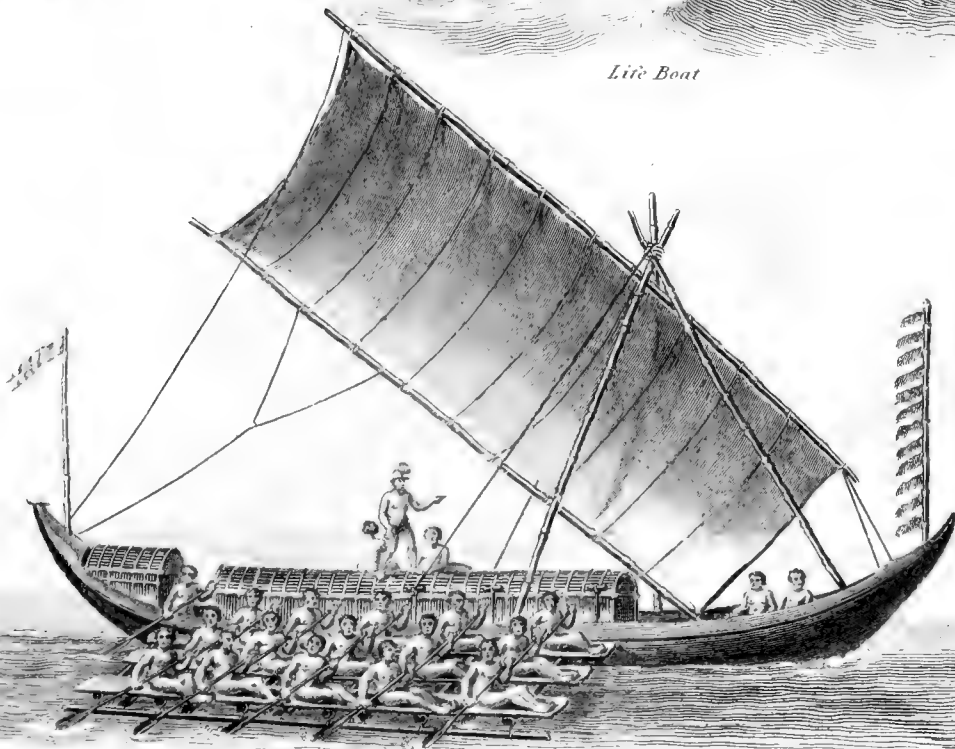
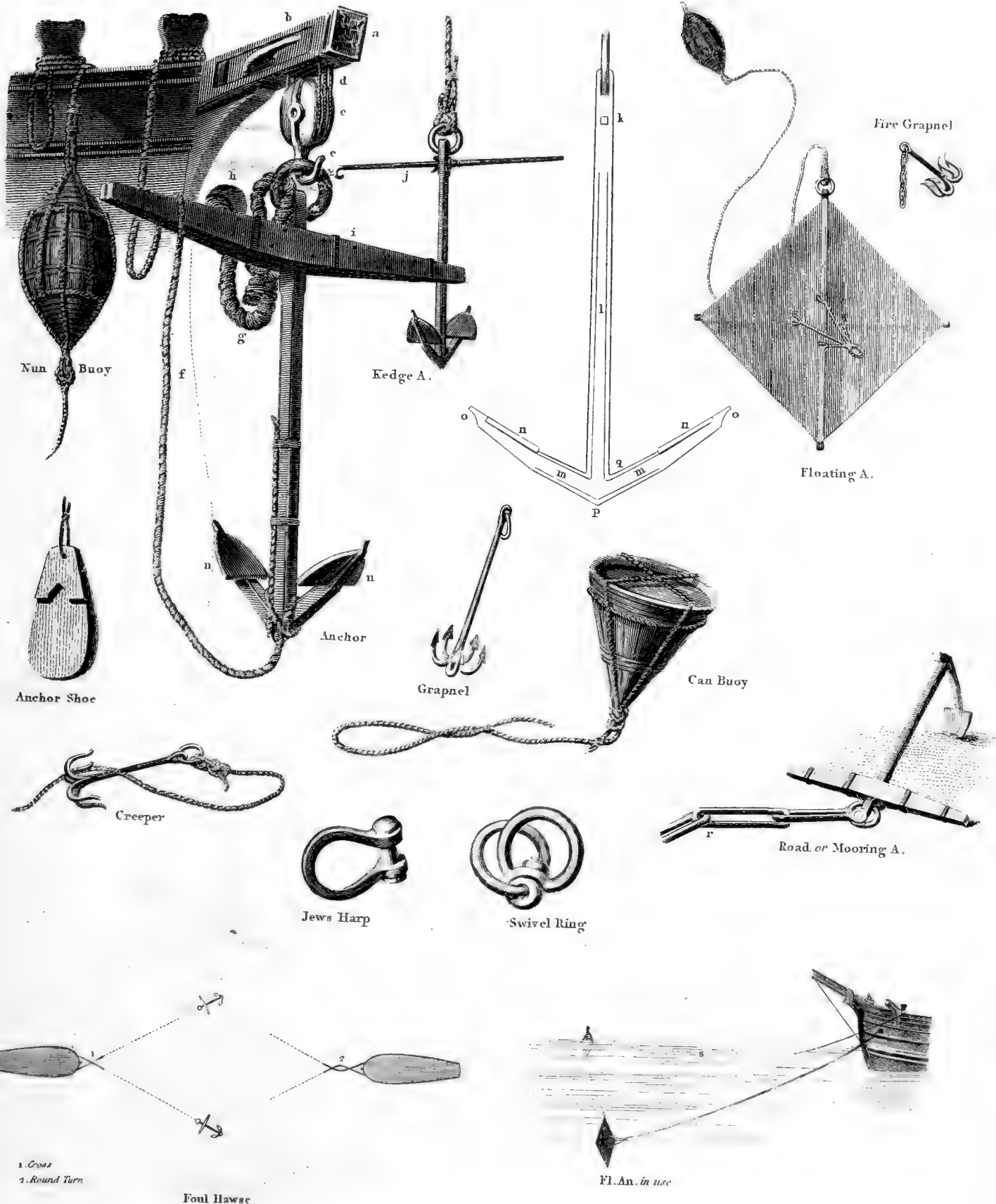


Fig 1.



Caracore

* Spring Block



a. Cat Head. b. Clout. c. Cat Block. d. Cat Fall. e. Cat Hook. f. Buoy Rope. g. Hawser. h. Hawse Hole. i. Stock. j. Shirling Stock (Iron). k. Nut for securing the Stock. l. Shank. m. Arms. n. Flukes. o. Bill. p. Crown. q. Throat. r. Mooring Chain. s. Buoy Guy.

SHORT HAND.

The Alphabet
Invented by John Byrom, M.A. and T. R. S.

LETTERS.	WORDS.	PREPOSITIONS.	TERMINATIONS.	Miscellaneous EXAMPLES.	
A	----	----	----	∩ Answer	
b))	Be-	-able	∩ Cypher	
c, e	—, e	----	----	∩ Departure	
d	(de-	-ed	∩ Entertained	
e	----	----	----	∩ Fail	
f	\	for-	{-ful	∩ Feet	
g	e	----	----	∩ Forward	
h	9 d	----	----	∩ Library	
i	----	----	----	∩ Matrimony	
k	e	{com- con-	-ical	e Nations	
l	6 p r	----	----	∩ Numeration	
m)	{magni- mis- omni-	-ment	∩ Overcome	
n)	{ante- or anti- in- or inter- in- or under-	{-ence -ent -ness	∩ Perplex	
o	----	----	----	∩ Revengeful	
p)	per- pre- or pro-	----	∩ Short-hand	
q	9	----	----	∩ Square	
r	/	re-	-ary 'ing	∩ Substance	
s	—	{satis- circum- sub- or super-	{-ation -ition -ition -ution	{-self -soever	
t		trans-	-ity	Common CONTRACTIONS.	
u	----	----	----	Dr. ∩ Doctor	
v	\	----	----	Etc. † Et cœtera	
w	p d	with-	-ward	Mr. ∩ Master	
x	✓ 9	ex-; extra-	----	Mrs. ∩ Mistress	
y	9	----	----	MS. ∩ Manuscript	
z	—	----	----	NB. ∩ Nota Bene	
ch	9	----	----	P.S. ∩ Postscript	
sh	e 6	----	-ship	Rev. ∩ Reverend	
th	()	----	----	Viz. ∩ Videlicet	

Vowels' Places.

a, b, c, &c.
 m, n, o, &c.
 u, v, w, &c.
 x, y, z, &c.

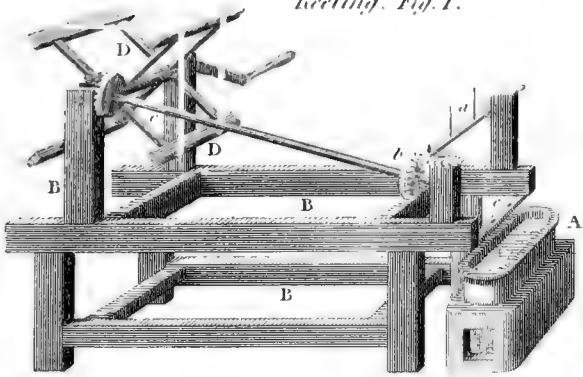
a, m, e, m, &c.
 m, a, m, e, &c.
 a, n, e, n, &c.
 n, a, n, e, &c.

Figures.

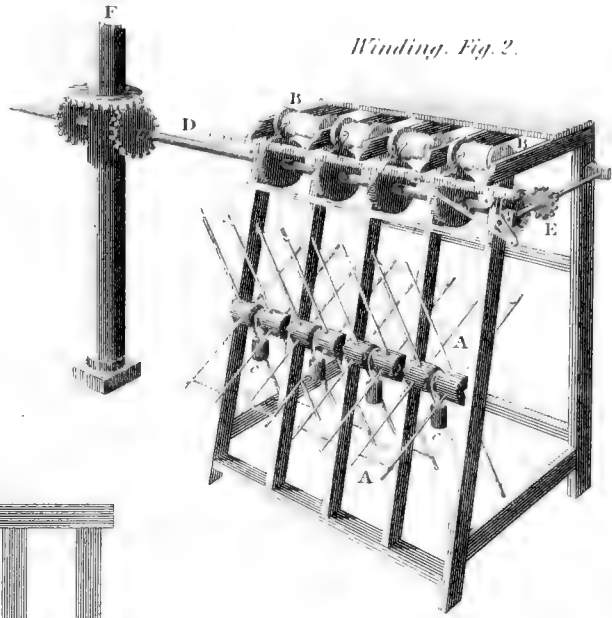
1 2 3 4 5 6 7 8 9 0
 ∩ | / \) — (() /

SILK MANUFACTURE

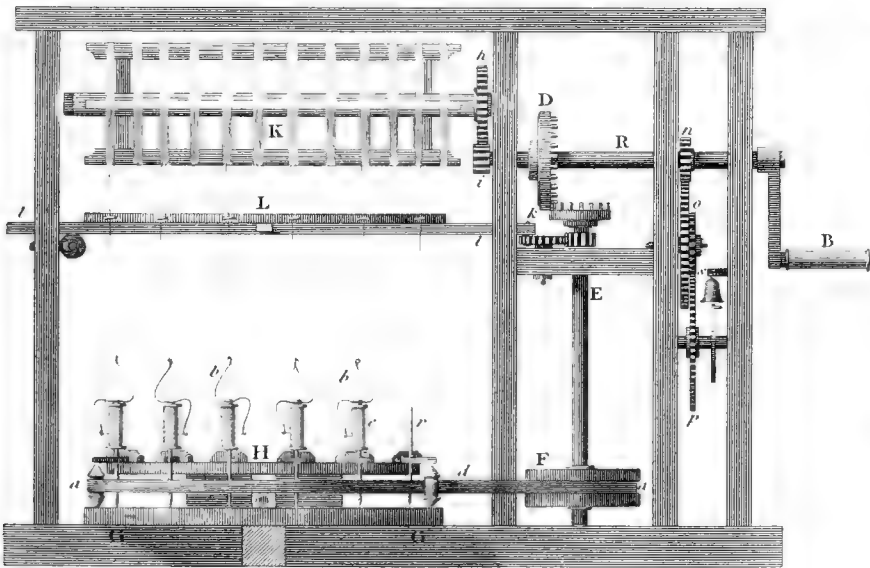
Reeling. Fig. 1.



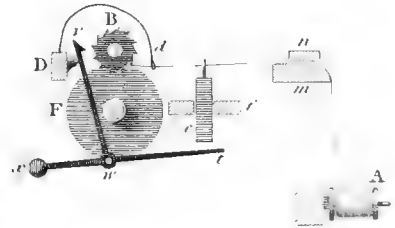
Winding. Fig. 2.



Throwing. Fig. 3.



Doubling. Fig. 4.



Warping. Fig. 6.

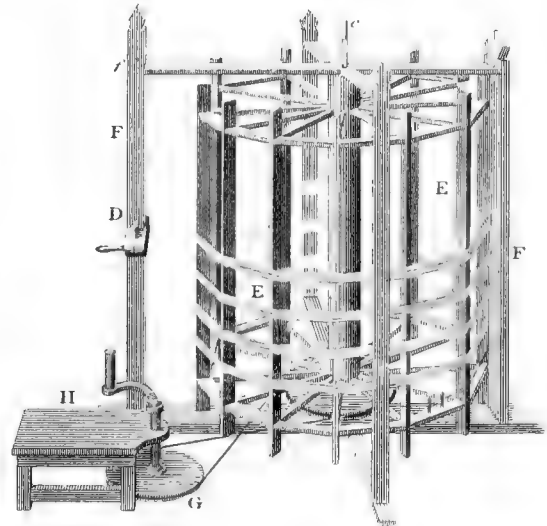
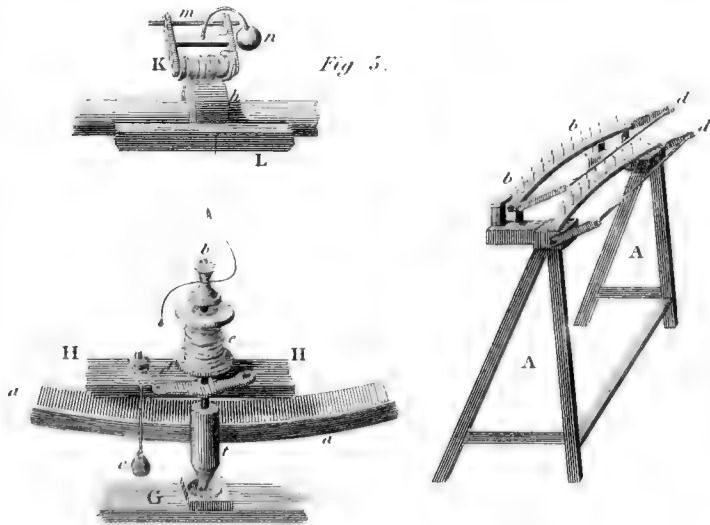
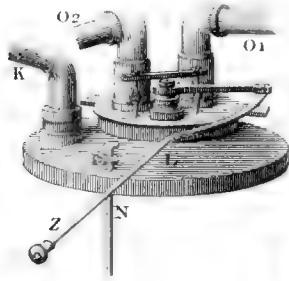
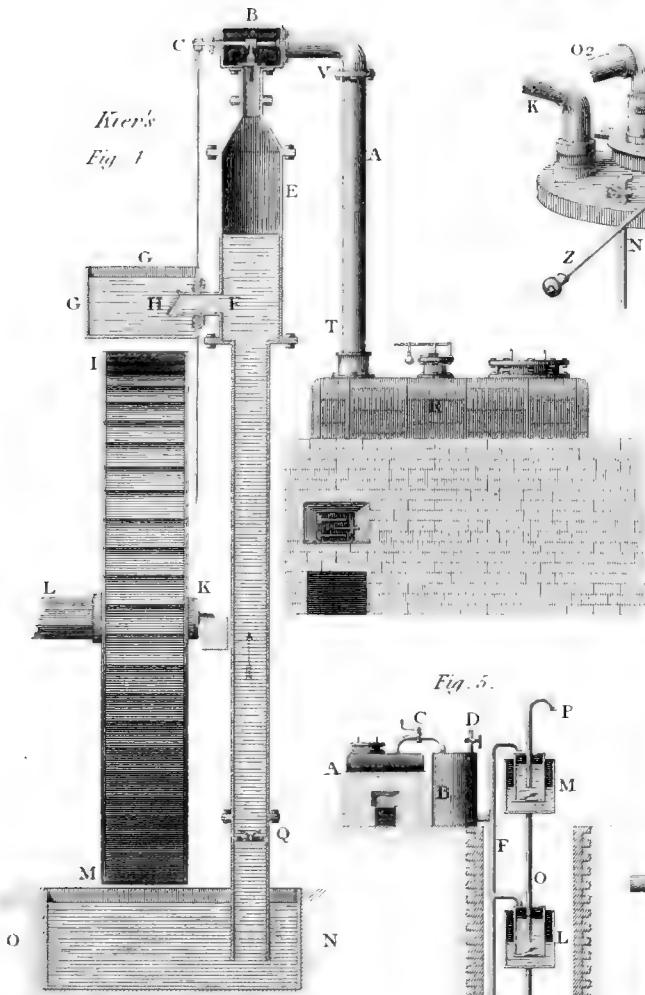


Fig. 5.





New's
Fig. 1.



Savery's
Steam Engine.
Fig. 1.

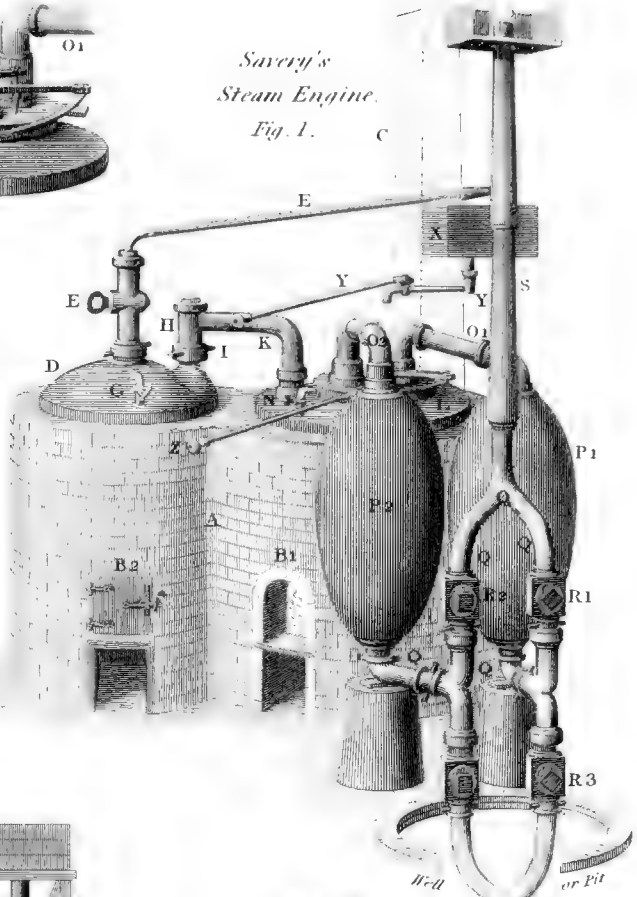


Fig. 5.

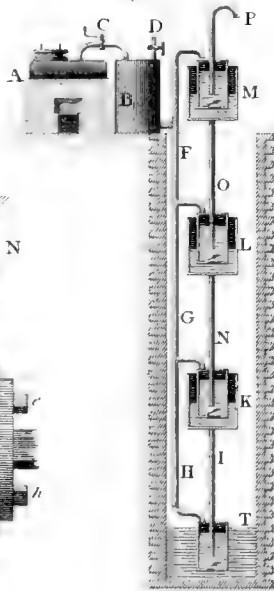
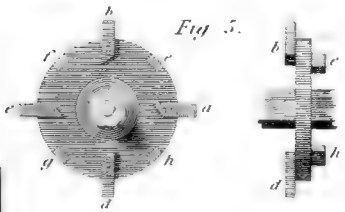
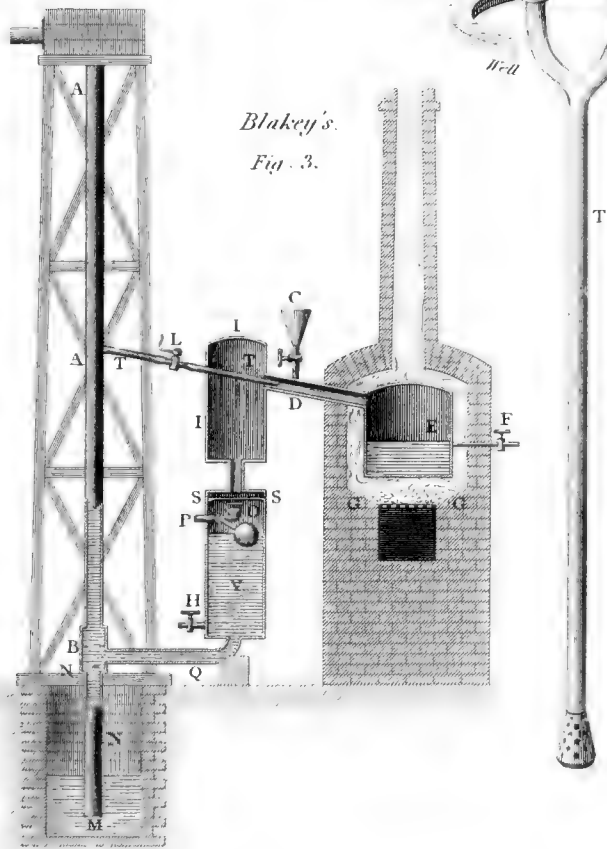


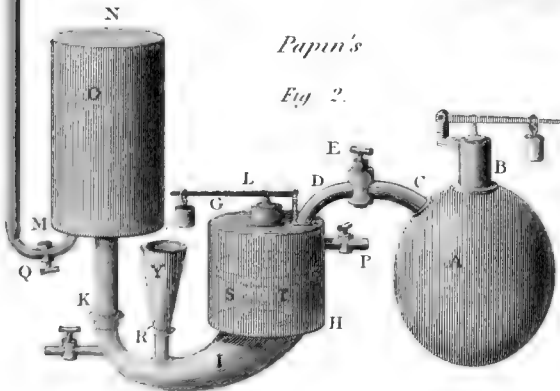
Fig. 5.



Blakey's
Fig. 3.

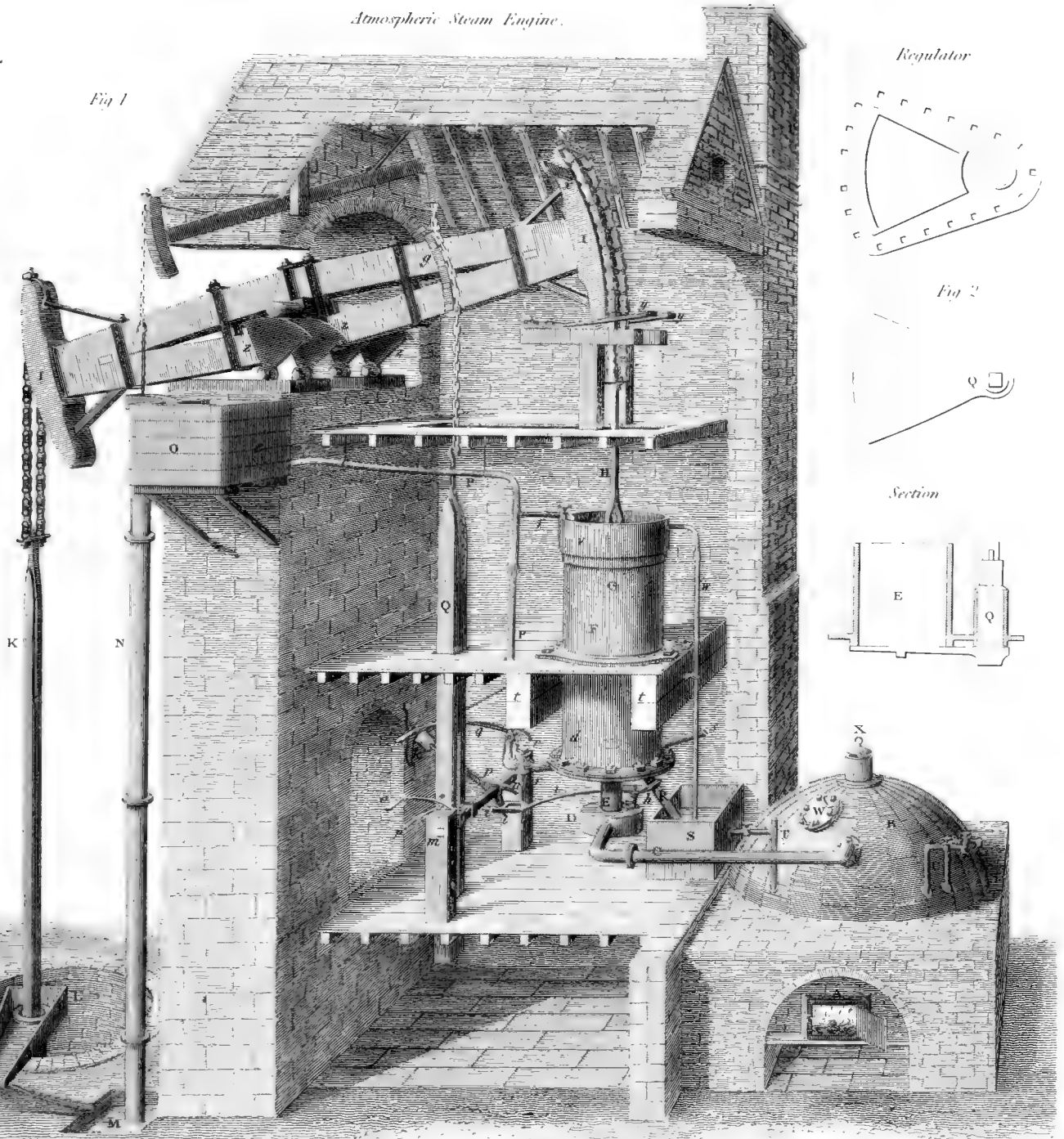


Papin's
Fig. 2.



Atmospheric Steam Engine.

Fig 1



Regulator

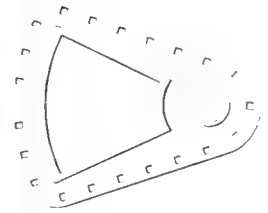
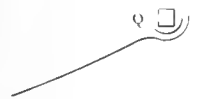
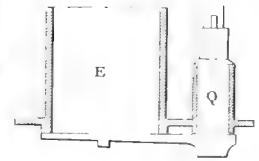


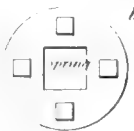
Fig 2



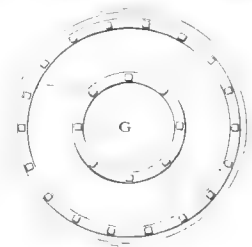
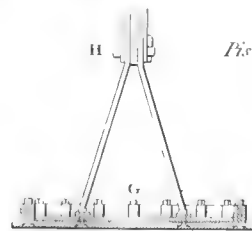
Section



*Injection Cap.
by M. Smeaton*

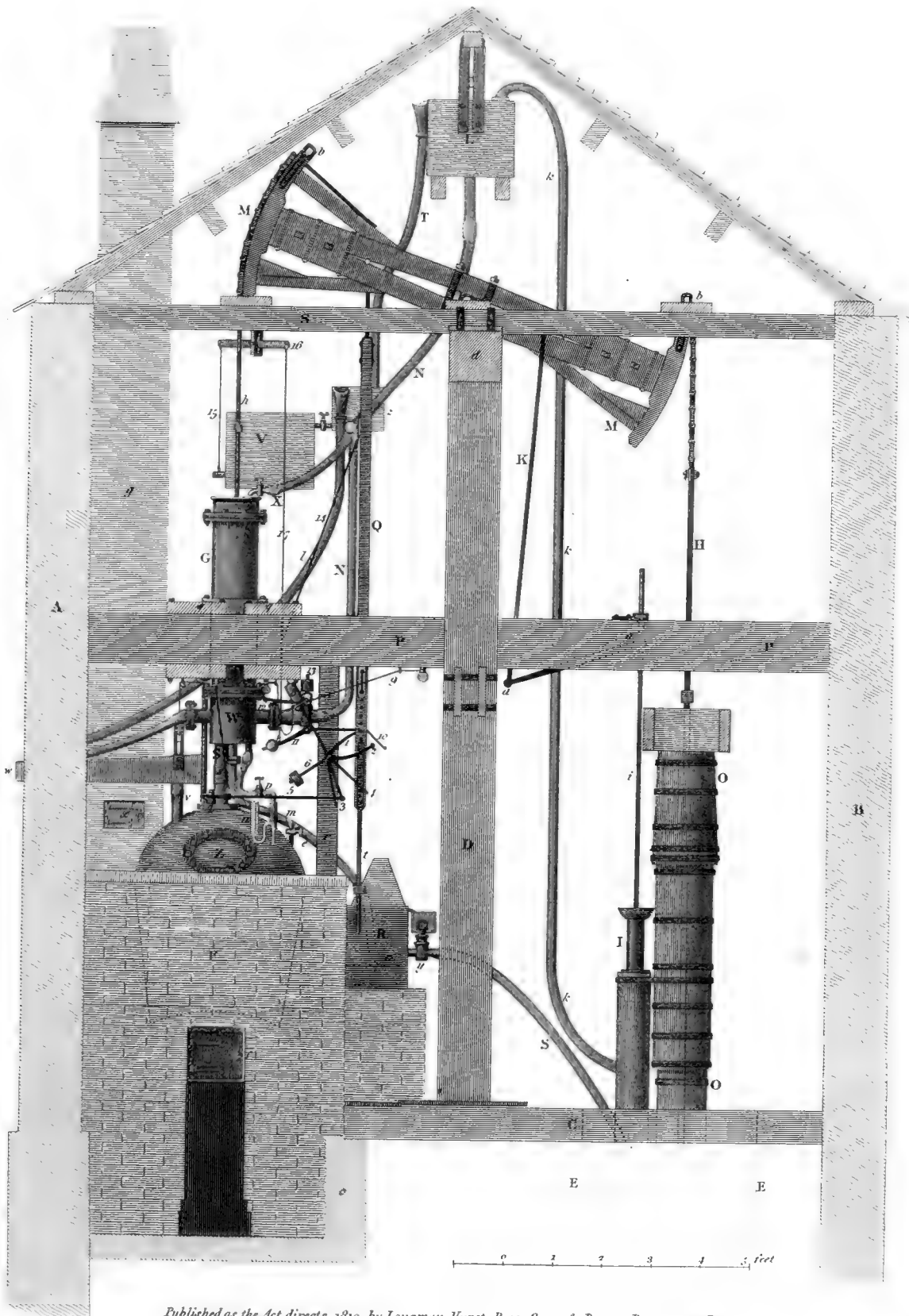


Piston



STEAM ENGINE.

On the principle of NEWCOMEN, as constructed by SMEATON.



STEAM ENGINE.
MR WATT'S ENGINE.

Fig. 1.
Single acting ENGINE
for pumping at
CHELSEA WATER-WORKS.

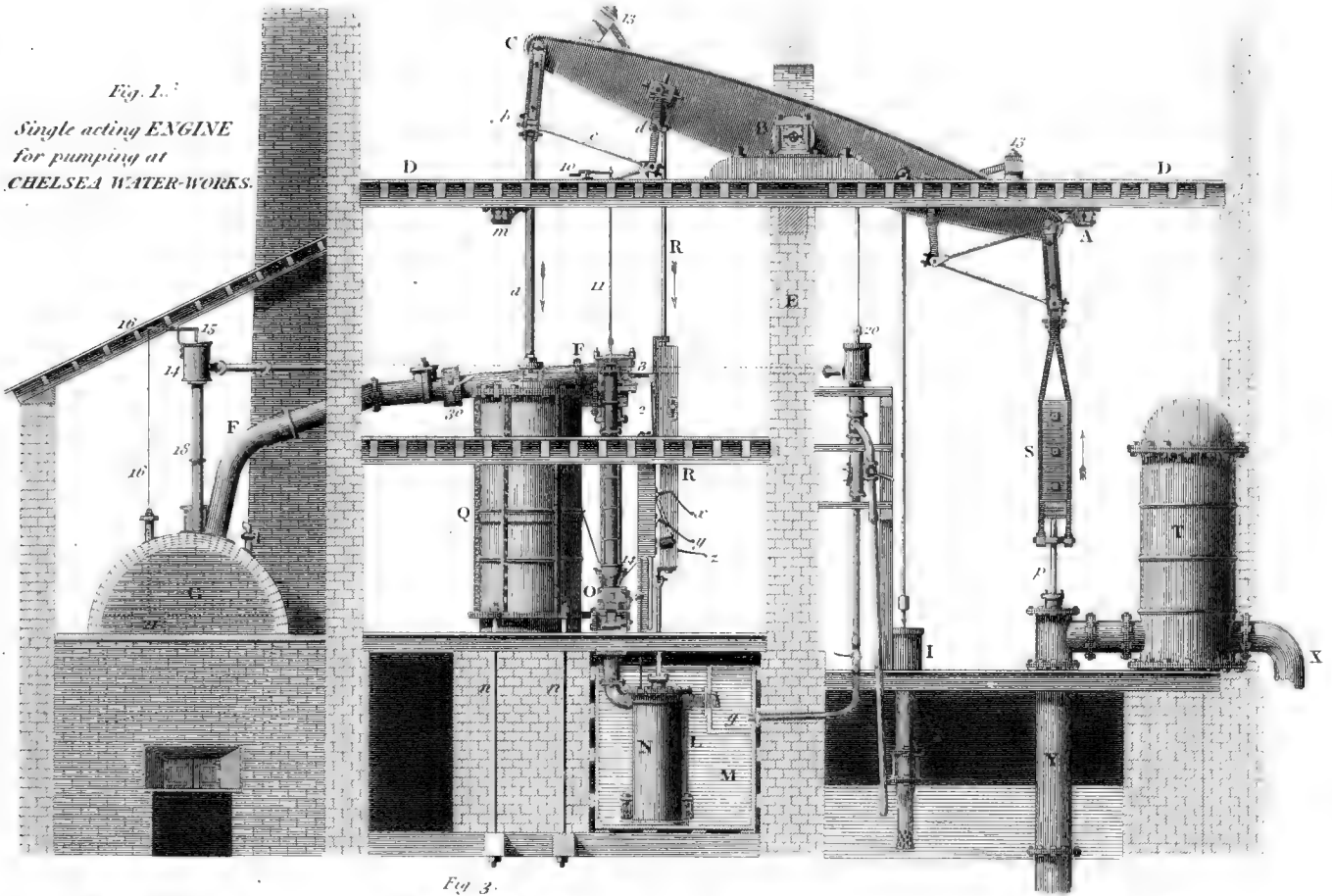


Fig. 2.

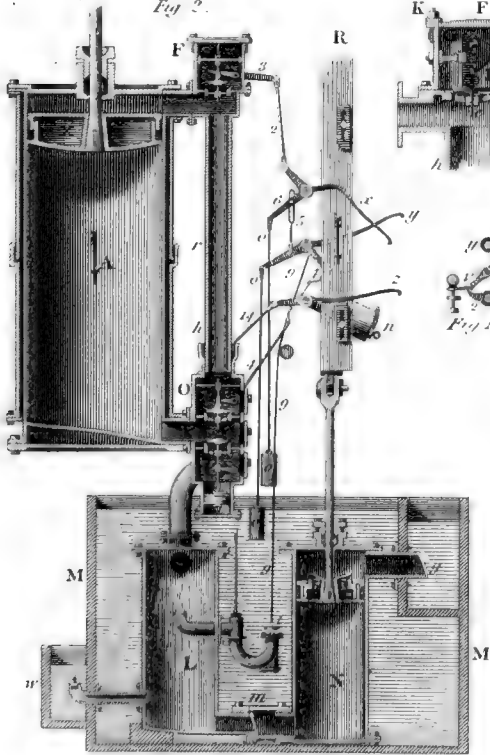


Fig. 3.

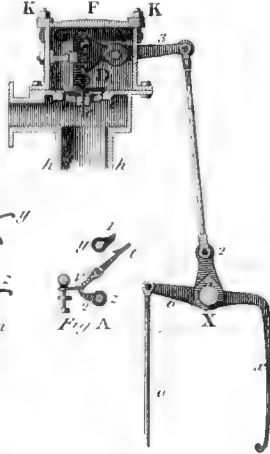


Fig. 4.

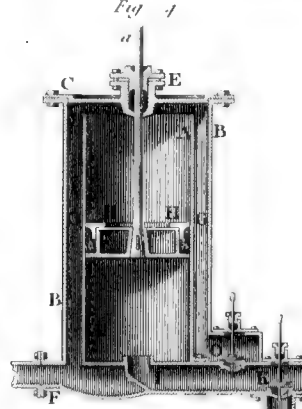


Fig. 5.

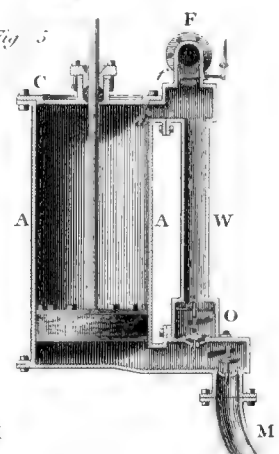


Fig. 6.

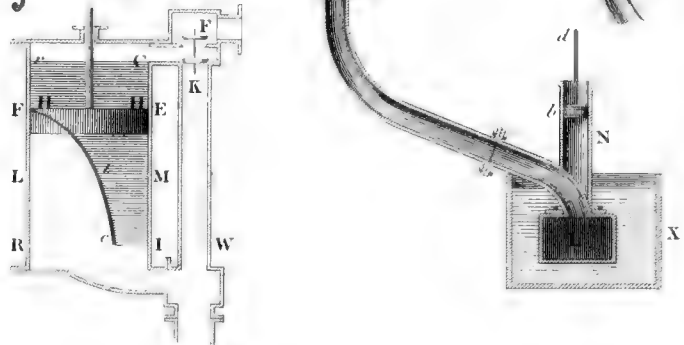




Fig. 6.

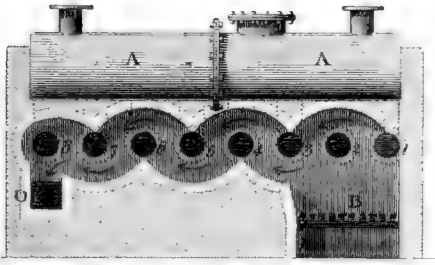


Fig. 4.

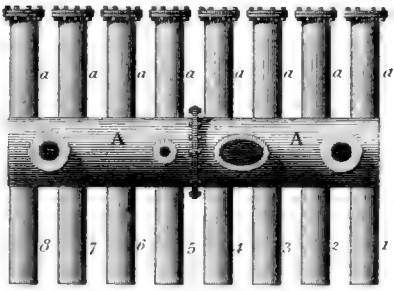
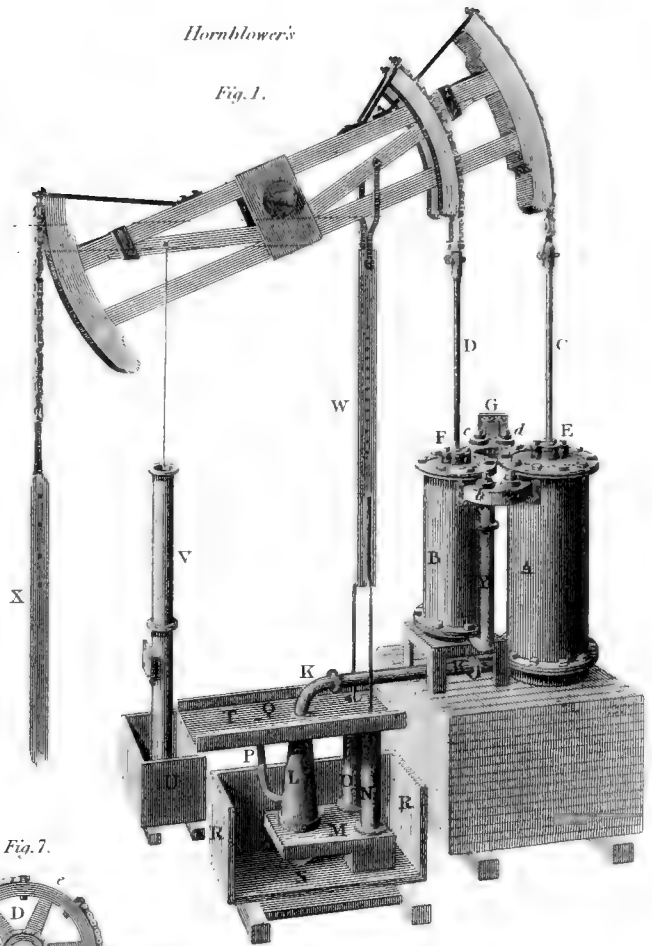


Fig. 2.



Hornblower's

Fig. 1.



Cartwright's

Fig. 8.

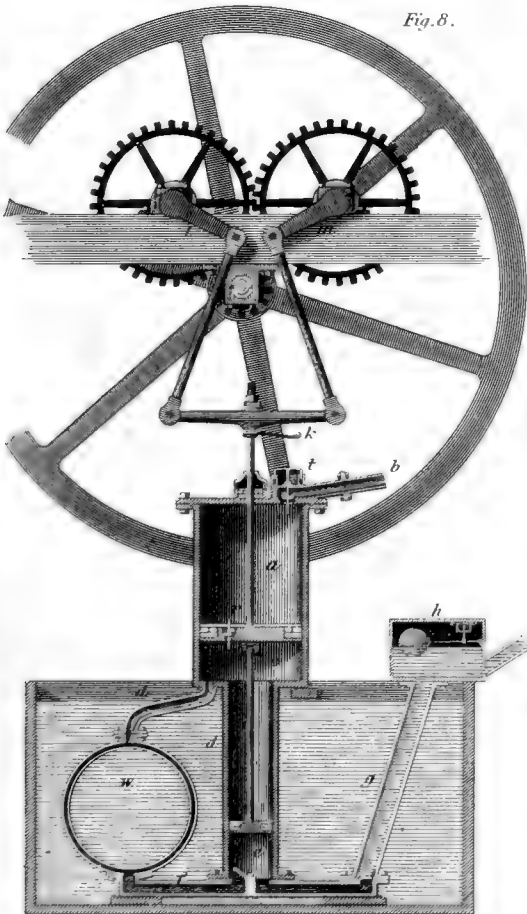


Fig. 7.

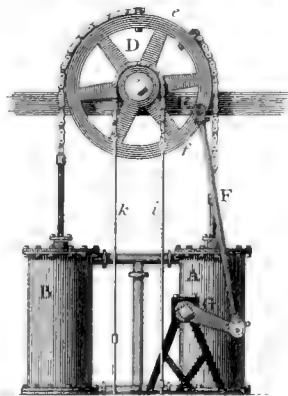
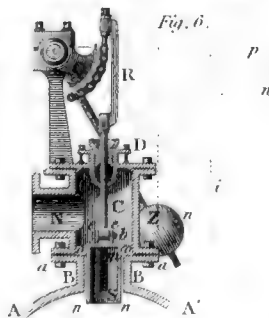
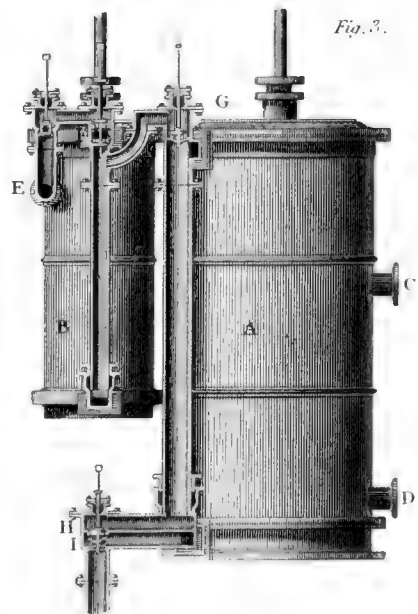


Fig. 6.



Woolf's

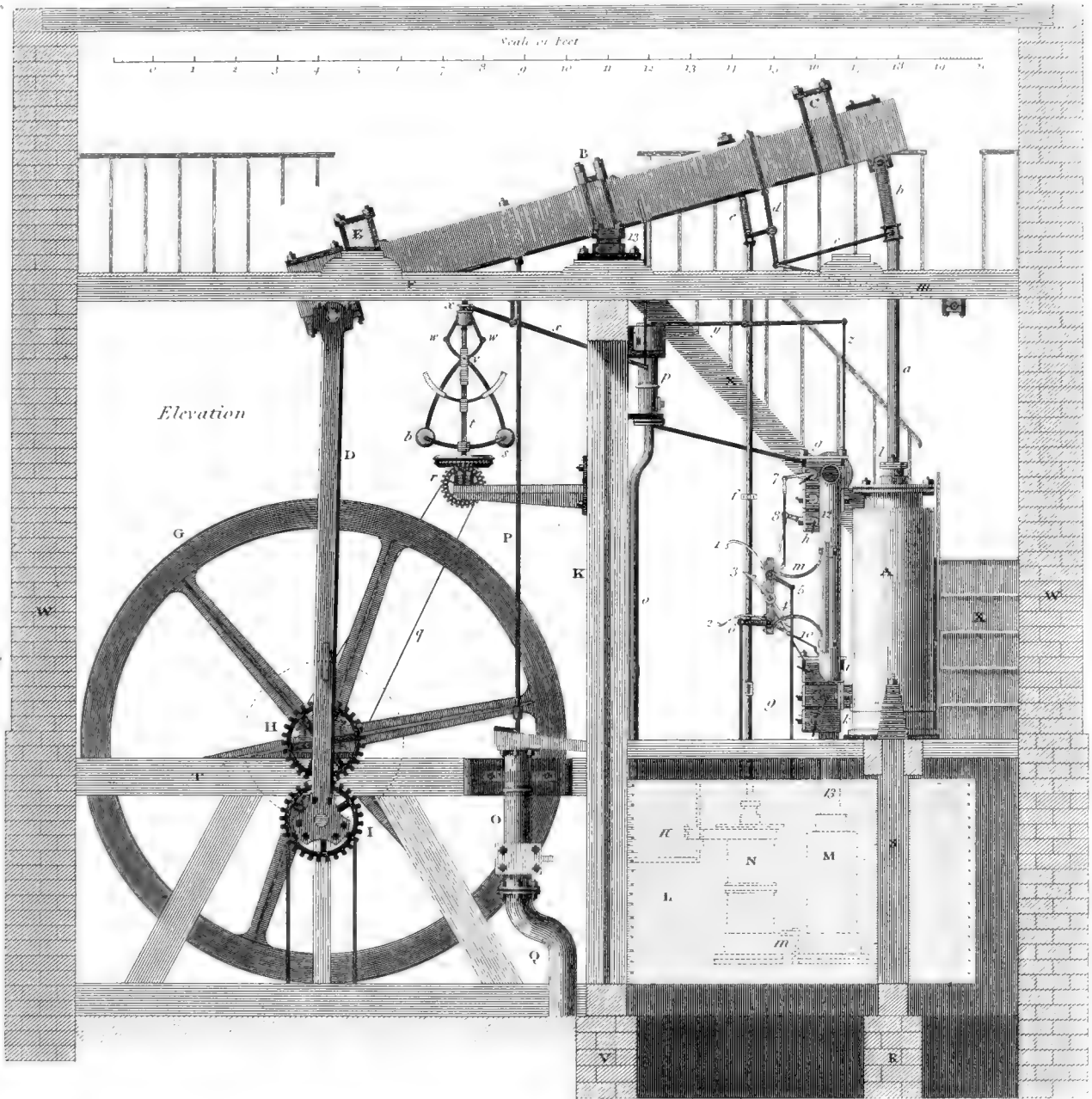
Fig. 3.





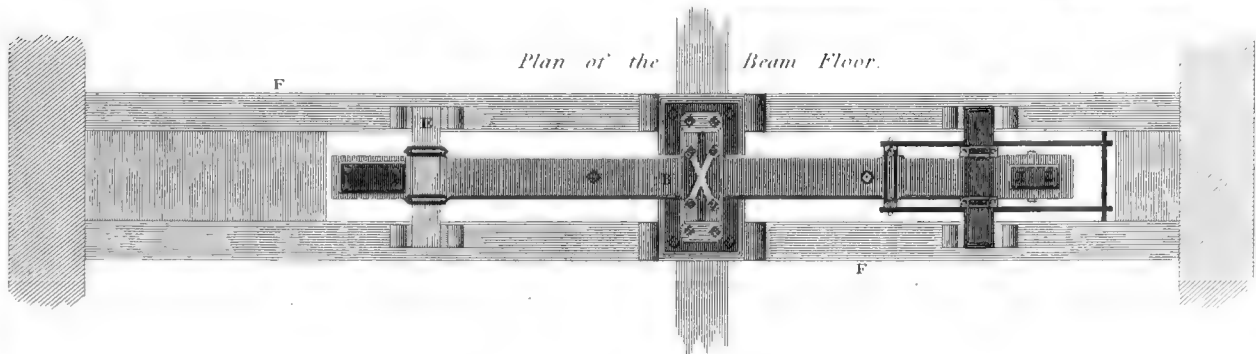
STEAM ENGINE.

Boulton and Watt's Engine on the original Construction.



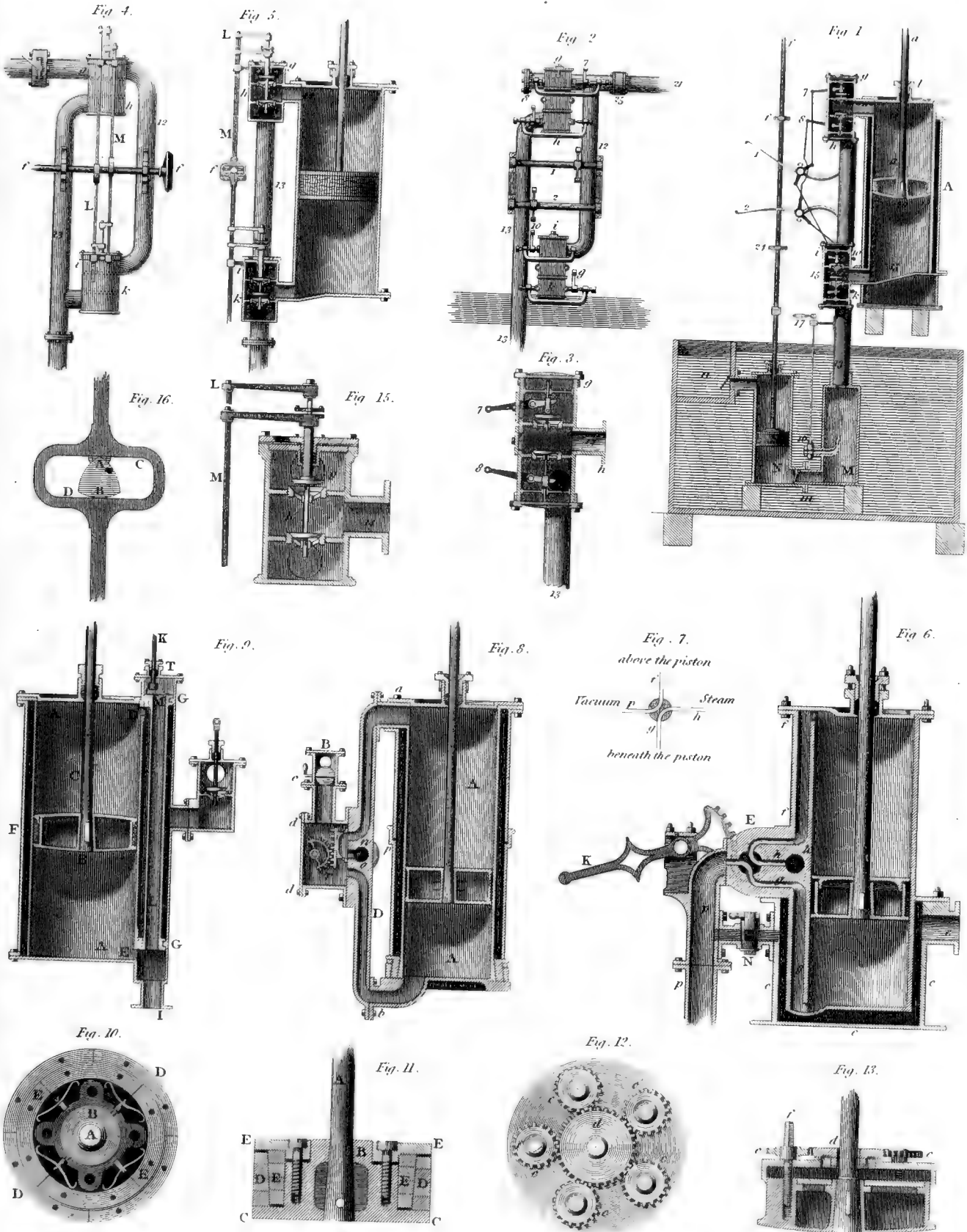
Elevation

Plan of the Beam Floor.



STEAM ENGINE, CYLINDERS, PISTONS &c.

PLATE VII.



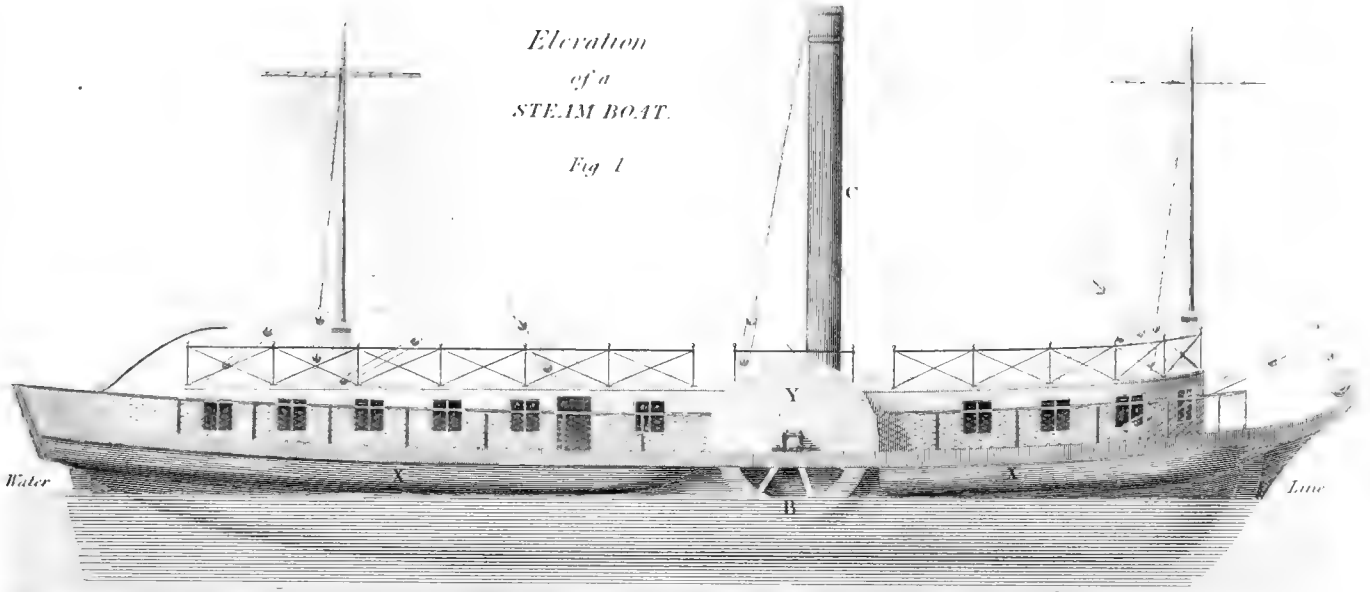
J. Earey delin.

Published as the Act directs, 1868, by Longman, Hurst, Rees, Orme & Brown, Paternoster Row.

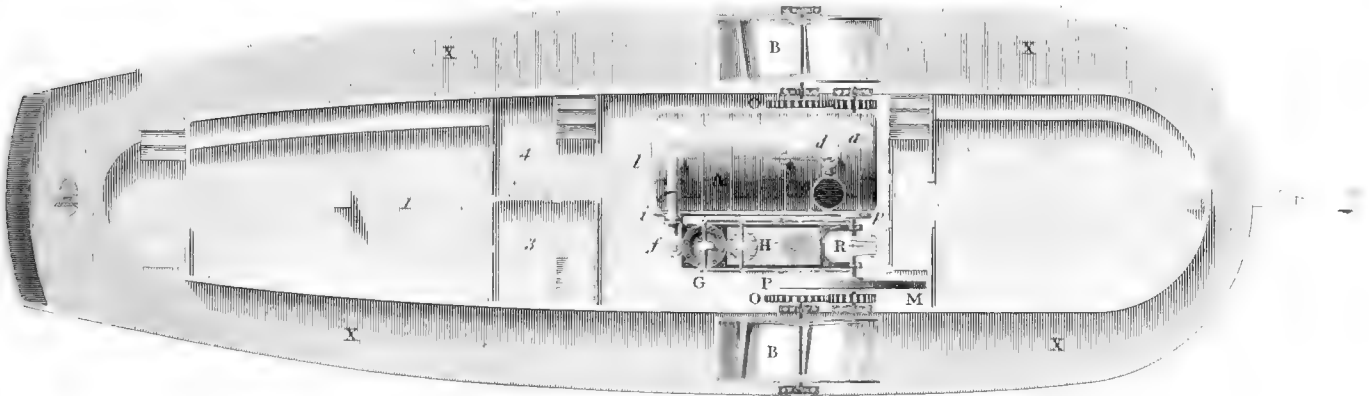
Lowry sc.

*Elevation
of a
STEAM BOAT.*

Fig. 1.

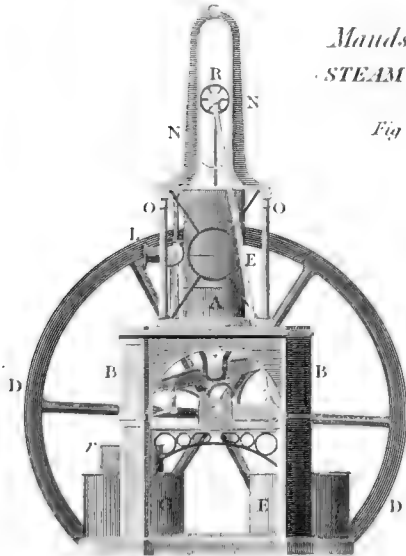


Plan Fig. 2.



*Maudslay's
STEAM ENGINE.*

Fig. 3.



*Murray's
STEAM ENGINE.*

Fig. 4.

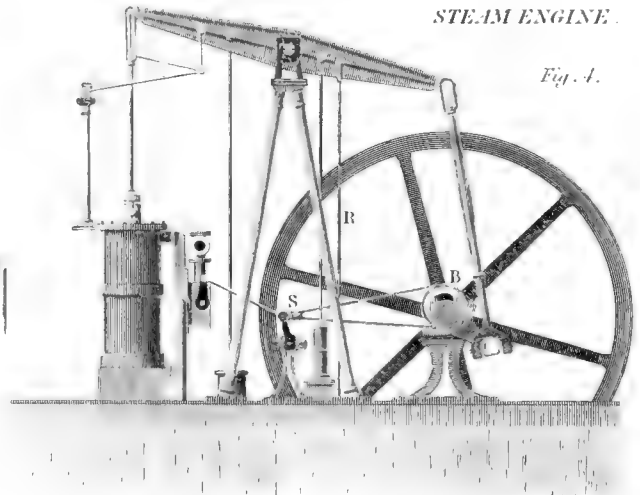


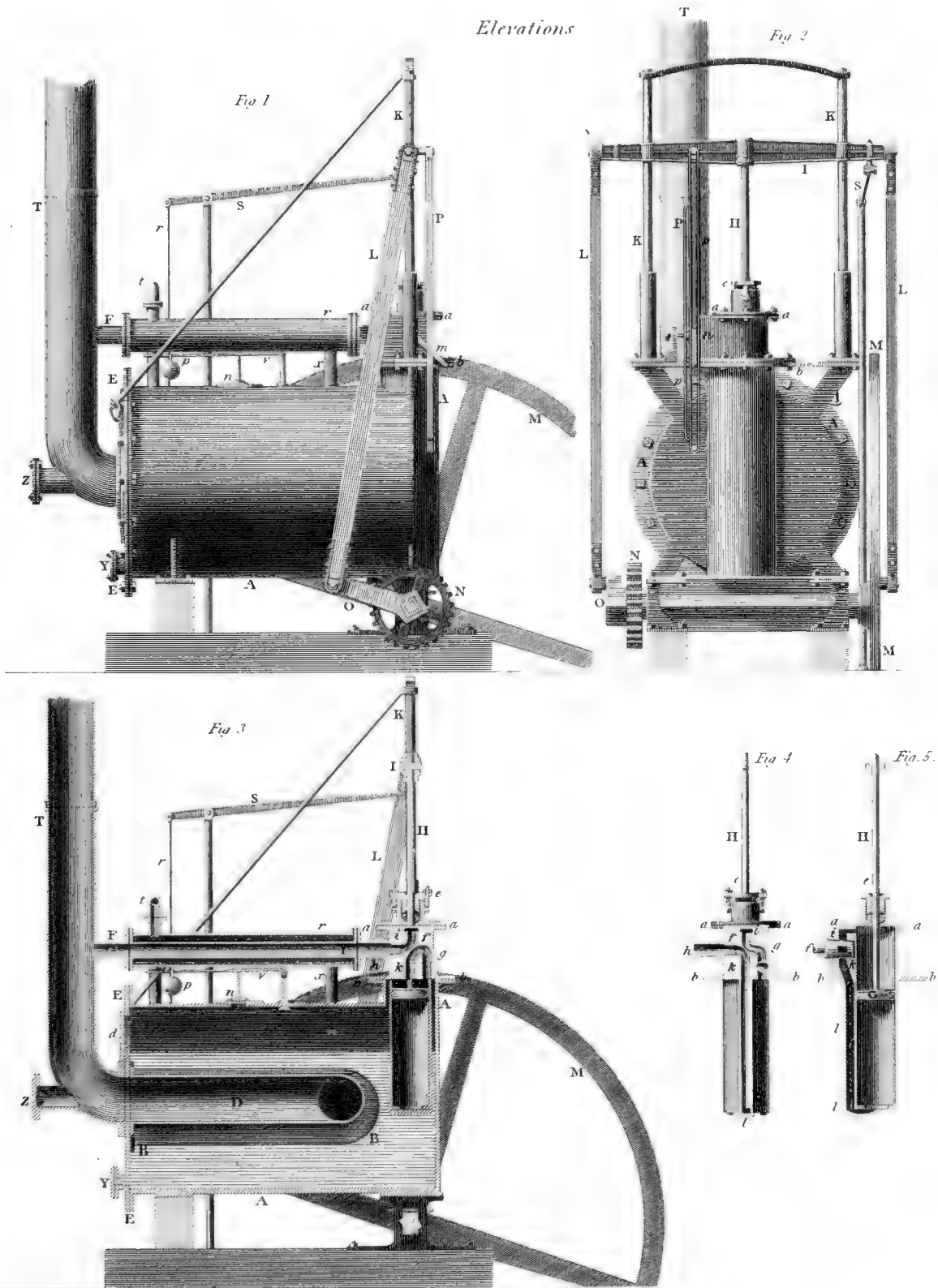
Fig. 5.



STEAM ENGINE.

High Pressure STEAMENGINE used with the Dredging Machine on the River Thames.

Elevations



STEAM ENGINE.
PARALLEL MOTIONS.

Fig. 3.

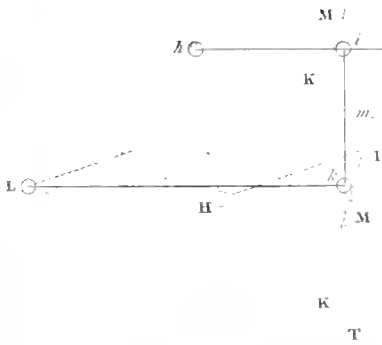


Fig. 1.

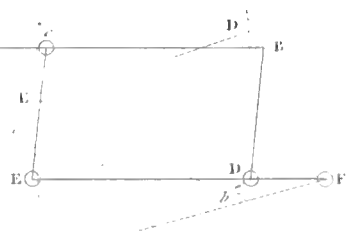


Fig. 4.

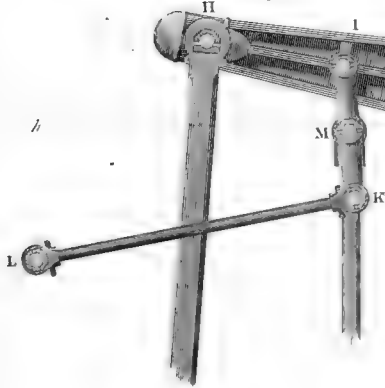
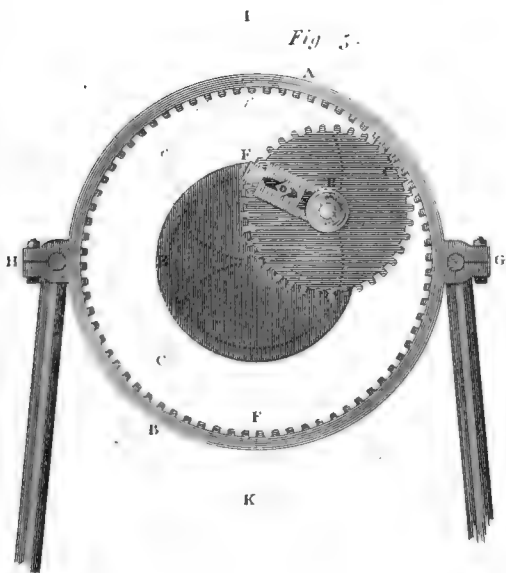


Fig. 2.

By Messrs Boulton & Watt

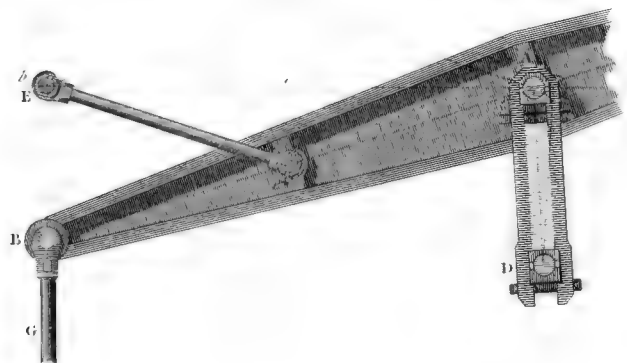


Fig. 5.



By Mr Freemantle

Fig. 6.





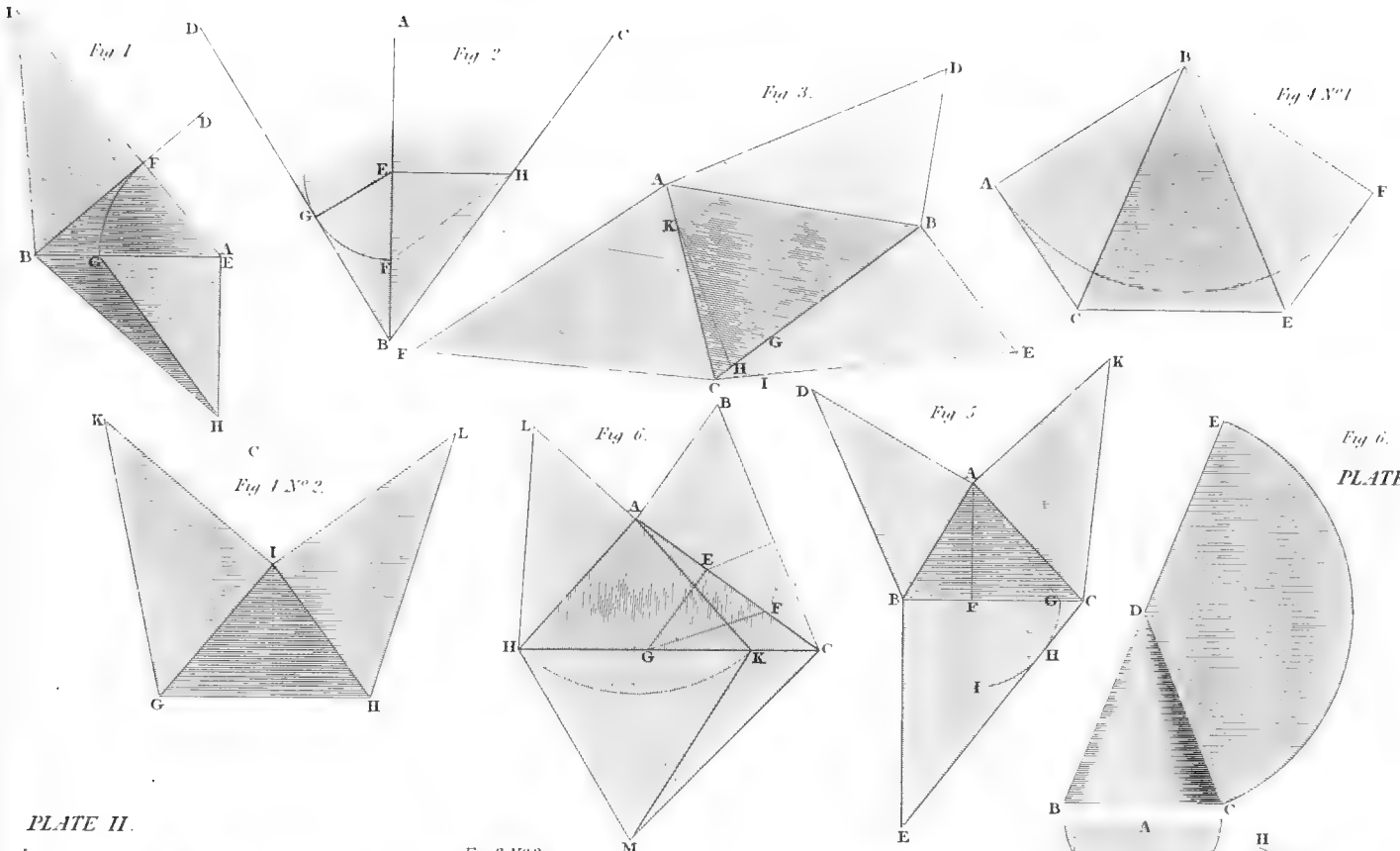
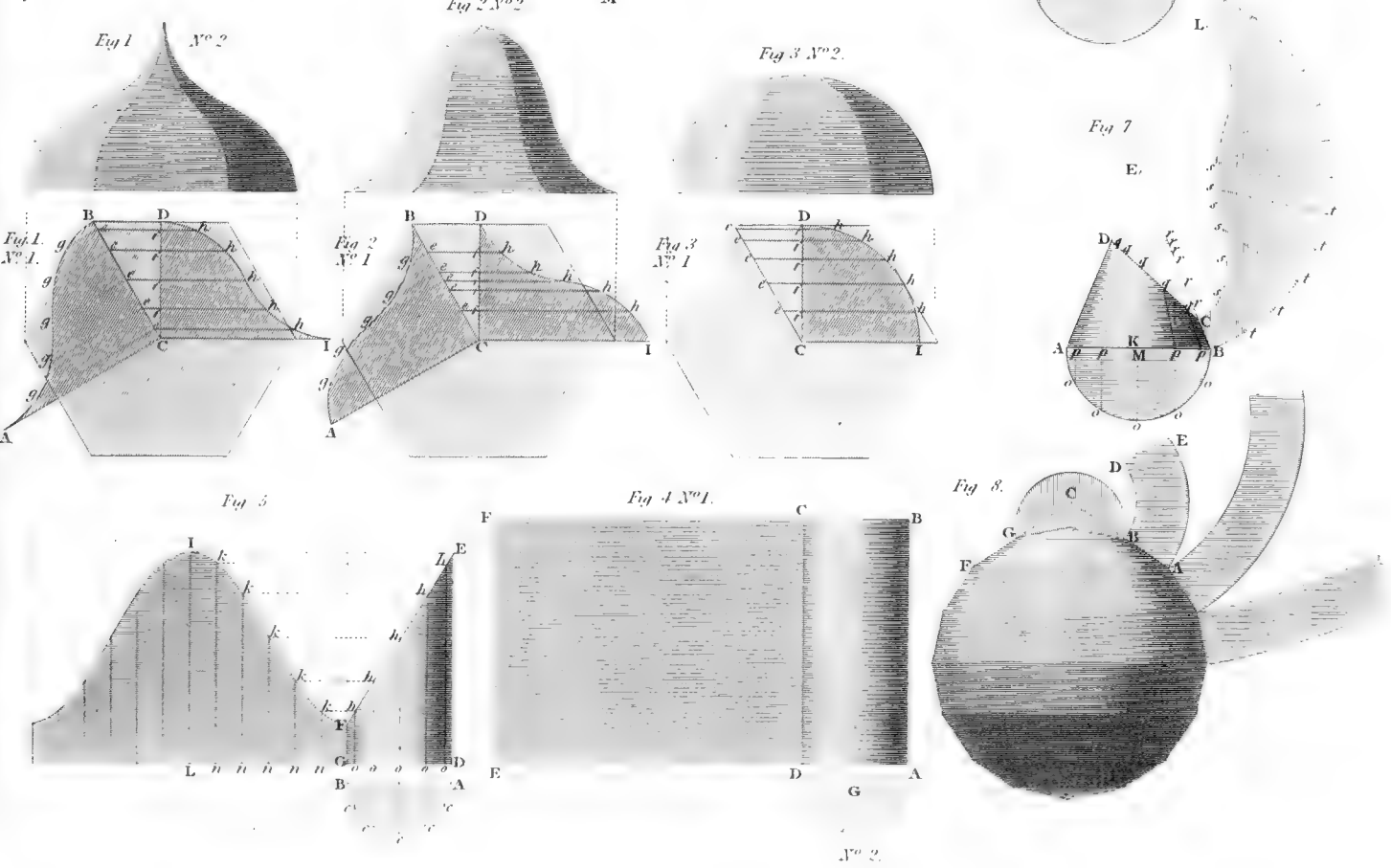


PLATE II.



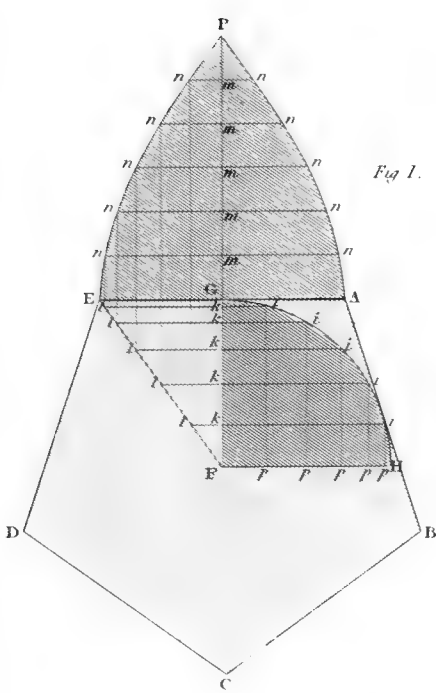


Fig. 1.

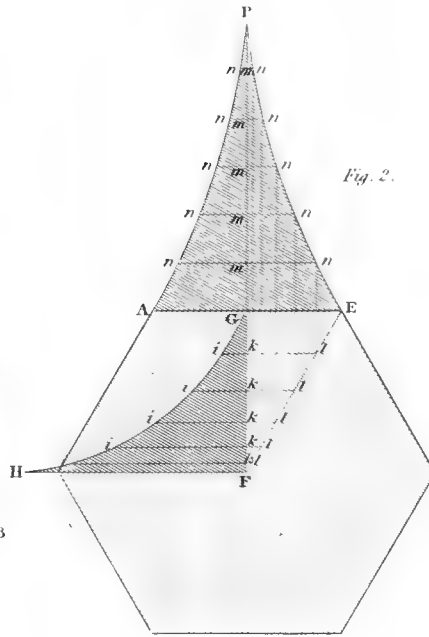


Fig. 2.

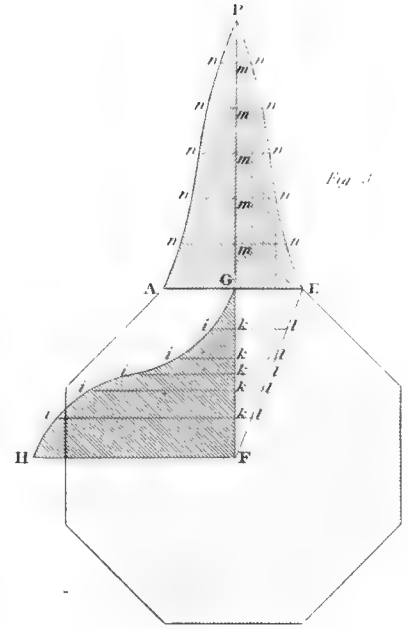


Fig. 3.

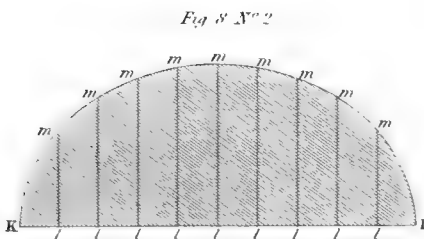


Fig. 8 N° 2

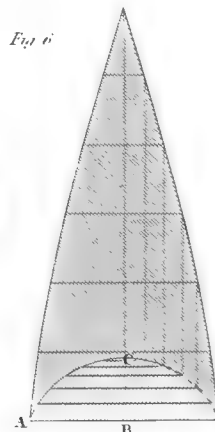


Fig. 6.

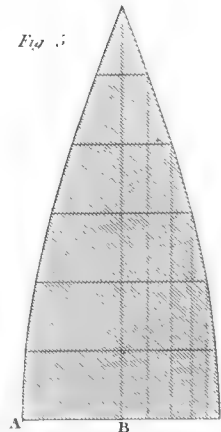


Fig. 5.

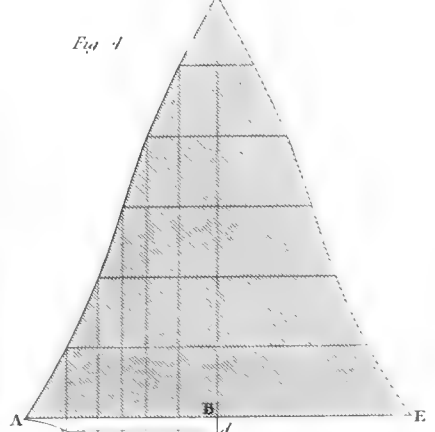


Fig. 4.

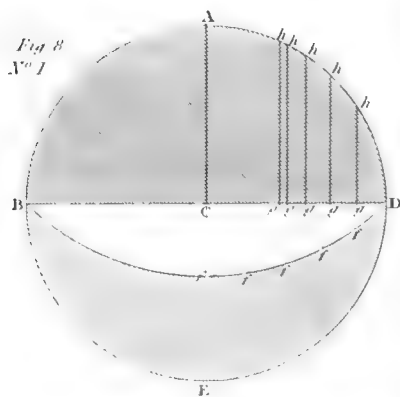


Fig. 8 N° 1

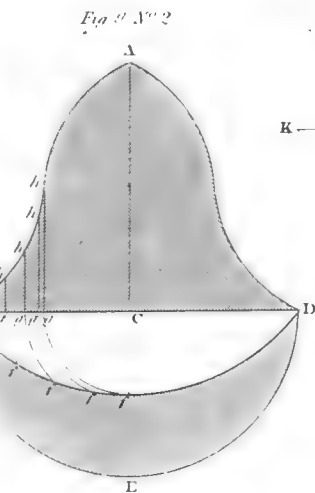


Fig. 9 N° 2

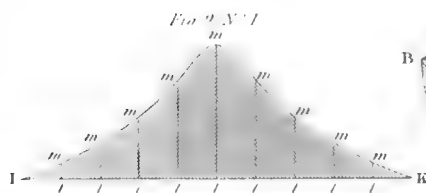


Fig. 9 N° 1

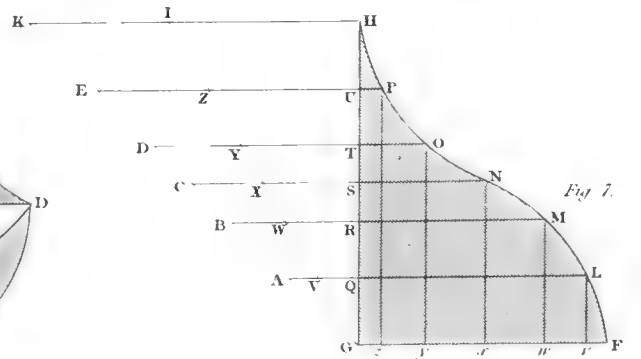


Fig. 7.

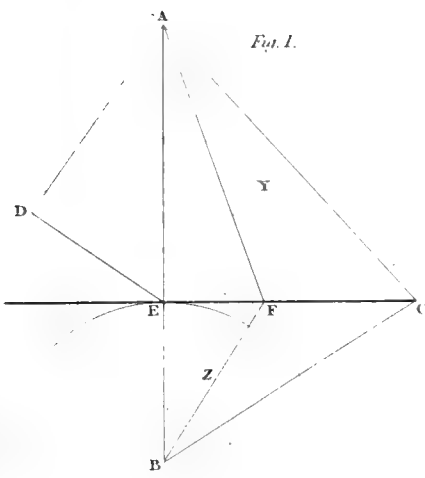


Fig. 1.

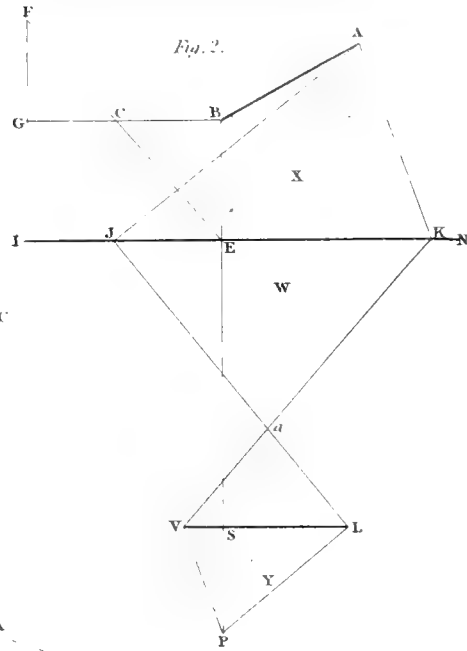


Fig. 2.

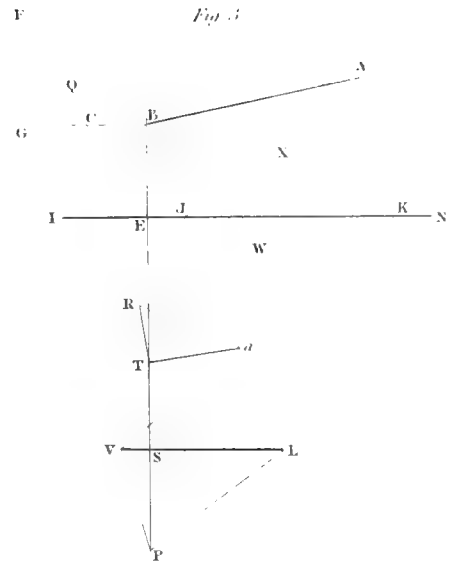


Fig. 3.

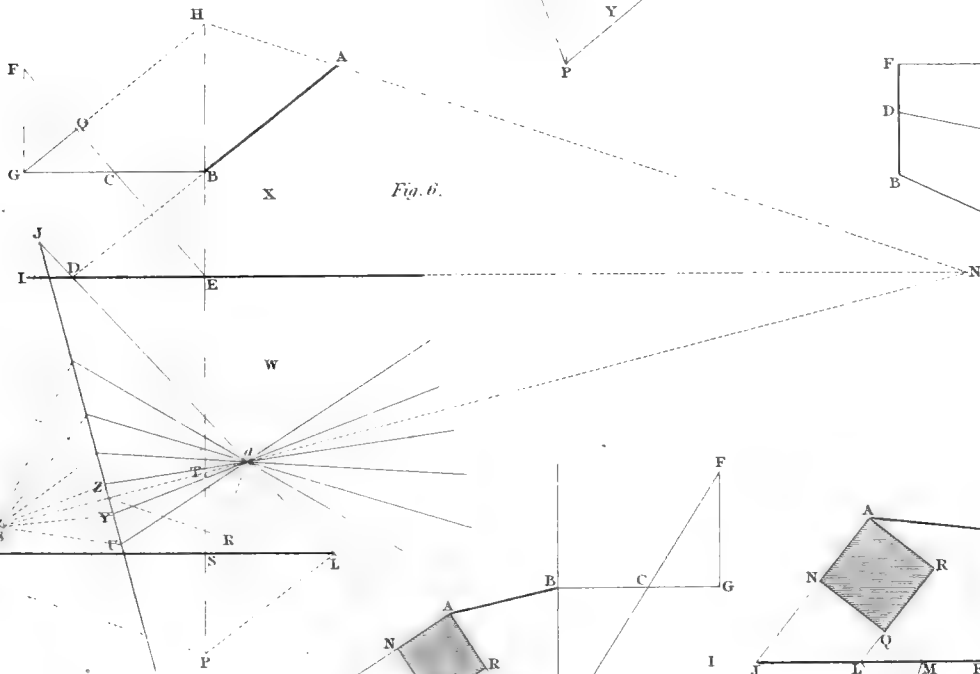


Fig. 4.

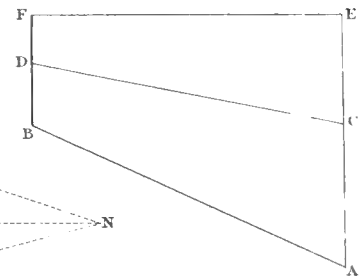


Fig. 5.

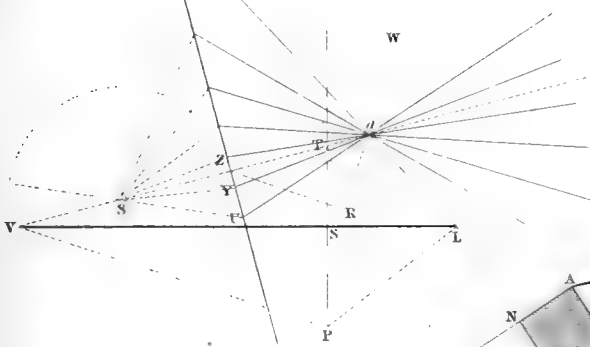


Fig. 6.

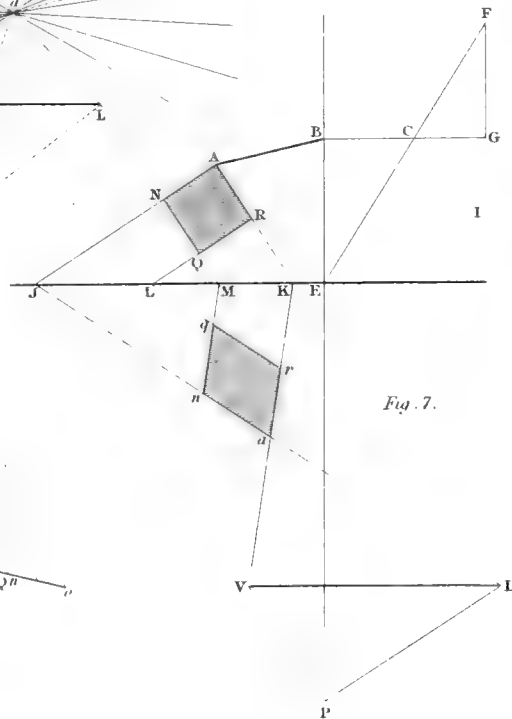


Fig. 7.

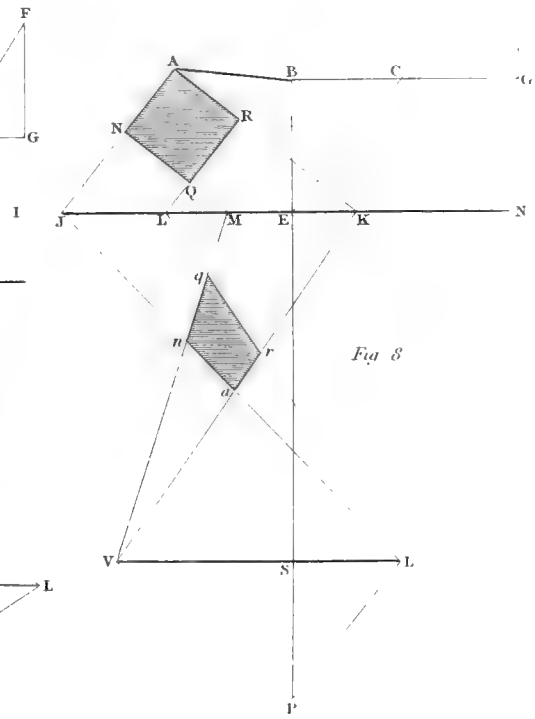


Fig. 8.

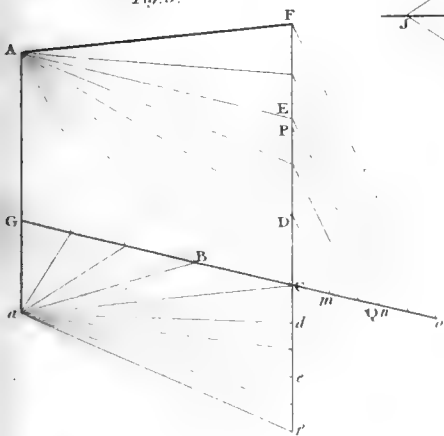
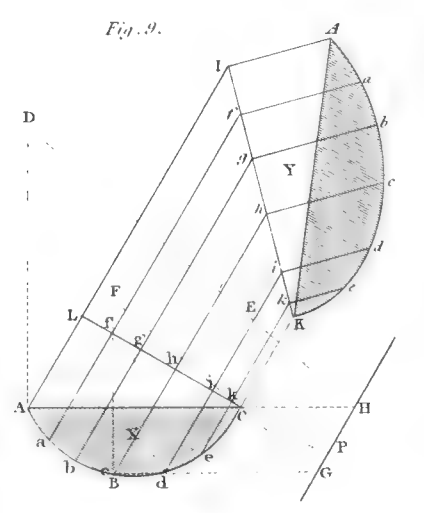
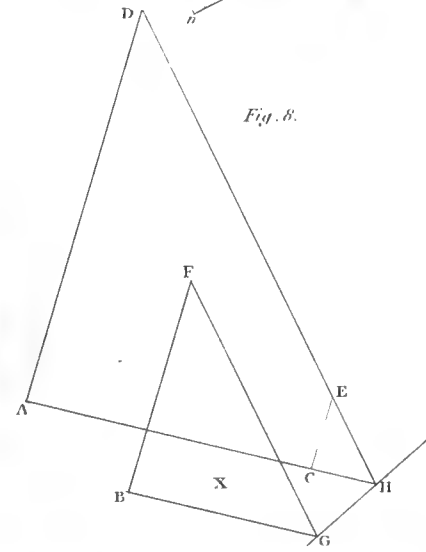
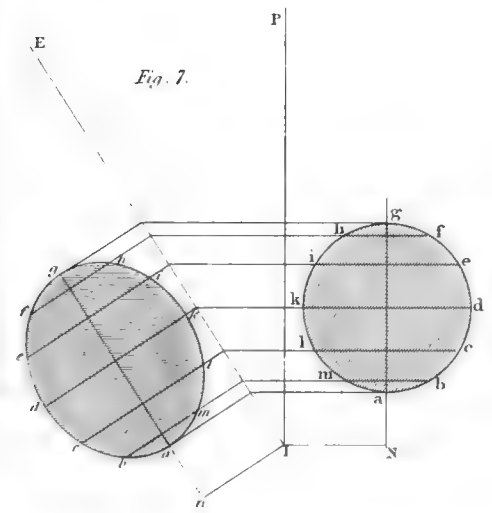
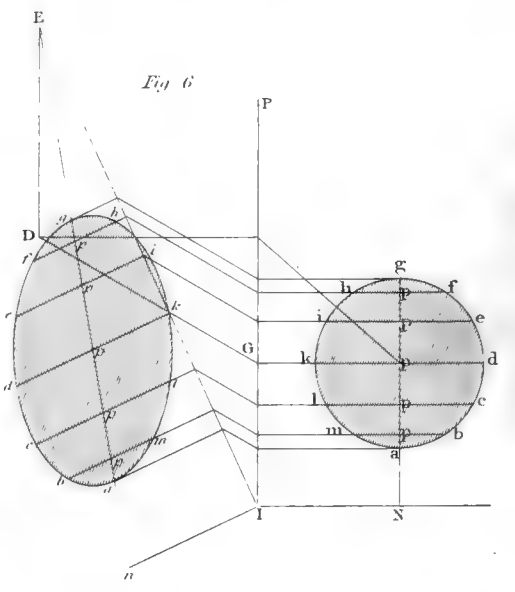
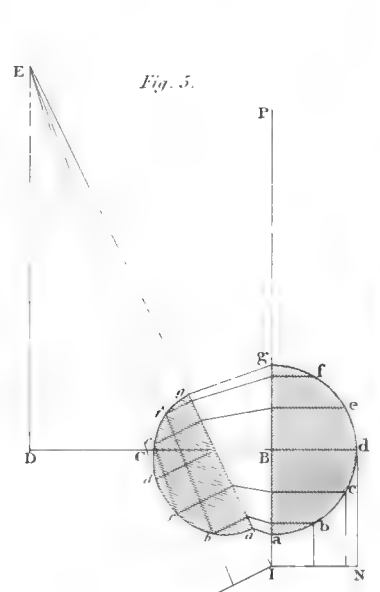
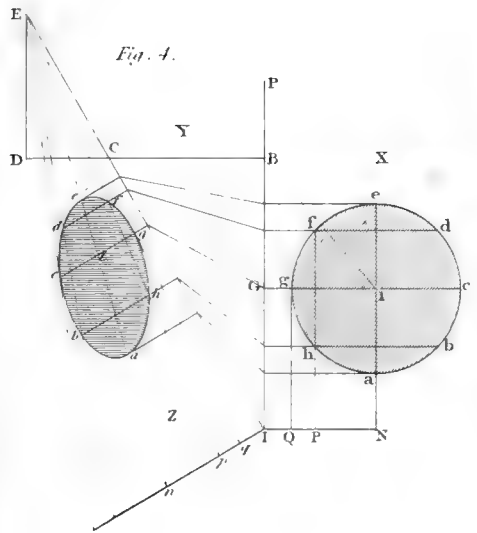
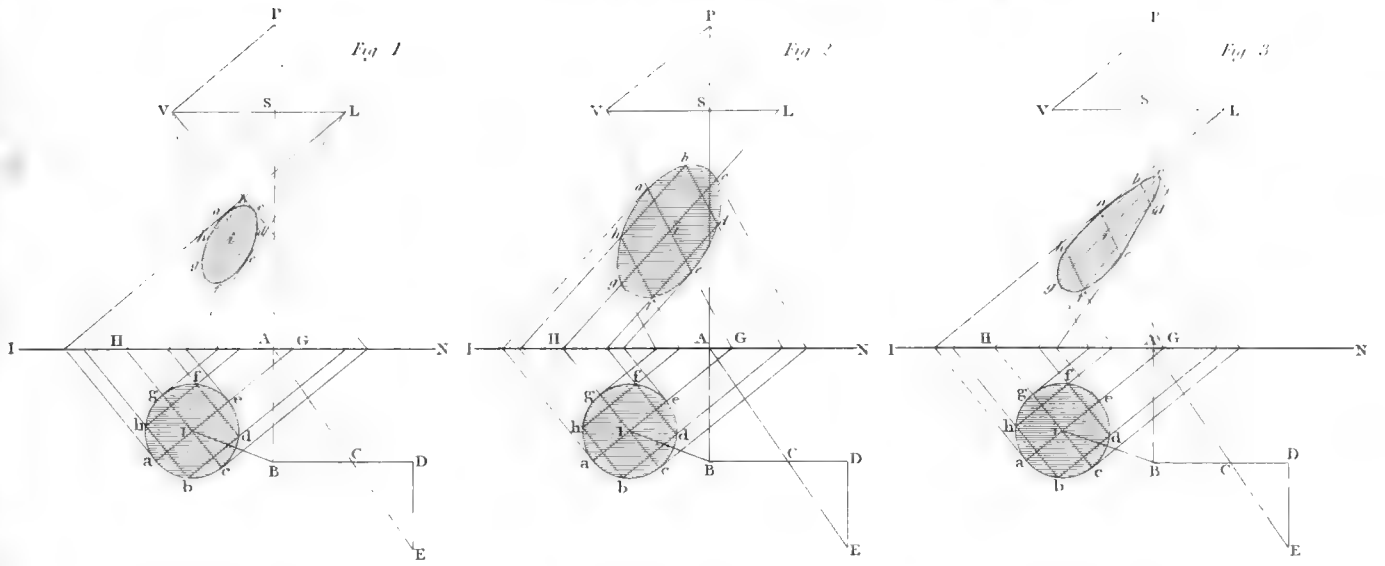


Fig. 9.



STOCKING FRAME.

Fig 1.

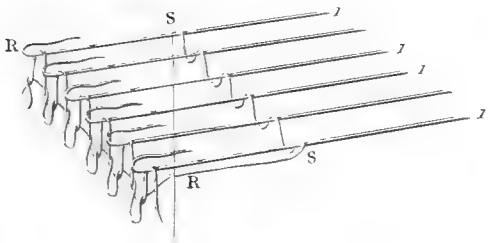


Fig 3.

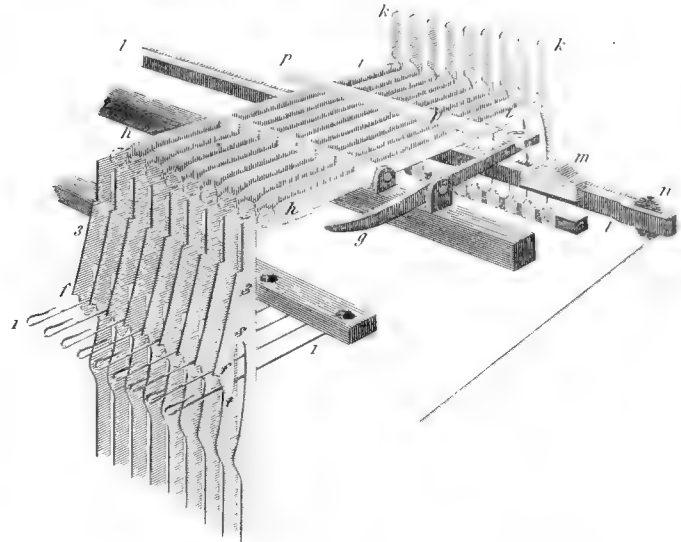


Fig 7.

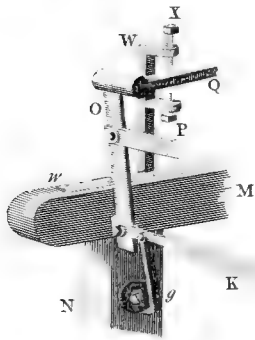


Fig 2.

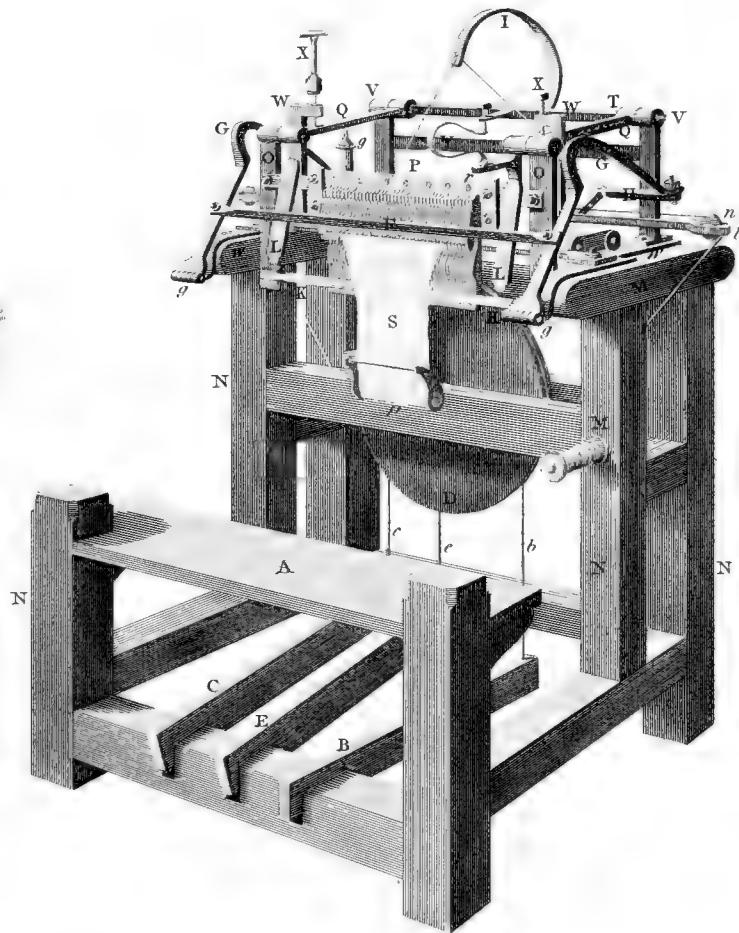
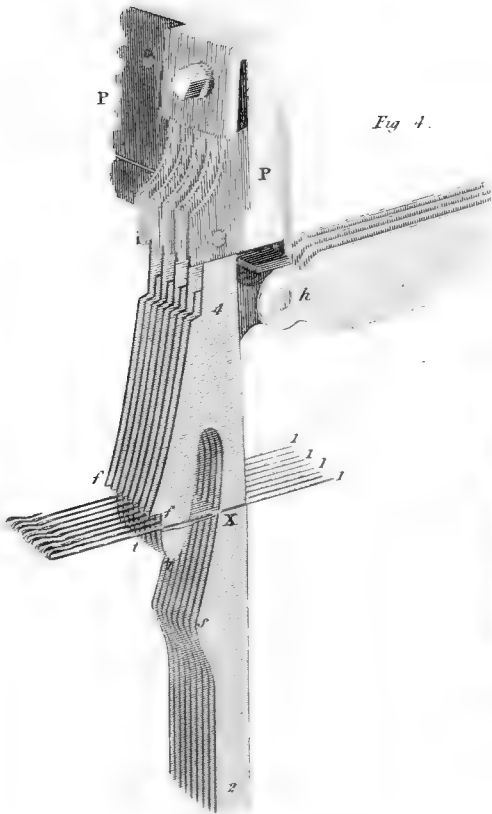
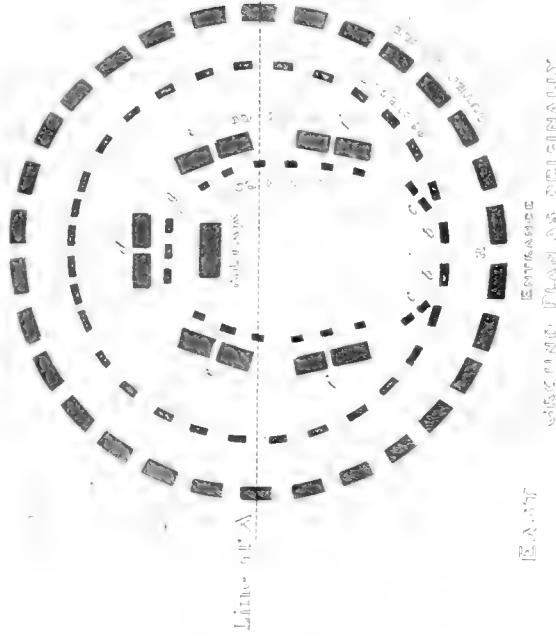


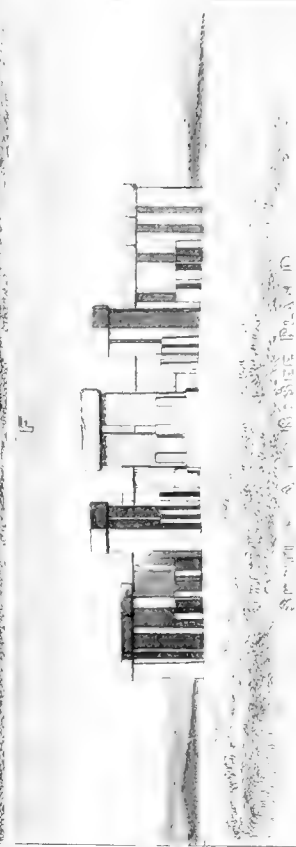
Fig 4.



STONEHENGE
WILTSHIRE, ENGLAND.

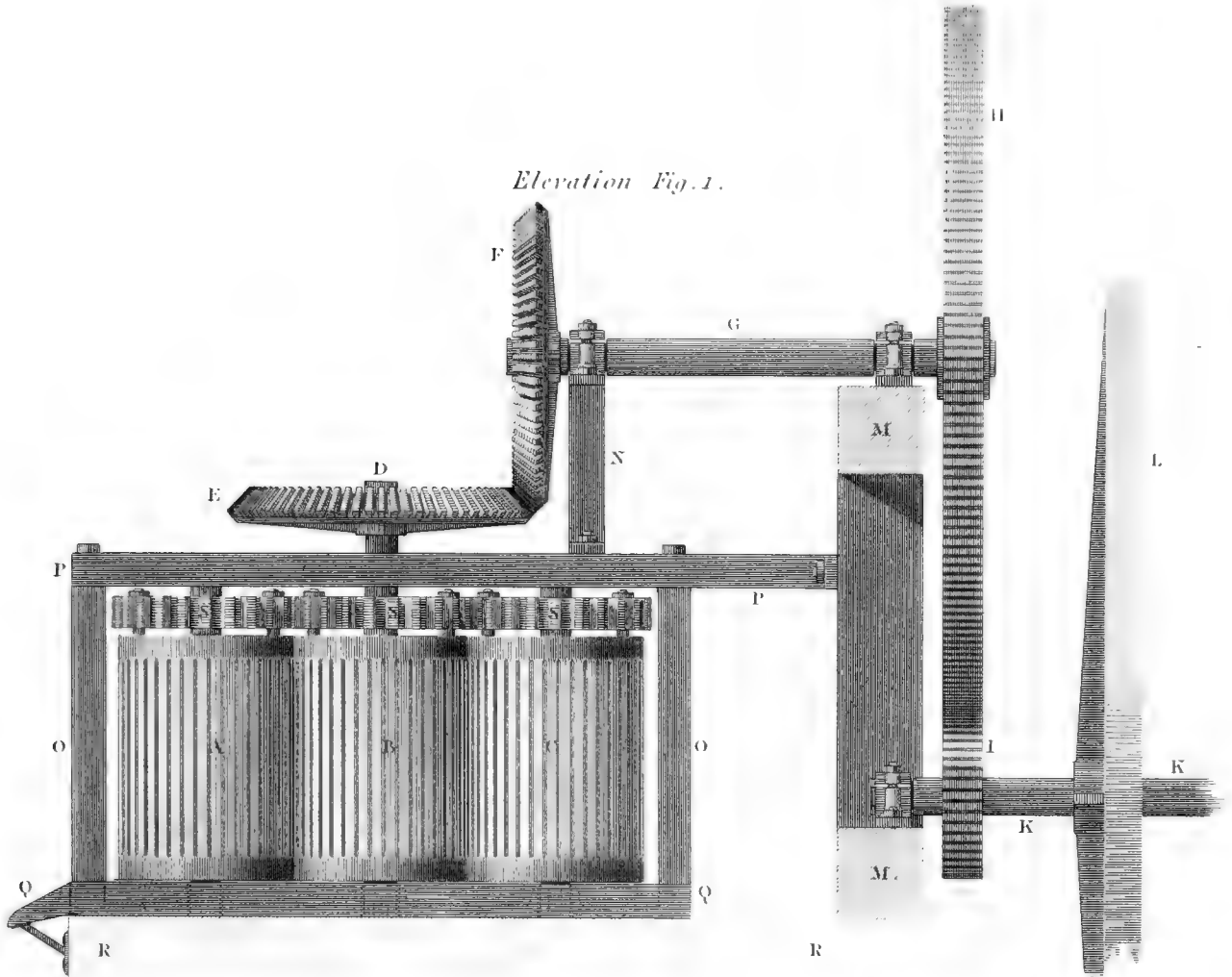


PLAN OF STONEHENGE

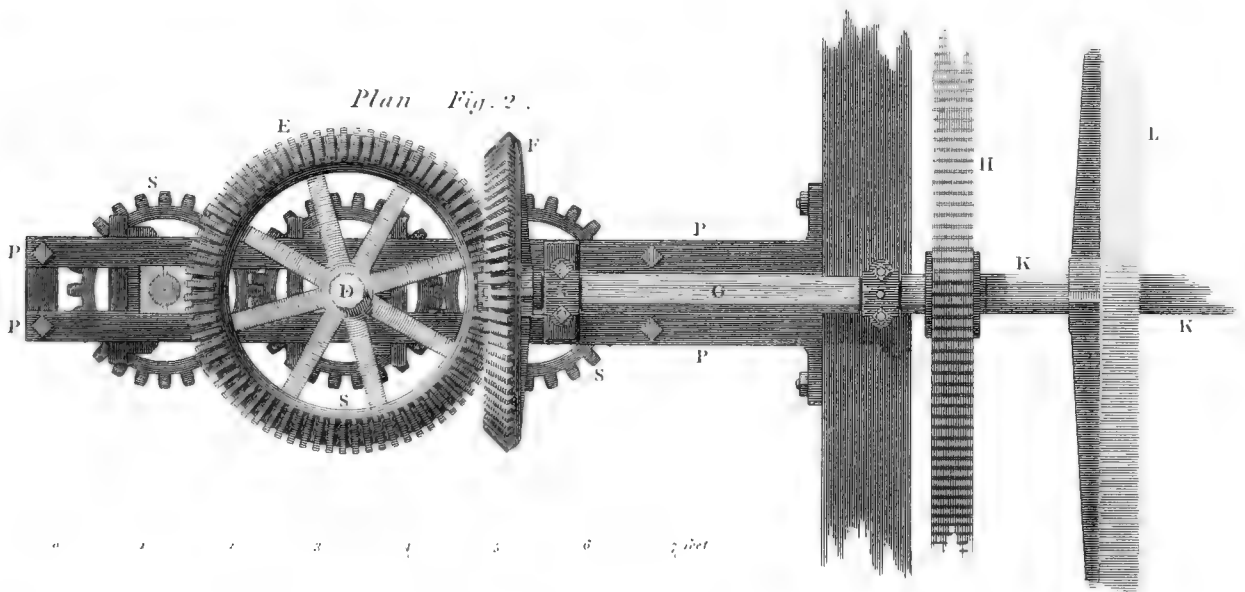


SUGAR MILL.

Elevation Fig. 1.



Plan Fig. 2.



TOURNIQUETS AND AMPUTATING INSTRUMENTS.

Fig. 3.

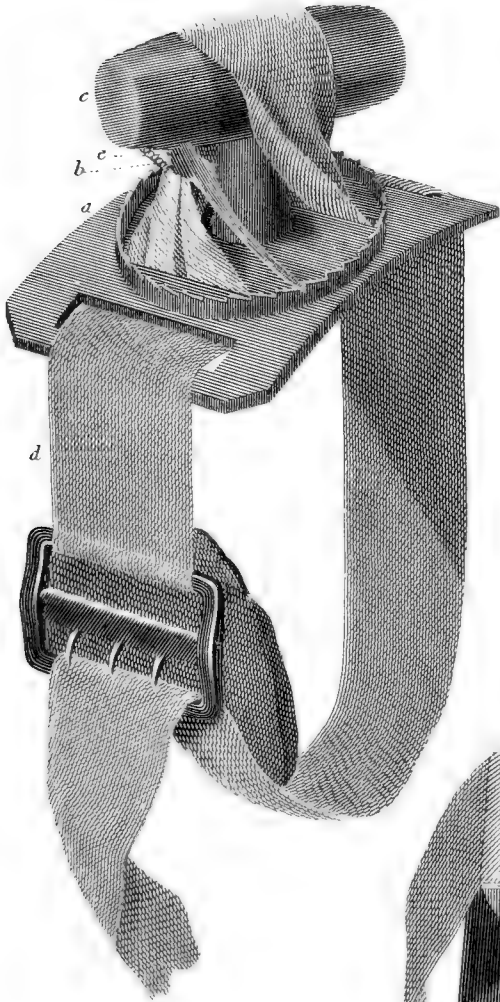


Fig. 1.

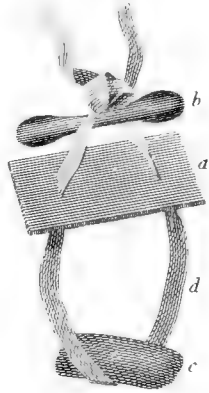


Fig. 2.

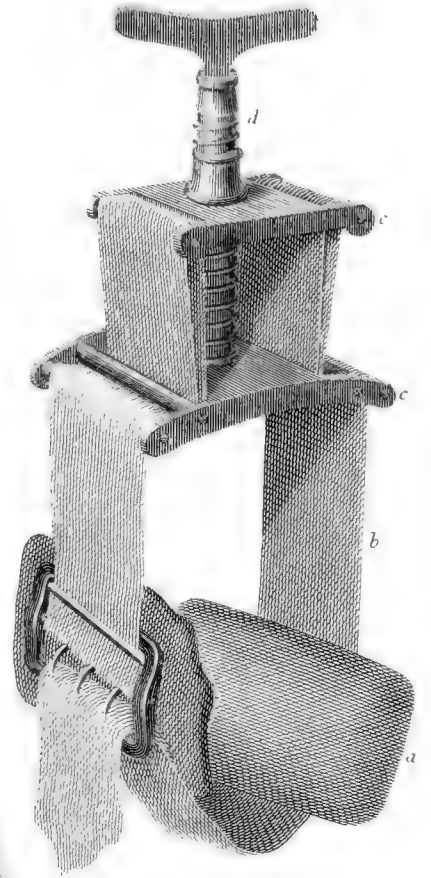


Fig. 4.

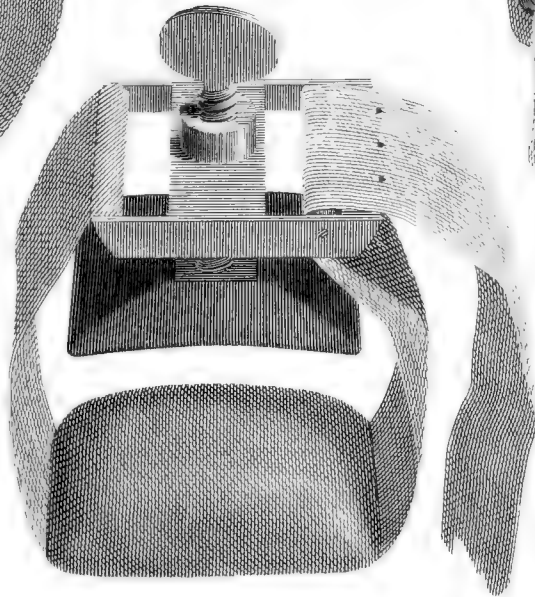


Fig. 5.



Fig. 6.



Fig. 1. Amputating Saw.

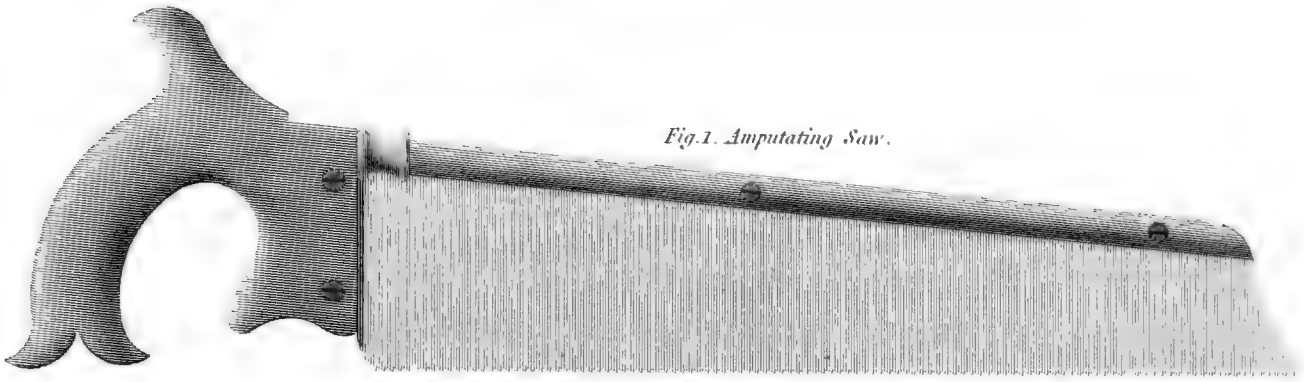


Fig. 2. Large Amputating Knife.

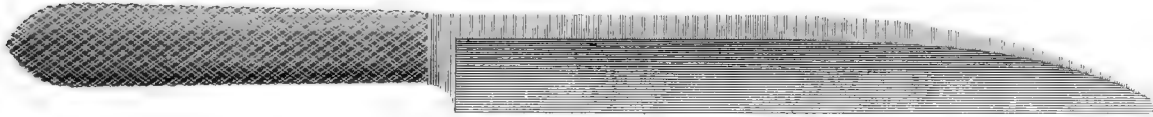


Fig. 3. One of smaller size.

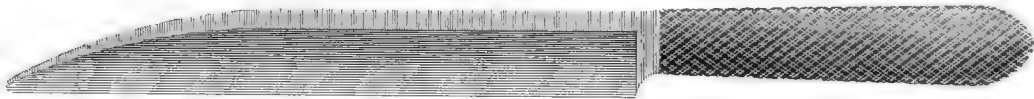


Fig. 4. Catling.

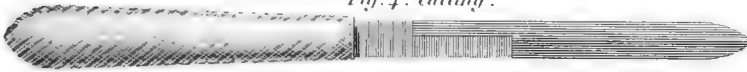


Fig. 5. Metacarpal Saw.

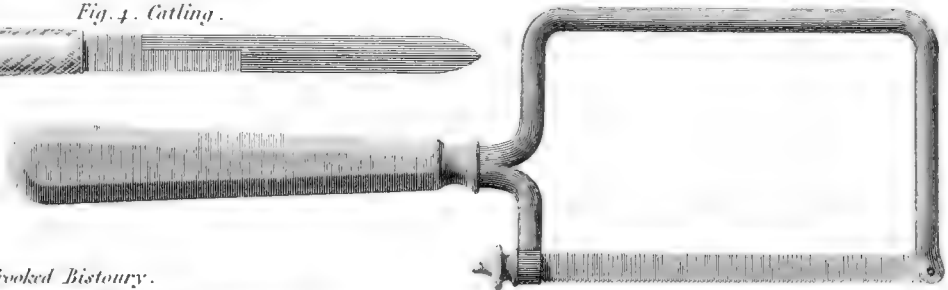


Fig. 6. Crooked Bistoury.



Fig. 7. Probe pointed crooked Bistoury.



Fig. 8. Straight double edged Scalpel.



Fig. 9. Tenaculum.



Fig. 10. Aneurysm Needle.



Fig. 11.

Forceps for taking up the mouths of vessels. Employed also in several operations, in which careful dissection is requisite.



Fig. 12. Bone Nippers.



Fig. 1.

Fig. 2.

Fig. 3.

Needles for sewing up Wounds.

Fig. 4. Spalata.

Fig. 5. Lancet.

Fig. 6. Eye Probe.

Fig. 7. Caustic Case.

Fig. 9. Common Probe.

Fig. 10. Director.

Fig. 12. Pocket Tenaculum.

Fig. 8.

Common Forceps.

Fig. 21.

Scissors.

Fig. 13.

Female Catheters.

Fig. 14.

Fig. 16.

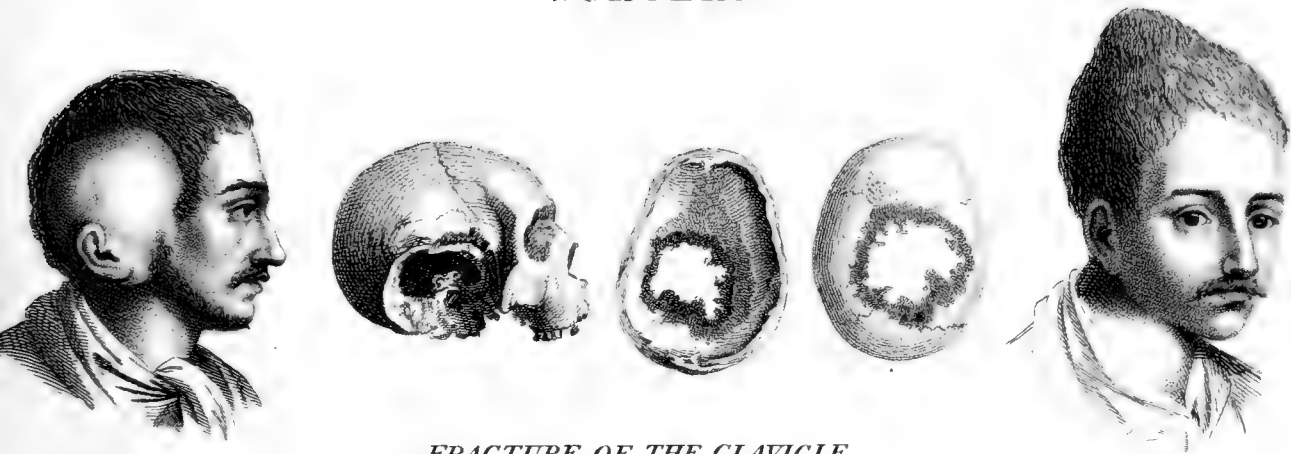
Male Catheters.

Fig. 17.

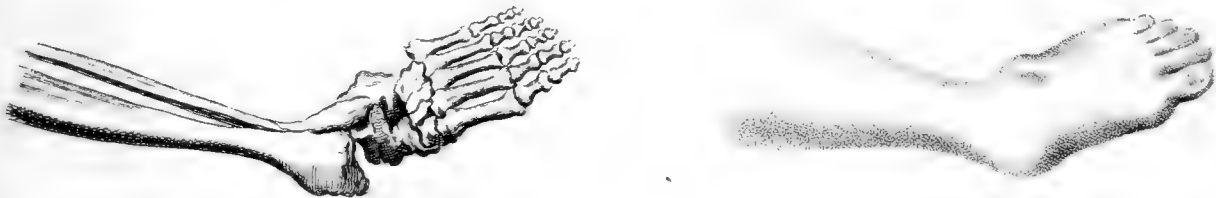
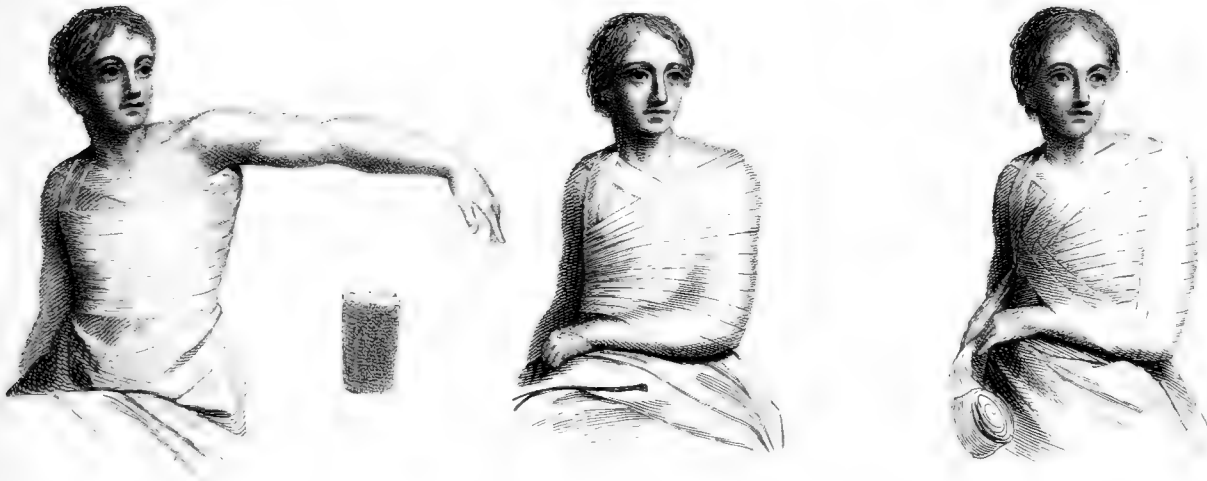
Fig. 18.

Fig. 19.

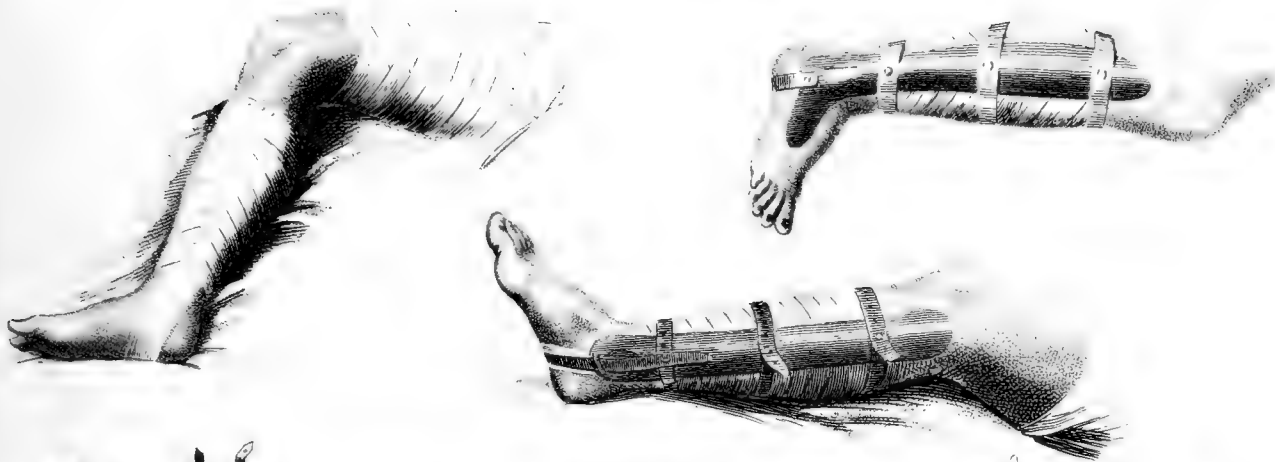
SURGERY.



FRACTURE OF THE CLAVICLE.



FRACTURE OF THE LEG.



SPLINTS.



BANDAGES.



Instruments for Lithotomy.

Fig. 1.

M^r Earle's Stone Breaker.

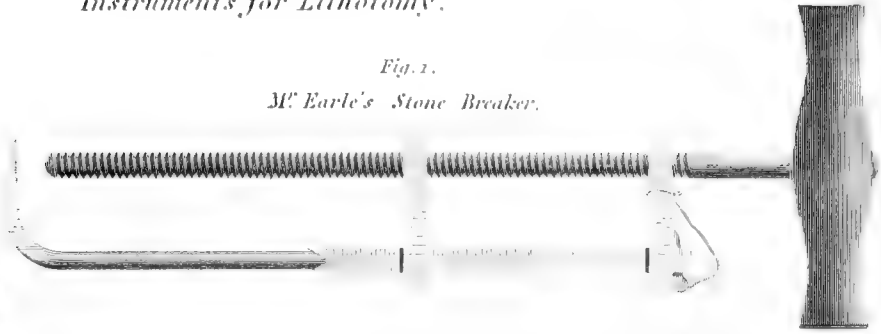


Fig. 3.

M^r Chas. Bell's Staff with the groove on the side.



Fig. 2.
Scoop



Fig. 4.

M^r A. Burn's knife and Staff.

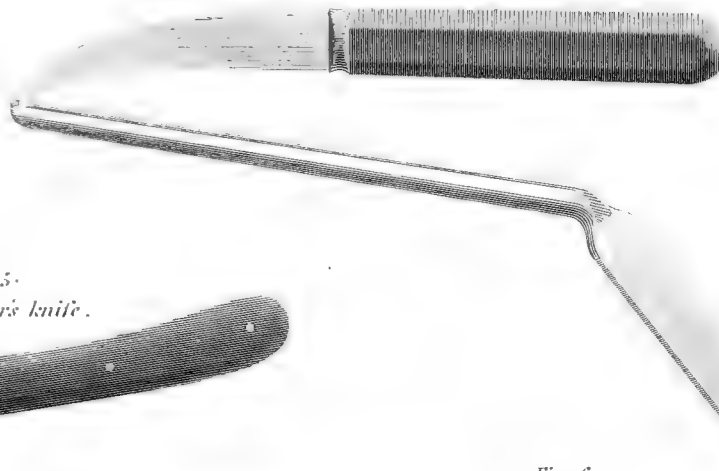


Fig. 5.

M^r Hunter's knife.



Fig. 6.

M^r A. Cooper's knife.



Fig. 7.

M^r Tho^s Blizzard's knife.



Screw, by which the distance, to which the blade shall move out may be best regulated.

Fig. 9.

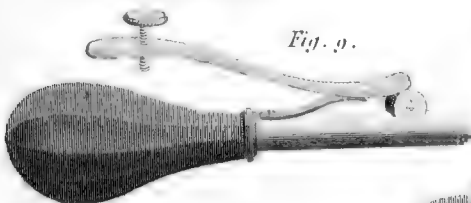
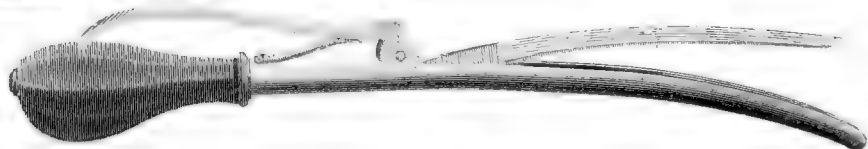


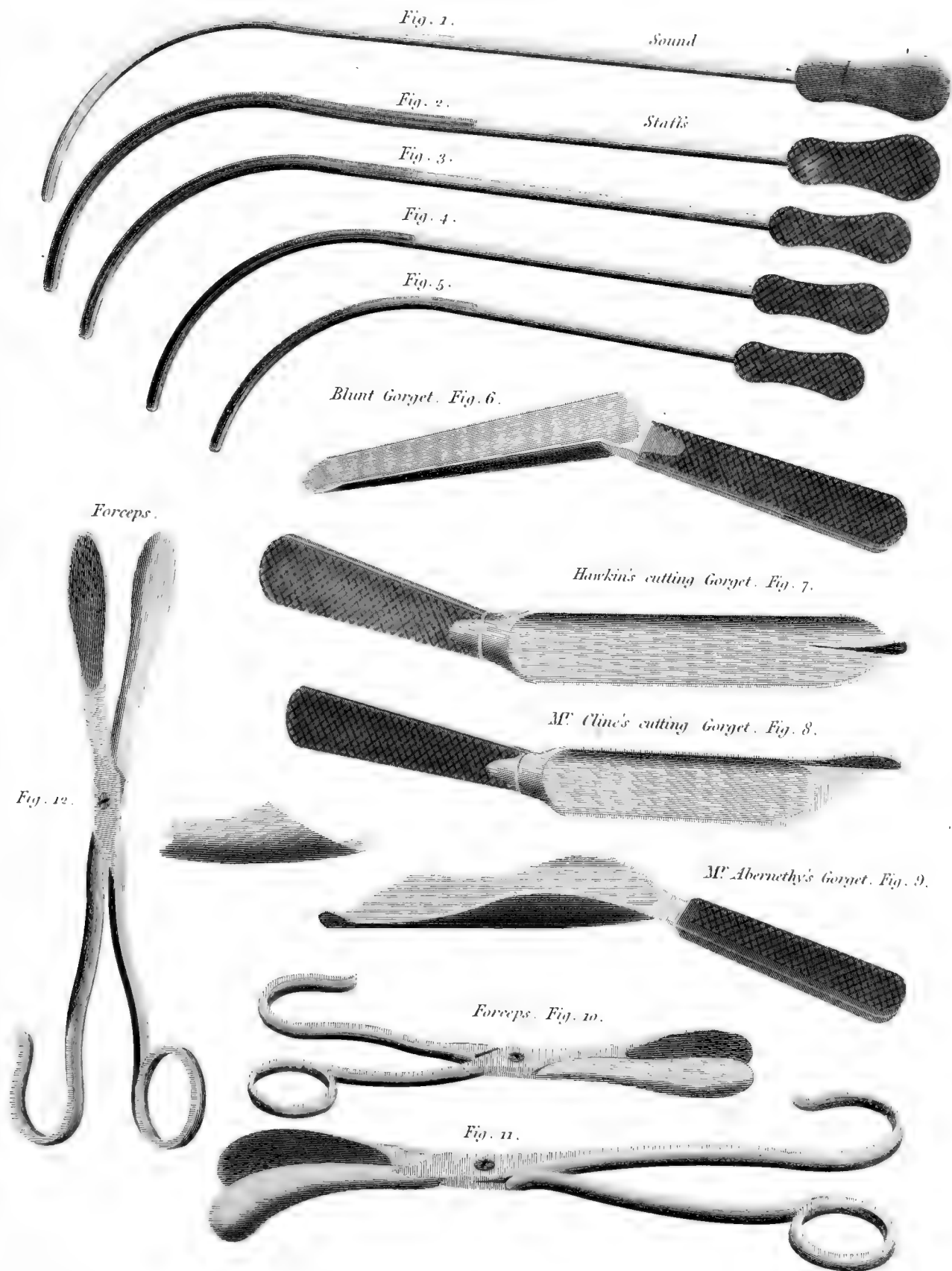
Fig. 8.

Frere Cosmès Bistourie Caché.



SURGERY.

Instruments for Lithotomy.



TRIPOD ELEVATOR.

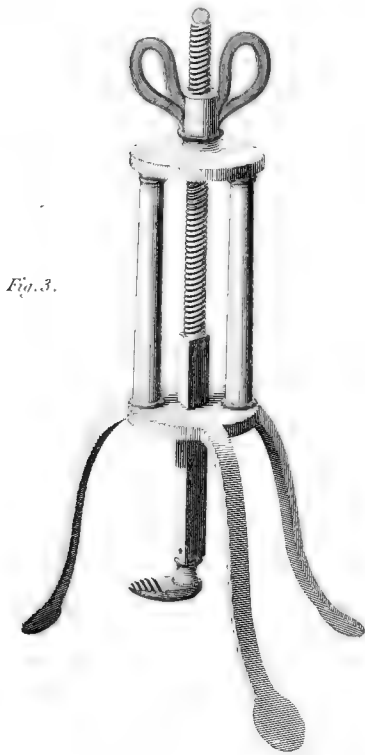


Fig. 2.



ELEVATOR for Raising Depressed Portions of a FRACTURED SKULL.

M^r RODMANS TREPPANNING INSTRUMENT.

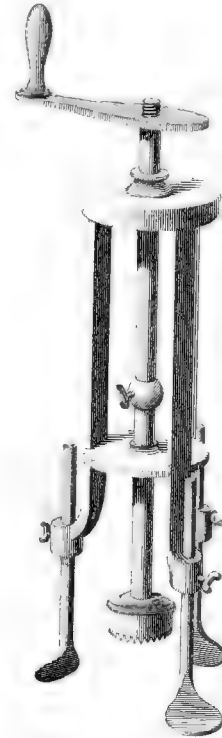


Fig. 1.

ELEVATOR of L.L. PETIT as improved by M. LOUIS.

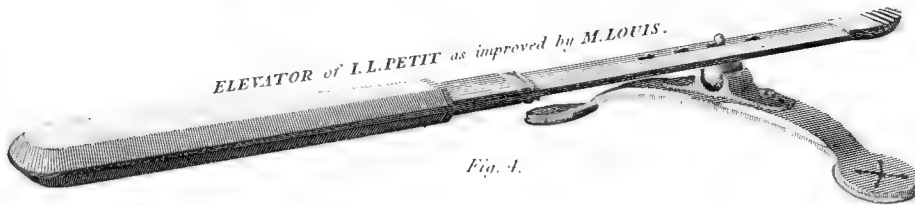


Fig. 4.

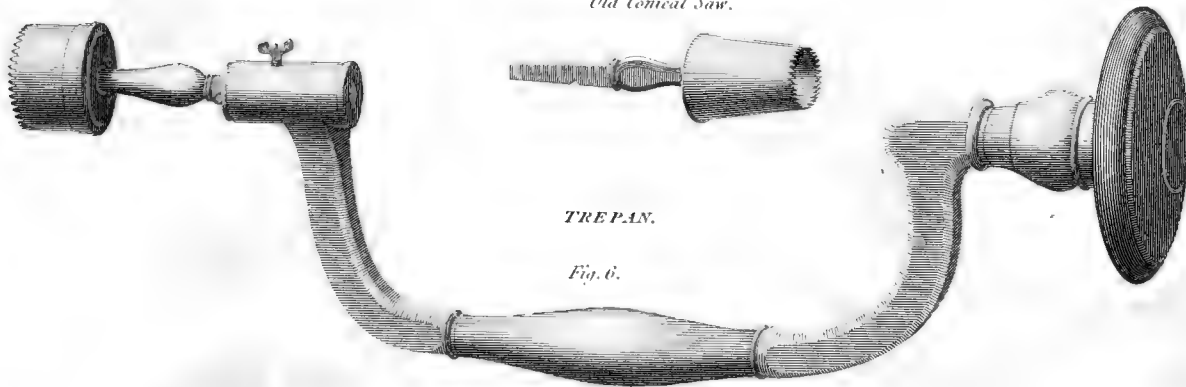
Fig. 5.

Old Conical Saw.



TREPAN.

Fig. 6.



TREPANNING INSTRUMENTS.

Fig. 1. Spring Forceps for Extracting the Circle of Bone, and Fragments.



Trephines with Sliding Centre-Pins as made by Savigny.

Fig. 2.

Fig. 3.

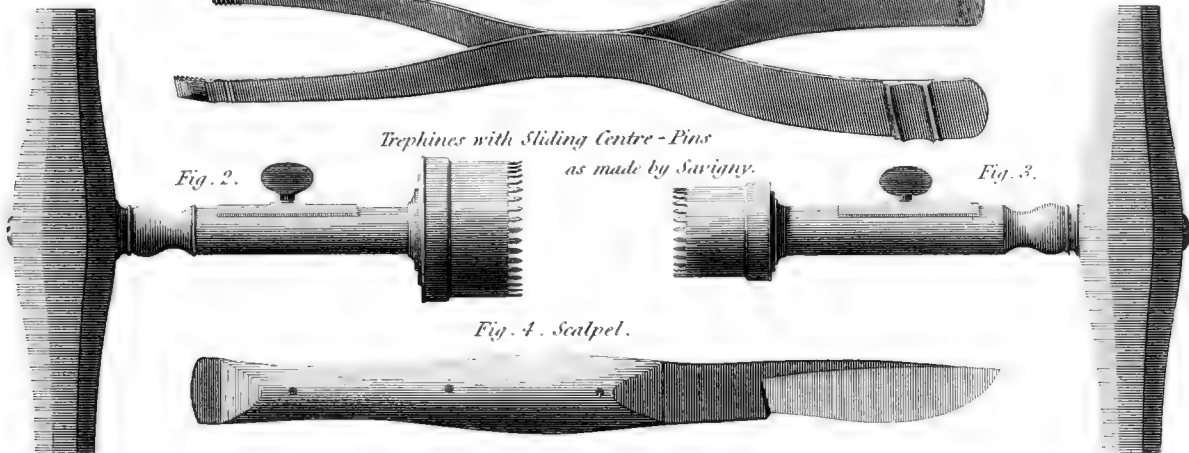


Fig. 4. Scalpel.



Fig. 5. Common Elevator.

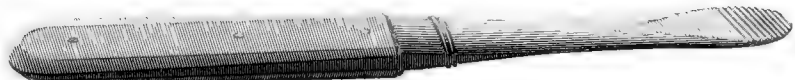


Fig. 6. Mr. Hey's Saws with Curved Edges.



Fig. 7. Lenticular.



Fig. 8. Raspatory.



Fig. 9. Mr. Hey's small straight Saw.



Brush for cleaning the Teeth of the Trephine.



Fig. 11.

Fig. 12. Mr. Hey's large straight Saw.

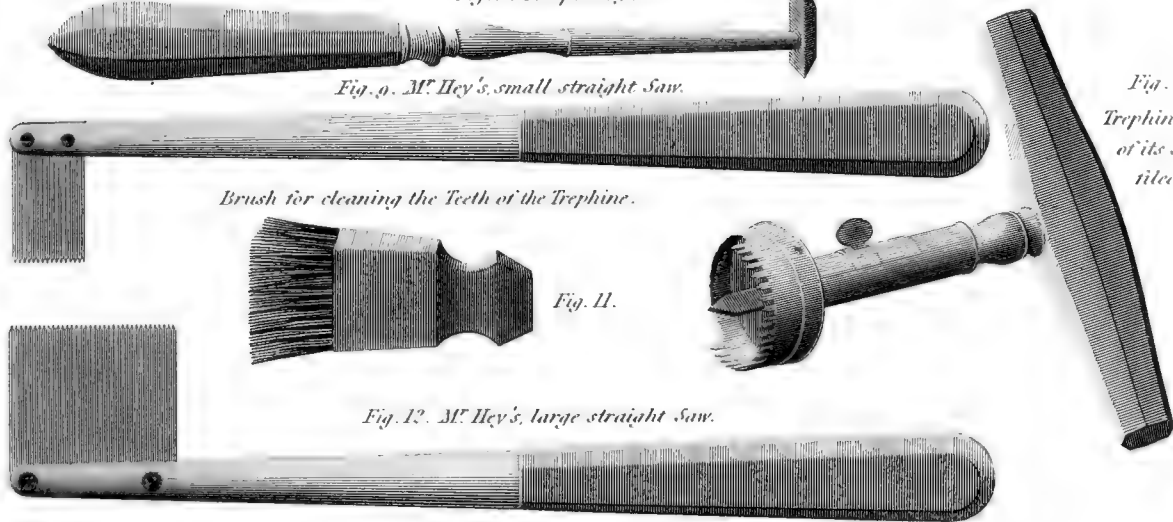


Fig. 13.

Centre pin and Screw.

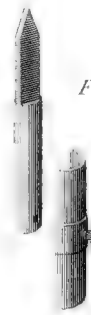


Fig. 1.

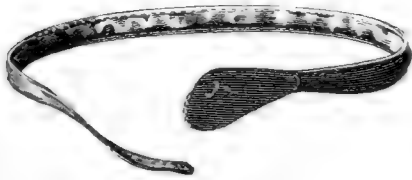


Fig. 2.



Fig. 3.

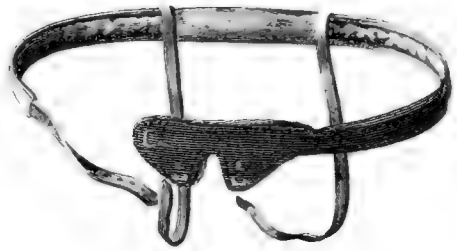
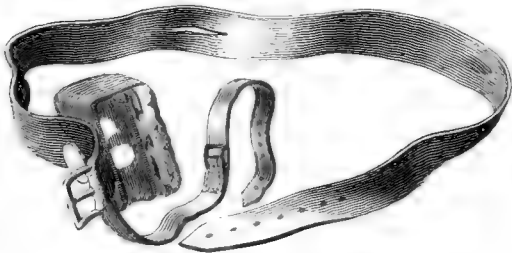


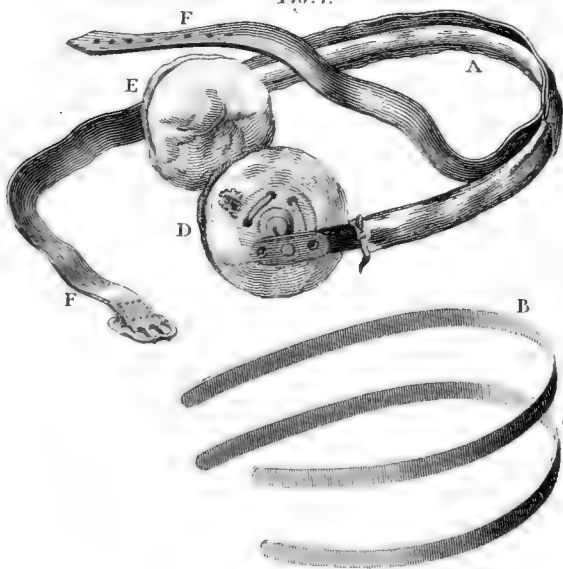
Fig. 4. Dr. Hulme's Palm Truss.



M. Whitford's Fig. 5.

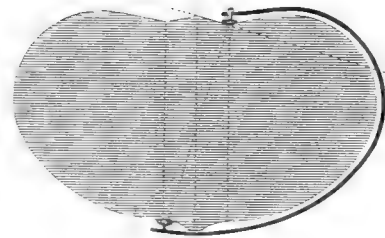


Fig. 6.



M. Salmon's Patent.

Fig. 7.



M. Morrison's for Exomphalos Fig. 8.

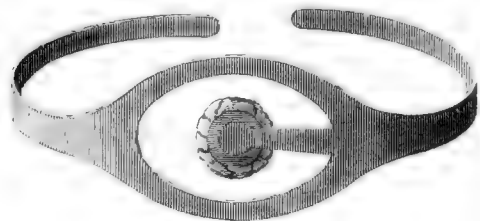
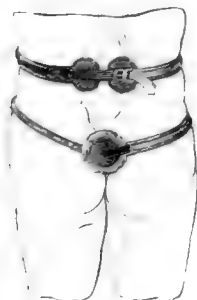


Fig. 10.



M. England's Fig. 9.

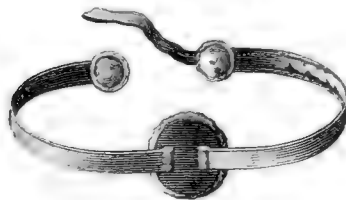
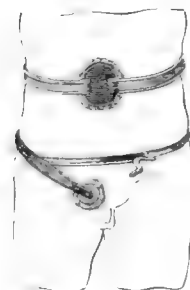
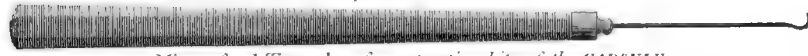


Fig. 11.



Instruments for the Extraction of the CATARACT,
and for the Fistula Lachrymalis.

Fig. 1.



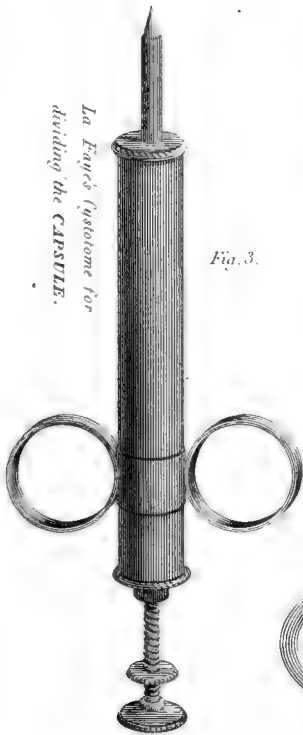
Minute Steel Tenaculum for extracting bits of the CAPSULE.

Fig. 2.



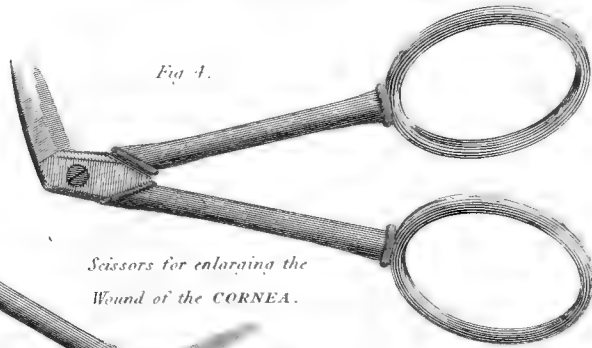
Cline's Instrument for dividing the CAPSULE.

Fig. 3.



La Feye's Syringe for
dividing the CAPSULE.

Fig. 4.



Scissors for enlarging the
Wound of the CORNEA.

Fig. 5.

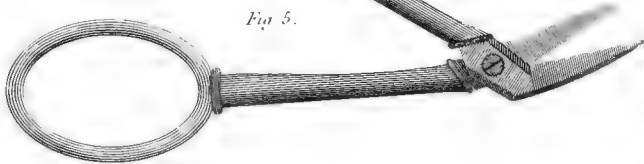
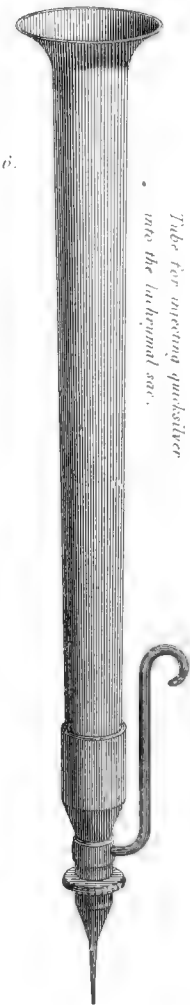


Fig. 6.



Tube for inserting quills
into the lachrymal sac.

Anel's Syringe and Pipes.

Fig. 7.



Fig. 8.



Fig. 9.

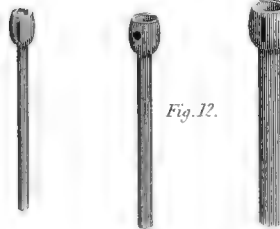


Fig. 10.



Wathen's Tubes.

Fig. 11.



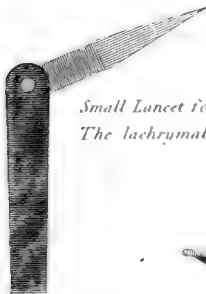
Ware's Stiles.

Fig. 12.



Small Lancet for puncturing
The lachrymal sac.

Fig. 13.

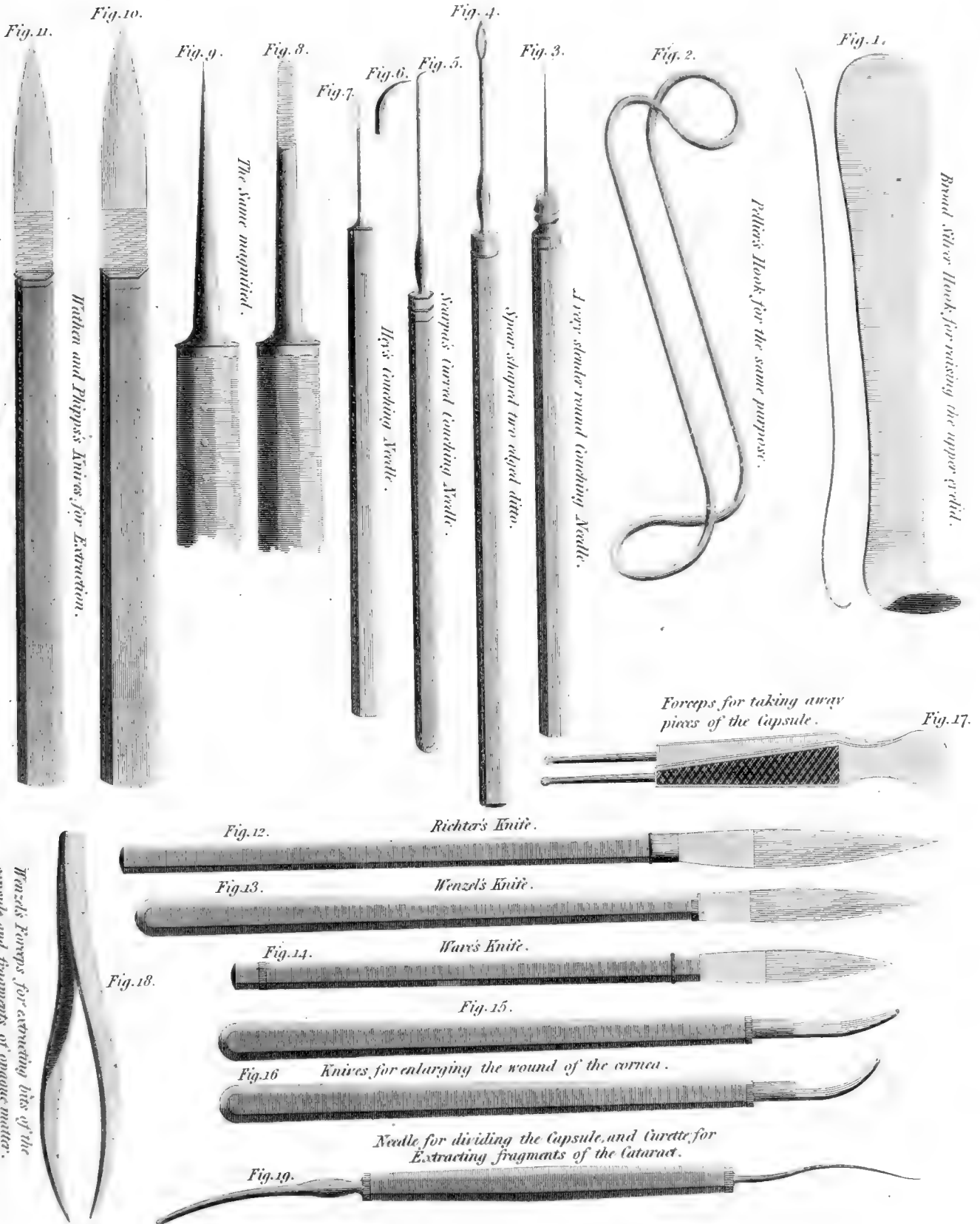


Gibson's Knife for LITHOTOMY.

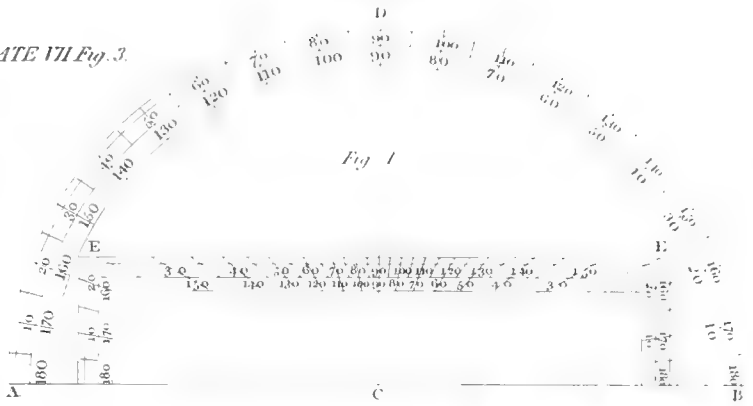
Fig. 14.



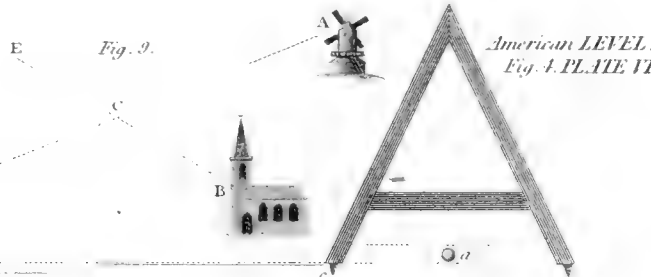
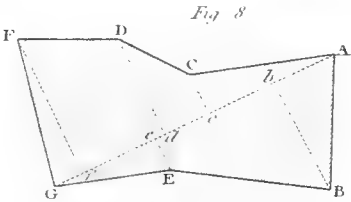
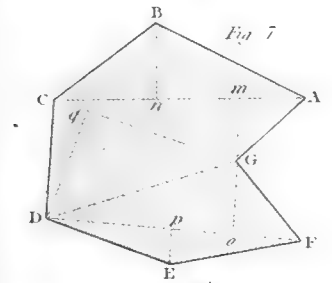
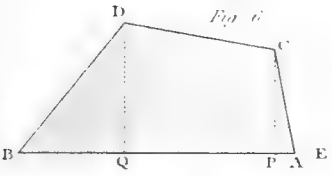
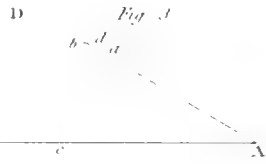
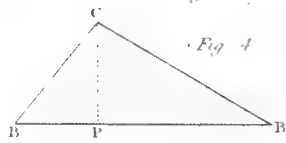
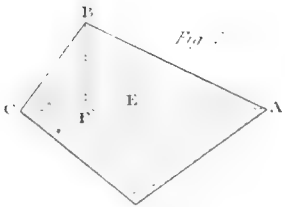
Instruments for Couching and the Extraction of the Cataract.



PROTRACTOR.



For Fig 2 see PLATE VII Fig. 3.



American LEVEL. Fig. 4. PLATE VII.

LEVEL

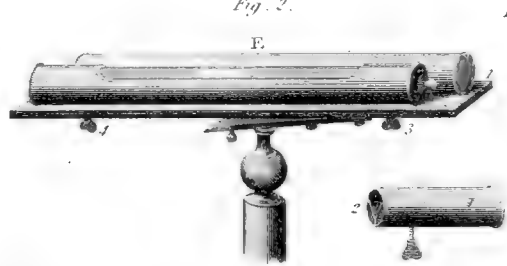
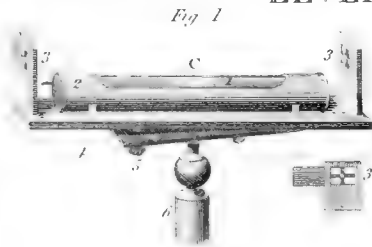
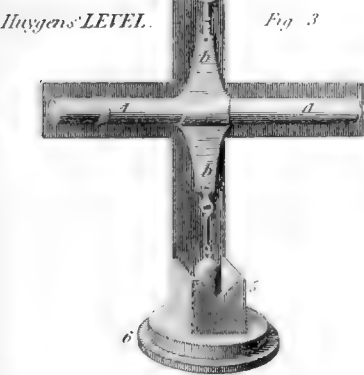
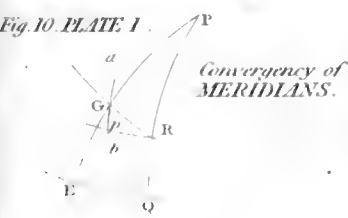
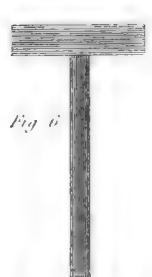
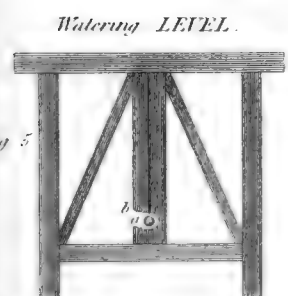
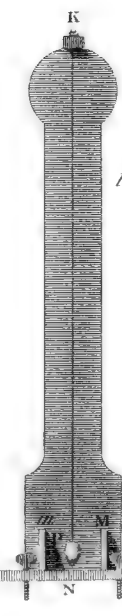
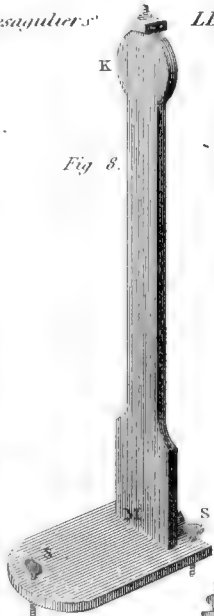
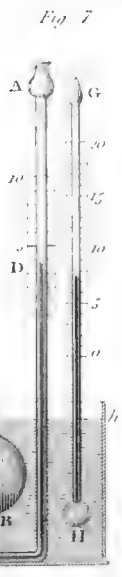


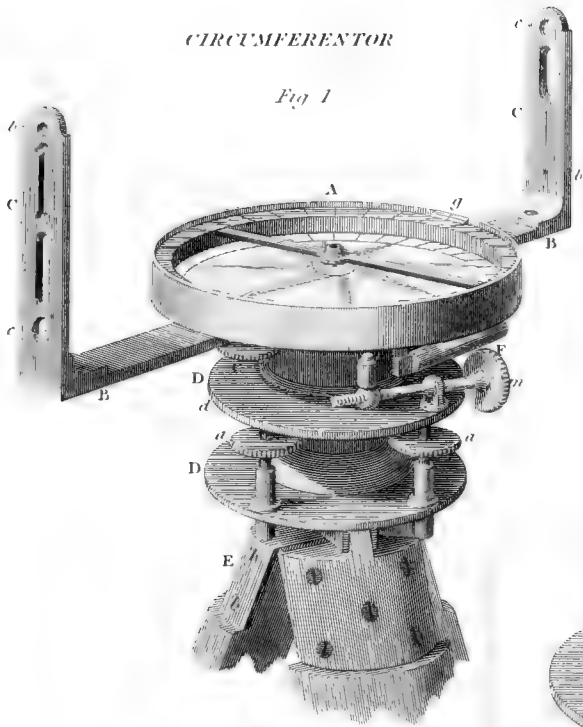
PLATE VI.

Desagueters' LEVEL.



CIRCUMFERENTOR

Fig 1



CROSS

Fig 1

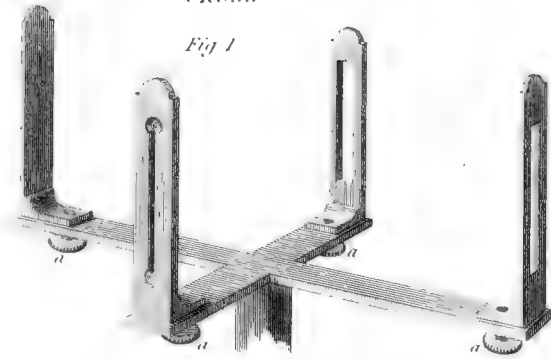


Fig 2.

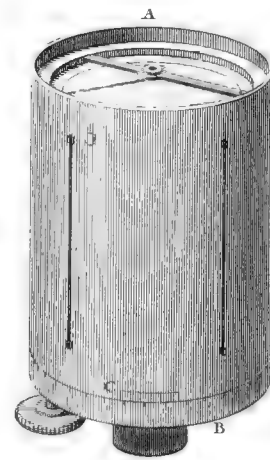


Fig 5.

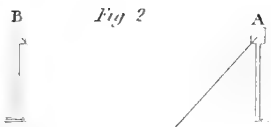
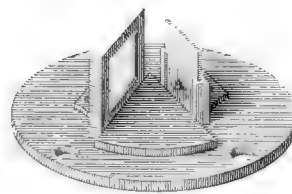


Fig 2

Fig 4

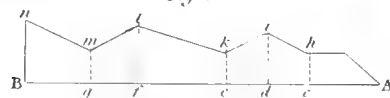


Fig. 3.

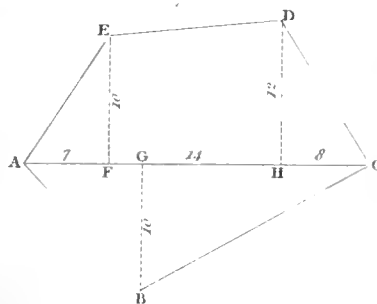


Fig. 6.

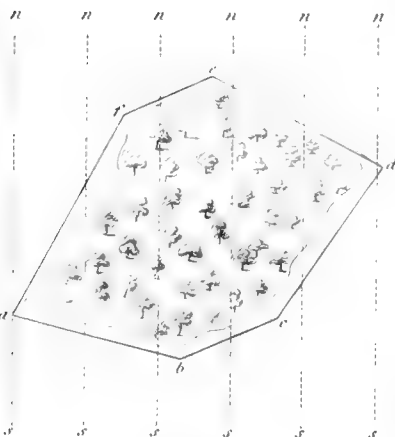
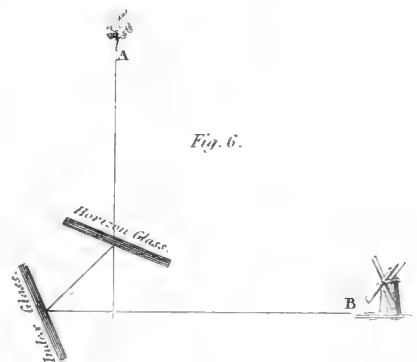


Fig. 3

SURVEYING

GAUGING Rod

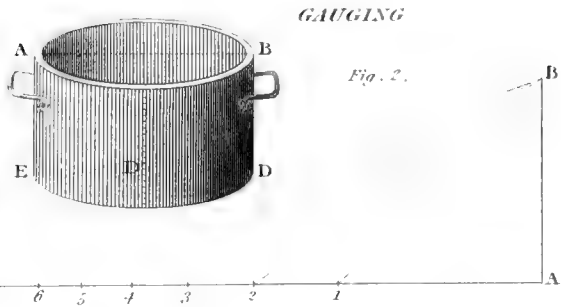
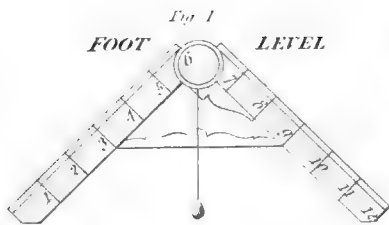


Fig. 1

1	2	3	4	5	6	7	8	9	10	11	12	13	14	15	16	17	18	19	20	21	22	23	24	25	26	27	28	29	30	31	32	33	34	35	36	37	38	39	40	41	42	43	44	45	46	47	48	49	50	51	52	53	54	55	56	57	58	59	60	61	62	63	64	65	66	67	68	69	70	71	72	73	74	75	76	77	78	79	80	81	82	83	84	85	86	87	88	89	90	91	92	93	94	95	96	97	98	99	100
---	---	---	---	---	---	---	---	---	----	----	----	----	----	----	----	----	----	----	----	----	----	----	----	----	----	----	----	----	----	----	----	----	----	----	----	----	----	----	----	----	----	----	----	----	----	----	----	----	----	----	----	----	----	----	----	----	----	----	----	----	----	----	----	----	----	----	----	----	----	----	----	----	----	----	----	----	----	----	----	----	----	----	----	----	----	----	----	----	----	----	----	----	----	----	----	----	----	----	-----

Barrel 36
Kilometer 12
Dixton 10

Artillery foot LEVEL

Artificers' LEVEL

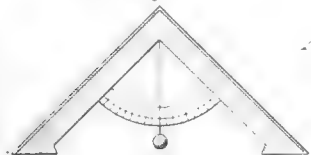


Fig. 6.

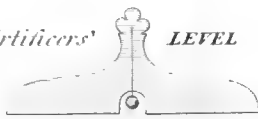


Fig. 5.

Gunners' LEVEL

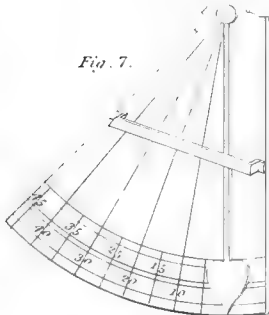


Fig. 7.

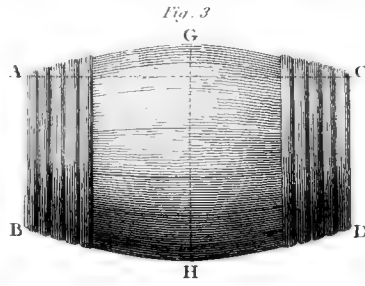


Fig. 3

Mercurial LEVEL



Fig. 8.

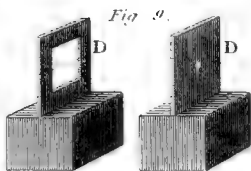


Fig. 9.

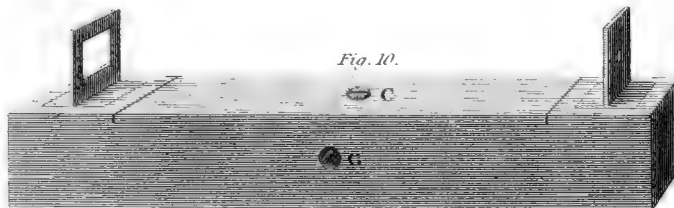


Fig. 10.



Fig. 11.

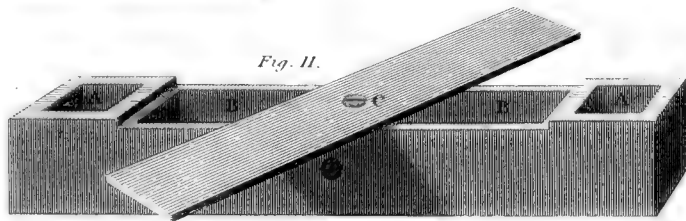
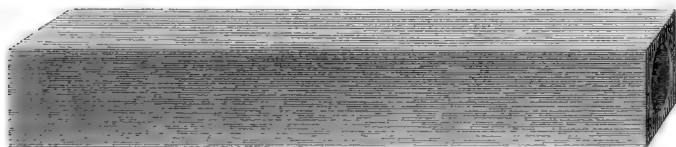
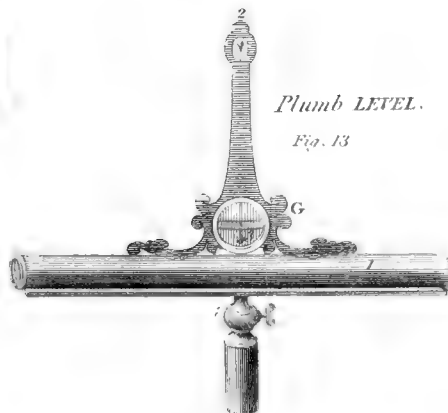


Fig. 12.



Plumb LEVEL.

Fig. 13



SURVEYING.

LEVELS,

by Mr. Ramsden.

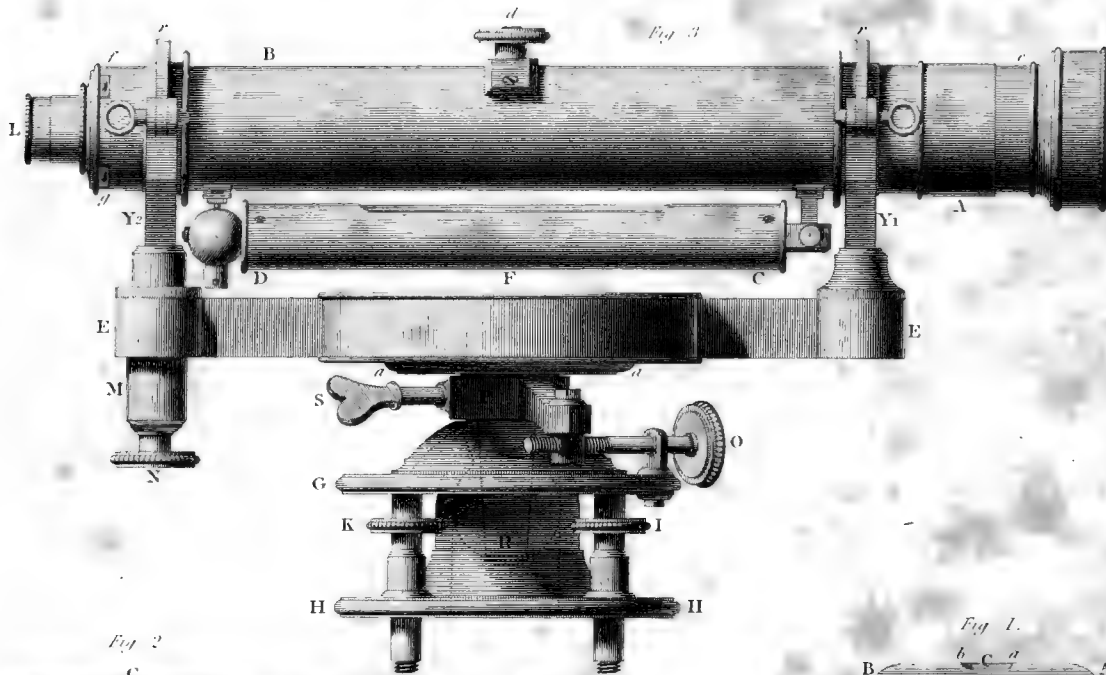


Fig. 3



Fig. 2

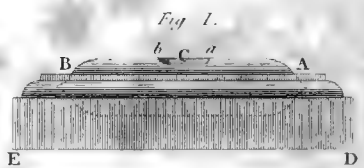
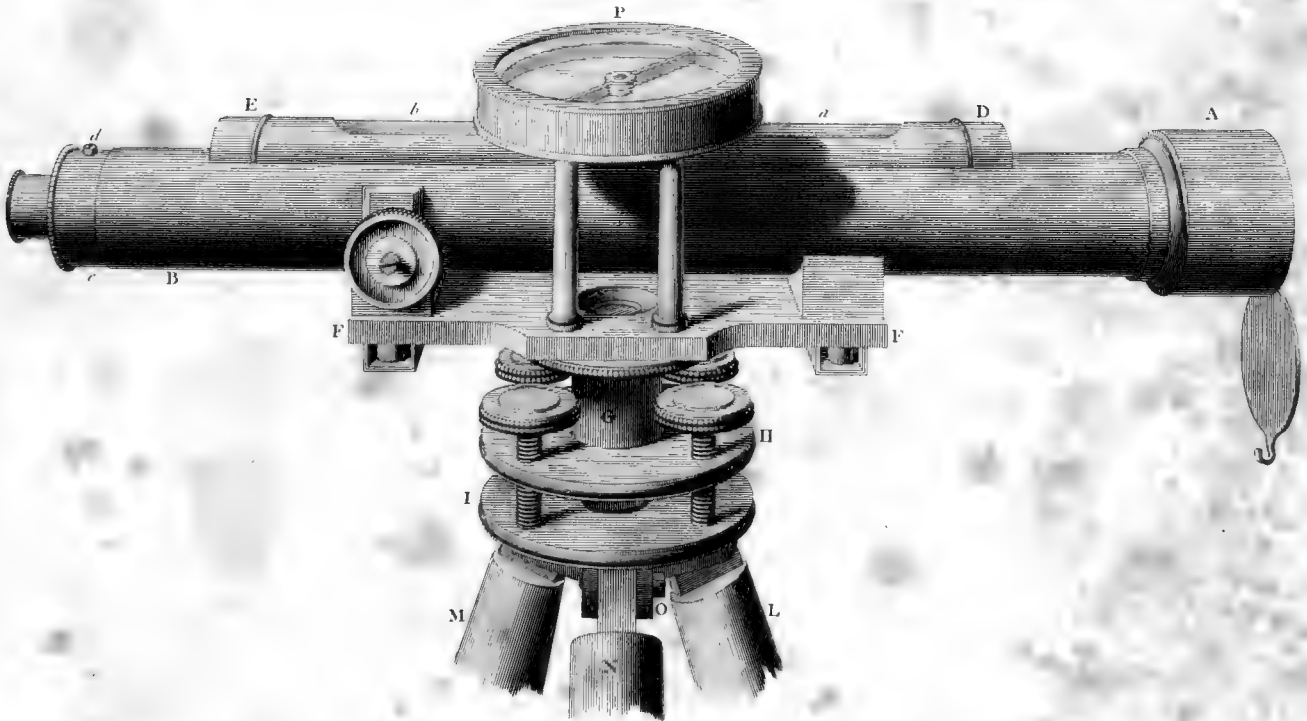


Fig. 1

Mr. Troughton's

Fig. 1.



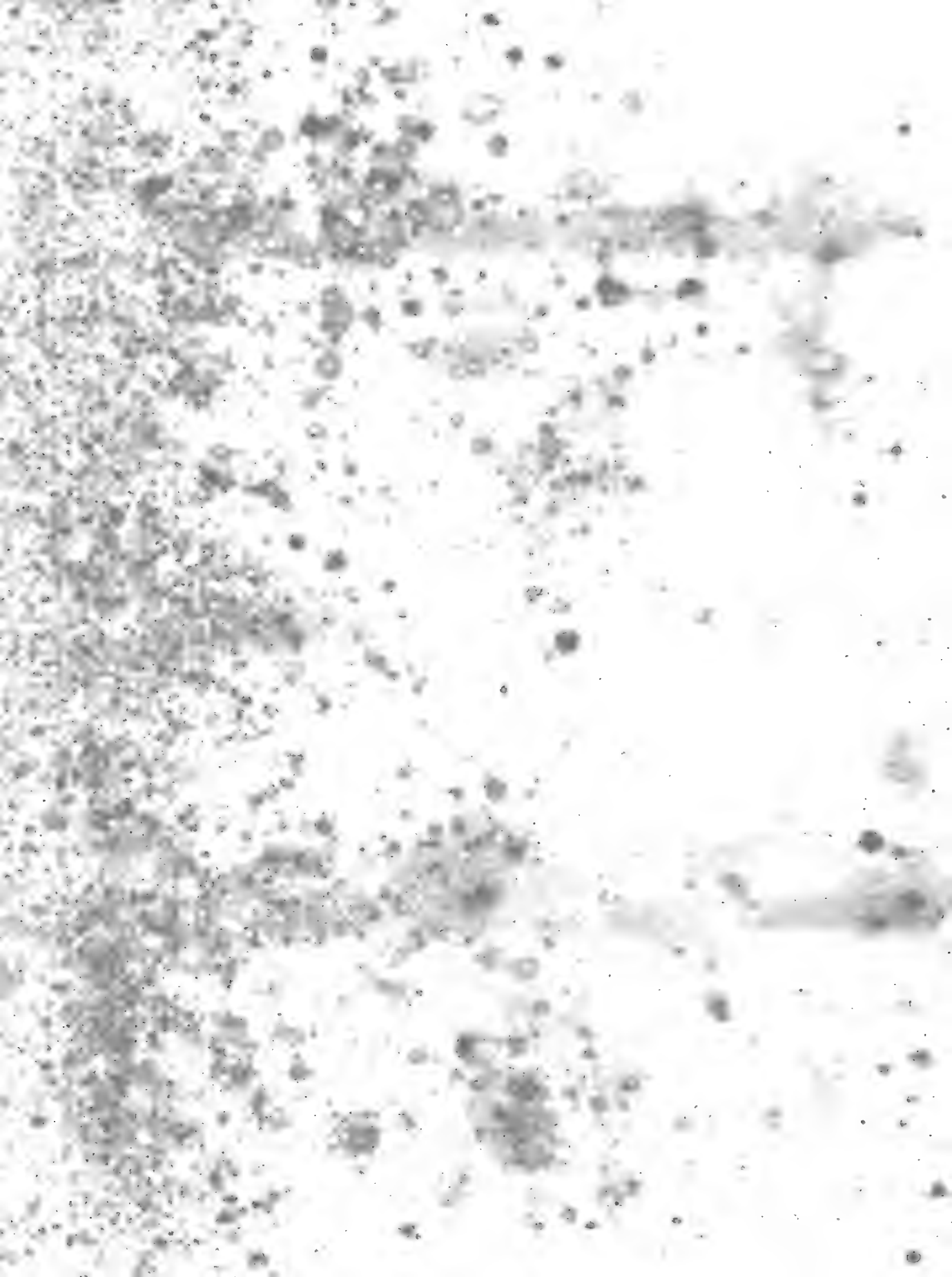


Fig. 1.

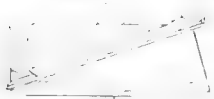


Fig. 2.

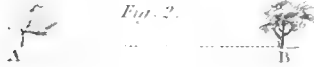


Fig. 3.



Fig. 4.

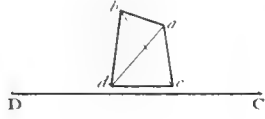
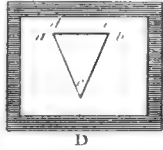
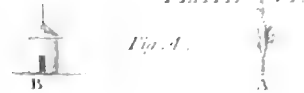


Fig. 6.

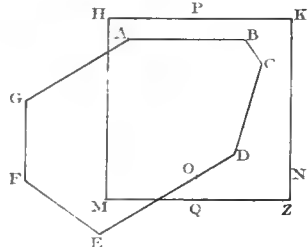


Fig. 12.

Fig. 7.

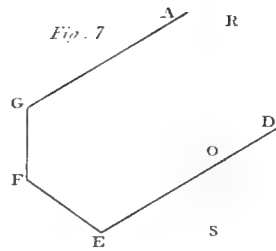
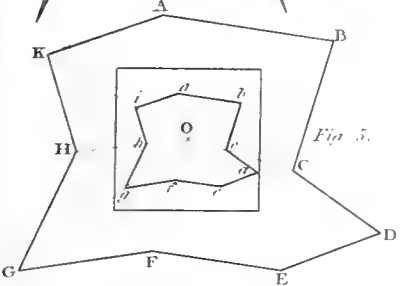


Fig. 5.



PERAMBULATOR

Fig. 10.

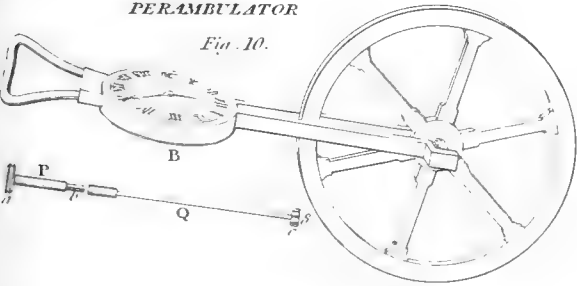
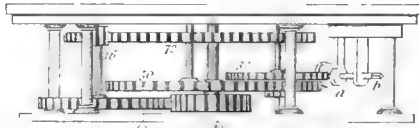
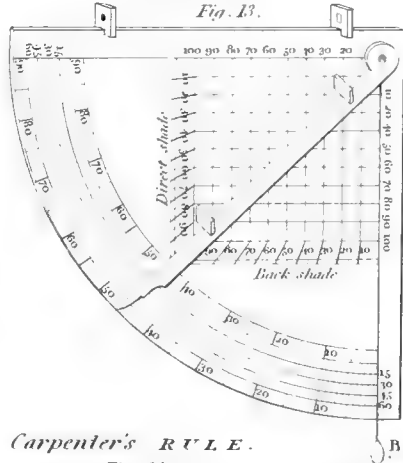


Fig. 9.

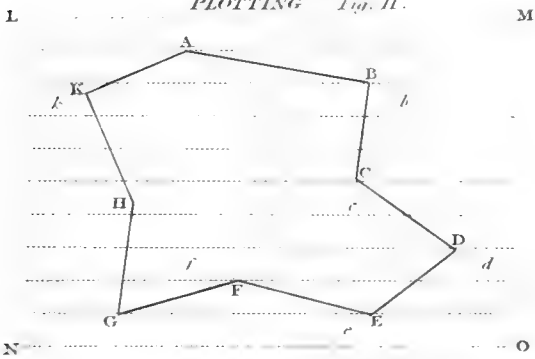


QUADRANT

Fig. 13.



PLOTTING Fig. 11.



Carpenter's R U L E.

Fig. 14.



PLOTTING SCALE.

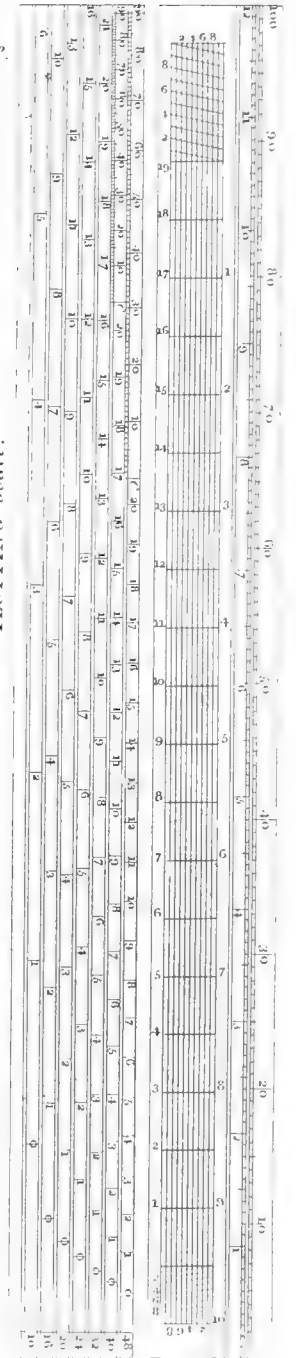
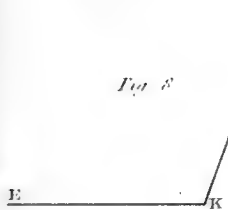
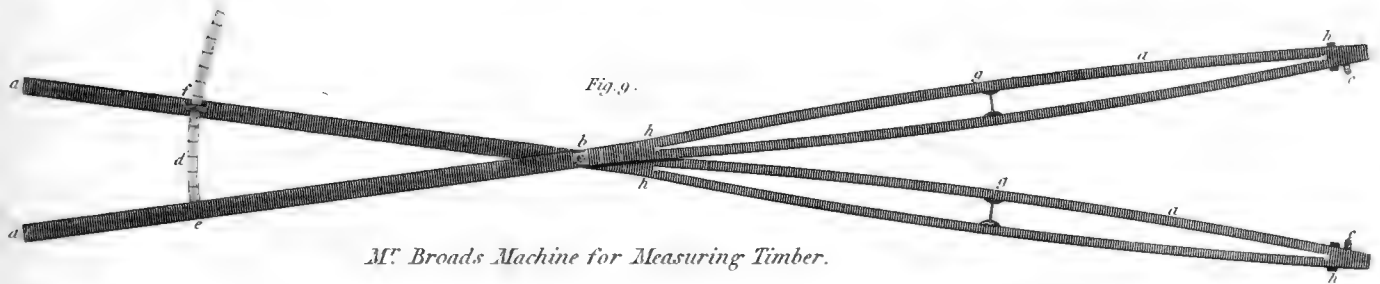
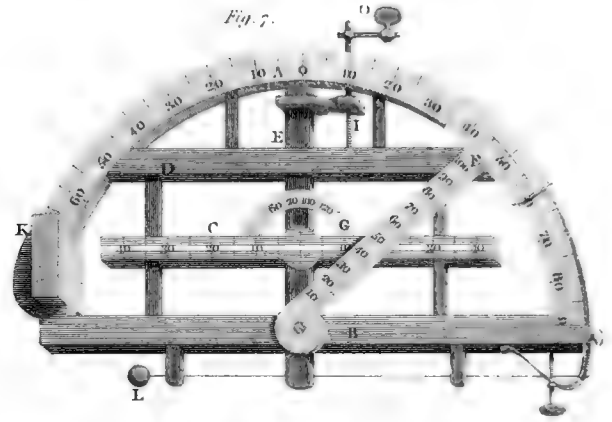
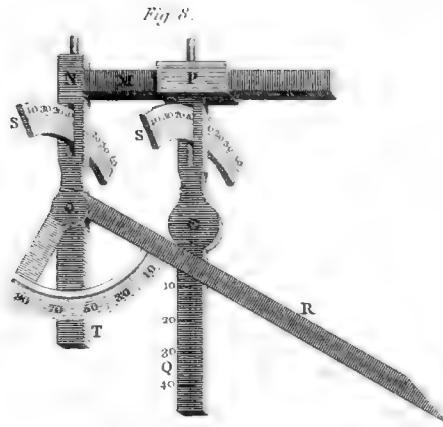


Fig. 8.



SURVEYING.
DENDROMETERS.



Mr. Broads Machine for Measuring Timber.

Fig. 11.

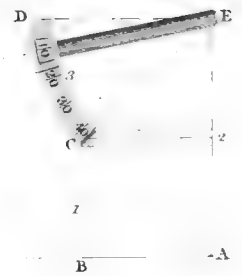
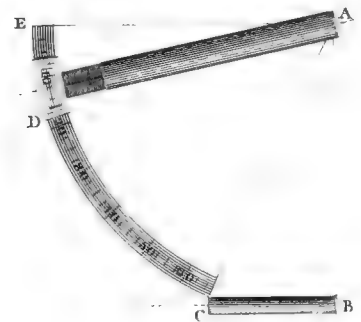


Fig. 10.



SURVEYING.
LEVELLING.

Fig 1.

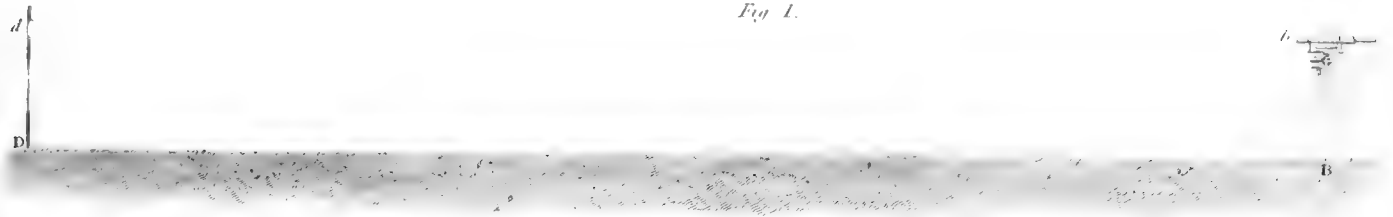


Fig 2.

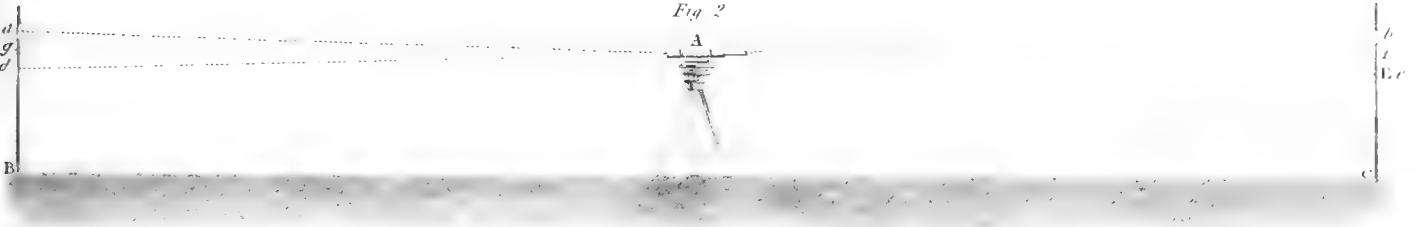


Fig 4.

Fig 5.

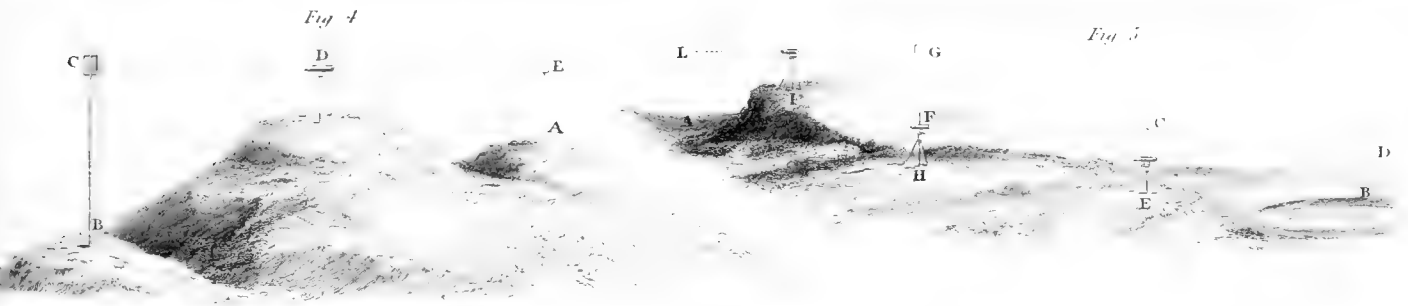


Fig 7.

Fig 8.

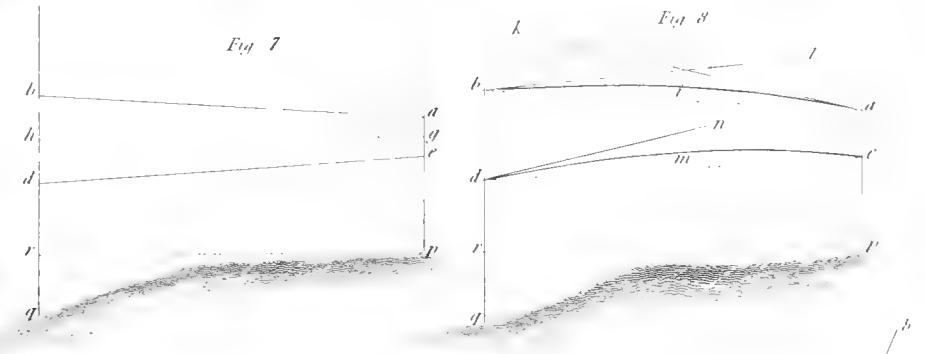


Fig 6.

Fig 9.

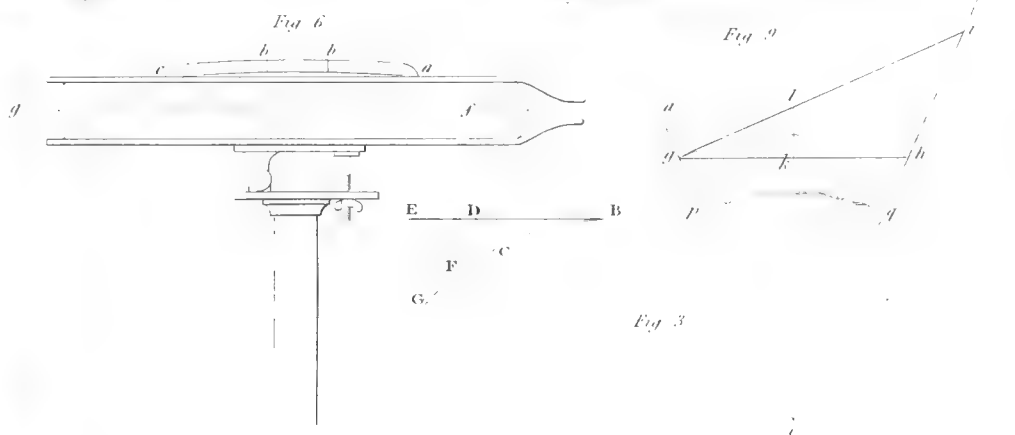
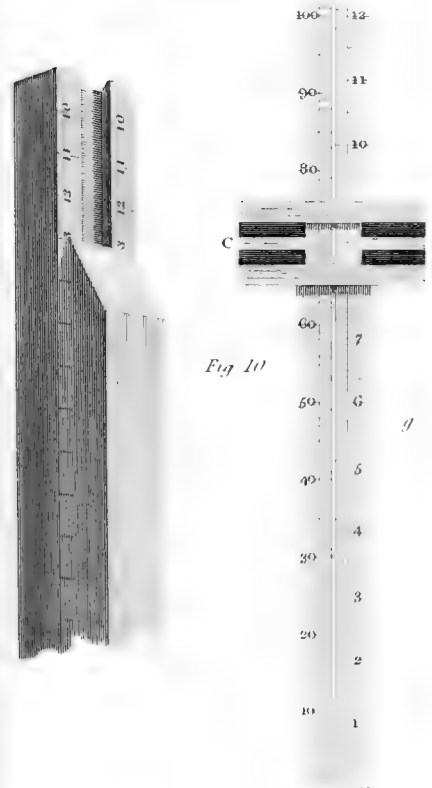


Fig 10.



SURVEYING.

D^r Rogel's SLIDING Rule

Fig 9

SECTOR

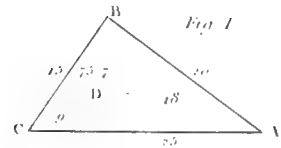


Fig 1

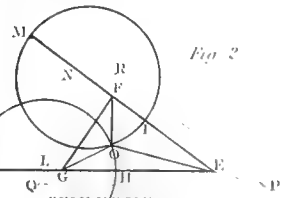
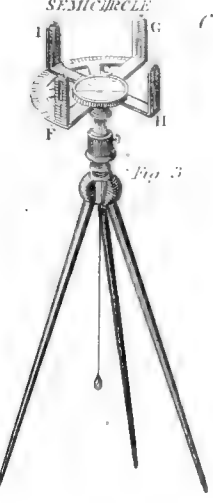


Fig 2



Coggshall's SLIDING Rule

Fig 3

Everard's SLIDING Rule

Fig 4

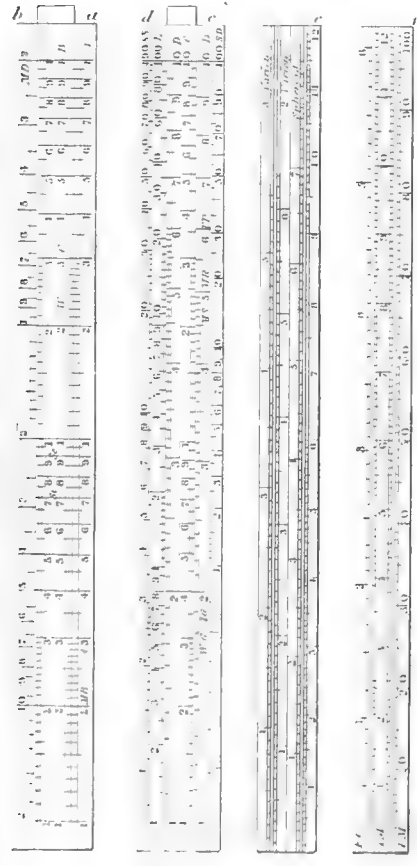
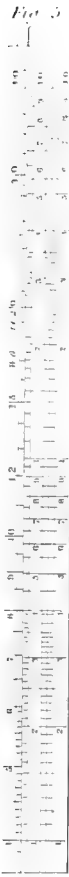


Fig 6

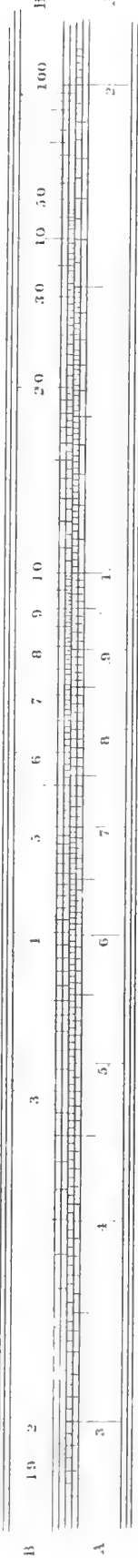


Fig 7

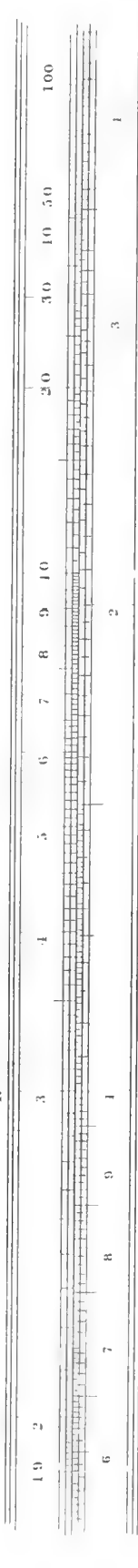
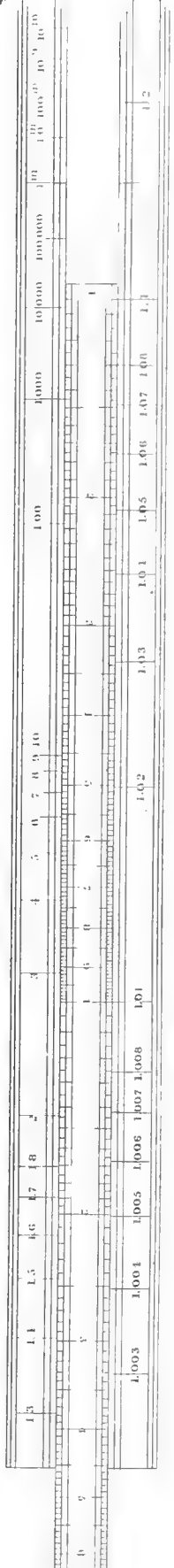
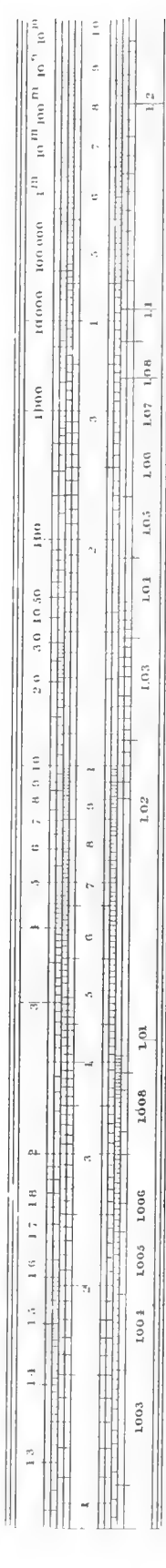
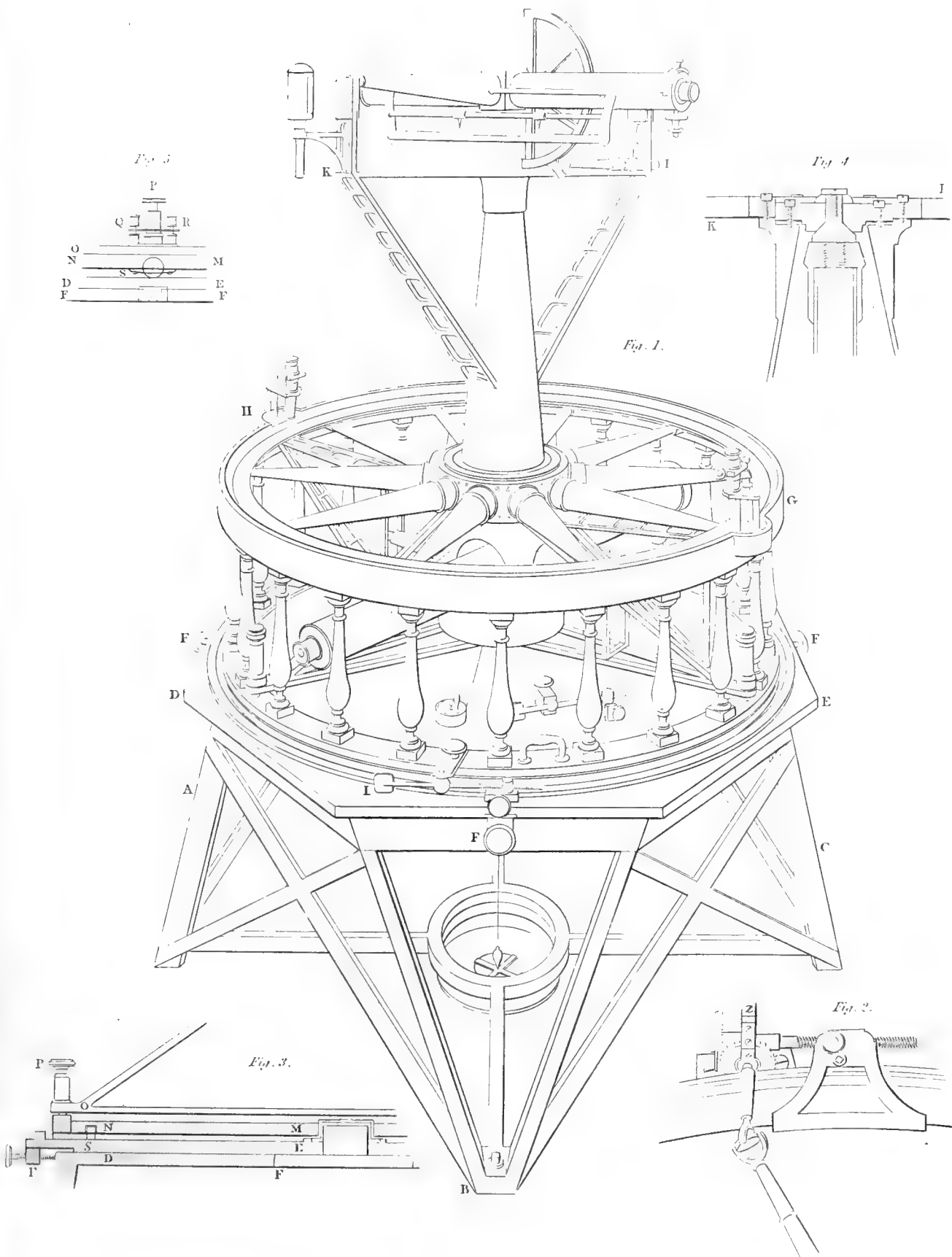


Fig 8



Grand THEODOLITE by Ramsden.



SURVEYING.

Portable THEODOLITE by Troughton.

PLATE IX.

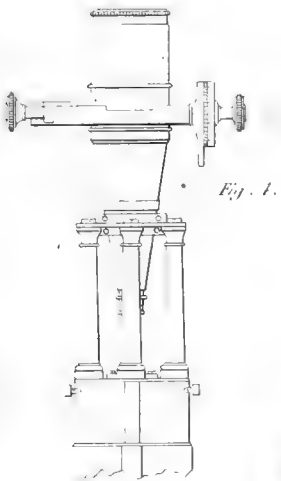


Fig. 1.

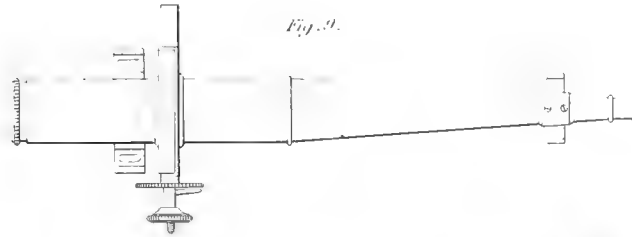


Fig. 2.

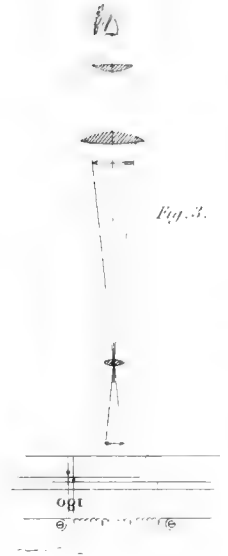


Fig. 3.

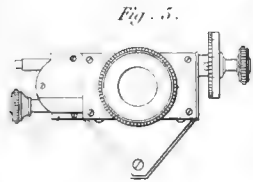


Fig. 5.

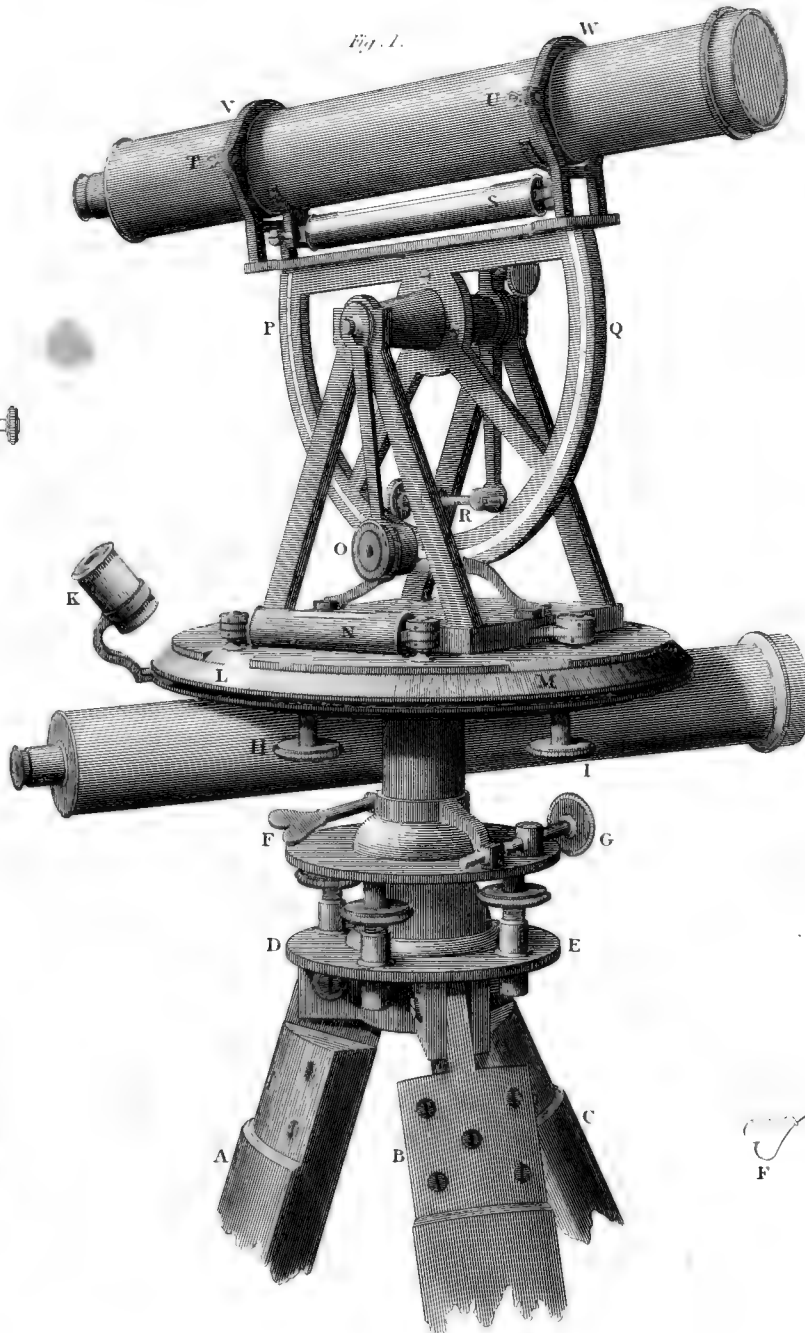


Fig. 4.

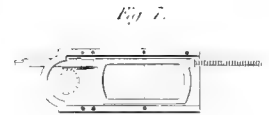


Fig. 7.

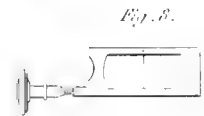


Fig. 8.



Fig. 6.

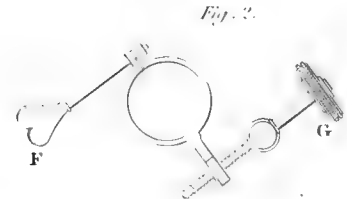
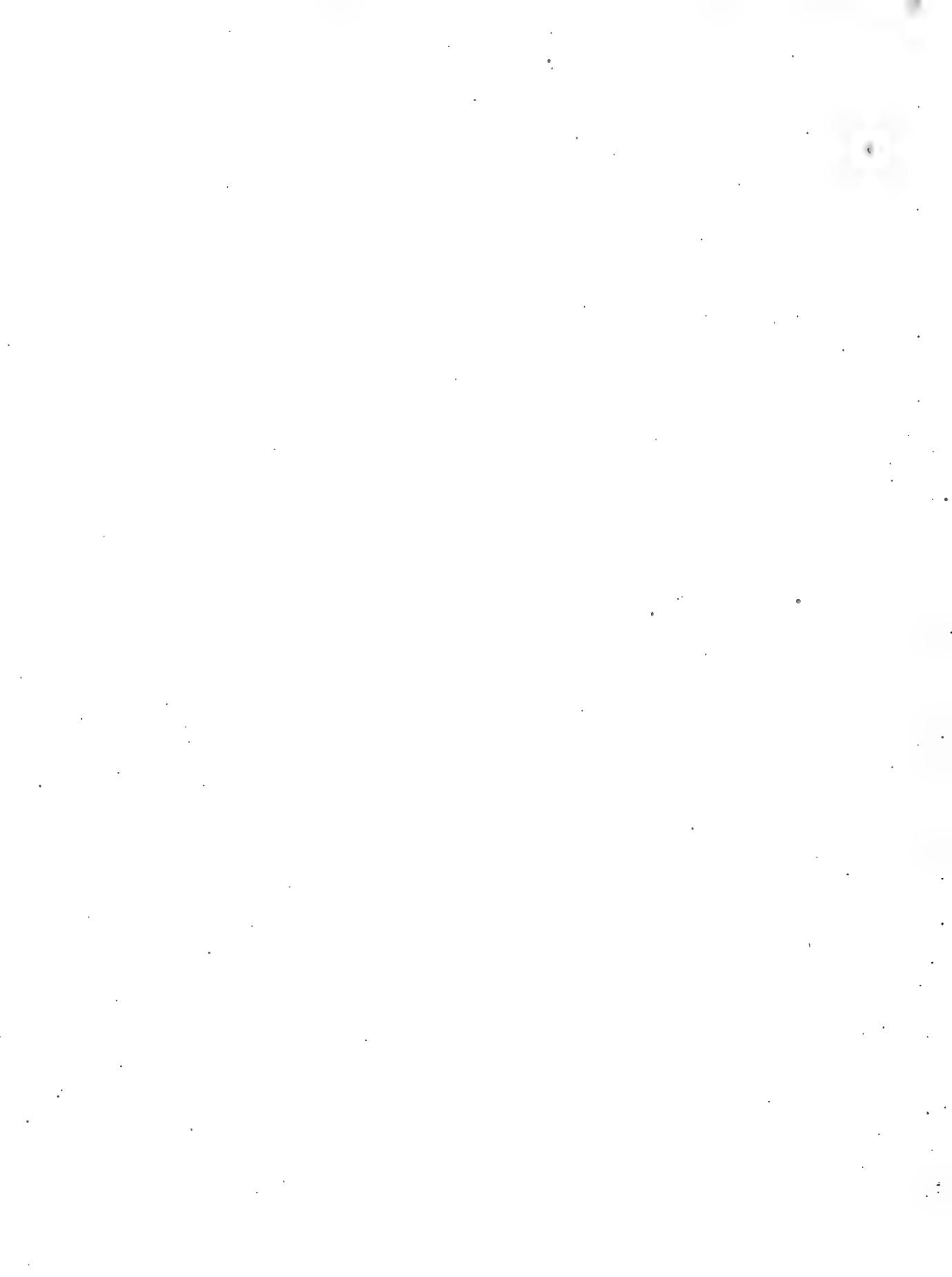


Fig. 9.



TELEGRAPH

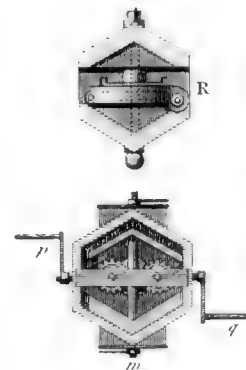
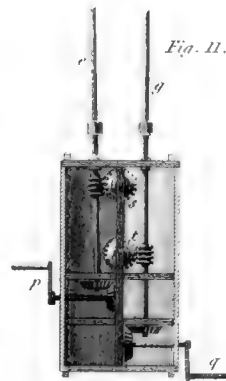
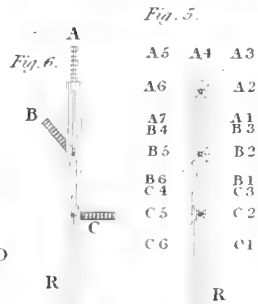
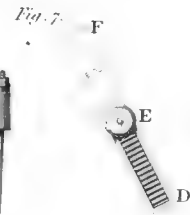
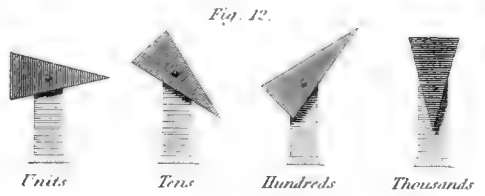
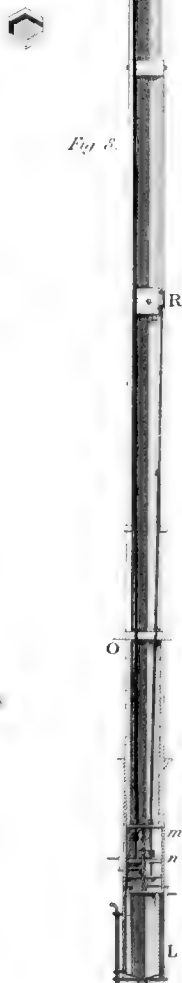
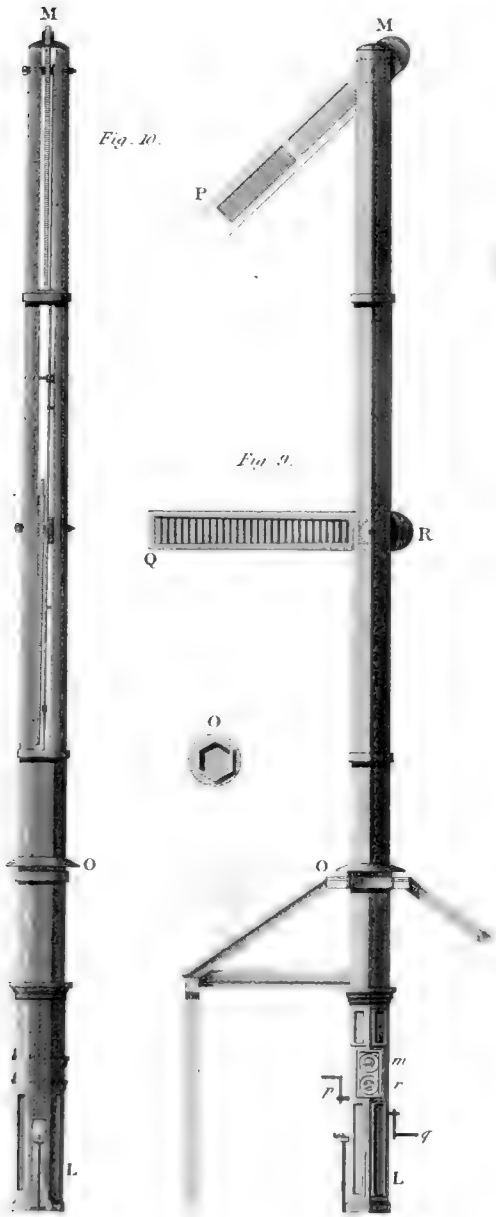
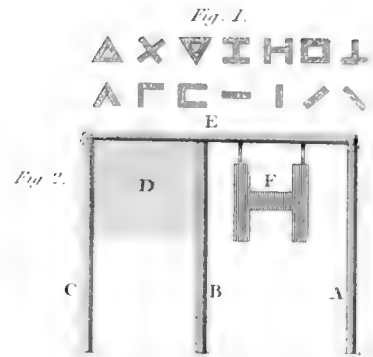
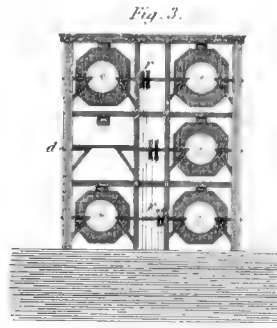
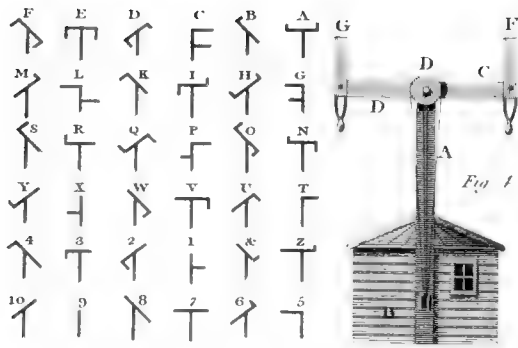
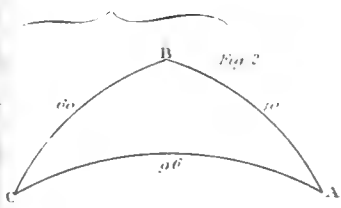
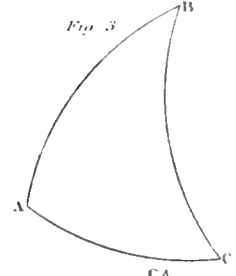


Fig 1



PART



SECANT & SINE

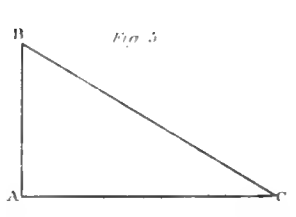
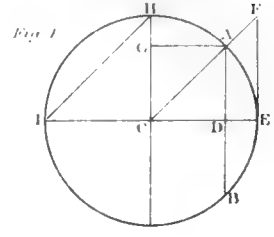


Fig 6

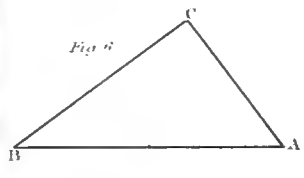
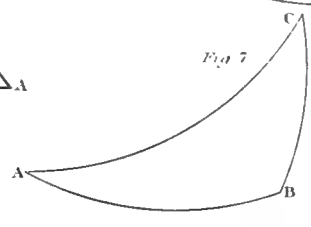
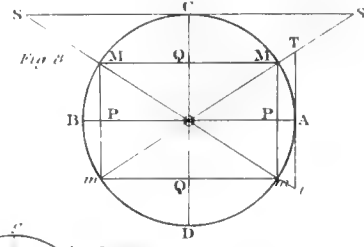


Fig 7



ARITHMETIC



OF SINES

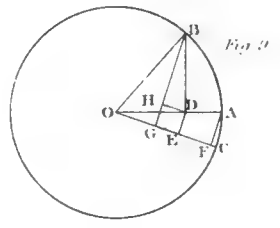


Fig 10

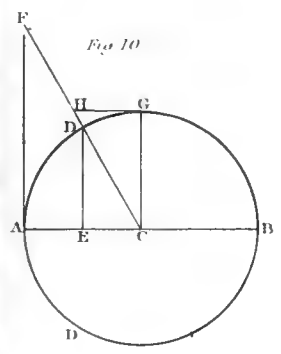
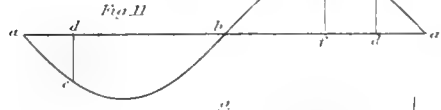
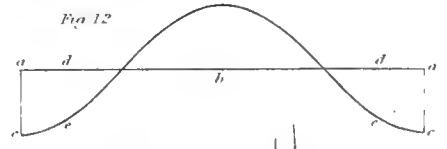


FIG OF SINES

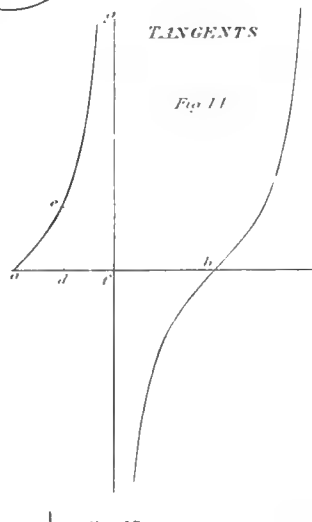


COSINES



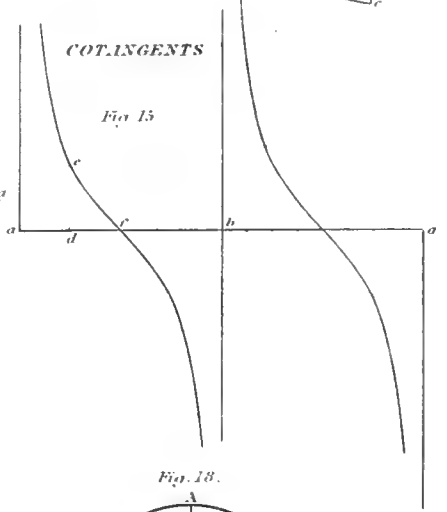
TANGENTS

Fig 11



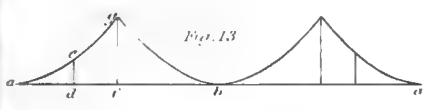
COTANGENTS

Fig 15



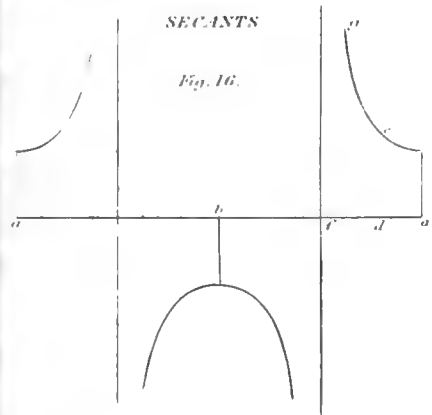
VERSED SINES

Fig 13



SECANTS

Fig 16



COSECANTS

Fig 17

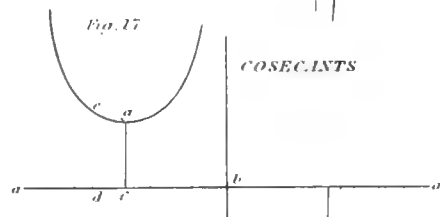


Fig 18

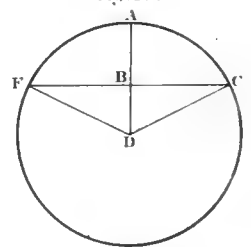


Fig 19

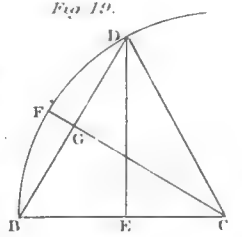


Fig 20

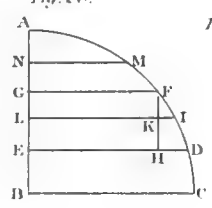


Fig 21

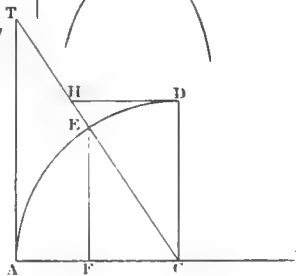
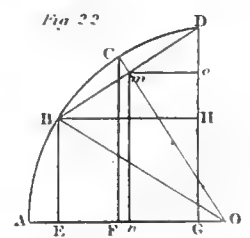
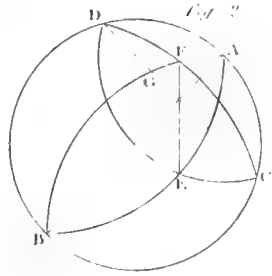
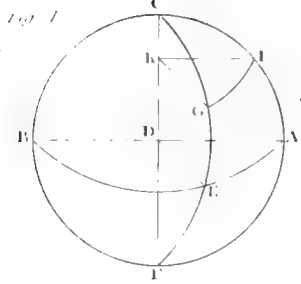


Fig 22



SPHERICAL Angle



SPHERICAL Triangle

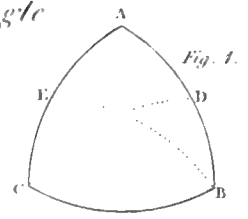
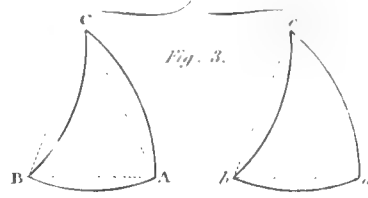


Fig. 5

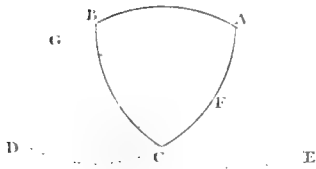


Fig. 6

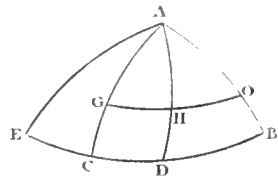


Fig. 7

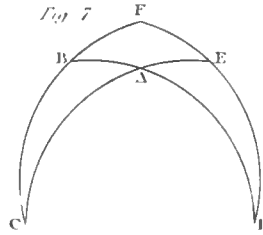
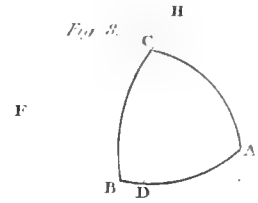


Fig. 8



SPHERICS

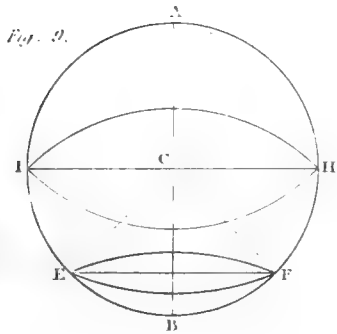


Fig. 10

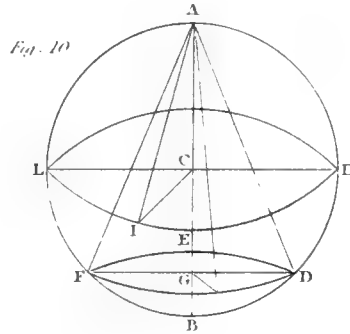
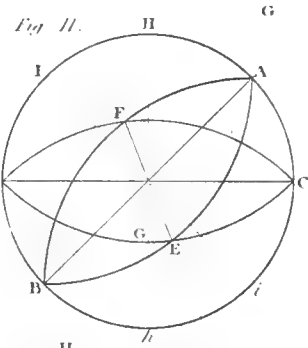


Fig. 11



TANGENT

TRIGONOMETRY

Fig. 12

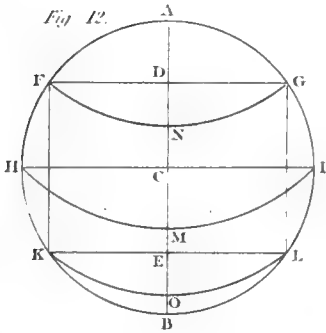


Fig. 13

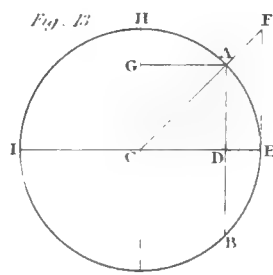


Fig. 14

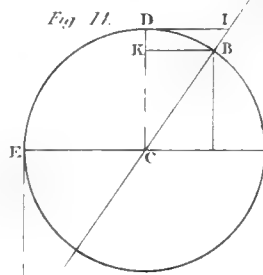


Fig. 15

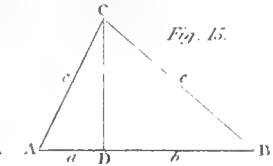


Fig. 16

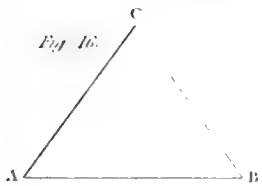


Fig. 17

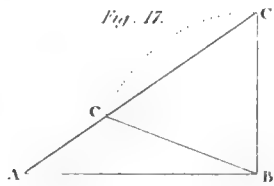


Fig. 18

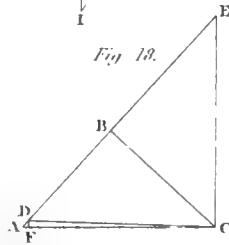


Fig. 19

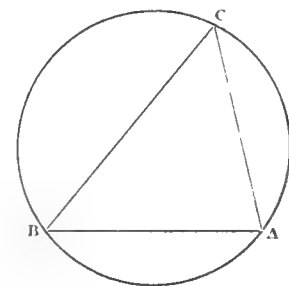


Fig. 20

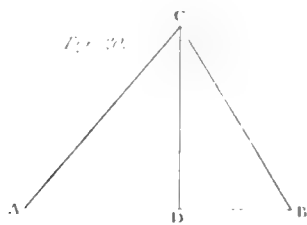


Fig. 21

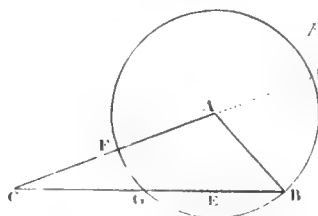
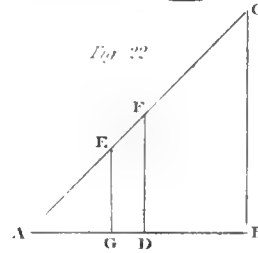
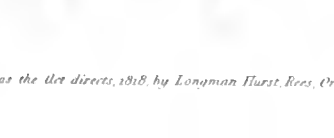
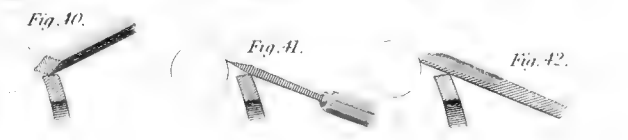
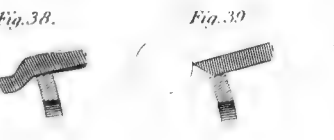
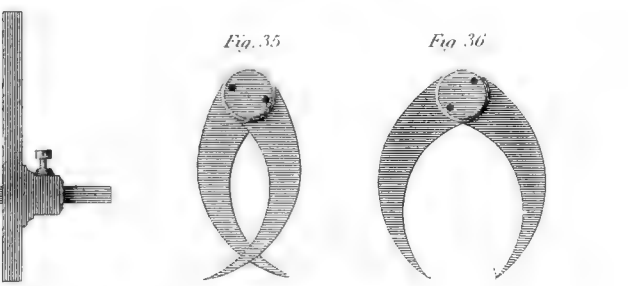
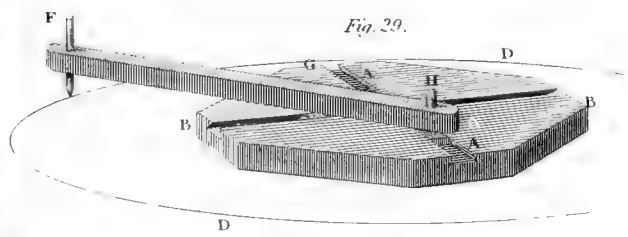
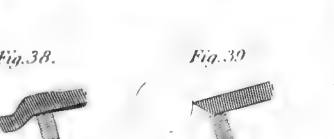
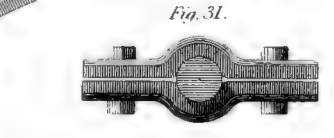
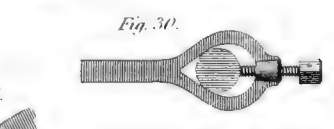
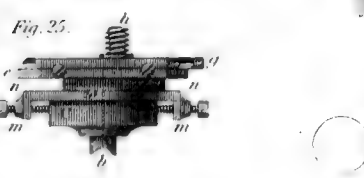
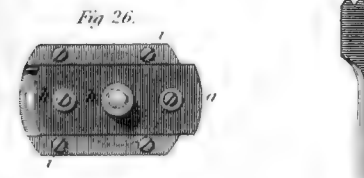
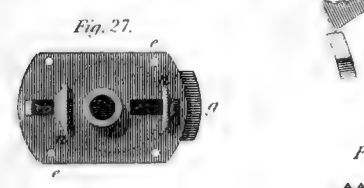
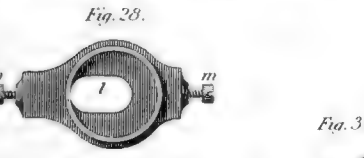
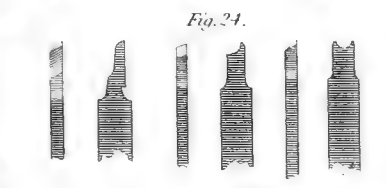
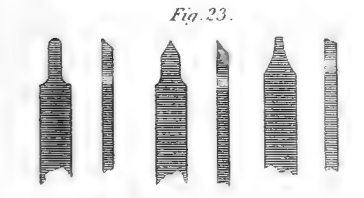
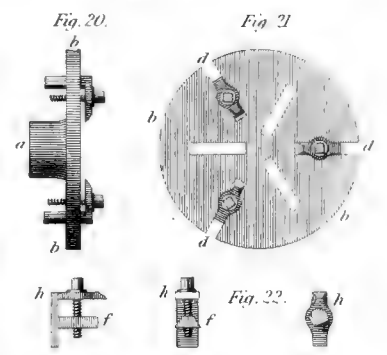
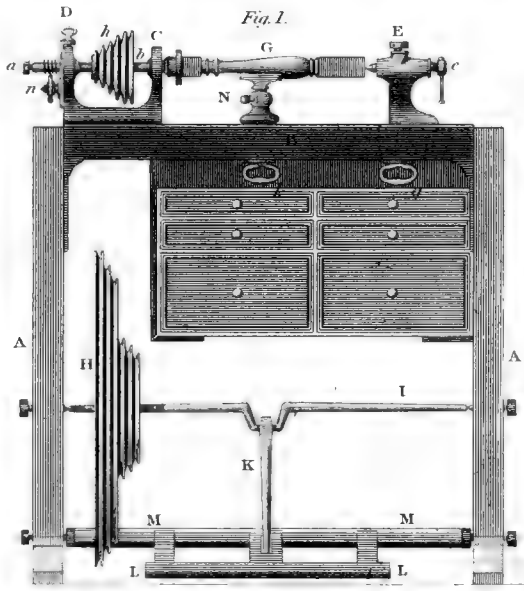
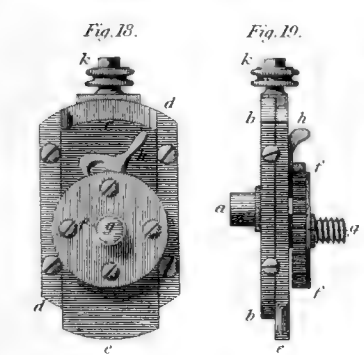
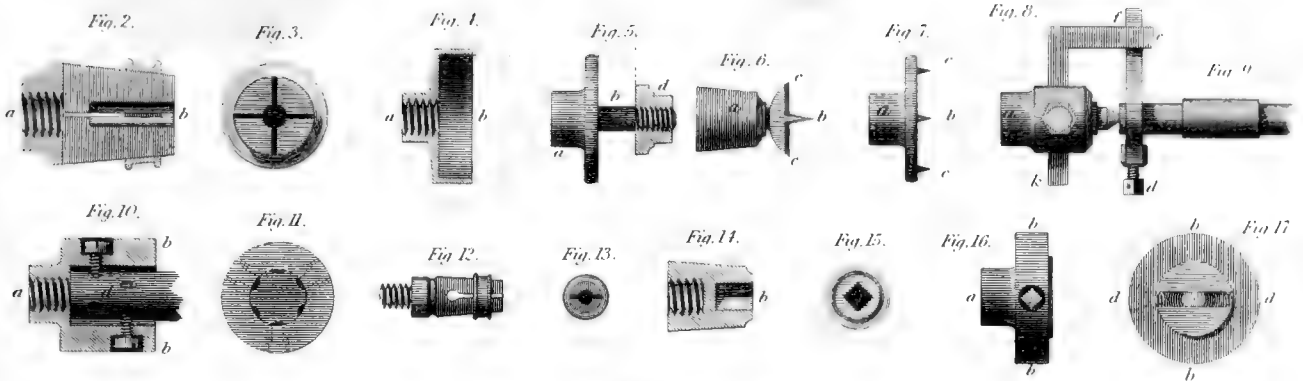
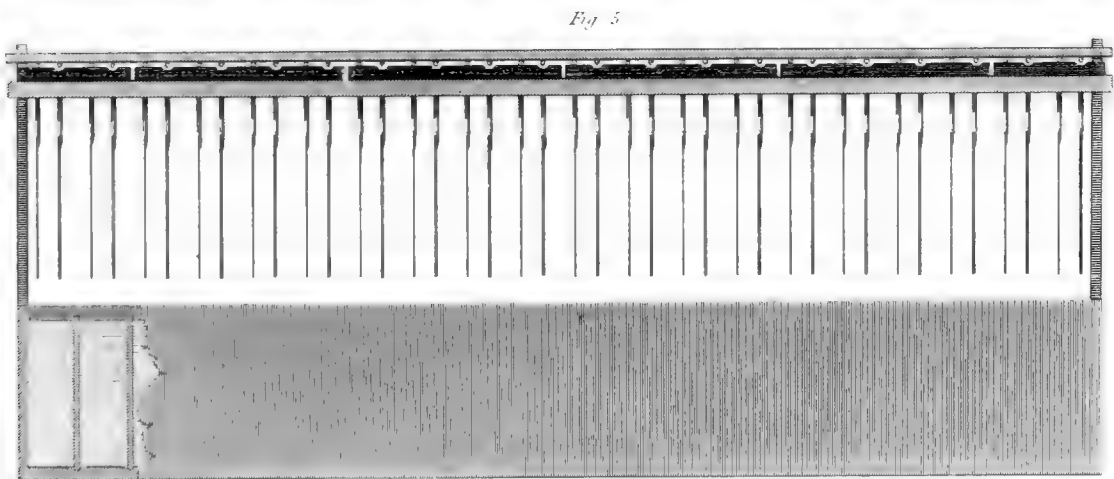
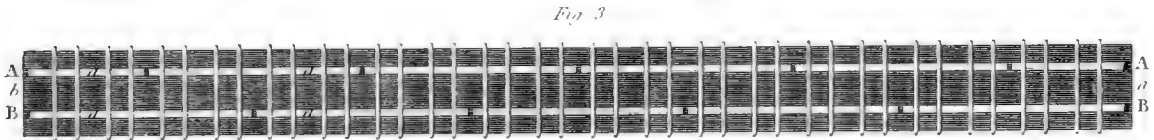
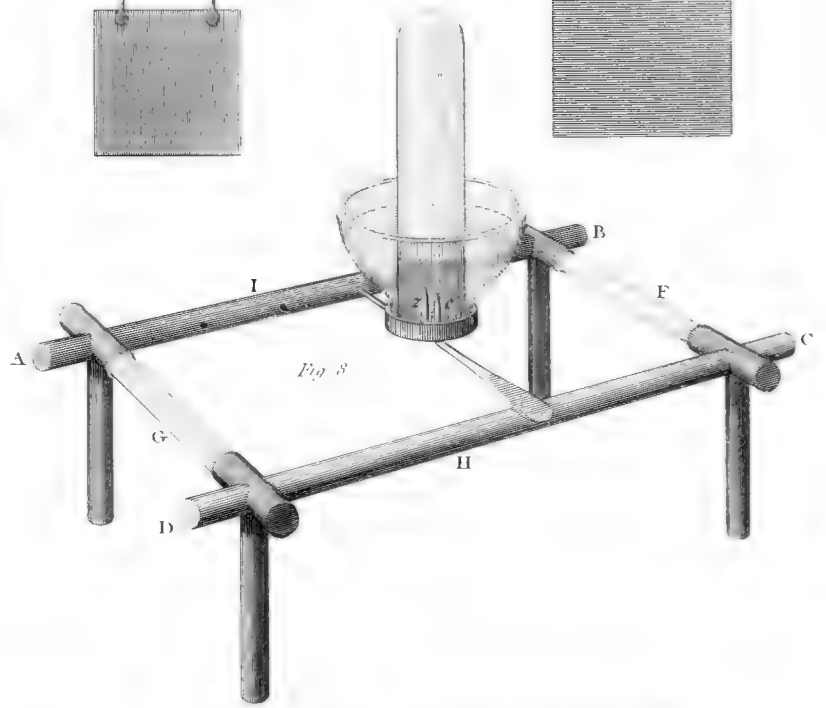
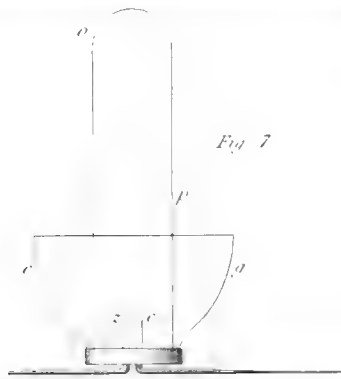
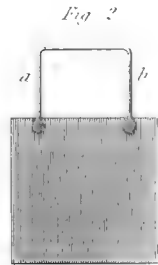
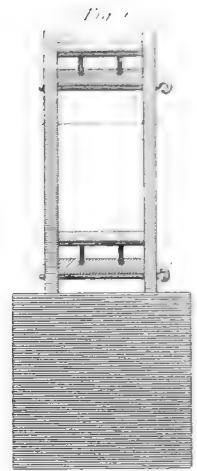
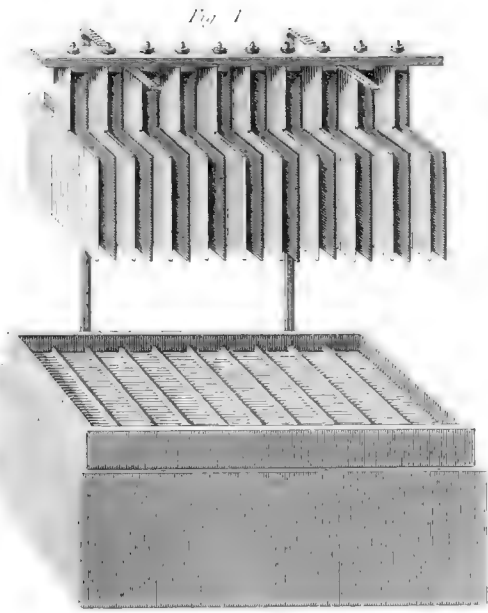


Fig. 22









WATER WHEELS.
OVER SHOT and UNDER SHOT.

Fig. 2.

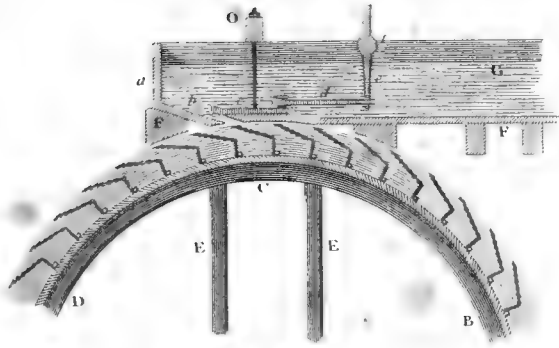


Fig. 1.

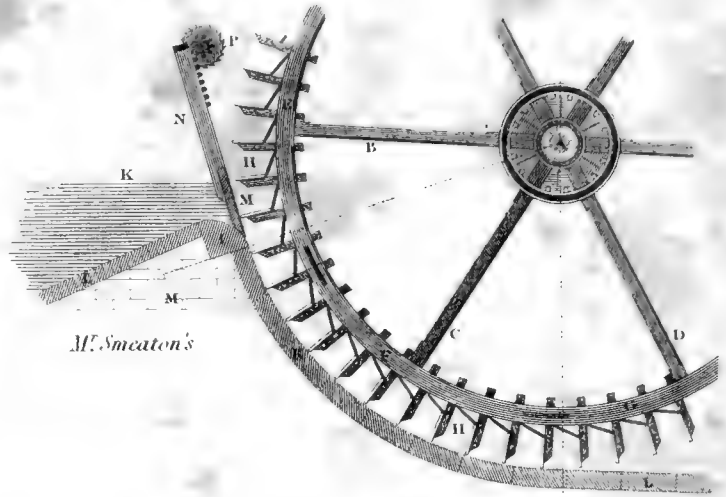


Fig. 4.

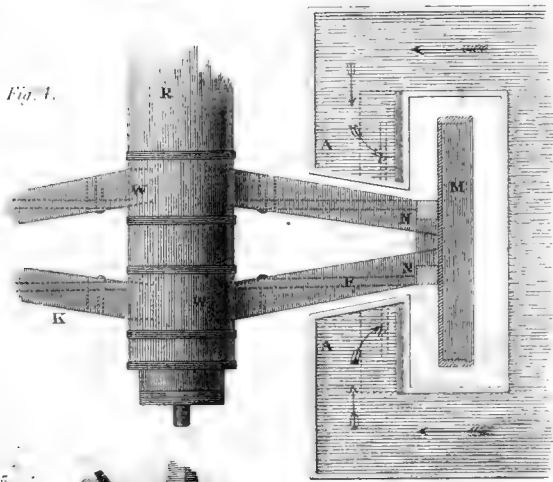


Fig. 3.

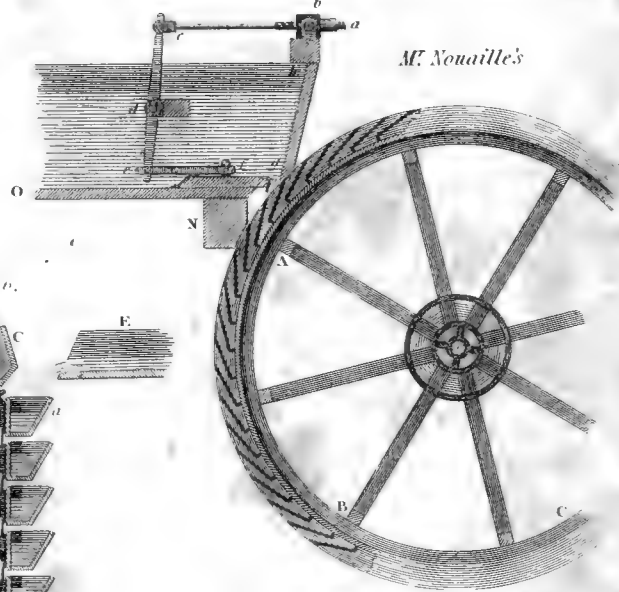


Fig. 6.



Fig. 7.

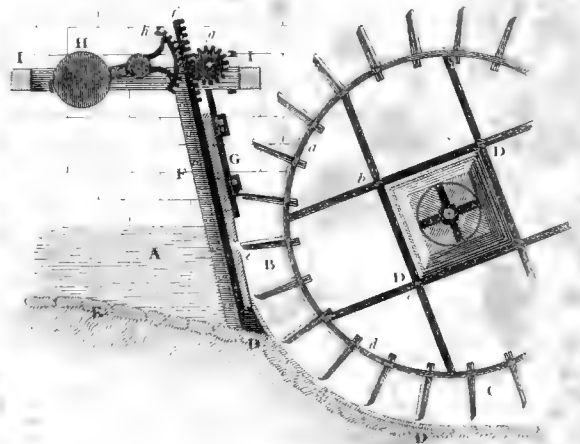


Fig. 5.

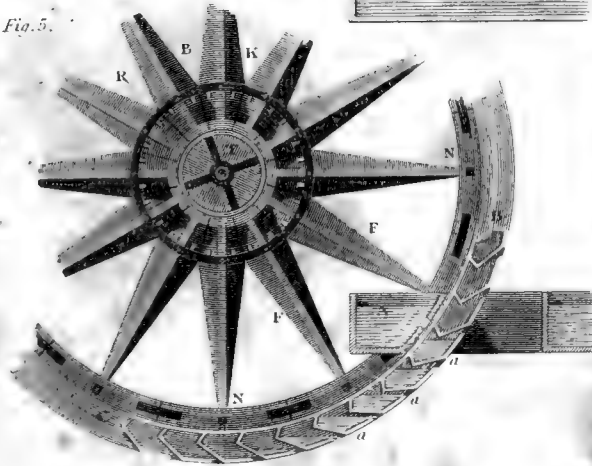
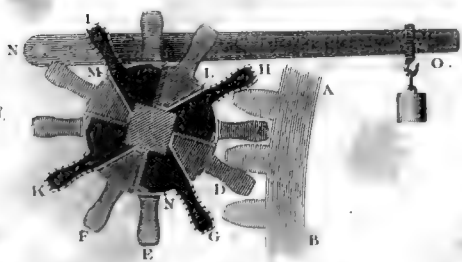


Fig. 8.





Breast WHEEL with two Shuttles.

Fig. 3.

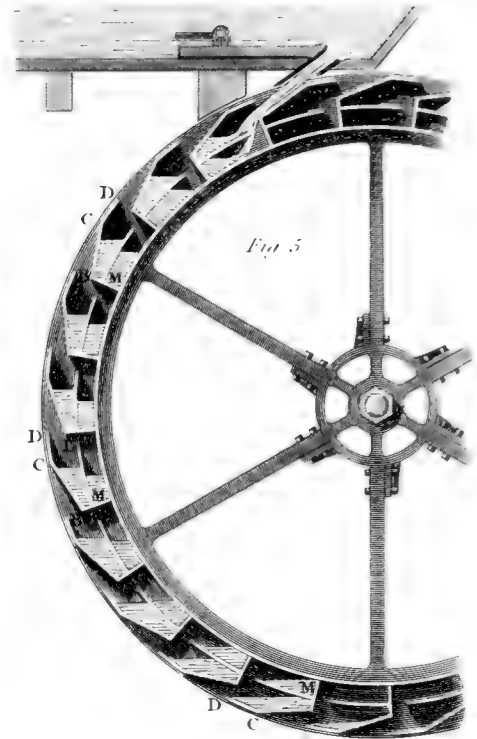
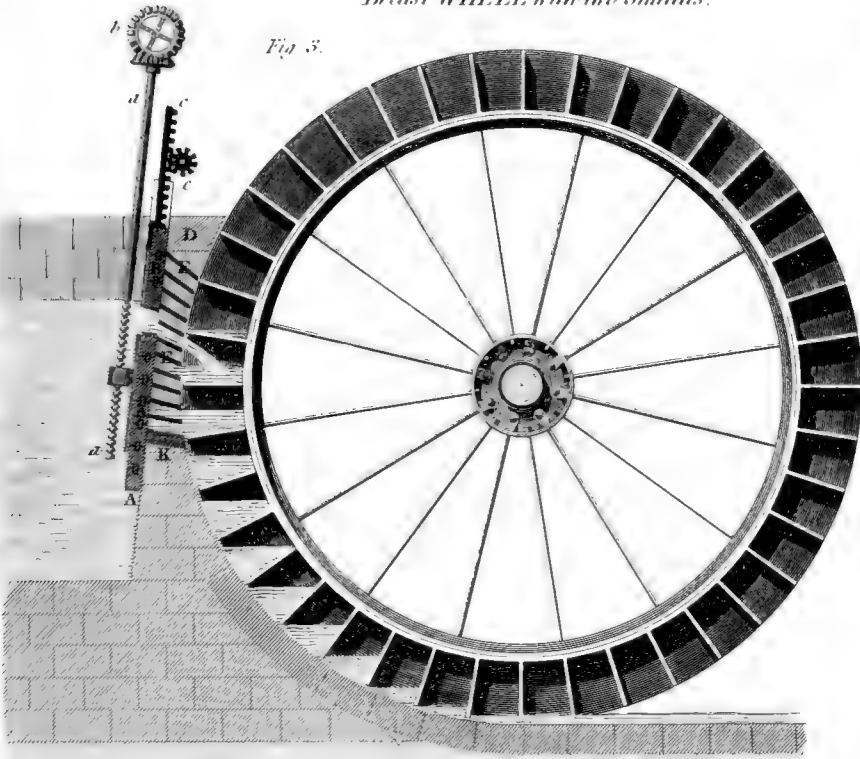


Fig. 5.

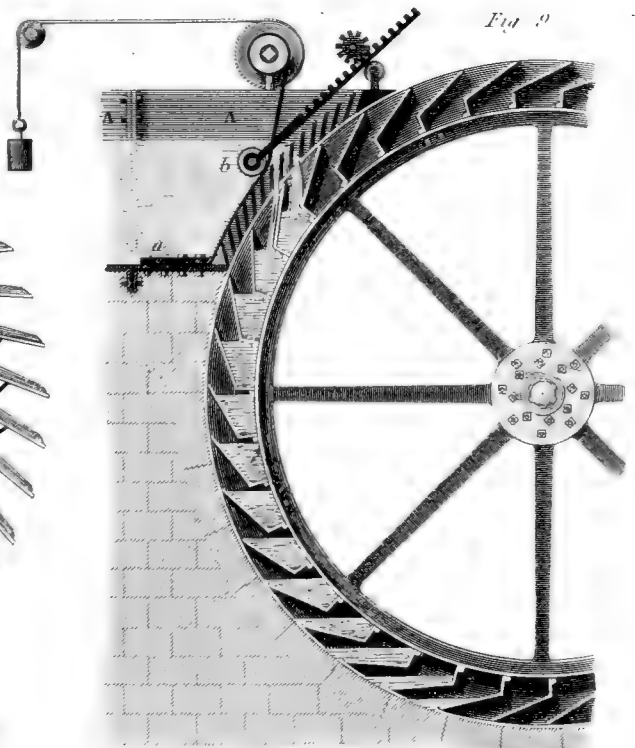
Breast WHEEL in which the water flows over the Shuttle.

Fig. 4.



Overshot WHEEL.

Fig. 2.





WATER WORKS.

Machines for raising Water.

Fig. 1.

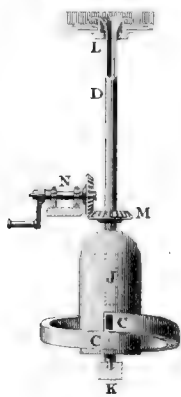


Fig. 3.

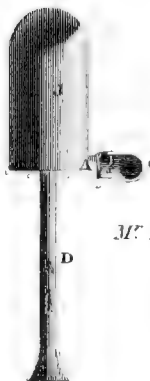
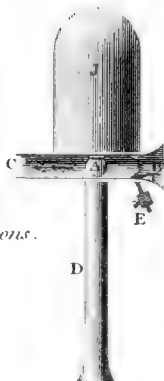


Fig. 2.



M^r Boultons.

R

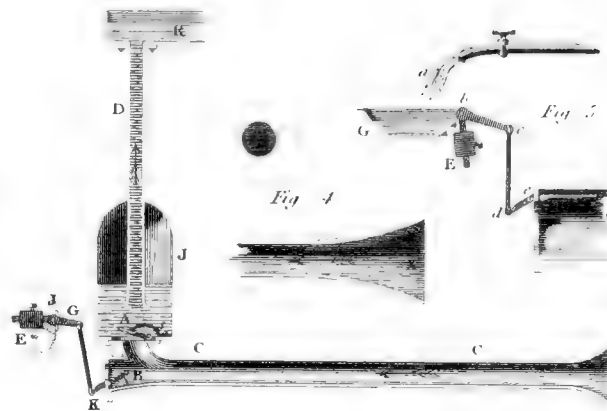


Fig. 4.

Fig. 5.

Fig. 6.

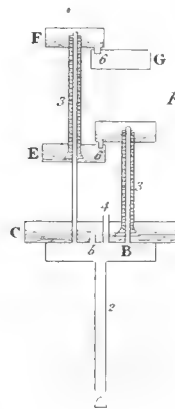


Fig. 8.

M^r Whitehursts.

Fig. 7.

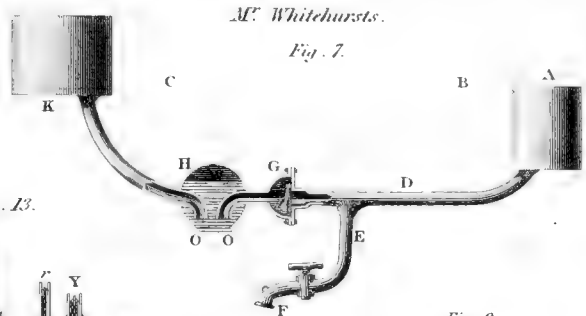


Fig. 10.

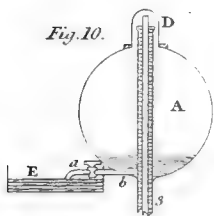


Fig. 13.

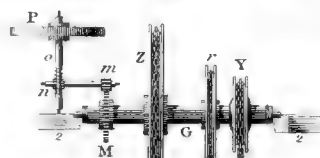
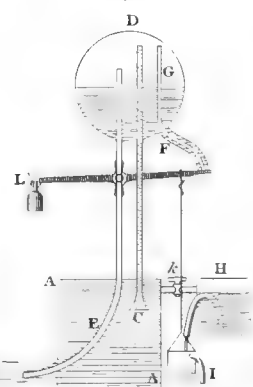


Fig. 9.



Chemnitz Fountain.

Fig. 14.

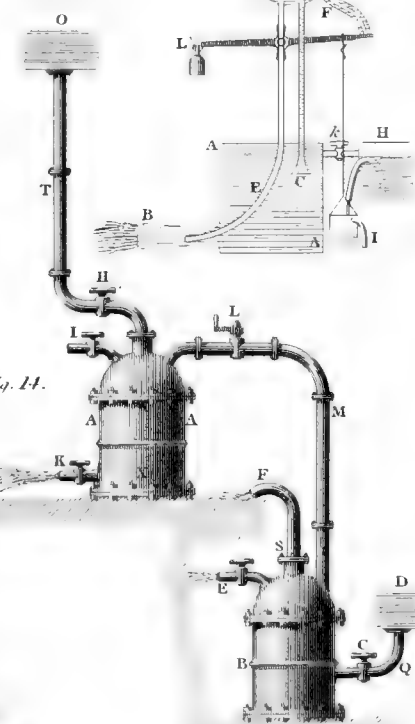


Fig. 12.

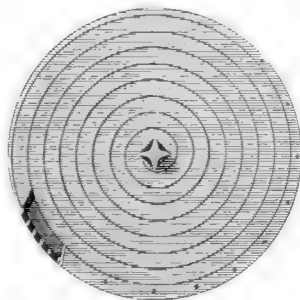
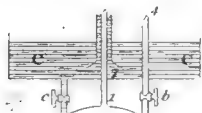
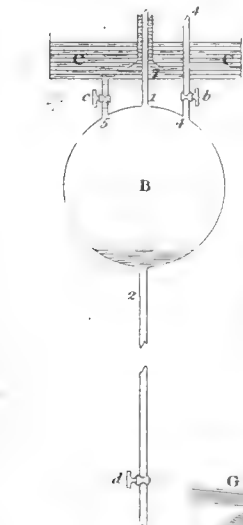
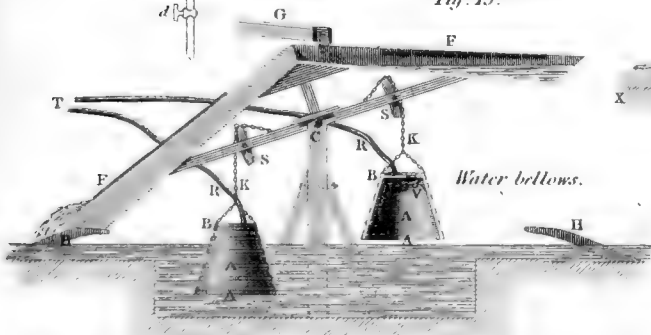


Fig. 15.



Water bellows.



MACHINE for raising WATER at London Bridge.

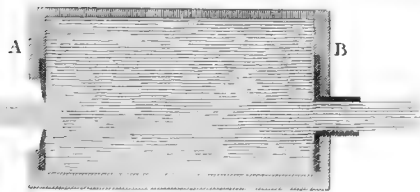
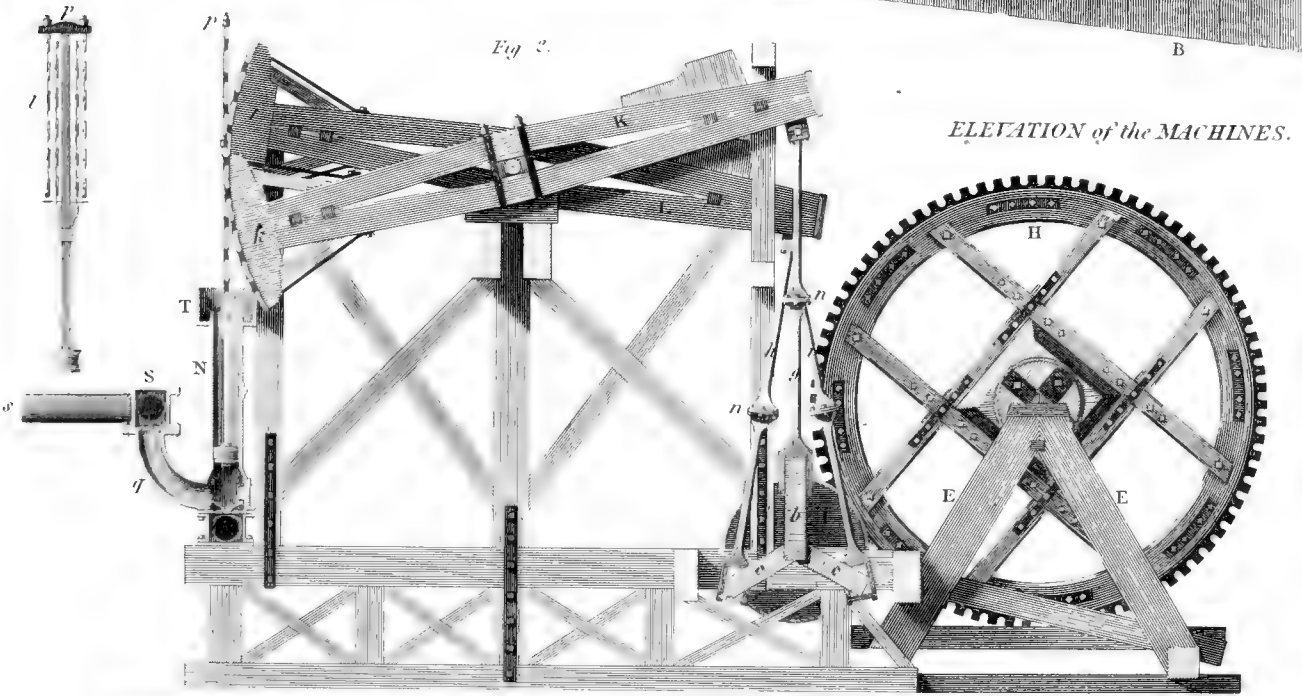
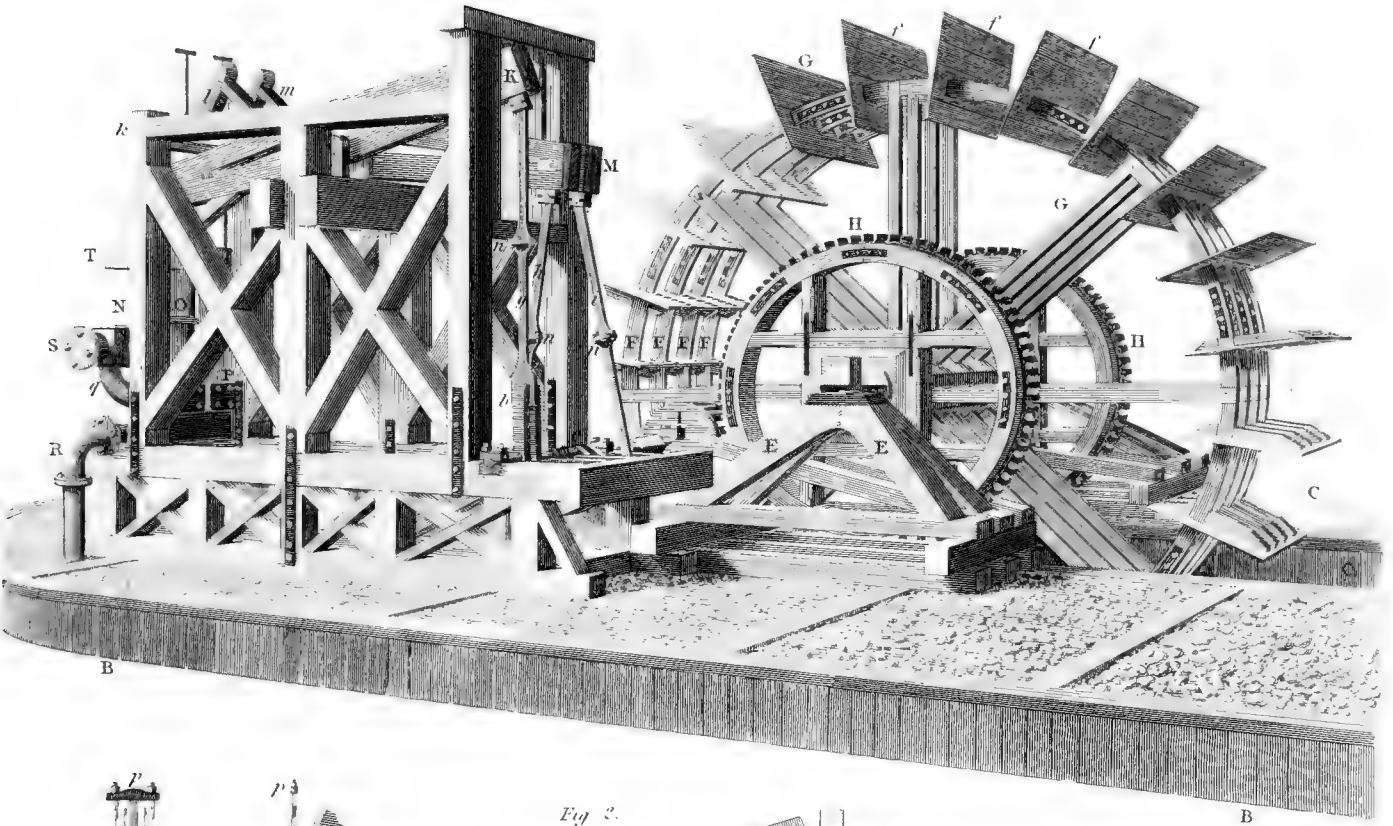


Fig. 8.

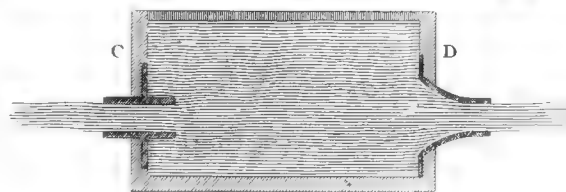


Fig. 2

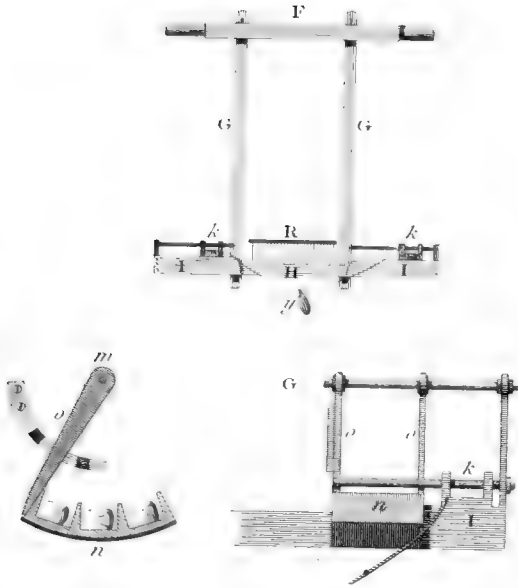
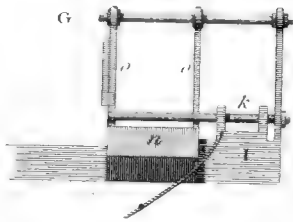


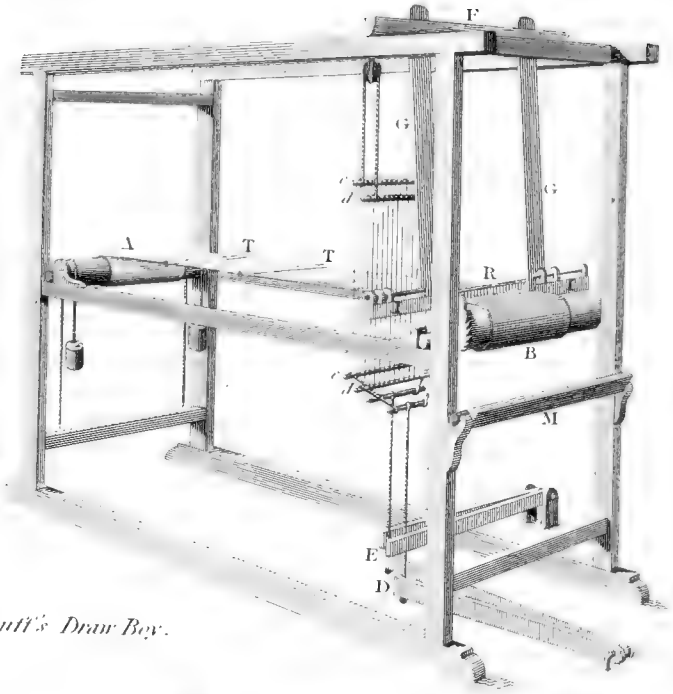
Fig. 3



H

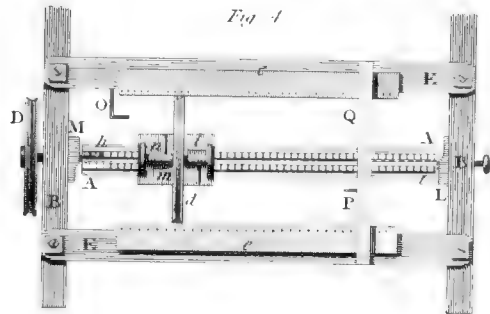


Fig. 1.



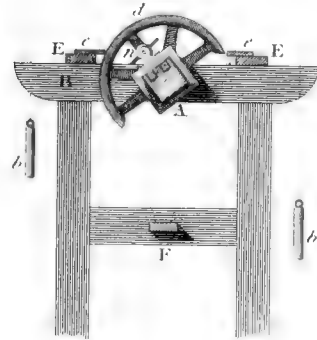
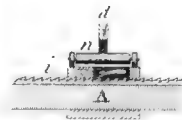
Duff's Draw Boy.

Fig. 4

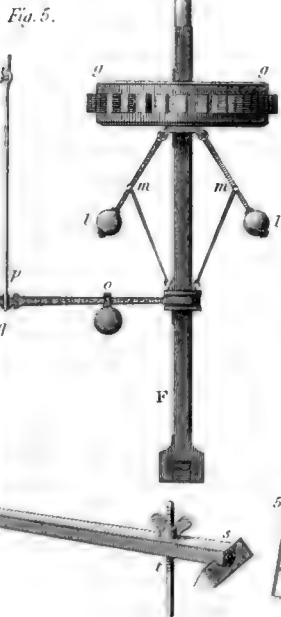
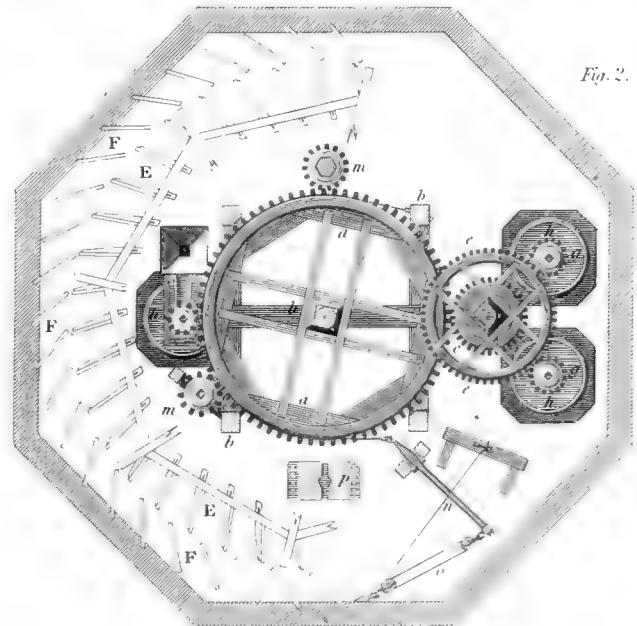
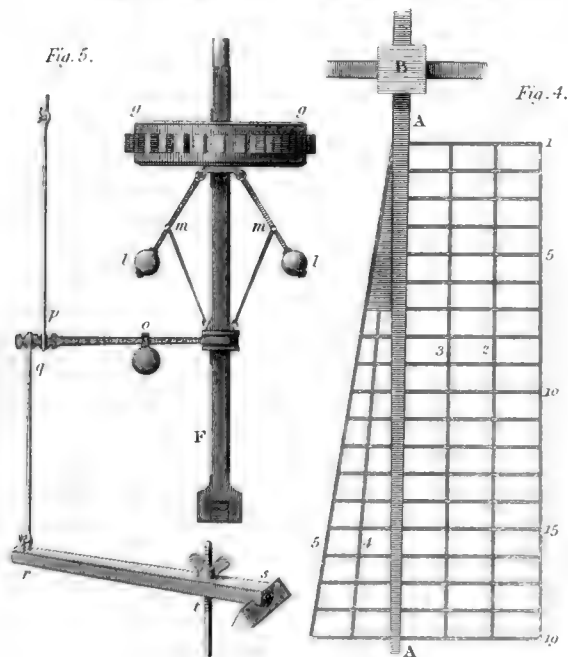
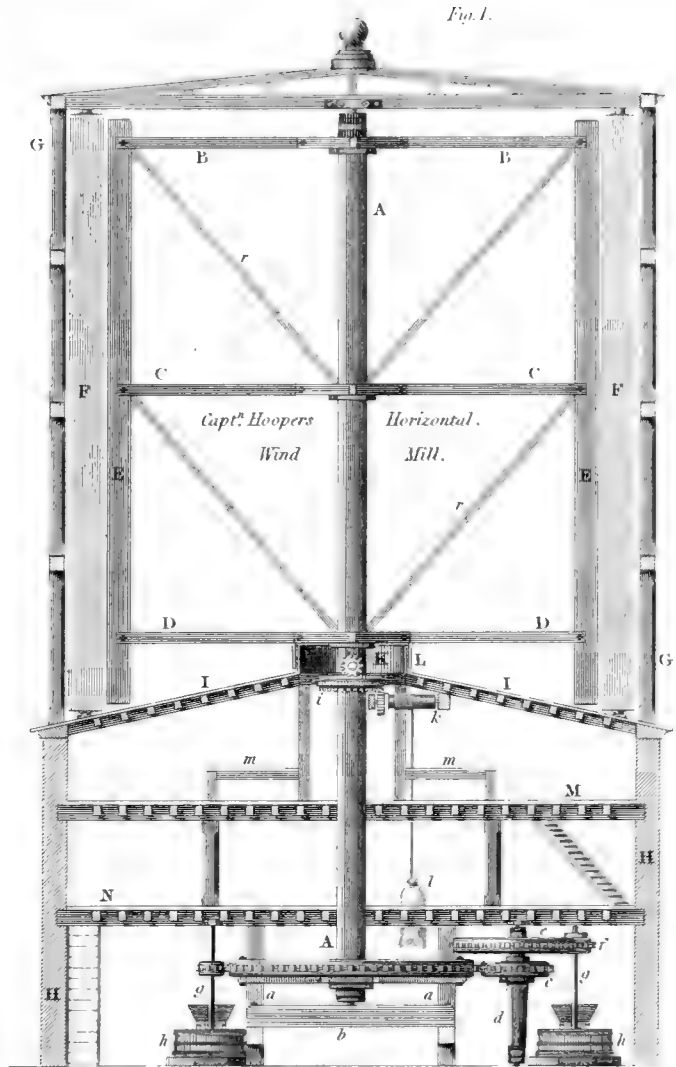
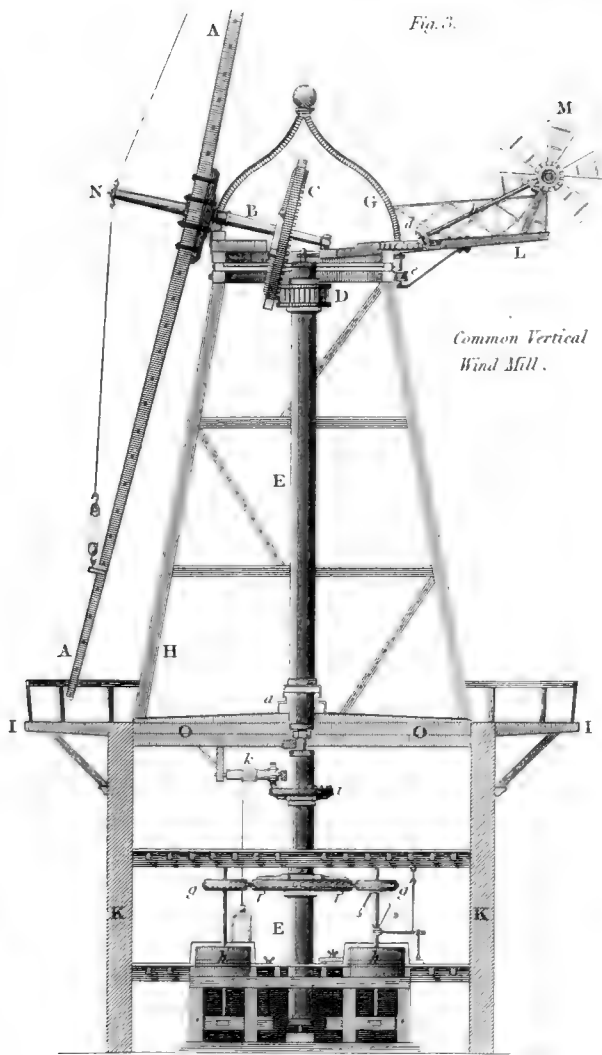


H

H



WIND MILL.



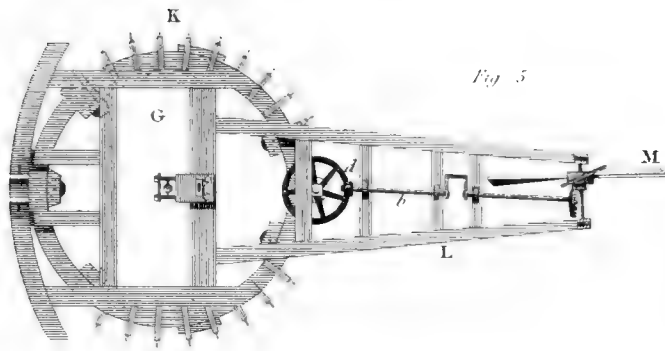


Fig. 5

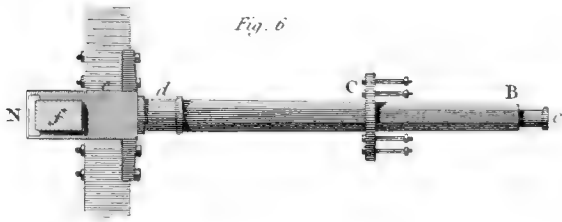


Fig. 6

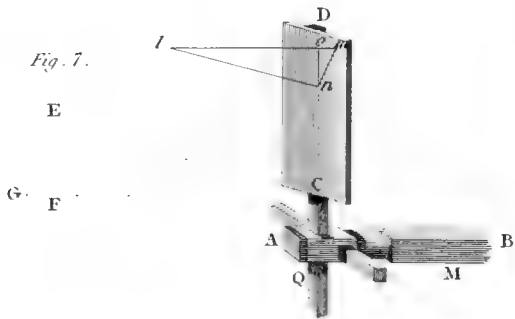


Fig. 7.

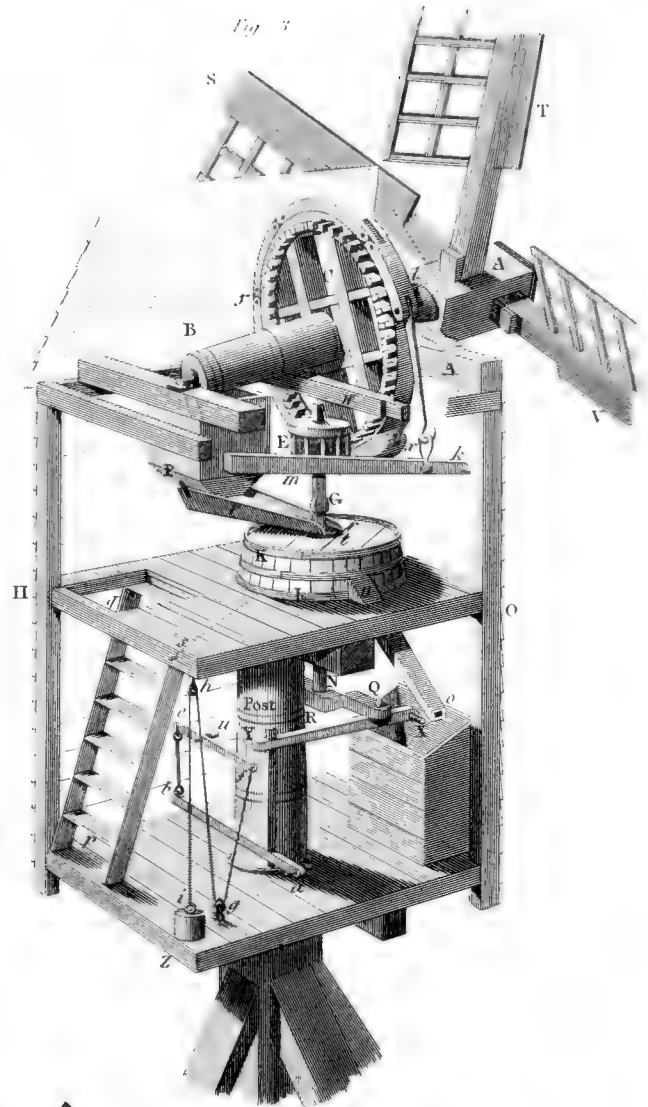


Fig. 3



Fig. 4.

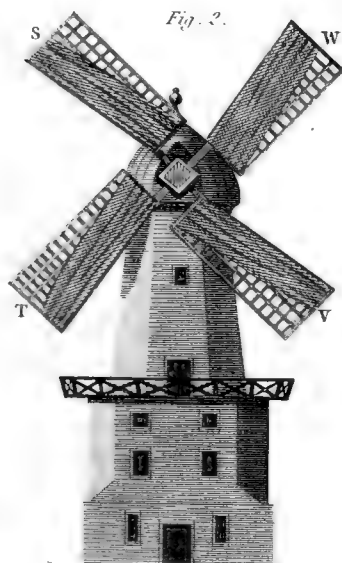


Fig. 2.



Fig. 1.

Mr. Smeaton's design for a Water GIN for drawing Coals from the Pits. . .

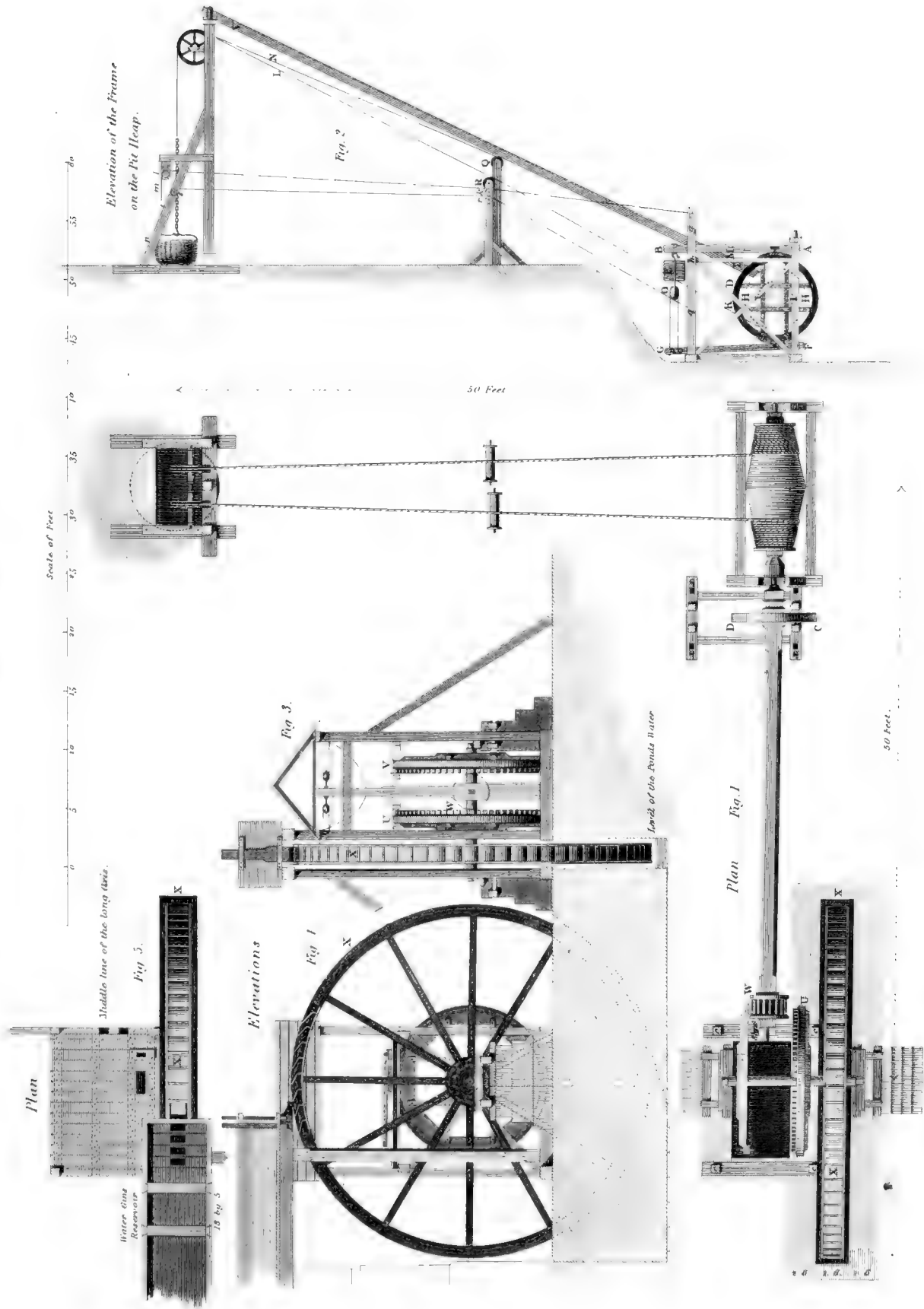


Fig 2

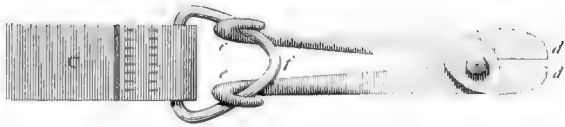


Fig 13.

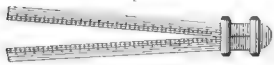


Fig 3



Fig 4



Fig 12



Fig 11

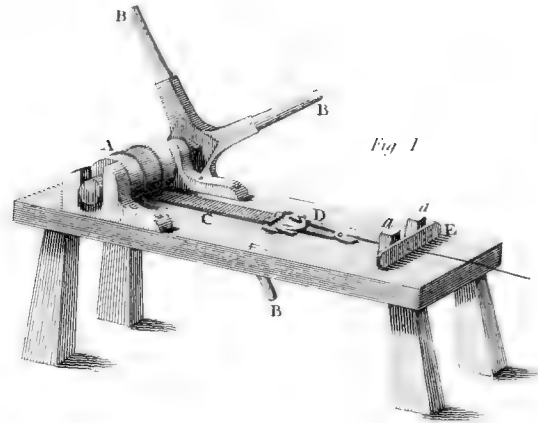


Fig 1

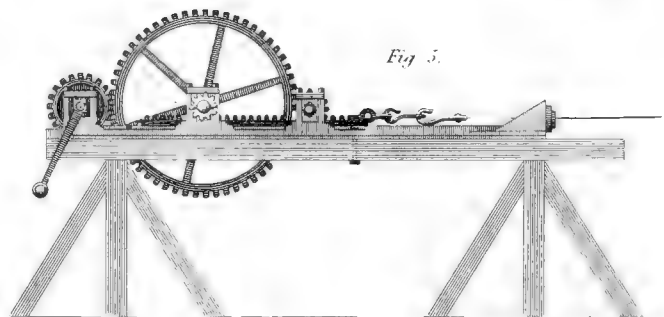


Fig 5.

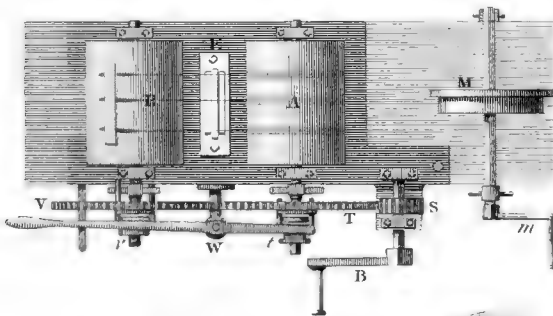


Fig 9.



Fig 8

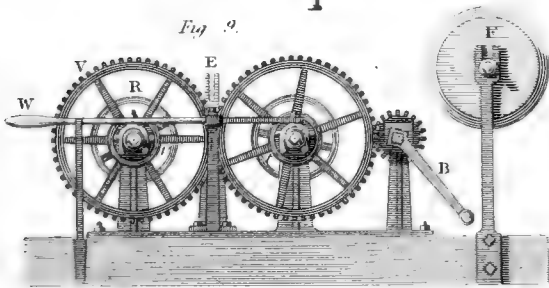
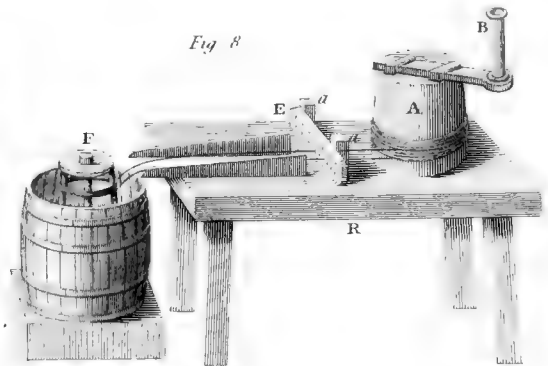


Fig 10

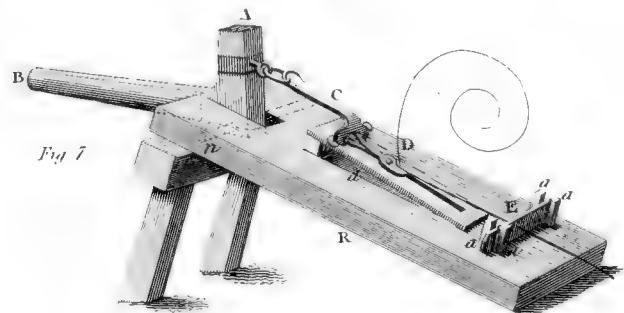
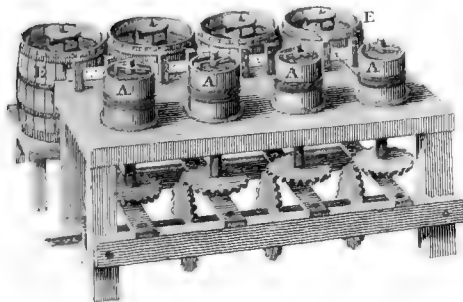


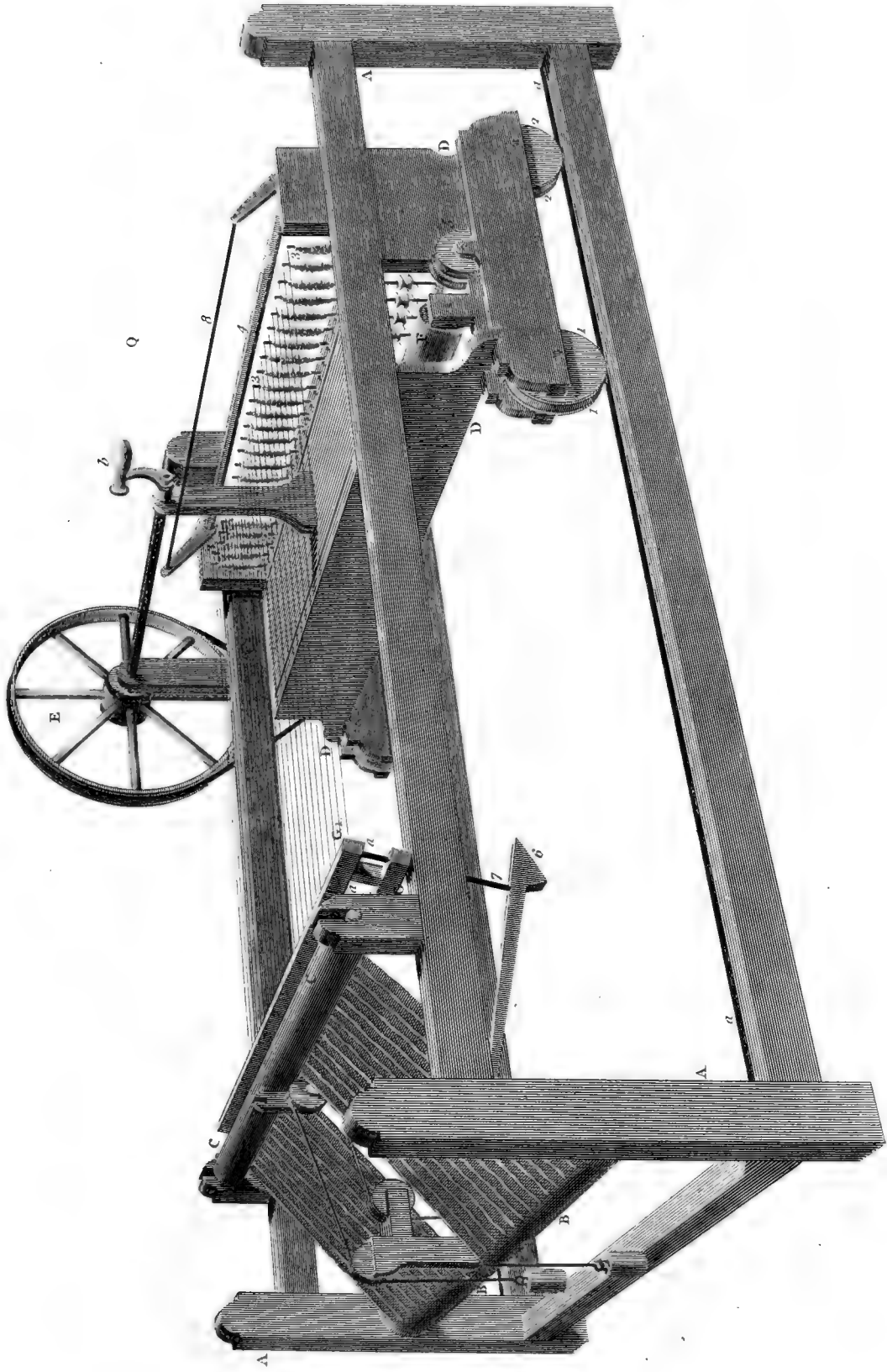
Fig 7



WOOLLEN MANUFACTURE.

SLUBBING MACHINE OR BILLY.

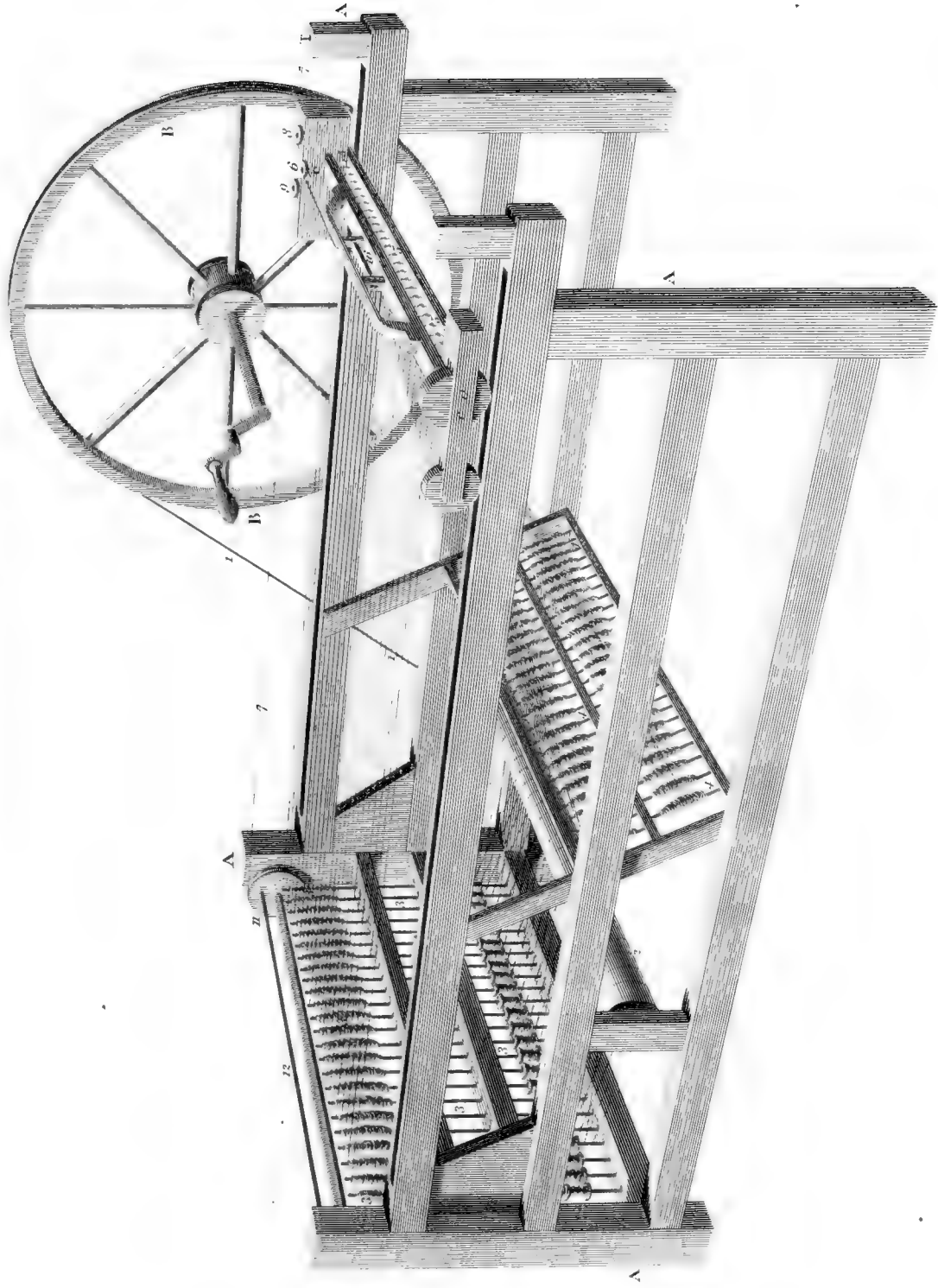
PLATE I.



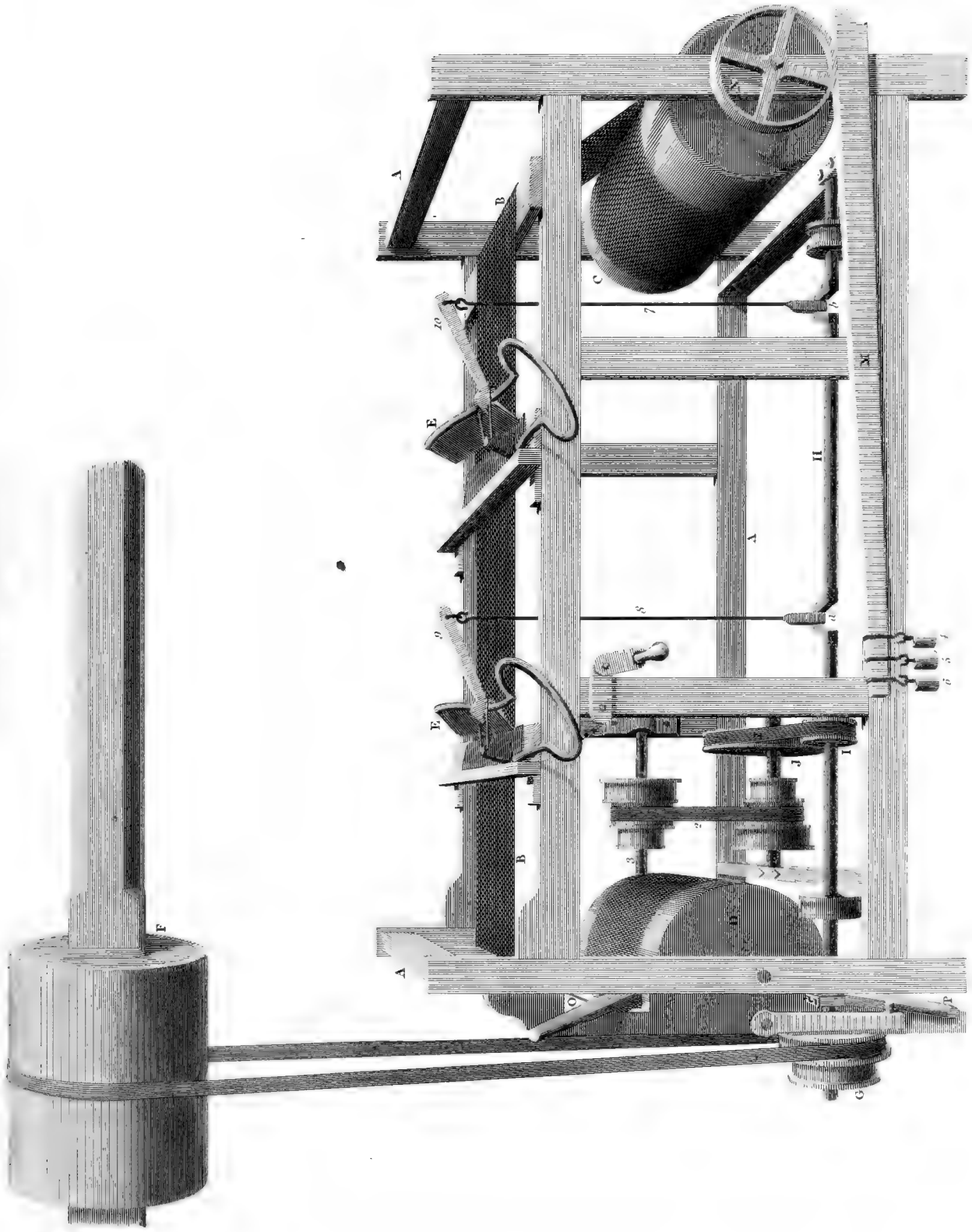


WOOLLEN MANUFACTURE.

SPINNING JENNY.

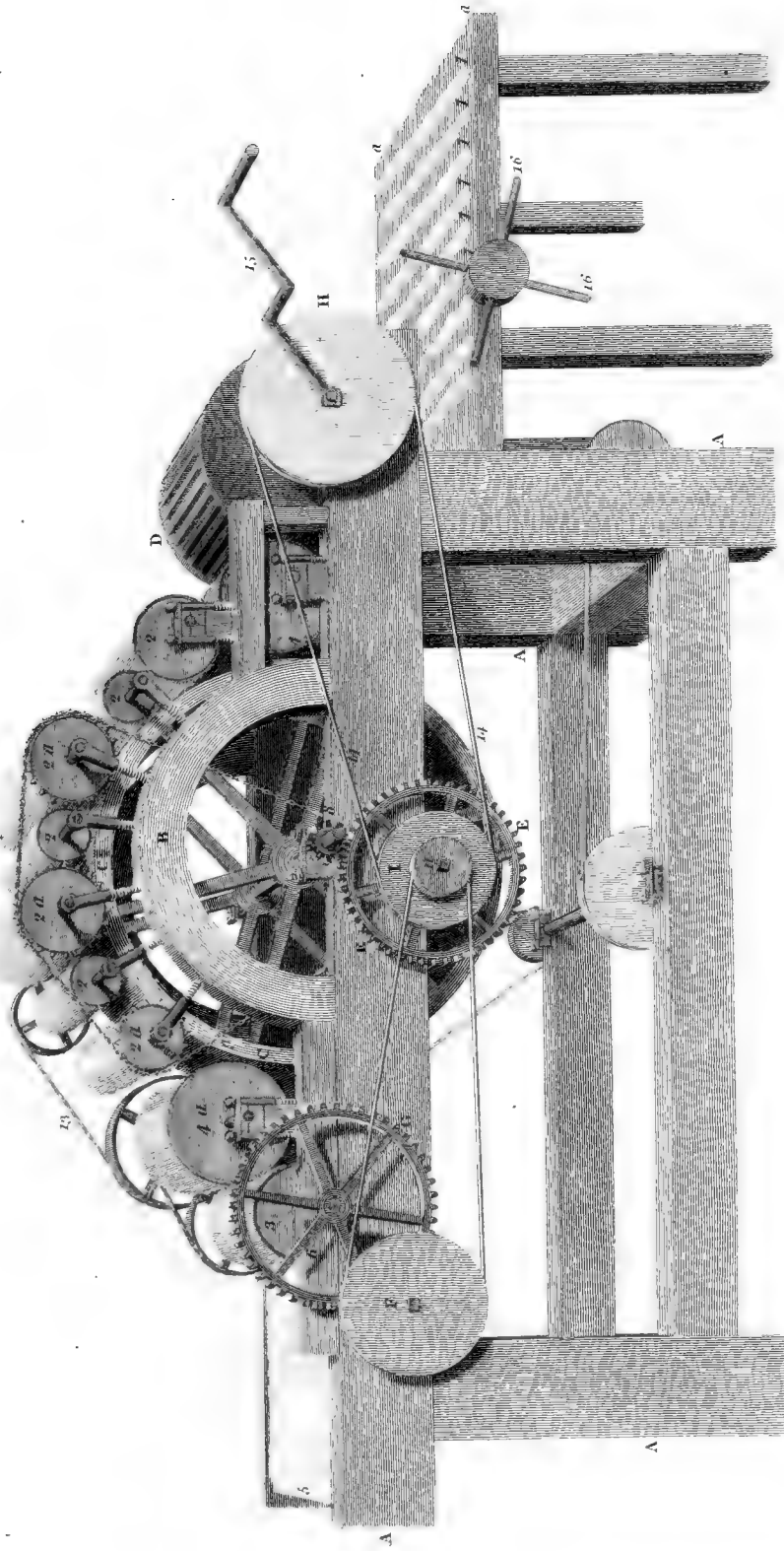


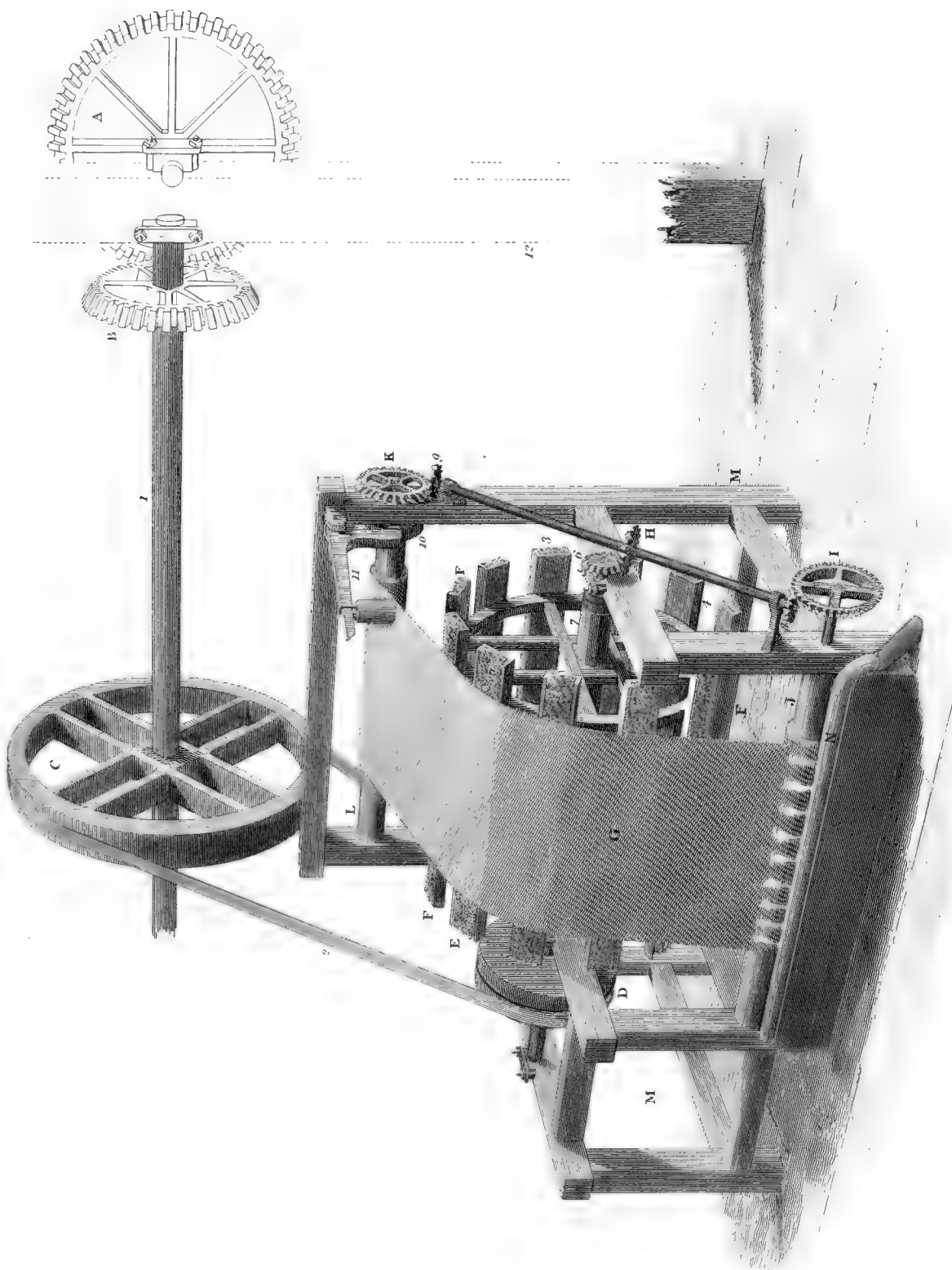
SHEARING MACHINE.



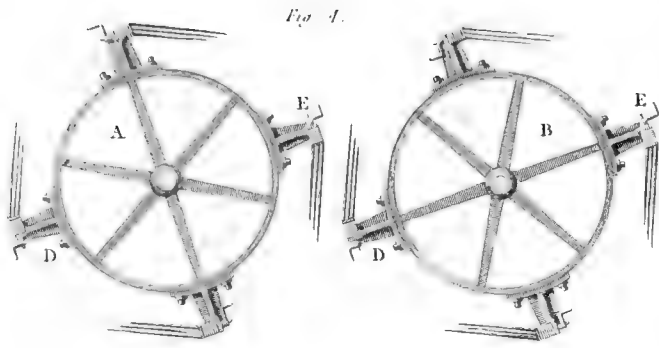
Published as the Act directs, 1851, by Longman, Hurst, Rees, Orme & Brown, Stationers' Row.

Engraved by Wilson Lowry.

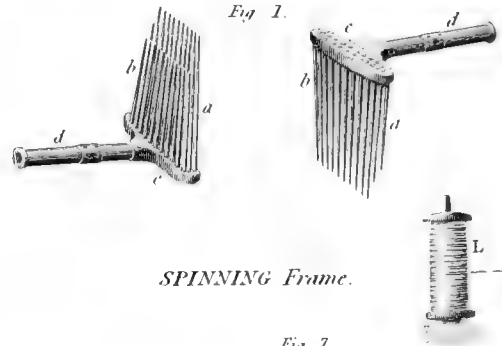
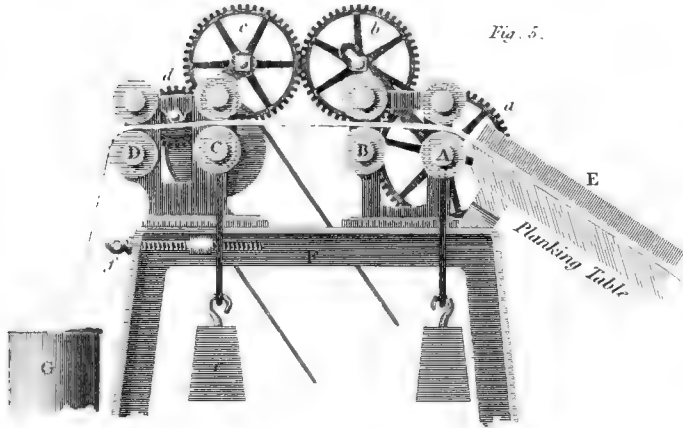
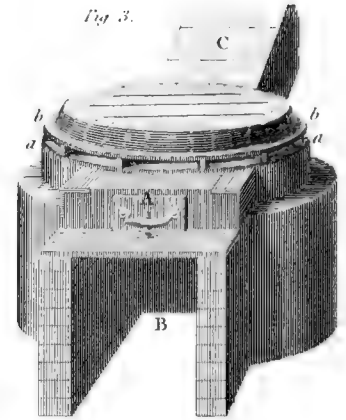
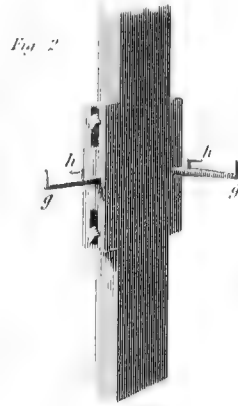




Published as the Act directs, 1855, by Longman, Hurst, Rees, Orme & Brown, Paternoster Row.

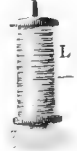


BREAKING Frame.



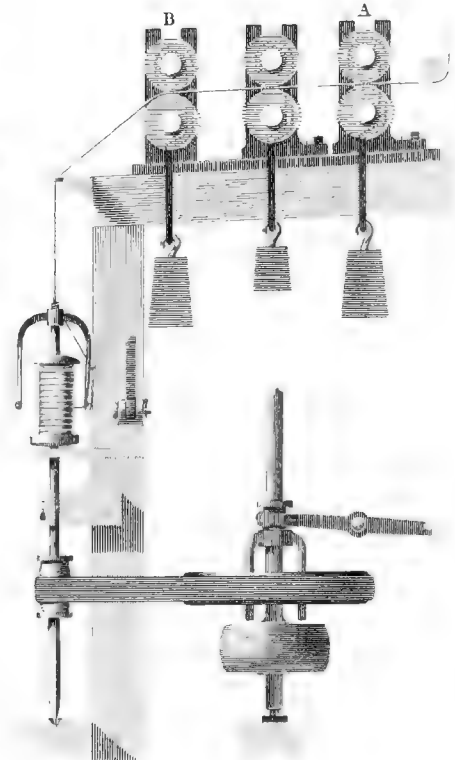
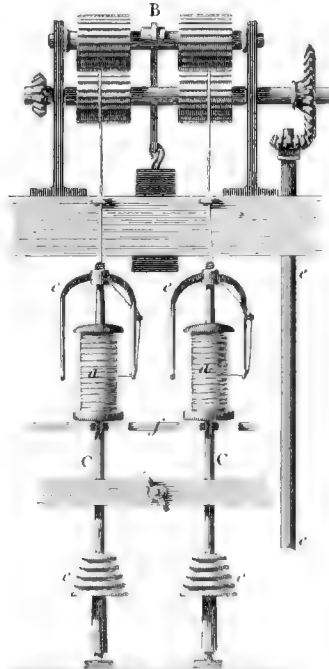
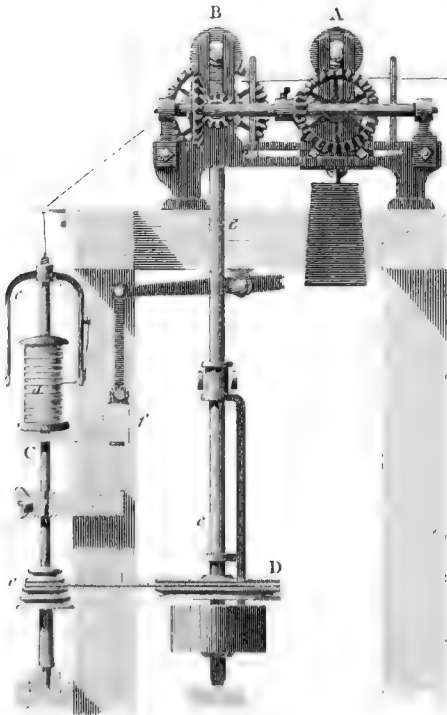
SPINNING Frame.

Fig. 7.



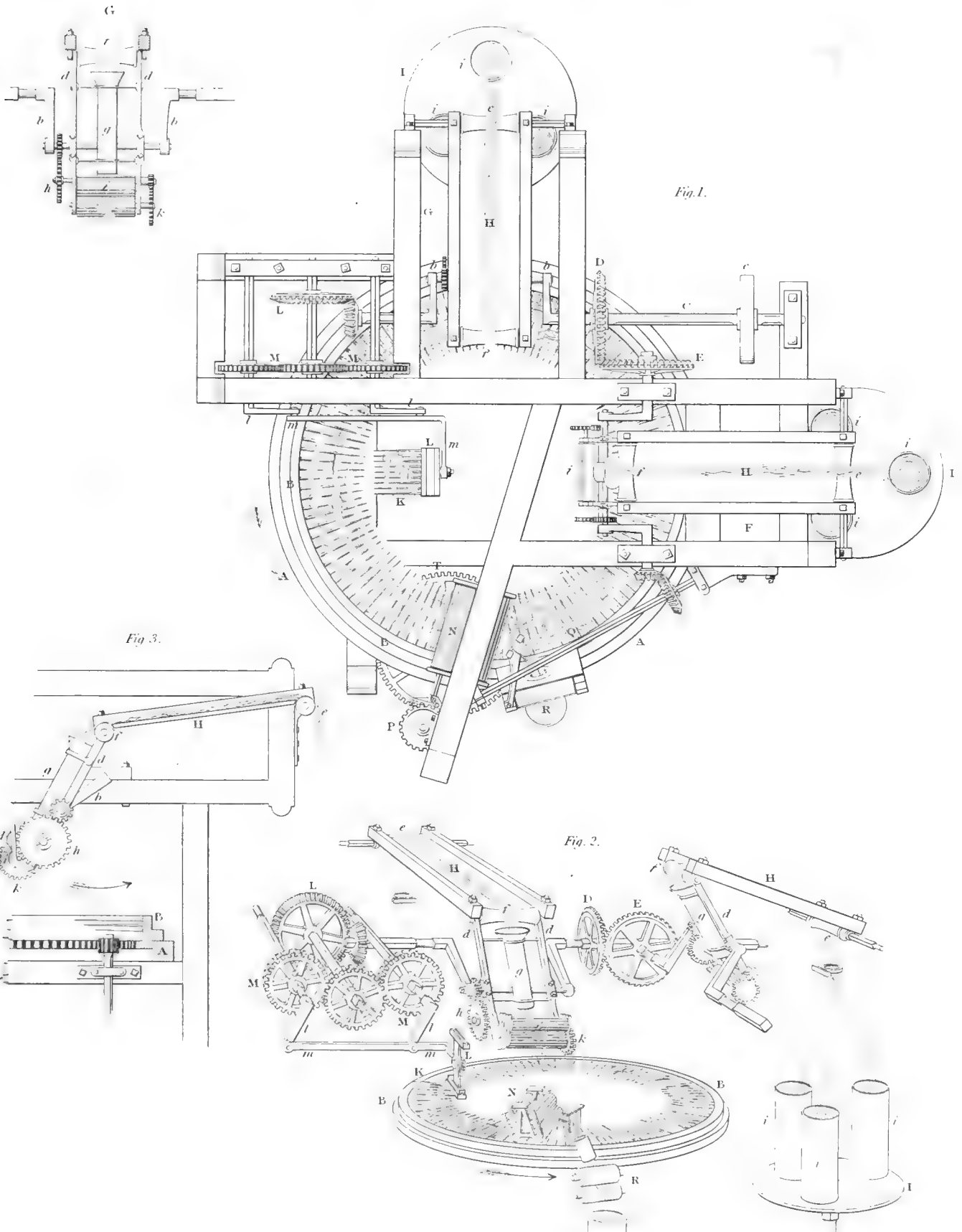
ROVING Frame.

Fig. 6.





WORSTED MANUFACTURE.
 CARTWRIGHT'S COMBING MACHINE.



WRITING BY CIPHER.

z	i	f	x	π	co	H	p	λ	m	q	π	π	Γ	υ	v	Δ	γ	ψ	7	6	2	φ	ψ	Ψ
a	b	c	d	e	f	g	h	i	k	l	m	n	o	p	q	r	s	t	u	w	v	x	z	

b	l	f	s	n	h	d	t	e	g	m	g	ny	y	r	a	o	u	e	a	o	oi	ui	io	oo	z
I	II	III	IIII	IIII	I	II	III	IIII	IIII	I	II	III	IIII	IIII	I	II	III	IIII	IIII	X	O	o	#	z	

a	b	c	d	e	f	g	h	i	k	l	m	n	o	p	q	r	s	t	v	w	x	y	z	
.		'			/	\	.		/	/				/	/		/	/	-		/	-	/	z

a	b	c	d	e	f	g	h	i	k	l	m	n	o	p	q	r	s	t	u	w	x	y	z	
⊖	⊙	⊙	⊙	⊙	⊙	⊙	⊙	⊙	⊙	⊙	⊙	⊙	⊙	⊙	⊙	⊙	⊙	⊙	⊙	⊙	⊙	⊙	⊙	⊙

It is high time on his Majesty and my behalfe with his grace's countigne thanks and my most humble recommendations, you plainly show and declare unto the Emperour, what hindrance hath ensued, and daily doth, unto the common affaires by reason things, &c.

⊖ ⊙ π ξ χ // x h d = - h ~ x ~ λ = ~ λ i ~ h ~ λ = ~ h f . d x σ # τ = λ - h = χ z + p
 - ~ λ f = ~ λ λ i δ ξ ~ λ λ = d λ f ε d δ // λ ζ = ε ξ χ 4 ~ λ λ τ = λ = d λ f
 - - = - z h σ h ε d = = h x // ξ ~ λ d x λ λ h s = ξ ~ λ χ h z ~ λ λ = h - - τ h

The talks between me and the Gen^l of that Marriage wch I spread adventure
 It may please your Majesty should trouble both your Ma^{ties} and them twice decade gave me
 6.7.5.9. ω s. ζ ξ 2 : 6.7.++ v 4 ≠ 7 2 : ω : γ θ τ h and 6.7.2 : L 6. π 2 : 4 q m
 occasion of nature 7 ∞ χ π 9. 4 7 4. τ ∞ ω γ ∞ ω π 6. 2 : ω λ 7 γ f f π 10. π δ ε β . o .
 4 π 2 : s : 7 . 4 10 . 6 : 9 10 4 ∞ π 7 s : 10 π 4 : ω 7 s : ε ω 4 : β β 7 . φ π 10 . w . b g s :

The new Emperour by his Ambassadour here
 I ω h : δ : 3 4 0 3 h 9 π o : 9 β h γ σ ω λ 3 : 4 : z o k o : 9 ω n h 9 7
 gerith all the new forwards v ω 4 : 7 : s ω 4 h γ . 4 λ ω m h t p r i c k e I 4 :
 o h ω + k 9 : 8 : 2 9 o 3 : to a direct resolution touching T o s 9 h z w

the somme to increased nine
 he desired that 5 λ δ π η o - o - o b mought 4 6 x h e δ ⊕ δ π 6 ω to h e x h e
 thousand shall manie things, and places of importance I δ ω δ β π ρ λ o I n ⊕ ω h γ δ
 else D d n n δ ω δ Δ D ω x δ β γ ρ n ⊕ ω π o - o ω δ β ω λ x h γ β δ
 would quaryle for a smaule thing

WRITING BY CIPHER.

1

a b c d e f g h i j k l m n o p q r s t u v w x y z

2

t a c t o u s l u r y e q k w b i c d m p h g z

3

near ye undereopshere on e the e gardens mile d
and still where many a garden flower grows wild

4 Lento

p r e c e a n b e c e s d
j n t h c s
s a r t n u m b e
e c e h r s
l e t m e k n o w y o u a r e s a f e a

6

u m p e r i t a e t u n s c i t a s e e r
c t a r i o r u m e t a m a n u e n s t u m
i u a u t i s p r i n c i p u m t a u t a
c s t u t m a x i m a p l e r u n q u e n
e g e t i a e i p h r i s i n i t u r m i s e
t u t i t a b u s e o m m i t t a u t u r

WRITING BY CIPHER.

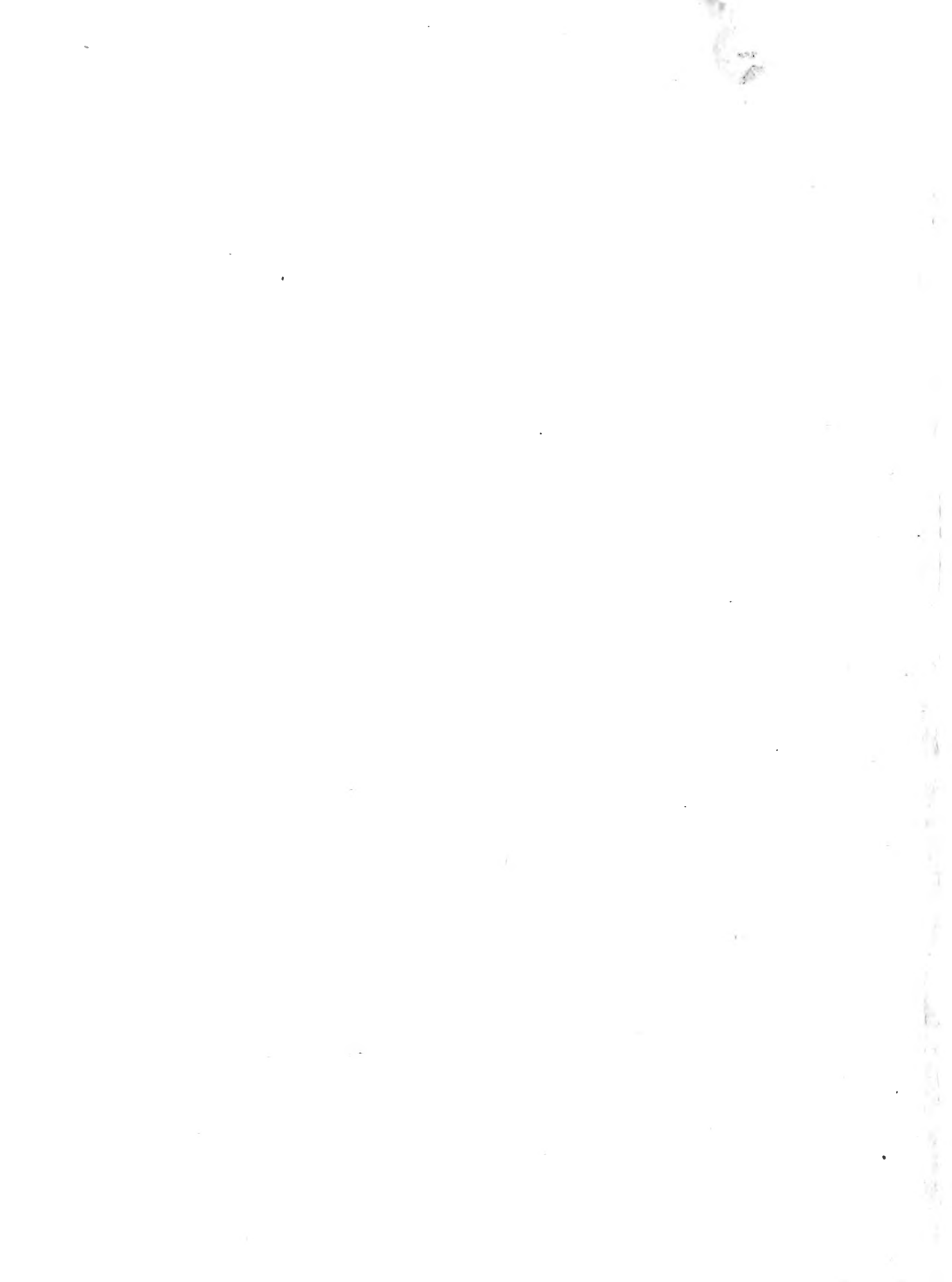
Alphabet and Key.

b	c	s	m	t	i	c	o	
g	m	t	p	u	h	o	i	a
j	p	u	d	a	n	h	o	e
k	d	y	r	e	r	n	s	t
q	r	a	l	i	s	r	t	o
v	l	e	h	o	t	s	u	a
w	h	i	n	e	u	t	a	e
x	n	o	r	d	a	u	e	i
z	r	o	s	t	e	a	i	o

H. Murat inv. 1807.

The page contains 20 horizontal lines for writing practice. Each line is filled with a sequence of dots representing a cipher code. The dots are arranged in a regular pattern, with some lines showing more complex sequences than others. The lines are evenly spaced and cover most of the page's width.

ALPH. 33 H. 33



AE
5
R329

Rees, Abraham
The cyclopaedia

Plates
v.4



PLEASE DO NOT REMOVE
CARDS OR SLIPS FROM THIS POCKET

UNIVERSITY OF TORONTO LIBRARY

UTL AT DOWNSVIEW



D RANGE BAY SHLF POS ITEM C
39 14 10 17 07 005 0