

# NOSC

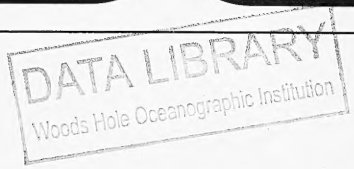

NOSC TR 632

Technical Report 632

## DEVELOPMENT OF AN UNDERWATER MANIPULATOR FOR USE ON A FREE-SWIMMING UNMANNED SUBMERSIBLE

Peter Bosse  
Paul J. Heckman, Jr.

October 1980

Prepared for  
NOSC Independent Exploratory Development Programs

Research and Development Programs,  
Outer Continental Shelf Oil and Gas Operations,  
U.S. Geological Survey

Office of Naval Research  
(Code 455)

Approved for public release: distribution unlimited

TC  
1501  
.TY  
no. 632

NAVAL OCEAN SYSTEMS CENTER  
SAN DIEGO, CALIFORNIA 92152



NAVAL OCEAN SYSTEMS CENTER, SAN DIEGO, CA 92152

**A N A C T I V I T Y O F T H E N A V A L M A T E R I A L C O M M A N D**

**SL GUILLE, CAPT, USN**

Commander

**HL BLOOD**

Technical Director

**ADMINISTRATIVE INFORMATION**

The effort to develop an advanced supervisory-controlled manipulator for a free-swimming submersible has been undertaken by the Ocean Technology Department of the Naval Ocean Systems Center in cooperation with the U.S. Department of Interior, Geological Survey (Mr. John Gregory); the Office of Naval Research, Code 455 (Mr. Gerald Malecki); and the NOSC Independent Exploratory Development Programs (Dr. Eugene Cooper). This specific task to develop the manipulator itself was funded by the NOSC Independent Exploratory Development Program under element 62766N, task ZF61512, project ZD57. The research on supervisory control concepts for advanced undersea tele-operator systems is sponsored by the Office of Naval Research and is being conducted by Dr. Tomas Sheridan at MIT with the technical cooperation of the Naval Ocean Systems Center. The development of a free-swimming, unmanned, untethered submersible testbed was funded by the U.S. Geological Survey and is a part of a total research and development program designed to supply technology required for pollution prevention and safety in outer continental shelf oil and gas operations. Unmanned, untethered submersible systems have a significant potential for upgrading the scope and complexity of these inspection missions in a cost-effective manner. The investigation of unmanned submersibles for pipeline and structures inspection problems represents an attempt to transfer technology from the Navy's Ocean Technology Programs for use in these inspection missions. The Navy, in turn, is using this testbed to assess advanced concepts in supervisory-controlled work systems as well as other advanced techniques applicable to search, recovery, and rescue missions at sea.

Released by  
I. P. Lemaire, Head  
Advanced Systems Division

Under authority of  
H. R. Talkington, Head  
Ocean Technology Department



| REPORT DOCUMENTATION PAGE  |                       | READ INSTRUCTIONS<br>BEFORE COMPLETING FORM   |
|--|-----------------------|---|
| 1. REPORT NUMBER<br>NOSC Technical Report 632 (TR 632)   | 2. GOVT ACCESSION NO. | 3. RECIPIENT'S CATALOG NUMBER   |
| 4. TITLE (and Subtitle)<br>DEVELOPMENT OF AN UNDERWATER MANIPULATOR FOR USE<br>ON A FREE-SWIMMING UNMANNED SUBMERSIBLE   |                       | 5. TYPE OF REPORT & PERIOD COVERED<br>Development<br>April 1979—October 1980            |
|  |                       | 6. PERFORMING ORG. REPORT NUMBER  |
| 7. AUTHOR(s)<br>Peter Bosse<br>Paul J. Heckman, Jr.  |                       | 8. CONTRACT OR GRANT NUMBER(s)  |
| 9. PERFORMING ORGANIZATION NAME AND ADDRESS<br>Naval Ocean Systems Center<br>San Diego, CA 92152   |                       | 10. PROGRAM ELEMENT, PROJECT, TASK<br>AREA & WORK UNIT NUMBERS<br>62766N, ZF61512, ZD57 |
| 11. CONTROLLING OFFICE NAME AND ADDRESS  |                       | 12. REPORT DATE<br>October 1980   |
|  |                       | 13. NUMBER OF PAGES<br>72   |
| 14. MONITORING AGENCY NAME & ADDRESS (if different from Controlling Office)  |                       | 15. SECURITY CLASS. (of this report)<br>Unclassified                                    |
|  |                       | 15a. DECLASSIFICATION/DOWNGRADING<br>SCHEDULE   |
| 16. DISTRIBUTION STATEMENT (of this Report)<br><br>Approved for public release; distribution unlimited   |                       |   |
| 17. DISTRIBUTION STATEMENT (of the abstract entered in Block 20, if different from Report)   |                       |   |
| 18. SUPPLEMENTARY NOTES  |                       |   |
| 19. KEY WORDS (Continue on reverse side if necessary and identify by block number)<br>Underwater inspection<br>Underwater work<br>Underwater manipulators<br>Free-swimming submersibles<br>Untethered submersibles   |                       |   |
| 20. ABSTRACT (Continue on reverse side if necessary and identify by block number)<br><br>The inspection of underwater objects such as pipelines and structures can be made more cost-effective through the development and use of unmanned, free-swimming (untethered) submersibles. A critical adjunct is a manipulator capable of emplacing sensors, positioning imaging subsystems, and retrieving small objects. A small, lightweight, electrically driven manipulator capable of handling an 8-pound load in water was designed, developed, and tested at NOSC. The oil-filled, pressure-compensated motor assembly design, incorporating potentiometer feedback and harmonic drive gearing, represents one of the most compact designs of its kind. Sleek exterior design, together with smooth, quiet operation, are noteworthy features. |                       |   |

DATA LIBRARY  
Woods Hole Oceanographic Institution

UNCLASSIFIED

SECURITY CLASSIFICATION OF THIS PAGE (When Data Entered)

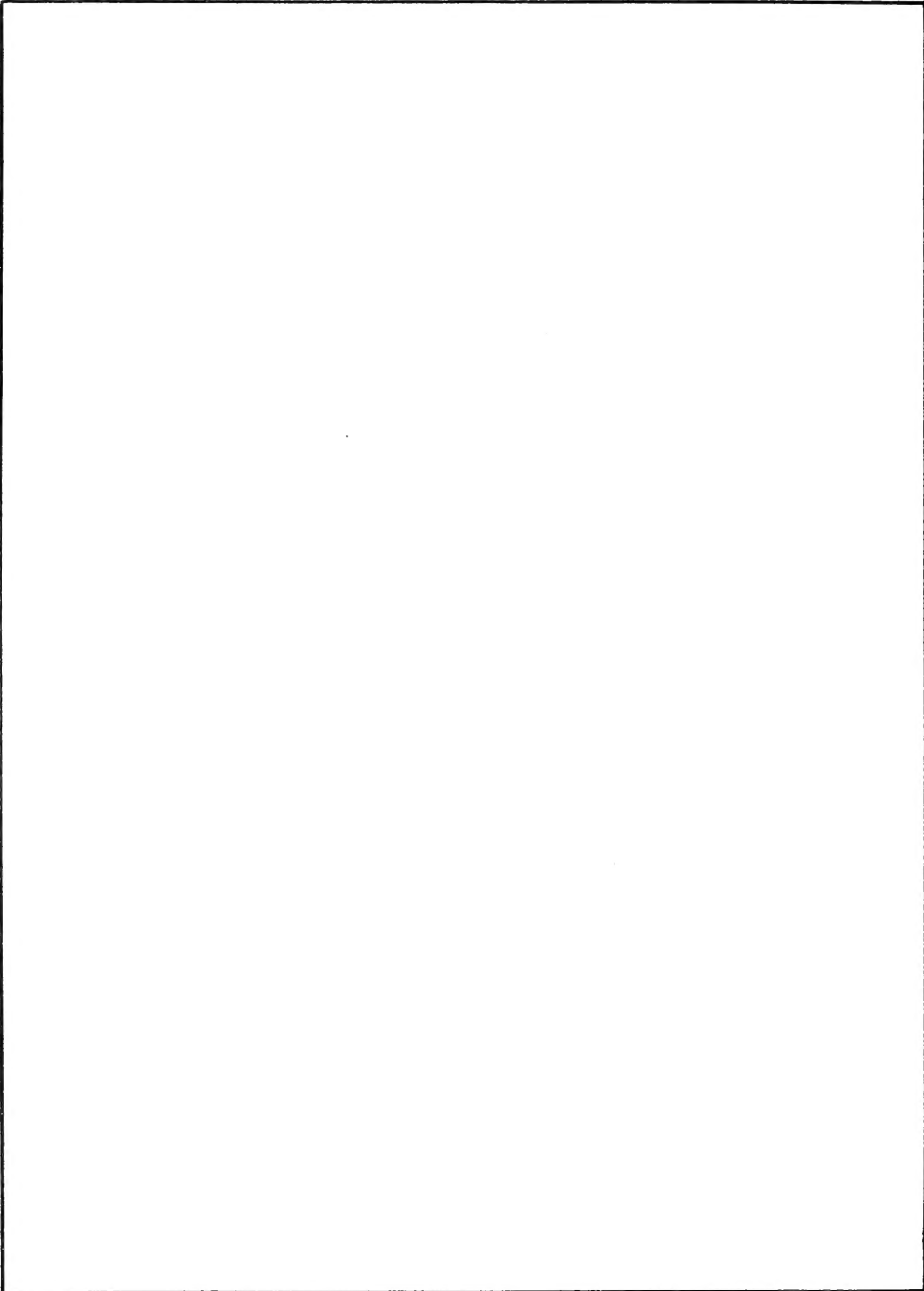

UNCLASSIFIED

SECURITY CLASSIFICATION OF THIS PAGE(When Data Entered)

## PROBLEM

Inspection of underwater objects such as underwater pipelines and structures can be made more cost-effective if the technology for using unmanned, free-swimming (untethered) submersibles is developed. One major critical area in the development of such vehicle systems is that of a manipulator capability for implacement of sensors, positioning of imaging subsystems, and retrieval of small objects in the water. A small, lightweight, energy-efficient manipulator, which could be operated on an unmanned, free-swimming submersible, was required to act as a testbed for advanced supervisory-control techniques.

## RESULTS

A small, lightweight, electrically driven manipulator capable of handling an 8-pound load in water was designed, developed, and tested in the laboratory. The unit was found to be quite satisfactory as a testbed for advanced supervisory-controlled teleoperator techniques. The oil-filled, pressure-compensated motor assembly design, incorporating potentiometer feedback and harmonic drive gearing, represents one of the most compact underwater designs of its kind in existence. The sleek exterior design, together with the smooth, quiet operation of the entire manipulator configuration, are noteworthy features.

## RECOMMENDATIONS

Advanced techniques in manipulator control should be tested and evaluated with this manipulator mounted on the NOSC/US Geological Survey EAVE WEST free-swimming submersible testbed.

## CONTENTS

|     |                                       |        |
|-----|---------------------------------------|--------|
| 1.0 | INTRODUCTION . . .                    | page 3 |
| 1.1 | NOSC Free-swimming Submersible . . .  | 4      |
| 1.2 | Supervisory Control . . .             | 8      |
| 2.0 | TECHNICAL APPROACH . . .              | 12     |
| 2.1 | Design Requirements . . .             | 12     |
| 2.2 | Component Tradeoffs . . .             | 13     |
| 2.3 | Structure Elements . . .              | 16     |
| 3.0 | SYSTEM DESCRIPTION . . .              | 17     |
| 3.1 | General Description . . .             | 17     |
| 3.2 | Performance Specifications . . .      | 17     |
| 3.3 | System Integration . . .              | 23     |
| 4.0 | CONCLUSIONS AND RECOMMENDATIONS . . . | 26     |

### APPENDIXES:

- A. ASSEMBLY PROCEDURE FOR LARGE MOTOR ASSEMBLY . . . 27
- B. ASSEMBLY PROCEDURE FOR SMALL MOTOR ASSEMBLY . . . 49

|                  |    |
|------------------|----|
| REFERENCES . . . | 71 |
|------------------|----|

## ILLUSTRATIONS

|    |   |    |
|----|---|----|
| 1. | The NOSC free-swimming submersible mounted on its laboratory test stand . . .                                 | 6  |
| 2. | The principle of supervisory control applied to remote teleoperator systems . . .                             | 7  |
| 3. | The NOSC free-swimming submersible configured for use with the supervisory-controlled manipulator . . .       | 9  |
| 4. | The final underwater manipulator configuration as mounted in a test support apparatus in the laboratory . . . | 18 |
| 5. | Manipulator shown grasping small object with "fingertips" . . .   | 19 |
| 6. | Manipulator shown grasping large object . . .   | 20 |
| 7. | The fiberglass portions of the manipulator (before painting) . . .  | 21 |
| 8. | Manipulator assembly drawing showing the movement angle for each joint . . .                                  | 22 |
| 9. | NOSC free-swimmer manipulator supervisory control block diagram . . .   | 24 |

## TABLE

|    |   |    |
|----|---|----|
| 1. | Comparison of nitrile-based versus fluorocarbon-based seals . . . | 15 |
|----|---|----|

## 1.0 INTRODUCTION

The extraction and exploration of offshore oil, gas, and other important materials during the past decade has encouraged the development of a wide variety of underwater support services. In 1977, according to the Exxon Company, 16 percent of worldwide crude-oil production came from offshore bore-holes. Proven crude-oil reserves are estimated at 26 percent of the world's total.

As a result of current economic and political conditions, the nations of the world have been turning to the oceans to fill their ever-increasing demands for energy and food, even though extraction may have to take place in cold and hostile ocean regions with water depths of 3000 feet and more. In US waters alone, about 7000 miles of pipeline have been laid. More than 3000 structures have been erected in the Gulf of Mexico alone in the last 10 years (ref 1). All these structures require routine inspection, maintenance, and rectification of defects. The scale of the task is enormous.

Divers play a vital role in the difficult task of establishing a physical link between surface and seabed. Advanced diving technology will place a diver down to 1000 feet. However, as man progresses into deeper water, into areas under arctic conditions, or into exposed locations having wave heights of 95 feet, effective substitutes for the unsaturated diver must be developed.

Recently, the greatest surge in developmental activity and operational deployment has been in the area of remotely operated vehicles (ROVs). In unmanned submersible operations, three vehicle configurations are in use: (1) towed vehicles; (2) tethered vehicles; and (3) untethered, free-swimming vehicles.

- (1) Towed vehicle systems are operated by means of an umbilical cable which conveys mechanical propulsion, electrical power, and communications to the vehicle from a relatively large surface support craft. The submersible is fairly uncomplicated in nature, but is capable of maneuvering only forward on its own and up/down by means of a cable winch.
- (2) The tethered vehicle, which appeared a few years later, incorporated an umbilical cable that provided only electrical power and communication. Propulsion was provided by thrusters located on the vehicle. Because the cable no longer conveyed mechanical power for the vehicle, the cable was made lighter and more flexible, and support-ship size requirements were reduced. Since these vehicles were capable of three-dimensional maneuvering, undersea inspections and work operations were possible.
- (3) Free-swimming submersibles, or untethered unmanned submersibles, have recently made an appearance as a result of emerging technology in this field. Eliminating the tether affords a free-swimming submersible the performance advantages of higher speed (due to reduced cable drag) and entanglement-free operation. Support-ship requirements are minimized because there is no need for a cable-handling

system and its associated manpower and shipboard storage requirements. There is also no need for stationkeeping during an operation.

If communications requirements for the free-swimming vehicle were reduced to zero, a totally autonomous submersible could be produced and the support ship itself could be eliminated. Although certain totally autonomous operations are practical, even with today's technology there are several major areas where development is required before untethered RCVs can approach the usefulness of their tethered counterparts. One of these areas is that of adapting a manipulator arm to the free-swimming submersible and developing a reasonable and efficient means of remotely controlling that manipulator by means of a low-bandwidth acoustic channel. For additional discussion concerning the differences between a truly autonomous vehicle and a remotely controlled vehicle, see ref 2.

### 1.1 THE NOSC FREE-SWIMMING SUBMERSIBLE

For the last several years, the Naval Ocean Systems Center (NOSC) has been involved with the development of small, unmanned vehicle systems. The list of these submersibles includes the first hydraulic Snoopy, Submerged Cable Actuated Teleoperator (SCAT), Electric Snoopy, NAVFAC Snoopy, and the Mine Neutralization Vehicle (MNV). (For details of these systems, see ref 3.)

The development of control systems for these vehicles has proceeded from completely manual control, through heavy, multiwire cable, to automatic control circuits directed by a lightweight, low-drag cable with multiplexed data and control signals. New technological advances in solid-state electronics and microprocessor technology permit a simplification of the hardware required for small unmanned vehicles by allowing the designer to replace much of the hardware with flexible software to meet the changing needs of various mission requirements. With funding from the U.S. Geological Survey, NOSC has developed a free-swimming (untethered) submersible testbed (EAVE WEST) for pipeline and undersea structures inspection as well as Navy search and inspection tasks. The basic development requirements in the design of the vehicle were as follows:

- Operate with and without a communication link.
- Demonstrate speeds greater than those of a tethered submersible having the same thruster power.
- Hover and maneuver at zero and low-to-medium speeds.
- Operate relatively inexpensively for several test operations and experiments at sea.
- Be mechanically modular to lend itself to the addition of appendages such as TV cameras, side-looking sonars, and other inspection sensors and effectors.
- Contain a modular, easily updated, and expandable software structure that allows expansion from a simple single computer system to a more sophisticated supervisory-controlled configuration for autonomous operations.



- Allow the addition of incremental step-by-step improvements to demonstrate progressively complex near-term advantages of improved performance over existing systems and approaches.
- Provide a basic system design which is adaptable to a variety of users.
- Incorporate the use of analogic and symbolic controls and displays to offer the operator a more familiar adaptation to the computer.
- Be able to interface with the operator as a combination of direct vehicle control and interactive and adaptive control. The machine does not have to replace the man totally at all times, but the machine should be capable of replacing the man during routine functions or for operations such as automatic position holding, which are more easily performed by automatic control.

The vehicle (fig 1) is 9 feet long, 22 inches wide, and 22 inches high. It weighs about 400 pounds in air, and has an operating depth of 2000 feet. A long, narrow configuration was chosen to allow minimum drag in the forward direction. By adapting a closed external skin, the speed could be increased from its present measured 1.8 knots to a projected 5 knots. The "T"-shaped frame, weighing only 10 pounds in water, is constructed of sealed, welded aluminum tubing. An open-frame configuration has the advantage of allowing the addition of payloads by simply strapping them onto the frame or by lengthening the vehicle to accommodate 25 pounds of additional payload per linear foot of extension. Syntactic foam blocks mounted on top of the frame provide about 180 pounds of buoyancy. Two stern and one midships fixed-mounted thrusters provide 3 degrees of freedom. The horizontal motion thrusters are canted 15 degrees to provide a turning radius smaller than the length of the vehicle. Each thruster is powered by commercially available 1/4-horsepower, 24-Vdc motors. The motor housings are oil-filled, pressure-compensated units designed and fabricated at NOSC. Electrical interconnections are achieved by using oil-filled, pressure-compensated cables and connectors. Four 7-inch-diameter, one-atmospheric-pressure aluminum bottles are strapped to support brackets welded onto the main frame. The two 30-inch-long bottles at the stern contain the basic microprocessor control electronics, as well as the motor control electronics and switching relays which are required for all configurations of the vehicle. The two 42-inch-long bottles in front of the vehicle contain the sensor and communication system electronics, which can be changed easily for various vehicle configurations. Two 3-inch-diameter, approximately 7-foot-long aluminum bottles containing the main battery power pack are attached to brackets bolted to the lower portion of the frame to provide a good center-of-gravity to center-of-buoyancy separation. The battery pack, which provides 26 and 14 Vdc, is constructed of a series of Gates 2-volt, 25-ampere-hour rechargeable lead-acid batteries, weighs about 77 pounds, and allows up to 1 hour of underwater vehicle duration. The lead-acid batteries could be replaced by more expensive non-rechargeable lithium cells, which would deliver about five times the energy. All metal parts exposed to saltwater are hard black-anodized aluminum. The entire configuration is adjusted by trim weights to provide approximately 8 pounds of positive buoyancy.

The basis of the vehicle control electronics is an Intel 8080 microprocessor on low-cost, commercially available (Prolog Corporation), fully tested

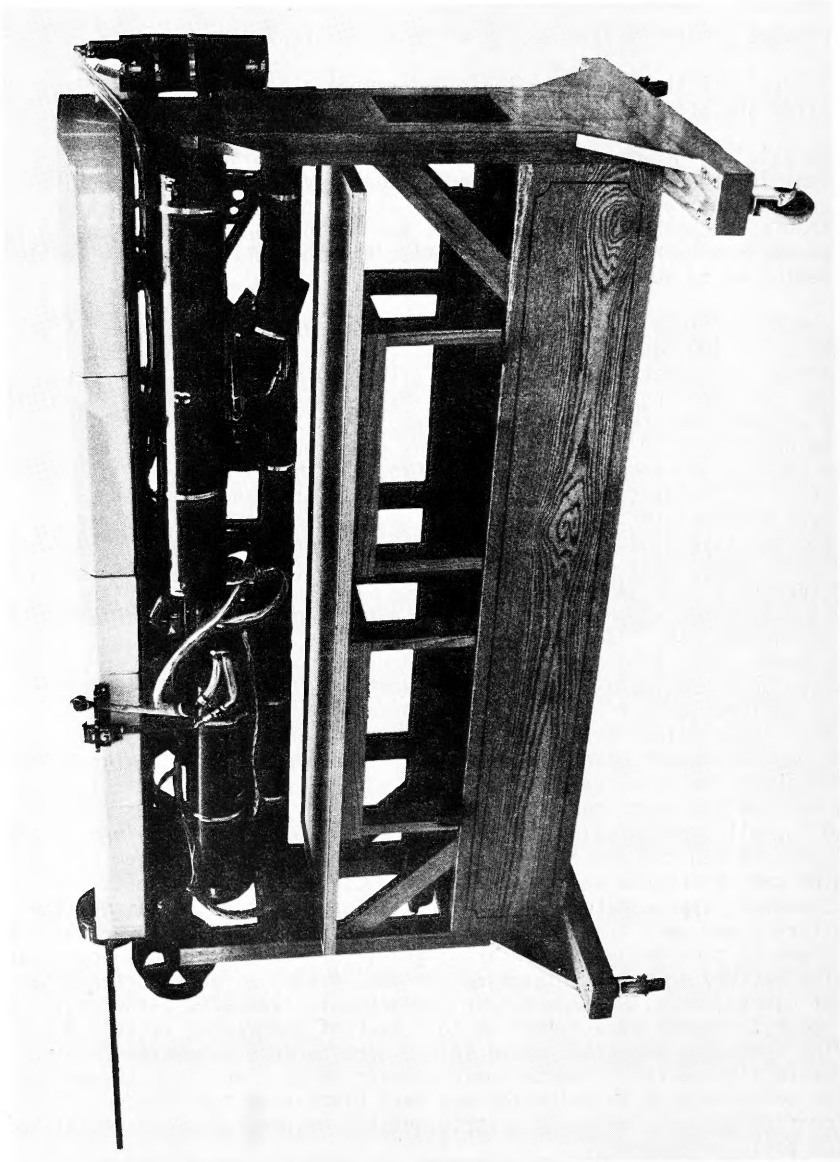

Figure 1. The NOSC free-swimming submersible mounted on its laboratory test stand.

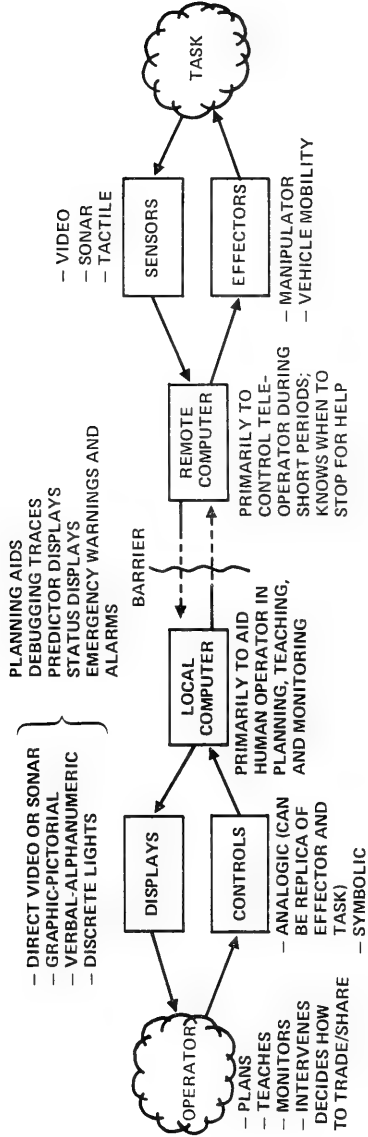

Figure 2. The principle of supervisory control applied to remote teleoperator systems.

universal printed circuit cards. The heart of the control system is the software program stored presently as firmware in 6 kbytes of UV-erasable programmable read-only memory (PROM) and 2 kbytes of random-access memory (RAM) in the vehicle microprocessor and 24 kbytes of RAM in the topside Intecolor 8051 colorgraphic display terminal with associated mini-floppy disk drives and keyboard. The primary programming language is PL/M, a microprocessor-compatible subset of PL-1. The topside terminal and the control system on the submersible are connected by an umbilical cable which is disconnected before launch. The use of a lightweight, deployable, low-drag, single-fiber strand as a real-time high-bandwidth data link to the submersible after launch is being investigated. This would allow the use of relatively inexpensive data sensors such as TV cameras and sonar systems without the disadvantage of high cable drag. The onboard microprocessor is used to compare programmed run time, heading, depth, and run sequence input data with measured data originating from a clock, fluxgate-updated gyrocompass, depth sensor, and run sequence pointer, respectively. The microprocessor generates digital 8-bit error signals between the programmed and measured values and issues them to the appropriate linear motor controller. A trajectory design program allows the operator to choose a series of preprogrammed tracks such as taxi (out and return), figure-eight, parallel path search patterns, a square, or a hexagon. If he desires, the operator also can generate new patterns for the vehicle to execute. The total trajectory can be displayed graphically to help the operator in visualizing the chosen trajectory.

## 1.2 SUPERVISORY CONTROL

The basic software and hardware architecture for the vehicle described in section 1.1 is that of supervisory control by means of a two-computer configuration. This control concept is shown schematically in fig 2. Pioneering work on this concept was conducted by Ferrell and Sheridan (ref 4). Under ONR sponsorship, Dr. Sheridan is currently conducting basic research on supervisory control at MIT, and with the technical cooperation of NOSC is investigating the application of these concepts to advanced undersea teleoperator systems under supervisory control. The human operator communicates with a given teleoperator system such as a vehicle through the intermediary of a computer. The operator is responsible for higher-level functions such as specifying a trajectory and receiving status information from the remote computer on the submersible. The remote computer, meanwhile, controls continuously the sensors and thrusters of the vehicle by breaking the task commands down to primitive functions such as increasing the current to the dc motor which drives the left stern-mounted thrusters. In general, the human operator communicates continuously with the local computer which, in turn, communicates intermittently at a low data rate with the remote computer that continuously completes a previously given set of instructions.

Although the main reason to adopt a supervisory-controlled architecture is to be able to use lower communication data rates, experiments at MIT (ref 5 and 6) have shown that such a manipulator is more efficient and effective than switch rate control, joystick rate control, and master-slave position control. Since the experiments were performed under ideal conditions, it is predicted that supervisory control in a two-computer configuration will show to even more advantage when used with degraded sensor or control loops; eg, time delays, limited bandwidth, etc. Operating a remotely controlled manipulator on a free-swimming untethered submersible with a limited data transfer through

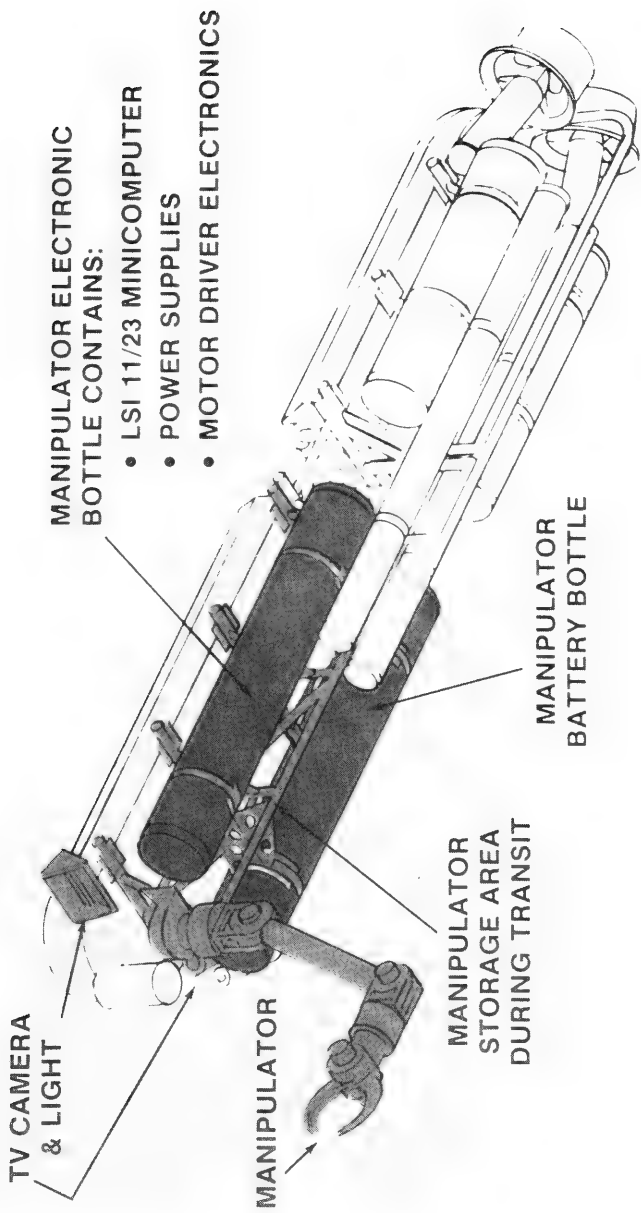

Figure 3. The NOSC free-swimming submersible configured for use with the supervisory-controlled manipulator.

the water medium is only possible through a bandwidth-reduction scheme such as that of using a two-computer supervisory-controlled configuration. Based on the results of laboratory experiments, however, there is reason to believe that control of the entire teleoperator (ie, vehicle plus manipulator) would be more efficient than previous conventional operator command techniques. An artist's conception of how the manipulator would be used on the NOSC free-swimming submersible, EAVE WEST, is shown in fig 3. The shaded portion of the vehicle represents those parts that are directly concerned with the use and support of the manipulator. The unshaded portion of the drawing represents the basic configuration of the vehicle used for other mission scenarios. The manipulator could also be attached to the center of the vehicle if the major design was to lift objects in an open area with the least adverse consequences to vehicle stability.

## 2.0 TECHNICAL APPROACH

### 2.1 DESIGN REQUIREMENTS

The original design requirements stated when the manipulator program was initiated in May 1979 were as follows:

- Objective: To develop a small, lightweight underwater manipulator compatible with the requirements of the existing unmanned, free-swimming submersible at NOSC and the existing software structures and algorithms developed by the Massachusetts Institute of Technology (MIT), Man-Machine Systems Laboratory in Cambridge.
- Depth of Operation: 2000 feet
- Degrees of Freedom: Four
- Configuration: Straight arm-pivoted at mounting, 180-degree stowage. Wrist rotate, wrist pivot, jaw closure.
- Power: 24-V electric
- Weight: 20 to 25 pounds
- Lift Capability: 30 pounds at full extension, 100 pounds vertical.
- Jaw Type: Grabber-type jaw.
- Electrical Feedback: Position feedback.
- Performance Capability: Pick up small objects. Apply magnetic particle inspection techniques.

These requirements were meant as general design goals and not as absolute requirements for a specific set of tasks. During the design process, the number of degrees of freedom were increased from four to five, and, because of size and weight constraints, the lift capability was reduced to 5 pounds at full extension and 25 pounds vertical. In addition, it became evident that the existing MIT software would have to be modified extensively to accommodate the particular mechanical design geometry of this manipulator and the use of the powerful LSI/11-23 computer system which was later adopted for both the topside and vehicle computers.

Potential tasks for the manipulator relative to the USGS pipeline and structures inspection for which the EAVE WEST vehicle has been designed are

1. Positioning a cavitation-erosion cleaning nozzle developed under contract to the USGS R&D program.
2. Placing a self-contained sensor package at selected positions on a structure. These packages may be attached either mechanically or magnetically.

3. Positioning an imaging subsystem to allow visual inspection of welded joints and structural members. Candidates include still- and motion-picture photography, as well as conventional and solid-state TV.
4. Attaching a line onto instrument packages or navigation transponders through a hook arrangement to recover such packages from underwater structures or in the vicinity of pipelines on the ocean bottom.

Similar tasks are envisioned for Navy missions involving search, rescue, and recovery operations. However, the attempt of the research and development effort described here is not to provide a work system for immediate use on a Navy mission, but rather to perform the research necessary to develop the concepts basic to the design of such systems in the future.

## 2.2 COMPONENT TRADEOFFS

The choice of components was dependent upon developing a manipulator capable of underwater operation to 2000 feet and operating on a free-swimming submersible. Thus power efficiency, size, and weight became important factors in the design philosophy. In addition, cost and time restraints forced the use of off-the-shelf components wherever possible.

### 2.2.1 Power Source

The most important decision was the choice between an electrohydraulic and an electromechanical-powered manipulator system. An electromechanical system was chosen for the following reasons:

- Off-the-shelf components for an electrohydraulic system such as cylinders, pistons, pump, and valves are larger in size and weight and are clumsier than the counterparts for the electromechanical system.
- The power consumption of a hydraulic system is greater because the pump has to be operated during the entire operating time of the manipulator system, while an electromechanical system consumes energy only during the periods when the linkage and joints need to be actuated.
- Dc motors start and stop smoothly and both high and low speeds are easily obtained while the movement rate of a fluid system is not easily adjustable during operation.
- The wiring system is much simpler than an electromechanical system, while complex internal fluid routing plus wiring is required for position feedback devices of an electrohydraulic manipulator system.
- The outside mechanical configuration of a manipulator with electric drives tends to be smoother and sleeker than a hydraulic-powered manipulator with external hydraulic lines feeding each motor. A smooth and sleek mechanical design helps prevent entanglement in the underwater work environment.

### 2.2.2 Electric Drive Assembly

At operating depths of 2000 feet, electric drives need to be internally pressurized to balance the external pressure. Otherwise, the sealing of



shafts becomes impractical. The most common method of pressure-balancing an electric drive is to place it in a fluid-filled housing with some sort of flexible pressure equalizing below. All fluid-immersed parts have to be compatible with the chosen fluid. The rated voltage to drive the motor must be kept low to reduce electrical arc-ing of the brush contacts, which generates gases. Because of the higher viscosity of fluids in relation to air, all revolving parts should turn as slowly as possible to reduce rotational losses and hydrodynamic brush lifting, which would also cause arc-ing.

### 2.2.3 Electric Motor

An induction (or squirrel-cage) motor does not require brushes and it could, therefore, be run immersed in oil or even in salt water. However, to develop the high starting torques which are necessary to move the manipulator joints, this motor type requires high starting currents. Thus one would need relatively heavy motor controllers to invert the vehicle battery voltage, to control motor speeds, and to filter the ripple voltages. The only off-the-shelf motor type found to meet all requirements was a permanent-magnet, armature-excited, continuous-rotation dc motor. This motor type delivers high torques at low speeds and low input power. It is probably the most linear kind of servoactuator; stall torque and no-load speed are almost perfectly linear functions of applied voltage. Because of its fast response and smooth linear characteristics, the direct-drive dc torque motor is recommended where accurate tracking over high-speed ranges are required. The ability of a permanent-magnet dc torque motor to convert electrical power input to torque is proportional to (1) the square root of the product of total magnetic flux linking the winding from the field and (2) the magnetomotive force established by the excited armature winding. This ability can be represented by

$$K(M) = \text{Torque}/(\text{Power Input})^{1/2}$$

### 2.2.4 Gearing

A gearless torque motor drive would be ideally suited to drive the manipulator joints. The absence of gearing would eliminate errors caused by friction, backlash, and other gear inaccuracies, and would be free from noise caused by bearing play. But a dc torque motor which would deliver the recommended torques to move the manipulator joints would be too heavy and would consume too much electrical power. An off-the-shelf unit found to both optimally meet the requirements and mate with the pancake-shaped dc-torque motor is the harmonic drive power transmission. This transmission operates on a patented principle which employs a deflection wave transmitted to a nonrigid flexpline member to produce a high mechanical advantage between concentric parts. Harmonic drive units allow ratios from 80 to 320 in a single reduction, and they also allow torque outputs equal to drives twice their size and three times their weight with efficiencies up to 90%. The standard harmonic drive unit has very low backlash and thereby minimizes potential stability problems. Since some 10% of the teeth are in continuous engagement, the effect of tooth-to-tooth error is minimized and accuracy in the arc-second range is obtainable with excellent repeatability. Because there are no radial loads generated during the transmission of torque, the support housing can be lightened. Because the harmonic drive gearing will allow a given joint to back drive, it self-protects the manipulator joints in the presence of dynamic

overloads. If the design is not well thought out, however, the stiffness of a joint incorporating a harmonic drive unit might be less than that of a joint using a spur gearing because of the natural flexibility of the flexpline.

### 2.2.5 Sealing Techniques

A significant problem in designing electromechanical systems for underwater use is to choose the right sealing techniques to prevent seawater intrusion or loss of oil. Compensating the pressure differences by using fluid-filled motor housings reduces the problem significantly. An O-ring was chosen for the rotary seal between the inner and outer housing of the motor units (see appendix A). The O-ring is squeezed between the inner housing and the gland in the retainer ring by about 10 to 15% of its original cross-sectional diameter. This compression absorbs the tolerance stackup between inner and outer housing and forces the O-ring into microscopic grooves on the metal surfaces. To seal the potentiometer cover against the outer housing, one O-ring is used in the so called "crush" installation. In this instance, the O-ring is crushed into a triangular space between both motor unit parts which has 92.5% of the volume of the O-ring.

Compatibility between the O-ring and the fluids with which it will be used is another major design problem. Nitrile or Buna N (NBR) is today the most widely used elastomer in the seal industry. In fact, most military rubber specifications for oil-resistant O-rings require nitrile-base compounds. Because of their fair chemical resistance and their poor resistance against ozone, which might be generated by brush arc-ing, O-rings made of fluorocarbon rubber (FPM) were chosen. Table 1 shows the advantages of FPM against NBR.

| Factor              | Nitrile or<br>Buna N | Fluorocarbon   |
|---------------------|----------------------|----------------|
| Ozone resistance    | Poor                 | Excellent      |
| Weather resistance  | Fair                 | Excellent      |
| Chemical resistance | Fair/good            | Excellent      |
| Oil resistance      | Excellent            | Excellent      |
| Abrasion resistance | Good                 | Good           |
| Set resistance      | Good/excellent       | Good/excellent |
| Acid resistance     | Fair                 | Excellent      |
| Water resistance    | Fair/good            | Fair/good      |
| Flame resistance    | Poor                 | Excellent      |
| Dynamic properties  | Good/excellent       | Good/excellent |
| Age resistance      | 2 to 5 years         | 5 to 10 years  |

Table 1. Comparison of nitrile-based versus fluorocarbon-based seals.

All other metal-to-metal connections which are exposed to seawater were sealed with anaerobic adhesive, in which single-component, solventless metallic ions are present. These compounds can fill the entire space (from about 0.001 to 0.030 inch) between metal parts and harden without shrinkage. The cured adhesives form a bond that conforms to the adjoining surfaces and prevents leakage, and can withstand corrosive action of most hydraulic fluids,

industrial acids, chemicals, solvents, and gases. During the assembly procedure of the motor units, several grades of those anaerobic adhesives and sealants were used as sealants, fasteners, and locking materials.

### 2.2.6 Bearings

By using Kaydon Reali-Slim ball bearings, the outside housing diameters could be minimized because of the thin cross section of these bearings. The Type X bearing was chosen because of its ability to resist radial thrust and moment loads in any combination. A pair of FAG Angular Contact ball bearings holds the motor shaft in position. The chosen bearing (7000-series) is designed for medium to high speeds, and with a contact angle of 25 degrees it can carry heavy and radial loads combined with medium thrust loads in one direction. Because of the thin cross section of the bearing, the supporting housing parts could be minimized.

## 2.3 STRUCTURE ELEMENTS

The motor units which drive the manipulator joints are connected to the arm structure elements by lightweight laminated glass-fiber parts with epoxy resins. A washcoat 5 to 10 mils thick prevents intrusion of water. No pigments have been used in the layup process to allow easy visual inspection of the parts. The laminate design is capable of withstanding hydrostatic pressure of 1000 psi. The structure part which connects shoulder and elbow joints is filled with 32-lb/ft<sup>3</sup> syntactic foam to provide buoyancy underwater. Use of glass-fiber-based epoxy resin has the following advantages:

- Light weight (has 30% weight saving over aluminum).
- Insulated (no electrolytic reaction with aluminum parts).
- Noncorrosivity.
- Easily manufactured.
- High flexural strength (65 000 psi min).



## 3.0 SYSTEM DESCRIPTION

### 3.1 GENERAL DESCRIPTION

The manipulator resulting from the approach described above is shown in fig 4. The outside physical design is relatively smooth and sleek, with few protruding areas susceptible to potential entanglement. The three-finger design allows the manipulation of both small objects, by using the "finger-tips" or ends of the claw (fig 5), and of relatively large objects by using the inner portion of the claw (fig 6). The portions of the manipulator constructed of fiberglass are shown in fig 7 as laid out on the full-size assembly drawing of the arm (fig 8) before final painting. The upper arm segment is filled with syntactic foam to provide buoyancy in the water and reduce the load weight of the manipulator upon itself. The vacant areas in fig 7 are linked together by using the hard black-anodized aluminum underwater motor housing assemblies described in detail in appendixes A and B. The larger housings (appendix A) are used for the shoulder rotation and shoulder pivot. Four smaller motor assembly units (appendix B) are used for the elbow pivot, wrist rotate, and combination wrist pivot/jaw closure. These six motors then provide jaw closure in addition to five degrees of freedom.

### 3.2 PERFORMANCE SPECIFICATIONS

The operation of the manipulator was found to be extremely smooth and quiet. To date, it has been operated by using only a set of switches which individually represent actuation of each motor. Final integration of the unit into a computer-controlled system is planned for FY 1981.

The manipulator design (fig 8) consists of

- Shoulder rotation (motor unit I with HDC 1M-100-2 gear).
- Shoulder pivot (motor unit I with HDC 1M-200-2 gear or interchangeable 1M-100-2).
- Upper arm, 15 inches long.
- Elbow pivot (motor unit II with HDUF 20-160-2 gear).
- Forearm, 9.75 inches long, which contains a motor unit II (HDUF 20-80-2 gear) for wrist rotate.
- Combination of wrist pivot and individual moveable three-finger-type hand consisting of two motor units II (HDUF 20-80-2 gear).
- Two claws, 7.25 inches long (wrist to fingertip).

Other major features are as follows.

- Lift capability in fingertip with fully extended arm: 8 pounds in air, 12.5 pounds in salt water.

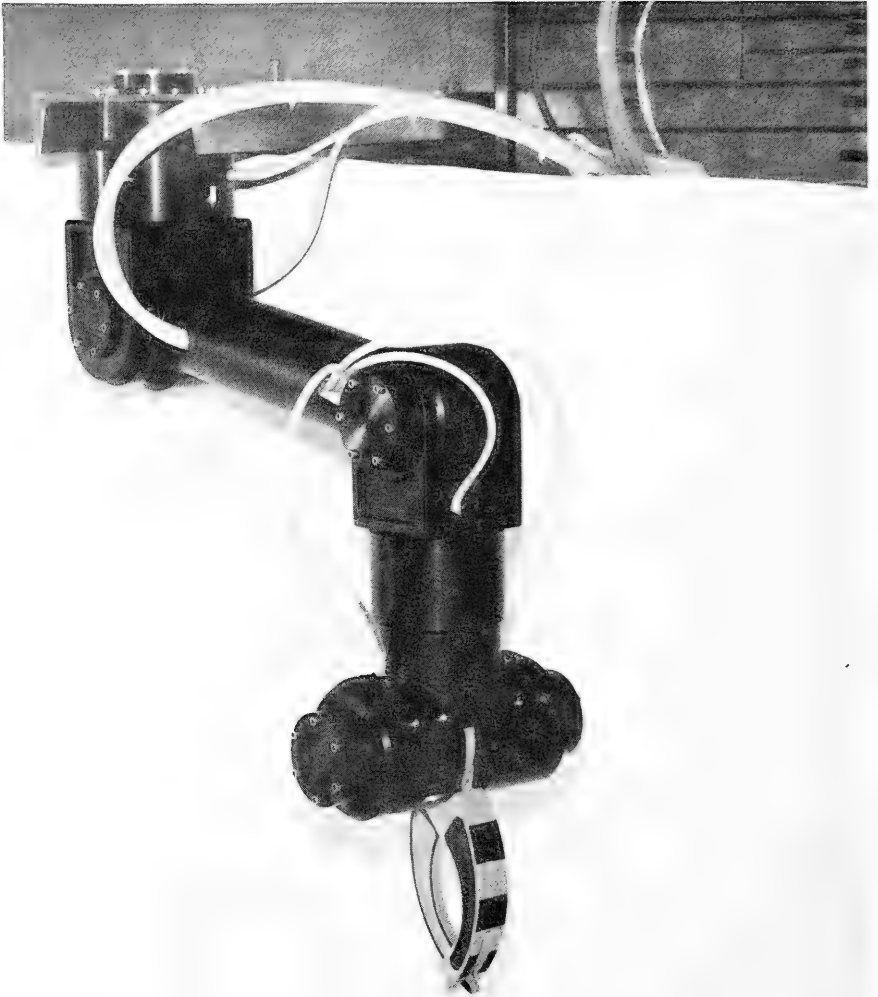

Figure 4. The final underwater manipulator configuration as mounted in a test support apparatus in the laboratory.



Figure 5. Manipulator shown grasping small object with "fingertips."

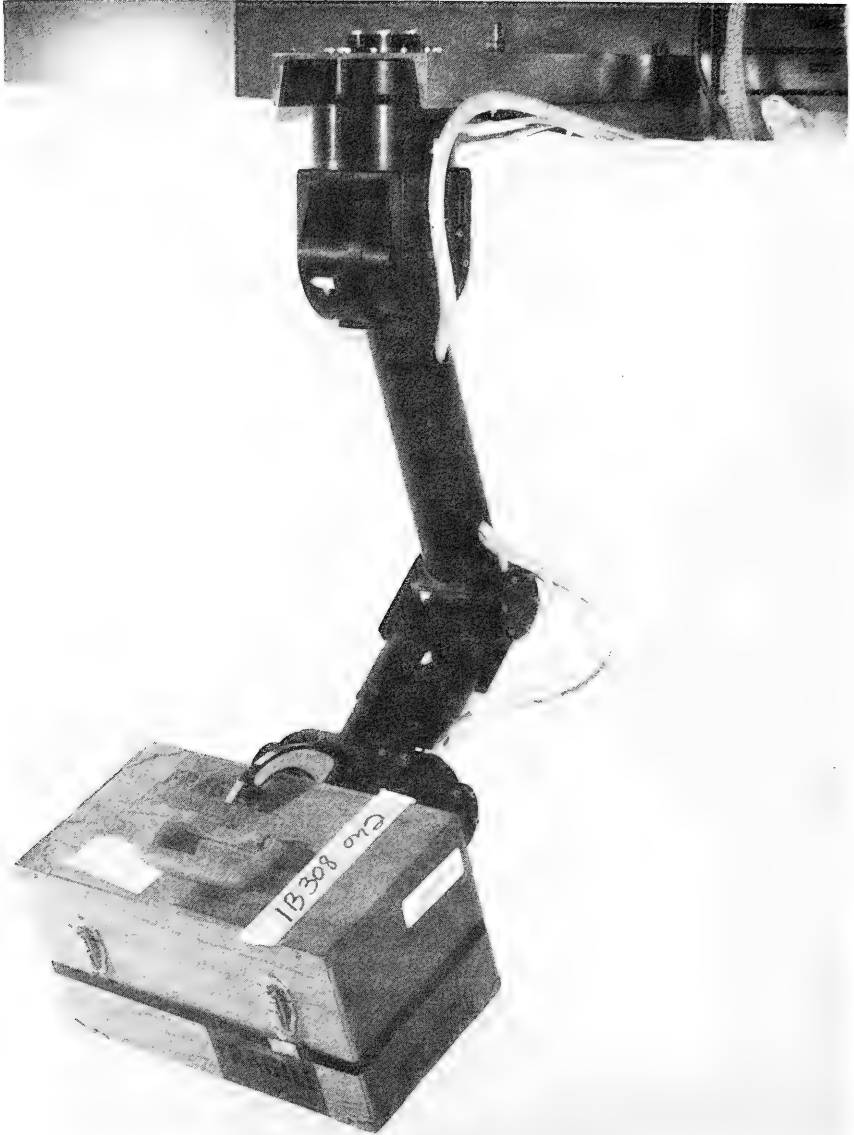

Figure 6. Manipulator shown grasping large object.



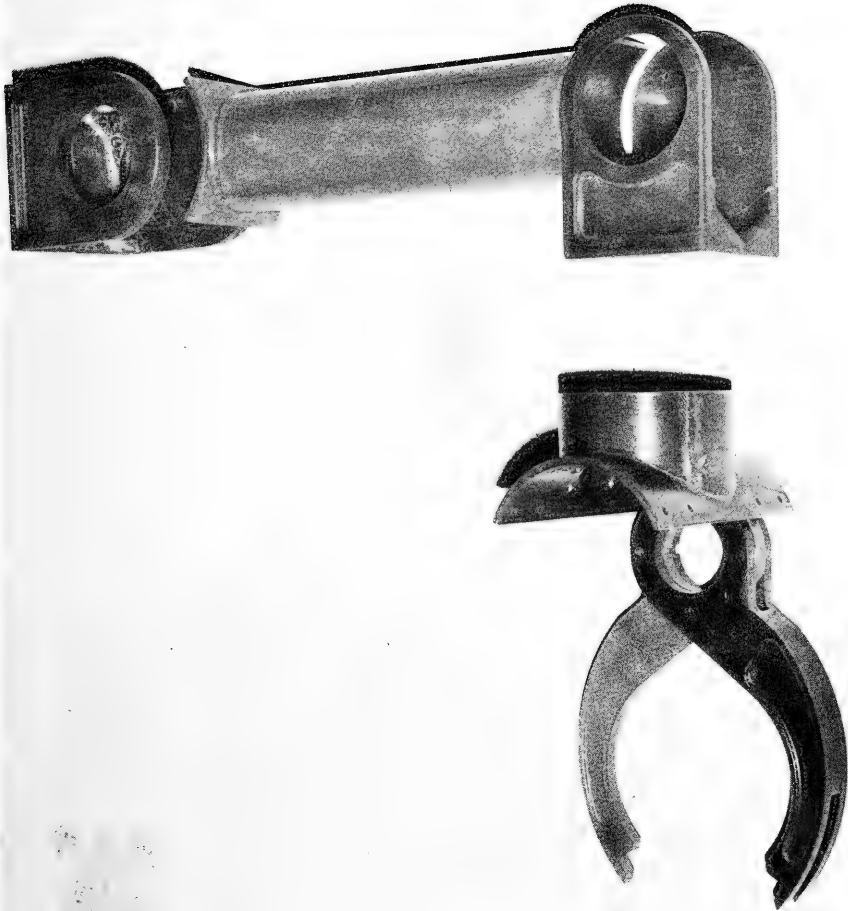

Figure 7. The fiberglass portions of the manipulator (before painting).

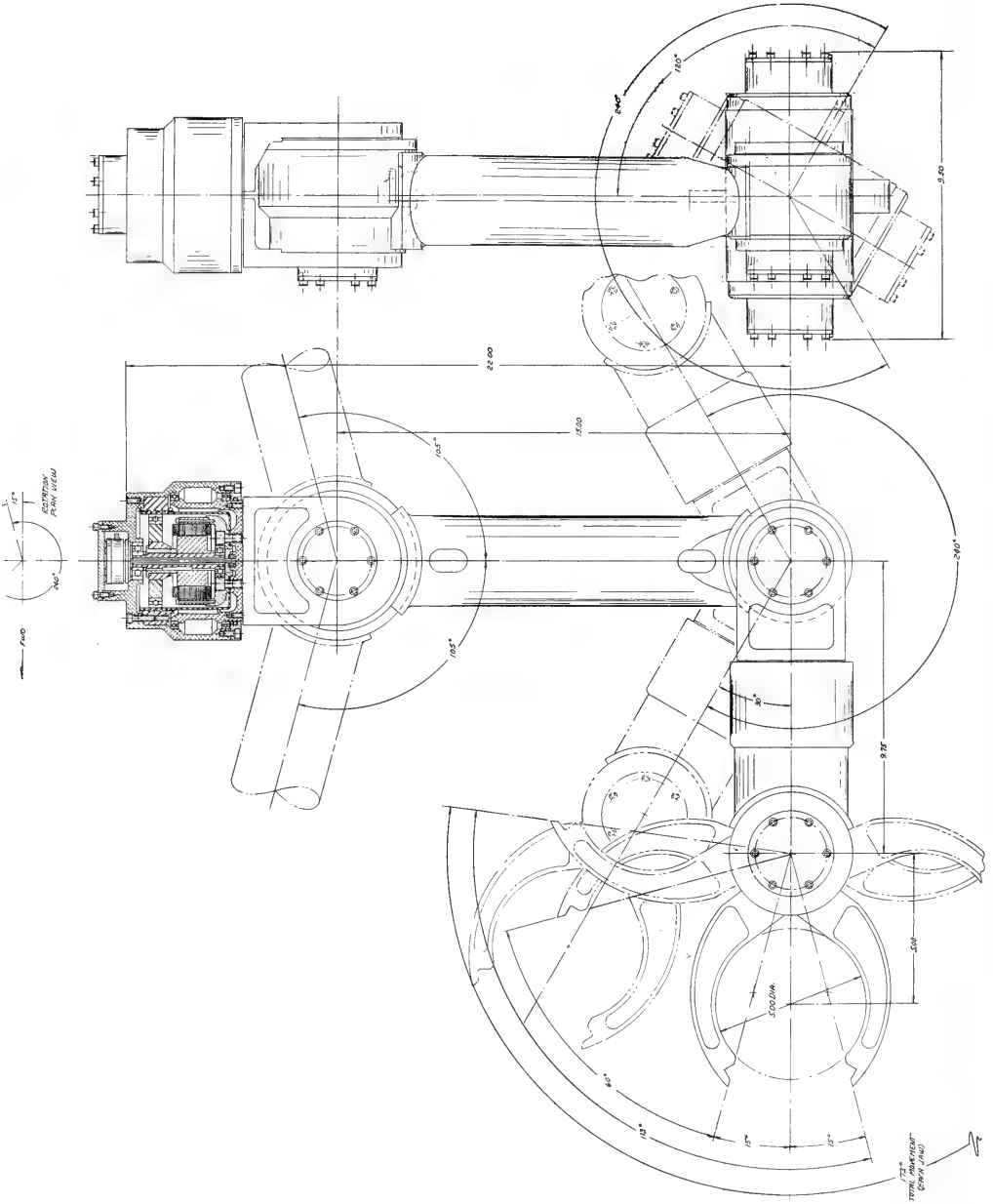

Figure 8. Manipulator assembly drawing showing the movement angle for each joint.

- Lift capability in claw center with fully extended arm: 9 pounds in air, 14 pounds in salt water.
- Manipulator weight: 35 pounds in air, 20.2 pounds in salt water.

Each motor unit is driven by a low-speed dc torque motor with a one-step gear reduction (see assembly drawings: foldout assembly of motor units I and II). Position feedback is provided by one installed potentiometer per motor unit. The system operates on 24-V electrical power (dc).

### 3.3 SYSTEM INTEGRATION

Plans are to incorporate the manipulator into a total supervisory-controlled configuration during FY 1981. This final hardware configuration (fig 9) will consist of a topside LSI/11-23 computer interfacing with a very simple lightweight master arm and operator feedback CRT display located in a topside console. A similar LSI/11-23 computer will be located in the left forward housing on the free swimmer. This computer will then provide resolved position control of the manipulator and interface with the topside computer through a fiber-optic link (ref 7). The fiber-optic link can then later be replaced with an acoustic link that takes advantage of the relatively low bandwidth required to operate the manipulator in a supervisory-controlled configuration. A vehicle-mounted underwater television camera and light will provide the operator with sensor feedback from the manipulator and task environment during operation. This sensor data will also be transmitted through the fiber-optic link by using pulse frequency modulation (PFM) techniques (ref 8) and a multiplexing technique to place digital-control sensor information on the video retrace (ref 7). When the fiber-optic link is replaced with an acoustic communication command and control link, the television data will also be transmitted acoustically via slow-scan techniques developed fairly recently at NOSC (ref 9, 10, 11). A picture resolution of 256 by 256 elements has been achieved at depths to 3720 feet with an update rate of 32 seconds. An 8-second update rate was achieved from 128-by-128-element resolution displays. It is hoped that this information, plus an updated transmission of key points located on the manipulator, will be sufficient for the control of a supervisory control configuration. Concepts involved in working out such problems of man/machine interface are the subject of continuing research and development on a program being conducted jointly by MIT and NOSC. Technological problems to be attacked under this follow-on program are as follows:

1. The validation of operator performance models with supervisory-controlled teleoperator systems.
2. The investigation of control/display factors that most significantly mediate operator control performance (eg, the allocation of control functions between the operator and computer components, the dynamics of operator-computer interaction, and the effects of limited bandwidth and degraded visual feedback).
3. The use of a measurement arm to facilitate operation when relative motion is present between the vehicle and the work site.
4. The use of electrically induced compliance to facilitate final approach and grasp operations.

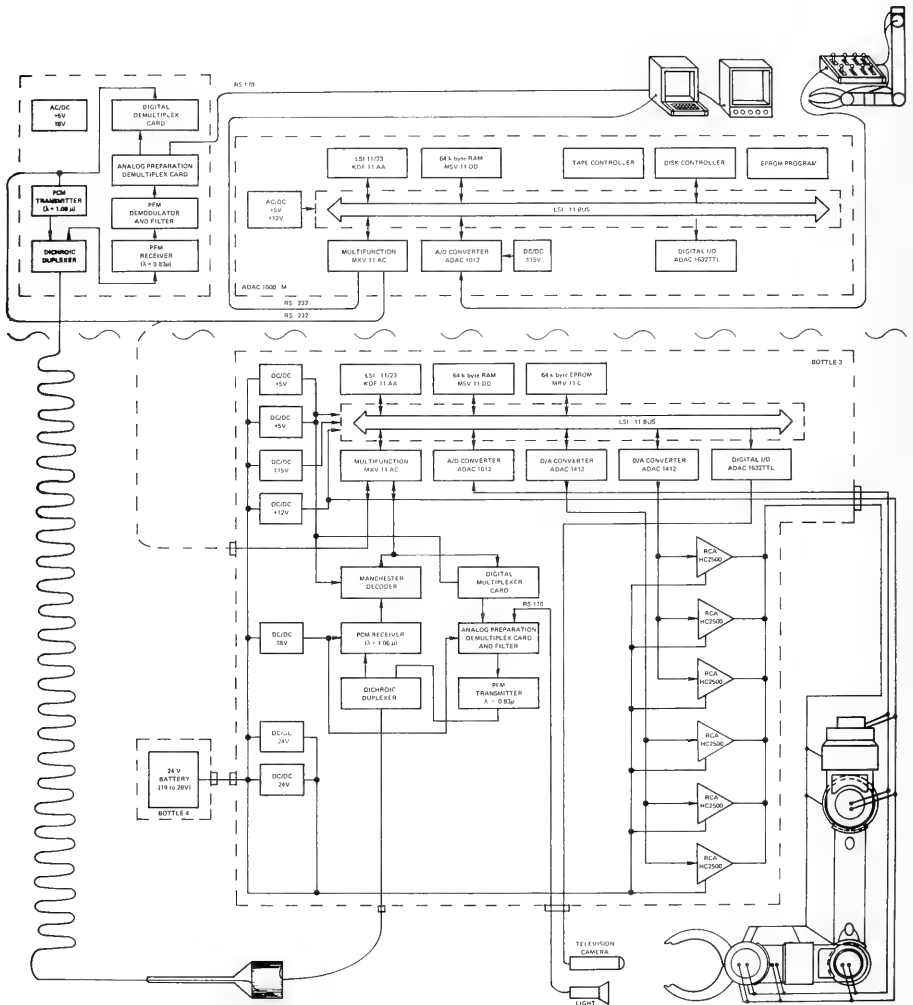

Figure 9. NOSC free-swimmer manipulator supervisory control block diagram.

5. The use of low-bandwidth measurements of the position of the endpoint of the manipulator to update slow-scan television pictures as to the status of the manipulator position.

Further details on future research and development plans, as well as plans for the integration of the entire manipulator control concept, are given in ref 12.

#### 4.0 CONCLUSIONS AND RECOMMENDATIONS

The manipulator described in this report was developed by NOSC to allow interfacing with the latest advanced concepts in man/machine interface and supervisory-controlled teleoperator systems research being conducted by MIT. The resulting manipulator, designed, fabricated, and laboratory-tested at NOSC, appears to be quite satisfactory as a testbed for these advanced control concepts. The oil-filled, pressure-compensated motor assembly design, incorporating potentiometer feedback and harmonic-drive gearing, represents one of the most compact underwater designs of its kind in existence. The sleek exterior design, together with the smooth, quiet operation of the entire manipulator configuration, are noteworthy features.

Current efforts are directed toward the development of algorithms for supervisory control of the manipulator. These efforts include the integration of the two LSI/11-23 computers, which will link the vehicle computer with the surface command console. Laboratory and field tests are planned to verify fundamental system design principles and to demonstrate the performance effectiveness of these control concepts.

It is recommended that the manipulator and the EAVE WEST free-swimming vehicle now be used to attack the advanced research and technological problems listed in the system integration section (3.3) of this report.

APPENDIX A

ASSEMBLY PROCEDURE FOR  
LARGE MOTOR ASSEMBLY

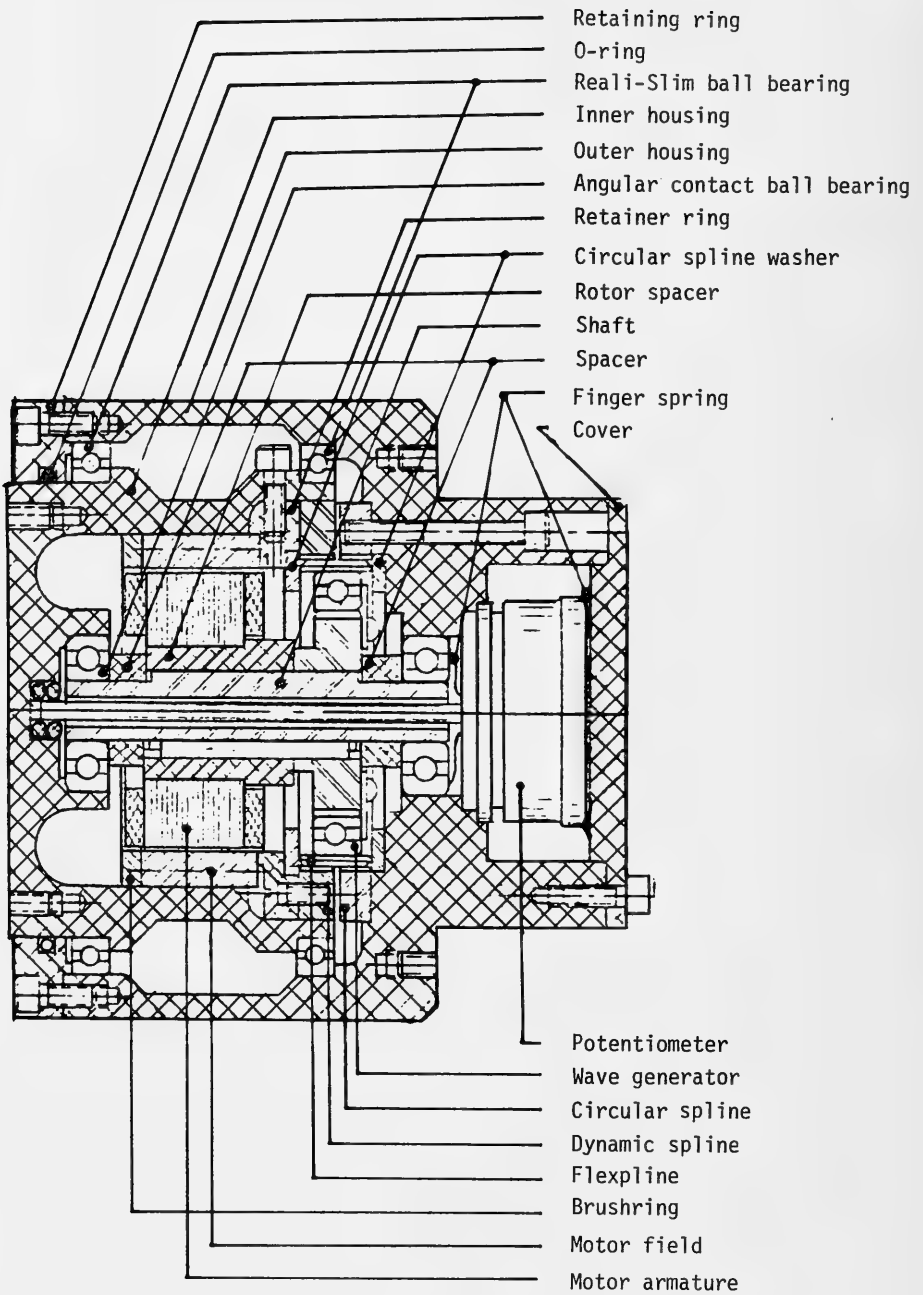

CROSS SECTION OF MOTOR UNIT II



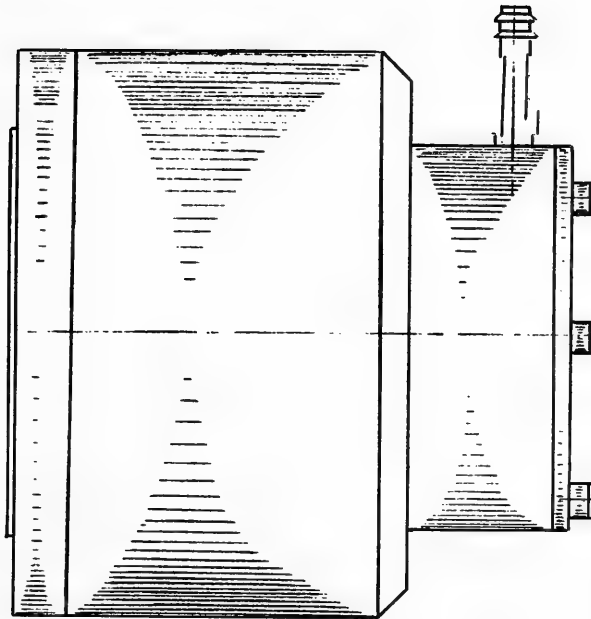

ELBOW

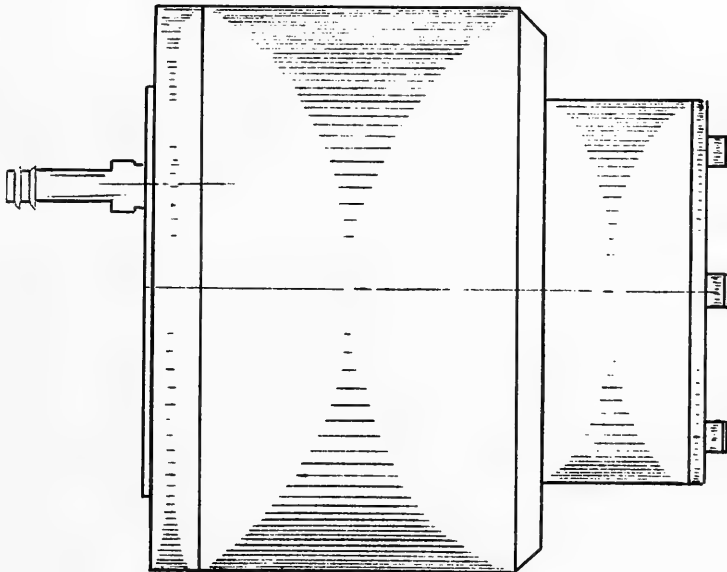

WRIST ROTATION

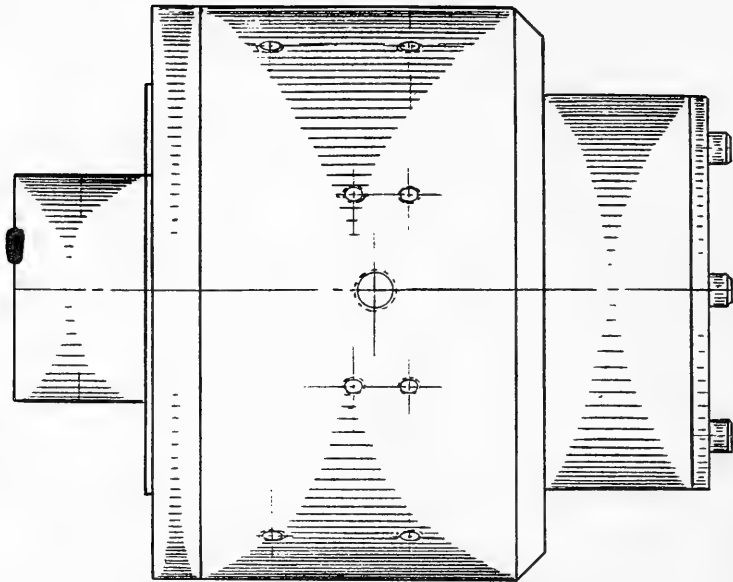

UPPER CLAW

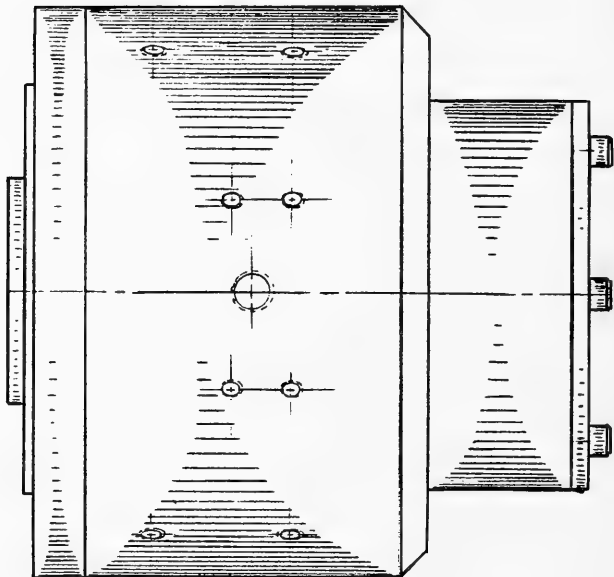

LOWER CLAW



## ASSEMBLY PROCEDURE

1. Clean all metal surfaces very thoroughly. Make sure that all deposits from previously used liquids such as cutting oils, masking paints, galvanic solutions, etc, are removed.



2. Put Loctite Quick Set 404 adhesive on the outside diameter of two O-rings (Parker no 2-104 V747-75). Push the O-rings into the bore so that they just fit inside. Cover the adhesive bond with Loctite water-proofing solution.

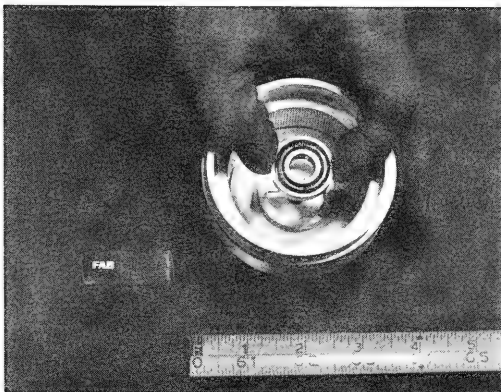

3. Press the angular contact ball bearing (FAG no B.7000.E) into the inner housing so that it can take a thrust load in the direction of the inner housing. Make sure not to transmit pressure or impact through the rolling elements of the bearing while pressing it in.

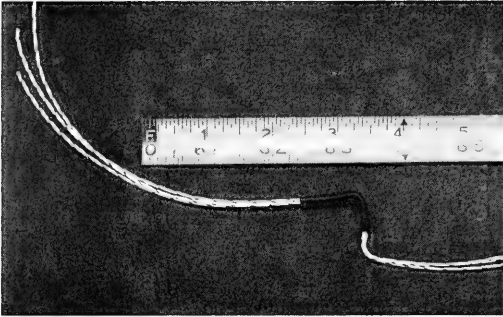

4a. Wrist rotate, upper claw, lower claw: Run three Teflon-insulated, 22-gauge wires through the outer housings and keep them in position, as shown, with an appropriate bond. Strengthen and protect the parts of the wires which run through the bore with pieces of heat-shrinkable tubing.

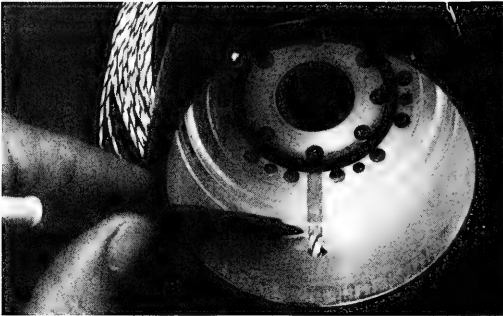

4b. Write rotate, upper claw, lower claw: Run two twisted Teflon-insulated, 22-gauge wires through the fitting and let them stick out of the housing (not shown in the photograph).



4c. Elbow pivot: Proceed with three wires as described in 4a, but instead of running the wires through the fitting, let them stick out of the outer housing.

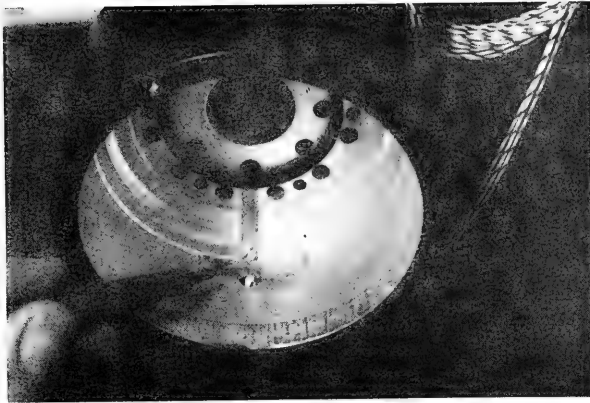
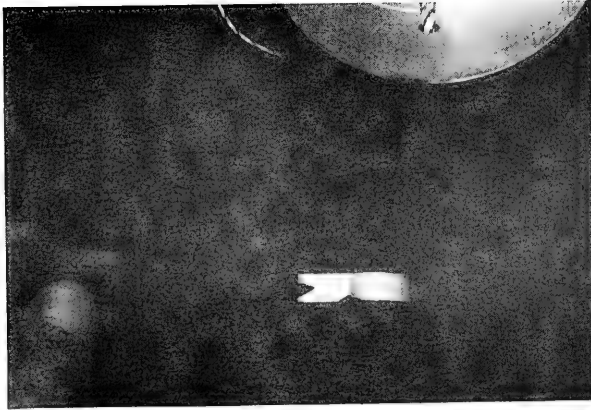

5a. Wrist rotate, upper claw, lower claw:

Bond a piece of thick aluminum foil over the wires as shown in the photograph. Use an appropriate bond. This is to ensure that the wires will not be hooked onto the socket-head screws which will hold the retainer ring onto the inner housing.

5b. Elbow pivot:

Bond a piece of thick aluminum foil over the wires at the same place as shown for the wrist rotate, upper claw, and lower claw (5a).

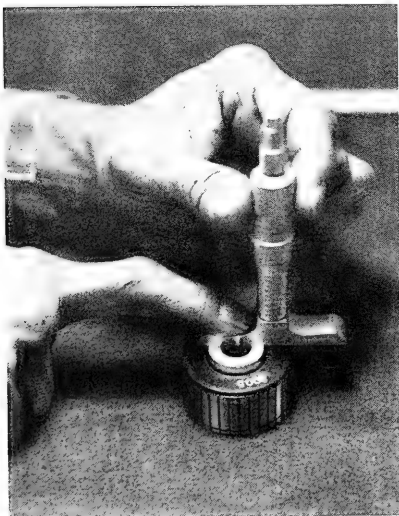
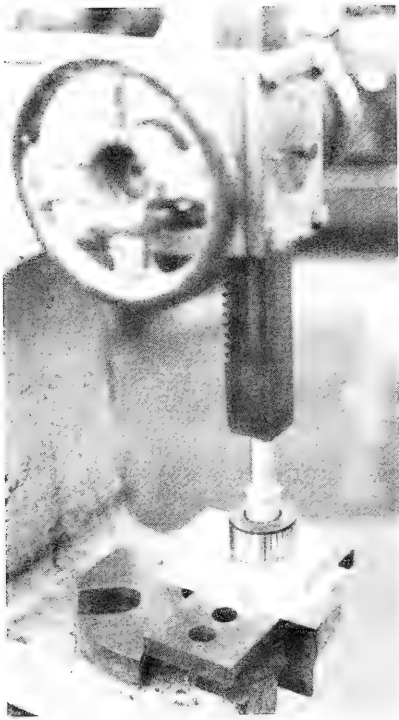

6. Put some Loctite 290 adhesive/sealant onto the rotor spacer and press the rotor spacer into the motor armature. The rotor spacer is in place when the distance from the surface of the rotor spacer to the surface of the motor armature (coil) is  $0.174 \pm 0.001$  inch.

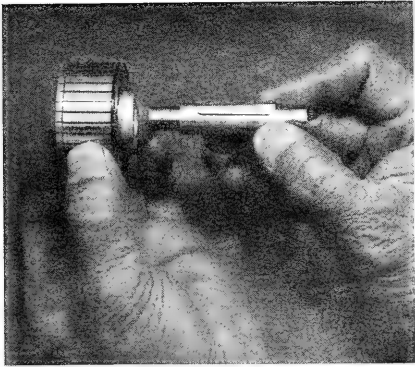

7. Press the key into the keyway or the shaft. Put some high-quality approved oil (MIL-L-6085A, MIL-L-870A, MIL-L-644A) with a viscosity index of 70 on the surface of the shaft and the keyway. Put the shaft, as shown, into the rotor spacer and add the spacer.

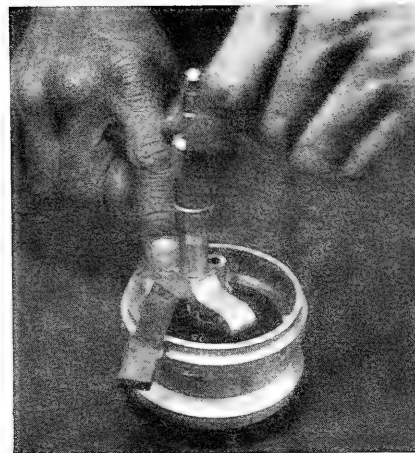

8. Put shaft into the ball bearing in the inner housing. The motor armature is in place when the distance from the inner housing surface to the surface of the rotor spacer is  $0.279 \pm 0.002$  inch.
9. Remove the shaft with spacer and motor armature.



10. With the motor armature (with the rotor spacer in place) push the keeper out of the motor field.

**ATTENTION:** Removing the keeper without substituting it with the field;

- or placing the field on steel shelves or benches, unless separated from the steel by at least one-half inch of nonmagnetic material;

- or letting the field come in contact with the ferrous tools or measuring instruments

will demagnetize the field up to 50%.



#### **HANDLING, STORAGE, INSTALLATION**

Greater care is required for handling frameless dc torque motors than for housed units or conventional ac motors. The armature field and brush assembly are supplied as a matched set identified serially and should not be interchanged with other components. They are packaged separately in the shipping container. During unpacking and handling and throughout installation care must be taken to avoid bending or distorting the brush assembly springs and to protect the commutator surfaces from scratching or contamination by oil or fingerprints. The field is supplied with a "keeper" ring attached by magnetic force, which must not be removed until the field is installed and the armature is in place. To do so will result in approximately 1/3 reduction in torque sensitivity.

Frameless units should be stored in nonmagnetic racks or containers — the shipping container is suitable — to prevent interaction of magnetic fields. Attraction of magnetic particles also should be avoided. Protect the armature core from moisture with desiccant.

#### **COMPONENT PARTS— DEFINITIONS**

**Armature.** The rotating element. The windings are in this part.

**Commutator.** A conductive segmented ring on the armature, which allows electrical power to be transferred to the winding from the stationary elements.

**Field.** The stationary permanent magnetic flux field in the motor air gap.

**Brush Assembly.** The stationary insulating ring, or segment supporting spring-loaded electrical contacts (brushes), which slide on the commutator to transfer the dc power.

**Keeper.** A magnetic steel ring installed on the field to keep the magnets at full strength until the armature is fully in place. The normal keeper type is shown in the above installation instructions. Other types sometimes are used for magnetic or assembly reasons.



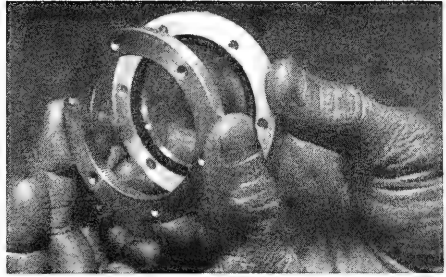
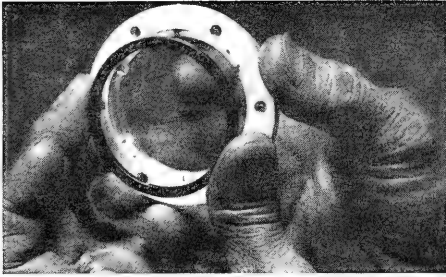

11. Assemble circular spline washer, dynamic spline, and retainer ring; bring them in line and screw them loosely together.
12. Gently press this unit into the inner housing with the dynamic spline down. Then screw dynamic spline and retainer ring tightly together with the six countersunk screws.
13. Get the unit out of the inner housing. Take one screw out, put Loctite 290 adhesive/sealant on the thread and replace the screw tightly. Proceed until all bolts are locked.

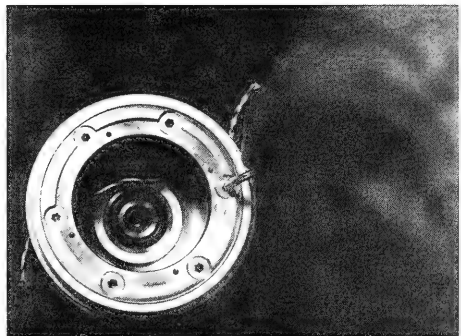
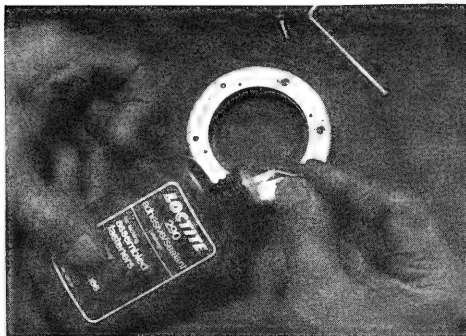

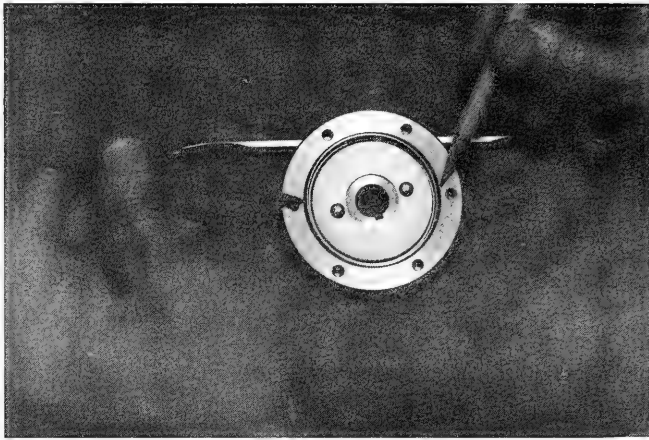

14. Put a few drops of high-quality approved oil (see step 7) in the wave generator and onto the teeth of the flexpline.
15. Install the wave generator with the flexpline into the dynamic spline (fastened to the retainer ring) so that the teeth mesh concentrically. Check this visually or with a feeler gauge.
16. Put the circular spline on the flexpline so that the teeth mesh concentrically. Check this visually or with a feeler gauge.

### ASSEMBLY

It is essential that the C/S and F/S toothmesh concentrically engage for proper function as noted below. The unit will function in what is defined as the "dedoidal" state but will be subject to reduced life.

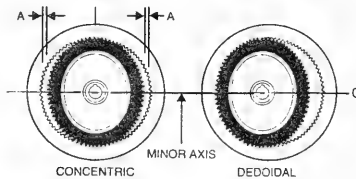

When the toothmesh is exposed, a visual or feeler gage check for equal tooth clearance (A) is made as noted above.

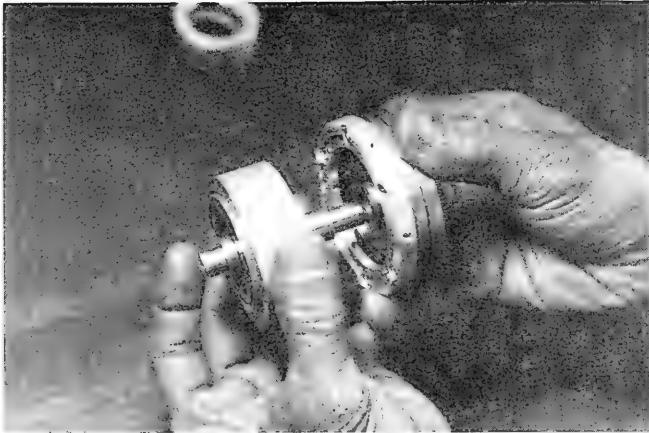

17. Assemble the harmonic drive gearing unit with the motor unit. Make sure that the motor armature does not move out of the motor field.



18. Secure the field with the four countersunk screws.
19. Get one screw out, put Loctite 290 adhesive/sealant on the thread and tighten the screw carefully. Then proceed until all four screws are locked.

20. Screw in, as shown, two temporary pins (to make sure that, during the handling of this unit, the armature cannot slip out of the field in the direction of the harmonic drive gearing).

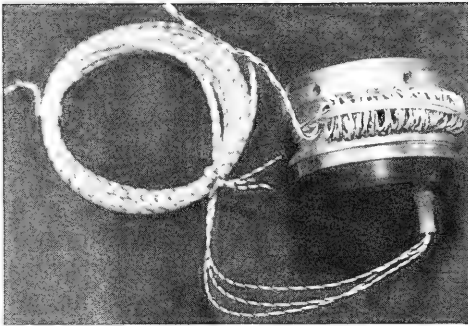
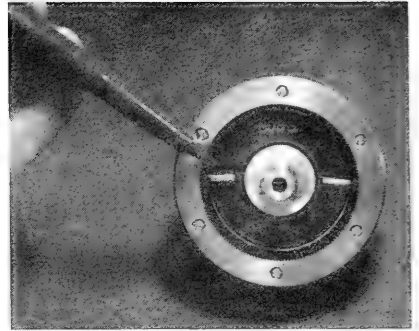

- 21a. Write rotate: Twist three Teflon-insulated, 22-gauge wires together and build a coil with about 20 turns. Strengthen and protect the part of the wires which go through the hole of the fitting with pieces of heat-shrinkable tubing. Put that coil, as shown, on the inner housing and secure the coil temporarily. Twist two Teflon-insulated, 22-gauge wires together and thread them through the fitting. Secure these wires with heat-shrinkable tubing so that they don't come out of the housing if the wire comes under tension from outside the motor unit (see picture on opposite page).

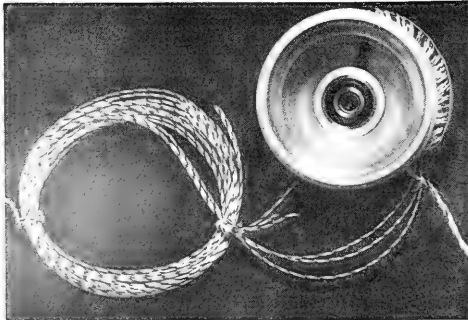

- 21b. Elbow pivot, upper claw, lower claw: Twist two Teflon-insulated, 22-gauge wires together and build a coil with about 25 turns. Strengthen and protect the part of the wires which go through the hole into the inner part of the inner housing with pieces of heat-shrinkable tubing. Put that coil on the inner housing and secure the coil temporarily.

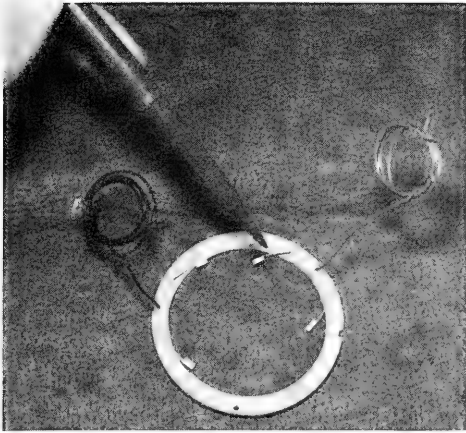

23. Connect the brushring, as shown, with the two wires which stick out of the inner part of the inner housing. Secure and insulate the soldered joints with heat-shrinkable tubing. Make sure that the wires are long enough so that it is possible to repeat this procedure in case the replacement of motor parts is necessary. Make sure also that the wires don't touch the brush springs or the armature when assembled.

24. Put the brushring on the armature by setting one set of brushes on the commutator and gently compressing the remaining brush springs and sliding them onto the commutator.

NOTE: The commutator should remain clean of fingerprints and scratches. All possible precautions should be taken to prevent silicone contamination of the commutator or the brushes.

25. Put Loctite 290 adhesive/sealant on the thread of the two countersunk screws and secure the brushring.

22. Bend the brush springs very carefully so that they remain like the pair of brushes pointed out in the picture. Avoid distorting. The original spring position is shown on the opposite pair of brushes. Position one set of brushes on the commutator, then gently compress the remaining brush springs and slide them onto the commutator. The brushes have to contact the commutator along the whole length of the brush. If the brushes are canted, distorted, or shifted, remove the brushring gently and bend the brush springs as necessary. Proceed until they fit correctly and then remove the brushring before proceeding in the assembly.

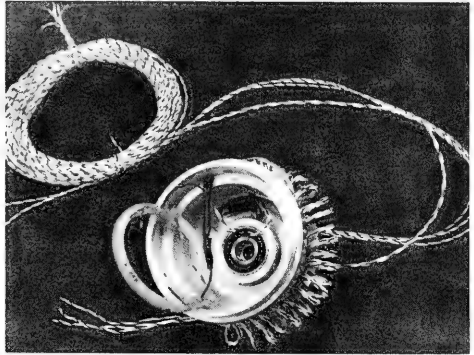

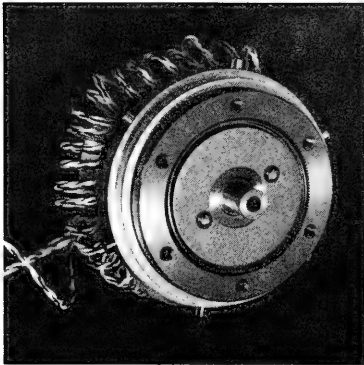
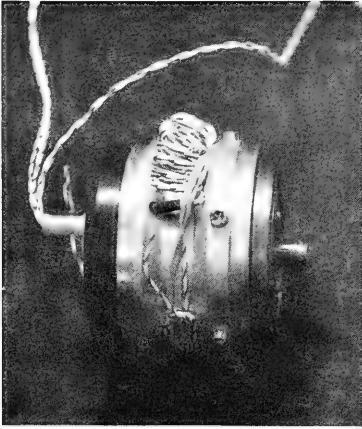

26. Put a few drops of high-quality approved oil (see step 7) into the angular contact ball bearing.
27. Slip one spacer on the shaft from the brushring side.
28. Very gently insert the motor bearing unit in the inner housing. Make sure that during the insertion the motor armature does not move out of the motor field (this would bend or destroy the brush springs). Make sure the wires don't touch the brush springs or the armature. Make sure the wires don't remain between the ball bearing and the spacer. Make sure the holes in the retainer ring match with the holes in the inner housing. – Your first try will probably fail, so try again. Patience is required.
29. Remove the two temporary pins. Make sure that during the following assembly the motor armature does not move out of the motor field!
30. Screw the retainer ring and inner housing tightly together with the six socket-head screws.
31. Take one screw out. Put Loctite 290 adhesive/sealant on the thread and replace the screw tightly. Proceed until all screws are locked.

32. Press the Reali-Slim ball bearing (Kaydon bearing no KA 030 XPO) onto the inner housing so that the non-interrupted part of the bearing separator faces to the coil on the inner housing. Make sure not to transmit pressure or impact through the rolling elements of the bearing while pressing it onto the inner housing.
33. Put a few drops of high-quality approved oil (see step 7) into the gap between flexpline and circular spline and into the Kaydon ball bearing.



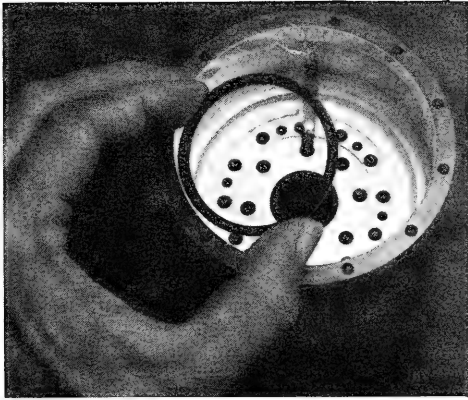

34. Put the circular spline washer into the outer housing.

35. Put outer and inner housings together and solder the wires from the coil on the inner housing with the wires sticking out of the outer housing. Secure and insulate the soldered joints with heat-shrinkable tubing. Make sure that the wires are long enough to repeat this procedure in case the replacement of motor parts is necessary (see step 27).
36. Bend the soldered joints back into the outer housing. Take out what was used to secure the coil on the inner housing and press both housing parts together until the Kaydon ball bearing fits into its seat in the outer housing (see the assembly drawing from page A-1 and step 27).

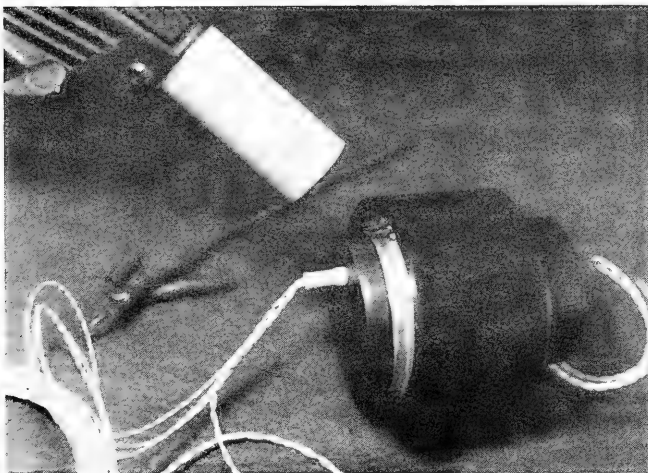

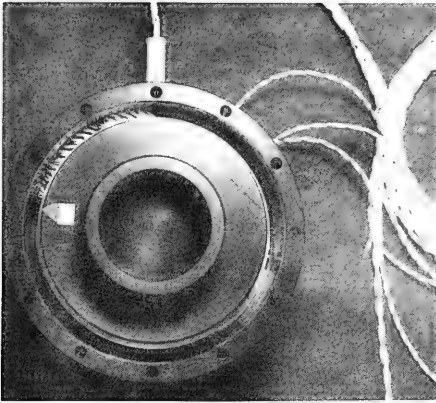

37. Mark the possible movement from the compressed coil to the stretched coil on the inner and outer housings.

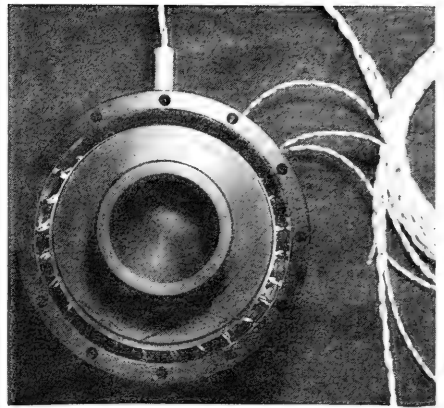

38. Press the Reali-Slim ball bearing (Kaydon bearing no KA040 XPO) into the housings so that the noninterrupted part of the bearing separator faces to the coil on the inner housing. Make sure not to transmit pressure or impact through the rolling elements of the bearing while pressing it into the housing.



39. Put a few drops of high-quality approved oil (see step 7) into the Kaydon bearing.

40. Put the O-ring (Parker no 2-155-V747-75) into the groove of the retaining ring.
41. Put a few drops of high-quality oil on the O-ring surface.

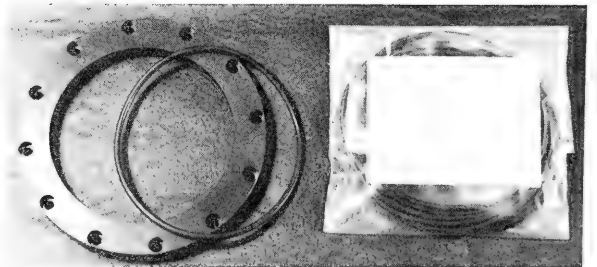



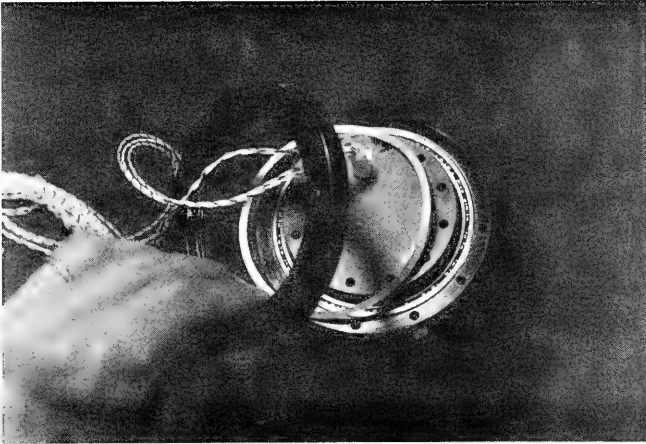

42. Gently press the retaining ring in position and screw the parts together.
43. If the two housing parts are too loose, place an aluminum foil washer between the Kaydon bearing and the retaining ring (not shown).

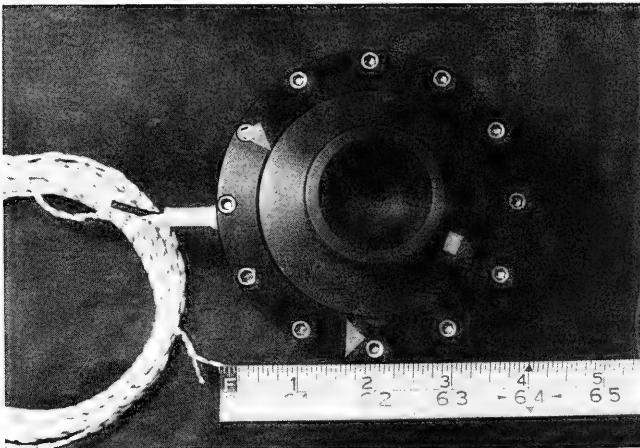

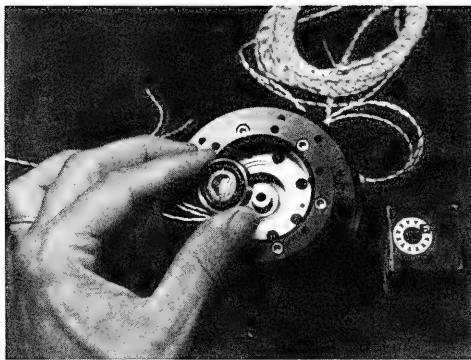
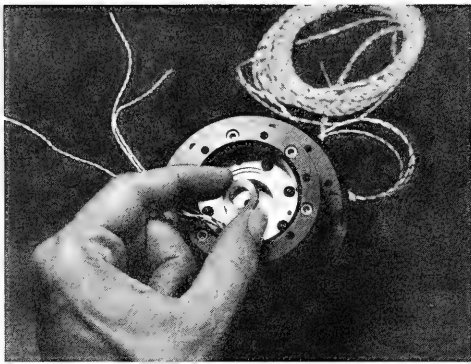

44. Turn the motor unit in its middle position (from the middle position, the motor unit can turn at least  $120^{\circ}$  in either direction without overstressing or overcompressing the coil on the inner housing). Then turn the shaft with a sharpened wooden pencil until you can position the six socket-head screws to fasten the circular spline to the outer housing. Make sure that the motor unit stays in its middle position while you are turning the shaft. If the shaft does not turn freely, or you hear a rabbling noise while turning the shaft, a problem exists. The brush springs are probably destroyed as a result of moving the motor armature out of the motor field during assembly steps 2 to 41.
45. Slip the spacer over the shaft.
46. Press the angular contact ball bearing (FAG no B.7000.E) into the housing so that it can take a thrust load sufficient to push the bearing out. Make sure not to transmit pressure or impact through the rolling elements of the bearing while pressing it in.
47. Put a few drops of high-quality approved oil (see step 7) into the FAG ball bearing.
48. Place one finger spring washer (F1004-007, OD 26.0 mm) on the ball bearing (see section 48 of assembly procedure for motor unit I).
49. Solder the wires onto the solder points of the potentiometer (see section 49 of assembly procedure for motor unit I).
50. Bring the potentiometer to its middle position. That means turning the shaft until you measure 5-k $\Omega$  resistance between 1 and 2 or 2 and 3 on the potentiometer.
51. Assemble the potentiometer without turning the shaft. (Be sure it is seated correctly.)
52. Place finger spring washer (F1830-016, OD 47 mm) on the potentiometer (see section 52 of assembly procedure for motor unit I).

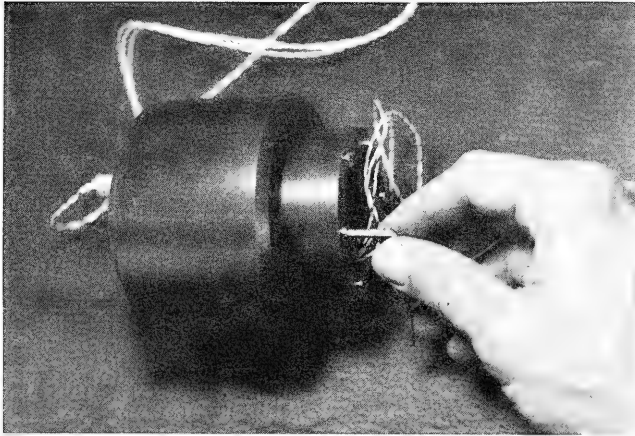

53. Put the O-ring (Parker no 2-032 V747-75) on the cover. Put some high-quality oil on the O-ring surface.
54. Bring the cover into position and screw down by alternate opposite screws.
55. The motor unit is now assembled. Before you proceed in making it watertight, it has to be tested.

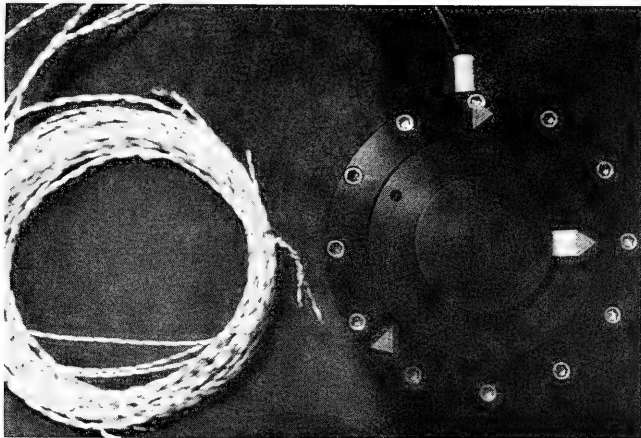



#### SEALING PROCEDURE

- A. Take the retaining ring off; degrease the seat surfaces on the retaining ring and the outer housing; and degrease the socket screws.
- B. Put a thin layer of Loctite 504 gasket eliminator on the seat surface of the outer housing and gently bring the retaining ring into its position.
- C. Put Loctite 290 adhesive/sealant on the threads of the socket-head screws and torque down the screws on alternate opposite sides.
- D. Take one socket-head screw, which fastens the circular spline to the outer housing, and degrease it.
- E. Put Loctite 290 adhesive/sealant on the threads of the socket-head screw and insert the screw.
- F. Let a few drops of Loctite 504 gasket eliminator run into the counterbore so that the screw is surrounded by the gasket eliminator.
- G. Torque the screw down and proceed step-by-step until all six screws are secured and sealed.

APPENDIX B

ASSEMBLY PROCEDURE FOR  
SMALL MOTOR ASSEMBLY

CROSS SECTION OF MOTOR UNIT I

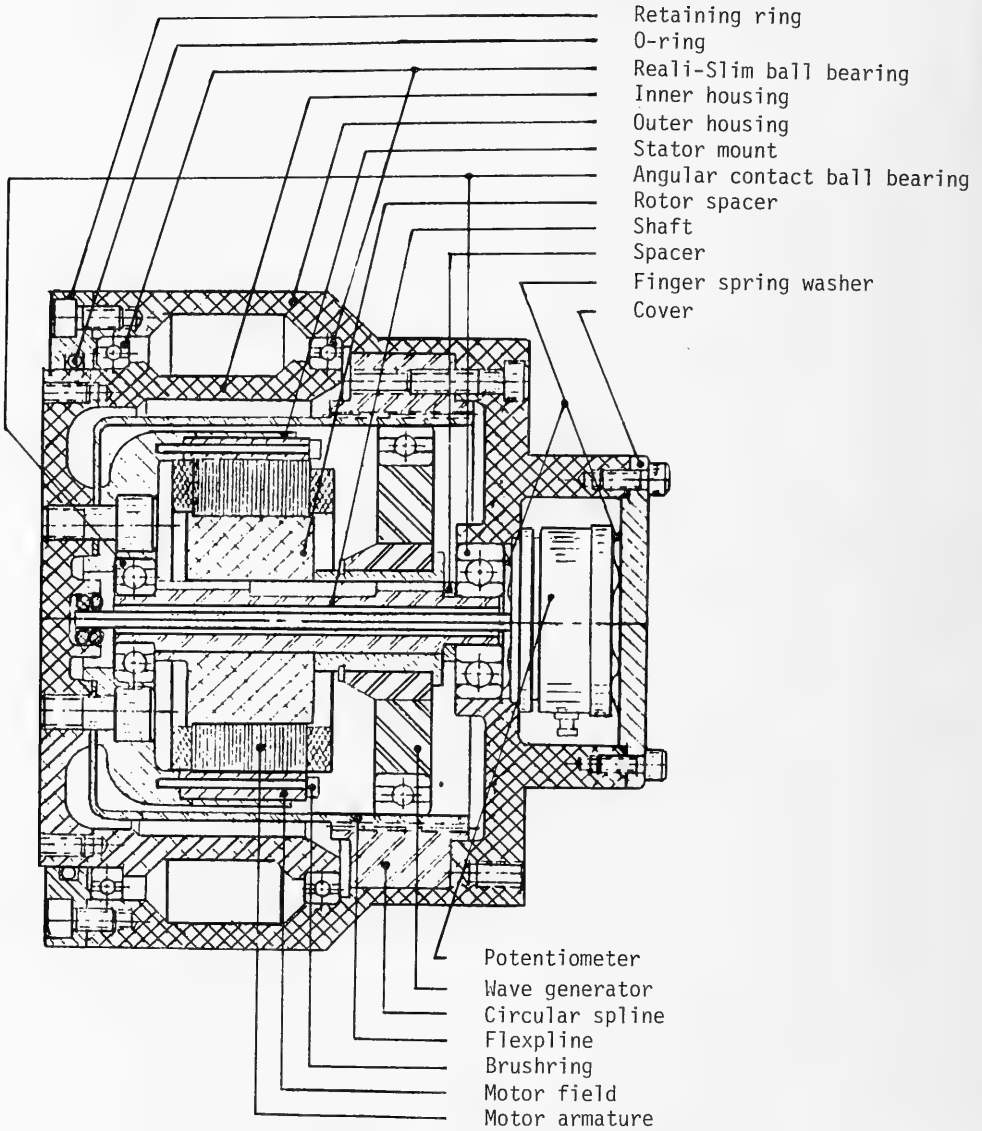

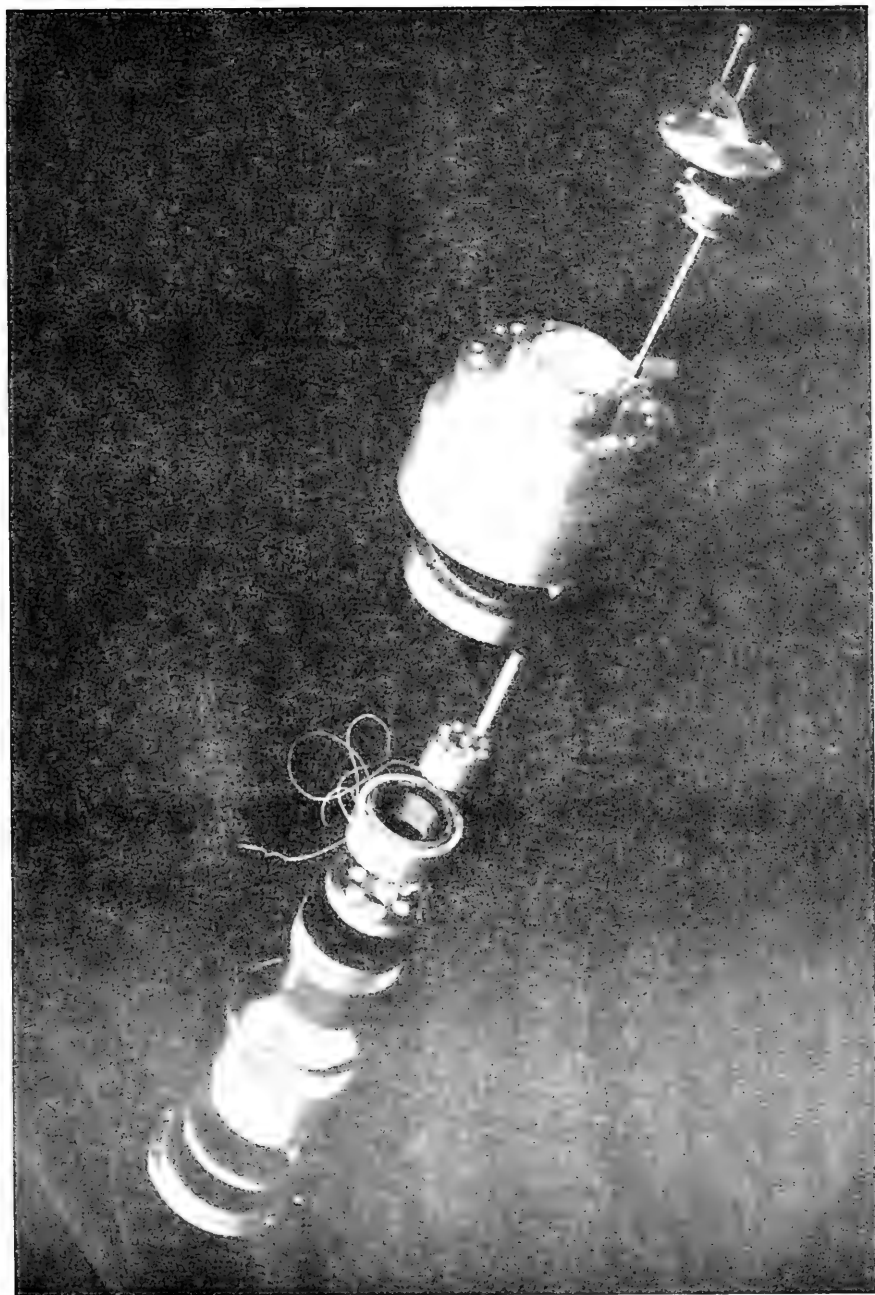

EXPLODED VIEW PHOTO OF MOTOR UNIT I  
(Aluminum parts shown prior to hard anodizing)

## ASSEMBLY PROCEDURE

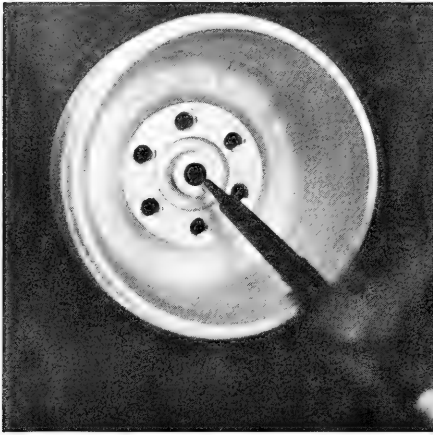

1. Clean all metal surfaces very thoroughly. Make sure that all deposits from previously used liquids such as cutting oils, masking paints, galvanic solutions, etc, are removed.
2. Put Loctite Quick Set 404 Adhesive on the outside diameter of two O-rings (Parker no 2-104 V747-75). Push the O-rings into the bore so that they just fit inside. Cover the adhesive bond with Loctite waterproofing solution.

- 3a. Shoulder rotate – twist two Teflon-insulated 22-gauge wires together and build a coil with about 25 turns.
- 3b. Shoulder pivot – twist three Teflon-insulated 22-gauge wires together and build a coil with about 20 turns.

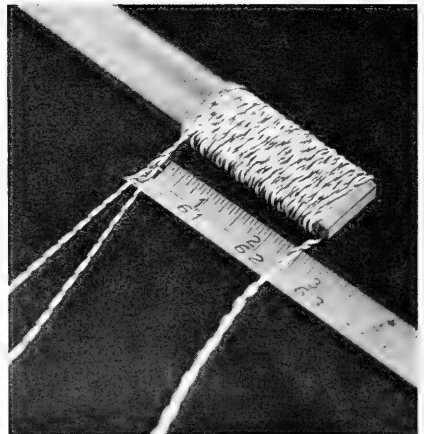



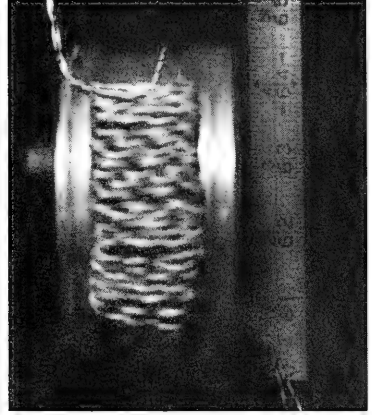

4. Secure the coil temporarily on the inner housing, as shown.

5. Strengthen and protect the part of the wire which goes into the inner part of the housing with pieces of heat-shrinkable tubing.

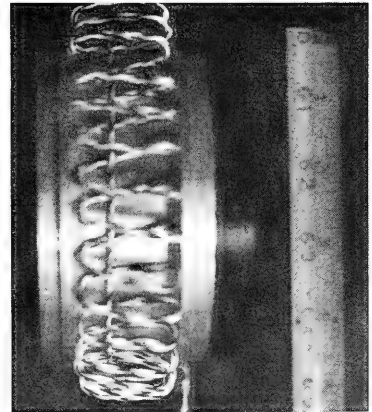
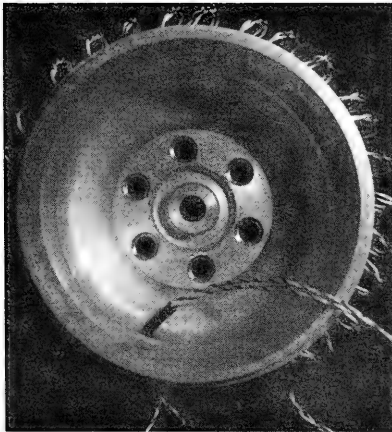

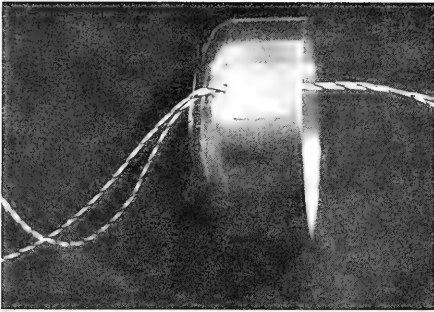

6. Bond a piece of thick aluminum foil over the groove of the stator mount. Use an appropriate bond.
7. Press the angular contact ball bearing (FAG no B.7000.E) into the inner housing so that it can take a thrust load in the direction of the flexpline. Make sure not to transmit pressure or impact through the rolling elements of the bearing while pressing it in.

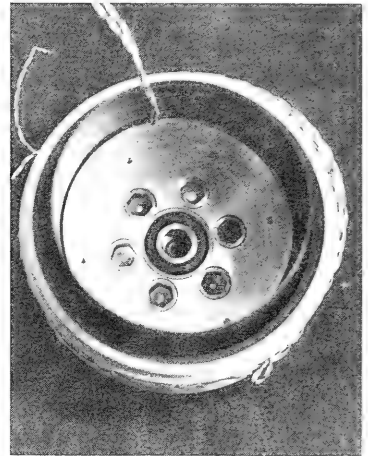

8. Put the flexpline into the inner housing and thread the wires through the fitting hole.
9. Thread the wires through the covered groove of the stator mount and put the stator mount into the flexpline.
10. Screw all three parts together. Pay attention to the fit.
11. When all six bolts are tightened down, take one bolt out. Put Loctite 290 adhesive/sealant on the thread and torque the bolt down. Proceed until all bolts are locked and sealed.



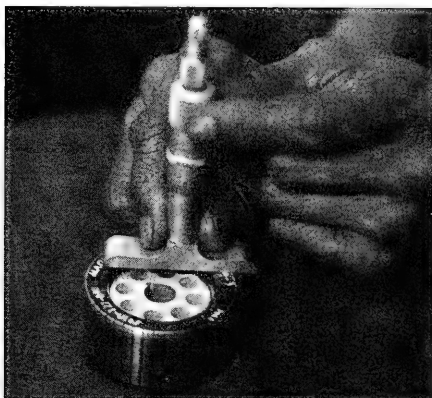
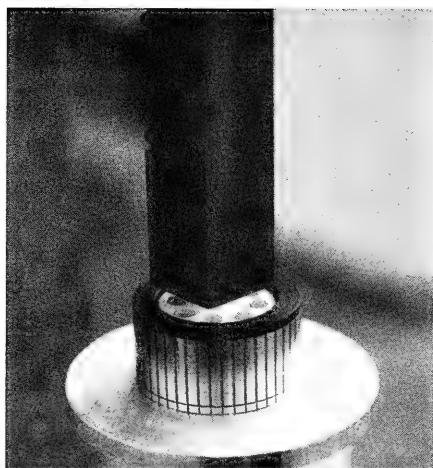
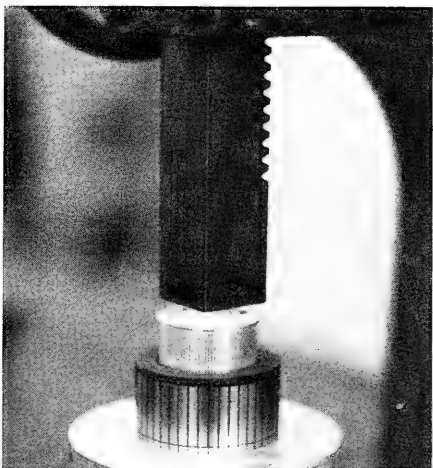

12. Press the rotor spacer into the motor armature. The rotor spacer is in place when the distance from the surface of the rotor spacer to the bottom of the recess in the armature is  $+ 0.035 \pm 0.001$  inch.



13. Lock the two parts together by letting Loctite 290 adhesive/sealant flow into the gap. Wipe off the remaining adhesive.

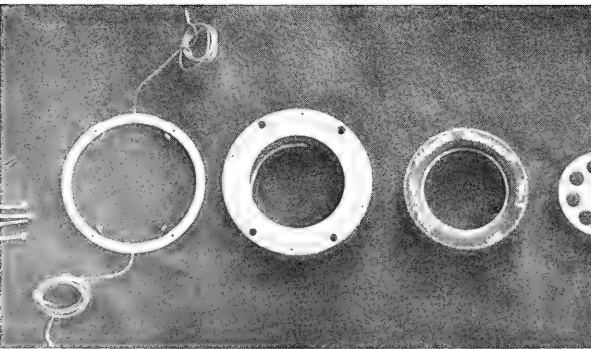
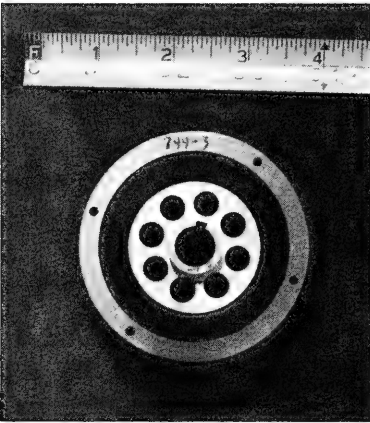
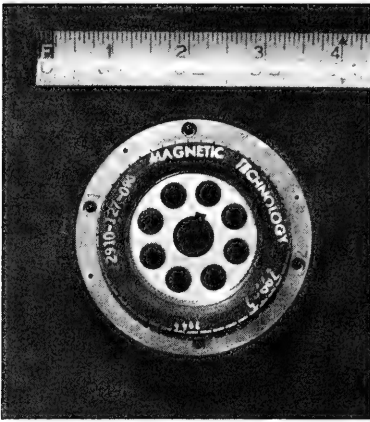

## HANDLING, STORAGE, INSTALLATION

Greater care is required for handling frameless dc torque motors than for housed units or conventional ac motors. The armature, field, and brush assembly are supplied as a matched set identified serially and should not be interchanged with other components. They are packaged separately in the shipping container. During unpacking and handling, and throughout installation, care must be taken to avoid bending or distorting the brush assembly springs, and to protect the commutator surfaces from scratching or contamination by oil or fingerprints. The field is supplied with a "keeper" ring, attached by magnetic force, which must not be removed until the field is installed and the armature is in place. To do so will result in approximately 1/3 reduction in torque sensitivity.

Frameless units should be stored in nonmagnetic racks or containers — the shipping container is suitable — to prevent interaction of magnetic fields. Attraction of magnetic particles also should be avoided. Protect the armature core from moisture with desiccant.

14. Using the motor armature (with the rotor spacer in place), push the keeper out of the motor field.

**ATTENTION:** Removing the keeper without substituting it with the field;

- or placing the field on steel shelves or benches, unless separated from the steel by at least one-half inch of non-magnetic material;
- or letting the field come in contact with the ferrous tools or measuring instruments

will demagnetize the field up to 50%.

## COMPONENT PARTS — DEFINITIONS

**Armature.** The rotating element. The windings are in this part.

**Commutator.** A conductive segmented ring on the armature, which allows electrical power to be transferred to the winding from the stationary element.

**Field.** The stationary permanent magnet assembly that produces the magnetic flux field in the motor air gap.

**Brush Assembly.** The stationary insulating ring, or segment supporting spring-loaded electrical contacts (brushes), which slide on the commutator to transfer the dc power.

**Keeper.** A magnetic steel ring installed on the field to keep the magnets at full strength until the armature is fully in place. The normal keeper type is shown in the above installation instructions. Other types sometimes are used for magnetic or assembly reasons.



15. To protect the armature finish and commutator surface, place some 0.005-inch-thick plastic strips (Mylar) inside the field. They should extend above the armature for grasping and removal after motor installation.

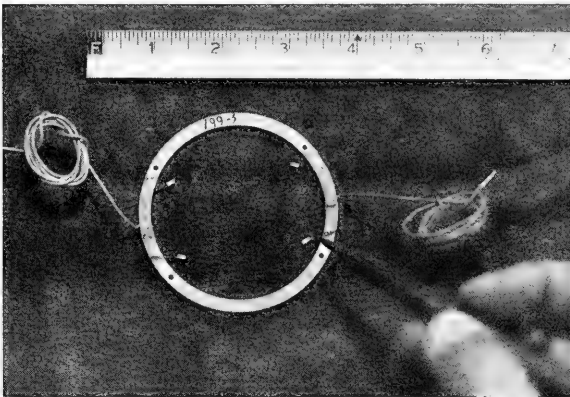

16. Bend the brush springs very carefully so that they remain as shown. Avoid distorting. The original spring position is shown on the opposite page. Position one set of brushes on the commutator, then gently compress the remaining brush springs and slide them onto the commutator. The brushes have to contact the commutator along the entire length of the brush. If the brushes are canted, distorted, or shifted, remove the brushring gently and bend the brush springs as necessary. Proceed until they fit correctly and then remove the brushring before proceeding in the assembly.



17. Put some drops of high-quality approved oil (MIL-L-6085A, MIL-L-8704A, MIL-L-644A) with a viscosity index of 70 into the bearing in the stator mount.
18. Insert armature with field in place into the stator mount. Avoid pushing the armature out of the field (see 14).
19. Secure the field with the four socket-head screws.
20. The armature is in place when the distance from the field surface to the bottom of the recess in the armature is  $0.040 \pm 0.005$  inch. NOTE: Take measured values from opposite places and use mean value, because the armature is normally canted in relation to the field by magnetic forces.

21. Get one socket-head screw out. Put Loctite 290 adhesive/sealant on the thread and torque the screw down. Then proceed until all four screws are locked.

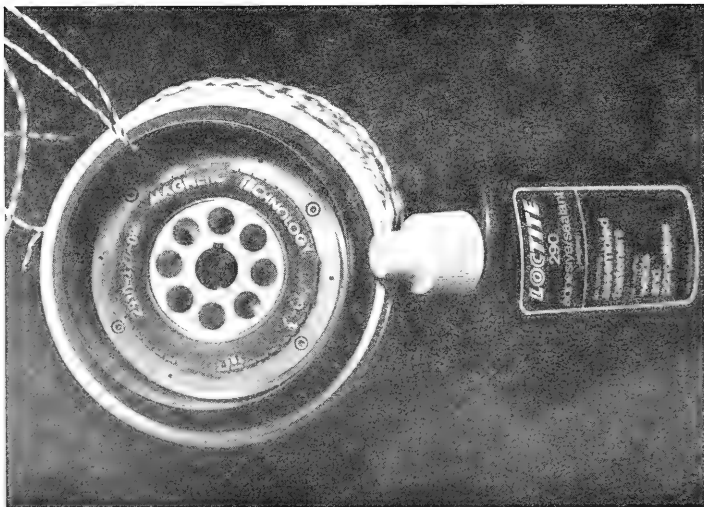

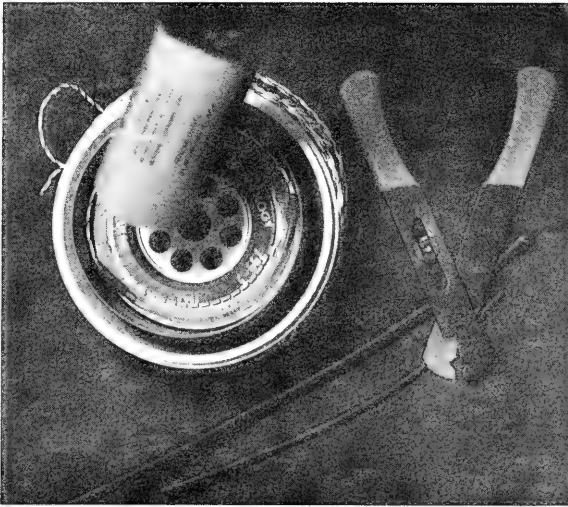

22. Remove the plastic strips and put the brushring on the armature by setting one set of brushes on the commutator and gently compressing the remaining brush springs and sliding them onto the commutator.

NOTE: The commutator should remain clean of fingerprints and scratches. All possible precautions should be taken to prevent silicone contamination of the commutator or the brushes.

23. Put Loctite 290 adhesive/sealant on the thread of the two countersunk screws and secure the brushring.
24. Solder the wires together and secure and insulate the soldered joints with heat-shrinkable tubing. Make sure that the wires are long enough to make it possible to repeat this procedure in case it is necessary to replace motor parts. Make sure also that the wires do not touch the brush springs, the armature, or the wave generator (which is not in place now). Make sure the wires do not get into the gap between the flexpline and the stator mount.

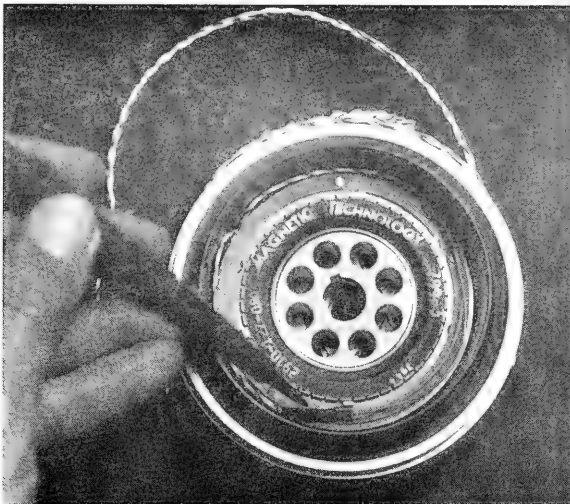

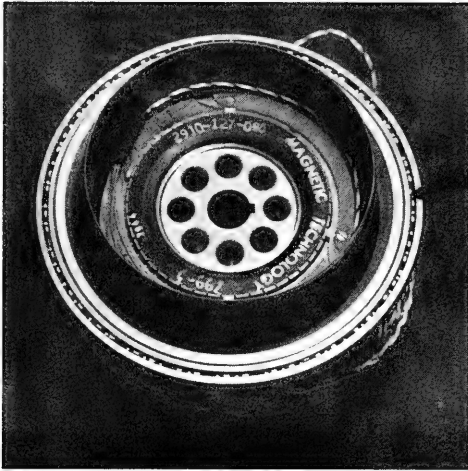

25. Press the Reali-Slim ball bearing (Kaydon bearing no KA 040 XPO) on the inner housing so that the noninterrupted part of the bearing separator faces to the coil on the inner housing. Make sure not to transmit pressure or impact through the rolling elements of the bearing while pressing it onto the inner housing.

26. Install the wave generator into the flexpline, as shown.

27. Put a few drops of high-quality approved oil (MIL-L-6085A, MIL-L-870A, MIL-L-644A) with a viscosity index of 70 into the Kaydon bearing and into the wave generator.

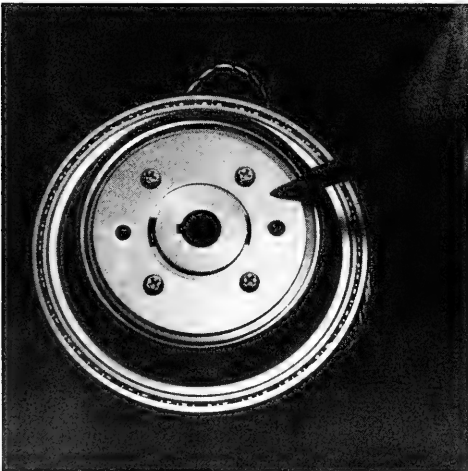

#### WAVE GENERATOR ASSEMBLY (W/G)

The W/G is provisioned with an Oldham-type flexible coupling and consists of parts shown in the exploded view. Disassembly as required for hub mounting is permissible, together with reverse mounting if desired.

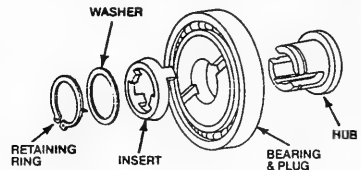

The hub portion of the W/G must be torsionally and axially affixed to an input shaft. Overhung input shaft loads caused by gears, sprockets, etc. require a suitable two-bearing shaft support, as noted below; otherwise, one bearing to axial-contains the W/G assembly is permissible.



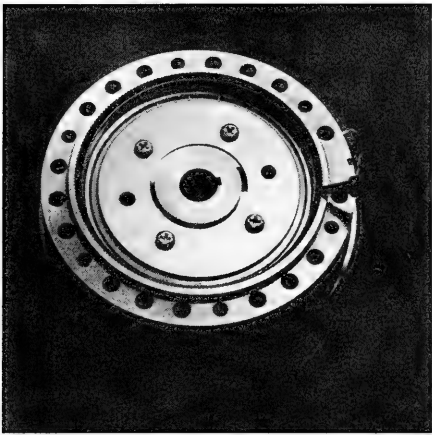

28. Install the circular spline so that the teeth mesh concentrically (see "ASSEMBLY" below) Check this visually or with a feeler gauge.
29. Put a few drops of oil (see 27) on the teeth of the circular spline and the flexpline.

### ASSEMBLY

It is essential that the C/S and F/S toothmesh concentrically engage for proper function as noted below. The unit will function in what is defined as the "dedoidal" state, but will be subject to reduced life.

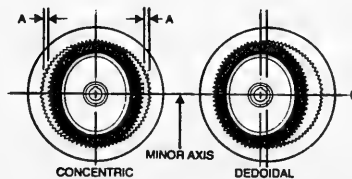

A correct assembly is checked in one of two ways.

1. When the toothmesh is exposed, a visual or feeler gage check for equal tooth clearance (A) is made as noted above.
2. In a blind assembly, an access hole adjacent to the C/S provides the means for indicating the motion of a correctly assembled F/S as noted below for one revolution of the W/G.

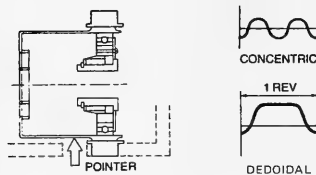



30. Put the key into the keyway of the shaft.

31. Put some oil (see 27) on the surface of the shaft.

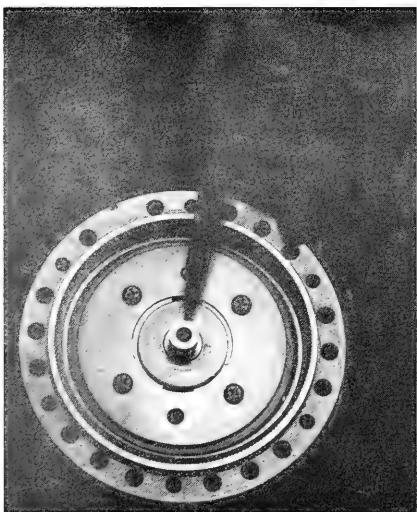

32. Put the short end of the shaft into the assembly. Make sure that now (and later) the motor armature does not move out of the motor field. This would destroy the brush springs of the brushring!

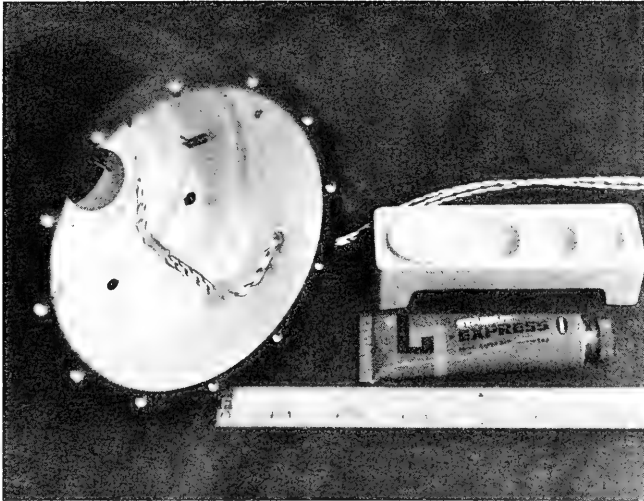

- 33a. Shoulder rotate--run three Teflon-insulated, 22-gauge wires through the outer housing and keep them in position, as shown, with an appropriate bond. Run two twisted Teflon-insulated, 22-gauge wires through the fitting and let them stick out of the housing.
- 33b. Shoulder pivot--proceed with three wires as described in 33a, but instead of running the wires through the fitting, let them stick out of the outer housing.
34. Strengthen and protect the parts of the wires which run through the bore with pieces of heat-shrinkable tubing (not shown in the photographs).

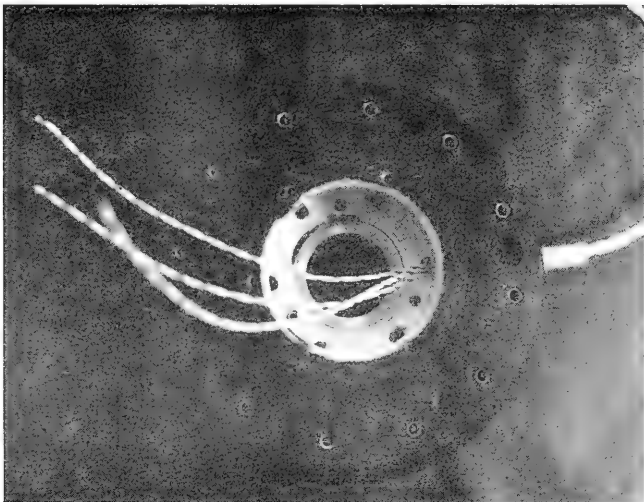

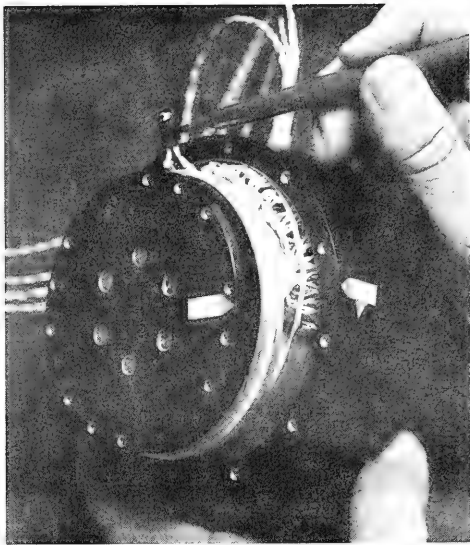

35. Put outer and inner housings together as shown, and solder the wires from the coil on the inner housing to the wires running to the fitting (shoulder rotate) or the wires sticking out of the outer housing (shoulder pivot). Secure and insulate the soldered joints with heat-shrinkable tubing. Make sure that the wires are long enough to repeat this procedure in case of necessary replacement of motor parts. Make sure that during the assembly process the motor armature cannot come out of the motor field (see 32).

36. Bend the soldered joints back into the outer housing. Take out what was used to secure the coil on the inner housing and press both housing parts together until the Kaydon ball bearing fits into its seat in the outer housing (see the assembly drawing from page B-1). Make sure that during the assembly the motor armature cannot come out of the motor field.

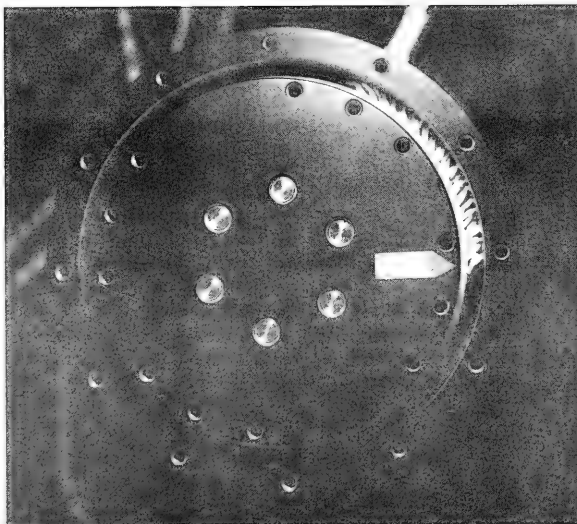

37. Mark the possible movement from the compressed coil to the stretched coil on inner and outer housings.

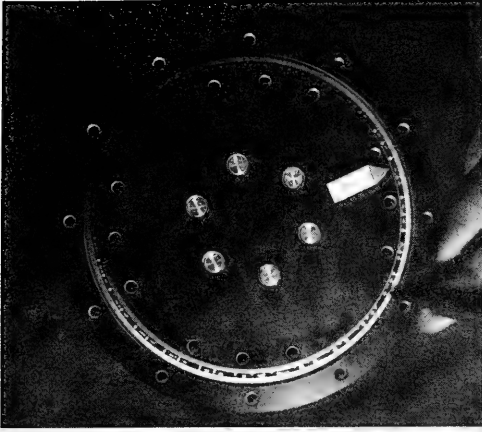

38. Press the Reali-Slim ball bearing (Kaydon bearing no KA040 XPO) into the housings so that the noninterrupted part of the bearing separator faces to the coil on the inner housing. Make sure not to transmit pressure or impact through the rolling elements of the bearing while pressing it into the housing.

39. Put a few drops of high-quality approved oil (see 27) with a viscosity index of 70 into the Kaydon bearing.

40. Put the O-ring (Parker no 2-155-V747-75) into the groove of the retaining ring.

41. Put a few drops of high-quality oil on the O-ring surface.

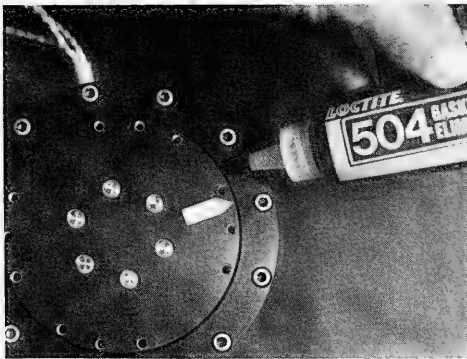

42. Gently press the retaining ring in position and screw the parts together.

43. If the two housing parts are too loose, place an aluminum foil washer between the Kaydon bearing and the retaining ring (not shown).

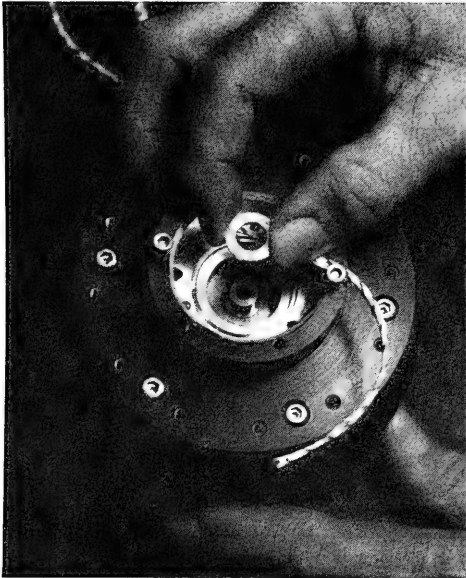

44. Turn the motor unit in its middle position (from the middle position, the motor unit can turn at least  $120^{\circ}$  in either direction without overstretching or over-compressing the coil on the inner housing). Then turn the shaft with a sharpened wooden pencil until you can position the six socket-head screws to fasten the circular spline with the outer housing. Make sure that the motor unit stays in its middle position while you are turning the shaft. If the shaft does not turn freely, or you hear a rabbling noise while turning the shaft, a problem exists. The brush springs are probably destroyed because of moving the motor armature out of the motor field during assembly steps 25 to 44.

45. Slip the spacer over the shaft.

46. Press the angular contact ball bearing (FAG no B.7000.E) into the housing so that it can take a thrust load sufficient to push the bearing out. Make sure not to transmit pressure or impact through the rolling elements of the bearing while pressing it in.

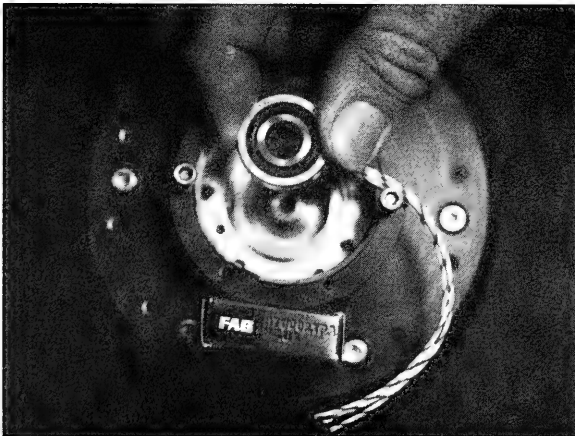

47. Put a few drops of high-quality approved oil (see 17) with a viscosity index of 70 into the ball bearing.

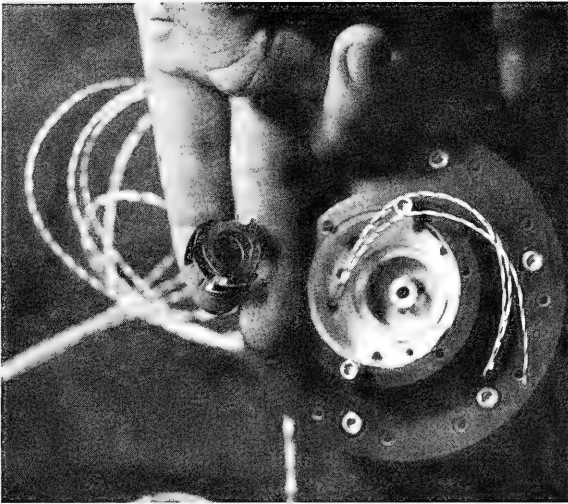

48. Place one finger spring washer (F1004-007 OD, 26.0 mm) on the ball bearing. (NOTE: The upper picture does not show the bearing in place and it shows two washers, one upon the other, instead of one.)

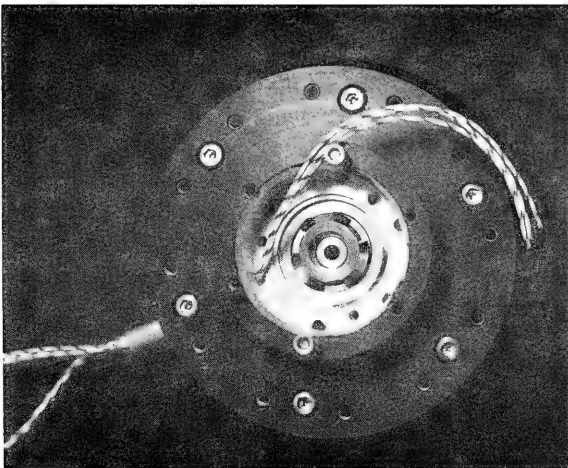

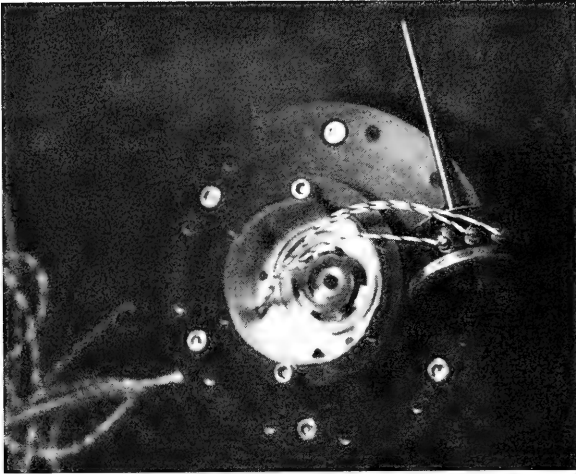

49. Solder the wires onto the solder points of the potentiometer (model SF40). Make sure the wires are long enough to get the potentiometer in and out without desoldering.

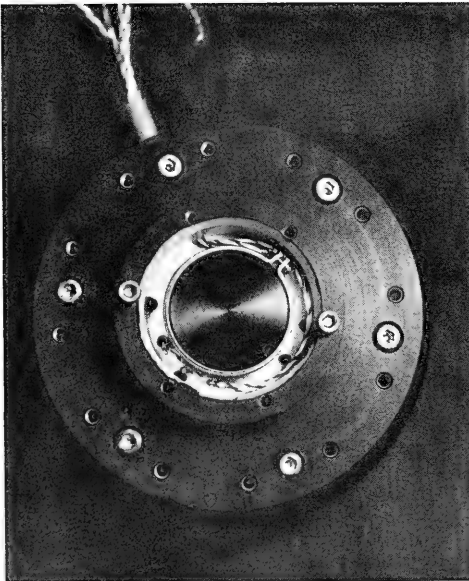

50. Bring the potentiometer into middle position; that means turning the shaft until you measure 5-k $\Omega$  resistance between 1 and 2 or 2 and 3 on the potentiometer.
51. Assemble the potentiometer without turning the shaft. Be sure it is seated correctly.



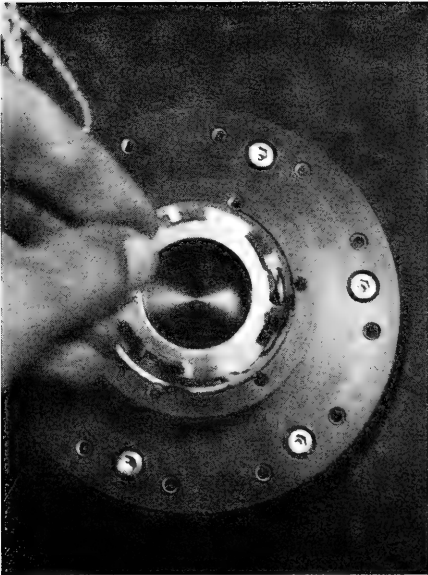

52. Place, as shown, one finger spring washer (F 1830-016, OD 47 mm) on the potentiometer.

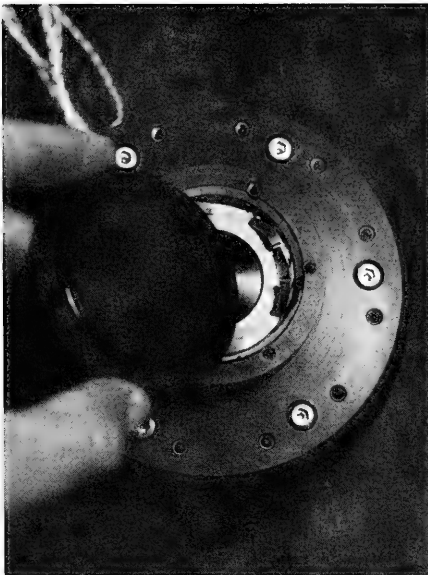

53. Put the O-ring (Parker no 2-032 V747-75) on the cover.
54. Put some high-quality oil on the O-ring surface.
55. Bring the cover into position and screw it down by means of alternate, opposite screws.
56. The motor unit is now assembled. Before you proceed in making it watertight, it has to be tested.

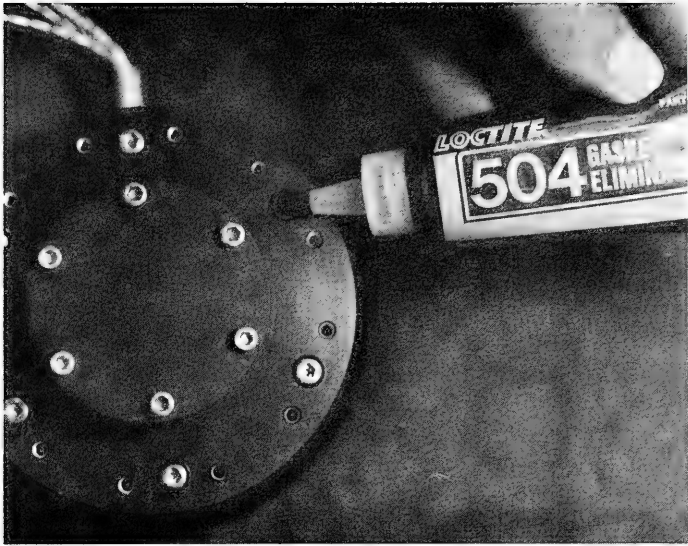

#### SEALING PROCEDURE

- A. Take the retaining ring off; degrease the seat surfaces on the retaining ring and the outer housing; degrease the socket screws.
- B. Put a thin layer of Loctite 504 gasket eliminator on the seat surface of the outer housing and gently bring the retaining ring into position.
- C. Put Loctite 290 adhesive/sealant on the threads of the socket-head screws and torque the screws down by means of alternate, opposite screws.
- D. Take one socket-head screw, which fastens the circular spline to the outer housing, and degrease it.
- E. Put Loctite 290 adhesive/sealant on the threads of the socket-head screw and insert the screw.
- F. Let a few drops of Loctite 504 gasket eliminator run into the counter-bore so that the screw is surrounded by the gasket eliminator.
- G. Torque the screw down and proceed step-by-step until all six screws are secured and sealed.

## REFERENCES

1. R. Frank Busby Associates, Underwater Inspection/Testing/Monitoring of Offshore Structures, (US Department of Commerce contract 7-35336).
2. NOSC TR 622, Free-Swimming Submersible Testbed (EAVE WEST), P.J. Heckman, 15 September 1980.
3. NUC TP 278, Ocean Engineering (Revision 1), H.R. Talkington, January 1975.
4. Ferrell, W.R., and T.B. Sheridan, Supervisory Control of Remote Manipulator, IEEE Spectrum, v 4, no 10, p 81--88, October 1967.
5. Brooks, T.L., and T.B. Sheridan, Experimental Evaluation of the Concept of Supervisory Manipulation, 16th Annual Conference of Manual Control, MIT, Cambridge, MA, 5--7 May 1980.
6. Brooks, T., SUPERMAN: A System for Supervisory Manipulation and the Study of Man/Computer Interactions, MIT MS thesis, 1979.
7. NOSC TR in preparation, Fiber Optics Communication Links for Unmanned Inspection Submersibles, S.J. Cowen, M. Kono, and P.J. Heckman,
8. Cowen, S.J., Fiber-Optic Transmission System Pulse Frequency Modulation, Proceedings, Ocean 79, p 253--259, September 1979.
9. NOSC TR 217, FY-77 Subsea Slow Scan Acoustic Television (SUBSAT) Tests, A. Gordon, March 1978.
10. NOSC TD 299, Independent Research and Independent Exploratory Development Annual Report FY 79, v 1, 1 October 1979.
11. Gordon, A., BUMP, Information Display, April 1980.
12. Heckman, P., D. Yoerger, and T.B. Sheridan, The NOSC/MIT Submersible Manipulator: an Experiment in Remote Supervisory Control of a Microprocessor Based Robot, paper for Session F10P on Robotics, International Conference on Cybernetics and Society, Cambridge, MA, 10 October 1980.



WHOI  
DOCUMENT  
COLLECTION

DEMO

1980 10 20

