

M. B. / 0



7:00 37 - c

Handwritten text, possibly a title or description, which is mostly illegible due to fading. Some words like "i. k. e. c. t. i. o. n." are faintly visible.

**THE DOG.**







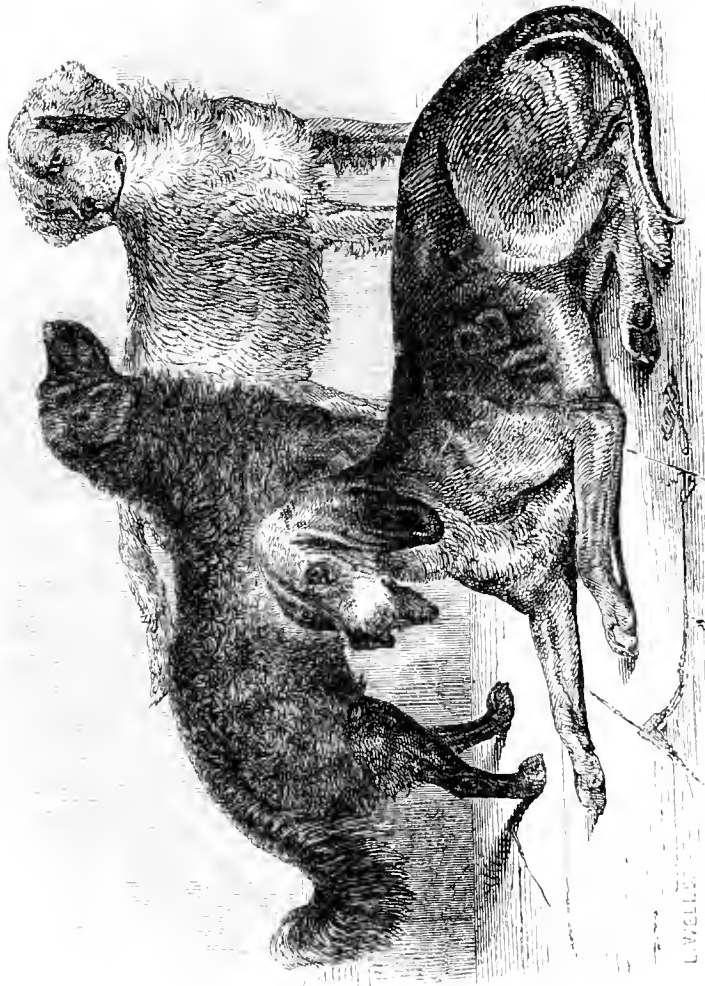

RETRIEVER, BLOODHOUND, AND SETTER.

(The property of The Hon. GRANBY BERKELEY.)

L. WELLS.

# THE DOG

IN HEALTH AND DISEASE.

COMPRISING THE VARIOUS MODES OF BREAKING AND USING HIM FOR  
HUNTING, COURSING, SHOOTING, ETC., AND INCLUDING THE  
POINTS OR CHARACTERISTICS OF TOY DOGS.

BY STONEHENGE,

AUTHOR OF "THE GREYHOUND," ETC.

*Second Edition.*

LONDON:  
LONGMANS, GREEN, READER, & DYER.

1872.

---

JOHN CHILDS AND SON, PRINTERS..

## PREFACE.

---

AMONG the various scientific and anecdotal writings in the English language on *The Dog*, it might be thought that the subject was exhausted, and that nothing remained to be done by the most careful observer of the habits and external forms of the varieties of this animal. But let any one seek for specific information upon several points connected with even well-marked and generally-recognised kinds, and he will soon be brought to confess that he is lost in doubt and uncertainty. For instance, where shall we find a sufficient description of the spaniels and terriers, or of the various retrievers for which such large sums are often given? Who will be able to discover, from any written account, the difference between the springer and the cocker, or between the Clumber and Sussex spaniels? Who, again, will tell us the colours and forms of the Skye and Dandie Dinmont terriers, or the characteristics of the English toy terriers, pugs, and Maltese dogs? Yet there are thousands and tens of thousands who take a great

interest in these animals, and who would spare neither money nor trouble to ascertain the exact properties of the variety to which each individual of their acquaintance belongs. Daniel, Youatt, and Richardson have all laboured hard to enlighten their readers upon the varieties of the canine species, and have no doubt done much towards the attainment of this end; but, as I before remarked, the deficiencies in their descriptions are patent to all. It is true that the hound and the greyhound, the pointer and the setter, as well as many of the foreign varieties of the dog, have been favoured with special treatises; but beyond them the ground is almost untrodden, or else it is choked with weeds and rubbish which render it difficult to ascertain what is beneath them.

In the following pages I have been compelled to have recourse to the work of Mr. Youatt in the instances of some of the foreign dogs, both for the descriptions and also for the engravings which are contained in it. At the time when he wrote, the Zoological Society of London possessed an extensive collection of dogs, which was made use of by him to great advantage; and I can speak to the correctness of most of his illustrations, from having compared them with the originals soon after he first gave them to the public; but unfortunately there is now no such collection in England. As far as possible, however, throughout the first Book the descriptions and illustrations are drawn from the life, the specimens selected being of the most perfect symmetry and of the purest breed within my reach. For many of them I am indebted to

gentlemen who have given up their best energies to improve the peculiar strain which has enlisted their attention, and for the facilities which they have afforded me I here beg to record my most sincere thanks.

BOOK I. contains the Natural History of the Dog, with a minute description of the varieties which are generally recognised. The chief claims of this book rest upon its being a faithful transcript in writing of oral records which have been treasured up by the breeders of the dog in all its varieties, and which being now made public, will render it comparatively easy in future to ascertain the position which any particular dog can claim, and how far it complies with the points which are attributed to it. These records have been carefully collected; and I believe it will be found, that though some individuals may hold different views, yet that in each case that which I have presented is the one which is maintained by a large majority of those who have made the subject their particular study. It is impossible to attain a certainty of this in every instance; but should I be wrong, it can, at all events, be maintained that neither time, trouble, nor expense has been spared in arriving at it.

BOOK II. describes the best methods of breeding, rearing, breaking, and managing the dog, while in health, by means of appropriate food, exercise, and lodging. This division of the subject therefore embraces the entering and running of the grey-



hound; the breaking and working of shooting dogs; the entering and hunting of hounds; and the management of vermin terriers, toy, and house dogs.

Lastly, in the THIRD BOOK the most modern and successful treatment of the diseases to which the dog is subject is given at length, and in terms which will, it is hoped, be intelligible to all. My readers will therefore perceive that I have omitted no information at all likely to be interesting to the lover of *the dog*, which a long experience and most extensive opportunities have enabled me to obtain.

STONEHENGE.

# CONTENTS.



## BOOK I.

### THE NATURAL HISTORY, ZOOLOGICAL CLASSIFICATION, AND VARIETIES OF THE DOG.

#### INTRODUCTORY CHAPTER.

|   | PAGE |
|---|------|
| Origin. — General Characteristics. — Habitats. — Varieties. — F. Cuvier's Divisional Arrangement.—Arrangement adopted by the Author . . . . . | 3    |

#### CHAPTER I.

|   |    |
|---|----|
| Wild and half-reclaimed Dogs, hunting in Packs.—The Dingo.—The Dhole.—The Pariah.—The Wild Dog of Africa.—The South-American Dog.—The North-American Dog.—Other Wild Dogs . . . . . | 14 |
|---|----|

#### CHAPTER II.

##### DOMESTICATED DOGS HUNTING CHIEFLY BY THE EYE, AND KILLING THEIR GAME FOR MAN'S USE.

|  |    |
|--|----|
| The Rough Scotch Greyhound and Deerhound.—The Smooth or English Greyhound.—The Gazehound.—The Irish Greyhound, or Wolf-dog.—The French Mâtin.—The Hare-Indian Dog.—The Albanian Dog.—The Grecian Greyhound.—The Turkish Greyhound.—The Persian Greyhound.—The Russian Greyhound.—The Italian Greyhound . . . . . | 29 |
|--|----|

## CHAPTER III.

DOMESTICATED DOGS, HUNTING CHIEFLY BY THE NOSE, AND BOTH FINDING AND KILLING THEIR GAME; COMMONLY KNOWN AS HOUNDS.

|  | PAGE |
|--|------|
| The Southern Hound.—The Bloodhound.—The Staghound.—The Foxhound.—The Harrier.—The Beagle.—The Otterhound.—The Terrier.—The Dachshund . . . . . | 47   |

## CHAPTER IV.

DOMESTICATED DOGS, FINDING GAME BY SCENT, BUT NOT KILLING IT, BEING CHIEFLY USED IN AID OF THE GUN.

|   |    |
|---|----|
| The Spanish Pointer.—The Modern English Pointer.—The Portuguese Pointer.—The French Pointer.—The Dalmatian and Danish Dogs.—The English and Irish Setters.—The Russian Setter.—The Ordinary Field Spaniel, including the Springer (Clumber, Sussex, and Norfolk breeds), and the Cocker (Welsh and Devonshire).—The Water Spaniel (English and Irish) . . . . . | 88 |
|---|----|

## CHAPTER V.

PASTORAL DOGS, AND THOSE USED FOR THE PURPOSES OF DRAUGHT.

|  |     |
|--|-----|
| The English Sheep-Dog.—The Colley.—The Drover's Dog.—The German Sheep-Dog.—Pomeranian Wolf-Dog.—The Newfoundland and Labrador Dogs.—The Esquimaux Dog.—The Greenland Dog.—The Iceland and Lapland Dogs . . . . . | 120 |
|--|-----|

## CHAPTER VI.

WATCH DOGS, HOUSE DOGS AND TOY DOGS.

|  |     |
|--|-----|
| Bulldog.—Mastiff, Cuban and English—Mount St. Bernard.—Thibet Dog.—Poodle.—Maltese Dog.—Pomeranian or Spitz.—Lion Dog.—Shock Dog.—Toy Spaniels.—Toy Terriers.—The Pug Dog.—Italian Greyhound . . . . . | 132 |
|--|-----|

# CONTENTS.

XI

## CHAPTER VII.

### CROSSED BREEDS.

|   | PAGE |
|---|------|
| Retriever.—Bull-Terrier.—Lureher.—Dog and Fox Cross . . . . . | 160  |

---

## BOOK II.

### THE BREEDING, REARING, BREAKING, AND MANAGEMENT OF THE DOG, IN-DOORS AND OUT.

#### CHAPTER I.

##### BREEDING.

Principles of Breeding.—Axioms for the Breeder's Use.—Crossing and crossed Breeds.—Importance of Health in both Sire and Dam.—Best Ages to breed from.—In-and-in Breeding.—Best Time of Year.—Duration of Heat.—Management of the Bitch in Season.—The Bitch in Whelp.—Preparations for Whelping.—Healthy Parturition.—Destruction or Choice of Whelps at Birth . . . . . 171

#### CHAPTER II.

##### REARING.

Management in the Nest.—Choosing.—The Foster-Nurse.—Feeding before Weaning.—Choice of Place for Whelping.—Removal of Dew-Claws, &c.—Weaning.—Lodging.—Feeding.—Exercise.—Home Rearing *v.* Walking.—Food.—General Management.—Cropping, Branding, and Rounding . . . . . 199

## CHAPTER III.

## KENNELS AND KENNEL MANAGEMENT.

|   | PAGE |
|---|------|
| Greyhound Kennels.—Foxhound Kennels.—Pointer Kennels.—Kennels for single Dogs.—House Dogs . . . . . | 225  |

## CHAPTER IV.

## BREAKING AND ENTERING.

|  |     |
|--|-----|
| The Entering of the Greyhound and Deerhound.—Of Foxhounds and Harriers.—Breaking the Pointer and Setter.—The Retriever (Land and Water).—The Spaniel.—The Vermin Dog . . . . . | 241 |
|--|-----|

## CHAPTER V.

## THE EMPLOYMENT OF THE DOG IN COURSING, HUNTING, SHOOTING, ETC.

|   |     |
|---|-----|
| Coursing.—Deerstalking.—Hunting.—Partridge- and Grouse-Shooting.—Snipe-Shooting.—Covert Shooting.—Wildfowl-Shooting.—Ferretting . . . . . | 280 |
|---|-----|

## BOOK III.

## THE DISEASES OF THE DOG AND THEIR TREATMENT.

## CHAPTER I.

## PECULIARITIES IN THE ANATOMY AND PHYSIOLOGY OF THE DOG.

|   |     |
|---|-----|
| The Skeleton, including the Teeth.—The Muscular System.—The Brain and Nervous System.—The Digestive System.—The Heart and Lungs.—The Skin . . . . . | 333 |
|---|-----|

## CHAPTER II.

THE REMEDIES SUITED TO THE DOG, AND THE BEST MEANS OF ADMINISTERING THEM.

|   | PAGE |
|---|------|
| Alteratives.—Anodynes.—Antispasmodics.—Aperients.—Astringents.—Blisters.—<br>Caustics.—Charges.—Cordials.—Diuretics.—Embrocations.—Emetics.—Expect-<br>orants.—Fever Medicines.—Clysters.—Lotions.—Ointments.—Stomachics.—Styp-<br>tics.—Tonics.—Worm Medicines.—Administration of Remedies . . . . . | 342  |

## CHAPTER III.

FEVERS, AND THEIR TREATMENT.

|   |     |
|---|-----|
| Simple Ephemeral Fever, or Cold.—Epidemic Fever, or Influenza.—Typhus Fever,<br>or Distemper.—Rheumatic Fever.—Small-Pox.—Sympathetic Fever . . . . . | 366 |
|---|-----|

## CHAPTER IV.

INFLAMMATIONS.

|   |     |
|---|-----|
| Definition of Inflammation.—Symptoms and Treatment of Rabies, Tetanus, and<br>Turnside.—Of Inflammation of the Eye, Ear (canker), Mouth, and Nose.—Of<br>the Lungs.—Of the Stomach.—Of the Bowels.—Of the Liver.—Of the Kidneys<br>and Bladder.—Of the Skin . . . . . | 387 |
|---|-----|

## CHAPTER V.

DISEASES ACCOMPANIED BY WANT OF POWER.

|  |     |
|--|-----|
| Chorea.—Shaking Palsy.—Fits.—Worms.—General Dropsy or Anasarca . . . . . | 425 |
|--|-----|

CONTENTS.

CHAPTER VI.

DISEASES ARISING FROM MISMANAGEMENT OR NEGLECT.

|  |      |
|--|------|
|  | PAGE |
| Anæmia. — Rickets. — Indigestion . . . . . | 445  |

CHAPTER VII.

DISEASES AND ACCIDENTS REQUIRING SURGICAL AID.

|  |     |
|--|-----|
| Tumours. — Cancer. — Encysted Tumours. — Abscesses. — Unmatural Parturition. —<br>Accidents and Operations . . . . . | 450 |
|--|-----|



## LIST OF ENGRAVINGS.

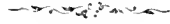

|  | PAGE |   | PAGE |
|--|------|---|------|
| Frontispiece.  |      | "Bellman," an Otterhound . . . . .                                | 70   |
| The Wolf . . . . .   | 3    | "Lady," an English Terrier . . . . .                              | 73   |
| Skull of Dingo . . . . .   | 10   | "Peto," a Scotch Terrier . . . . .                                | 75   |
| ,, Spaniel . . . . .   | 11   | "Rough" and "Puck," Dandies . . . . .                             | 77   |
| ,, Mastiff . . . . .   | 12   | Skye Terrier . . . . .  | 79   |
| The Dingo . . . . .  | 14   | "Quilick," a Skye Terrier . . . . .                               | 80   |
| "Cader," a Deerhound of the pure<br>Glengarry breed . . . . .        | 20   | "Fussy," Fox-Terrier Bitch . . . . .                              | 82   |
| Captain Daintree's "King Cob" . . . . .                              | 25   | "Tyneside," Bedlington Terrier . . . . .                          | 83   |
| The Hare-Indian Dog . . . . .  | 39   | "Dundreary," Blue Tan Terrier . . . . .                           | 84   |
| The Grecian Greyhound . . . . .                                      | 41   | The Boarhound . . . . .   | 86   |
| Italian Greyhounds, "Billy" and "Min-<br>nie" . . . . .              | 44   | The Spanish Pointer . . . . .                                     | 88   |
| The Southern Hound . . . . .   | 47   | "Sancho," a modern English Pointer . . . . .                      | 91   |
| Head of the Bloodhound . . . . .                                     | 51   | The Dalmatian Dog . . . . .                                       | 96   |
| "Hermit," a highbred modern Fox-<br>hound . . . . .                  | 55   | "Sailor," a perfect specimen of the<br>Setter . . . . .           | 97   |
| "Grasper," a Harrier, and "Trueman,"<br>a Foxhound-Harrier . . . . . | 63   | The Gordon Setter . . . . .                                       | 102  |
| "Dahlia," a pure Foxhound . . . . .                                  | 65   | A Russian Setter slightly crossed with<br>English blood . . . . . | 104  |
| The Medium-sized Beagle . . . . .                                    | 67   | "Brass" and "Judy," Clumber<br>Spaniels . . . . .                 | 110  |
| "Barmaid," a Dwarf Beagle, bred by<br>Lord Gifford . . . . .         | 69   | "George" and "Romp," Sussex<br>Spaniels . . . . .                 | 111  |
|  |      | English and Welsh Cockers . . . . .                               | 114  |

LIST OF ENGRAVINGS.

|  | PAGE  |   | PAGE |
|--|-------|---|------|
| The Southern Irish Water Spaniel . . . . . | 117   | "Hecate," second Cross from the Bull-       |      |
| The English Sheep-Dog . . . . .            | 120   | dog . . . . .                               | 182  |
| The Colley . . . . .                       | 122   | "Heeaba," third Cross from the Bull-        |      |
| The Larger Newfoundland Dog . . . . .      | 125   | dog . . . . .                               | 183  |
| "Billy," a St. John's or Lesser Lab-       |       | "Hysteries," fourth Cross from the          |      |
| rador Dog . . . . .                        | 129   | Bulldog . . . . .                           | 184  |
| The Esquimaux Dog . . . . .                | 130   | Ground Plan of Greyhound Ken-               |      |
| "Top," a pure Bulldog . . . . .            | 133   | nel . . . . .                               | 226  |
| The Cuban Mastiff . . . . .                | 139   | Elevation of Greyhound Kennel . . . . .     | 227  |
| "Wallace," an English Mastiff . . . . .    | 140   | Plan of Kennel Berch for Hounds . . . . .   | 232  |
| The Mount St. Bernard Dog . . . . .        | 143   | Muir's Ventilating Apparatus . . . . .      | 234  |
| The Thibet Dog . . . . .                   | 145   | Diagram of the principle upon which         |      |
| The Poodle . . . . .                       | 147   | Pointers should beat their ground . . . . . | 255  |
| "Psyche," a Maltese Bitch . . . . .        | 149   | Hunting with a "Puzzle-peg" . . . . .       | 260  |
| Pomeranian, or Spitz Dog . . . . .         | 151   | The Skeleton of the Dog . . . . .           | 334  |
| The King Charles and Blenheim              |       | Teeth of the Dog at various ages . . . . .  | 337  |
| Spaniels . . . . .                         | 153   | The Maw-worm . . . . .                      | 431  |
| "Punch" and "Tetty," Pugs . . . . .        | 156   | The Round-worm . . . . .                    | 431  |
| Retriever (Flat-coated) . . . . .          | 162   | The Tape-worm . . . . .                     | 433  |
| "Madman," Bull-Terrier . . . . .           | 166   | „ (Segment of) . . . . .                    | 434  |
| A Dog and Fox crossed Bitch . . . . .      | [164] | The Kidney-worm . . . . .                   | 436  |
| "Half-and-Half," first Cross from the      |       |   |      |
| Bulldog . . . . .                          | 181   |   |      |

# THE DOG.



## BOOK I.

THE NATURAL HISTORY, ZOOLOGICAL CLASSIFICATION, AND  
VARIETIES OF THE DOG.



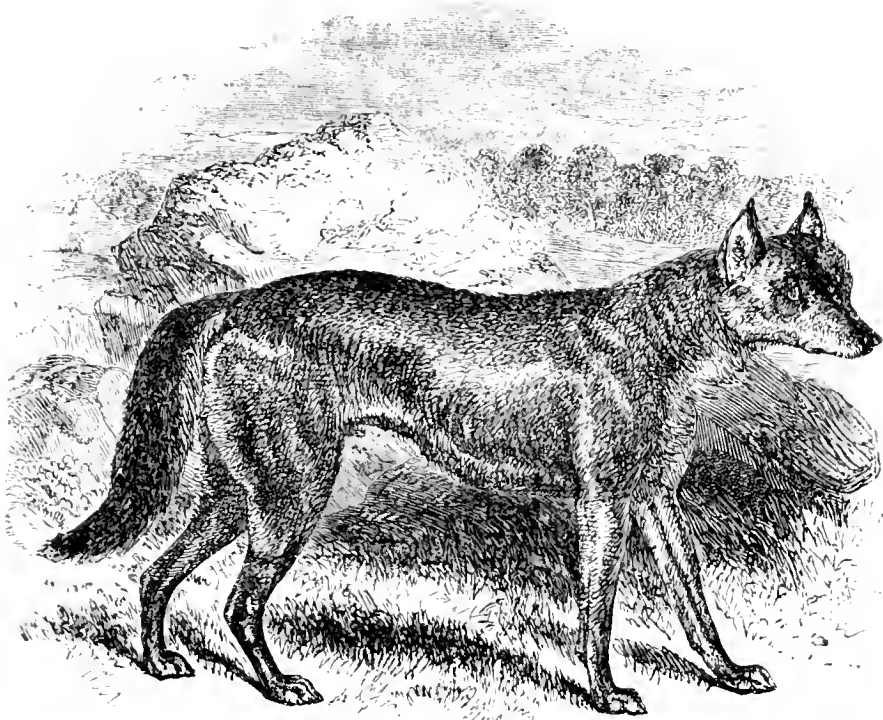

L. WELLS.

The Wolf. From a specimen in the Zoological Gardens.

## INTRODUCTORY CHAPTER.

Origin.—General Characteristics.—Habitat.—Varieties.—F. Cuvier's Divisional Arrangement.—Arrangement adopted by the Author.

FROM the earliest times we have reason to believe that the dog has been the faithful companion and assistant of man in all parts of the world, and his fidelity and attachment are so remarkable as to have become proverbial. Before the introduction of agriculture, it was by means of the hunting powers of this animal that man was enabled to support himself by pursuing the wild denizens of the forest; for though now, with the aid of gunpowder, he can in great

measure dispense with the services of his assistant, yet, until the invention of that destructive agent, he was, in default of the dog, reduced to the bow and arrow, the snare, or the pitfall. The dog was also of incalculable service in guarding the flocks and herds from the depredations of the *Carnivora*, and even man himself was often glad to have recourse to his courage and strength in resisting the lion, the tiger, or the wolf.

Much has been written on the origin of the dog, and Pennant, Buffon, and other naturalists have exhausted their powers of research and invention in attempting to discover the parent stock from which all are descended. The subject, however, is wrapped in so much obscurity as to baffle all their efforts, and it is still a disputed point whether the shepherd's dog, as supposed by Buffon and Daniel, or the wolf, as conjectured by Bell, is the progenitor of the various breeds now existing. Anyhow, it is a most unprofitable speculation, and, being unsupported by proof of any kind, it can never be settled upon any reliable basis. We shall not, therefore, waste any space in entering upon this discussion, but leave our readers to investigate the inquiry, if they think fit, in the pages of Buffon, Linnæus, Pennant, and Cuvier, and our most recent investigator, Professor Bell. It may, however, be observed that the old hypothesis of Pennant that the dog is only a domesticated jackal, crossed with the wolf or fox, though resuscitated by Mr. Bell, is now almost entirely exploded; for while it accounts somewhat ingeniously for the varieties which are met with, yet it is contradicted by the stubborn fact that, in the present day, the cross of the dog with either of these animals, *if produced*, is in-

capable of continuing the species when paired with one of the same crossed breed. Nevertheless, it may be desirable to give Mr. Bell's reasons for thinking that the dog is descended from the wolf, which are as follows:—

“ In order to come to any rational conclusion on this head, it will be necessary to ascertain to what type the animal approaches most nearly, after having for many successive generations existed in a wild state, removed from the influence of domestication, and of association with mankind. Now we find that there are several different instances of the existence in dogs of such a state of wildness as to have lost even that common character of domestication, variety of colour and marking. Of these, two very remarkable ones are the dhole of India and the dingo of Australia. There is, besides, a half-reclaimed race amongst the Indians of North America, and another also partially tamed in South America, which deserve attention. And it is found that these races in different degrees, and in a greater degree as they are more wild, exhibit the lank and gaunt form, the lengthened limbs, the long and slender muzzle, and the great comparative strength which characterise the wolf; and that the tail of the Australian dog, which may be considered as the most remote from a state of domestication, assumes the slightly bushy form of that animal.

“ We have here a remarkable approximation to a well-known wild animal of the same genus, in races which, though doubtless descended from domesticated ancestors, have gradually assumed the wild condition; and it is worthy of especial remark that the anatomy of the wolf, and its osteology in particular, does not



differ from that of the dog in general, more than the different kinds of dogs do from each other. The cranium is absolutely similar, and so are all, or nearly all, the other essential parts ; and, to strengthen still further the probability of their identity, the dog and wolf will readily breed together, and their progeny is fertile. The obliquity of the position of the eyes in the wolf is one of the characters in which it differs from the dog ; and, although it is very desirable not to rest too much upon the effects of habit on structure, it is not perhaps straining the point to attribute the forward direction of the eyes in the dog to the constant habit, for many successive generations, of looking forward to his master, and obeying his voice.”\*

Such is the state of the argument in favour of the original descent from the wolf, but, as far as it is founded upon the breeding together of the wolf and dog, it applies also to the fox, which is now ascertained occasionally to be impregnated by the dog ; but in neither case we believe does the progeny continue to be fertile if put to one of the same cross, and as this is now ascertained to be the only reliable test, the existence of the first cross stands for nothing. Indeed, experience shows us more and more clearly every year, that no reliance can be placed upon the test depending upon fertile intercommunion, which, especially in birds, is shown to be liable to various exceptions. Still it has been supported by respectable authorities, and for this reason we have given insertion to the above extract.

---

\* Bell's British Quadrupeds, pp. 196-7.

## GENERAL CHARACTERISTICS.

In every variety the dog is more or less endowed with a keen sight, strong powers of smell, sagacity almost amounting to reason, and considerable speed, so that he is admirably adapted for all purposes connected with the pursuit of game. He is also furnished with strong teeth, and courage enough to use them in defence of his master, and with muscular power sufficient to enable him to draw moderate weights, as we see in Kamtschatka and Newfoundland. Hence, among the old writers, dogs were divided into *Pugnaces*, *Sagaces*, and *Celeres*; but this arrangement is now superseded, various other systems having been adopted in modern times, though none perhaps much more satisfactory. Belonging to the division *Vertebrata*, class *Mammalia*, order *Feræ*, family *Felidæ*, and subfamily *Canina*, the species is known as *Canis familiaris*, the subfamily being distinguished by having two tubercular teeth behind the canines on the upper jaw, with non-retractile claws, while the dog itself differs from the fox with which he is grouped, in having a round pupil in the eye instead of a perpendicular slit, as is seen in that animal.

The attempt made by Linnæus to distinguish the dog as having a tail curved to the left, is evidently without any reliable foundation, as though there are far more with the tail on that side than on the right, yet many exceptions are to be met with, and among the pugs almost all the bitches wear their tails curled to the left.

The definition, therefore, of *Canis familiaris caudá (sinistrorsum) recurvatá*, will not serve to separate the species from the others of the genus *Canis*, as proposed by the Swedish naturalist.

---

#### HABITAT.

In almost every climate the dog is to be met with, from Kamtschatka to Cape Horn, the chief exception being some of the islands in the Pacific Ocean; but it is only in the temperate zone that he is to be found in perfection, the courage of the bulldog and the speed of the greyhound soon degenerating in tropical countries. In China and the Society Islands dogs are eaten, being considered great delicacies, and by the ancients the flesh of a young fat dog was highly prized, Hippocrates even describing that of an adult as wholesome and nourishing. In a state of nature the dog is compelled to live on flesh which he obtains by hunting, and hence he is classed among the *Carnivora*; but when domesticated he will live upon vegetable substances alone, such as oatmeal porridge, or bread made from any of the cereals, but thrives best upon a mixed diet of vegetable and animal substances; and, indeed, the formation of his teeth is such as to lead us to suppose that by nature he is intended for it, as we shall hereafter find in discussing his anatomical structure.

---

## VARIETIES OF THE DOG.

The varieties of the dog are extremely numerous, and, indeed, as they are apparently produced by crossing, which is still had recourse to, there is scarcely any limit to the numbers which may be described. It is a curious fact that large bitches frequently take a fancy to dogs so small as to be incapable of breeding with them; and in any case, if left to themselves, the chances are very great against their selecting mates of the same breed as themselves. The result is, that innumerable nondescripts are yearly born, but as a certain number of breeds are described by writers on the dog, or defined by "dog-fanciers," these "mongrels," as they are called from not belonging to them, are generally despised, and, however useful they may be, the breed is not continued. This, however, is not literally true, exceptions being made in favour of certain sorts which have been improved by admixture with others, such as the cross of the bulldog with the greyhound; the foxhound with the Spanish pointer; the bulldog with the terrier, &c., &c., all of which are now recognised and admitted into the list of valuable breeds, and not only are not considered mongrels, but, on the contrary, are prized above the original strains from which they are descended. An attempt has been made by M. F. Cuvier to arrange these varieties under three primary divisions, which are founded upon the shape of the head, and the length of the jaws; these being supposed by him to vary in accordance with the degree of cunning and scenting powers, which the animal possessing them displays. The following

is his classification, which in the main is correct, and I shall adhere to it with trifling alterations in the pages of this book.

*F. Cuvier's Divisional Arrangement.*

I. MÀTINS.

*Characterised* by head more or less elongated; parietal bones insensibly approaching each other; condyles of the lower jaw placed in a horizontal line with the upper molar teeth, exemplified by—

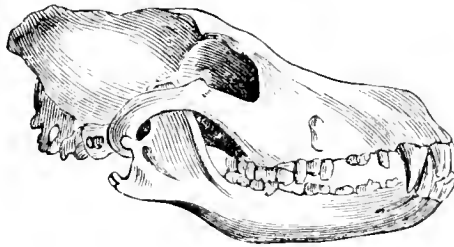

Skull of Dingo.

SECT. 1. *Half-reclaimed dogs*, hunting in packs; such as the Dingo, the Dhole, the Pariah, &c.

SECT. 2. *Domesticated dogs*, hunting in packs, or singly, but using the eye in preference to the nose; as, for instance, the Albanian dog, Deerhound, &c.

SECT. 3. *Domesticated dogs*, which hunt singly, and almost entirely by the eye. Example: the Greyhound.

## II. SPANIELS.

*Characteristics.* Head moderately elongated; parietal bones do not approach each other above the temples, but diverge and swell out, so as to enlarge the forehead and cavity of the brain.

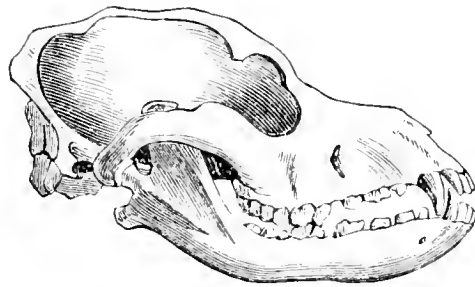

Skull of Spaniel.

- SECT. 4. *Pastoral dogs*, or such as are employed for domestic purposes. Example: Shepherd's Dog.
- SECT. 5. *Water dogs*, which delight in swimming. Examples: Newfoundland Dog, Water-Spaniel, &c.
- SECT. 6. *Fowlers*, or such as have an inclination to chase or point birds by scenting only, and not killing. Examples: the Setter, the Pointer, the Field-Spaniel, &c.
- SECT. 7. *Hounds*, which hunt in packs by scent, and kill their game. Examples: the Foxhound, the Harrier, &c.
- SECT. 8. *Crossed breeds, for sporting purposes.* Example: the Retriever.

## III. HOUSE DOGS.

*Characteristics.* Muzzle more or less shortened; skull high; frontal sinuses considerable; condyle of the lower jaw extending above the line of the upper cheek teeth. Cranium smaller in this group than in the first and second, in consequence of its peculiar formation.

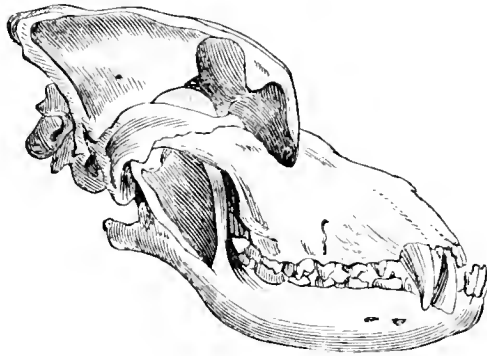

Skull of Mastiff.

SECT. 9. *Watch dogs* which have no propensity to hunt, but are solely employed in the defence of man, or his property. Examples: the Mastiff, the Bulldog, the Pug dog, &c.

As before remarked, this division is on the whole founded on natural laws, but there are some anomalies which we shall endeavour to remove. For instance, the greyhound is quite as ready to hunt in packs as any other hound, and is only prevented from doing so by the hand of his master. The same restraint keeps him

from using his nose, or he could soon be nearly as good with that organ as with the eye. So also Cuvier defines his sixth section as “having an inclination to chase and point *birds*,” whereas they have as great, and often a greater, desire for hares and rabbits. Bearing therefore in mind these trifling defects, we shall consider the dog under the following heads:—

CHAP. I. Wild and half-reclaimed dogs, hunting in packs.

CHAP. II. Domesticated dogs, hunting chiefly by the eye, and killing their game for the use of man.

CHAP. III. Domesticated dogs, hunting chiefly by the nose, and both finding and killing their game.

CHAP. IV. Domesticated dogs, finding game by scent, but not killing it; being chiefly used in aid of the gun.

CHAP. V. Pastoral dogs, and those used for the purposes of draught.

CHAP. VI. Watch dogs, House dogs, and Toy dogs.

CHAP. VII. Crossed breeds, Retrievers, &c.



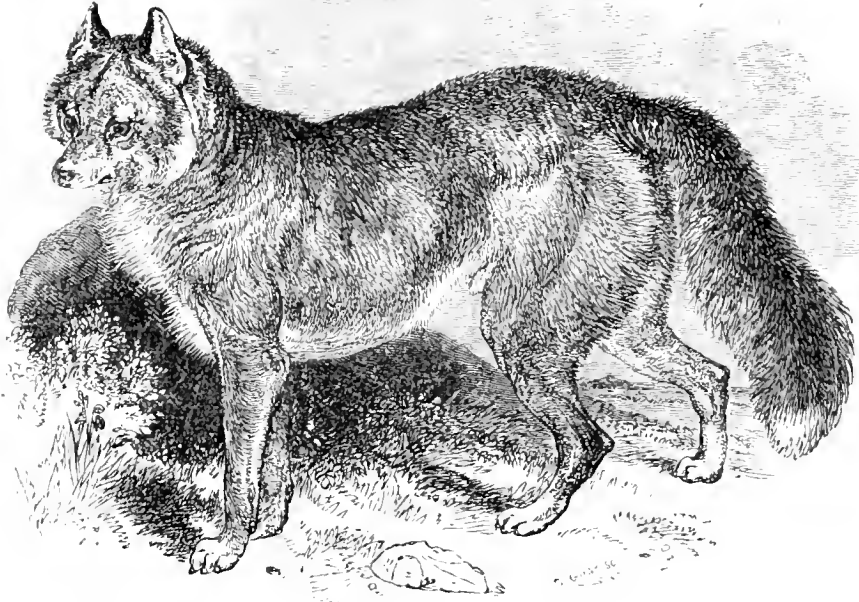

The Dingo. (Youatt.)

## CHAPTER I.

Wild and half-reclaimed Dogs, hunting in Packs. — The Dingo. — The Dhole. — The Pariah. — The Wild Dog of Africa. — The South-American Dog. — The North-American Dog. — Other wild Dogs.

### THE DINGO.

It is upon the great similarity between these wild dogs and the wolf or fox, that the supposition is founded of the general descent of the domesticated dog from either the one or the other. After examining the portrait of the dingo, it will at once be seen that it resembles the fox so closely in the shape of its body, that an

ordinary observer could readily mistake it for one of that species, while the head is that of the wolf. The muzzle is long and pointed, the ears short and erect. Height about 24 inches, length 30 inches. His coat is more like fur than hair, and is composed of a mixture of silky and woolly hair, the former being of a deep yellow, while the latter is grey. The tail is long and bushy, and resembles that of the fox, excepting in carriage, the dingo curling it over the hip, while the fox trails it along the ground.\* While in his unreclaimed state this dog is savage and unmanageable, but is easily tamed, though even then he is not to be trusted, and when set at liberty will endeavour to escape. Many dingoes have been brought to this country, and some of its crosses with the terrier have been exhibited as hybrids between the dog and fox, which latter animal they closely resemble, with the single exception of the pendulous tail. Whenever, therefore, a specimen is produced which is said to be this hybrid, every care must be taken to ascertain the real parentage without relying upon the looks alone.

---

#### THE DHOLE.

The native wild dog of India, called the dhole, resembles the dingo, in all but the tail, which, though hairy, is not at all bushy. The following is Captain Williamson's description, extracted from his "Oriental Field Sports," which is admitted to be a very accurate

\* The engraving of the Dingo was taken from an animal in confinement, in which state the tail is seldom curled upwards.

account by those who have been much in India. "The dholes are of the size of a small greyhound. Their countenance is enlivened by unusually brilliant eyes. Their body, which is slender and deep-chested, is thinly covered by a coat of hair of a reddish brown or bay colour. The tail is dark towards its extremity. The limbs are light, compact, and strong, and equally calculated for speed and power. They resemble many of the common pariah dogs in form, but the singularity of their colour and marks at once demonstrate an evident distinction. These dogs are said to be perfectly harmless if unmolested. They do not willingly approach persons, but, if they chance to meet any in their course, they do not show any particular anxiety to escape. They view the human race rather as objects of curiosity than either of apprehension or enmity. The natives who reside near the Ranochitty and Kateunsandy passes, in which vicinity the dholes may frequently be seen, describe them as confining their attacks entirely to wild animals, and assert that they will not prey on sheep, goats, &c.; but others, in the country extending southward from Jelinah and Meehungunge, maintain that cattle are frequently lost by their depredations. I am inclined to believe that the dhole is not particularly ceremonious, but will, when opportunity offers, and a meal is wanting, obtain it at the expense of the neighbouring village.

"The peasants likewise state that the dhole is eager in proportion to the animal he hunts, preferring the elk to any other kind of deer, and particularly seeking the royal tiger. It is probable that the dhole is the principal check on the multiplication of the tiger; and although incapable individually, or perhaps in small

numbers, to effect the destruction of so large and ferocious an animal, may, from their custom of hunting in packs, easily overcome any smaller beast found in the wilds of India." Unlike most dogs which hunt in packs, the dholes run nearly mute, uttering only occasionally a slight whimper, which may serve to guide their companions equally well with the more sonorous tongues of other hounds. The speed and endurance of these dogs are so great as to enable them to run down most of the varieties of game which depend upon flight for safety, while the tiger, the elk, and the boar diminish the numbers of these animals by making an obstinate defence with their teeth, claws, or horns, so that the breed of dholes is not on the increase.

---

#### THE PARIAH.

This is the general name in India for the half-reclaimed dogs which swarm in every village, owned by no one in particular, but ready to accompany any individual on a hunting excursion. They vary in appearance in different districts, and cannot be described very particularly; but the type of the pariah may be said to resemble the dhole in general characteristics, and the breed is most probably a cross with that dog and any accidental varieties of domesticated dogs which may have been introduced into the respective localities. They are almost always of a reddish brown colour, very thin and gaunt, with pricked ears, deep chest, and tucked up belly. The native Indians hunt the tiger and wild boar, as well as

every species of game, with these dogs, which have good noses and hunt well, and though they are not so high-couraged as our British hounds, yet they often display considerable avidity and determination in "going in" to their formidable opponents.

---

#### THE EKIA, OR WILD AFRICAN DOG.

The native dogs of Africa are of all colours, black, brown, and yellow, or red; and they hunt in packs, giving tongue with considerable force. Though not exactly wild, they are not owned by any individuals among the inhabitants, who, being mostly Mahometans, have an abhorrence of the dog, which by the Koran is declared to be unclean. Hence they are complete outcasts, and obtain a scanty living either by hunting wild animals where they abound, or, in those populous districts where game is scarce, by devouring the offal which is left in the streets and outskirts of the towns. The *Ekia*, also called the *Deab*, is of considerable size, with a large head, small pricked ears, and round muzzle. His aspect in general resembles that of the wolf, excepting in colour, which, as above remarked, varies greatly, and in the tail, which is almost always spotted or variegated. These dogs are extremely savage, probably from the constant abuse which they meet with, and they are always ready to attack a stranger on his entrance into any of the villages of the country. They are revolting animals, and unworthy of the species they belong to.

---

## THE NORTH AND SOUTH AMERICAN DOGS.

A great variety of the dog tribe is to be met with throughout the continent of America, resembling in type the dingo of Australia, but appearing to be crossed with some of the different kinds introduced by Europeans. One of the most remarkable of the South-American dogs is the *Aleo*, which has pendulous ears, with a short tail and hog-back, and is supposed to be descended from the native dog found by Columbus; but, even allowing this to be the case, it is of course much intermixed with foreign breeds. The North-American dogs are very closely allied to the dingo in all respects, but are generally smaller in size, and are also much crossed with European breeds. In some districts they burrow in the ground, but the march of civilisation is yearly diminishing their numbers throughout the continent of America.

---

  
OTHER WILD DOGS.

Many other varieties of the wild dog are described by travellers, but they all resemble one or other of the above kinds, and are of little interest to the general reader.



“CADER.” A Deerhound of the pure Glengarry breed, 28 inches high, 34 inches in girth.  
Bred by W. Meredith, Esq., Torrish, Sutherland.

## CHAPTER II.

### DOMESTICATED DOGS HUNTING CHIEFLY BY THE EYE, AND KILLING THEIR GAME FOR MAN'S USE.

The Rough Scotch Greyhound and Deerhound.—The Smooth or English Greyhound.—The Gazhound.—The Irish Greyhound, or Wolf-dog.—The French Mâtin.—The Hare-Indian Dog.—The Albanian Dog.—The Grecian Greyhound.—The Turkish Greyhound.—The Persian Greyhound.—The Russian Greyhound.—The Italian Greyhound.

#### THE ROUGH SCOTCH GREYHOUND AND DEERHOUND.

THIS breed of dogs is, I believe, one of the oldest and purest in existence, but it is now rapidly becoming extinct, being supplanted

in public estimation, for coursing purposes, by the English greyhound, or by a cross between the two. The rough greyhound is identical in shape and make with the pure deerhound, and the two can only be distinguished by their style of running when at work or play; the deerhound, though depending on his nose, keeping his head much higher than the greyhound, because he uses this attitude in waiting to pull down his game. By some people it is supposed that the smooth variety of the greyhound is as old as the rough; but, on carefully examining the description given by Arrian, no one can doubt that the dog of his day was rough in his coat, and in all respects like the present Scotch dog. In shape the Scotch greyhound resembles the ordinary smooth variety, but he is rather more lathy, and has not quite the same muscular development of loin and thigh, though, the bony frame being more fully developed, this is perhaps more apparent than real.

In spite of the external form being the same in the rough Scotch greyhound used for coursing hares, and the deerhound, there can be no doubt that the two breeds, from having been kept to their own game exclusively, are specially adapted to its pursuit by internal organisation, and the one cannot be substituted for the other with advantage. Generally speaking, the deerhound is of larger size than the greyhound, some being 28 inches high, though this size is not very uncommon in the greyhound, and dogs of  $26\frac{1}{2}$  or 27 inches are often seen. Mr. Scrope, the talented author of "Deer-stalking," gives the following description of Buskar, a celebrated deerhound belonging to Captain McNeill of Colonsay, viz. : height, 28 inches; girth round the chest, 32



inches ; running weight, 85 lbs. ; colour, red or fawn, with black muzzle. To these external qualifications were added great speed and strength, combined with endurance and courage, while the sagacity and docility of the dog made him doubly valuable. He was used for coursing the deer, but his nose was good enough for hunting, even a cold scent, as was the case with all of his breed. Whether or not the deerhound can now be procured in a state of purity I am not prepared to say, but that they are extremely rare is above dispute, though there are numberless animals resembling them in form, but all more or less crossed with the foxhound, bloodhound, bulldog, &c., and consequently not absolutely pure. Mr. Scrope himself, with all his advantages, could not succeed in obtaining any, and had recourse to the cross of the greyhound with the foxhound, which, he says, answered particularly well ; as, according to his experience, “you get the speed of the greyhound with just enough of the nose of the foxhound to answer your purpose. . . . In point of shape they resemble the greyhound, but they are larger in the bone and shorter in the leg. Some of them, when in slow action, carry the tail over the back like the pure foxhound ; their dash in making a cast is most beautiful, and they stand all sorts of rough weather.” (p. 314.) He advises that the first cross only should be employed, fearing that, as in some other instances, the ultimate results of breeding back to either strain, or of going on with the two crosses, would be unsatisfactory. “Maida,” the celebrated deerhound belonging to Sir Walter Scott, was a cross of the greyhound with the bloodhound, but some distance off the latter. The bulldog in-

fusion has the disadvantage of making the deerhound thus bred attack the deer too much in front, by which he is almost sure to be impaled on the horns, so that, in spite of the high courage of the breed, it is from this cause quite useless in taking deer.

The rough Scotch greyhound, as used for coursing, averages about 26 inches in the dog, and 22 or 23 inches in the bitch; but, as above remarked, its use is almost abandoned in public, and those which are still bred are either used in private, or are kept entirely for their ornamental properties, which are very considerable, and, as they resemble the deerhound, they are very commonly passed off for them. They are of all colours, but the most common are fawn, red, brindled (either red and black mixed, or fawn and blue), grey, and black. The coat is harsh, long, and rough, especially about the jaws, where the hair stands out like that of a Scotch terrier. In speed they are about equal to the smooth greyhound, but they do not appear to be quite so stout, though of late we have had no opportunities of judging, as a rough greyhound in public is rare in the extreme. Mr. A. Graham, who formerly was celebrated for his breed of these dogs, has now abandoned their use, excepting when largely crossed with the smooth greyhound, for which purpose they seem well suited, when the former are too small or too delicate for the work they have to do. But as these are now bred of a much more hardy kind than formerly, so that they will stand cold and wet almost as well as the Scotch dog, there is little necessity for resorting to the cross, and it is accordingly abandoned by almost all the breeders of the animal. Nevertheless, some of the best dogs of the present

day have a strain of the rough dog in them, but it is gradually dying out as compared with ten or twenty years ago. It is alleged, and I fancy with some truth, that the rough dog runs cunning sooner than the smooth, and hence the cross is objected to; and certainly many litters of greyhounds bred in this way within the last few years have been remarkable for this objectionable vice.

*The points*, or desirable external characteristics of this breed, with the exception of the rough coat, are so similar to those of the smooth greyhound, that the two may be considered together.

---

#### THE SMOOTH GREYHOUND.

This elegant animal appears to have existed in Britain from a very early period, being mentioned in a very old Welsh proverb, and a law of King Canute having precluded the commonalty from keeping him. Numberless hypotheses have been brought forward relative to the origin of the greyhound, Buffon tracing him to the French nation, and some other writers fancying that they could with more probability consider him as the descendant of the bulldog or the mastiff. But as I believe that it is impossible to ascertain with any degree of certainty the origin of the *species Canis*, so I am quite satisfied with the conclusion that no long-standing *variety* can be traced to its source. We must, therefore, be content to take each as we find it, and rest content with investigating its present condition; perhaps in some cases extending

our researches back for fifty or a hundred years, and even then we shall often find that we are lost in a sea of doubt.

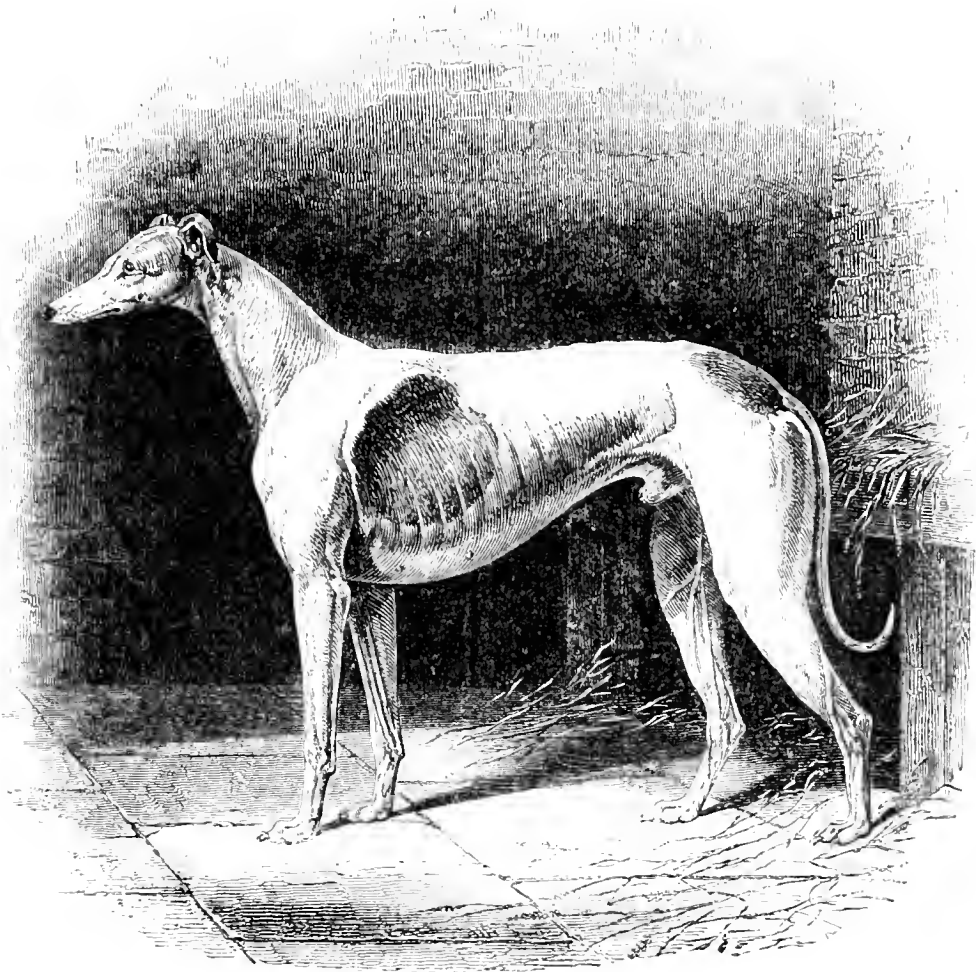

Captain Daintree's "KING COB."

Until within the last twenty-five years public coursing was confined to a very limited circle of competitors, partly owing to the careful retention of the best blood in the kennels of a chosen few, but chiefly to the existing game laws, which made it imperative that every person coursing should not only have a certificate,

but also a qualification, that is to say, the possession of landed property to the value of one hundred pounds per annum. Hence the sport was forbidden to the middle classes, and it was not until the passing of the present game laws, in 1831, that it was thrown open to them. From that time to the present the possession of the greyhound has been coveted and obtained by great numbers of country gentlemen and farmers in rural districts, and by professional men as well as tradesmen in our cities and towns, so that the total number in Great Britain and Ireland may be estimated at about fifteen or twenty thousand. Of these about five or six thousand are kept for public coursing, while the remainder amuse their owners by coursing the hare in private.

Various explanations have been offered of the etymology of the prefix *grey*, some contending that the colour is implied, others that it means Greek (*Græius*), while a third party understand it to mean *great*. But as there is a remarkable peculiarity in this breed connected with it, we need not, I think, go farther for the derivation. No other breed, I believe, has the blue or grey colour prevalent; and those which possess it at all have it mixed with white, or other colour; as, for instance, the blue-mottled harrier, and the blotched blue and brown seen in some other kinds. The greyhound, on the contrary, has the pure blue or iron *grey* colour very commonly; and although this shade is not admired by any lovers of the animal for its beauty, it will make its appearance occasionally. Hence it may fairly be considered a peculiarity of the breed, and this grey colour may, therefore, with a fair show of probability, have given the name to the greyhound.

In describing the greyhound it is usual, and indeed almost necessary, to consider him as used for the two purposes already mentioned, that is to say,—1st, as the private, and 2ndly, as the public, greyhound; for though externally there is no difference whatever, yet in the more delicate organization of his brain and nerves there is some obscure variation, by which he is rendered more swift and clever in the one case, and more stout and honest in the other. In the horse the eye readily detects the thoroughbred, but this is not the case here; for there are often to be met with most beautifully formed greyhounds of private blood, which it would be impossible to distinguish from the best public breeds by their appearance, but which in actual trial would be sure to show defective speed and cleverness. This being the case I shall first describe the general characteristics of both, and afterwards those in which they differ from one another.

*The points* of the greyhound will be described at length, because as far as speed goes, he may be taken as the type to which all other breeds are referred; but, before going into these particulars, it will be interesting to examine the often-quoted doggrel rhymes, which are founded upon a longer effusion originally published by Wynkyn de Worde in 1496, and to institute a comparison between the greyhound, of the fifteenth and nineteenth centuries. In the former of these periods it was said that this dog should have—

“The head of a snake,  
The neck of the drake,  
A back like a beam,  
A side like a bream,  
The tail of a rat,  
And the foot of a cat.”

Now, although the several points herein mentioned may be enlarged upon, it is scarcely possible to dissent from any one of them; but, as all my readers may not exactly know the form which is meant to be conveyed by the side of a bream for instance, it is necessary to explain it in more intelligible language.

1st. The HEAD, it is said, should be snake-like, but this is not to be taken literally, as that of the snake differs considerably from the head of any specimen of the greyhound which has ever come under my observation. Every snake's head is flat and broad, with the nose or snout also quite compressed, while the head of the greyhound, though flat at the top, is comparatively circular in its transverse section, and the nose is irregularly triangular. There is no doubt that the greyhound of former days, before the cross of the bulldog was introduced, had a much smaller head than that which is now seen; and I also believe that some breeds at present existing may be ascertained to be free from this cross, by their small brain-cases; but, still, none have the perfectly flat head of the reptile in question. The tyro, therefore, who looks for a literal interpretation of the first line of the rhyme will be disappointed. My own belief is that a full development of brain gives courage and cleverness, but leads to such a rapid acquirement of knowledge relative to the wiles practised by the hare, as to make the dog possessing it soon useless for anything but killing his game, which he is often able to do with absolute certainty. Hence it is important to bear this in mind, and to take care not to overdo this characteristic. In all cases, the more the development is increased behind the ears, the higher will be the courage; and if this can be

obtained without a corresponding increase in the diameter in front of those organs, there will be no attendant disadvantage, as the intellectual faculties no doubt reside in the anterior part of the brain. The best average measurement opposite the ear in dogs of full size is about 15 inches, and for bitches, 14 or 14½. The jaw should be very lean, and diminishing suddenly from the head, not gradually falling off in one uniform line. The teeth are of great importance, as, unless they are strong and good, the hare cannot be seized and held. They should be white, strong, and regular, showing strength of constitution, as well as being useful in the course. As a rule, the incisor teeth meet each other, but some dogs are underhung like the bulldog, and others the reverse like the pig; that is to say, one or other set of teeth overlaps those above or below, as the case may be. The former is not of much consequence unless very much marked, when it diminishes the chance of holding the hare; but the latter is certainly prejudicial, and a "pig-jawed" greyhound should never be selected, though I have known one or two good killers with this formation. The eye should be bright and tolerably full, the colour varying with that of the coat. The ears are generally recommended to be soft and falling, and pricked ears are despised, as being terrier-like, but some good breeds possess them, nevertheless, probably deriving them from the bulldog. I cannot, therefore, lay any great stress upon this point in the formation of the head.

The NECK also, though compared to that of a drake, is a long way from being as thin, but, nevertheless, it may be said that it



should be as drake-like as possible. The object of this is to enable the greyhound to stoop and bear the hare without being put out of his stride. The proper average length of the neck is about equal to that of the head.

The beam-like BACK is all-important, for without strength in this department, though high speed may be obtained for a short distance, it is impossible to maintain it, and then we have a flashy animal, who is brought up at the end of a quarter of a mile. What is meant by the comparison to the beam is not only that it shall be strong, but that the back shall have the peculiar *square* form of that object. There is a long muscle which runs from the hip forwards to be attached to the angles of the ribs, and this, if well developed, gives great power in turning, so that it is a very essential point, and upon the size of it the squareness mainly depends. Without width of hip no back can be strong, since the muscles have no possibility of attachment in sufficient breadth, and the same may be said of the ribs. In examining, therefore, a dog out of condition, the experienced eye often detects the probability of the future development of a good back, even though there is no appearance of muscle at the time; because, the bones being of good size and breadth, there is every reason to expect, *with health* and good feeding, that they will be covered by their usual moving powers, and will then show the substance which is desired. It is also desirable to have depth of back from above downwards, by which the whole body is "buckled and unbuckled" with quickness and power, as is required in the gallop. The muscles of the abdomen may draw the chest towards the hind legs powerfully, but the action is

too slow, and for quick contraction those of the under side of the back are essential.

By the *SIDE* is to be understood the chest, which is composed of the two sides combined. The *breem-like* form of this part depends upon the width at the angles of the ribs, where they curve towards the backbone, and upon which, as I before observed, the size of the back depends. Very round ribs like a barrel are not so desirable as the squared form which I have alluded to, for several reasons which will be given under the anatomical description of this part. Great depth of chest is apt to prevent the dog stooping on rough ground, as he strikes it against high ridges or large stones, but a moderately deep chest is a valuable point, giving plenty of "bellows' room" as it is popularly called. This, however, is provided for better by breadth than depth, and the former should be insisted on more than the latter, provided there is not that round tub-like form of the ribs which interferes with the action of the shoulder-blades, and often accompanies low breeding.

A rat-like *TAIL* is insisted upon, not as of absolute use in any way, but as a sign of high breeding, without which it is well known the greyhound is comparatively valueless. But it must be understood that it is only in the size of the bones that the similarity should be insisted on, for many good breeds have a considerable quantity of hair upon the tail, though this never ought to be in a bushy form. A slight fan-like distribution of hair is not therefore to be considered objectionable, and in puppies is a mark of hardihood.

Cat-like *FEET* are much insisted on, and this point has been so much attended to that some breeds have been produced remarkable

for having their feet even more round than those of the cat. Their toes seem to be the only parts touching the ground, the pad appearing as if it was not in contact with it. This form I believe to be an exaggeration of a good point, as all dogs so provided are very apt to draw their nails, or break their toes, both of which accidents it is of great importance to avoid. The most essential point, therefore, is such a form of foot as will prevent the toes spreading, taking care that the knuckles are well up, by which a good foothold is secured. But beyond this it is necessary to provide for the wear and tear which the sole of the foot incurs, and hence *a thick pad well covered with hard skin* is to be insisted on. If the greyhound has this he will stand his work, while its absence renders him at all times liable to become footsore, and incapable of doing it.

The HIND QUARTER is entirely overlooked in the rhymes above-mentioned, but it is of the greatest importance nevertheless, being the chief element of progression. First of all, we should insist upon a good framework, which, presenting the levers acted on by the muscles, must be in proper form, and of sufficient length and strength. Thus it is usual in examining puppies for selection to extend them to their full length, and then the one which stretches over the greatest distance is supposed to be the best in this point, and (other things being equal) very properly so. Thus, then, we arrive at the conclusion that the hinder limbs should be made up of long bones; but they must be united by well-formed joints, and in order that the dog shall not stand too high they should be well bent, though if the fore part of the dog is lower than the hind there is no necessity for the presence of this form, as it comes to the same

thing in reality. Strong bony stifle-joints and hocks, with great length between them and from the stifle to the hip, united with a short leg, constitute the perfection of form in the hind quarter, if, as is almost always the case, the muscles covering them are strong enough to put them in action.

The FORE QUARTER is composed of the shoulder, the upper arm (between it and the elbow), the fore-arm (below the elbow), the knee, the leg, and the foot. The shoulder should be oblique, well covered with muscles, and moving freely on the ribs, which it seldom does if the two blades are kept wide apart at their upper edges by the tub-like form of the chest, described under that head. Hence we should examine, and anxiously look for, length of shoulder-blade, which cannot exist without obliquity; freedom of play, without which the fore quarter is not protruded in the gallop as it ought to be; and muscular development to bear the shocks to which this part is subject. The arm also should be long, so as to raise the point of the shoulder high enough to make the blade lie at an angle of  $45^{\circ}$  with the horizon, and to throw the elbow well back to take the weight of the body. With regard to the elbow itself, the joint must be placed in the same plane as the body; that is to say, the point of the elbow should not project either inwards or outwards. In the former case the feet are turned out, and then there is a want of liberty in the play of the whole shoulder, because the elbow rubs against the ribs, and interferes with the action. This is called being "tied at the elbow," and is most carefully to be avoided in selecting the greyhound, as well as all other breeds. The arm should be straight, long, and well clothed with

muscle. The knee should be bony, and not bent too much back, which is an element of weakness, though seldom to such an extent as to be prejudicial to real utility. The leg, or bones below the knee, should be of good size, the stopper (or upper pad) well united to it, and firm in texture, and supported upon a foot of the formation recommended under that head.

The colours commonly met with among high-bred greyhounds are black, blue, red, fawn, brindled, and white, variously mixed. There are also sometimes seen cream, yellow, brown, dun, and grey dogs. When a plain colour is speckled with small white marks, the dog is said to be ticked. The black, red, and fawn are the most highly prized by most coursers, especially when the last two have black muzzles. Some people are partial to blue dogs, of which several good specimens have been met with, as may also be said of the brindled colour, but, as before remarked, the general opinion is in favour of black, red, and fawn. I believe that black, red, and white may be considered as the primary colours, and that the others arise out of their mixture in breeding. Thus a black dog and a white bitch will produce either blacks, whites, black and whites, blues, or greys; while a red dog and white bitch will have red, white, fawn, red and white, yellow, or cream puppies. Black and red united together make the red with black muzzle or the black brindle, while the blue and fawn give rise to the blue brindle; or sometimes we see the black or blue-tanned colour, as we meet with commonly enough in the setter, spaniel, and terrier. Mr. Thacker was of opinion, with some of the early writers on the greyhound, that the brindle was a mark of the descent from the

bulldog ; but, as nothing is known of the time when the colour first appeared, no reliance can be placed on the hypothesis.

The texture of the COAT is the last point upon which any reliance is placed, but, as far as my experience goes, there is little to be gained from it. Nevertheless, I should always discard a very soft woolly coat as being an evidence of a weak constitution, unable to bear exposure to weather, and, on that account, unfit for the purposes of the courser. The old breeds were, many of them, very bald about the cheeks and thighs, and this used to be considered a mark of good blood ; but, since the intermixture of the rough greyhound, most of our best sorts have been free from this peculiarity, and many of them have had hard rough coats, quite unlike the fine and thin hair, which was formerly so highly prized. My own impression is in favour of a firm, glossy, and somewhat greasy-feeling, coarse coat, which stands wetting well, and at the same time looks healthy and handsome to the eye.

VARIOUS DISTINCT BREEDS OR STRAINS have long been known as the Newmarket, Wiltshire, Lancashire, Yorkshire, and smooth Scotch greyhounds ; but these are now so completely amalgamated that it is useless to attempt a description of them. Twenty years ago, the Newmarket dog was a distinct animal from that used in Wiltshire, but it would be wholly impossible in the present day to find a single specimen of either uncrossed with the blood of some other variety. If, however, any of my readers wish, from motives of curiosity, for a definite description of these strains, it may be found in "The Greyhound," where they are all described most minutely. Public coursing has now reached such a pitch, that

those who indulge in it take care to select the best blood which is to be obtained, and readily send two or three hundred miles for it. Hence, locality has now little to do with it, and throughout Great Britain and Ireland the public greyhound is the same animal. Newmarket, which used to be the grand centre of the coursing world, is now fallen from its high position, and neither produces first-class dogs, nor coursing meetings of a corresponding character. Scotland, on the other hand, which formerly had its own breed of smooth greyhounds, has lately taken up the mantle fallen from the shoulders of Newmarket, and has not only usurped her breed of dogs, but has established most numerous supported meetings in various localities. Almost all her modern strains are thence descended, but some are also dependent upon old Lancashire blood, as, for example, Mr. Borron's "Bluelight" strain, and Mr. Wilson's "King Lear." It is true that there is an infusion of old Scotch blood in nearly all of these dogs, but that of the south and midland district greatly preponderates; as, for instance, Mr. Gibson's "Sam," "Jacobite," and "Caledonian;" Mr. Wilson's "King Lear," and sisters; the various descendants of "Japhet," "Baron," and "Hughie Graham," as well as of Sir James Boswell's "Jason," and Mr. Sharpe's "Monarch;" all of southern descent. Lancashire has still some strains peculiar to herself, which have suffered no intermixture for many years, and the same may be said of the Yorkshire blood; but these are exceptions to the general rule, for nine-tenths of the greyhounds in these districts are now crossed with Scotch or Newmarket blood, through "King Cob," or "Jason," or some of their descendants. Indeed, it is now extremely rare to meet with any

first-class breed of greyhounds which has not the name of one or other of these dogs in their pedigrees ; and, as in former years it was thought necessary to trace every dog if possible up to "Snowball," so now, if it can be asserted that a favourite is descended from "King Cob," it is considered that a good claim to high breeding has been made out.

In the CHOICE OF A GREYHOUND I have already observed that we must be guided by other considerations besides make and shape, depending greatly upon the precise object which the intending possessor has in view, since, although the high-bred and low-bred greyhounds are alike externally, yet there is in their internal structure some difference beyond the ken of our senses. But, as it is found by experience that in this particular "like produces like," it is only necessary to be assured that the parents possessed this internal formation, whatever it may be, in order to be satisfied that their descendants will inherit it. Thus we arrive at the necessity for "good breed," or "pure blood," as the same thing is called in different language, both merely meaning that the ancestors, for some generations, have been remarkable for the possession of the qualities most desired, whatever they may be. Hence, in selecting greyhounds to breed from, the pedigree for many generations is scrutinised with great care, and if there is a single flaw it is looked at with suspicion, because the bad is almost sure to peep out through any amount of good blood.

The modes of breeding, managing, breaking, and using the greyhound are entered into in the next part.



## THE GAZEHOUND.

This breed is now lost, and it is very difficult to ascertain in what respects it differed from the greyhound. Bewick describes it minutely, but he does not appear to have any authority for what he writes on this particular.

---

## THE IRISH GREYHOUND, OR WOLF-DOG.

This fine animal is now, I believe, extinct, though there are still some gentlemen who maintain that they possess the breed in all its pristine purity of blood. They are much larger than the deerhound; some of them being 35 or even 38 inches high, but resembling that dog in shape, being generally of a fawn colour, with a rough coat, and pendent ears. They were formerly used for the purpose of hunting the wolf.

## THE MÂTIN.

The French mâtin is not a very distinct dog, comprehending an immense variety of animals, which in England would be called lurchers, or sheep dogs, according to the uses to which they are put. The head has the elongated form of this division of the dog, with a flat forehead; the ears stand up, but are pendulous towards the tip, and the colour varies from red to fawn. He is about 24 inches high, has strong muscular action, and is very courageous,

being employed in hunting the wild boar and wolf. This dog is said, by F. Cuvier, to be the progenitor of the greyhound and deerhound; but Pennant, on the contrary, considers him to be descended from the Irish wolf-dog.



The Hare-Indian Dog. (Youatt.)

#### THE HARE-INDIAN DOG.

The specimen belonging to the Zoological Society, from which the above cut was taken, is now dead, and, I believe, there is no longer one of the variety in England. At one time there were three in the gardens of the Society, but for want of exercise none of the dogs throve there, and they now are entirely absent from the

otherwise rich and valuable collection. The general shape of the body would induce us to class this dog with the spaniels or pastoral dogs, but the shape of the head being allowed to be the best guide, it must take the place which is here given it, inasmuch as it has all the characteristics of the first division. The Hare-Indian dog inhabits the country watered by the Mackenzie River and the Great Bear Lake of America, where it is used to hunt the moose and reindeer *by sight*, aided occasionally by its powers of scent, which are by no means contemptible, but kept in abeyance by disuse. The feet are remarkable for spreading on the snow, so as to prevent them from sinking into it, and to enable the dog to bound lightly over a surface which the moose sinks into at every stride. The height is about 25 inches, combined with great strength. The ears are broad at the base, and pointed towards the tips, being perfectly erect. The tail is thick, bushy, and slightly curved, but not so much so as in the Esquimaux dog. The hair is long and straight; the ground colour being white, marked with large irregular patches of greyish black, shaded with brown.

---

#### THE ALBANIAN DOG.

The Albanian dog is said to stand about 27 or 28 inches high, with a long pointed muzzle, powerful body, strong and muscular limbs, and a long bushy tail, carried like that of the Newfoundland dog. His hair is very fine and close, being of

a silky texture, and of a fawn colour, variously clouded with brown. He is used for hunting the wild boar and wolf, as well as for the purpose of guarding the sheep-fold from the latter; but the accounts of this dog vary greatly, and are not much to be relied on.



The Grecian Greyhound. (Youatt.)

#### THE GRECIAN GREYHOUND.

This elegant animal is somewhat smaller than the English dog, and the hair is longer and slightly wavy, the tail also being clothed

with a thin brush of hair. This is supposed to be the same breed as the greyhound of Xenophon, the Athenian.

---

#### THE RUSSIAN GREYHOUND.

This variety of the greyhound hunts well by scent, and, being at the same time fast and stout, he is used for the destruction of the wolves and bears which inhabit the Russian forests, and also for coursing the deer and the hare. For this latter sport he is well adapted ; but, being somewhat deficient in courage and strength, he is hardly a match for the wolf and bear, excepting in packs.

The Russian greyhound is about 26 or 27 inches high, with short pricked ears, turned over at the tips ; he is rather thin and weak in the back and loins, and long on the leg. The coat is thick, but not long, excepting the hair of the tail, which is fanlike, with a spiral twist of a peculiar form. The colour is dark brown or grey. I am not aware of any undoubted specimen of this breed having been imported into this country, nor of a correct portrait having been painted ; so my readers must depend upon description alone.

---

### THE TURKISH GREYHOUND.

A small and almost hairless dog, of the greyhound kind, is met with in Turkey, but it is not common in that country, and I have never seen a specimen or even a good portrait of it.

---

### THE PERSIAN GREYHOUND

Is an elegant animal, beautifully formed in all points, and resembling the Italian in delicacy of proportions. In Persia he is used for coursing the hare and antelope, as well as sometimes the wild ass. When the antelope is the object of the chase, relays of greyhounds are stationed where the game is likely to resort to, and slipped each in their turn as the antelope passes.

The Persian greyhound is about 24 inches high. The ears are pendulous like those of the Grecian dog, and hairy like those of the English setter, but in other respects he resembles the English smooth greyhound, with the exception of the tail, which may be compared to that of a silky-coated setter. Several portraits of this dog have appeared at various times in the "Sporting Magazine," and elsewhere, but I am told they do not well represent his appearance.

---



Italian Greyhounds, "BILLY" and "MINNIE."

#### THE ITALIAN GREYHOUND.

This little dog is one of the most beautifully proportioned animals in creation, being a smooth English greyhound in miniature, and resembling it in all respects but size. It is bred in Spain and Italy in great perfection, the warmth of the climate agreeing well with its habits and constitution. In England, as in its native country, it is only used as a pet or toy dog, for though its speed is considerable for its size, it is incapable of holding even a rabbit.

\* See p. 46.

The attempt, therefore, to course rabbits with this little dog has always failed, and in those instances where the sport (if such it can be called) has been carried out at all, recourse has been had to a cross between the Italian greyhound and the terrier, which results in a strong, quick, little dog, quite capable of doing all that is required.

The chief points characteristic of the Italian greyhound are shape, colour, and size.

In *shape* he should as nearly as possible resemble the English greyhound, as described at page 28 *et seq.* The nose is not usually so long in proportion, and the head is fuller both in width and depth. The eyes, also, are somewhat larger, being soft and full. The tail should be small in bone, and free from hair. It is scarcely so long as that of the English greyhound, bearing in mind the difference of size. It usually bends with a gentle sweep upwards, but should never turn round in a corkscrew form.

The *colour* most prized is a golden fawn. The dove-coloured fawn comes next. Then the cream colour, and the blue fawn, or fawn with blue muzzle, the black-muzzled fawn, the black-muzzled red, the plain red, the yellow, the cream-coloured, and the black; the white, the blue, the white and fawn, and the white and red. Whenever the dog is of a whole colour, there should be no white whatever on the toes, legs, or tail; and even a star on the breast is considered a defect, though not so great as on the feet.

The *size* most prized is when the specified weight is about six or eight pounds; but dogs of this weight have seldom perfect symmetry, and one with good shape and colour of eight pounds is to







The Southern Hound. (Youatt.)

### CHAPTER III.

DOMESTICATED DOGS, HUNTING CHIEFLY BY THE NOSE, AND BOTH FINDING AND KILLING THEIR GAME; COMMONLY KNOWN AS HOUNDS.

The Southern Hound.—The Bloodhound.—The Staghound.—The Foxhound.—The Harrier.—The Beagle.—The Otterhound.—The Terrier.—The Dachshund.

THE SOUTHERN HOUND, NORTHERN HOUND, AND TALBOT.

THERE appears to be some difficulty in getting any reliable account of the original stock from which our modern hounds are descended.

inasmuch as the portraits of the old Talbots, southern hounds, northern hounds, bloodhounds, &c., which exist in various localities, do not bear any strong evidence of resembling the animals from which they were painted. One thing, however, is clear, namely, that one or more breeds of hound existed in former years which were heavier and slower than any we now possess, their ears also being longer, and their noses said to be more tender. The last point is one upon which much difference of opinion may be entertained, as it is almost impossible to compare one with the other; but in regard to their weight and want of pace, little doubt can be felt as to their differing from our modern hounds. But it was not only in shape and want of pace that these hounds were different from ours, but in their dwelling on a scent, as if enjoying the pleasure of inhaling the perfume, which no doubt is felt by the dog. These hounds would absolutely sit down and throw their tongues in the most melodious tone for half a minute when they met with any peculiarly strong scent, and then go off again till they came to another similar full stop, upon which the same occurred again; and, as a natural result, the frequent stoppages, added to the absolute deficiency of speed, made the dog wholly incapable of running down any animal which has a safe retreat like the fox, although he might in his "slow and sure" way overcome those which have none, such as the hare and the deer. Various writers describe the southern hound and northern hound as different dogs, the former being met with in the South of England and Wales, and more particularly in Devonshire, while the latter was confined to

the north. Both, however, were large, bony hounds, with long falling ears, but the southern hounds had absolute dewlaps, or at all events such excessive throatiness as to make them rejected in the present day on that account alone. The portrait at the head of this article does not represent this peculiarity sufficiently, and the dog there drawn would pass muster in this point among modern foxhounds. In other respects he is, I believe, a faithful copy of the southern hound, and shows the bony limbs, great strength and height, as well as the length of ear and heaviness of head so remarkable in them. Markham, who lived three hundred years ago, in comparing the two kinds of hound, describes the northern as having "a head more slender, with a longer nose, ears and flews more shallow, back broad, belly gaunt, joints long, tail small, and his general form more slender and greyhound-like; but the virtues of these Yorkshire hounds I can praise no farther than for scent and swiftness, for with respect to mouth, they have only a little shrill sweetness, but no depth of tone or music." The Talbot has been described in different terms by various authors, and his likeness delineated in changing forms, but there is no doubt that he was a heavier hound than the northern, though not perhaps quite up to the solemn and slow dignity of the southern hound, being very much like the bloodhound, except in colour, which was generally pied. In the nineteenth century, when pace is considered an essential to hunting, these three hounds are discarded in favour of either the staghound, foxhound, harrier, or beagle, all of which are now bred as fast as possible consistently with the possession of a good nose. The music of the pack is also

much neglected, and most men now-a-days prefer even that of "the squeaking bitches" if they give a good gallop, to the full-toned and bell-like tongues, one below the other, which were formerly considered to be a part of the sport, and without which a full cry was not listened to with pleasure. All this is of course a matter of taste, as it is manifest that the bitches with their shrill tongues can hunt as well as the dogs, and not having a musical ear myself, I cannot enter into the feelings of those who have.

There are still several small packs of these heavy slow hounds kept in the sequestered villages of Devon, Yorkshire, Sussex, and South Wales, but it is very doubtful how far they represent any one of the three above-named old breeds. It is wholly as a matter of curiosity and antiquarian lore that any reference is made to them.

---



Head of the Bloodhound. (Youatt.)

## THE BLOODHOUND.

The name given to this hound is founded upon his peculiar power of scenting the blood of a wounded animal, so that, if once put on his trail, he could hunt him through any number of his fellows, and would thus single out a wounded deer from a large herd, and stick to him through any foils or artifices which he may have recourse to. From this property he has also been used to trace human beings, and as his nose is remarkably delicate in hunting,

even without blood, he has always been selected for that purpose, whether the objects of pursuit were slaves, as in Cuba and America, or sheep-stealers, as in England.

At present there are, as far as I know, no true bloodhounds in this country for this purpose, or indeed for any other, as I believe the breed to be extinct; but several gentlemen possess hounds commonly called bloodhounds, though only partially resembling the veritable animal, and use them for hunting fallow-deer, especially those which are only wounded with the rifle, and not killed outright. This dog is also kept for his fine noble appearance, and as his temper is generally less uncertain than the genuine old bloodhound, and his taste for blood not so great, though still sometimes beyond all control, he is not unfitted to be the constant companion of man, but must always be regarded with some degree of suspicion.

Mr. Grantley Berkeley has long been celebrated for his breed of bloodhounds, and the performances of his dog "Druid" have been before the public so often as not to require recapitulation here. According to his authority the following are the distinctive marks, which should make their appearance even when the dog has one only of his parents thorough-bred:—Height from 24 to 25 or even 26 inches: peculiarly long and narrow forehead; ears from 8 to 9, and even 10, inches long; lips loose and hanging; throat also loose, and roomy in the skin; deep in the brisket, round in the ribs, loins broad and muscular, legs and feet straight and good, muscular thighs, and fine tapering and gracefully waving stern; colour black-tan, or deep and reddish

fawn (no white should be shown but on just the tip of the stern); the tongue loud, long, deep, and melodious; and the temper courageous and irascible, but remarkably forgiving, and immensely susceptible of kindness. Nevertheless, we have reason to believe that Mr. Berkeley, on more than one occasion, has had to run from "Druid" when his blood was up. (See *Frontispiece* for portrait of "Druid.")

According to Mr. Apperley, the Duke of Bedford possessed some fine specimens of the modern bloodhound fifteen years ago, and the Lords Yarborough and Fitzwilliam were also famous; the latter nobleman's "Bellman" being as well known for stud purposes as Mr. Osbaldiston's "Furrier" among foxhounds. He observes, with great probability of correctness, that the bloodhound is identical with the old southern harehound, now almost extinct in England, both being remarkable for adhering to the scent of the animal on which they are first laid. Mr. Jennings of London also possesses a fine breed of the bloodhound.

---

#### THE STAGHOUND.

The old English true staghound, which is now nearly if not quite extinct, resembles the bloodhound, but has a lighter cross, probably with the greyhound, and therefore somewhat approaches to the modern lurcher in formation of body, with the head of a southern hound. I believe there were till very lately some of these, nearly thorough-bred, in the pack of the Devon and Somerset staghounds.



but even they were more or less crossed with the foxhound. Like the bloodhound and old southern hound, this dog has the peculiarity of keeping to the hunted deer, which is not the case with the fashionable staghound of the day. There is some difficulty, however, in getting at a true description of the old staghound, and as it can only be valuable to the antiquarian, I shall not attempt anything further.

The staghound at present used in Her Majesty's and Baron Rothschild's kennels is merely a larger, and therefore faster, draft of the foxhound of the day. The dogs are about 24 or 25 inches high, and the bitches 22 to 23. They have broad short heads, straight hind legs, well-furnished thighs, full ears, which are not required to be rounded so much as the foxhound's, inasmuch as they do nothing in covert, and sterns feathered like the ordinary foxhound. The endurance of the staghound is very considerable, though from his extra size and weight he cannot compete in this respect with the foxhound of 23 inches; but as he is not required to hunt a second fox, and has not often more than a few miles of road work in going to the meet, he is not wanted to be so capable of long-continued exertion. Even in Somersetshire, where wild red deer are hunted, the staghound is not employed to "unharbour" them, and slow hounds which are nearly pure bloodhounds are used for the purpose.

It is unnecessary, therefore, to describe this hound more minutely, as, by reference to the foxhound, his shape, colour, &c., will be easily ascertained, and the size is given above.

---

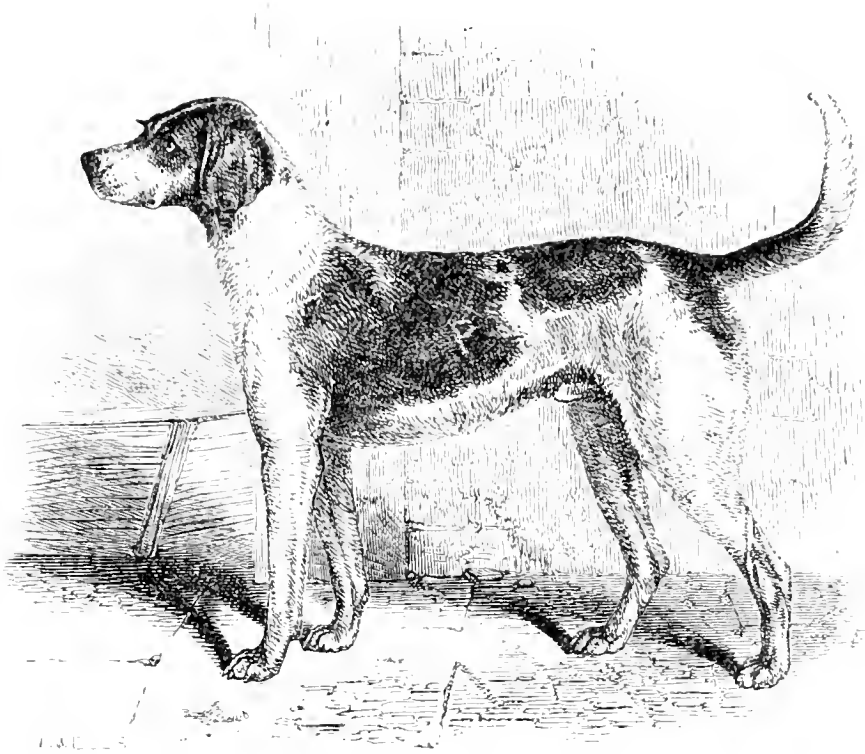

“HERMIT,” a highbred modern foxhound.\*

### THE FOXHOUND.

The modern foxhound is one of the most wonderful animals in creation, which is probably owing to the great pains that have been bestowed upon him for the last two or three centuries. Numerous instances have occurred where eight or ten thousand a year have been spent for a long time together upon a fox-hunting establishment, and therefore, when this outlay has been united

\* Bred by J. J. Farquharson, Esq., by Lord Fitzhardinge's "Hermit," out of the Puckeridge "Venus."

with the great judgment which has been displayed in the most celebrated kennels of the present century, it can scarcely occasion surprise that the combination has resulted in the most complete success. In breeding cattle and sheep one man has in more than one instance, during his single life, effected a complete revolution in the animal he was engaged in improving; and therefore, when a number of gentlemen combine for one purpose, and spare neither time, money, nor trouble, we ought to expect the fulfilment of their wishes. In no department of rural sports has so much been written as on fox-hunting, and this not only of late years, but for the last three centuries, during which Markham, Somerville, and Beckford may be instanced as examples of truthful as well as clever writing on the subject. Beckford, who wrote in the latter part of the last century, his first letter being dated 1779, is, however, the father of the modern school, and, with slight exceptions, the hound described by him is still that selected by our best masters, though perhaps they carry out his principles to a greater extent than he ever expected they would go. Much has been written, it is true, since his time, but I am not aware that any one has deviated from his description without doing wrong, and therefore, as I like to give credit where credit is due, I shall extract his description entire, as contained in his third letter to his friend.

“ You desire to know what kind of hound I would recommend. As you mention not for any particular chase or country, I understand you generally; and shall answer that I most approve of hounds of the middle size. I believe all animals of that description are strongest, and best able to endure fatigue. In the height as

well as the colour of hounds most sportsmen have their prejudices ; but in their shape, at least, I think they must all agree. I know sportsmen who boldly affirm that a small hound will oftentimes beat a large one ; that he will climb hills better, and go through cover quicker ; whilst others are not less ready to assert that a large hound will make his way in any country, will get better through the dirt than a small one, and that no fence, however high, can stop him. You have now their opinions : and I advise you to adopt that which suits your country best. There is, however, a certain size best adapted for business, which I take to be that between the two extremes, and I will venture to say that such hounds will not suffer themselves to be disgraced in any country. Somerville I find is of the same opinion :

‘ But here a mean  
 Observe, nor the large hound prefer, of size  
 Gigantie : he, in the thiek-woven covert,  
 Painfully tugs, or in the thorny brake,  
 Torn and embarrass’d, bleeds : but, if too small,  
 The pigmy brood in every furrow swims ;  
 Moil’d in the clogging elay, panting, they lag  
 Behind inglorious ; or else shivering creep,  
 Benumb’d and faint, beneath the sheltering thorn.  
 Foxhounds of middle size, active and strong,  
 Will better answer all thy various ends,  
 And crown thy pleasing labours with success.’

I perfectly agree with you that to look well they should be all nearly of a size ; and I even think that they should all look of the same family,

‘Facies non omnibus una,  
Nec diversa tamen, qualem decet esse sororum.’

“ If handsome without they are then perfect. With regard to their being sizeable, what Somerville says is so much in your own way that I shall send it you :

‘ As some brave captain, curious and exact,  
By his fix’d standard, forms in equal ranks  
His gay battalion : as one man they move,  
Step after step ; their size the same, their arms,  
Far gleaming, dart the same united blaze ;  
Reviewing generals his merit own ;  
How regular ! how just ! And all his cares  
Are well repaid if mighty GEORGE approve :  
So model thou thy pack, if honour touch  
Thy gen’rous soul, and the world’s just applause.’

“ There are necessary *points* in the shape of a hound which ought always to be attended to by a sportsman, for if he be not of a perfect symmetry he will neither run fast nor bear much work. He has much to undergo, and should have strength proportioned to it. *Let his legs be straight as arrows, his feet round and not too large ; his shoulders back ; his breast rather wide than narrow ; his chest deep ; his back broad ; his head small ; his neck thin ; his tail thick and brushy, if he carry it well so much the better.* Such hounds as *are out at the elbows*, and such as are *weak from the knees to the foot*, should never be taken into the pack.

“ I find that I have mentioned a small head as one of the neces-

sary requisites of a hound; but you will understand that it is relative *to beauty only*, for as to *goodness*, I believe, large-headed hounds are in no wise inferior. The colour I think of little moment, and am of opinion with our friend Foote, respecting his negro friend, that a good dog, like a good candidate, cannot be of a bad colour.

“Men are too apt to be prejudiced by the sort of hound which they themselves have been most accustomed to. Those who have been used to the sharp-nosed foxhound, will hardly allow a large-headed hound to be a foxhound; yet they both equally are; speed and beauty are the chief excellencies of the one, while stoutness and tenderness of nose in hunting are characteristic of the other. I could tell you that I have seen very good sport with very unhandsome packs, consisting of hounds of various sizes, differing from one another as much in shape and look as in their colour; nor could there be traced the least sign of consanguinity amongst them. Considered separately the hounds were good; as a pack of hounds they were not to be commended; nor would you be satisfied with anything that looked so very incomplete. You will find nothing so essential to your sport as that your hounds should run well together; nor can this end be better attained than by confining yourself, as near as you can, to those of the same sort, size, and shape.”

Thus then, as to *points*, it will be evident from the above extract that Beekford was fully aware of all which are considered essential to the foxhound, except the depth of the back ribs, in which the modern hound differs from both of his supposed progenitors (the

greyhound and old-fashioned hound), and which has been established by carefully breeding from sires and dams peculiar for this development. It is upon this formation that stoutness, and the capability of bearing work day after day, mainly depend; and hence all good judges both of the hunter and the hound insist so strongly upon it. Nimrod (Apperley) also remarks that Beckford has omitted to particularise "the length of thigh discernible in first-rate hounds, which, like the well-let-down hock of the horse, gives them much superiority of speed, and is also a great security against laming themselves in leaping fences, which they are more apt to do when they become blown and consequently weak." It may also be remarked, that though Beckford insists upon a middle size, he does not define what he means by the term, but as foxhounds vary from 26 inches to 20, I should say 23 to 25 inches for doghounds, and 21 to 23 for bitches, would be about the height meant by him. In open countries, with thin fences or walls, a large hound may perhaps suit best; but in woodlands, the small size, if not too small and delicate, has many advantages, and will always beat the larger and heavier hound, who tires himself in driving through the runs, which will readily admit the small dog or bitch. Nimrod fixed the height at "21 to 22 inches for bitches, and 23 to 24 for doghounds;" but I have given a little more latitude in the above estimate. The *speed* of the foxhound may be estimated from the well-known match over the Beacon course, at Newmarket, which is 4 miles 1 furlong and 132 yards, and which was run by Mr. Barry's "Bluecap" (the winner) in eight minutes and a few seconds, Mr. Meynell's

hounds being not far behind; and only twelve out of sixty horsemen who started with them being with them to the end. Colonel Thornton's bitch, "Merkin," is even said to have run the same course in seven minutes and half a second. This speed is accounted for by the greyhound descent, if it really exists; and that it does so I have little doubt, as it is quite clear that the old hound was deficient in those points which the greyhound alone would be able to give; but as this is only conjecture I have not insisted upon it.

The *small rounded ear* of the foxhound is due to the rounding irons of the huntsman, who removes a large portion of the pup's ears in order to save them from the tears and scratches which they would inevitably encounter in "drawing," if allowed to remain on. The portion left is sufficient to protect the passage to the internal organ, but for which necessity it would be better to crop them closely, as is practised with dogs intended for fighting; just as the wrestler and the pugilist have their hair cropt as close to their heads as possible.

The *prevailing colours* of foxhounds in the present day are as follows, placing them in the order of their frequency:—(1.) Black and white with tan; (2.) The mixed or blended colours, known as "pies," as red pie, blue pie, yellow pie, grey pie, lemon pie, hare pie, and badger pie, the last three very handsome; (3.) Tan; (4.) Black; (5.) White; (6.) Red; (7.) Blue; each being more or less mixed with white. Foxhounds are often slightly ticked, but rarely mottled, the "blue mottled hound," according to Mr. Apperley, being a true harrier or beagle, and most probably



descended from the southern hound, which was often of this colour.

It must be remembered that the foxhound is always to be looked at as *part of a pack*, and hence it is of no use to breed an exceptionally high or otherwise well made hound if it will make him run in a different style to his companions. Hence it is necessary to keep to such a model as can be produced in number sufficient to form the pack, which is another argument in favour of a medium size; and hence, in looking at a pack, together or separately, the lover of the foxhound is always on the look-out for "suitiness," or the resemblance to another in size and shape, which Beckford alludes to in describing a good-looking pack of hounds as appearing "all of one family."

In his *work* the foxhound is peculiar for dash, and for always being inclined to cast forwards, instinctively appearing to be aware that the fox makes his point to some covert different from that in which he was found. On the other hand, the harrier casts back, from a knowledge, instinctive or acquired, that the hare has a tendency to return to the place from which she started, and will be almost sure to do so if she has time enough given her.

---

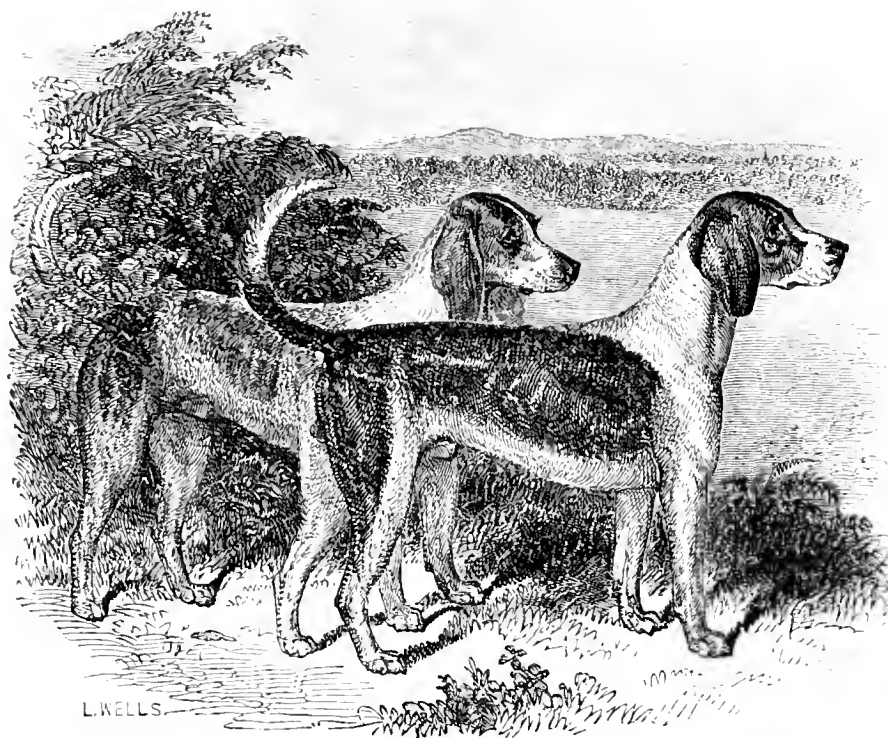

“GRASPER,”\* a Harrier, and “TRUEMAN,”† a Foxhound-Harrier.

### THE HARRIER.

The true harrier is a dwarf southern hound, with a very slight infusion of the greyhound in him. Hence he is more throaty than the foxhound, and has also more ear, with a broader head, more

\* “Grasper” by “Solomon,” out of “Governess,” from the late Mr. Furze’s harrier pack in Devonshire. “Solomon” by Prince Albert’s “Solomon.”

† “Trueman” by Mr. Lisle Phillipps’ harrier “Roman,” out of “Damsel.” “Damsel,” a pure foxhound bitch, only 18 inches high, from the late Sir Richard Sutton’s kennel, and of the famous “Trueman” blood, was by his “Dexter.”

fully developed flews, and altogether a heavier and less active frame. The height is usually at present under 20 inches, averaging about 18; but in the old times, when the dwarf foxhound was never used for the purpose, harriers were often 22 and sometimes 23 inches high, because even with that size they dwelt on the scent so long that they were not too fast for sport. But it is in tongue and in style of hunting that true harriers are chiefly remarkable, the former being melodious in the extreme, and a pack in full cry being heard for miles; while the latter is distinguished by excessive delicacy of nose, and by an amount of patience in working out the doubles of the hare which the old-fashioned hare-hunter considered perfection. Mr. Yeatman has, however, introduced a different style, and according to his system the hare is driven so fast that she is compelled to abandon her cunning devices, and to trust to her speed alone. But as, following his example, most of the modern packs of harehounds are dwarf foxhounds, it is unnecessary to dwell upon the old-fashioned animal, and the modern harrier may therefore be described as a foxhound in shape, but of a size averaging about 18 or 19 inches, and kept to hare with great care, so that in some instances packs are known to refuse to own the scent of the fox; but these are rare exceptions, as most huntsmen will be ready to hunt one whenever they have the opportunity, and many regularly finish their season by shaking down a bag-fox, or by trying for one in some covert where they have permission. The fashion of the day is to demand *pace* in all kinds of hunting, and for this reason these dwarf foxhounds are

selected, taking care to unite with it as fine and delicate a nose as possible, but altogether regardless of the music, which used to be a *sine qua non* with masters of harriers.

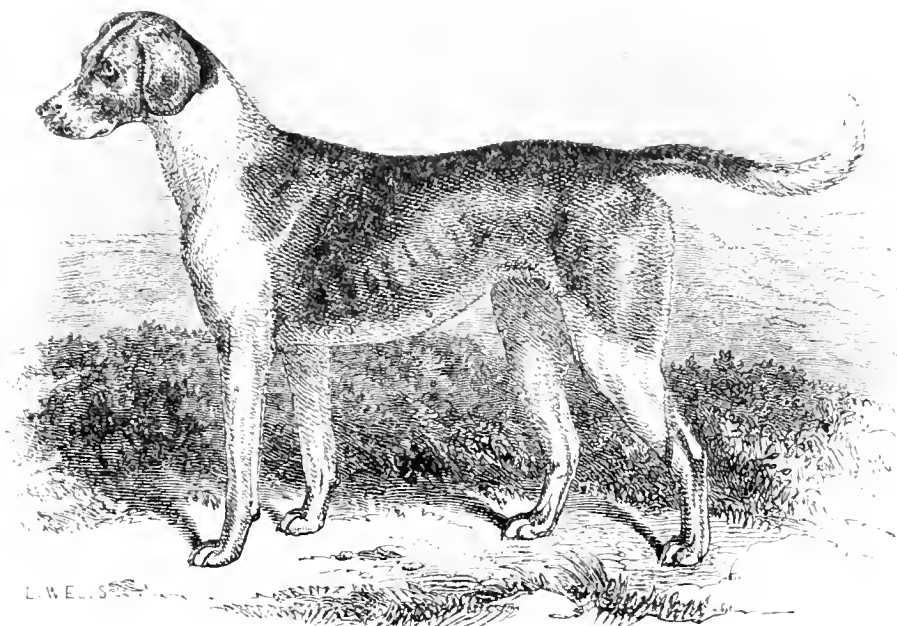

“DAHLIA,” a pure Foxhound.\*

Among the packs of pure foxhounds which are devoted to hunting the hare, Mr. Yeatman’s has long been celebrated in the west of England. His hounds possess very fine noses, combined with great pace; and while they drive their hares to abandon their natural doubles, they are able to hunt a cold scent in a marvellously clever manner.

One chief beauty in hare-hunting is the proper packing of the

\* “Dahlia” is by the Duke of Rutland’s “Driver,” out of the Bramhammoor “Dulcet.” She is 21 inches in height.

hounds, and as this cannot be done without having all nearly of the same size, shape, and breed, masters of harriers are very particular in keeping the whole of their kennel of one strain; and when they cross their hounds it should be with great care, so as to avoid the introduction of blood very different to that which they already possess.

For the *points* of the modern harrier the reader is referred to the description of the foxhound, with the modifications in height, &c., alluded to at page 64. To the *colours* detailed at page 61, may be added the "blue mottle," which is often seen in hounds of part harrier blood, marking their descent from the southern hound. The *ears* are either not rounded, or only slightly so. For the *points* of the old-fashioned harrier, see the southern hound at page 47. The Welsh harrier is a rough southern hound, being the same breed as that described in this book as the otterhound at page 70.

---

#### THE BEAGLE.

The true beagle, like the old harrier, is now almost entirely displaced by dwarf specimens of the foxhound, or by crosses with it in varying proportions. Still there are some packs left, and a good many gentlemen also possess one or two couple which they use for covert shooting, though even here this breed is giving way to the spaniel.

In *external form* the beagle resembles the southern hound, but is much more compact and elegant in shape, and far less throaty in proportion to its size, though still possessing a considerable ruff. There are three or four varieties, however, which differ a good deal among themselves in shape and make, and also to some degree in style of hunting.

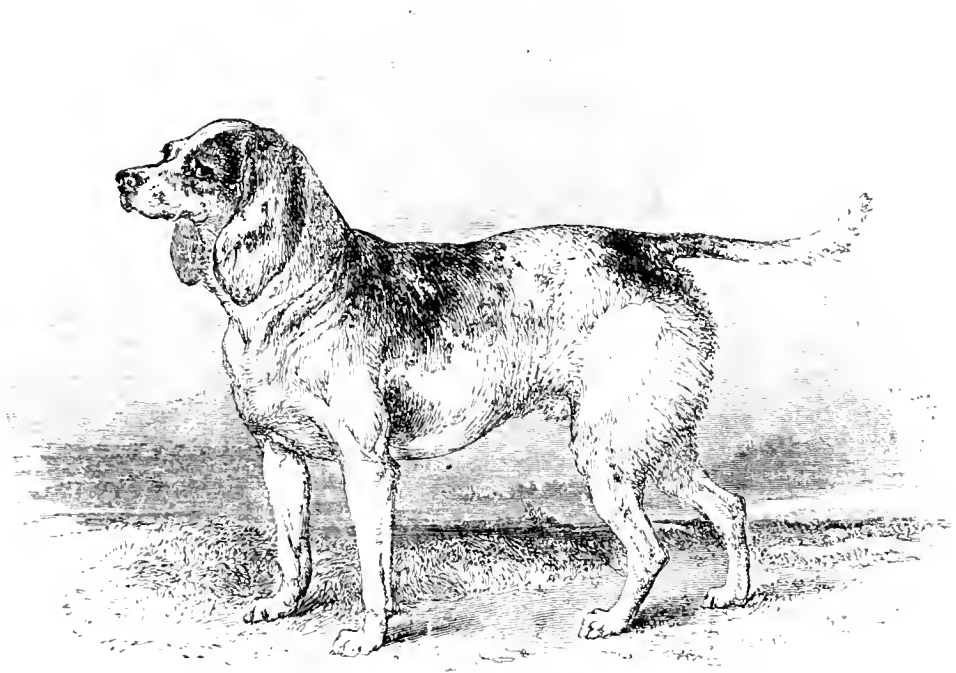

The medium-sized Beagle. (Youatt.)

The *medium-sized beagle* may be taken as the type of the others of the same name, and somewhat resembles a small old-fashioned harrier in shape, but with a larger body and shorter legs in proportion to it. The head is very wide and round, with a short square nose, very full and soft drooping ears, good feet, and not much hair on the body, but with a slight brush on the tail. Their tongues are most musical, and their noses extremely delicate, being

even more so than the harrier, but hunting in the same style, with the same tendency to dwell on the scent. In size they may be described as averaging about 12 or 14 inches. (See portrait.)

The *rough beagle* is apparently a cross between the above little hound and the rough terrier, though by many people he is supposed to be a distinct breed, and as much so as the Welsh harrier, which he resembles in all but size. His origin is, however, lost in obscurity, and can only be conjectured. One chief reason why I have supposed him to arise from the above cross is, that he has lost in great measure the beagle tongue, and squeaks like the terrier, though not quite so much as that dog. He has, however, the full ear of the smooth beagle, or nearly as great a development of that organ, but the nose is clothed with the stiff whisker of the rough terrier, and the body generally has the same rough and wiry hair. It is maintained by some people that he has obtained this from the deerhound through the southern hound, but his dwarf size renders it more probable that it is derived from the terrier, which breed, however, very probably is descended from the deerhound, as indeed I believe is the case with nearly all our hounds. The size of this beagle varies greatly, the average being perhaps about 14 inches.

The *dwarf* or *rabbit beagle* is a very small and delicate little hound, but with an excellent nose, and much faster than he looks. Some sportsmen have carried their predilection for small dogs to such an extent, as to use a pack of these beagles which might be carried about in the shooting pockets of the men; and in this way have confined their duties to the hunting alone, so that they were not tired in trailing along the road from the kennel to the hunting-

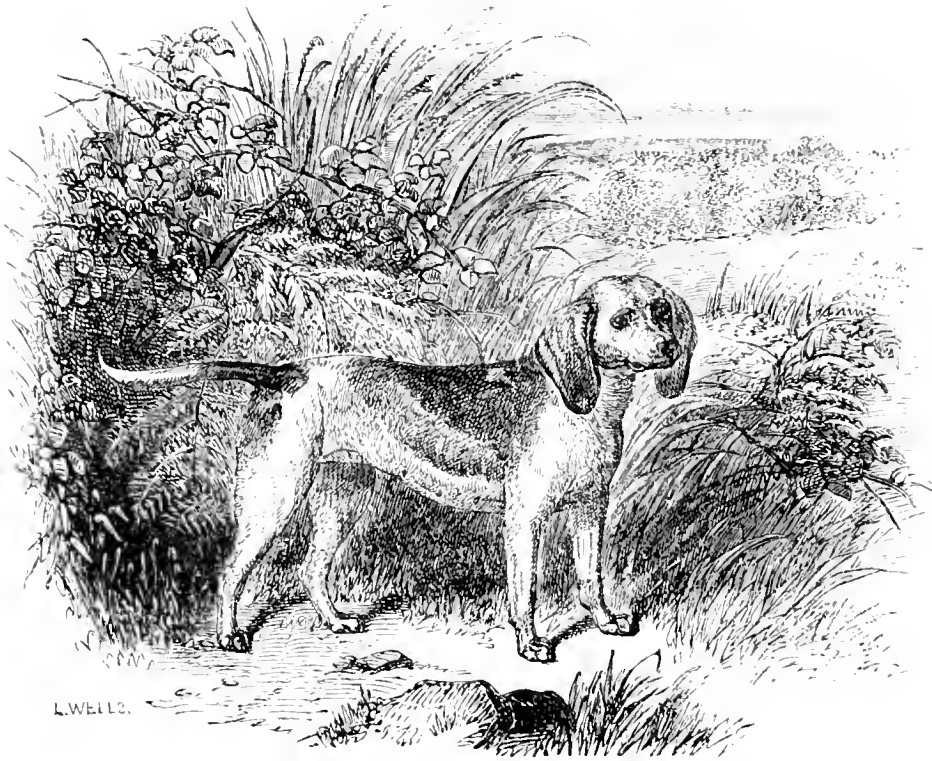

“BARMAID,” \* a Dwarf Beagle, bred by Lord Gifford.

field and back again. The average height of these may be taken at 10 inches, but their bodies are disproportionately lengthened. Patience and perseverance are still more necessary in these hounds than in their larger brethren, and without them they soon lose their hare, as they must be content to hunt her at a pace with which a man can readily keep up on foot, horses being quite out of place with such a diminutive pack.

\* This beautiful little bitch, presented to Mrs. Chapman of Cheltenham by Lord Gifford, is by Mr. Barker's “Ruler,” out of his “Bluebell.” Height, 12½ inches.



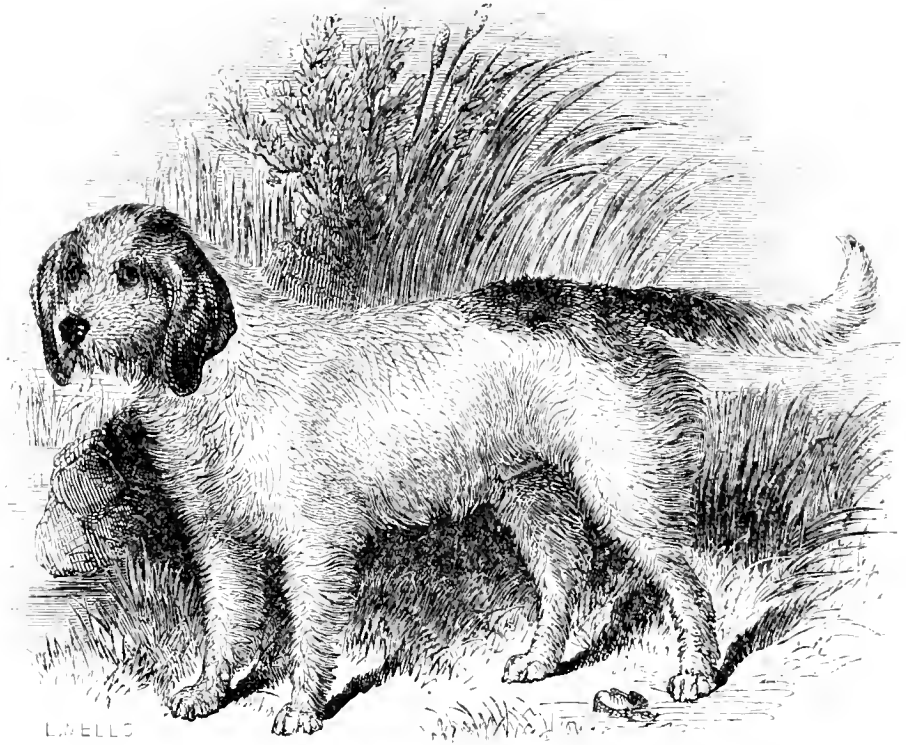

“BELLMAN,” an Otterhound; pedigree unknown.

### THE OTTERHOUND.

No hound which is now kept in Great Britain resembles the southern hound so much as this, the difference being only in the rough wiry coat, which has been obtained by careful breeding, to enable them to resist the ill effects of the rough weather which the breed have to encounter, whether in the chase of the hare, for which they were originally employed in Wales, or for that of the otter, to which they are now almost exclusively restricted. If, therefore, the reader turns to the description of the southern hound, and adds to it a rough wiry coat with a profusion of rough whisker, he will at once understand the form and nature of the otterhound, alias the

Welsh harrier. It is a moot point, whether this roughness is obtained by crossing, or whether it is attributable to careful selection only ; but I am inclined to think that as the full melodious note of the hound is retained, there is no cross of the terrier or of the deerhound, which two breeds divide between them the credit of bestowing their coats upon the otterhound. Anyhow it is a distinct breed in the present day ; and, with the shape I have described, it unites all the characteristics of the old southern hound, in dwelling on the scent, in delicacy of nose, and in want of dash. Whether the power of swimming has been obtained by any cross with the water-spaniel is also a disputed point, but as I do not believe in any peculiar swimming power inherent in that breed, I am not inclined to attribute that of the otterhound to a cross with it, especially as the foxhound swims equally well.

As these hounds have to compete with a very savage and hard-biting animal, they must of necessity be fearless and hardy ; and as for their specific purposes those which are not so have been rejected, it happens that the breed has become unusually savage, and that they are constantly fighting in kennel. Indeed, instances are common enough of more than half being destroyed in a single night, in the bloody fight which has been commenced by perhaps a single couple, but soon ending in a general scrimmage. No dog bites more savagely, and, unlike the bulldog, the hold is not firmly retained, but the teeth are torn out with great force the instant the hold is taken. The usual height of the otterhound is from 22 to 25 inches in the dogs, the bitches being somewhat lower.

## THE TERRIER.

The terrier as used for hunting is a strong useful little dog, with great endurance and courage, and with nearly as good a nose as the beagle or harrier. From his superior courage when crossed with the bulldog, as most vermin-terriers are, he has generally been kept for killing vermin whose bite would deter the spaniel or the beagle, but would only render the terrier more determined in his pursuit of them. Hence, he is the constant attendant on the rat-catcher, and is highly useful to the gamekeeper, as well as to the farmer who is annoyed with rats and mice. Formerly it was the custom to add a couple of terriers to every pack of foxhounds, so as to be ready to aid in bolting the fox when he runs into a drain, or goes to ground in any easily accessible earth; the stoutness of the terrier enabling him, by steadily following on the track, to reach the scene of operations before it would be possible to obtain any other assistance. This aid, however, in consequence of the increased speed of our hounds, is now dispensed with, and the old fox-terrier is out of date, or is only kept for the purpose of destroying ground vermin, such as the rat or the weasel, or as a companion to man, for which purpose his fidelity and tractability make him peculiarly fitted. Terriers are now usually divided into eight kinds:—1st, The old English terrier; 2nd, The Scotch; 3rd, The Dandie Dinmont; 4th, The Skye; 5th, The Fox Terrier; 6th, The Bedlington; 7th, The Halifax Blue Tan; and 8th, The Modern Toy Terriers of various kinds.

The *English Terrier* is a smooth-haired dog, weighing from about



"LADY," an English Terrier, the property of C. Morrison, Esq., of Walham Green.\*

6 to 10 lbs. His nose is very long and tapering neatly off, the jaw being slightly overhung, with a high forehead, narrow flat skull, strong muscular jaw, and small bright eye, well set in the head; ears when entire are short and slightly raised, but not absolutely pricked, turning over soon after they leave the head. When cropped they stand up in a point, and rise much higher than they naturally would. The neck is strong, but of a good length; body very symmetrical, with powerful short loins, and chest deep rather than wide. Shoulders generally good, and very powerful, so as to

\* "Lady" by Frank Redmond's celebrated dog "Tartar," out of "Vic," a Manchester-bred bitch, formerly the property of the Hon. Egremont Lascelles. Her weight is about  $6\frac{1}{2}$  lbs.

enable the terrier to dig away at an earth for hours together without fatigue, but they must not be so wide as to prevent him from "going to ground." Fore legs straight and strong in muscle, but light in bone, and feet round and hare-like. Hind legs straight but powerful. Tail fine, with a decided down carriage. The colour of these dogs should be black and tan, which is the only true colour: many are white, slightly marked with black, red, or sometimes, but very rarely, blue. The true fox-terrier was generally chosen with as much white as possible, so that he might be readily seen, either coming up after the pack, or when in the fox's earth, in almost complete darkness; but these were all crossed with the bulldog. Those which are now kept for general purposes are, however, most prized when of the black and tan colour, and the more complete the contrast, that is, the richer the black and tan respectively, the more highly the dog is valued, especially if without any white. In all cases there should be a small patch of tan over each eye; the nose and palate should always be black. The toes should be pencilled with black reaching more or less up the leg. Such is the pure English terrier, a totally different animal from the short, thick-muzzled, spaniel-eyed, long-backed, cat-footed, curly-tailed abomination so prevalent in the present day.

The *Scotch Terrier* closely resembles the English dog in all but his coat, which is wiry and rough, and hence he is sometimes called the wire-haired terrier, a name perhaps better suited to a dog which has long been naturalised in England, and whose origin is obscure enough. Beyond this difference in externals, there is little to be said distinctive of the one from the other, the



“PETO,” a Scotch Terrier.

colours being the same, but white being more highly prized in the southern variety, and the black and tan when more or less mixed with grey, so as to give the dog a pepper and salt appearance, being characteristic of the true Scotch terrier; but there are numberless varieties in size, and also in shape and colour. This is a very good vermin dog, and will hunt anything from a fox to a mouse; but while he may be induced to hunt feather, he never takes to it like fur, and prefers vermin to game at all times.

The *Dandie Dinmont* breed of terriers, now so much celebrated, was originally bred by a farmer of the name of James

Davidson, at Hindalee, in Roxburghshire, who, it is generally believed, got his dogs from the head of Coquet Water. There was also a good strain at Ned Dunn's at Whitelee, near the Carter Bar.

Those who have investigated the subject are inclined to think that the Dandie Dinmont is a cross between the Scotch terrier and the otterhound, or, as I believe, the Welsh harrier, which is identical with the latter.

The most celebrated strains are those belonging to the Duke of Buccleugh (presented by James Davidson); Stoddart, of Selkirk; Frain, of the Trows; McDougall, of Cessford; F. Sommers, of Kelso; Sir G. Douglass, of Springwood Park; Dr. Brown, of Melrose; J. Aitken, of Edinburgh; and Hugh Purves, of Leaderfoot, who is the principal hand in having kept up the breed. So much were the Dandies in vogue some years ago, that Mr. Bradshaw Smith, of Dumfriesshire, bought up every good dog he could lay his hands on, and as a consequence his breed is now well known.

The Dandie is represented by two colours of hair, which is sometimes rather hard, but not long; one entirely a reddish brown, and called the "mustard," the other grey or bluish grey on the back, and tan or light brown on the legs, and called the "pepper;" both have the silky hair on the forehead. The legs are short, the body long, shoulder low, back slightly curved, head large, jaws long and tapered to the muzzle, which is not sharp; ears large and hanging close to the head, eyes full, bright and intelligent, tail straight and carried erect, with a slight curve over the back



“ROUGH” and “PUCK,” Dandies.\*

(houndlike); the weight 18 to 24 lbs., varying according to the strain, but the original Dandie was a heavy dog. Occasionally in a litter there may be some with the short folding ear of a bull-terrier, and also with some greater length of the legs; these are not approved of by fanciers, but nevertheless are pure, showing a tendency to cast back. Sir W. Scott, I believe, preferred the small ear. The above description is taken from dogs bred from “Meadow,” † by Dr. Brown’s celebrated dog “John

\* Both from photographs. That of “Puck” showing only the upper part of the body, has necessitated the attitude in which he is drawn. See pages 78, 79.

† A Dandie Dinmont terrier bitch, named “Meadow,” bred at Birseslees.



Pym,"\* and "Puck,"† son of "John Pym." "Meadow" was bred at Birseslees. Sometimes a Dandie pup of a good strain may appear not to be game at an early age; but he should not be parted with on that account, because many of them do not show their courage till nearly two years old, and then nothing can beat them; this apparent softness arising, as I suspect, from kindness of heart.

The mustard-coloured bitch from which the above sketch was taken belongs to the breed referred to, as far as I can trace her pedigree, and answers to the description; but I have not been able to obtain positive proof of her entire purity of blood, the

Long Newton, Roxburgshire. Dam, "Schann;" sire, "Pepper;" was pupped early in December, 1844. "Pepper" and "Schann" are the property of Sir George H. S. Douglas, Baronet, of Springwood Park, Captain 34th Regiment of Infantry. "Schann" was bred at Bowhill, Selkirkshire; dam, his Grace the Duke of Buccleugh's "Schann;" sire, "Old Pepper," also the property of his Grace.

"Schann," at Bowhill, was bred by John Stoddart, at Selkirk. Dam, "Schann;" sire, "Old Dandy." J. Stoddart's "Schann" was bred at Hindalee by Mr. Scott, the successor to James Davidson in that place.

"Pepper," at Birseslees, was bred by Mr. Lang, Selkirk; but as "Pepper" is now thirteen or fourteen years of age, and as Mr. Lang's bitch had about that period litters to different celebrated dogs of that breed, there is now a doubt which of those breeds he is really the produce of. "Old Pepper" is claimed as being bred by more than one celebrated breeder.

"Old Dandie" was bred by Mr. Stoddart.

\* "John Pym" was by "Shem," a dog which belonged to Mr. Somner, of Kelso; dam, a bitch belonging to John Lauder, "Old Melrose," and bred by Mr. Frain, of the Trows, near Kelso.

† "Puck," Dr. Brown's present dog, was got by his old dog "Pym," out of a bitch called "Tib." "Tib" was bred by Purves, of Leaderfoot; sire, "Old Dandie," the famous dog of "Old Stoddart," of Selkirk; dam, "Whin," a very well-bred bitch.

breed having, I believe, been obtained surreptitiously a generation back. It will be seen that the points differ a good deal from those usually ascribed to this breed in England, where the Dandies have almost invariably prick ears, and are of smaller size, seldom exceeding 10 or 12 lbs.

Of this English mongrel the following is a characteristic sketch, in a somewhat exaggerated form.

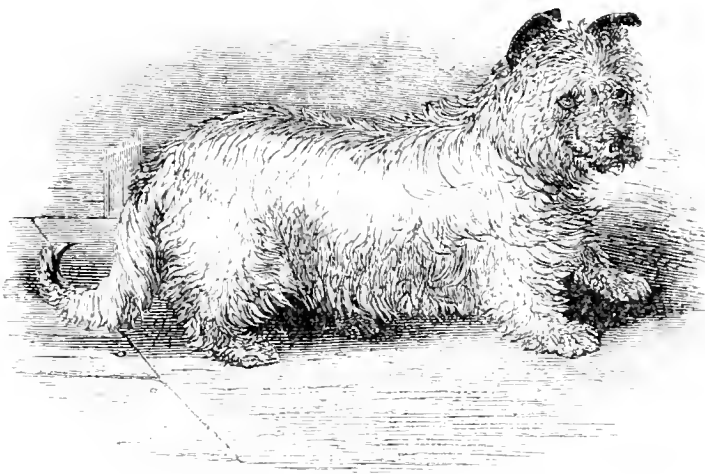

The *Skye Terrier* is remarkable for his long weasel-shaped body, and for his short fin-like legs, added to which he has a long rather than a wide head, and also a neck of unusual dimensions, so that when measured from tip to tail the entire length is more than three times his height. The nose is pointed, but so concealed in the long hair which falls over his eyes, that it is scarcely visible without a careful inspection; eyes keen and expressive, but small as compared with the spaniel. The ears, if falling, are large and slightly raised, but turning over; in the prick-eared variety, which is by many in the north preferred, the ears stand up like those of the fox:



“QUILICK,” a Skye Terrier, the property of Capt. Frazer.

tail long, but small in bone and standing straight backwards, that is, not curved over the back, but having only a very gentle sweep to prevent touching the ground. Fore legs slightly bandy, yet this is not to be sought for, but to be avoided as much as possible, though always more or less present. The dew-claws are entirely absent, and if present may be considered a mark of impurity. The colours most in request are steel-grey, with black tips; fawn with brown tips to ears and tail; black, fawn, or blue, especially a dark slaty blue; the slightest trace of white is carefully avoided. The hair is long and straight, hard, and not silky, parted down the back, and nearly reaching the ground on each side, without the slightest curl or resemblance to wool. On the

legs and on the top of the head it is lighter in colour than on the body, and is softer and more silky. This dog is little used as a sporting or vermin dog, being chiefly reserved for the companionship of man, but he is sometimes employed as a vermin-killer, and is as game as the rest of the terriers when employed for that purpose. His weight is from 10 to 18 lbs., averaging about 14. But the variations in this particular, as indeed in almost all the points of the Skye terrier, are numerous beyond description. Thus there are, first of all, two if not three kinds of the pure Skye: one rather small in size, with long soft hair; another considerably larger, and with hard wiry hair; while again, between these two, a third may, by hair-splitters, be readily made out. Then there is also a cross between the Skye and Dandie, which partakes in nearly equal proportions of the characteristics of each; and, lastly, most of the Skye terriers about London are crossed with the spaniel, giving them that silky coat and jet black colour which are admired by the ladies, but mark impurity of blood. This cross is detected by the worn-out appearance of the hair on the face up to the brow. The Skye is a very good vermin dog, and will hunt anything.

The *Fox Terrier* was originally kept as an addition to every pack of foxhounds, being always so handy as to be up within a very few minutes of running to ground. Now hounds are so fast that he would be left many miles behind in a run, and dependence is therefore placed upon any chance terrier at hand when one is wanted. But in proportion as he has ceased to be used in the hunting-field, he has attained popularity as the most fashionable

companion for young men, and of late years the classes of fox-terriers at our dog shows have been the most numerous and generally interesting.

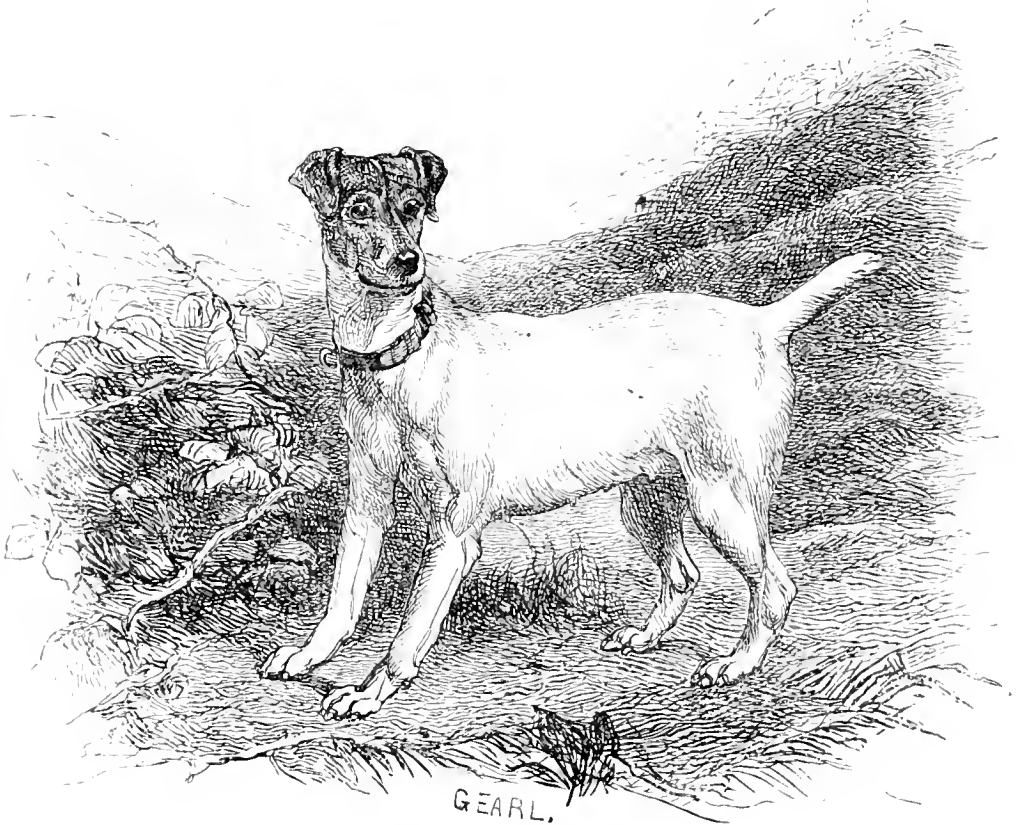

“Fussy,” Fox-Terrier Bitch.

The *points* are as follows: Head flat, and narrow between the eyes, but wider between the ears,—these are set rather back but lie close to the cheek, and are small and thin; jaw strong, mouth level, and teeth strong; eyes small and keen; nose black; shoulders straight, not too wide; chest full and round, but not deep; neck light and coming beautifully out of the shoulder; back

powerful, and thighs well bent and strong ; legs and feet straight and strong ; colour white, with black, or black and tan, or tan markings about the head ; coat fine, but hard and not silky ; weight not exceeding 16 lbs.



“TYNESIDE,” Bedlington Terrier, property of T. J. Pickett, Newcastle-on-Tyne.

The *Bedlington Terrier* has long been prized in the north of England, but until lately it has not been known out of that district. It is a very quarrelsome dog, and is said to be of high courage. The body is not very long, the general appearance being somewhat leggy ; head high and narrow, and crowned with a tuft

of silky hair like the Dandie ; eyes small, round, and rather sunk ; ears filbert-shaped, long, and hanging close to the cheek ; neck long and slender ; legs rather long, but well formed and straight ; colour liver or sandy, or dark blue,—in the two former cases with a cherry nose, in the latter with a black one.



“DUNDREARY,” Blue Tan Terrier. Mr. Foster, Bradford.

The *Yorkshire Blue Tan, silky coated Terrier*, is a modern breed altogether, having been almost unknown beyond the neighbourhood of Halifax until within the last few years. Excepting in colour and coat this dog resembles the old English rough terrier, as well as the Scotch, but the silky texture of his coat and his rich blue tan colour are the result of careful selection and prob-

ably of crossing with the Maltese. The ears are generally cropped, but if entire should be fine, thin, and moderately small. The coat should be long, silky in texture, and well parted down the back. The beard is peculiarly long and falling, being often several inches in length, and of a rich golden tan colour. The colour must be entirely blue on the back and down to the elbows and thighs, without any mixture of tan or fawn. The legs and muzzle should be a rich golden tan; the ears being the same, but of a darker shade. On the top of the skull it becomes lighter and almost fawn. The weight varies from 10lb. to 18lb.

The *Maltese dog* is sometimes classed among the terriers, but, as it has little affinity with them, it is included among the toy dogs.

The *Toy Terrier*, being used solely for fancy purposes, will be described under the chapter devoted to that subject.

The *Turnspit* and the *Truffle-dog* are by some naturalists described as terriers, but they are now nearly extinct, and need not therefore be included here, especially as the shape of the former is so well known, while the latter varies greatly in different districts.

---



## THE BOARHOUND, OR GREAT DANE.

This dog has so frequently been represented on canvas that it would be idle to refuse a description of it, in a work professing

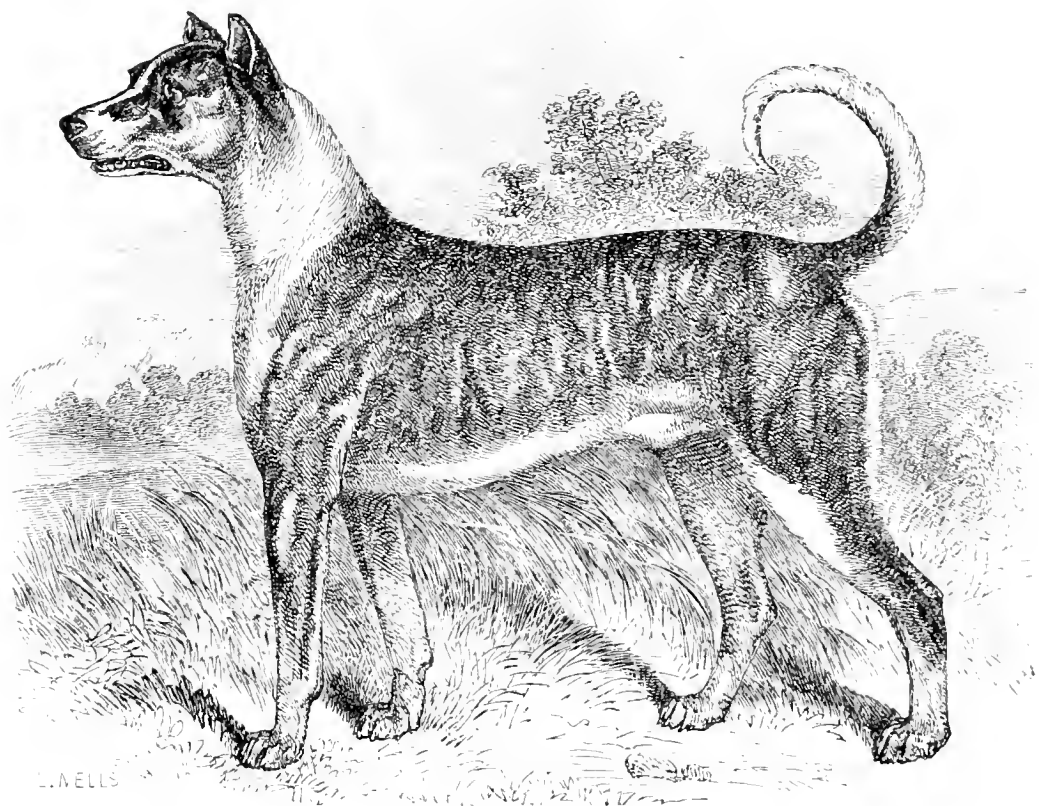

The Boarhound.

to treat of the dog in all his varieties. Nevertheless, he does not appear to be a distinct breed, but rather a compound of the greyhound, the mastiff, and the terrier. The first element being required for speed, the second for strength and courage, and the

third for nose. By some writers he is considered to be a distinct breed, and it is possible that he may be so; but the various forms in which he appears militate against this idea. The colour resembles that of the mastiff, being brindled or fawn, but sometimes of a bluish slate, with blotches of brown. The height is great, being from 30 to 32 inches at the shoulder, with vast strength of body. Head long and narrow, but the muzzle square like that of the mastiff. Tail fine, and slightly curved upwards. This is the same dog as the *Great Dane*, and is used for boar-hunting in Germany, and for hunting the elk in Denmark and Norway.

---

#### THE DACHSHUND, OR TECKEL.

Within the last few years this little hound has been introduced into England, a few couple having been presented to the Queen, from Saxony. The dachshund is a long, low, and very strong hound, with full head and sweeping ears. The fore legs are somewhat bandy, and when digging their action is very mole-like. The colour is either black-and-tan or wholly tan, and the height about 9 to 10 inches. The scenting power of these hounds is said to be very good; they are chiefly used in Germany for hunting the badger, whence the name.

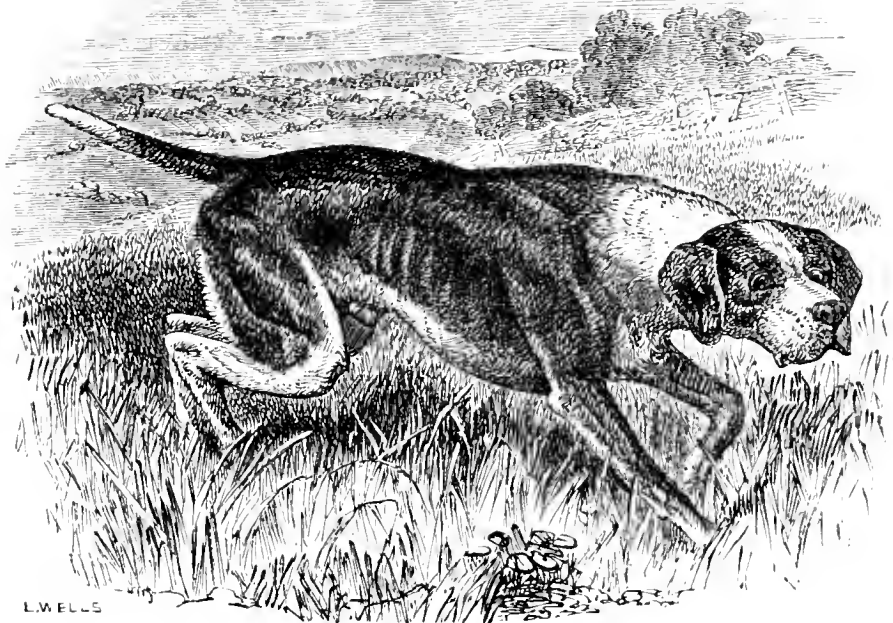

The Spanish Pointer.

## CHAPTER IV.

DOMESTICATED DOGS, FINDING GAME BY SCENT, BUT NOT KILLING IT, BEING CHIEFLY USED IN AID OF THE GUN.

The Spanish Pointer.—The Modern English Pointer.—The Portuguese Pointer.—The French Pointer.—The Dalmatian and Danish Dogs.—The English and Irish Setters.—The Russian Setter.—The Ordinary Field Spaniel, including the Springer (Clumber, Sussex, and Norfolk breeds), and the Cocker (Welsh and Devonshire).—The Water Spaniel (English and Irish).

### THE SPANISH POINTER.

As in the case of the species itself, so in this and most other varieties of the dog, a great difference of opinion exists as to the

origin of each. By most writers the Spanish pointer is thought to be descended from the hound, but from being kept to one particular kind of work he has gradually become fonder of it than of any other, and those particular faculties which are employed in it have become developed. No dog requires a more keen sense of smell, and in none are tractability, patience, and a kind of reasoning power, more imperatively demanded. Hence we require a large brain, and a well-developed nose, in order to endow the possessor with the attributes I have enumerated. The first thing, therefore, which was formerly sought for was the full head, large in all its dimensions, and the wider nose, with the pendent flews which generally accompany a high sense of smell, and which, being met with also in the hound, have led to the belief of the descent of the pointer from that variety of the dog. But, accompanying this form of head, there was produced a heavy and unwieldy formation of the body; and, what is very remarkable, it differed in shape from that of the hound, so that there is strong reason for believing that the two are altogether distinct, and have been kept so from the earliest ages. Indeed, their style of hunting differs so much, that it alone would lead one to suppose them to have had a distinct origin, inasmuch as the hound always drops his nose to the ground in feeling for a scent, while the pointer carries his head in the air, and tries for the body scent as it is wafted on the breeze. The true old Spanish pointer is hardly to be met with now in a pure state, and I therefore insert a copy of an old and well-known portrait of the animal, which is acknowledged to be correct, and gives his points with great fidelity, showing also how much he exceeds the

modern breed of dogs in size of head and nose, and in depth of ear. It will be seen that this is a very heavy and somewhat clumsy dog, incapable of ranging far and fast, as is required in wild beats for the partridge, and in most cases for grouse. Our ancestors were satisfied and pleased to walk with their dogs in beating for game, but in these modern times sportsmen like to take it easy, and make their pointers or setters do their work for them, so that pace and lasting powers to keep it up are now much more required; and hence the modern English pointer has been bred, partly by crossing with the foxhound or greyhound, and partly by selecting the lightest and quickest of the old breed.

The *Spanish pointer* is characterised by great height and weight, large bones, and altogether heavy limbs, large and rather spreading feet, a small stern, which in the engraving is represented as cropped, that being the universal practice in former days with the pointer; muzzle broad, head large and heavy, ears full and pendent, but not so wide as those of the hound. In hunting he was slow and lumbering, lashing his "stern" with great vigour, and, from his weight, soon tiring himself, or wearing his feet through till he became lame. Three or four hours' work in the day was quite as much as could be got out of this dog, which is therefore now almost entirely superseded by the modern breeds.

---

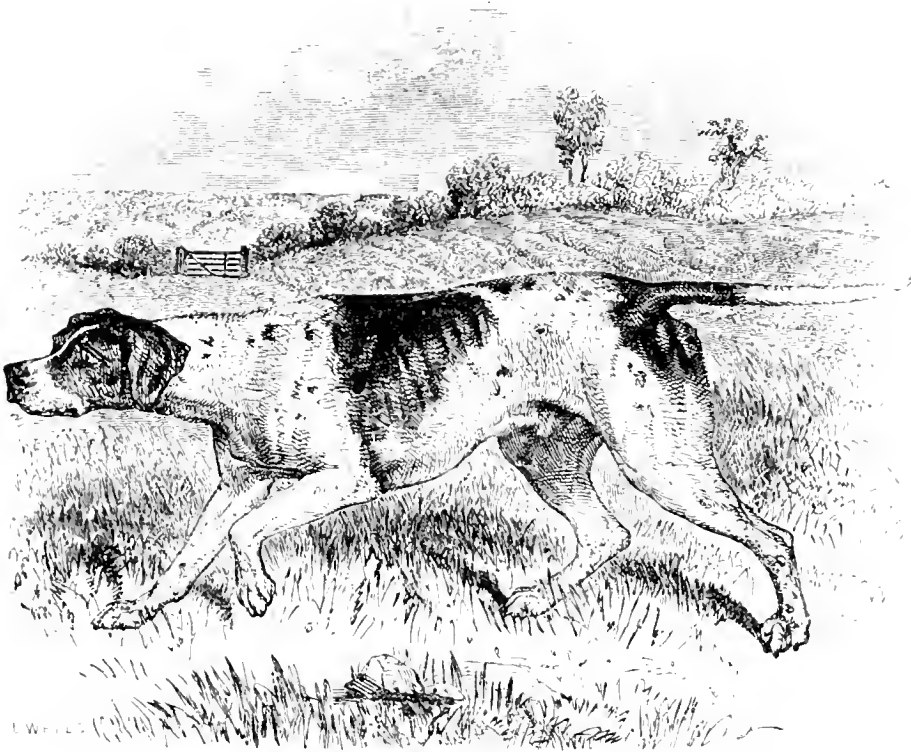

“SANCHO,” a modern English Pointer.

### THE MODERN ENGLISH POINTER.

This is now one of the most beautiful of all our sporting dogs, dividing with the setter the admiration of all those who enjoy the pleasures attending on the use of the gun. The above engraving is from a dog possessing the extreme degree of development of the head and muzzle that is now sanctioned, but uniting with it a very different frame, legs, and feet from those of the Spanish pointer. Such a dog is a very fast galloper compared with the old-fashioned dog, and will beat out a moderate-sized field while his master is crossing it at a moderate pace. If extreme speed is obtained, many

single birds must be passed over, and on bad scenting days coveys even will be run in to from the dog being unable to stop himself in time, after he catches the scent, which then does not reach beyond a few yards. I have seen and owned pointers almost as fast as a slow greyhound, but though some are able to do wonders, considering the pace they go, I am satisfied that a brace of good dogs of the above shape are able to do all that can be required, in point of pace, and at the same time will not run in to a twentieth part of the game which will be put up by a faster dog. The trace of the foxhound in these heavier specimens of the modern pointer is very slight if any; and I am inclined to believe that they are descended from the Spanish pointer in all his purity, but, by constant care in the selection of the lightest specimens to breed from, so altered in shape as to appear like different animals. All this is, however, purely conjectural, as the pedigrees of our pointers seldom extend beyond two or three generations, and even Mr. Edge in his day could hardly have gone further, nor could the breeders of the present time trace their pointers sufficiently far back to settle the question. The pedigrees of those bred by Lord Sefton are probably as well made out as any in the kingdom, but even they are far from leading to what is desired. If a dog is traced up to any one of Mr. Edge's kennel, all is done which is now thought necessary, and indeed all that can be useful to the sportsman, however interesting a further investigation might be to the naturalist.

The *points* desirable in the pointer are, a moderately large head, wide rather than long, with a high forehead, and an intelligent eye

of medium size. Muzzle broad, with its outline square in front, not receding as in the hound. Flews manifestly present, but not pendent. The head should be well set on the neck, with a peculiar form at the junction only seen in the pointer. The neck itself should be long, convex in its upper outline, without any tendency to a dewlap or to a "ruff," as the loose skin covered with long hair round the neck is called. The body is of good length, with a strong loin, wide hips, and rather arched ribs, the chest being well let down, but not in a hatchet shape as in the greyhound, and the depth of the *back ribs* being proportionately greater than in that dog. The tail, or "stern" as it is technically called, is strong at the root, but suddenly diminishing it becomes very fine, and then continues nearly of the same size to within two inches of the tip, when it goes off to a point looking as sharp as the sting of a wasp, and giving the whole very much the appearance of that part of the insect, but magnified as a matter of course. This peculiar shape of the stern characterises the breed, and its absence shows a cross with the hound or some other dog. The shoulders are points of great importance in the pointer, as unless they are well-formed he cannot last throughout the day, and, moreover, he can neither stop himself nor turn quickly in his work as he ought to do. Hence, a long, slanting, but muscular blade is of vast importance, united to a long upper arm, which again requires for its existence an elbow well let down below the chest, and a short fore arm. This low position of the elbow is not generally sufficiently insisted on, but in pointers and setters it is all-important, and it will be seen to be particularly well shown in the portrait annexed.



Plenty of bone in the leg, well clothed with muscle and tendon, a strong knee, full-sized ankle, and round strong foot, *provided with a thick sole*, are also essential to the wear and tear of the fore quarter, while the hind requires muscular haunches and thighs, strong well-bent stifles, large and strong hocks, and the hind feet of the same character as those described for the fore feet. The colour should be principally white, in order that the dog may readily be seen either among heather, or in clover or turnips, as the case may be. Liver-coloured or black pointers look very handsome, but it will be found that great inconvenience attaches to them, as they will often be lost sight of when pointing in either of the above kinds of beat. White, with black, liver, yellow, or lemon-coloured heads, are the most prized; and of these my prejudice is in favour of the last, from having had and seen so many good dogs of that colour. A spot or two on the body, and any number of ticks, are not considered objectionable, particularly the latter, which are generally admired. Some breeds are distinguished by having numerous white ticks in the colour, especially when there are large patches on the body, the marks on the head being usually free from them. Black and white pointers have sometimes also the tanned spots over the eye, and the edges of the black on the cheeks tinged with tan; but this is supposed to indicate a cross of the foxhound, and no doubt in many cases with truth; yet I fancy that if a yellow and white pointer is put to a black and white one, the tan will show itself occasionally without any admixture with the hound. The coat of the high-bred pointer is short and soft to the touch; but for hard work, especially on

the moors, a dog with rather a wiry coat, and well clothed with hair on the legs and feet, should be preferred; but these will show rather more hair on the stern than is thought to be characteristic of high breeding; yet let the stern be ever so hairy, there ought to be the same small *bone* and pointed tip as in the engraving.

---

#### THE PORTUGUESE POINTER

Resembles the Spanish in general form, but is furnished with a bushy stern, and looks like a cross with the old-fashioned spaniel.

---

#### THE FRENCH POINTER.

This is rather a nondescript animal, as he varies greatly throughout France, being in some districts very similar to the Spanish dog, while in others he has evidently been crossed with the poodle, and resembles that dog very closely. Indeed, the poodle itself is often broken and used as a pointer, but he is incapable of long-continued work; and such is also the characteristic of the French dog, though perhaps superior in this respect to the Spanish breed. Many English pointers are now used in France, and indeed the great majority of good sportsmen in that country have them more or less pure.

---

#### THE DALMATIAN AND DANISH DOGS.

The *Dalmatian dog* is a handsome well-formed dog, standing

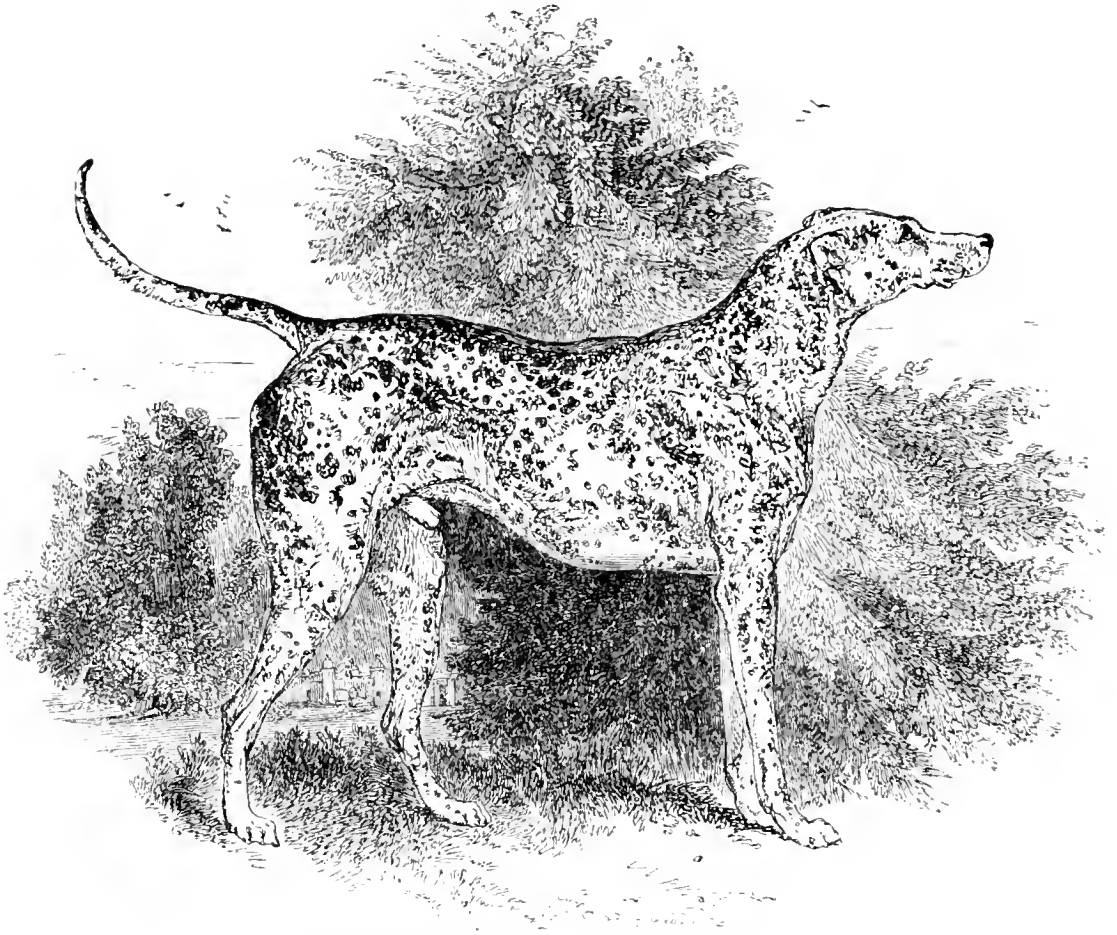

The Dalmatian Dog. (Youatt.)

about 24 or 25 inches high, and resembling the pointer in his shape, but usually having his ears cropped, as shown in the engraving. He is beautifully spotted with black on a white ground, his chief merit consisting in the nearly uniform size of the spots (which should be from about an inch in diameter), and in their distinctness from the white in which they are imbedded; and being remarkably fond of horses, and of road-work with them, he has been long employed in this country to accompany our carriages as an ornamental appendage; but this fashion has of late

years subsided. Hence he is here commonly known as “the Coach Dog;” but in his native country he is used as a pointer in the field, and is said to perform his duties well enough.

The small *Danish dog* is smaller than the Dalmatian; but, being spotted in the same way and characterised by the same fondness for horses, they are generally confounded under the term “Coach Dog.”

The *Great Dane* resembles the Boarhound. See page 86.

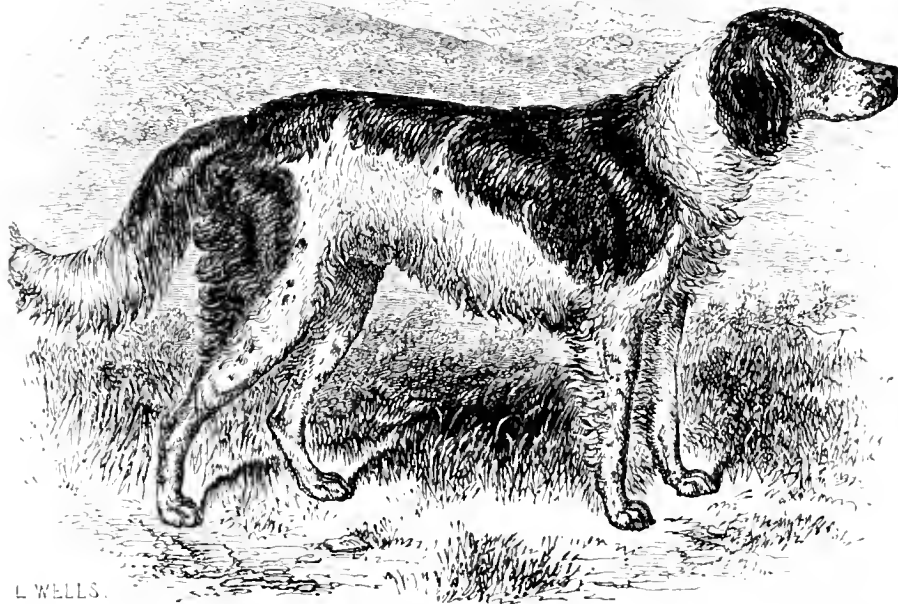

L. WELLS.

“SAILOR,” a perfect specimen of the Setter; bred by Mr. Tustin of Worcester.

#### THE SETTER (ENGLISH, IRISH, AND SCOTCH).

The *setter* is commonly supposed to be the old spaniel, either crossed with the pointer or his setting powers educated by long

attention to the breed. Daniel, in his "Rural Sports," vol. ii. p. 290, gives a copy of a bond, signed by John Harris, on Oct. 7, 1485, in which he covenants to keep for six months, and break, a certain spaniel to "set partridges, pheasants, and other game," in consideration "of ten shillings of lawful English money." Thus it can be shown, that as early as the fifteenth century, a dog similar to a spaniel, and therefore not a pointer, was used for setting game; and there is reason to believe that at that time, and for a long period subsequently, the setter did actually *drop* and not *stand* as the pointer does; but how this change was effected we do not exactly know, though there can be no doubt of the fact. The following may be hazarded as the most probable explanation of this change which has taken place in the position of the setter. Prior to the introduction of the flint-gun it was impossible to shoot flying, and these dogs were used in aid of the net which was drawn over both dog and game, and hence a crouching setter was more useful than a standing pointer; but, when the gun came into general use, the pointer, from being more visible as he kept his upright posture, was selected in preference, and the setter rejected, until in course of time certain breeds of that dog were known to imitate the pointer in the standing position, and after a still further lapse the old crouching style of setting was lost. Thus, I believe, it came to pass that the English setter imitated the pointer; but whether it was effected by crossing with that dog it is difficult to say. We know now by experience that the first cross between the two, commonly called "a dropper," is a very useful dog, possessing the properties of each, but it does not

answer to go on breeding from it, either on the side of the sire or dam; and therefore, judging from analogy, the effect has not been produced in this way.

The peculiar characteristics of the English and Irish setters, as displayed in the field, are great speed, activity, endurance, capability of bearing cold and wet, and of standing the rough work of the moors, in all of which good qualities the Irish setter is even better than the English. He not only has these in perfection, but he also exaggerates the wilfulness and want of steadiness so remarkable in the setter as compared with the pointer, while, at the same time, he is just as incapable of bearing the heat of the sun without water. Indeed some rough-coated setters, both Irish and English, cannot work at all when their skins are dry, and, unless they can run into a pool every half-hour at least, they blow like porpoises, and are utterly useless. Hence it is that, in the south, the pointer, who fulfils all the requisites for partridge-shooting, is preferred to the setter as a general rule; while, in the north, the latter is adopted, because he will range wider and faster, stand more work, and bear the vicissitudes of the weather so common in Scotland, as well as the rough heather, which distresses the more delicate feet and legs of the highbred pointer. In point of nose it is commonly supposed that the pointer is also superior, but I believe that if both are in condition, and neither of them distressed by heat, there will be little or no difference in this respect. A moderately slow dog will always appear to have a better nose than a very fast one, and will put up less game; but, if too slow, he will lose a great many points which are taken from him by his faster competitor.

Hence it follows that there is a medium in point of speed which may be possessed by either breed, and a selection need not be made on that account. The setter is, however, acknowledged to be more difficult to break than the pointer, and when once broken he is more apt to require a second series of lessons, whereas the pointer rarely forgets himself unless encouraged to do so by a careless or incompetent master.

The *points* of the English and Irish setters are nearly the same, but there is a peculiar look about each, which, though not exactly capable of being described, readily distinguishes the one from the other. Both have moderately heavy heads, but not so much so as the pointer; and their muzzles also are not so broad, nor are they nearly so square in profile, the lower angle being rounded off, but the upper being still nearly a right angle. The eye is similar to that of the pointer, but not so soft, being more sparkling and full of spirit. The ear long, but thin, and covered with soft silky hair, slightly waved. The neck is long, but straighter than that of the pointer, being also lighter and very flexible. The back and loin are hardly so strong as those of the pointer, the latter also being rather longer; the hips also being more ragged, and the ribs not so round and barrel-like. The stern, or flag, is usually set on a little lower, is furnished with a fan-like brush of long hair, and is slightly curved upwards towards the tip, but it should never be carried over the back, or raised above the level of its root, excepting when standing, and then a slight elevation is admired, every hair standing down with a stiff and regular appearance. The shoulder-blade is very long and fine, and the

chest not being so wide as that of the pointer, it plays very freely upon the ribs. The true arm should be very long, and the elbow, when in perfection, is placed so low as to be fully an inch below the brisket, making the fore arm appear very short, as seen in the beautiful illustration which heads this article. The bone of the leg is very large, and the feet round, thick, and their soles hard, while they, as well as the back of the legs, being clothed with long hair, are well protected from all kinds of friction. The hind quarter is not usually so muscular as that of the pointer; but the thighs being longer, and the hocks usually stronger, the power is quite as great. The hind feet and legs are clothed with hair, or "feathered," as it is called, in the same way as the fore legs, and the amount of this beautiful provision is taken into consideration in selecting the dog for his *points*. In all these the English and Irish dogs are alike, except that the latter are rather more leggy, but are very powerful nevertheless, and are quite as enduring. The colour of the Irish should be a rich blood red, with muzzle of the same shade. Sometimes this is actually black, but more often a rich mahogany, the same dark shade running down the back to the stern, which has the short hair as dark as the muzzle, but this deeper stain is objected to by most breeders. Many strains have more or less white about their limbs, but the mouth should always be black, and, unless they are white and red, the less white the better. On the other hand, the English setter has almost always, like the pointer, a foundation of white, with black, liver-coloured, yellow, red, or lemon-coloured head, and much of the same colour, with or without ticks, about them. Some are pure black



or pure white, others black and tan ; and others, again, black and white, with the tan spots over the eyes, and tanned cheeks, described under the head of the pointer. The coat of the setter is of the greatest importance to attend to in selecting the breed, since there is a great difference in this respect ; and while those with thin coats are equally capable of bearing heat with the pointer, the rough, curly, and oily-coated dogs are utterly useless in hot weather. The best kind of hair is one which is composed of the same silky text-



The Gordon Setter.

ure throughout (that is, without an under coat of a woolly nature), and which, without any decided curl, has a trace of a wave here

and there. These dogs ought, however, to be well feathered nearly all the way down their legs, and their feet especially ought to be well clothed with hair. When thus feathered they have always plenty of hair on their flags; but if these are bushy sideways, and not presenting a flat fanlike form, they are to be considered imperfect in this point, though, nevertheless, the individual possessing such a stern may be a good dog.

*The Scotch or Gordon Setter* is of a black tan, or black tan and white colour, in other respects resembling the English dog, except in some few minute points. This breed has lately become fashionable in England, where it is as common as its southern competitor.

The bitch setter, like the pointer, is lighter and smaller, especially about the head, which is not so square and deep in any of its proportions.

---

#### THE RUSSIAN SETTER.

This dog was at one time, that is, about twenty years ago, considered to be superior to our English breed, and many of them were then introduced into the kennels of our best sportsmen, but they are now almost lost sight of again. In the year 1841, the late Mr. Lang, well known as a first-rate shot both at game and pigeons, and as a breeder of pointers and setters, wrote to the Editor of the "Sporting Review" a letter warmly in praise of them, from which the following is an extract:—

"In the season of 1839 I was asked, for a week's shooting, into Somersetshire, by an old friend, whose science in everything con-

needed with sporting is first rate. Then, for the first time for many years, I had my dogs, English setters, beaten hollow. His breed was from pure Russian setters, crossed by an English setter dog, which some years ago made a sensation in the sporting world, from his extraordinary performances: he belonged to the late

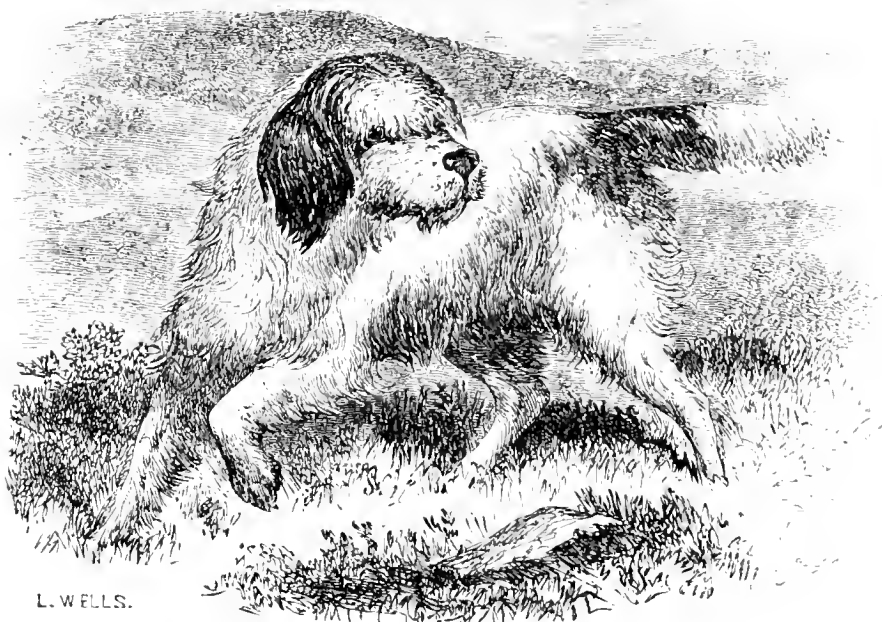

A Russian Setter slightly crossed with English blood.

Joseph Manton, and had been sold for a hundred guineas. Although I could not but remark the excellence of my friend's dogs, yet it struck me, as I had shot over my own old favourite setter (who had himself beat many good ones, and had never before been beaten) for eight years, that his nose could not have been right, for the Russians got three points to his one. I therefore resolved to try some others against them the next season; and having heard a

gentleman, well known as an excellent judge, speak of a brace of extraordinary young dogs he had seen in the neighbourhood of his Yorkshire moors, with his recommendation I purchased them. I shot to them in August last, and their beauty and style of performance were spoken of in terms of praise by a correspondent to a sporting paper. In September I took them into Somersetshire, fully anticipating that I should give the Russians the go by : but I was again disappointed ; I found, from the wide ranging of my dogs, and the noise consequent upon their going so fast through stubbles and turnips (particularly in the middle of the day, when the sun was powerful and there was but little scent), that they constantly put up their birds out of distance, or, if they did get a point, that the game would rarely lie till we could get to it. The Russians, on the contrary, being much closer rangers, quartering their ground steadily—heads and tails up—and possessing perfection of nose, in extreme heat, wet, or cold, enabled us to bag double the head of game that mine did. Nor did they lose one solitary wounded bird ; whereas, with my own dogs, I lost six brace the first two days of partridge-shooting, most of them in standing corn.

“ My old friend and patron, having met with a severe accident while hunting last season, determined to go to Scotland for the next three years. Seeing that my dogs were well calculated for grouse-shooting, as they had been broken and shot to on the moors, and being aware of my anxiety to possess the breed of his Russians, he very kindly offered to exchange them for mine, with a promise that I would reserve a brace of Russian puppies for him. Although I had refused fifty guineas for my brace, I most gladly

closed with his offer. Since then I have hunted them in company with several dogs of high character, but nothing that I have yet seen could equal them. If not taken out for six months, they are perfectly steady, which is a quality rarely to be met with. Every sportsman must know, that the fewer dogs he can do his work with properly, the better : for if they are in condition they cannot be too frequently hunted ; and their tempers, style of working, &c., become more familiar to him. On this the whole comfort of shooting depends. Upon these grounds I contend that, for all kinds of shooting, there is nothing equal to the Russian or half-bred Russian setter, in nose, sagacity, and every other necessary qualification that a dog ought to possess."

Since then, however, Mr. Lang lost the breed, and, I believe, for some reason or other, had also lost confidence in them. They are now very scarce in this country, of pure blood, and even the cross with the English setter is seldom seen.

The actual form of the Russian setter is almost entirely concealed by a long woolly coat, which is matted together in the most extraordinary manner, and which would lead to the supposition that he would be unable to stand heat even as well as our curly setters ; but, on the contrary, he bears it almost like a pointer. He has the bearded muzzle of the deerhound and Scotch terrier, but the hair is of a more woolly nature, and appears to be between that of the poodle and the water spaniel, or perhaps the ordinary setter, but far thinner than either, which may account for the sustenance of heat. The legs are straight and strong, and the form of the body well adapted for the pace which the setter has to keep

up; but this dog is not very fast, though quite sufficiently so for all sporting purposes. The feet are generally rather flat, but the soles are stout, and stand work well, while the quantity of hair on them fits them to bear the friction of heather or other rough work. I have never tried one of these dogs myself, but I have always heard the highest character of their nose and sagacity, as well as of their powers of endurance.

---

#### THE FIELD SPANIEL.

*The field spaniel* is distinguished from the toy dog by his propensity to hunt game, and by his size and strength, which are sufficient to enable him to stand the work which is required in making his way through the briars and thorns of a thick covert, where he is chiefly employed. Although not used for water, where the water spaniel is pre-eminent, his coat must be of such a thick nature as to bear long-continued wet, inasmuch as he is generally soaked with it, either from the snow on the briars, or from moisture hanging to them in drops, caused either by rain or dew. Hardihood, therefore, is essential, and though a little dog *may* possess it, there are few instances of anything under 12 or 14 pounds being able to stand the wet and labour of a day's covert shooting. The nose of the spaniel must be exquisite, or he will be unfit to perform his duties, which require him to follow out the pheasant, woodcock, or hare, to the well-concealed retreat in or under a thick bush, which either of them may have chosen. A good and somewhat musical tongue was, by the old school of sportsmen, con-

sidered a *desideratum*, in order not only to give notice that the dog is on game, but also the particular kind which he is "questing," and which many good spaniels enable their masters to distinguish by a variation in their notes. Formerly this was thought so important, that if a spaniel happened to be mute, he was hunted with a bell round his neck, as is sometimes done with the setter when used in covert. In the present day, a very fashionable breed (the Clumber), is invariably mute; but as these dogs are chiefly used in aid of the *battue*, there is not the same necessity for them to give notice of their approach, as in the case of spaniels used either in wild-pheasant shooting, or for cocks, hares, or rabbits. It will therefore appear, that, for every kind of covert shooting but the *battue*, we require a strong useful spaniel, capable of bearing exposure to the weather, and neither too large for the runs, nor too small to bear work. Added to these qualities, we want an exquisite nose, and a musical but not noisy tongue, which is all the more valuable if it will distinguish by its note the various kinds of game. These dogs must also be readily kept under command, and must not be inclined to hunt far away from the shooter, or so fast as to prevent his following them. For various purposes a vast number of breeds have been established, more or less resembling each other, and a good many of them being now extinct, in consequence of the diminished demand for their services since the introduction of *battues* and their attendant preserves, by which, as a matter of course, wild covert shooting is rendered much more scarce. All the spaniels have a marked down carriage of their tails, which they work rapidly when on

game, but should never raise above the level of their backs. All these various breeds may, however, be arranged under two leading divisions: one known as "the Springer," and including the Sussex, Clumber, and Norfolk Spaniels, besides several others confined to their respective localities; and the other called "the Cocker," from his being chiefly used for woodcocks, though also good for general purposes. The King Charles and Blenheim originally belonged to the second division, but they are now kept and bred for toy purposes only.

The *springer* has a most tender and discriminating nose, is very tractable, and therefore easily kept in command. As has been already remarked, some are mute (as the Clumber), while others throw their tongues, as, for instance, the Sussex and the Norfolk. All the springers are heavy and slow as compared with the cockers, and most of them soon tire, three or four hours' work being about a good average day's work. Hence, they are scarcely adapted for beating large and wild woodlands, and for this reason they are seldom used for cock-shooting, excepting in small coverts frequented by this bird, and highly valued by the sportsman.

The *Clumber spaniel*, which for a long time was confined to the Newcastle family, but has lately become very fashionable, is a remarkably long, low, and somewhat heavy dog. In weight he is from 30 to 40 lbs. Height 18 to 20 inches. The head is heavy, wide, and full, the muzzle broad and square, generally of a flesh colour. Nostrils open, and chops full and somewhat pendent. Ears long, and clothed with wavy hair, not too thick. Body very



long and strong, the back ribs being very deep, and the chest being very round and barrel-like, the ribs at the same time being so widely separated from each other as to make the interval between them and the hips small in proportion to the great length. Tail

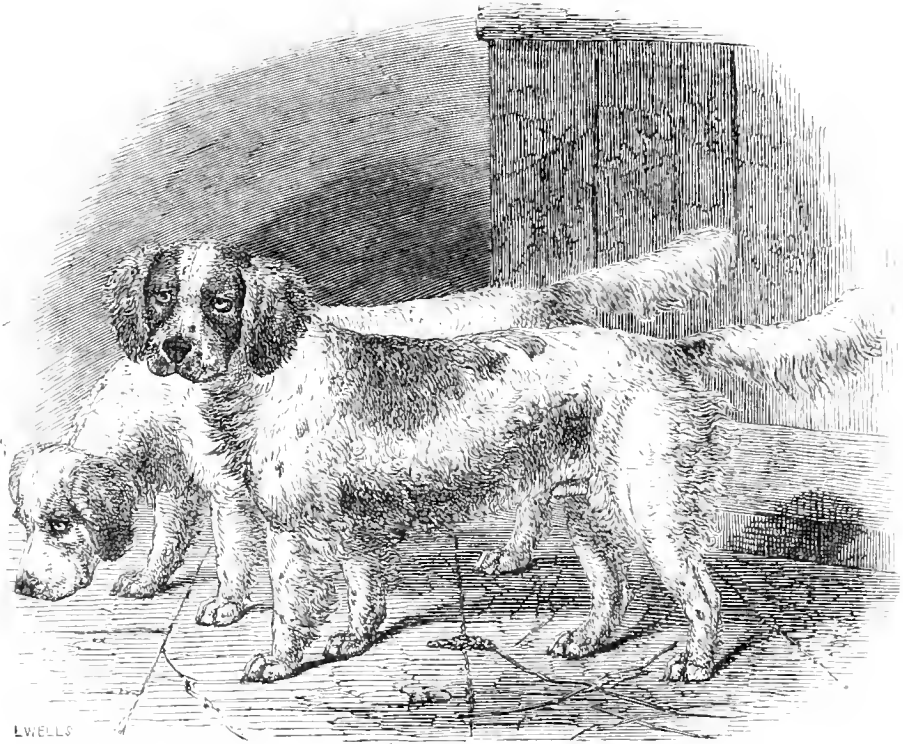

“BRASS” and “JUDY,” Clumber Spaniels, the property of G. Vernon, Esq., of Hambury Hall.

bushy, but not at all woolly, the hair being waved only, not curled. It is generally cropped. Shoulders rather heavy and wide apart, arms short but strong, elbows not very well let down, fore arms strong, with plenty of bone, good knees, and strong useful round feet, but not very well up in the knuckles. The legs should be well feathered, and the feet hairy. The hind legs are rather straight, and should, like the fore legs, be short, so that the dog

altogether has rather a weasely appearance, but the body being considerably stouter in proportion than that animal's. The coat is very thick, but should be silky and wavy, not curled, except in the featherings, which are long and well marked. Colour, yellow and white, or, as is most highly prized, lemon and white. This dog is almost invariably mute.

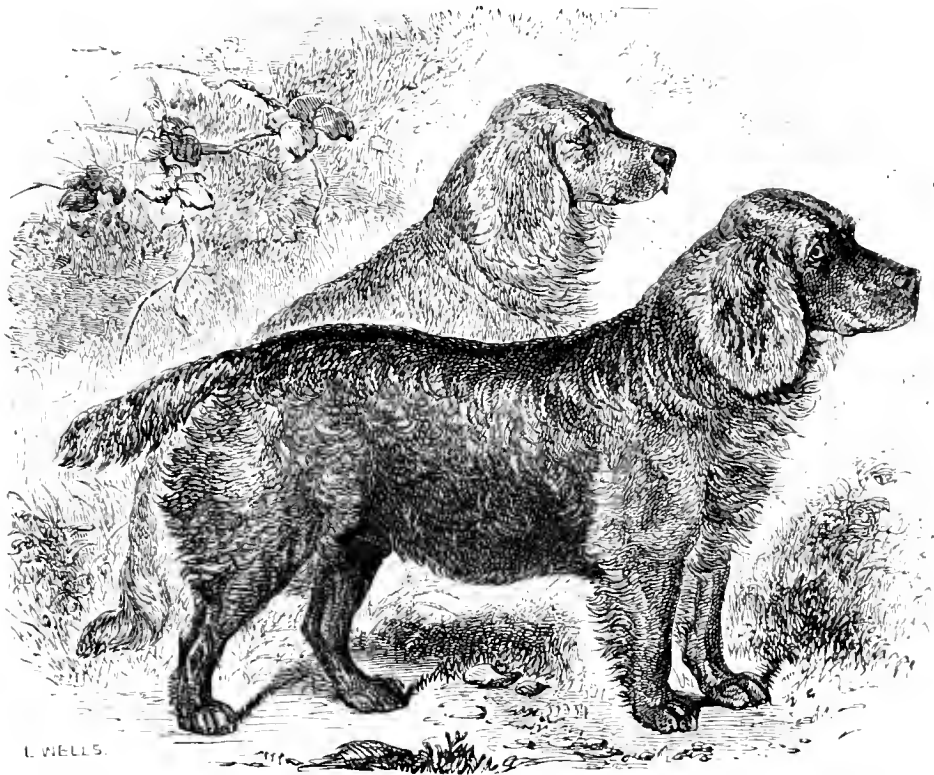

"GEORGE" and "ROMP," \* Sussex Spaniels, the property of E. Soames, Esq., of London.

The *Sussex spaniel* differs from the Chumber in shape and colour, as well as in his "questing," his note being full and bell-like, though sharp. In height and weight there is not much

\* Bred by the late A. E. Fuller, Esq., of Rose Hill, Brightling, Sussex. and descended from the celebrated stock of Mr. Moneypenny, of Rolvendon.

difference, nor is the general character of the head very distinguishable from that of the Clumber; but in length he is not nearly so remarkable as that dog, though still long and low, the body being very round and full, indicating great power. The coat also is pretty nearly the same in quality, being soft and silky, though thick and free from distinct curls; and this dog is also beautifully feathered. The head is not quite so heavy about the muzzle, but very square above the eyes, and with an expression of exceeding gravity and intelligence. The ears are full in length, lobe-shaped, but not very thickly covered with hair. Muzzle broad, with the under jaw receding more than in the Clumber, and the point of the nose of a liver-colour. The whole body is also of a decided liver-colour, but with rather a golden shade, not so puce as that of the Welsh or Devonshire cockers, or the Irish water spaniel. Legs and feet very strong, and well feathered. Tail generally cropped, and well clothed with wavy hair. The bitches are usually smaller than the dogs. All of this breed throw their tongues, and when kept to cocks or pheasants, they readily indicate their scent by a sharper note than usual.

The *Norfolk spaniel* resembles a thick-made English setter in shape and general proportions, but is of smaller size, seldom exceeding 17 or 18 inches in height. The colour is black and white, or liver and white, accompanied by ticks of either on the white. This is a very useful breed, and it is now generally spread throughout England, where, however, it is not kept very pure, being crossed with the Clumber and Sussex, and also with the innumerable other breeds which are met with in other counties.

The *cocker* can scarcely be minutely described, inasmuch as there are so many varieties in different parts of Great Britain. He may, however, be said, in general terms, to be a light active spaniel of about 14 lbs. weight on the average, sometimes reaching 20 lbs., with very elegant shapes, and a lively and spirited carriage. In hunting he keeps his tail down, like the rest of his kind, and works it constantly in a most rapid and merry way, from which alone he may be known from the springer, who also works his, but solemnly and deliberately, and apparently without the same pleasurable sensations which are displayed by the cocker. The head is round, and the forehead raised. Muzzle more pointed than the springer, and the ear less heavy, but of good length, and well clothed with soft wavy hair, which should not be matted in a heavy mass. In the show-dog of the present day (1872) the ear is far too long, both in leather and feather, according to my judgment. The eye is of medium size, slightly inclined to water, but not to weep like the toy dog's. Body of medium length, and the shape generally resembling that of a small setter. It has long been the custom to crop the tail nearly half off, so as to prevent the constant wearing of it against the bushes, as the dog works his way through them. If left on, it is nearly as long in proportion as that of the setter, but more bushy, and not so closely resembling a fan. These dogs are well feathered, and the work for their feet and legs requires them to be strong and well formed. The coat should be thick and wavy, but not absolutely curled, which last shows the cross with the water spaniel, and that gives too much obstinacy with it to

conduce to success in covert shooting. The colour varies from a plain liver or black to black and tan, white and black, white and liver, white and red, or white and lemon; and different breeds are noted as possessing some one of these in particular, but I am not aware that any one is remarkable as belonging to a superior race.

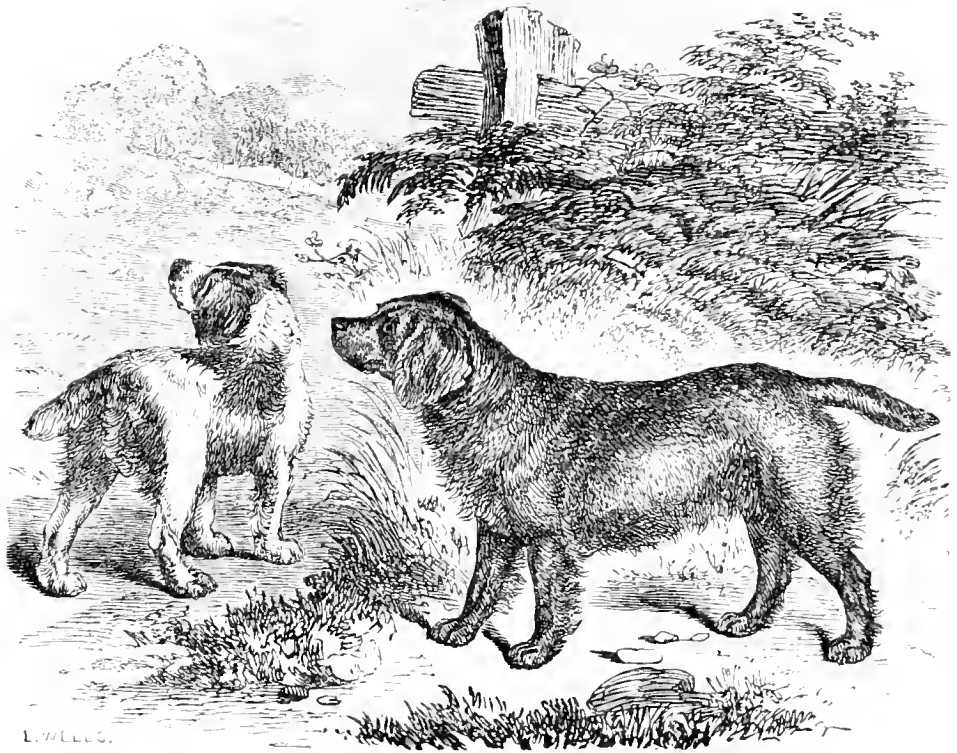

English and Welsh Cockers.

The *Welsh cocker*, as represented on the right, is one of the best of this division, being of good size, with strong loins, capital legs and feet, and an excellent nose. The coat is very slightly curled on the body, but the ears and legs are feathered, the tail being very nearly bare of hair. These dogs are still extensively used in Wales for the purpose of hunting the cocks, which

are to be met with in the principality in large numbers during the season, and form one of the chief attractions to the shooter.

The *Deronshire cocker* closely resembles the Welsh dog, both being of a deep liver-colour. The dog on the left is the ordinary English cocker.

The *Blenheim* and *King Charles' spaniels* will be described under the head of toy dogs, to which purpose alone are they really suited, though sometimes used in covert shooting.

---

#### THE WATER SPANIEL.

*Water spaniels* are commonly said to have web-feet, and this point is often made a ground of distinction from other dogs, but the fact is that all dogs have their toes united by membranes in the same way, the only distinction between the water and land dogs being that the former have larger feet, and that the membrane between the toes being more lax, they spread more in swimming, and are thus more useful in the water. Most people would understand, from the stress laid on web-feet in the water dogs, that the toes of the land dogs were nearly as much divided as those of man, but there are none so formed, and, as I before remarked, the toes of all are united throughout by a strong membrane. The coat in all the water dogs is woolly and thickly matted, often curly, and in all more or less oily, so as to resist the action of the water. This oil is rank in smell, and hence they are all unfit to be inmates

of our houses, which is a strong objection even to the poodle as a toy dog. As, therefore, we have no ground for separating the land from the water dogs by this strong line, I have not attempted to do so, but have grouped them according to the divisions under which they naturally fall.

The *Old English water spaniel* is particularly fond of the water, and will enter it in almost all weathers by choice, while it never is too cold for him when any game is on it. His powers of swimming and diving are immense, and he will continue in it for hours together, after which he gives his coat a shake and is soon dry. Indeed, when he first comes out he does not seem thoroughly wet, his oiled and woolly coat appearing to set at defiance the approach of water. His nose is pretty good, and he is capable of an excellent education; but it takes some time to break him thoroughly, as he is required to be completely under command, and is a very restless dog by nature, whereas his duties demand perfect silence. There are generally said to be two distinct breeds, one larger than the other, but in other respects alike.

His *points* are as follows:—Head long and narrow, eyes small, and ears of medium length, covered with thick curly hair. Body stout, but elegantly formed, with strong loins, and round barrel-like chest, which is broad across the shoulders. The legs are rather long, but very strong, the bone being of great size, and well clothed with muscle. Feet large and spreading, tail covered thickly with long curly hair, and slightly curved upwards, but not carried above the level of the back.



The Southern Irish Water Spaniel.

The *Irish water spaniel* consists of two distinct varieties, peculiar to the North and South of Ireland. The *Northern* dog has short ears, with little feather either on them or on the legs, but with a considerable curl in his coat. In colour he is generally liver, but with more or less white which sometimes predominates, so as to make him decidedly white and liver. The *South country* Irish water spaniel is, on the contrary, invariably of a puce liver colour. Ears long and well feathered, being often two feet from point to point, and the whole coat consisting of short crisp curls.



Body long, low, and strong, tail round and carried slightly down ; but straight, without any approach to feather. The celebrated breed known as "M'Carthy's" is thus described by that gentleman in "The Field" newspaper.

"The present improved and fancy breed, called M'Carthy's breed, should run thus :—Dog from 21 to 22½ inches high (seldom higher when pure bred), head rather capacious, forehead prominent, face from eyes down perfectly smooth, ears from 24 to 26 inches from point to point. The head should be crowned with a well-defined top-knot, not straggling across like the common rough water dog, but coming down in a peak on the forehead. The body should be covered with small crisp curls, which often become daggled in the moulting season ; the tail should be round without feather underneath, of the two rather short, and as stiff as a ramrod ; the colour of a pure puce liver without any white. Though these dogs are generally of very high mettle, I have never found them intractable or difficult to be trained ; they readily keep to heel and down-charge, and will find a dead or wounded bird anywhere, either in the open or in covert, but they are not partial to stiff thorny brakes, as the briars catch the curl and trail after them. It is advisable to give them a little training at night, so that in seeking objects they must rely upon the nose alone. For the gun, they should be taught to go into the water like a duck ; but when kept for fancy, a good dog of this breed will take a flying jump of from 25 to 35 feet, or more, perpendicular height, into the water. My old dog "Boatswain" lived to be about eighteen years old, when, although in good health and

spirits, I was obliged to destroy him. When going abroad in 1849, for some years, I gave my breed to Mr. Jolliffe Tuffnell, of Mount-street, Merrion-square, Dublin, son of the late Col. Tuffnell, of Bath. His dog Jack, a son of my dog Boatswain, is known particularly as a sire to every one in Ireland, and to very many in England. A good well-trained dog of this breed will not be obtained under from 10*l.* to 15*l.* or 20*l.*, and I have known as much as 40*l.* and 50*l.* to be paid for one. They will not stand a cross with any other breed; the spaniel, setter, Newfoundland dog, and Labrador dog, &c., perfectly destroy coat, ears, tail, and symmetry; added to which, the cross-bred dog is very difficult to dry. If any cross would answer, I should say the bloodhound, which would give at least head, and ears, and nose. I have bred with the greatest care, giving the highest prices for good dogs to cross my own. I still have a first-rate bitch of the breed. It is essential for gentlemen purchasing puppies to see both sire and dam, as in this breed it is very easy to be imposed upon in a young one. The true breed has become very scarce; and although very hardy when grown up, they are very delicate as puppies.—J. M'C.

The celebrated "Doctor" family, which have carried away all the prizes of late years, answer fully to the above description which is beautifully rendered by Mr. Earl.

The *poodle* was probably originally a water spaniel, but he is now used solely as a house dog, in this country at all events. See Chap. VI.



The English Sheep-Dog. (Youatt.)

## CHAPTER V.

PASTORAL DOGS, AND THOSE USED FOR THE PURPOSES OF DRAUGHT.

The English Sheep-Dog. — The Colley. — The Drover's Dog. — The German Sheep-Dog. — Pomeranian Wolf-Dog. — The Newfoundland and Labrador Dogs. — The Esquimaux Dog. — The Greenland Dog. — The Iceland and Lapland Dogs.

### THE ENGLISH SHEEP-DOG.

THE English sheep-dog is tolerably represented in the annexed engraving, but there are so many different breeds that it is difficult

to describe him very exactly. He has a sharp muzzle, medium-sized head, with small and piercing eyes; a well-shaped body, formed after the model of a strong low greyhound, but clothed in thick and somewhat woolly hair, which is particularly strong about the neck and bosom. The tail is naturally long and bushy, but, as it has almost invariably been cut off until of late years, its variations can hardly be known. Under the old excise laws the shepherd's dog was only exempt from tax when without a tail, and for this reason it was always removed; from which at last it happened that many puppies of the breed were born without any tails, and to this day some particular breeds are tailless. In almost all sheep-dogs there is a double dew-claw on each hind leg, and very often without any bony attachment. The legs and feet are strong and well formed, and stand road-work well, and the untiring nature of the dog is very remarkable. The colour varies greatly, but most are grey, or black, or brown, with more or less white.

Such is the true old English sheep-dog, but a great proportion of those in actual use are crossed with the various sporting dogs, such as the setter, which is very common, or the pointer, or even the hound; and hence we so often find the sheep-dog as good in hunting game as in his more regular duties, while a great many are used as regular poaching dogs by night, and in retired districts by day also.

---



The Colley. (Youatt.)

### THE COLLEY.

One of the most beautiful and useful of all our dogs is the Scotch sheep-dog or colley, an excellent engraving of which heads this article. With a fine muzzle he combines an intelligent-looking and rather broad head, and a clear but mild eye, a pricked and small ear slightly falling at the tip. His body is elegantly formed, and clothed with a thick coat of woolly hair, which stands out evenly from his sides and protects him from all

the vicissitudes of the weather, neither wind, rain, nor snow being capable of penetrating it. The legs are well formed and the feet strong and useful. The tail is long, gently curved, and bushy, and the whole outline resembles that of the dingo; but the form is stouter and the limbs stronger. The colour is nearly always black and tan, with little or no white; sometimes, however, the whole skin is of one or other of these colours, but then the dog is not considered nearly so valuable. The colley, like the true English sheep-dog, has always one or two dew-claws on each hind leg. The sagacity and perseverance of this dog are wonderful, and the instances in which he has succeeded in saving sheep and lambs under perilous circumstances are beyond all description.

---

#### THE DROVER'S DOG.

This is a mixed breed, being a cross between the sheep-dog and the mastiff or hound, or sometimes the greyhound, pointer, or setter. In the grazing counties he is of great size and strength, and some strains are highly valued; but they differ so much as to be incapable of being distinguished from other breeds.

---

## THE GERMAN SHEEP-DOG

Is a small-sized dog, with bushy tail carried over the back, small muzzle, and shaggy coat, which is generally black or light fawn. His manner is brisk and affectionate, and his tractability is great, so that he is most useful in his vocation, and as a companionable dog is not excelled.

---

## THE POMERANIAN WOLF-DOG.

This variety is used to protect the sheep from the wolf. His head is long, with a pointed muzzle, and short pricked ears. He is a large wolf-like dog in shape, with long silky hair on the body and tail, but short on the head, legs, and ears. The colour is black, white, grey, fawn, or sometimes yellow. If of the lighter colours the ears and muzzle are of a darker tint. Tail long and spirally curled.

---



The Larger Newfoundland Dog. (Yolatt.)

### THE NEWFOUNDLAND.

This most valuable animal is of three very different kinds, viz. :  
1. The true Newfoundland ; 2. The large, loose-made, and long-haired variety, known as the Large Labrador ; and, 3. The small, compact, and comparatively short-haired dog, known as the St.



John's or Lesser Labrador breed. All were originally natives of Newfoundland, and though many are bred in England, fresh specimens are constantly being imported from the island. Many of the naturalised strains are now more or less crossed with the mastiff or setter. In this country they are chiefly used for ornamental purposes and as companions to their masters, the small breed being also crossed with the setter to make the retriever; but in their native country they are used to draw timber over the snow in the winter months, being harnessed to carts and sledges made for the purpose. In intelligence the three breeds are about equal, all being celebrated for their faculty of learning to fetch and carry. This is sometimes developed to such an extent that a well-trained dog will go back for anything which his master has pointed out to him, if it has been handled, when it is only necessary to order him back to "seek," and he will find it by the scent. Many amusing instances of this are told, one of which we have heard on good authority, but which is almost beyond belief. A lady was most anxious to obtain a particular object from her lover, which he had strong reasons for refusing to her; but being at length teased into complying he gave it her, and after parting, at some distance from her home, he fetched his dog and ordered him to "go seek." The intelligent creature at once started off on the heel of his master, and, overtaking the lady still carrying the *gage d'amour*, he laid hold of it and brought it back in triumph. The dispossessed fair one, not having the least idea whose dog it was, and being ashamed to own how she had lost it, said nothing about the matter, and so the gentleman for once outwitted the lady in this stage of their

courtship; whether the tables were turned afterwards, and the dog was enlisted in her service, we know not. Both breeds are good water dogs and bear immersion for a long time, but the large variety having a more woolly coat is superior in endurance of wet and cold. Hundreds of anecdotes are told of extraordinary escapes from drowning by means of these dogs, their tendency to fetch and carry being doubly useful here. Children and light small women may be intrusted to them with safety in the water, if they are not bewildered with fear, when they will sometimes cling round the dog's neck, and frustrate all his efforts to restore them to the land by swimming; generally, however, in cases of recovery, the person has fainted, and being then powerless is towed ashore readily enough. The speed with which the Newfoundland swims is very great, his large legs and feet enabling him to paddle himself with great force. From their great size and strength they are able to beat off most dogs when they are attacked, and their thick coats prevent the teeth of their assailants from doing much damage; but in offensive measures they are of little use, being rather unwieldy, and soon winded in a desperate struggle. Hence they are not useful in hunting the large kinds of game, nor the bear, wolf, or tiger. The nose is delicate enough to hunt any kind of scent, but as they soon tire they are not used in this way, and it is solely as retrievers on land or water that they are useful to the sportsman, being generally crossed with the setter for the former, and the water spaniel for the latter element.

The *characteristic points* of the Large Newfoundland are, great size, often being from 25 to 30 inches high; a form proportion-

ally stout and strong, but loosely put together, so that there is a general want of compactness, especially about the loins, which are long and very flexible. The head is not large in comparison to the size, but wide across the eyes; muzzle of average length and width, and without any flews, as in the hounds and pointers; eye and ear both small, the latter falling, and without much hair on it; neck short and clothed with a ruff of hair; tail long, curled on itself slightly, and woolly; legs very strong, but not feathered; feet large and rather flat, bearing the road badly; coat on the body long, hairy, shaggy, and shining, without any admixture of wool; the colour should be black, but it is sometimes black and white, or white with little black, or liver colour, or a reddish dun, or sometimes, but rarely, a dark brindle not very well marked.

The *Large Labrador* is a more loosely-framed animal, and is never entirely black, being more or less mixed with white. The coat also is longer, more woolly, and curly.

The *St. John's*, or *Smaller Labrador*, or *Newfoundland*, the three names being used indiscriminately, is seldom more than 25 inches high, and often much less. The head is larger in proportion to his size, and the ear also slightly fuller; neck longer; body far more compact, and clothed with shorter hair, shining, and without any woolly texture; tail similar in shape, but the hair less woolly; legs and feet also better adapted for work; colour almost always a jet black, rarely liver-coloured. This dog is now generally more or less crossed with the setter. The specimen which is here engraved is not particularly well marked, but I have been unable to obtain a better, and therefore give it as the nearest approach

to the true breed, which is now very scarce. The dog was bred by the celebrated "Bill George," of Kensall New-town, who considers him to be a pure Small Labrador; but according to my own opinion his coat is too curly for perfect purity of blood, and he



"BILLY," a St. John's or Lesser Labrador dog.

is probably crossed with the setter, or perhaps with the spaniel. I have lately been shown several of these dogs which were said to have been recently imported, but all were evidently crossed with other breeds, and were therefore rejected.



The Esquimaux Dog. (Youatt.)

### THE ESQUIMAUX DOG.

This dog is the only beast of burden in the northern parts of the continent of America and adjacent islands ; being sometimes employed to carry materials for hunting, or the produce of the chase, on his back ; and at others he is harnessed to sledges in teams varying from 7 to 11, each being capable of drawing a hundred-weight for his share. They are harnessed to a single yoke-line by a breast-strap, and, being without any guide-reins, they are

entirely at liberty to do what they like, being only restrained by the voice of their master, and urged forward by his whip. A single dog of tried intelligence and fidelity is placed as leader, and upon him the driver depends for his orders being obeyed. In the summer they are most of them turned off to get their own subsistence by hunting, some few being retained to carry weights on their backs; sledges are then rendered useless by the absence of snow; and, as there is a good subsistence for them from the offal of the seal and the walrus which are taken by the men, the dogs become fat at this season of the year. The Siberian and Greenland dogs are nearly similar to those of Kamtschatka, but somewhat larger, and also more manageable, all being used in the same way. The Esquimaux dog is about 22 or 23 inches high, with a pointed fox-like muzzle, wide head, pricked ears, and wolf-like aspect; the body is low and strong, and clothed with long hair, having an undercoat of thick wool; tail long, gently curved, and hairy; feet and legs strong and well formed; the colour is almost always a dark dun with slight disposition to brindle, and black muzzle.

---

## ICELAND AND LAPLAND DOGS.

These are nearly similar to the Esquimaux, but rather larger, more wolf-like, and far less manageable.

## CHAPTER VI.

### WATCH DOGS, HOUSE DOGS, AND TOY DOGS.

Bulldog.—Mastiff, Cuban and English.—Mount St. Bernard.—Thibet Dog.—Poodle.—Maltese Dog.—Pomeranian or Spitz.—Lion Dog.—Shock Dog.—Toy Spaniels.—Toy Terriers.—The Pug Dog.—Italian Greyhound.

THE peculiarity of this division is that the dogs composing it are solely useful as the companions or guards of their owners, not being capable of being employed with advantage for hunting, in consequence of their defective noses, and their sizes being either too large and unwieldy, or too small, for that purpose. For the same reason they are not serviceable as pastoral dogs or for draught, their legs and feet, as well as their powers of maintaining long-continued exertion, being comparatively deficient. These dogs nearly all show a great disposition to bark at intruders, and thereby give warning of their approach; but some, as the bulldog, are nearly silent, and their bite is far worse than their bark. Others, as, for instance, the little house dogs, generally with more or less of the terrier in them, are only to be used for the purpose of warning by their bark, as their bite would scarcely deter the most timid. The varieties are as follows:—

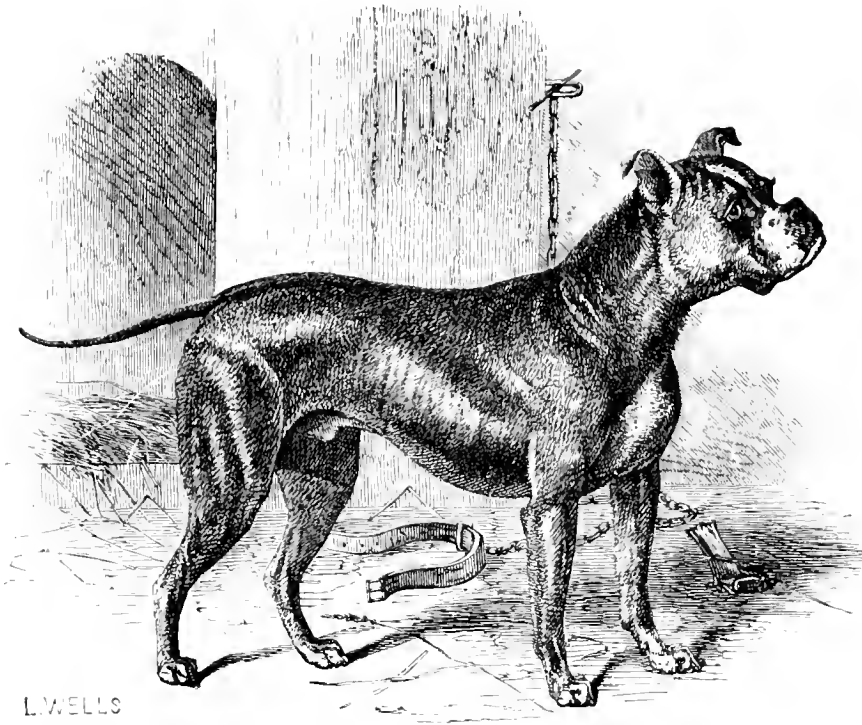

“Tor,”\* a pure Bulldog, the property of C. Stockdale, Esq., Shepherd’s Bush.

### THE BULLDOG.

F. Cuvier has asserted that this dog has a brain smaller in proportion than any other of his congeners, and in this way accounts for his assumed want of sagacity. But, though this authority is deservedly high, I must beg leave to doubt the fact as well as the inference, for if the brain is weighed with the body of the dog from which it was taken, it will be found to be relatively

\* For the following pedigree of this bulldog I am indebted to his owner



above the average, the mistake arising from the evident disproportion between the brain and the skull. For the whole head, including the zygomatic arches and cheek-bones, is so much larger than that of the spaniel of the same total weight of body, that the brain may well look small as it lies in the middle of the various processes intended for the attachment of the strong muscles of the jaw and neck. I have never been able to obtain the fresh brain of a pure bulldog for the purpose of comparison, but, from an examination of the skull, I have no doubt of the fact being as above stated. The mental qualities of the bulldog may be highly cultivated, and in brute courage and unyielding tenacity of purpose he stands unrivalled among quadrupeds, and with the single exception of the game-cock, he has perhaps no parallel in

C. Stockdale, Esq., Shepherd's Bush, who has compiled it from authentic sources :—

*Pedigree of Mr. Stockdale's "Top."*

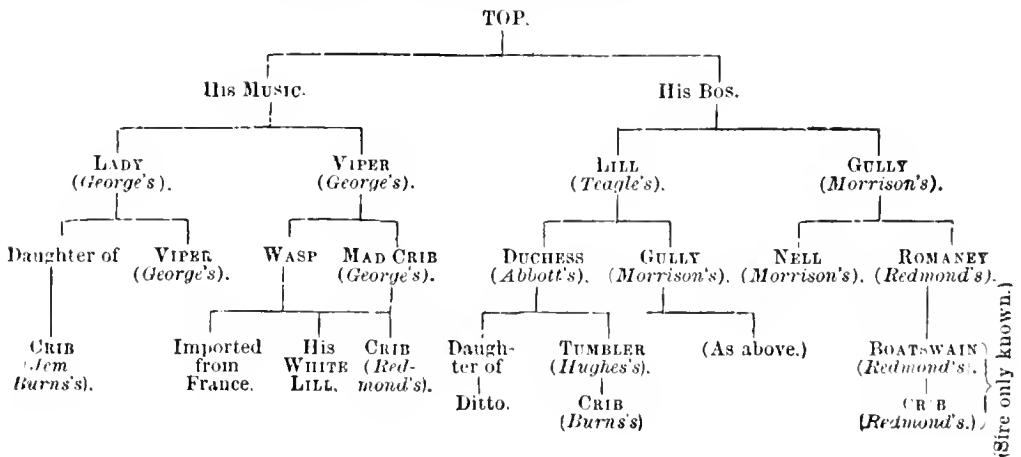

these respects in the brute creation. Two remarkable features are met with in this breed: Firstly, they always make their attack at the head; and, secondly, they do not bite and let go their hold, but retain it in the most tenacious manner, so that they can with difficulty be removed by any force which can be applied. Instances are recorded in which bulldogs have hung on to the lip of the bull (in the old days of baiting this animal) after their entrails had been torn out, and while they were in the last agonies of death. Indeed when they do lay hold of an object, it is always necessary to choke them off, without which resource they would scarcely ever be persuaded to let go. From confinement to their kennels, they are often deficient in intelligence, and they can rarely be brought under *good* control by education; and, from the same circumstance, they show little personal attachment, so that they are almost as likely to attack their friends as their enemies in their fury when their blood is put up. Many a bulldog has pinned his master's leg in revenge for a tread on his foot, and it is very seldom that liberties can be taken with him by any one. There is an old story strongly characteristic of this tendency, which will illustrate this passion for pinning, and also the fondness of the lower orders in some districts for the fighting and baiting propensities of their dogs. A Staffordshire coal-miner was one day playing with his bulldog, an unentered puppy, when the animal became angry and pinned his master by the nose. On this the by-standers became alarmed, and were going to treat the dog roughly, when the owner interfered with—"Doan't touch un, Bill; let un teaste blood, an it 'll

be the meaking on him." And so the puppy was allowed to hang on and worry his master's nose to his heart's content.

But, when differently treated, the bulldog is a very different animal, the brutal nature which he so often displays being mainly attributable to the savage human beings with whom he associates. Although, therefore, I am ready to admit that the bulldog often deserves the character for ferocity which he has obtained, yet I contend that this is not natural to him, any more than stupidity and want of affection, which may readily be proved to be the reverse of his character, if any one will take the trouble to treat him in a proper manner. For the following remarks I am mainly indebted to Mr. Stockdale, who is a celebrated breeder of bulldogs, and has had a long experience of their various attributes. The antiquity of the breed is unquestionable, and it has always been peculiar to these islands, the Spanish variety having originally been procured from Britain. It is highly probable that the modern bulldog has undergone a change in appearance during the last fifty years, being now decidedly neater in shape than was formerly the case, if we are to judge from the portraits handed down to us. As now exhibited, he is a remarkably neat and compact animal naturally, the deformities sometimes seen being produced principally from the practice of constantly keeping the poor dog tied up with a short chain. It is amusing to any one who has any knowledge of these dogs to read the terrible accounts of their ferocity in various books purporting to give us an insight into canine nature in general, but as these for the most part are merely copies of each other, too much weight

need not be attached to them. The only evil of such books is that they find their way into the hands of inexperienced persons, who are easily imposed on by bold assertion. Surely no animal has suffered more at the hands of his would-be historians than the dog, the books on him being composed, one half of improbable stories of his exploits, and the other of silly conclusions from them. Most writers, whether political or otherwise, are fond of dilating on the "Bulldog courage" of Englishmen, yet, in the same breath, they vilely asperse the noble animal from whom they draw their simile. The bulldog has been described as stupidly ferocious, and showing little preference for his master over strangers; but this is untrue, he being an excellent watch, and as a guard unequalled, except perhaps by the bull-mastiff, a direct cross from him. Indeed, he is far from being quarrelsome by nature, though the bull-terrier in many cases undoubtedly is so, and I fancy that some writers have taken their description from this dog rather than from the pure bulldog, which has been at all times rather a scarce animal. If once the pure breed is allowed to drop, the best means of infusing fresh courage into degenerate breeds will be finally lost, except with the addition of extraneous blood which may not suit them; for I believe that every kind of dog possessed of very high courage owes it to a cross with the bulldog; and thus the most plucky greyhounds, foxhounds, mastiffs, pointers, &c., may all be traced to this source. Though bull and badger baiting may not be capable of extenuation, to them we owe the keeping up of this breed in all its purity; and though we may agree to discontinue

these old-fashioned sports, yet, I am sure, my brother-sportsmen will see the bad taste of running down a dog who, with all his faults, is not only the most courageous *dog*, but the *most courageous animal in the world*.

The *points* of a well-bred bulldog are as follows. The head should be round, the skull high, the eye of moderate size, and the forehead well sunk between the eyes, the ears semi-erect and small, well placed on the top of the head, rather close together than otherwise, the muzzle short, truncate, and well furnished with chop; his back should be short, well arched towards the stern, which should be fine and of moderate length; many bulldogs have what is called a crooked stern, as though the vertebræ of the tail were dislocated or broken. I am disposed to attribute this to in-breeding. The coat should be fine, though many superior strains are very woolly-coated; the chest should be deep and broad, the legs strong and muscular, and the foot narrow and well split up like a hare's.

---



The Cuban Mastiff. (Youatt.)

### THE MASTIFF.

There is every reason to suppose that this is an indigenous breed, like the bulldog, for though the Cuban mastiff closely resembles it, yet the latter is to all appearance crossed with the bloodhound (see cut).

The *English mastiff* is a fine noble-looking animal, and in temper is the most to be depended on of all the large and power-

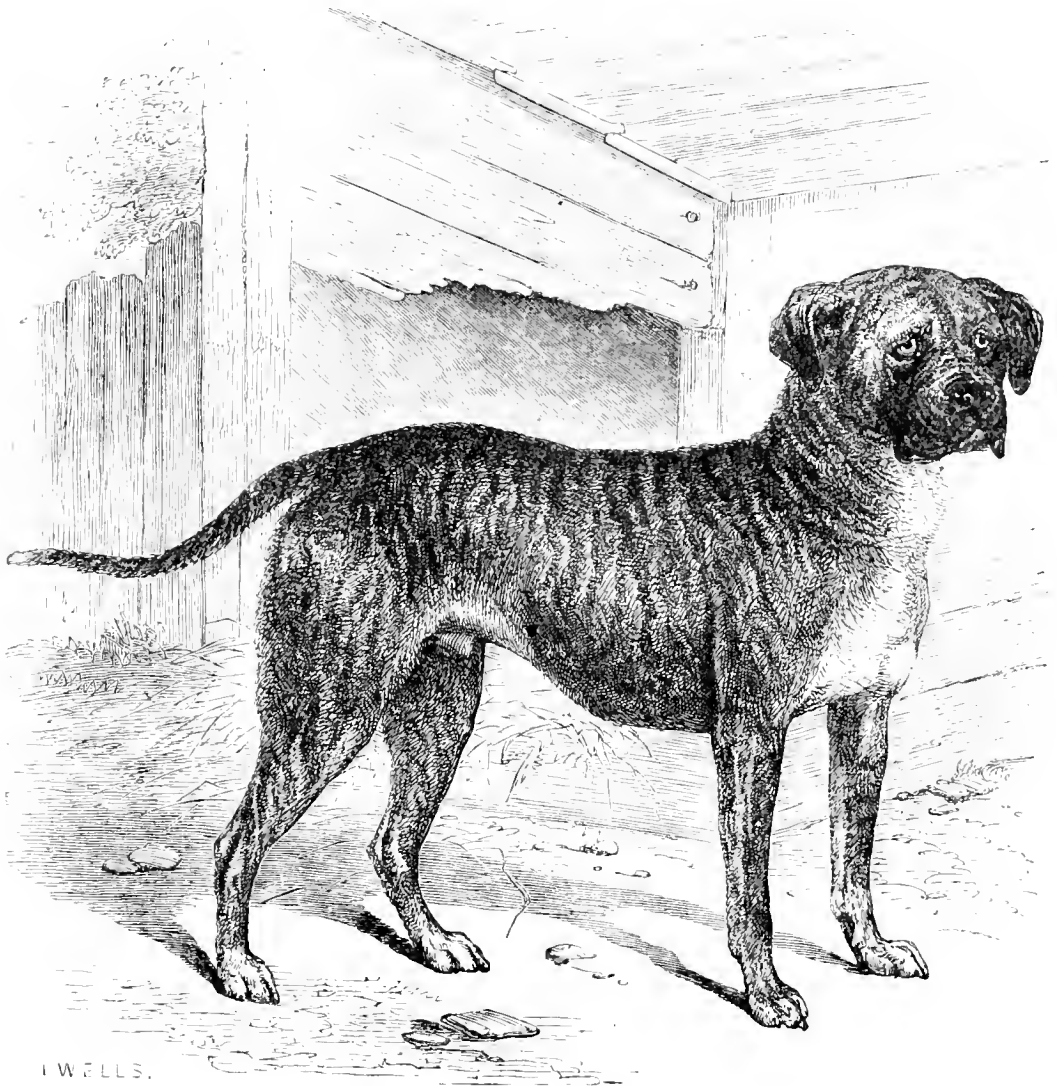

“WALLACE,” an English Mastiff, the property of T. Lukey, Esq., of Morden.

ful dogs, being extremely docile and companionable, though possessed of the highest courage. When crossed with the New-

foundland or bloodhound they answer well as yard-dogs, but the produce is generally of a savage nature, while the pure breed is of so noble and mild a nature that they will not on any provocation hurt a child or even a small dog, one of their most remarkable attributes being their fondness for affording protection. Mr. Lukey of Morden, Surrey, has a very fine breed of the pure mastiff, an engraving of one of which accompanies this article, together with his account of the mode in which he obtained the blood.\*

The English mastiff is a most useful watch dog, and is so capable of attachment to the person of his master, and so completely under control, that he makes a most excellent night-guard to the game-keeper, for which purpose he is much used in this country, especially crossed with the bulldog, to give extra courage. This cross is, however, not to any great extent, and many true mastiffs are used for the purpose. The well-known

\* "In 1835 I bought of the late Geo. White, of Knightsbridge, a brindled mastiff bitch, at a high price (40*l.*), from the Duke of Devonshire's stud. I bred from her with a fawn black-muzzled dog, 'Turk,' the property of the late Lord Waldegrave, a splendid high-couraged dog. I kept two brindled bitch pups; and with great interest and considerable cost I obtained the use of 'Pluto,' the Marquis of Hertford's well-known mastiff dog, considered by judges the finest and best-bred dog of his day, and valued immensely by the Marquis. I have not had any other cross but the 'Turk' and 'Pluto' breed, having kept bitches from the one and dogs from the other. 'Wallace,' the grandsire of the dog engraved, was an immense animal, standing 33 inches at the shoulder, 50 inches round the body, and weighed 172 lbs. The Ne-paulese Princes bought his brother and sister at eight months old, and gave 105*l.* for them. The late Pasha of Egypt for five successive years had two pair of whelps (brindled) sent spring and autumn from Southampton.—T. L."



Bill George is also celebrated for his breed of mastiffs; but in modern days (1860-70) Mr. Edgar Hanbury has produced the finest specimens of this breed.

The *points* of the mastiff are:—A head of large size between that of the bloodhound and bulldog in shape, having the volume of muscle of the latter, with the flews and muzzle of the former, though, of course, not nearly so deep; the ear being of small size but drooping, like that of the hound. The teeth generally meet, but if anything there is a slight protuberance of the lower jaw, never being uncovered by the upper lip like those of the bulldog. Eye small. In shape there is a considerable similarity to the hound, but much heavier in all its lines. Loin compact and powerful, and limbs strong. Tail very slightly rough, and carried high over the back when excited. Voice very deep and sonorous. Coat smooth. Colour red or fawn with black muzzle, or brindled, or black; or black, red, or fawn and white, the latter mixture objected to. Height about 28 to 31 inches.



The Mount St. Bernard Dog. (Youatt.)

THE MOUNT ST. BERNARD DOG.

Closely allied to the mastiff, but resembling the Newfoundland in temper and in his disposition to fetch and carry, is the Mount St. Bernard breed, until lately confined to the Alps and

the adjacent countries, where he is used to recover persons who are lost in the snow-storms of that inclement region. Wonderful stories are told of the intelligence of these dogs and of the recovery of travellers by their means, which are said to extend almost to the act of pouring spirits down the throats of their patients; but, however, there is no doubt that they have been and still are exceedingly useful, and the breed is kept up at the monastery of Mount St. Bernard. The height is about 28 to 31 inches; length six feet, including the tail. The coat varies a good deal in length, there being in England two distinct varieties founded upon this point, viz. the rough and the smooth. Mr. Macdona, who has been at great trouble and expense to import both of the best Swiss strains, leans to the rough, but there are many who still adhere to the smooth variety. The smooth dog is red and white, or brindled and white, a broad white collar of white of a peculiar shape distinguishing the true breed. The rough dog is most highly prized when of a deep tawny brindle, still with some white, but not so much as in the smooth kind. Both dogs are remarkably good-tempered, and may be trusted with the care of women or children with great dependence. The absence of dew claw on the hind leg is considered a defect by some judges, and there is no doubt that many imported specimens of the breed have the double dew claw.



The Thibet Dog. (Youatt.)

### THE THIBET DOG.

This animal, as before remarked, resembles the English mastiff in general appearance, and, being also put to the same use, the two may be said to be nearly allied. According to Mr. Bennet, he is bred on the Himalaya Mountains, on the borders

of Thibet, for the purpose of guarding the flocks and the women who attend them.

The portrait annexed sufficiently describes the shape of this dog, whose colour is a dark black, and his coat is somewhat rough.

---

#### THE POODLE.

The engraving given on next page represents the poodle with the whole of his coat on, but he is generally to be seen shaved in part, so as to resemble the lion in having a mane, and the tip of his tail also having a tuft left on. He is by many supposed to be the produce of a cross between the water and land spaniels, but there is no good reason to suppose that the breed is not quite as distinct as either of them. For many years it has been known in France and Germany, particularly the former country, and it is there occasionally used for sporting purposes, though, as in England, it is chiefly as a companion that this dog is kept. With more intelligence than falls to the lot of any other dog, he unites great fidelity to his master, and a strong love of approbation, so that he may readily be induced to attempt any trick which is shown him, and the extent to which he may be taught to carry out the secret orders of his instructor is quite marvellous. He fetches and carries very readily, swims well, and has a good

nose, but has no particular fondness for hunting game, often preferring a stick or a stone to a hare or pheasant. Two of these dogs which were exhibited in London, in 1829, astonished



The Poodle. (Youatt.)

every one by their clever performance, sitting up to table gravely, and playing a game at cards as quickly as a human being, the cards being placed before them, and the one to be played being selected by the dog's foot. Of course this was all done

by preconcerted signal, but nevertheless it was remarkably well managed, and showed a degree of intelligence and discipline worthy of a better purpose. Dancing dogs are also generally poodles, and indeed nearly all canine actors are of that description, including Sir Bulwer Lytton's impersonation of the tribe in "What will he do with it," where the character of "Sir Isaac" is drawn to the life.

The poodle *is characterised* by a large wide head, rising sharply at the forehead, long falling ears clothed with thick curly hair, rather small eyes, square muzzle, with a liberal allowance of jowl, and a sedate appearance till roused by any prospect of fun. A well-formed pointer-like body, but covered with thick closely curling hair, hanging down in ringlets below; tail usually cropped more or less, naturally covered with crisp curls. Legs straight, and covered all round with hair hanging in short ringlets. Feet small and round, and moderately hairy. Colour white or black, or white and black. Height from 16 to 20 inches.

The *barbet* is merely a small variety of the poodle, which it resembles in all respects but size.

---



“PSYCHE,”\* a Maltese Bitch, the property of Miss Gibbs, of Morden.

#### MALTESE DOG.

This beautiful little dog is a Skye terrier in miniature, with, however, a far more silky coat, a considerably shorter back, and a tail stiffly curved over the hip.

\* “Psyche,” the original of the engraving, was bred by Mr. Lukey, of Morden, direct from the parent stock, being by “Cupid” out of “Psyche,” who were both brought from Manilla in 1841, and bought there at a high price by Captain Lukey, of the East India Company’s service. They were intended as a present for the Queen, but after being nine months on board



*Points.*—The weight should never exceed 5 or 6 lbs. Head closely resembling that of the Skye, but with more shining and silky hair. Coat as long as that dog's; but more transparent and silky. Actions lively and playful, and altogether rendering it a pleasing pet. The tail is curved over the back, very small and short, with a brush of silky hair. Colour white, with an occasional patch of fawn on the ear or paw. The breed was so scarce some time ago, as to induce Sir E. Landseer to paint one as the last of his race; since which several have been imported from Malta, and, though still scarce, they are now to be obtained. The little bitch from which the above portrait was sketched is the property of Miss Gibbs, of Morden, and is descended from parents imported by Mr. Lukey direct from Manilla.

---

#### THE POMERANIAN OR SPITZ DOG.

This cheerful little dog is extremely common on the Continent of Europe, where it goes by the name of *Loup-loup*. Until lately

ship were found on their arrival in England not presentable, from their coats having been entirely neglected during the voyage. "Psyche" is now twenty months old, pure white, weighs  $3\frac{1}{2}$  lbs., measures in length of hair across the shoulders 15 inches, and when in her gambols presents in appearance a ball of animated floss silk, her tail falling on her back like spun glass. Of all the canine pets this breed is the most lovable, being extremely animated and sagacious, full of natural tricks, and perfectly free from the defects of the spaniel, viz. snoring and an offensive breath, being naturally cleanly and capable of instruction.

it was very rare in England, but within the last twenty years it has become very common as a house dog. It is not recognised, however, by the fanciers, and is not prized highly by any one,

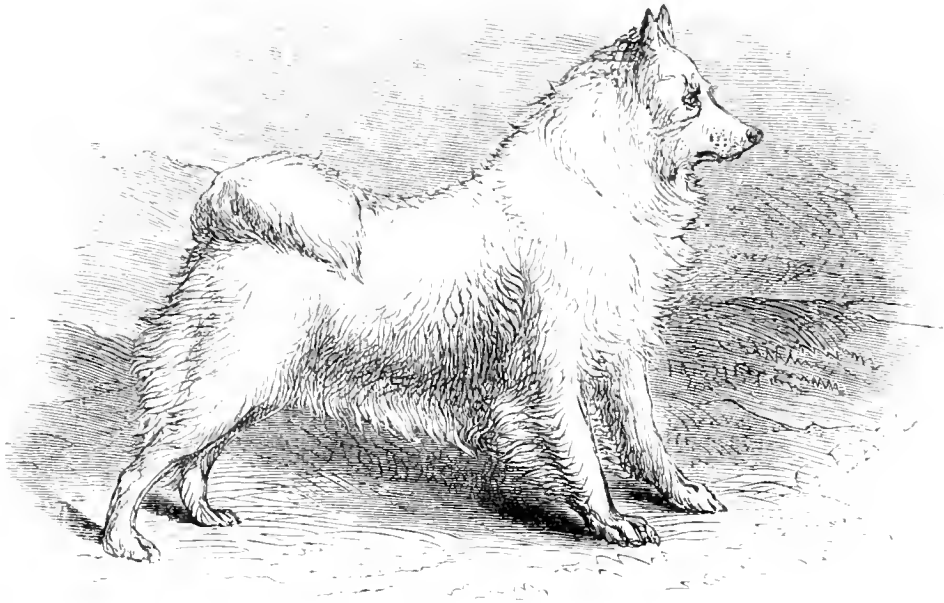

Pomeranian, or Spitz Dog.

being of no use but as a companion. The head is very fox-like, with pricked ears and a sharp nose; neck thick, and covered with a ruff of woolly hair; body also clothed with thick woolly hair, not curled; legs free from hair. Tail carried high, and curled over the back, but not so closely as that of the pug dog. Colour generally white, sometimes a pale cream colour, and more rarely black.

---

### THE LION DOG.

This toy dog appears to be crossed between the poodle and the Maltese dog, being curly like the former, but without his long ears and square visage. He is now very seldom seen in this country, and is not prized among fanciers of the canine species. Like the poodle he was generally shaved to make him resemble the lion.

---

### THE SHOCK DOG.

This dog also is now almost unknown. But formerly he was very generally kept as a toy dog. He is said to have been a cross between the poodle and small spaniel, both of which varieties he resembled in part.

---

### TOY SPANIELS.

Two breeds are known and recognised under this head, namely, the King Charles and the Blenheim spaniels, the former being slightly the larger of the two, and by most people considered the more handsome. To an ordinary observer the chief points of distinction in the King Charles are, the colour, which is black and tan more or less mixed with white, the less the better; and the length

of the ears, which is greater than in the Blenheims; these being also lighter in frame, and always yellow or red and white. Both are small delicate dogs, and though they have pretty good noses, and will hunt game readily, yet they so soon tire that they are rarely used for the purpose, and are solely kept for their ornamental

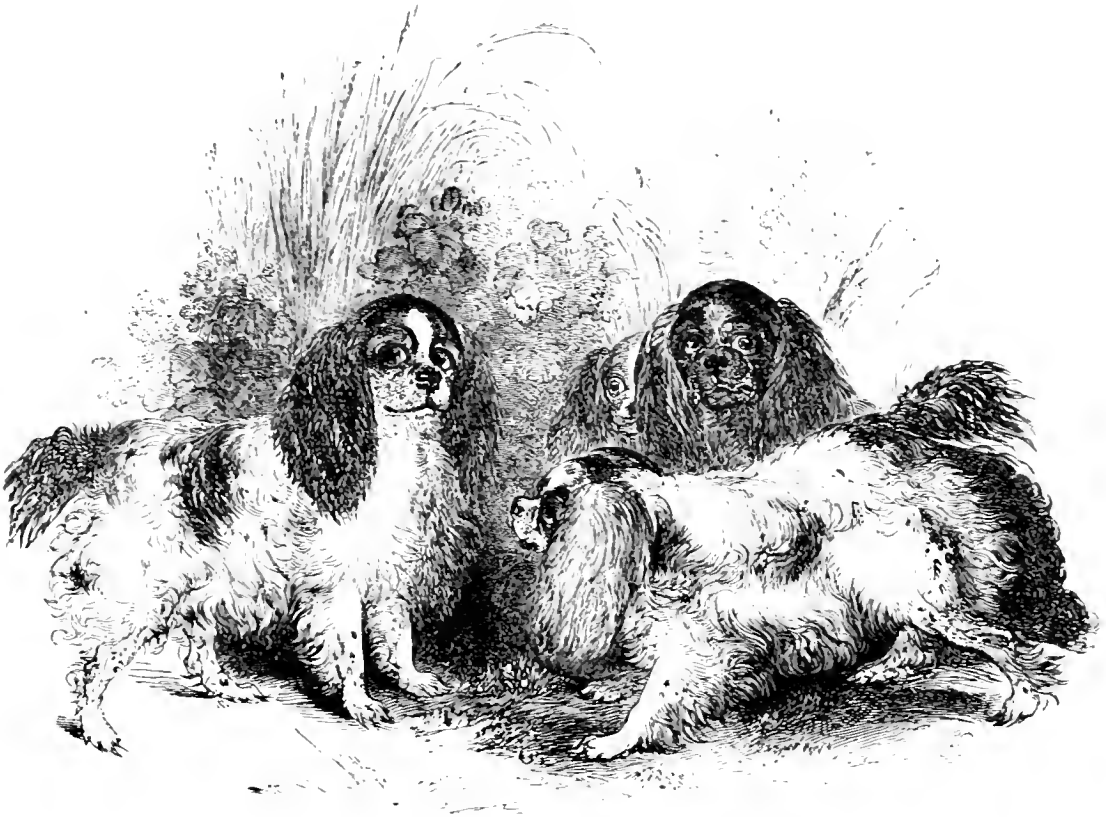

The King Charles and Blenheim Spaniels. (Youatt.)

properties. They make good watch dogs in-doors, barking at the slightest noise, and thus giving notice of the approach of improper persons; nor, though they are somewhat timid, are they readily silenced, as their small size allows of their retreating beneath chairs and sofas, from which asylum they keep up their sharp and

shrill note of defiance. The great objection to these handsome little creatures as pets is that they follow badly out of doors, and as they are always ready to be fondled by a stranger, they are very liable to be stolen. Hence many people prefer the toy terrier, or the Skye, which is now introduced very extensively as a toy dog, and might with equal propriety be inserted in this chapter, as in that which he occupies. The King Charles and Blenheim spaniels are often crossed, and then you may have good specimens of each from the same litter, but if true their colours never vary.

The *points* of the King Charles spaniel are: extremely short muzzle, which should be slightly turned up; black nose and palate; full prominent eye, which is continually weeping, leaving a gutter of moisture down the cheek; a round bullet-shaped head, with a well-marked "stop" between the eyes; very long, full-haired, and silky ears, which should fall close to the cheeks, and not stand out from them. The body is covered with wavy hair of a silky texture, *without curl*; and the legs should be feathered to the toes, the length and silkiness of this being a great point. Tail well feathered, but not bushy; it is usually cropped. The colour should be a rich black and tan, without a white hair; but those marked as in the left-hand dog of the engraving are not to be despised, and sometimes make their appearance in a litter of which both sire and dam had scarcely a white hair. The weight should never exceed 6, or at the utmost 7 lbs.; and they are valued the more if they are as low as  $4\frac{1}{2}$  or 5 lbs.

The *points* of the Blenheim vary very little from those of the King Charles, except in colour, which is always a white ground

with red or yellow spots, and there should be a well-marked blaze of white between the eyes. The ears should be coloured, and also the whole of the head with the exception of the nose and a white mark up the forehead, as is shown in the right-hand figure of the cut, which represents the Blenheim pretty accurately. The palate is black like that of the King Charles; and there is little difference in shape, though an experienced eye could detect the one from the other even irrespective of colour. This dog is generally slightly less than the King Charles.

---

#### THE PUG.

This curly-tailed and pretty little toy dog was out of fashion in England for some years, but has recently come again into such vogue that a good pug will fetch from 20 to 35 guineas. The British breed, however, which is one of those known to have existed from the earliest times, was never entirely lost, having been carefully preserved in a few families. The Dutch have always had a fondness for the pug dog, and in Holland the breed is common enough, but the same attention has not been paid to it as in England, and yellow masks, low foreheads, and pointed noses are constantly making their appearance in them, from the impure blood creeping out, and showing evidences of the crosses which have taken place. For the sketch of the very beautiful pair of these dogs which is engraved on the next page,

I am indebted to one of the first toy dog breeders of the day, Mr. Morrison, of Walham Green, who has been long engaged in bringing his stock to their present state of perfection, and whose

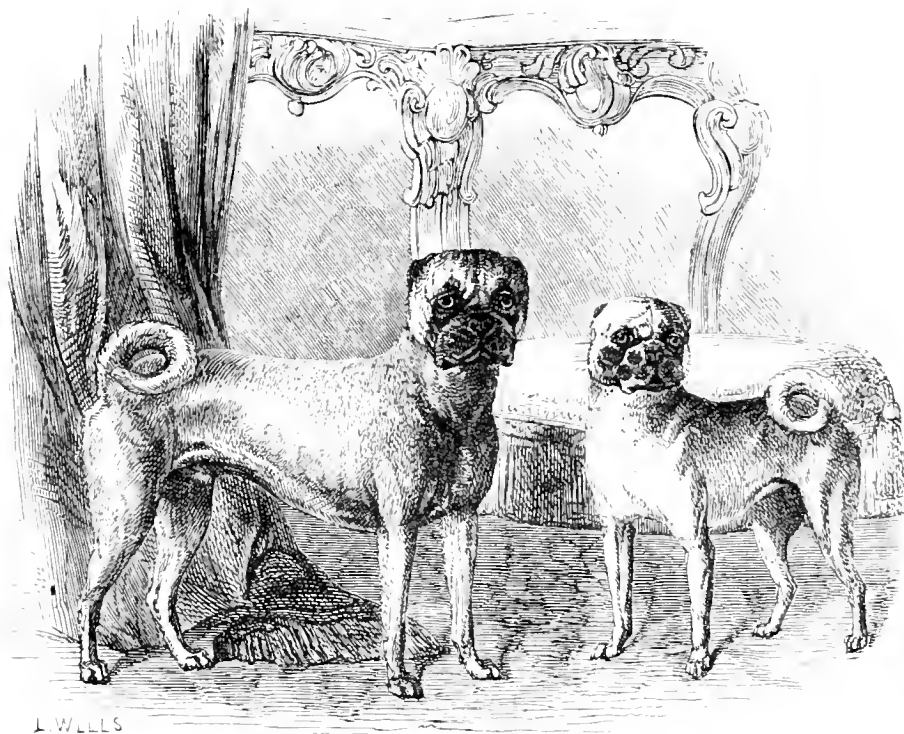

“PUNCH” and “TETTY,”\* Pugs, the property of C. Morrison, Esq., of Walham Green.

admirable management is shown in the healthy appearance of all of them. These dogs are not remarkable for sagacity displayed in any shape, but they are very affectionate and playful, and, like the Dutch and Flemish cows, they bear the confinement of the house better than many other breeds, racing over the carpets in

\* “Punch,” out of Mr. Morrison’s “Minnie;” “Tetty,” out of his “Mouse;” both by his “Charlie.”

their play as freely as others do over the turf. For this reason, as well as the sweetness of their skins, and their short and soft coats, they are much liked by the ladies as pets.

Their *points* are as follows:—General appearance low and thickset, the legs being short, and the body as close to the ground as possible, but with an elegant outline. Weight from 6 to 10 lbs. Colour fawn, with black mask and vent. The clearer the fawn, and the more distinctly marked the black on the mask, which should extend to the eyes, the better; but there is generally a slightly darker line down the back. Some strains have the hair all over the body tipped with “smut,” but on them the mask is sure to shade off too gently, without the clear line which is valued by the fancier. Coat short, thick, and silky. Head round, forehead high; nose short, but not turned up; and level-mouthed. Ears, when cut, cropped quite close, naturally rather short but falling. Neck of moderate length, stout but not throaty. Chest wide, deep, and round. Tail short, and curled closely to the side, not standing up above the back. It is remarkable that the tail in the dog generally falls over the off side, while in the bitch it lies on the near. The legs are straight, with small bone, but well clothed with muscle. Feet like the hare, not cat-footed. No dew-claws on the hind legs. The height is from 11 to 15 inches.

---



## TOY TERRIERS.

These are of the various breeds described under the head of the terrier, but of smaller size than the average, and with great attention paid to their colour and shape. The smooth English terrier, not exceeding 7 lbs. in weight, is much prized; and when he can be obtained of  $3\frac{1}{2}$  or 4 lbs. weight, with perfect symmetry, and a good rich black and tan colour without a white hair, he is certainly a very perfect little dog. The black lines ("penciling") of the toes, and the richness of the tan on the cheeks and legs, are points much insisted on. Most of the toy terriers now sold are either crossed with the Italian greyhound or the King Charles spaniel. If the former, the shape is preserved, and there is the greatest possible difficulty in distinguishing this cross from the pure English terrier; indeed, I am much inclined to believe that all our best modern toy terriers are thus bred. They have the beautiful long sharp nose, the narrow forehead, and the small sharp eye, which characterises the pure breed; but they are seldom good at vermin, though some which I have known to be half Italian have been bold enough to attack a good strong rat as well as most dogs. Many of these half-bred Italians are used for rabbit-coursing, in which there is a limit to weight, but it is chiefly for toy purposes that long prices are obtained for them. When the cross with the spaniel has been resorted to, the forehead is high, the nose short, and the eye large, full, and often weeping, while the general form is not so symmetrical and

compact ; the chest being full enough, but the brisket not so deep as in the true terrier, or in the Italian cross.

The *Skye terrier*, as used for toy purposes, is often crossed with the spaniel to get silkiness of coat. See page 81.

The *points* are as there described.

*Scotch terriers* are seldom used as toys, and are not considered such by the fanciers of the animal.

The *Haliſar Blue tan* terrier is a toy dog, whether the weight is 16 lbs. or 3 lbs., between which every gradation may be found. The colour of the back is a blue sometimes stained with fawn, all the rest of the body being a rich golden tan. The hair is long and silky, always parting down the middle, and very long at the muzzle, from which it hangs like a beard. The shape resembles that of the Scotch terrier.

*The Italian Greyhound* has been already described at page 44.

---

## CHAPTER VII.

## CROSSED BREEDS.

Retriever.—Bull-Terrier.—Lurcher.— Dog and Fox Cross.

ALTHOUGH many of the breeds which have been enumerated in the preceding chapters were most probably originally the produce of crosses between distinct varieties, yet at present they are continued by breeding from a sire and dam of the same kind, whereas, with those which we are now considering, there is constantly a necessity for having recourse to the original breeds. For instance, many breeds of the greyhound are known to be crossed with the bull, and the identical animal with which the cross first commenced is well ascertained, as in the case of Sir James Boswell's "Jason," Mr. Etwall's "Eurus," &c.; so also with the foxhound, though here the particular cross is not so well ascertained, but it is admitted to have taken place within the last century. Yet these are not called mongrels, and the breed, instead of being despised as such, is more highly prized than those of the pure strain which formed one side of the parent stock. The term *mongrel* may more properly be applied to those chance crosses which occur from accident or neglect, the bitch selecting

her own mate, and being guided by caprice, without reference to the fitness of the match in reference to the progeny resulting. Hence we see the monstrosities which disgrace our streets, animals which might puzzle the most learned in dog-lore to say in what proportions they are allied to recognised varieties of the species *Canis*, but which are sometimes highly valuable in point of utility, and are often broken by the poacher to perform the most difficult feats. Indeed, it often happens that a poaching labourer, who is the worst kind of poacher, selects some mongrel in preference to a better-bred dog, in order to escape notice; but the gamekeeper should never despise the most wretched-looking animal on his beat, if the cur has size and strength to do what is required.

#### THE RETRIEVER.\*

In speaking of the retriever, it is generally understood that the dog for recovering game *on land* is meant, the distinct kind known as the water spaniel being already alluded to at page 115. With regard to the propriety of using a separate dog for retrieving in open or covert shooting, there is a great difference of opinion, but this subject will be better considered under the next division of this book, and I shall now confine myself to a description

\* See also Frontispiece.

of the crosses used solely as retrievers, including the ordinary cross between the Newfoundland and setter, and that between the terrier and the water spaniel, which is recommended by Mr. Colquhoun, and which I have found especially serviceable.



Retriever. (Flat-coated.)

The *qualities* which are required in the regular retriever are : great delicacy of nose, and power of stooping (which latter is often not possessed by the pointer) ; cleverness to follow out the windings of the wounded bird, which are frequently most intricate, and puzzle the intelligence as well as the nose to unravel them ; love of approbation, to induce the dog to attend to the

instructions of the master; and an amount of obedience which will be required to prevent his venturing to break out, when game is before him. All these are doubtless found in the retriever, but they are coupled with a large heavy frame, requiring a considerable amount of food to keep it, and space in the dog-cart when he is to be conveyed from place to place. Hence, if a smaller dog can be found to do the work equally well, he should be preferred; and, as I think he can, I shall describe both.

The *large black retriever* is known by his resemblance to the small Newfoundland, and the Irish water spaniel, or setter, between which two he is bred, and the forms of which he partakes of in nearly equal proportions, according to the cross. Hence the modern retriever is distinguished as either the curly-coated or wavy-coated, separate classes being made for them at most of our shows, and sometimes a third depending on colour alone.

The *wavy-coated retriever* has a head like that of a heavy setter, but with shorter ears, less clothed with hair. The body is altogether larger and heavier, the limbs stronger, and the feet less compact, while the loin is much more loose, and the gait more or less resembling in its peculiarities that of the Newfoundland. The colour is almost always black, with very little white; indeed, most people would reject a retriever of this kind, if accidentally of any other colour. The coat is slightly wavy, but not very long or curly; and the legs are not much feathered. The height is usually about 23 or 24 inches, sometimes slightly more or less. This dog can readily be made to set and back; and he will also hunt as well as a setter, but slowly, and lasting for a short time only.

The *curly-coated retriever* is distinguished by having the whole body covered with short crisp curls like those of the Irish water spaniel. The head is quite free from these, a well-marked line being apparent just behind the ears. Like the wavy-coated dog he should have a long deep jaw, and with the exception of the coat the two breeds resemble each other closely. The curly-coated dog is black or deep liver colour, without white.

The *terrier cross* is either with the beagle or the pointer, the former being that which I have chiefly used with advantage, and the latter being recommended by Mr. Colquhoun in his "Lochs and Moors." He gives a portrait of one used by himself, which he says was excellent in all respects; and, from so good a sportsman, the recommendation is deserving of all credit. This dog was about 22 inches high, with a little of the rough coat of the Scotch terrier, combined with the head and general shape of the pointer. The sort I have used is, I believe, descended from the smooth white English terrier and the true old beagle; the nose and style of hunting proclaiming the hound descent, and the voice and appearance showing the preponderance of the terrier cross. These dogs are small, scarcely ever exceeding 10 lbs. in weight, and with difficulty lifting a hare, so that they are not qualified to retrieve "far" any great distance. They must, therefore, be followed when either a hare or pheasant is sought to be recovered. They are mute in "questing," and very quiet in their movements, readily keeping at heel, and backing the pointers steadily while they are "down charge," for as long a time as may be required; and when they go to their game they

make no noise, as is too often done by the regular retriever. They do not carry so well as the larger dog, but in all other respects they are his equal, or perhaps superior; and from their small size they are admissible to the house, and being constant companions are more easily kept under command; besides which, they live on the scraps of the house, while the large retriever must be kept tied up at the keeper's, and costs a considerable sum to pay for his food.

---

#### THE BULL-TERRIER.

Many of our smooth terriers are slightly crossed with the bulldog, in order to give courage to bear the bites of the vermin which they are meant to attack. When thus bred, the terrier shows no evidence of pain, even though half a dozen rats are hanging on to his lips, which are extremely tender parts of the body, and where the bite of a mouse even will make a badly bred dog yell with pain. In fact, for all the purposes to which a terrier can be applied, the half or quarter cross with the bull, commonly known as the "bull-terrier" or "half-bred dog," is of more value than either of the purely bred progenitors. Such a dog, however, to be useful, must be more than half terrier, or he will be too heavy and slow, too much under-jawed to hold well with his teeth, and too little under command to obey the orders of his master. Sometimes the result of the second cross,



which is only one quarter bull, shows a great deal of the shape peculiar to that side; and it is not till the third or fourth cross that the terrier shape comes out predominant: but this is all a matter of chance, and the exact reverse may just as probably hap-

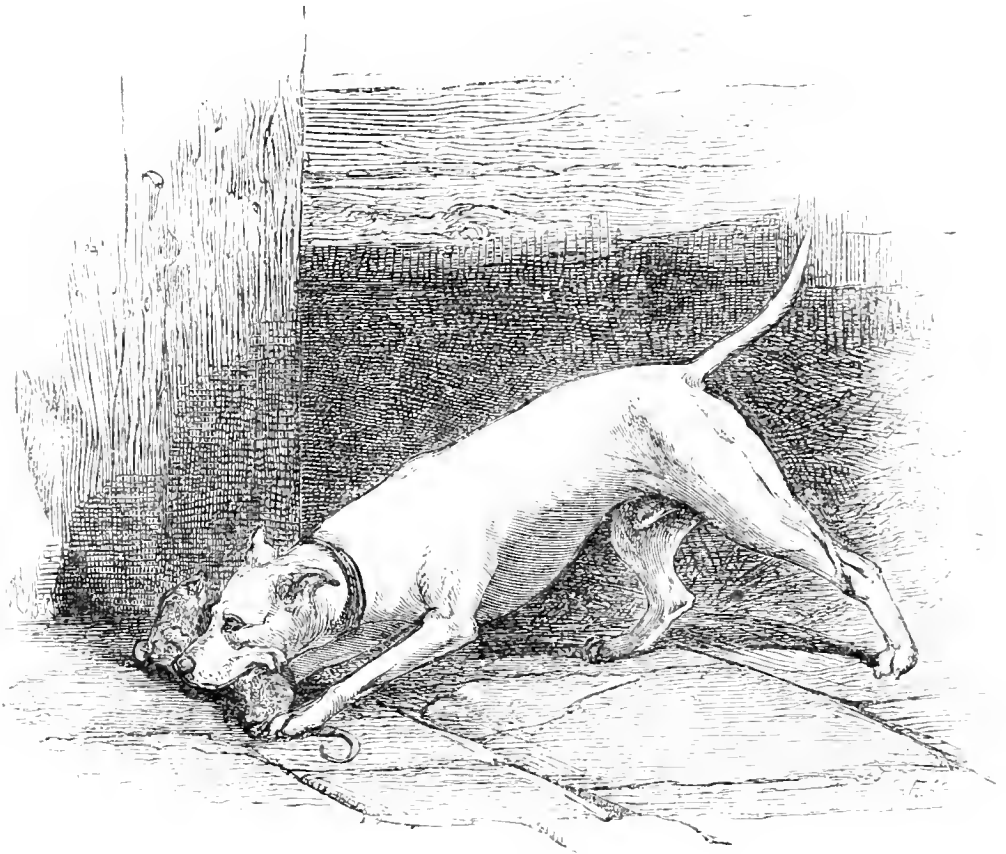

“MADMAN,” Bull-Terrier.

pen, if the terrier was *quite free from the stain of the bull*, which is seldom the case; and this may account for the great predominance of that side in most cases, as we shall see in investigating the subject of breeding for the kennel in the next Book. The field fox-terrier, used for bolting the fox when gone to ground, was of

this breed. So also is the fighting-dog *par excellence*, and, indeed, there is scarcely any task to which a dog of his size may be set that he will not execute as well as, or better than, most others. He will learn tricks with the poodle, fetch and carry with the Newfoundland—take water with that dog, though his coat will not suffer him to remain in so long,—hunt with the spaniel, and fight “till all’s blue.” For thorough gameness, united with obedience, good temper, and intelligence, he surpasses any breed in existence.

The *points* of the bull-terrier vary greatly in accordance with the degree of each in the specimen examined. There should not be either the projection of the under jaw, or the crooked fore legs, or the small and weak hind quarters; and until these are lost, or nearly so, the crossing should be continued on the terrier side. The perfect bull-terrier may, therefore, be defined as the terrier with as much bull as can be combined with the absence of the above points, and showing the full head (not of course equal to that of the bull), the strong jaw, the well-developed chest, powerful shoulders, and thin fine tail of the bull-dog, accompanied by the light neck, active frame, strong loin, and fuller proportions of the hind quarter of the terrier. A dog of this kind should be capable of a fast pace, and will stand any moderate amount of road work. The height varies from 10 inches to 16, or even 20. Colour most admired white, either pure or patched with black, blue, red, fawn, or brindle. Sometimes also black and tan, or self-coloured red.

## THE LURCHER.

Although this dog is not used by the fair sportsman in this country, yet he must be recognised as a distinct and well-known cross. From his great speed, combined with his good nose and his silence, he is *par excellence* the poacher's dog; but he is very little better than the pure-bred greyhound accustomed to the same kind of work, and with the same amount of practice. I have known a great many greyhounds which would never miss a hare if once sighted, or even put on the fresh scent, dropping their noses, and hunting out all the turns of the hare nearly as well as the beagle. Hence it is not to be supposed that the nose of the lurcher is derived from the sheep-dog's side only, for both being good, he may be readily said to owe it to each in due proportions. When the lurcher is bred from the rough Scotch greyhound and the colley, or even the English sheep-dog, he is a very handsome dog, and even more so than either of his progenitors when pure. He is also a most destructive animal, showing speed, sagacity, and nose in an extraordinary degree, from which causes the breed is discouraged, as he would exterminate all the furred game in a very short time. A poacher possessing such an animal seldom keeps him long, every keeper being on the look out, and putting a charge of shot into him on the first opportunity; and as these *must* occur of necessity, the poacher does not often attempt to rear the dog which would suit him best, but contents himself with one

which will not so much attract the notice of those who watch him.

It is needless to describe the *points* of the lurcher, further than to remark that he partakes of those of the greyhound in shape, combined with the stouter frame, larger ears, and rougher coat of the sheep-dog, but varying according to the breed of each employed in producing the cross. Formerly these lurchers were invariably deprived of their tails, in order to pass muster as sheep-dogs, and some are still thus cropped; but as hundreds of these farmer's friends are now suffered to enjoy their full proportions, the lurcher, when he does exist, is also full-tailed. The colour varies greatly, and may be any one of those belonging to either of the breeds from which he springs.

---

THE DROPPER.

This is a cross of the pointer with the setter, which at one time was supposed to be superior to either, but is now seldom met with; for, though the individual is useful enough, he is not ornamental, and has the inconvenience of being unfitted for breeding purposes, the second cross being invariably a failure.



A Dog and Fox crossed Bitch, the property of — Hewer, Esq., of Reading.

#### THE DOG AND FOX CROSS.

It is now generally admitted that the dog and fox will breed together, but so little is known with certainty of the resulting produce that it is scarcely desirable to attempt a minute description. Still it will be perhaps interesting to allude to the best authenticated specimen within my knowledge, which is now the property of Mr. Hewer, of Reading. She is a daughter of the first

cross, which was described by Mr. Tomlin in "Bell's Life" in the year 1855, and is by an ordinary terrier dog.

*Letter by R. Tomlin, Esq., on the subject of the Dog and Fox  
Cross.*

MR. EDITOR,—As your 'Life' is the only 'Old Curiosity Shop' for the reception of 'fancy articles,' I venture to forward you one respecting the fox and dog cross, and, although somewhat out of season, it may, perhaps, prove interesting to the sportsman and the naturalist. In 1853 various accounts appeared in 'Bell's Life in London' of the fox and dog cross, the fact being established by a gentleman of Kent, who then possessed a vulpo-canine bitch which had produce by a dog (*vide* 'Bell's Life,' Dec. 1853 and Feb. 1854). This bitch (half fox, half dog), now in my possession, had produce in the month of February last by a terrier dog. The produce are two dog-whelps and three bitches, some of which were (to ease the dam) suckled by a cur bitch. Two of the litter prove in nature shy as a fox; three of them dog-like in appearance, colour, and perfectly quiet, and follow well at heel. Still, they have the real fox-muzzle and 'fox-action,' about which (to those who have well studied it in the hunting-field) there exists but little mistake. Many there are who doubt the existence of any such animal as that between fox and dog. I am, however, in perfect condition to prove (by the living articles themselves) that the fox is merely a separate species of the *genus* dog, and intercopulates with the bitch, producing not a hybrid or mule animal, but one which will propagate its species to the very end of the chapter.—Yours, &c.

ROBERT TOMLIN.

"Peterborough, June, 1855."

The following letter, sent by Mr. Tomlin to the above paper in 1857, refers to this particular bitch which formed one of the litter therein mentioned:—

*Second Letter on the above Subject.*

“MR. EDITOR,—In 1855 you were good enough to describe in ‘Bell’s Life’ some history of a vulpo-canine bitch in my possession at Peterborough which had bred whelps, and as you are at this period of the year ‘for the fox and nothing but the fox,’ perhaps you can spare a niche in your ‘fancy columns’ for a subject that may not be considered out of season. The vulpo-canine vixen is now, like all the fox genus, in full coat, and a beautiful-looking animal, higher on the leg than our common foxes, with more frame and size, and looks like going a slapping pace, and carries that unmistakable odour which accompanies ‘the beast of stinking flight.’ She bred a litter of whelps in the spring of the years 1855 and 1856 (got by a ‘lion-tawny’-coloured terrier dog), and goes ‘on heat’ only at one regular period. Her produce are endued more or less with the natural shyness and timidity of the vulpine species, and which it appears somewhat difficult to remove. The formation of their heads is faultless—long, and punishing—in fact, the appearance of these animals resembles terrier dogs, with the perfect head and countenance, back, body, and feet of the fox. The vulpo-canine bitch is now suckling four whelps (got by a good white terrier dog), and as their colours are likewise good—white ‘with black and pied ear-patches’—it is likely to prove a better cross of its sort than the two former litters of whelps which the bitch reared, they being all of foxy, wild, dark-looking colours; and, as the terrier dog which got them was somewhat wicked and crafty in nature, I am now inclined to think that, ‘as like begets like,’ he was not altogether a suitable partner for the vulpo-canine bitch—an animal but one remove from the ‘veritable fox itself,’ as wild, too, as the wildest fox which ever broke away in a state of nature from any ‘evergreen gorse covert,’ with a pack of hounds in pursuit, all eager for the fray. Yours, &c.

ROBERT TOMLIN.

“Dane Court, Isle of Thanet, January, 1857.”

The original of the engraving which heads this article has all the crouching look of the fox, with many of the wild habits of that animal. Mr. Hewer tells me that up to six or eight months old she would hiss and spit like a kitten, but has quite lost that peculiarity now. She still often disappears into the adjacent coverts for a day or two, after which hunger compels her return. She has bred a litter by a terrier, but has not been put to one of her own cross, which is necessary to be done before Mr. Tomlin's assertion is to be accepted, that the individuals of the dog and fox cross will breed *inter se*. And this being the only proof of a distinction of species which is now recognised, until the experiment is carried out successfully we are not in a position to admit that the dog and fox belong to the same species.





## BOOK II.

THE BREEDING, REARING, BREAKING, AND MANAGEMENT  
OF THE DOG, IN-DOORS AND OUT.



## CHAPTER I.

### BREEDING.

Principles of Breeding.—Axioms for the Breeder's Use.—Crossing and crossed Breeds.—Importance of Health in both Sire and Dam.—Best Ages to breed from. — In-and-in Breeding. — Best Time of Year.—Duration of Heat. — Management of the Bitch in Season.—The Bitch in Whelp.—Preparations for Whelping.—Healthy Parturition.—Destruction or Choice of Whelps at Birth.

### GENERAL PRINCIPLES OF BREEDING.

THE principles upon which the breeding of the dog should be conducted are generally in accordance with those necessary for the production of other domestic animals of the class *Mammalia*, remembering always that it is not reliable to argue from one class of animals to another, because their habits and modes of propagation vary so much as to interfere with the analogy. Thus as the pigeon, in common with other birds, does not rear her young *with the produce of her own body* to the same comparative size as most of the individuals of the class *Mammalia*, the mother has not so much more to do with the process than the father as is the case with the bitch, mare, and cow, &c., where the quantity and quality of the milk are to be taken into the calculation. Hence, in selecting a sire and dam for breeding purposes among dogs, the

bitch is most to be considered for many reasons, one being that she usually continues the property of the breeder, while the sire can be changed each time she breeds; but the chief argument in her favour being founded upon the supposition that she really impresses her formation upon her progeny more than the dog. This, however, is a vexed question in natural history as well as in practical breeding, but from my own experience I am strongly of opinion that it is true. Many horses and dogs may be instanced which have got good stock from all sorts of mares and bitches; but in opposition to this may be instanced the numbers which have had enormous opportunities of showing their good qualities, but while they have succeeded with one or two they have failed with the larger proportion of their harems. So with mares and bitches, some have produced, every year of their breeding lives, one or more splendid examples of their respective kinds, altogether independent of the horse or dog which may be the parent, so long as he is of the proper strain likely to hit with hers. It is usually supposed that the sire impresses his external formation upon his stock, while the bitch's nervous temperament is handed down; and very probably there is some truth in the hypothesis. Yet it is clearer that not only do the sire and dam affect the progeny, but also the grandsires and granddams on both sides, and still further than this up to the sixth and perhaps even the seventh generations, but more especially on the dam's side, through the granddam, great-granddam, &c. There is a remarkable fact connected with breeding which should be generally known, which is, that there is a tendency in the produce to a separation between the different strains

of which it is composed ; so that a puppy composed in four equal proportions of breeds represented by A, B, C, and D, will not represent all in equal proportions, but will resemble one much more than the others, and this is still more clear in relation to the next step backwards, when there are eight progenitors : and the litter which, for argument's sake, we will suppose to be eight in number, may consist of animals each "going back" to one or other of the above eight. This accounts for the fact that a smooth terrier bitch put to a smooth terrier dog will often "throw" one or more rough puppies, though the breed may be traced as purely smooth for two or three generations, beyond which, however, there must have been a cross of the rough dog. In the same way colour and particular marks will be changed or obliterated for one, two, or even three generations, and will then reappear. In most breeds of the dog this is not easily proved, because a record of the various crosses is not kept with any great care ; but in the greyhound the breed, with the colours, &c., for twenty generations, is often known, and then the evidence of the truth of these facts is patent to all. Among these dogs there is a well-known strain descended from a greyhound with a peculiar nose, known as the "Parrot-nosed bitch." About the year 1825 she was put to a celebrated dog called "Streamer," and bred a bitch called "Ruby," none of the litter showing this peculiar nose ; nor did "Ruby" herself breed any in her first two litters ; but in her third, by a dog called "Blackbird," belonging to Mr. Hodgkinson, two puppies showed the nose ("Blackbird" and "Starling"). In the same litter was a most celebrated bitch, known as "Old Linnet," from which are

descended a great number of first-rate greyhounds. In these, however, this peculiarity has never appeared, with two exceptions, namely, once in the third generation, and once in the fifth, in a dog called "Lollypop," bred by Mr. Thomas, of Macclesfield, the possessor of the whole strain. One of the bitches of this breed is also remarkable for having always one blue puppy in each litter, though the colour is otherwise absent, never having been seen since the time of the above-mentioned "Ruby," who was a blue bitch. These facts are very remarkable as showing the tendency to "throw back" for generations, but, as they are well known and fully recognised by all breeders, it is unnecessary to dilate upon them, and the above instances are only introduced as absolutely proving to the uninitiated what would otherwise depend upon dogmatic assertion.

---

#### AXIOMS FOR THE BREEDER'S USE.

But it may be asked,—What then are the principles upon which breeding is to be conducted? To this, in many of the details, no answer can be given which can be relied on with certainty. Nevertheless, there are certain broad landmarks established which afford some assistance, and these shall be given, taking care to avoid all rules which are not clearly established by general consent.

1. The male and female each furnish their quota towards the original germ of the offspring; but the female over and above this nourishes it till it is born, and, consequently, may be supposed to have more influence upon its formation than the male.

2. Natural conformation is transmitted by both parents as a general law, and likewise any acquired or accidental variation. It may therefore be said that, on both sides, "*like produces like.*"

3. In proportion to the purity of the breed will it be transmitted unchanged to the offspring. Thus a greyhound bitch of pure blood put to a mongrel will produce puppies more nearly resembling her shape than that of the father.

4. Breeding in-and-in is not injurious to the dog, as may be proved both from theory and practice; indeed it appears, on the contrary, to be very advantageous in many well-marked instances of the greyhound, which have of late years appeared in public.

5. As every dog is a compound animal, made up of a sire and dam, and also their sires and dams, &c., so, unless there is much breeding in-and-in, it may be said that it is impossible to foretell with absolute certainty what particular result will be elicited.

6. The first impregnation appears to produce some effect upon the next and subsequent ones. It is therefore necessary to take care that the effect of the cross in question is not neutralised by a prior and bad impregnation. This fact has been so fully established by Sir John Sebright and others that it is needless to go into its proofs.



By these general laws on the subject of breeding we must be guided in the selection of the dog and bitch from which a litter is to be obtained, always taking care that both are as far as possible remarkable, not only for the bodily shape, but for the qualities of the brain and nervous system which are desired. Thus, in breeding the pointer, select a good-looking sire and dam by all means, but also take care that they were good in the field; that is, that they possessed good noses, worked well, were stout, and if they were also perfectly broken so much the better. So, again, in breeding hounds, care must be taken that the animals chosen are shaped as a hound should be; but they should also have as many of the good hunting qualities, and as few of the vices of that kind of dog; and if these points are not attended to the result is not often good.

To secure these several results *the pedigrees* of the dog and bitch are carefully scanned by those who are particular in these matters, because then assurance is given that the ancestors, as far as they can be traced, possessed all those qualifications without which their owners would not in all human probability retain them. Hence a pointer, if proved to be descended from a dog and bitch belonging to Lord Sefton, Lord Lichfield, or any well-known breeder of this dog in the present day, or from Sir H. Goodrich, Mr. Moore, or Mr. Edge, so celebrated for their breeds some years ago, would be valued more highly than another without any pedigree at all, although the latter might be superior in shape, and might perform equally well in the field. The importance of pedigree is becoming more fully recognised every

year, and experienced breeders generally refuse to have anything to do with either dog or bitch for this particular purpose, unless they can trace the pedigree to ancestors belonging to parties *who were known to be themselves careful in their selections*. In most cases this is all that is attempted, especially in pointers, setters, spaniels, &c., but in greyhounds and foxhounds of first-class blood the genealogy may generally be traced through half a dozen kennels of known and established reputation; and this same attention to breed ought to prevail in all the varieties of the dog whose performances are of importance, and indeed without it the reproduction of a particular shape and make cannot with anything like certainty be depended on. Hence the breeders of valuable toy dogs, such as King Charles spaniels, Italian greyhounds, &c., are as careful as they need be, having found out by experience that without this attention they are constantly disappointed.

---

#### CROSSING AND CROSSED BREEDS.

*Crossing* is practised with two distinct objects in view:—1st, To prevent degeneration in consequence of keeping to the same blood, or what is called “in-and-in” breeding; and 2ndly, With the view of improving particular breeds when they are deficient in any desirable quality, by crossing with others which have it in perfection, or often in excess. The first of these will be better

understood after alluding to the practice of "in-and-in" breeding, but the second may now be considered with advantage.

Among dogs, as among horses, certain varieties are remarkable for particular qualities, and as the latter are more numerous in the species *Canis familiaris* than in the horse, so there is a greater opportunity for alteration. Thus in the horse there are speed, stoutness, courage, temper, and shape (which includes action) to be considered; but in the dog there are also, over and above these, nose and sagacity, the presence or absence of which in some breeds is of the greatest importance. Now it happens that there are certain old strains which have some of these qualities developed in a very high degree, but are deficient in others, and therefore they are only adapted to those breeds in which the qualities they are deficient in are in excess. It is by a knowledge of these properties, and by taking advantage of them, that our modern breeds have been brought to the perfection at which they have arrived; carefully combining the plan with the principle of selection, which is the great secret in all kinds of breeding. In this way the foxhound has been produced by introducing the speed of the greyhound, and in like manner the courage of the bulldog has been added to the speed of the greyhound, to establish the present high form of that animal. So also the terrier, though ardent enough in pursuit of vermin, is too great a coward to bear their bites without flinching unless he is crossed with the bulldog; and hence the bull-terrier is the most useful dog for that purpose. Although many breeds of terrier so crossed are not admitted to contain the bull strain, still it is notorious that a

vast proportion, if not all, have been crossed in this way some generations back, and I firmly believe that without this blood in their veins they are utterly useless.

It might naturally be supposed by any person who has not been convinced to the contrary, that it would take several crosses to get rid of the heavy form of the bull-dog when united with the light and graceful shape of the greyhound. But on actually trying the experiment it will readily be seen that in the third generation very little trace remains of the bull-dog, while in the fourth there is none whatever apparent in external form. My friend the late Mr. Hanley, of the 2nd Life Guards, was the last who tried the experiment, and having kept a daguerreotype of every individual used in it, which he kindly placed at my service, I have been enabled to present to my readers perfectly trustworthy proofs of the correctness of this assertion. The bulldog "Chicken" used was a very high-bred animal, and of him also Mr. Hanley has preserved a daguerreotype, but as his blood is very similar to that of Mr. Stockdale's "Top" (see p. 133), I have not thought it necessary to engrave him. The bitch "Fly," put to "Chicken," was also highly bred; but the most satisfactory proceeding will be to insert the whole pedigree at length, as shown on next page.

That the illustrative engravings are literal copies of the above-mentioned daguerreotypes is a fact which should be plainly stated; in the first place, because, without a knowledge of it, the strangely uncouth forms of the first two would hardly be accepted; and in the second, to account for the attitudes in which the whole four are represented.

*Pedigree of Mr. Hanley's "Hecate," "Hecate," and "Half-and-Half."*

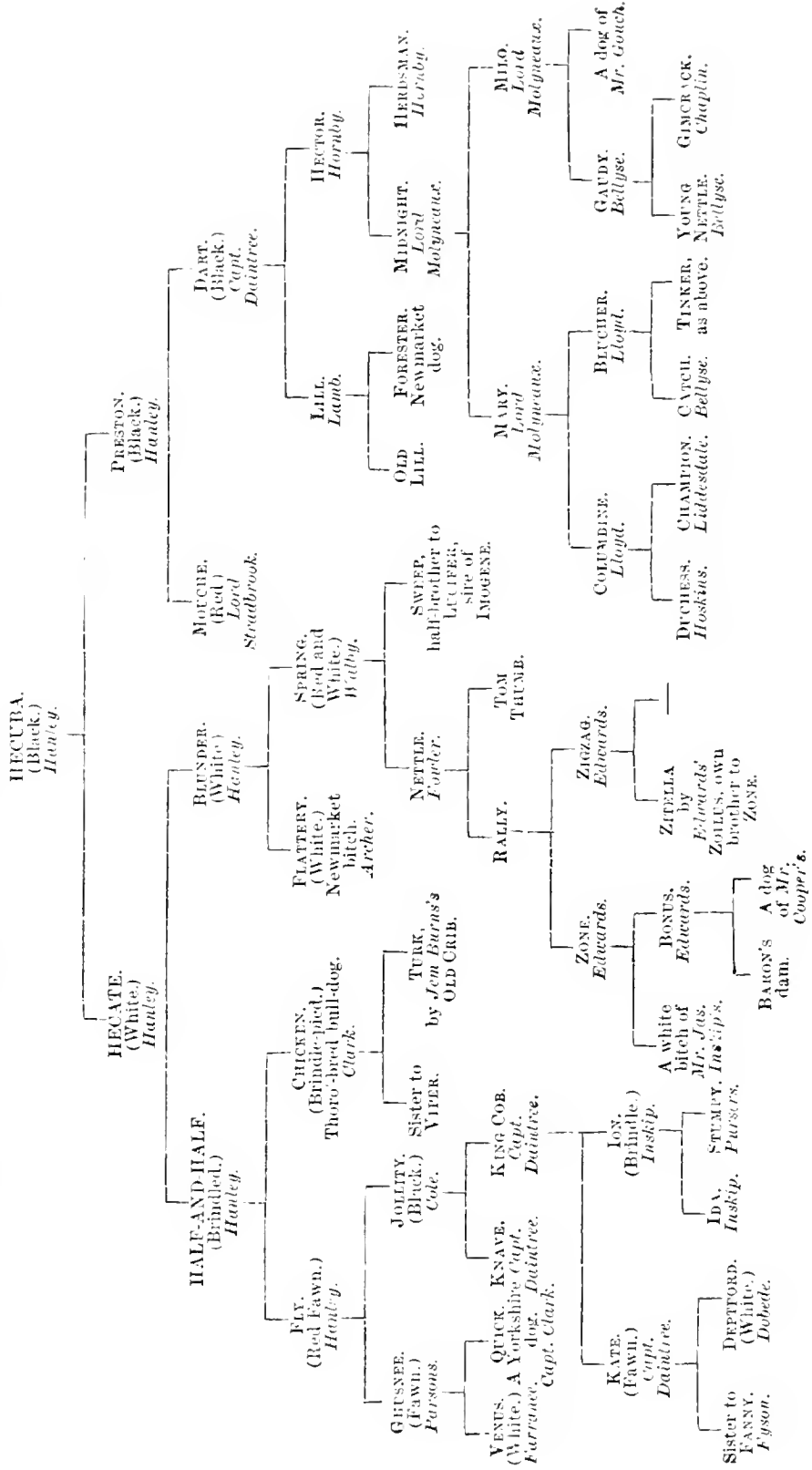

From "Chicken" and "Fly" came the following thick and clumsy-looking animal, which was named "Half-and-Half," being the first cross.

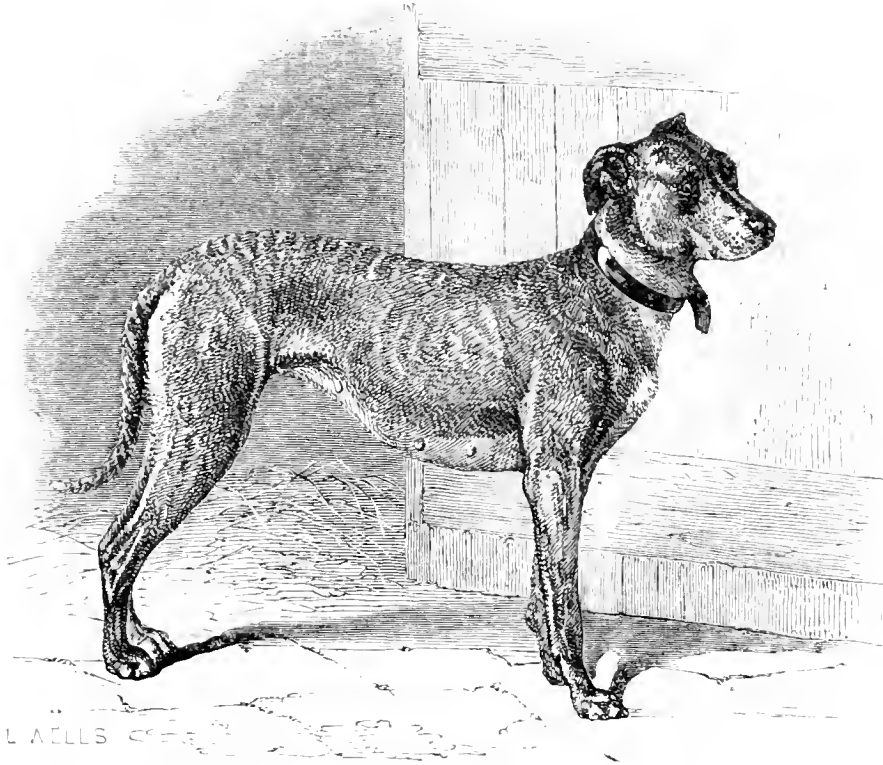

"HALF-AND-HALF," \* first Cross from the Bulldog.

The next step was to put this "Half-and-Half" to a well-bred dog belonging to Mr. Hanley, called "Blunder," whose descent is shown in the extended pedigree. From these came the second cross, "Hecate," a white bitch still presenting some slight charac-

\* From a daguerreotype in the possession of Hugh Hanley, Esq., 1st Life Guards.

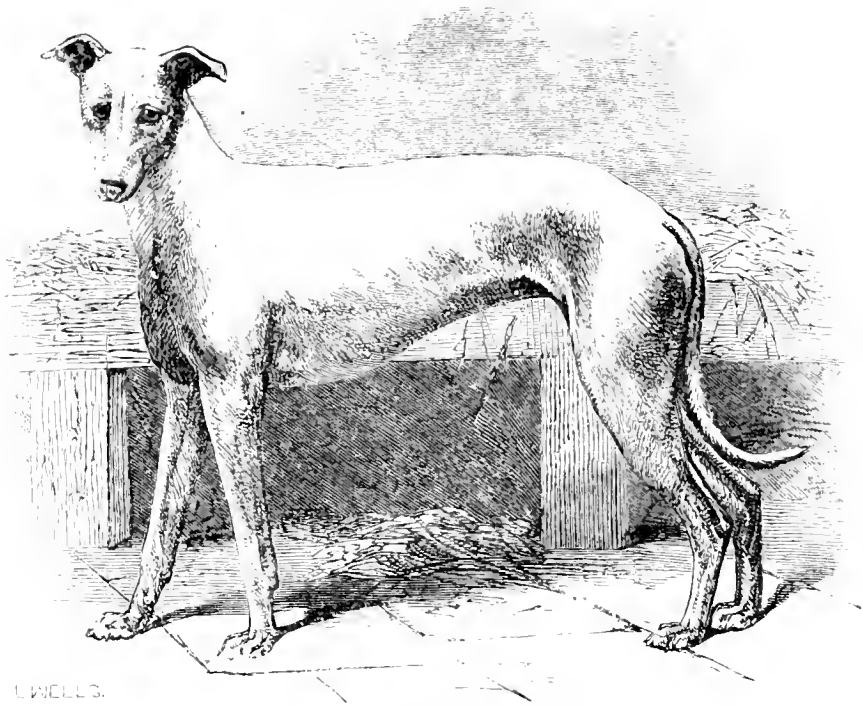

“HECATE,” \* second Cross from the Bulldog.

teristics of the bulldog breed, but by an ordinary observer this would be scarcely noticed. There is, however, a remarkable want of symmetry and true proportion in this bitch, which the portrait conveys exactly.

She was again put to “Preston,” a very fast dog belonging to her owner, and from them the produce was “Hecuba,” a large black bitch of good shape, and, as I before remarked, scarcely dis-

\* From a daguerreotype in the possession of Hugh Hanley, Esq., 1st Life Guards.

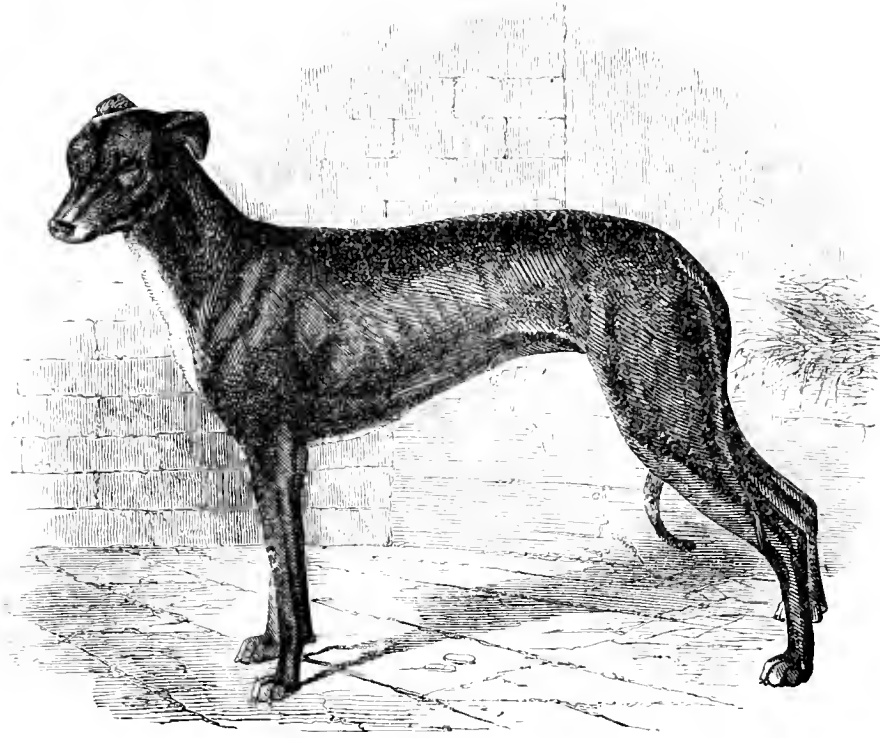

“HECUBA,” third Cross from the Bulldog.

tinguishable from the pure greyhound. She was very fast, but could not work very cleverly, and her staying powers were very limited indeed.

Mr. Hanley sent her to the celebrated dog “Bedlamite,” expecting in this fourth cross to have some good runners, but they were all remarkably deficient in stoutness, though fast as well as clever. One of them is represented on the next page, having run in public as “Hysterics.”



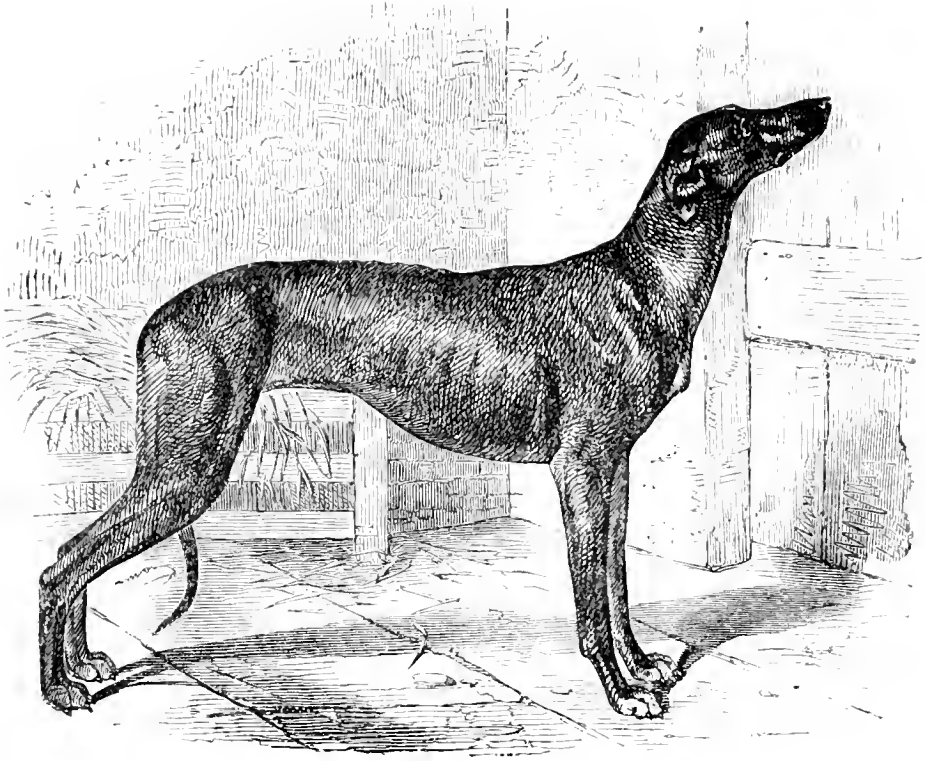

“HYSTERICS,” fourth Cross from the Bulldog.

This bitch has been put to “Ranter,” a son of “Bedlamite:” but the result of this, the fifth cross, is not as yet, I believe, more satisfactory than the fourth.

Before resorting to any particular strains, with a view of improving upon defects, it is necessary to consider what breeds are remarkable for each quality which is likely to be desired,—namely, speed, courage, nose, and sagacity. Of these, the first is so remarkably prominent in the greyhound, that there is no necessity for going further, and whenever it is desired to increase the

pace of any kind of dog, no discussion would arise as to the best means of effecting the object, this breed being immediately selected. So also the bulldog is proverbial for courage, and fortunately he is so formed as to be readily made to amalgamate with other breeds. Even the greyhound recovers his peculiar shape completely in the fourth generation, and in the third it would be difficult to discover any certain proof of the existence of the cross.

With regard to nose, there may be a difference of opinion depending upon the purpose to which it is devoted; but as it is seldom that this quality is wanted to be engrafted on speed or courage, the reverse being the usual course, it is scarcely necessary to dilate upon it. Thus it may be desirable to alter or improve the nose of the hound, the pointer, the setter, the spaniel, or the terrier, and in that case it would only be necessary to have recourse to the best specimens, as regards nose, in each breed, because there is a peculiarity attending on each mode of using the nose, which renders it more adapted to the work to be done than any other. Hence the pointer, when crossed with the foxhound, is apt to hunt too low, besides other faults which interfere with the usefulness of the cross, and the same may be said of the cross with the setter and spaniel. So that it may be laid down as a rule, that in the article nose, it is not safe to look beyond the particular breed for improvement in this important quality.

Sagacity may be looked for in several breeds, but it is most highly developed perhaps in the poodle, the Newfoundland, and the terrier; chiefly, I imagine, because these dogs are more frequently the companions of man than the sporting dogs, which are

kept in kennels. No dog is more capable of being taught than the half-bred bull-terrier, although the bulldog is by no means so, and, as he is almost always tied up, the reason is obvious enough. Solitary confinement makes all animals, and even man himself, more or less idiotic, and if any dog is to be rendered as sagacious as possible, he must be constantly associated with his master. Hence it is that the poacher's dog is so much more clever than the fair sportsman's, for, being the constant companion and friend of his master, he understands every word he says, and is ready also to communicate his own ideas in return.

To sum up, it may be assumed that the following breeds may be taken as types of the qualities so remarkable in each, and may be resorted to when any other kind is deficient in them. Thus, speed is typified in the greyhound, courage in the bulldog, and nose or scenting power in the bloodhound; for hunting purposes, the pointer or setter, when required in conjunction with setting; and the spaniel or terrier, for finding or "questing" both fur and feather. Lastly, sagacity is displayed in the poodle, Newfoundland, and terrier, chiefly because they are the constant associates of man.

---

## IMPORTANCE OF HEALTH IN BOTH SIRE AND DAM.

*Health* in both parents should be especially insisted upon, and in the bitch in particular there should be a sufficiently strong constitution, to enable her to sustain the growth of her puppies before birth, and to produce milk enough for them afterwards, though in this last particular she may of course be assisted by a foster-nurse.

---

## BEST AGE TO BREED FROM.

*The best age* to breed from, in almost all breeds, is soon after the sire and dam have each reached maturity. When, however, the produce is desired to be very small, the older both animals are, the more likely this result is,—excepting in the last litter which the bitch has, for this being often composed of only one or two puppies, they are not smaller than the average, and sometimes even larger. All bitches should be allowed to reach full maturity before they are allowed to breed, and this period varies according to size, small dogs being adult at one year, whereas large ones are still in their puppyhood at that time, and take fully twice as long to develop their proportions. The mastiff is barely full grown at two years; large hounds at a year and a half; greyhounds at the same time; pointers and setters from

a year and a quarter to a year and a half; while terriers and small toy dogs reach maturity at a year old, or even earlier.

---

#### IN-AND-IN BREEDING.

*The questions relating to in-and-in breeding and crossing are of the greatest importance, each plan being strongly advocated by some people and by others as strenuously opposed. Like many other practices essentially good, in-breeding has been grossly abused; owners of a good kennel having become bigoted to their own strain, and, from keeping to it exclusively, having at length reduced their dogs to a state of idiocy and delicacy of constitution which has rendered them quite useless. Thus I have seen in the course of twenty years a most valuable breed of pointers, by a persistence in avoiding any cross, become so full of excitability that they were perpetually at "a false point," and backing one another at the same time without game near them; and, what is worse, they could not be stirred from their position. This last was from a want of mental capacity, for it is by their reasoning powers that these dogs find out when they have made a mistake, and without a good knowledge-box the pointer and setter are for this reason quite useless. But the breed I allude to, when once they had become stiff, were like Chinese idols, and must absolutely be kicked or whipped up in order to make them start off beating again. Mr. A. Graham, who has had a long*

experience in breeding greyhounds, and was at one time so successful as to obtain the name of "The Emperor of Coursers," has laid down the rule that "once in and twice out" is the proper extent to which breeding in the greyhound should be carried, and probably the same will apply to other breeds. Sometimes a sister may be put to a brother even, when there was no previous near relationship in their sire and dam; but though this has answered well two or three times, it is not to be generally recommended. A father may in preference be put to a daughter, because there is only half the same blood in them, when the sire and dam of the latter were not related; or an uncle to a niece; but the best plan is to obtain a dog which has some considerable portion of the same blood as the bitch, but separated by one or two crosses; that is to say, to put two animals together whose grandfathers or great-grandfathers were brothers, but whose mothers and grandmothers were no relation to each other. This relationship will do equally well on the dam's side, and the grandmother may be sister to the grandsire, quite as well as having the two grandsires brothers. The practice of breeding-in to this extent has been extensively adopted of late years, and has answered well with the greyhound, in which breed, as used for public coursing, the names of "Harriet Wilson," "Hourglass," "Screw," "Sparrowhawk," "Vraye Foy," "Motley," "Miss Hannah," and "Rival" speak volumes in its approbation, all being in-bred and all wonderfully successful. The last-named bitch is a remarkable instance, being by a half-brother out of a half-sister, and yet continuing honest up to her sixth

season, when she broke a toe in running the last course but one in a large stake at Ashdown. In her case too the blood of the dam was somewhat notorious for a tendency to run cunning; and indeed the same might be said of nearly all the strains of which she was composed; nevertheless, throughout her career she was entirely free from this vice, and left off without a stain. She has, however, unfortunately refused to breed; but, as I have never known this peculiarity confined to in-bred bitches, I do not allege the fact as arising from her close in-breeding. Thus I have shown that in practice in-and-in breeding, within certain bounds, is not only not prejudicial, but absolutely advantageous, inasmuch as it does not injure the nervous temperament and mental qualities of the produce; and that the body does not suffer is a well-known fact, easily capable of proof by examining the external forms of the dogs so bred. Theoretically, also, it ought to answer, because we find in nature gregarious wild animals resorting to in-breeding in all cases, the stag adding his daughters to his harem as long as he has strength enough to beat off his younger rivals. In the same way the bull and the stallion fight for supremacy, till at length from age or accident they are beaten off, and a younger and more vigorous animal masters them and their female attendants. Yet this seems Nature's mode of insuring a superior stock, and preventing the degeneration which we see take place among human beings, when a feeble pair take upon themselves the task of producing a family. It would appear that man is an exception to the general rule, for there is a special revelation prohibiting inter-marriages, while we find them constantly going on among brutes,

and especially, as above remarked, among gregarious animals. Hence it should not lead us to reason by analogy from one to the other, nor because we find that first cousins among our own race are apt to produce defective children, bodily and mentally, should we conclude that the same evil results will occur when we breed from dogs or horses having the same degree of relationship to their mates. At the same time, when all that can be desired is obtainable without in-breeding, I should be inclined to avoid it; always taking care to resort to it, when it is desired to recover a particular strain, which is becoming merged in some other predominant blood. Then by obtaining an animal bred as purely as possible to the desired strain, and putting him or her to your own, it may be expected that the produce will "go back" to this particular ancestry, and will resemble them more than any other.

---

BEST TIME OF YEAR.

*The best time of the year* for breeding dogs is from April to September, inasmuch as in the cold of winter the puppies are apt to become chilled, whereby their growth is stopped, and some disease very often developed. Among public greyhounds there is a particular reason for selecting an earlier period of the year, because as their age is reckoned from the 1st of January, and as they are wanted to run as saplings or puppies, which are defined



by their age, the earlier they are born the more chance they have in competition with their fellows of the same year. Hounds and game dogs are wanted to begin work in the autumn, and as they do not come to maturity till after they are a year old, they should be whelped in the spring. This is more especially the case with pointers and setters, which are then old enough to have their education nearly completed at "pairing time" in the spring of the next year, when only their breaking can properly be carried on, as birds then lie like stones and allow the dog to be reached, and properly kept under by his breaker. Toy dogs, and all small dogs, which are reared in the house, *may* be bred almost at any time of the year, but even they are stronger and healthier if born in the summer months, because the puppies may then be supposed to get more air and sun than they could do in the winter, when the warmth of the fire is essential to their well-doing.

---

#### DURATION OF HEAT.

*The duration of the period of heat* in the bitch is about three weeks, during the middle week of which she will generally take the dog; but about the eleventh or twelfth day from the first commencement, is, on the average, the best time to put her to him. During the first three or four days of the middle week the bitch "bleeds" considerably from the *vulva*, and while this is

going on she should not be allowed access to the male, nor will she generally if left to herself, but as soon as it subsides, no time should be lost, as it often happens that very shortly afterwards she will refuse him altogether, and thus a whole year may be lost. Most bitches are "in heat" twice a year, at equal periods, some every five, or even every four, months; others every seven, eight, nine, ten, eleven, or twelve months; but the far greater proportion of bitches of all breeds are "in season" twice a year pretty regularly. There is, therefore, a necessity for ascertaining the rule in each bitch, as it varies so considerably; for, when it is known, the calculation can better be made as to the probability of the heat returning at the desired time. The period between the first and second "heats" will generally indicate the length of the succeeding ones, but this is not invariable, as the "putting by" of the animal will sometimes throw her out of her regular course.

---

#### MANAGEMENT OF THE BITCH IN SEASON.

*When bitches are not intended to breed, they are carefully "put by," that is to say, they are secluded from the dog, and during that time they are in great measure deprived of their usual exercise. From this circumstance they are very apt to get out of health, and some injury is thereby done to their offspring*

as well as themselves. At this time they ought, from their general feverishness, as well as from their deprivation of exercise, to be kept rather lower than usual, and very little meat should be given. Slops and vegetables, mixed with biscuit or oatmeal, form the most suitable diet; but, if the bitch has been accustomed to a great deal of flesh, it will not do to deprive her of it altogether. Bearing in mind then this caution, it is only necessary to remember that she must be lowered in condition, but not so starved as to do harm by the sudden change. After the end of the period, a little cooling medicine will often be required, consisting of a dose of oil or salts. (See Aperients.)

---

#### MANAGEMENT OF THE BITCH IN WHELP.

When it is clearly ascertained that the bitch is in whelp, the exercise should be increased and carried on freely till the sixth week, after which it should be daily given, but with care to avoid strains either in galloping or jumping. A valuable bitch is often led during the last week, but somehow or other she ought to have walking exercise to the last, by which in great measure all necessity for opening medicine will be avoided. During the last few weeks her food should be regulated by her condition, which must be raised if she is too low, or the reverse if she is too fat, the desired medium being such a state as is

compatible with high health, and neither tending towards exhaustion nor inflammation. Excessive fat in a bitch not only interferes with the birth of the pups, but also is very liable to interfere with the secretion of milk, and, if this last does happen, aggravates the attendant or "milk" fever. To know by the eye and hand how to fix upon this proper standard, it is only necessary to feel the ribs, when they should at once be apparent to the hand, rolling loosely under it, but not evident to the eye so as to count them. It is better to separate the bitch from other dogs during the last week or ten days, as she then becomes restless, and is instinctively and constantly looking for a place to whelp in, whereas, if she is prevented from occupying any desirable corner she is uneasy. At this time the food should be of a very sloppy nature, chiefly composed of broth, or milk and bread, adding oatmeal according to the state of the bowels.

---

#### PREPARATION FOR WHELPING.

The best mode of preparing a place for the bitch to whelp in is to nail a piece of old carpet over a smooth boarded floor, to a regular "bench," if in a sporting kennel; or on a door or other flat piece of board raised a few inches from the ground, if for any other breed. When a regular wooden box or kennel, as these are called in ordinary language, is used for the bitch, she may as well continue to occupy it, as she will be more

contented than in a fresh place ; but it is not so easy to get at her there if anything goes wrong with either mother or whelps, and on that account it is not a desirable place. A board, large or small, according to the size of the bitch, with a raised edge to prevent the puppies rolling off, and supported by bricks a few inches from the ground, is all that is required for the most valuable animal ; and if a piece of carpet, as before mentioned, is tacked upon this, and some straw placed upon all, the height of comfort is afforded to both mother and offspring. The use of the carpet is to allow the puppies to catch their claws in it as they are working at the mother's teats ; for without it they slip over the board, and they are restless, and unable to fill themselves well ; while at the same time they scratch all the straw away, and are left bare and cold.

---

#### HEALTHY PARTURITION.

*During whelping*, the only management required is in regard to food and quiet, which last should as far as possible be enjoined, as at this time all bitches are watchful and suspicious, and will destroy their young if they are at all interfered with, especially by strangers. While the process of labour is going on no food is required, unless it is delayed in an unnatural manner, when the necessary steps will be found described in the Third Book. After it is completed, some lukewarm gruel,

made with half milk and half water, should be given, and repeated at intervals of two or three hours. Nothing cold is to be allowed for the first two or three days, unless it is in the height of summer, when these precautions are unnecessary, as the ordinary temperature is generally between 60° and 70° of Fahrenheit. If milk is not easily had, broth will do nearly as well, thickening it with oatmeal, which should be well boiled in it. This food is continued till the secretion of milk is fully established, when a more generous diet is gradually to be allowed, consisting of sloppy food, together with an allowance of meat somewhat greater than that to which she has been accustomed. This last is the best rule, for it will be found that no other useful one can be given; those bitches which have been previously accustomed to a flesh diet sinking away if they have not got it at this time, when the demands of the puppies for milk drain the system considerably; and those which have not been used to it being rendered feverish and dyspeptic if they have an inordinate allowance of it. A bitch in good health, and neither over-reduced by starvation nor made too fat by excessive feeding, will rarely give any trouble at this time; but, in either of these conditions, it may happen that the secretion fails to be established. (For the proper remedies see Parturition, in Book III.) From the first day the bitch should be encouraged to leave her puppies twice or thrice daily to empty herself, which some, in their excessive fondness for their new charge, are apt to neglect. When the milk is thoroughly established, they should be regularly exercised for an hour a day, which increases the secretion of milk, and

indeed will often bring it on. After the second week, bitches will always be delighted to leave their puppies for an hour or two at a time, and will exercise themselves if allowed to escape from them. The best food for a suckling bitch is strong broth, with a fair proportion of bread and flesh, or bread and milk, according to previous habits.

---

#### DESTRUCTION OR CHOICE OF WHELPS AT BIRTH.

*Sometimes it is desirable to destroy all the whelps as soon as possible after birth, but this ought very seldom to be done, as in all cases it is better to keep one or two sucking for a short time, to prevent milk fever, and from motives of humanity also. If, however, it is decided to destroy all at once, take them away as fast as they are born, leaving only one with the mother to engage her attention, and when all are born, remove the last before she has become used to it, by which plan less cruelty is practised than if she is permitted to attach herself to her offspring. Low diet and a dose or two of mild aperient medicine, with moderate exercise, will be required to guard against fever, but at best it is a bad business, and can only be justified under extraordinary circumstances.*

## CHAPTER II.

### REARING.

Management in the Nest.—Choosing.—The Foster-Nurse.—Feeding before Weaning.—Choice of Place for Whelping.—Removal of Dew-Claws, &c.—Weaning.—Lodging.—Feeding.—Exercise.—Home Rearing *v.* Walking.—Food.—General Management.—Cropping, Branding, and Rounding.

#### THE MANAGEMENT OF WHELPS IN THE NEST.

THIS, till they are weaned, does not require much knowledge or experience beyond the feeding of the mother, and the necessity for removing a part when the numbers are too great for her strength to support. For the first fortnight, at least, puppies are entirely dependent upon the milk of their dam or a foster-nurse, unless they are brought up by hand, which is a most troublesome office, and attended also with considerable risk. Sometimes, however, the bitch produces twelve, fourteen, or even sixteen whelps, and these being far beyond her powers to suckle properly, either the weak ones die off, or the whole are impoverished, and rendered small and puny. It is better, therefore, especially when size and strength are objects to the breeder, to destroy a part of the litter, when they are more than five or six in the greyhound, or seven or eight in the hound or other dog of that size. In toy dogs a small size is sometimes a desideratum, and with them, if the strength of



the dam is equal to the drain, which it seldom is, almost any number may be kept on her. For the first three or four days, the bitch will be able to suckle her whole litter; but if there are more puppies than she has *good* teats, that is, teats with milk in them, the weak ones are starved, unless the strong ones are kept away in order to allow them access, so as to fill themselves in their turn. To manage this, a covered basket, lined with wool if the weather is at all cold, should be provided; and in this one third or one half of the puppies should be kept, close to the mother, to prevent either from being uneasy, but the lid fastened down or she will take them out in her mouth. Every two or three hours a fresh lot should be exchanged for those in the basket, first letting them fill themselves, when they will go to sleep and remain contented for the time fixed above, thus allowing each lot in its turn to fill itself regularly. At the end of ten days, by introducing a little sweetened cow's milk on the end of the finger into their mouths, and dipping their noses in a saucer containing it, they learn to lap; and after this there will be little difficulty in rearing even a dozen; but they will not, however carefully they may be fed in aid of the mother, be as large as if only a small number were left on her, and therefore greyhound breeders limit their litters to five, six, or at most seven; destroying the remainder, or rearing them with a foster-nurse.

---

## CHOICE OF WHELPS.

*To choose the whelps in the nest* which are to be kept, most people select on different principles, each having some peculiar crotchet to guide himself. Some take the heaviest, some the last born ; others the longest of the litter ; while others again are entirely guided by colour. In toy dogs, and those whose appearance is an important element, colour ought to be allowed all the weight it deserves, and among certain toy dogs the value is often affected a hundred per cent. by a slight variation in the markings. So also among pointers and setters, a dog with a good deal of white should be preferred, on the score of greater utility in the field, to another self-coloured puppy which might otherwise be superior in all respects. Hounds and greyhounds are however chosen for shape and make, and though this is not the same at birth as in after life, still there are certain indications which are not to be despised. Among these the shoulders are more visible than any others, and if on lifting up a puppy by the tail he puts his forelegs back beyond his ears, it may be surmised that there will be no fault in his shape in reference to his fore quarter, supposing that his legs are well formed and his feet of the proper shape, which last point can hardly be ascertained at this time. The width of the hips, and shape of the chest, with the formation of the loin, may also be conjectured, and the length of the neck is in like measure shadowed forth, though not with the same certainty as the shoulders and ribs. A very fat puppy will look pudgy to an inexperienced

eye, so that it is necessary to take this into consideration in making the selection; but fat is a sign of strength, both actual and constitutional, when it is remarkably permanent in one or two among a litter, for it can only be obtained either by depriving the others of their share of milk by main force, or through such constitutional vigour as to thrive better on the same share of aliment. The navel should be examined to ascertain if there is any rupture, and this alone is a reason for deferring the choice till nearly the end of the first week, up to which time there is no means of judging as to its existence. Indeed, if possible, it is always better to rear nearly all till after weaning, either on the dam herself or on a foster-nurse, as at that time the future shape is very manifest, and the consequences of weaning are shown, either in a wasting away of the whole body, or in a recovery from its effects in a short time. Sometimes, however, there are not conveniences for either, and then recourse must be had to an early choice on the principles indicated above.

---

#### THE FOSTER-NURSE

Need not be of the same breed as the puppies which she is to suckle, and at all times a smooth-skinned bitch is superior for the purpose to one with a rough coat, which is apt to harbour fleas, and in other ways conduces to the increase of dirt. For all large breeds the bull-terrier (which is the most commonly kept among

the class who alone are likely to sell the services of a nurse) answers as well as any other, and her milk is generally plentiful and good. For small breeds any little house dog will suffice, taking care that the skin is healthy, and that the constitution is not impaired by confinement or gross feeding. Greyhound puppies are very commonly reared by bull-bitches without any disadvantage, clearly proving the propriety of the plan. It may generally be reckoned, in fixing the number which a bitch can suckle with advantage, that, of greyhound or pointer puppies, for every seven pounds in her own weight the bitch can do one well; so that an average bull-terrier will rear three, her weight being about twenty-one pounds, and smaller dogs in proportion. When the substitution is to be made, the plan is to proceed as follows:—Get a warm basket, put in it some of the litter in which the bitch and her whelps have been lying, then take away all her own progeny, and, together with the whelps to be fostered, put all in the basket, mixing them so that the skins of the fresh ones shall be in contact with the bitch's own pups and also with the litter. Let them remain in this way for three hours, during which time the bitch should be taken out for an hour's walk, and her teats will have become painfully distended with milk. Then put all the pups in her nest, and, carefully watching her, let her go back to them. In ninety-nine cases out of a hundred, she will at once allow them all to suck quietly, and *if she licks all alike*, she may be left with them safely enough; but if she passes the fresh ones over, pushing them on one side, she should be muzzled for twelve hours, leaving all with her, and keeping the muzzle on excepting while she is fed,

or watched till she is observed to lick all alike. On the next day, all but one of her own puppies may be withdrawn, with an interval of one hour or two between each two, and taking care that she does not see what is done. After two days the last may also be taken away, and then she acts to her foster-puppies in every way the same as to her own. Some people squeeze a little of the bitch's milk out of her teats, and rub this over the puppies, but I have never seen any advantage in the plan, and, as I have never had any difficulty in getting puppies adopted, I do not recommend any other than that I have described. In most cases the foster-bitch is strange to those about her, having been brought from her own home, and in that case a muzzle is often required for the safety of the servants watching her as well as for the whelps; but if she seems quiet and good-tempered, it may be dispensed with even here.

---

#### FEEDING BEFORE WEANING.

*The food of whelps before weaning* should be confined at first to cow's milk, or, if this is very rich, reduced with a little water. It is better to boil it, and it should be sweetened with fine sugar, as for the human palate. As much of this as the whelps will take may be given them three times a day, or every four hours if they are a large litter. In the fourth week get a sheep's head, boil it in a quart of water till the meat comes completely to pieces, then carefully take away every particle of bone, and break up the meat into fragments no larger than a small horse-bean; mix all

up with the broth, thicken this to the consistence of cream with *fine* wheat flour, boil for a quarter of an hour, then cool and give alternately with the milk. At this time the milk may also be thickened with flour; and as the puppies grow, and the milk of the bitch decreases in quantity, the amount of milk and thickened broth must be increased each day, as well as more frequently given. Some art, founded on experience, is required not to satiate the puppies; but, by carefully increasing the quantity whenever the pups have finished it greedily the last time or two, they will not be overdone. In no case should the pan containing the food be left in the intervals with the puppies, if they have not cleared it out, as they only become disgusted with it, and next time refuse to feed. A sheep's head will serve a litter of large-sized puppies two days up to weaning, more or less according to numbers and age.

---

## CHOICE OF PLACE FOR WHELPING.

*The whelping-place*, up to the third week, may be confined to a square yard or two, floored with board as already described. After the third week, when the puppies begin to run about, access should be given them to a larger run, and an inclined plane should be arranged for them to get up and down from their boarded stage. If the weather is cold, the best place for a bitch to whelp is in a saddle-room warmed by a stove; or an empty stall, with a two-foot board placed across the bottom, opposite the

stall-post, so as to prevent the puppies getting among the horses. In either case there is an amount of artificial heat, which conduces to the growth of the puppies, and allows them to be reared sufficiently strong to bear any cold afterwards with impunity. If the weather is not cold, an ordinary horse-box is the best place which can be chosen, fixing the boarded stage at a distance from the door, and either sanding or slightly littering the brick floor, according to the weather; but the latter is to be preferred, excepting in a very hot summer. In these boxes puppies take a vast amount of exercise, which they require for health, and to give that appetite without which sufficient food for growth is not taken.

---

#### REMOVAL OF DEW-CLAWS, ETC.

*Before weaning, any cropping* which is intended, whether of the dew-claw or tail, should be practised, but the ears should be left alone till the third or fourth month, as they are not sufficiently developed before. If, however, the operator does not understand his business thoroughly, it is better to leave the latter organs alone, till a later period, as otherwise the proper quantity may not be cropped or rounded, as the case may be. Indeed, even the most skilful hand will hardly ever manage either the one or the other well before the fifth month; and in hounds it is usual to defer it till they are nearly full grown, as they often lose a considerable quantity of blood, which interferes with their

growth. But the tail and dew-claws may always be best done, and with least pain, while with the dam; besides which, her tongue serves to heal the wound better than that of the young puppy, who has hardly learnt to use it. Regular dog-fanciers bite off the tail, but a pair of scissors answers equally well; and the same may be said of the dew-claw. If, however, the nail only is to be removed, which it always ought to be, the teeth serve the purposes of a pair of nippers perfectly, and by their aid it may be drawn out, leaving the claw itself attached, but rendered less liable to injury, from having lost the part likely to catch hold of any projecting body.

---

#### WEANING.

*When weaning is to be commenced*, which is usually about the fifth or sixth week, it is better to remove the puppies altogether, than to let the bitch go on suckling them at long intervals. By this time their claws and teeth have become so sharp and so long, that they punish the bitch terribly, and therefore she does not let them fill their bellies. Her milk generally accumulates in her teats, and becomes stale, in which state it is not fit for the whelps, and by many is supposed to engender worms. The puppies have always learned to lap, and will eat meat, or take broth or thickened milk, as described in the last chapter; besides which, when they have no chance of



sucking presented to them, they take other food better, whereas, if they are allowed to suck away at empty teats, they only fill themselves with wind, and then lose their appetites for food of any kind. But, having determined to wean them, there are several important particulars which must be attended to, or the result will be a failure, at all events for some time. That is to say, the puppies will fall away in flesh, and will cease to grow at the same rate as before. In almost all cases, what is called the "milk-fat" disappears after weaning, but still it is desirable to keep some flesh on their bones, and this can only be done by attending to the following directions, which apply to dogs of all kinds, but are seldom rigidly carried out, except with the greyhound, whose size and strength are so important as to call for every care to procure them in a high degree. In hounds, as well as pointers and setters, a check in the growth is of just as much consequence; but as they are not tested together as to their speed and stoutness so closely as greyhounds are, the slight defects produced in puppyhood are not detected, and, as a consequence, the same attention is not paid. Nevertheless, as most of these points require only care, and cost little beyond it, they ought to be carried out almost as strictly in the kennels of the foxhound and pointer as in those devoted to the longtails. These chief and cardinal elements of success are,—1st, a warm, clean, and dry lodging; 2ndly, suitable food; 3rdly, regularity in feeding; and 4thly, a provision for sufficient exercise.

---

## NECESSITY FOR WARM AND DRY LODGING.

*All puppies require a dry lodging,* and in the winter season it should also be a warm one. Greyhound whelps, up to their third or fourth month, are sometimes reared in an artificial temperature, either by means of a stove, or by using the heat of a stable, the temperature chosen being 60° of Fahrenheit. Beyond this age, it can never be necessary to adopt artificial heat in rearing puppies, because for public coursing they are required to be whelped after the last day of the year, and four months from that time takes us on to May, when the weather is seldom cold enough to require a stove; and then during the summer months they are gradually hardened to the vicissitudes of the weather, and as they become older their growth is established, and they are no longer in danger of its being checked. It is true that some few coursers always keep their kennels at 60°; but on the whole, as we shall hereafter find, the plan is not a good one, and need not be considered here. But far beyond the warmth is dryness essential to success. Dogs will bear almost any amount of cold if unaccompanied by damp, provided they have plenty of straw to lie in; but a damp kennel, even if warm, is sure to lead to rickets or rheumatism, if the puppies escape inflammation of some one or more of the internal organs. Take care, therefore, to give a dry bedstead of boards, lined with the same material towards the wall, (the cold of which strikes inwards and gives cold,) and raised somewhat from the floor, which will

otherwise keep it damp. Puppies soon learn to lie on this, and avoid the cold stones or bricks, except in the heats of summer, when these do no harm. The stone or brick floor should be so made as to avoid absorption of the urine, &c., which can only be effected by employing glazed tiles or bricks that are not porous, or by *covering the whole with a layer of London or Portland cement*, or with *asphalte*, which answers nearly as well. Care should be taken that there are no interstices between the boards, if the kennel is made of them; and in every way, while ventilation is provided, cold draughts must be prevented. Cleanliness must also be attended to rigidly by sweeping out the floor daily, and washing it down at short intervals, and by changing the litter once a week at the least. In the summer time, straw is not desirable, as it harbours fleas; and, if the boarded floor is not considered sufficient, a thick layer of deal sawdust will be the best material, as it is soft enough, without harbouring vermin of any kind; the only objection to it being that the puppies are apt to wet it often, after which it becomes offensive.

---

#### FEEDING.

The *feeding* of puppies is all important, and, unless they have plenty of food sufficiently nourishing to allow of a proper growth, it is impossible that they should become what they might be if fed with the best materials for the purpose. From the time of weaning

to the end of the third month, when a decision must be arrived at as to their subsequent management, very little deviation is required from the plans described at pp. 204, 205; that is, the puppies should be fed every four hours upon the thickened broth made from sheep's head, and thickened milk alternately. After that time, however, their food must be given them rather stronger and of a somewhat different nature, as we shall find in its proper place. This food will be required for any kind of dog, but a single puppy may very well be reared upon thickened milk, with the scraps of the house in addition, including bones, which it will greedily pick, and any odds and ends which are left on the plates.

*Regularity of feeding* in puppies, as in adult animals, is of the utmost importance; and it will always be found that if two puppies are equally well reared in other respects, and one fed at regular hours, while the other is only supplied at the caprice of servants, the former will greatly excel the latter in size and health, as well as in the symmetrical development of the body. It is also very necessary to avoid leaving any part of one meal in the pans or feeding-troughs till the next, as nothing disgusts the dog more than seeing food left in this way. The moment the puppies fill themselves, take away the surplus; and, indeed, it is better still to anticipate them by stopping them before they have quite done. All this requires considerable tact and experience, and there are very few servants who are able and willing to carry out these directions fully.

## EXERCISE.

*Exercise is necessary* at all ages, but the fully developed dog may be confined for some little time without permanent injury, the formation of his feet and the texture of his bones and muscles being then finally settled. On the other hand, the puppy will grow according to the demands made upon his mechanism, and if the muscles are left idle they do not enlarge; while the feet remain thin and weak, with the tendons and ligaments relaxed, so that they spread out like a human hand. Growing puppies should be provided with an area sufficiently large for them to play in, according to their size, and under cover up to the end of the third month; after which, if they have a sheltered sleeping-place to run into, they will generally avoid heavy rain. Young puppies play sufficiently in a loose box or similar enclosure; but, after the time specified above, they must either have their entire liberty, or be allowed the run of a larger space, the alternative being bad feet, defective development, and weak joints.

---

HOME REARING *VERSUS* WALKING.

When one or two puppies only are to be reared, they may be readily brought up at home, excepting in towns or other confined situations where due liberty and a proper amount of sun and

air cannot be obtained. But where a larger number are to be reared, as in the case of hounds, greyhounds, pointers and setters, &c., there is a difficulty attending upon numbers, as a dozen or two of puppies about a house are not conducive to the neatness and beauty of the garden; besides which, the collection together in masses of young dogs is prejudicial to their health. To avoid this evil, therefore, it is customary to send puppies out at three or four months of age to be kept by cottagers, butchers, small farmers, &c., at a weekly sum for each, which is called "walking" them. Young greyhounds may be reared in a large enclosure, which should be not less than thirty or forty feet long, with a lodging-house at one end; but hounds do not take exercise enough in a confined space, and should invariably be sent out. It is only therefore in reference to the rearing of greyhounds that the two plans can be compared, or perhaps also with pointers and setters, if they are taken out to exercise after they are four or five months old.

The two plans have been extensively tried with the longtails, and in my own opinion the preference should be given to the home rearing *if properly carried out*, because it has all the advantages of the "walk" without those disadvantages attending upon it, in the shape of bad habits acquired in chasing poultry, rabbits, and often hares, during which the puppy learns to run cunning. One of the first symptoms of this vice is the waiting to cut off a corner, which is soon learnt if there is the necessity for it, and even in mutual play the puppy will often develop it. Hence I have seen a "walked" greyhound, with his very first hare, show as much waiting as any old worn-out runner, evidently acquired

in his farm-yard education, or possibly from having been tempted after a hare or two by the sheep-dog belonging to the farm. Moreover, the home-reared puppy, being confined in a limited space during the greater part of his time, is inclined to gallop when first let out, and takes in this way more exercise than those brought up on the other plan; so that, after considering both methods, I have come to the conclusion that the home rearing is preferable on the whole, though there is no doubt that good dogs may be reared in either way.

The best plan is to fence off a long slip of turf; or, if a small walled enclosure can be procured, fence off about a yard or two all round, by which last plan an excellent gallop is secured, without the possibility of cutting corners, and with a very slight loss of ground. An admirable plan is to build four large sleeping-rooms in a square-block, and then all round this let there be a run two yards wide, which may be separated into four divisions, or thrown into one at will. If the latter, the puppies will exercise themselves well round and round the building, which is a practice they are very fond of; and, even if two or more lots are wanted to occupy the compartments, the whole can be thrown open to each lot in turn. When this plan is adopted the run should be paved, so that the expense is much greater than in the other mode, in which the natural soil is allowable, because the puppies are not kept on it long enough to stain it. (See page 226.)

---

## THE FOOD OF PUPPIES AT HOME OR "AT WALK," AND ITS PROPER PREPARATION.

Whether at home or out, puppies require the same kind of food, and the more regularly this is given as to quantity and quality, as well as the times of feeding, the more healthy the puppy will be, and the faster he will grow. Many people consider milk to be by far the best article of food for growing puppies, and undoubtedly it is a good one, but it is not superior to a mixed diet of meal and animal food in proper proportions, and occasionally varied by the addition of green vegetables. Indeed, after three months, or at most four, puppies may be fed like grown dogs as to the quality of their food, requiring it however to be given them more frequently the younger they are. Up to six months they require it three times a day, at equal intervals, and after that age twice; for although there is a difference of opinion as to the propriety of feeding the adult once or twice a day, there is none about the puppy demanding a supply morning and evening. In all cases, they should be encouraged to empty themselves (by allowing a run, if they are confined to kennel) just before feeding, and for an hour or two afterwards they are best at rest. If milk is given, it may be thickened by boiling in it oatmeal or wheat-flour, or both together, or biscuits may be scalded and added to it; but no flesh is needed in addition, bones only being required to amuse the dog and to clean his teeth by gnawing them. With these any dog may be very well reared, but the plan is an expensive one, if the



milk has any thing like the ordinary value attached to it, and if it has to be purchased, the cost is generally quite prohibitory of its employment.

*Besides milk*, the following articles are employed in feeding dogs, each of which will be separately considered, as to price and value. Of these, Indian meal is by far the best in proportion to its price (being quite equal to anything but the very best wheat-flour, which is perhaps slightly more nourishing), and, being so much cheaper, is, on that account, to be preferred. It requires to be mixed with oatmeal, in about equal proportions, or less of the latter if the bowels are at all relaxed. The usual price of Indian meal is about 10*l.* or 12*l.* per ton, half that of wheat and the same as that of barley, to which it is greatly to be preferred, being far less heating, and producing muscle in larger proportion. Oatmeal is considerably dearer, though the grain itself is cheaper; but the quantity of meal obtained, owing to the amount of chaff, is so small, that when this is got rid of the meal is necessarily sold at a higher price, being from 12*l.* to 18*l.* per ton, according to the season. But a much larger *bulk* of thick stuff, commonly called "puddings," is produced by oatmeal than can be obtained from any other meal in proportion to weight, the absorption of water being greater, and also varying in different qualities of oatmeal itself; so that, after all, this meal is not so expensive as it looks to be, when comparing an equal weight of it with barley or Indian meal. The real coarse Scotch oatmeal yields the greatest bulk of puddings, and is to be preferred on that account; besides which, it appears to agree best with dogs, and altogether is a very superior article; but in

any case it ought to be nearly a year old. It may therefore be considered that Indian meal or Scotch oatmeal, both of which may always be procured from the corn-dealers, will be the best meal, unless the price of wheat-flour can be afforded, when the best red wheat should be coarsely ground and not dressed, and in this state made into biscuits or dumplings, or used to thicken the broth.

If *Indian meal* is employed, it must be mixed with the water or broth while cold, and then boiled for at least an hour, stirring it occasionally to prevent burning. If it is intended to mix oatmeal with the Indian meal, the former may be first mixed with cold water to a paste, and then stirred in after boiling the latter for three quarters of an hour; then boil another quarter, reckoning from the time that the contents of the copper came to the boiling point a second time.

*Wheat-flour* should be boiled from fifteen to twenty minutes, and may be mixed with the oatmeal in the same way as the Indian meal.

*Oatmeal pudding*, and *porridge*, or *stirabout*, are made as follows; the first name being given to it when so thick as to bear the weight of the body after it is cold, and, the last two to a somewhat thinner composition. In any case the meal is stirred up with *cold* water to a thick paste, and, when quite smooth, some of the broth should be ladled out and added to it, still stirring it steadily. Then return the whole to the copper, and stir till it thickens, ladle out into coolers, and let it "set," when it will cut with a spade and is quite solid. The directions as to length of time for the boiling of oatmeal vary a good deal, some preferring at least half an

hour's boil, while others are content with ten or fifteen minutes, but for most purposes from a quarter to half an hour is the proper time, remembering that this is to be reckoned *from the moment that the water boils*.

The *animal food* used should be carefully selected to avoid infectious diseases, and the flesh of those creatures which have been loaded with drugs should also be avoided. Horseflesh, if death has been caused by accident, is as good as anything, and in many cases of rapid disease the flesh is little the worse, but though in foxhound kennels there is little choice, yet for greyhounds those horses which have been much drugged for lingering diseases, and those also which are much emaciated, are likely to do more harm than good. Slipped calves and lambs, as well as beef and mutton, the result of death from natural causes, make an excellent change, but are seldom better than *bad* horseflesh. Still, as variety is essential to success in rearing, they should not be rejected. Flesh may be kept for a long time, even in summer, by brushing it over with a quicklime wash, or dusting it with the powder, and then hanging it up in trees with thick foliage, carefully watching the attacks of the flies, which will not blow in the lime. In this way I have kept the shank ends of legs and shoulders good for six weeks in the height of summer, and in winter for three months. Whatever this kind of food is composed of, it should be boiled, with the exception of paunches, which may be given raw, but even they are better boiled, and I think an occasional meal of well-kept horseflesh is rather a good change. The flesh with the bones should be boiled for hours, till the meat is thoroughly done; then

take it out and let it hang till cold, cut or strip it from the bones and mix with the puddings or stirabout according to the quantity required. The broth should always be used, as there are important elements of nutrition dissolved in it, which are absent in the boiled flesh. It is therefore necessary to make the puddings or stirabout with it, or to soak in it the biscuit, when this is the food selected. The bones should be given for the dogs to gnaw, together with any others from the house which can be obtained, but taking care to remove all fragments small enough for them to swallow whole. Bones should be given on grass or clean flags.

The *comparative value* of the various articles of diet enumerated above, according to the authority of Liebig, is as follows:—

| The proportions in  | Materials used for making muscle, bone, &c. | Materials used in respiration, or in forming fat. |
|---------------------|---|---|
|                     | Parts.                                      | Parts.  |
| Cow's milk      are | as 10                                       | to 30   |
| Fat mutton      „   | 10  | 27 to 45  |
| Lean mutton    „    | 10  | 19  |
| Lean beef        „  | 10  | 17  |
| Lean horseflesh „   | 10  | 15  |
| Hare and rabbit „   | 10  | 2 to 5  |
| Wheat-flour    „    | 10  | 46  |
| Oatmeal         „   | 10  | 50  |
| Barley-meal    „    | 10  | 57  |
| Potatoes        „   | 10  | 86 to 115   |
| Rice             „  | 10  | 153   |

From this high authority it appears that barley-meal is superior both to wheat-flour and oatmeal in fat-making materials, but

it is greatly inferior in muscle-making power, and hence, in dogs where fat is not required, it is of inferior value. Science and practical experiment here go hand in hand, as they always do when the former is based upon true premises. In cow's milk, which is the natural food of the young of the Mammalia, the proportion is 30 to 10, and this seems to be about what is required in mixing the animal and vegetable food. Now by adding equal weights of wheat-meal and lean horseflesh, we obtain exactly the same proportions within the merest trifle; thus—

|             |     |     |    |    |
|-------------|-----|-----|----|----|
| Wheat-flour | ... | ... | 10 | 46 |
| Horseflesh  | ... | ... | 10 | 15 |
|             |     |     | —  | —  |
|             |     |     | 20 | 61 |

being equal to 10 of muscle-making to  $30\frac{1}{2}$  of fat-making matter; and this is practically the proportion of animal food to meal which best suits the dog's stomach and general system. The reader is not to suppose that a dog is to be fed on equal parts of *cooked* meat and *puddings*, but of *raw* meat and dry meal, which when both are boiled would, by the loss of juice in the flesh and the absorption of water in the meal, become converted into about two quantities by weight of pudding to one of cooked meat. Even this proportion of flesh is a large one for growing dogs which have not much exercise, but those which are "at walk" or which have their liberty in any situation will bear it. Most people prefer a much smaller proportion of meat, especially for hounds, pointers, setters, and spaniels, which depend on their nose, this organ being

supposed to be rendered less delicate by high feeding. From long experience in this matter, however, I am satisfied that, while the health is maintained in a perfect state, there is no occasion to fear the loss of nose, and that such may be avoided with the above diet I am confident from actual practice. At the same time it must not be forgotten that all dogs so fed require a great supply of green vegetables, which should be given once or twice a week during the summer, without which they become heated, and throw out an eruption as a proof of it, the nose also being hot and dry. Green cabbage, turnip-tops, turnips, nettle-tops, or carrots, as well as potatoes, may all be given with advantage boiled and mixed with the meal and broth, in which way they are much relished.

*Greaves*, bought at the chandler's, and consisting of the refuse of the fat melted to make tallow, make a very common article for flavouring the meal of sporting dogs of all kinds. Beyond this they have little value, but they certainly afford some degree of nourishment, and are not altogether to be despised. They are boiled in water first till soft, and then mixed with the meal to form the stirabout or pudding. With oatmeal they form a good food enough for pointers and setters, as they are not so heating as flesh.

The *quantity by weight* which is required by the growing puppy daily of such food as the above, is from a twelfth to one-twentieth of the weight of its body, varying with the rapidity of growth, and a good deal with the breed also. Thus a 12 lb. dog will take from five-eighths of a pound to a pound, and a 36 lb. dog from two pounds to three pounds. When they arrive at full growth, more

than the smaller of these weights is very seldom wanted, and it may be taken as the average weight of food of this kind for all dogs in tolerably active exercise.

---

#### GENERAL TREATMENT.

*During the whole time of growth*, the only general management required is, firstly, a habit of obedience, the dog being taught his kennel name, to follow at heel, and to lead. Some breeds require more than this; as, for instance, the pointer and setter, which will be mentioned under the head of breaking. Secondly, great cleanliness in all respects, the kennel being kept scrupulously clean by washing the floor, and at least once a year lime-washing the walls, while the skins are freed from any vermin which may be found by the means described in the Third Book. In the summer a straw bed is seldom required, but in the winter it must be given for the sake of warmth, and changed once or twice a week. Physic is not needed as a regular practice, if feeding is conducted on the above plan, and the exercise is sufficient; but if the puppies are dull, a dose of castor oil occasionally will do good.

---

## CHOICE OF PUPPIES AFTER WEANING THEM.

Puppies of all kinds vary in form so much between the weaning time and the period of full growth, that there is great difficulty in making a choice which shall be proved by subsequent events to be on reliable grounds. All young animals grow by fits and starts, the proportions varying with the stage of development in which any part is at the time of examination. Thus at the fourth month a puppy may look too long, but during the next month he may have grown so much in the legs that he no longer looks so. Again, another may be all legs and wings in the middle of his growth, but he may finally grow down to a strong, low, and muscular dog. So also with the fore and hind quarters, they may grow alternately, and one month the fore quarter may be low, and the next the hind. None but an experienced eye therefore can pretend to foresee, after the period of weaning, what will be the final shape; but either soon after that time, or a day or two after birth, a pretty good guess may be given, subject to the continuation of health, and to proper rearing in all respects. Bad feet can soon be detected, but the limbs grow into a good shape after most extraordinary deviations from the line of beauty, particularly in the greyhound, which is often apparently deformed in his joints when half grown. The most unwieldy-looking animals often fine down into the best shapes, and should not be carelessly rejected without the *fiat* being pronounced by a breeder of experience.

---



## CROPPING, BRANDING, AND ROUNDING.

If terriers are to be cropped, the beginning or end of the fourth month is the best time to choose ; and, before sending out to walk, hounds are branded with the initials of the master or of the hunt, a hot iron shaped like the letter itself being used. Both cropping and rounding require practice to perform them well, a large sharp pair of scissiors being used, and care being necessary to hold the two layers of skin in the ear in their natural position, to prevent the one rolling on the other, and thus leaving one larger than the other. Foxhounds have so much work in covert that rounding is imperatively called for to prevent the ears from being torn, and it always has been adopted as a universal practice, different huntsmen varying in the quantity removed. Some people after cutting one ear lay the piece removed on the other, and so mark exactly the amount which is to be removed from it ; but this is a clumsy expedient, and, if the eye is not good enough to direct the hand without this measurement, the operation will seldom be effected to the satisfaction of the owner of the dog. It is usual to round foxhound puppies *after* they come in from their walks ; but it would be far better to perform the operation *before* their return, as it only makes them more sulky and unhappy than they otherwise would be, and is a poor introduction to their new masters. The men could easily go round to the different walks during the summer, and it would insure a supervision which is often required.

## CHAPTER III.

## KENNELS AND KENNEL MANAGEMENT.

Greyhound Kennels. — Foxhound Kennels. — Pointer Kennels. — Kennels for single Dogs. — House Dogs.

BETWEEN the kennels intended for the various kinds of dogs, and the methods of management therein, some considerable difference exists, though the same principles are adopted throughout. Thus, packs of foxhounds are often kept to the number of 80 or even 100 couples, and these must be managed rather differently to the three or four brace of greyhounds or pointers, which usually constitute the extent of each of these kinds in one man's possession, or at all events in one building. Besides this, foxhounds are much more exposed to the weather than greyhounds, which are usually clothed out of doors, and otherwise protected by dog-carts, &c. The former therefore must be hardened to the duties they have to perform, while the latter may be brought out in more vigorous health, and with their speed very highly developed, but at the same time in so delicate a condition as to be liable to take cold if allowed to remain in the rain for any length of time. Hence it will be necessary to describe the kennels for greyhounds, hounds, pointers, &c., separately.

## GREYHOUND KENNELS.

Every kennel intended for greyhounds should be thoroughly protected from the weather, and should have the yard covered in as well as the lodging-house. The plan which has been indicated at page 214 as useful for the kennel intended to rear puppies is also best adapted for their future keeping, and this it will be desirable to describe more fully here.

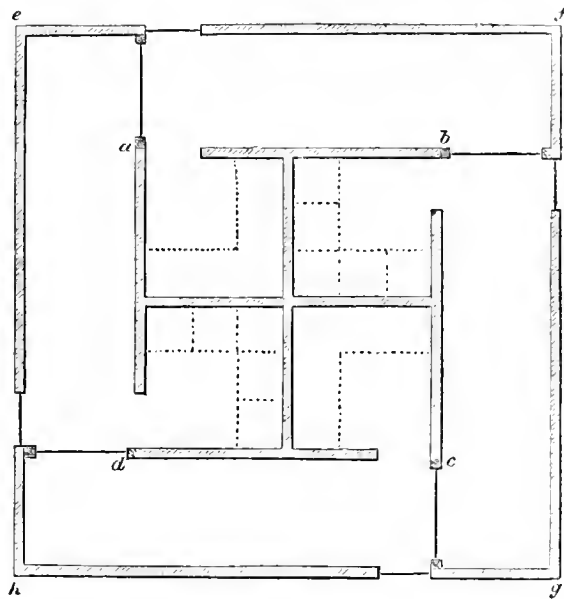

Ground Plan of Greyhound Kennel.

The central square, comprised between the four angles *a b c d*, is divided into four lodging-houses, having a ventilating shaft in the middle, with which they all communicate. These are filled up with benches separated by low partitions as shown in the diagram,

and raised about a foot from the ground. Each opens into a yard, with a door of communication so arranged as to be left partly open without allowing the slightest draught to blow upon the beds. These yards, *ab*, *bc*, *cd*, *da*, are all roofed in, and bounded on the outer side by open pales guarded by coarse wire net, to prevent the teeth of the inmates gnawing them. They are separated by narrow partitions, which slide up to allow of the dogs having the whole run; or they may be left down, and the upper part open, so as to

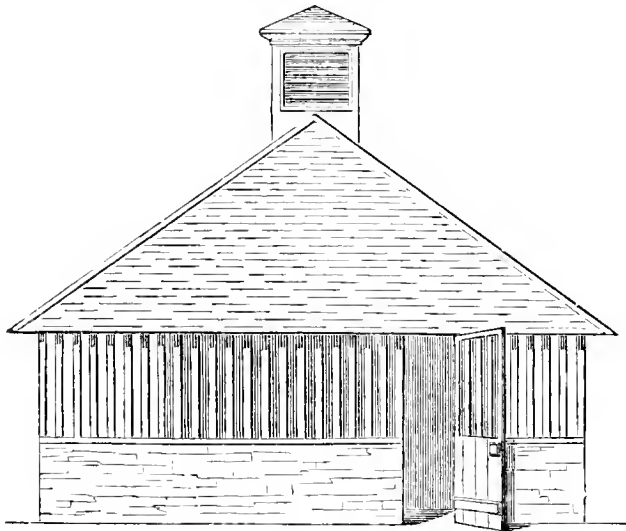

Elevation of Greyhound Kennel.

encourage the puppies to fence, by the necessity for jumping over them in pursuing one another. The floors should be of *glazed* tiles, adamantine clinkers, Dutch clinkers, Broseley bricks, or cement, the last being the most clean and free from absorption, which ought always to be entirely prevented. Each sleeping-place and yard should have a trapped drain, so as to carry off any wet

directly it falls, and the former should be built exteriorly of brick cemented at least a foot from the ground, with board partitions between them. A window should be in each, which is capable of being opened, and the ventilation should be secured by the plan introduced by Mr. Muir, whose address is 11, Ducie Street, Exchange, Manchester. This always secures a down-current as well as an up-current, so that there is little or no necessity for having the door open except for cleanliness, but in very windy weather the ventilation on the side of the wind should be closed, or the down-draught will be enough to chill the greyhounds. As these kennels are to be paved with a non-porous material, the soil is not of much consequence, but the situation should be dry and healthy, and the shade of a large tree is to be obtained if possible.

The *kennel management* of the greyhound consists in little more than the adoption of cleanliness, which should be of the most scrupulous kind, together with regular feeding. Water is by some people constantly left for them to get at, but others object to it for dogs in training, and they then only give it with the food. My own opinion is decidedly in favour of the constant supply, as it is impossible to prevent these animals from getting to it when at exercise; and I am sure that, when they are kept from it in-doors, they take too much while they are out. On the contrary, if it is regularly supplied to them, they take very little, and are quite careless about it at all times. The dressing and management of the feet form a part of the training of the greyhound, and will be treated of under the head of Coursing.

---

## FOXHOUND AND HARRIER KENNELS, ETC.

Unlike the greyhound kennel in many respects, that which we are now considering must be adapted for from thirty to a hundred couples of hounds, and the accommodation should therefore be more extensive, while a less degree of protection from the weather is desirable, because these hounds must be constantly exposed to long-continued wind and wet, and should therefore be hardened to them. The annexed description of the most desirable plan for kennels is chiefly derived from "Scrutator," who is, I believe, the most trustworthy as well as the most recent writer on the subject.

The kennel should be placed upon some high and dry situation; the building should face the south, and there should be no large trees near it. To hunt three or four days a week, you will require about forty couples of hounds according to the country. The lodging-rooms should be four in number, by which you will have a dry floor for the hounds to go on to every morning (the pack in the hunting season being in two divisions), instead of its being washed down whilst the hounds are left shivering in the cold on a bleak winter's day, which I have seen done when the huntsman has been too busy to walk them out during this process.

Nothing is more prejudicial to hounds than damp lodging-rooms, a sure cause of rheumatism and mange, to which dogs are peculiarly liable. I have seen them affected by rheumatism

in various ways, and totally incapacitated from working; sometimes they are attacked in the loins, but more often in the shoulders, both proceeding either from a damp situation, damp lodging-room, or damp straw, often combined with the abuse of mercury in the shape of physic. In building kennels, therefore, the earth should be removed from the lodging-room floor to the depth of a foot at least, and in its place broken stones, sifted gravel, or cinders, should be substituted, with a layer of fine coal-ashes, upon which the brick floor is to be laid, in cement or hot coal-ash mortar, taking care to use bricks which are not porous, or to cover them with a layer of cement, which last is an admirable plan. Outside the walls and close to them, an air-drain about three feet deep should be constructed with a draining pipe of two inches bore at the bottom, and filled up with broken stones to within six inches of the surface. This drain is to be carried quite round the building, and should fall into the main sewer. For a roof to the building I prefer thatch to tiles as affording more warmth in winter and coolness in summer; but as slate or tiles are more agreeable to the eye, a thin layer of reed placed under the tiles will answer the purpose.

Over the centre of the lodging-rooms should be a sleeping-apartment for the feeder, which being raised above the level of the other roof will break the monotony of its appearance. At the rear of the kennel should be the boiling-house, feeding-court, straw-house, and separate lodgings for bitches. In front of the kennels, and extending round to the back door of the

feeding-house, should be a good large green yard enclosed by a wall or palings. The former I prefer, although more expensive, because hounds, being able to see through the latter, will be excited by passing objects ; and young hounds, for whose service the green yard is more particularly intended, are inclined to become noisy, barking and running round the palings when any strange dog makes his appearance.

In the boiling-house will be required two cast-iron boilers, one for the meal, the other for flesh. Pure water must be in some way conducted to the kennels, both for cleanliness and for the preparation of food, and this should be laid on at the service of the kennel-man at all parts, so that there may be no excuse on the score of trouble in carrying it. There must also be coolers fixed in proportion to the number of hounds, each couple requiring from half a foot to a foot superficial, according as it is intended to make the puddings daily or every other day. Stone or iron feeding- and water-troughs are the best ; the latter should be fixed high enough to keep them clean.

To each lodging-room there should be two doors ; one at the back with a small sliding panel and high up, through which the huntsman may observe the hounds without their seeing him ; and another in the front with a large opening cut at the bottom, high enough and wide enough for a hound to pass through easily, and which should always be left open at night to allow free egress to the court. In addition there must also be another between each of the rooms, so as to throw two into



one in the summer for the purpose of making them more airy. The benches should be made of pine or oak spars, and if they are made to turn up according to the following plan several advantages result, being described, by a correspondent signing himself "Lepus," in the columns of "The Field," as follows:—

"KENNEL BENCHES.

"My benches are made of inch deal, cut into widths of three inches, and nailed half an inch apart to two transverse pieces, to which hinges are fixed to connect the bench with a board six

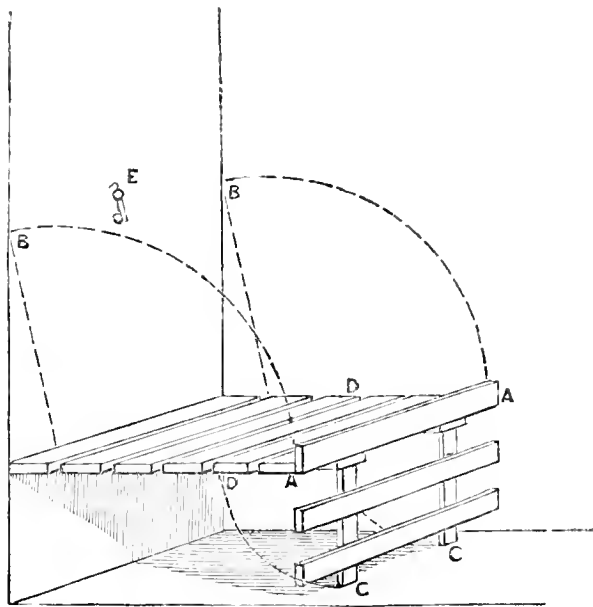

Plan of Kennel Bench for Hounds. A A folds to B B; C C folds to D D; E, hook to fasten bench back.

inches wide, fastened firmly to the wall about a foot from the ground. In front is a piece of board about three inches in width to keep the straw from drawing off with the hounds. To prevent

the hounds from creeping under, I nail two long laths the length of the bench across in front of the legs, which are hung with hinges in front of the bench, so that when the bench is hooked back they fall down and hang flat. By having the six-inch board between the hinges and the wall, it prevents the former from being strained when the bench is hooked back with straw upon it."

In some establishments there is a separate kennel for the young hounds, with a grass yard attached, for their own use, and it is certainly very advantageous; but with a little management the buildings above recommended will be sufficient, and with a saving of considerable expense. The hounds during the hunting season will not require it at all, as they should be walked out several times a day into a paddock or field, and should not be allowed to lie about anywhere but on their benches.

In the rear of the kennels should be a covered passage into which the doors of the middle kennel should open, and leading to the feeding-house, which stands under the same roof as the boiling-house, only separated from it by a partition. This passage should be so constructed as to make a foot bath for the hounds as they pass through after hunting, the bricks being gradually sloped from each end to the centre, where it should be a foot deep, with a plugged drain in the lowest part, to let the hot liquor or water off into a drain. On each side of this passage should be a paved court with a small lodging-house at each end; one for lame hounds, and the other for those which are sick.

The *ventilation* of the rooms composing the lodgings of the hounds must be carefully attended to, and for this purpose the shaft alluded to at page 228 is by far the best adapted. It resembles in external appearance that usually placed above well

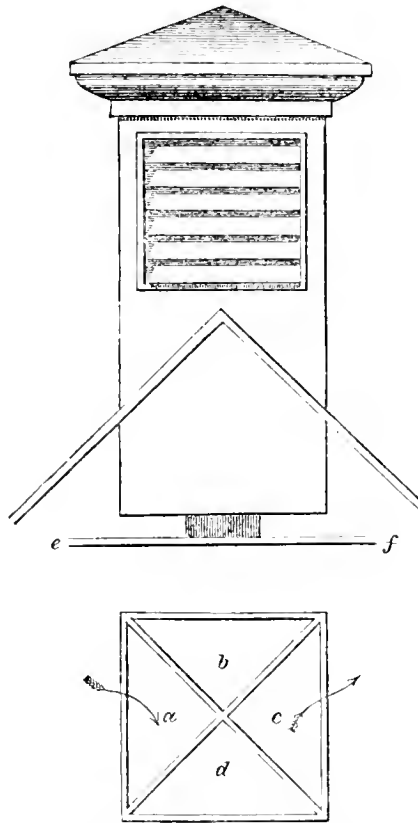

Muir's Ventilating Apparatus. *a, b, c, d*, the four divisions of shaft; *e, f*, board for distributing down current.

constructed stables, &c.; but there is this important internal alteration, that the square is divided perpendicularly into four triangular tubes, one of which is sure to be presented to the wind from whatever quarter of the compass it is blowing, while the opposite one allows the foul air to escape, to make room for that

descending through the first-named tube. When this is once constructed, it only remains to lead a metal tube from each of these four compartments to every one of the lodging-rooms, which will thus be as effectually ventilated as if each had an apparatus to itself. To carry this out well the lodging-rooms should be in a block, and then there will be a corner of each meeting in a common centre, above which the ventilator should be placed with the arrangement of tubes above described.

The *kennel management* of hounds is a much more difficult and important affair than is generally supposed, as upon its proper performance, in great measure, depends the obedience of the pack in the field. Sometimes it is entirely committed to the care of the feeder, but every huntsman who knows his business will take as much pains with his hounds in kennel as out, and though he will not of course prepare the food, yet he will take care to superintend it, and will always "draw" his hounds himself, for no one else can possibly know how to feed them. During the season this duty must of necessity devolve on the feeder or kennel-man on the hunting days, but the huntsman should always carry it out himself whenever he can. Hounds cannot be too fond of their huntsman, and though "cupboard love" is not to be encouraged in man, yet it is at the bottom of most of that which is exhibited by the dog, however much it may appear to take a higher range when once it has been properly developed.

The *regular daily kennel discipline* is as follows:—With the four lodging-rooms described there should always be two dry and clean in the early morning, having been washed the day before.

Into these the general pack should be turned, as soon as the doors are opened, or, if the morning is not wet, directly after a short airing in the paddock. The feeder then sweeps out the room in which they have slept, and afterwards mops it clean, drying the floor as much as possible, so that by ten or eleven o'clock it is fit for the hounds to re-enter. The men then get their breakfast, and directly afterwards the hounds are taken out to exercise, or the hunting hounds to their regular day's work. If the former, they are brought back to kennel at eleven o'clock, fed, and returned to their regular lodging-room, or in some kennels they are still kept in a separate room during the day and night, always taking care that they are not turned into a room while the floor is damp, and that strict cleanliness is practised nevertheless. The hour of feeding is generally fixed for eleven o'clock, but for the day before hunting it should be an hour or two later, varying with the distance they have to travel. Water should be constantly provided, taking care that the troughs are raised above the height at which dogs can pass their urine into it, which they will otherwise be constantly doing. As before remarked, iron troughs are the best. After feeding the hounds should remain quiet for the rest of the day, only stirring them in removing them from their day-room to their night-room, if two are allowed, which, I think, is an excellent practice.

The *food* of hounds is composed of meal flavoured with broth, to which more or less flesh is added, or with greaves as a substitute when flesh cannot be obtained. The relative value of the various meals is described at page 217, but I may here remark

that old oatmeal is the recognised food of hounds, though Indian meal is an excellent substitute. After boiling the flesh till the meat leaves the bones readily, take all out with a pitchfork, and put it to cool, skin all the fat off the broth, and fill up with water to the proper quantity; next mix the meal carefully with cold water, and then pour this into the hot broth, keeping it constantly stirred till it thickens; after which it should be boiled *very gently* till it has been on the fire for half an hour, continuing the stirring to prevent its burning. Lastly, draw the fire and ladle out the stuff into the coolers, where it remains till it has set, when it acquires the name with the solidity of "puddings." There should always be two qualities made, one better than the other for the more delicate hounds, which must be apportioned by the huntsman properly among them. This may be reduced with cold broth, when wanted, to any degree of thinness; and the meat, being cut or torn up, is mixed with it.

In *feeding the hounds*, the huntsman, having the troughs supplied with the different qualities of food, orders the door to be thrown open which communicates with the lodging-room; then, having the hounds under proper control, they all wait till each is called by name, the huntsman pronouncing each name in a decided tone, and generally summoning two or three couple at a time, one after the other. When these have had what he considers sufficient, they are dismissed and others called in their turn; the gross feeders being kept to the last, when the best and most nourishing part has been eaten. By thus accustoming hounds in kennel to wait their proper turn, and to come when called, a

control is obtained out of doors which could never be accomplished in any other way. Once a week, on a non-hunting day in the winter, and every three or four days in the summer, some green food, or potatoes or turnips, should be boiled up with the puddings, and serves to cool the hounds very considerably. If this is attended to very little physic is required, except from accidental causes.

*A regular dressing and physicking* is practised in some kennels, the former to keep the skin free from vermin and eruptions, and the latter with the same view, but also to cool the blood. This is by no means necessary, if great care is taken with regard to cleanliness, feeding, and exercise; and in the royal kennels neither one nor the other is practised, excepting when disease actually appears, and not as a preventive measure. When it is considered desirable to adopt either or both, directions for their use will be found given in the next Book.

---

#### POINTERS AND SETTERS.

These dogs do not require a covered yard, and may be treated in all respects like hounds, the only difference being in regard to numbers. More than three or four brace should not be kept together if it can be avoided, as they are apt to quarrel when not thoroughly exercised or worked, and then a whole lot

will fall upon one and tear him almost to pieces. The rules of cleanliness, feeding, &c., are the same as for hounds.

---

#### SINGLE DOGS KENNELLED OUT OF DOORS.

Where a single dog is kept chained up to what is called a kennel, care should be taken to pave the ground on which he lies, unless he can be moved every month, or still more frequently, as in course of time his urine stains the ground so much as to produce disease. It should always be borne in mind that the dog requires more exercise than he can take when chained up, and he should therefore be set at liberty for an hour or two daily, or at all events every other day.

---

#### HOUSE DOGS.

The great bane of dogs which are at liberty to run through the house is that they are constantly receiving bits from their kitchen, as well as from their parlour, friends. The dog's stomach is peculiarly unfitted for this increasing demand upon it, and, if the practice is adopted, it is sure to end in disease before many years



are passed. The rule should be strictly enforced, to avoid feeding more than once or twice daily, at regular hours, and then the quantity and quality should be proportioned to the size of the dog and to the amount of exercise which he takes. About one twentieth to one twelfth of the weight of the dog is the proper amount of food, and all beyond this is improper in most cases, though of course there are some exceptions. Dogs are very cleanly animals, and often refuse to dirty a carpet or even a clean floor; they should therefore be turned out at proper times to relieve themselves, the neglect of which is cruel, as well as injurious to the health. I have known dogs retain their excretions for days together, rather than expose themselves to the anger which they think they should incur, and I believe some high-couraged animals would almost die before they would make a mess. Long-haired dogs, when confined to the house, are apt to smell disagreeably if they have much flesh, and they should therefore be chiefly fed upon oatmeal porridge, with very little flavouring of broth or meat mixed up with it.

## CHAPTER IV.

## BREAKING AND ENTERING.

The Entering of the Greyhound and Deerhound.—Of Foxhounds and Harriers.—  
 Breaking the Pointer and Setter.—The Retriever (Land and Water).—The  
 Spaniel.—The Vermin Dog.

WITH the exception of the greyhound, sporting dogs require some considerable education to the sport in which they are to be engaged. Unlike the hound and the dogs intended for the gun, greyhounds have only their instinctive desires to be developed, and as no restraint is at any time placed upon these, except that depending upon mechanical means which they cannot get rid of, nature has uncontrolled sway. Hence their entering is a very easy process; nevertheless, there are some precautions to be taken which it is necessary to describe. The deerhound, as well as the greyhound, is held in slips, a single one being used for him, and a double slip, or pair of slips as it is called, for the two greyhounds which form the complement for coursing the hare, a greater number being considered unfair, and therefore unsportsmanlike. These slips are so made that by pulling a string the neck-strap is loosed, and the two dogs are let go exactly at the same moment. They are always used in public coursing, but in private the greyhounds are sometimes suffered

to run loose, waiting for the moment when the hare is put up by the beaters or by the spaniels, which are occasionally employed. Hounds also are coupled under certain circumstances, but they are never slipped at the moment when game is on foot, and they must therefore be made steady from "riot."

---

#### THE ENTERING OF THE GREYHOUND AND DEERHOUND.

Whether for public or private coursing, the greyhound should not be suffered to course a hare until he is nearly at maturity; but as the bitches come to their growth before the dogs, they may be entered earlier than the latter. About the tenth month is the best time for forward bitches, and the twelfth or fourteenth for dogs. If therefore a greyhound is to be allowed to see a hare or two at this age, he or she must be bred early in the year, in order to have a brace late in the spring, so as to be ready for the next season. Some people invariably prefer keeping them on to the autumn, and for private coursing there is no reason whatever for beginning so early; but public coursers begin to run their dogs in puppy stakes in the month of October, prior to which there is so little time after the summer is passed, that they prefer beginning in the spring if their dogs are old enough, and if they are not they will not be fit to bring out in October.

*Before being entered* the dogs must be taught to lead quietly,

as they cannot be brought on to the ground loose, and if not previously accustomed to it, they knock about and tear themselves dreadfully, and moreover will not go quietly in slips. As soon therefore as the ground is soft, after they are six or eight months old, they should have a neck-strap put on, and should be led about for a short time daily, till they follow quietly. Some puppies are very violent, and will fight against the strap for a long time, but by a little tact they soon give in, and follow their leader without resistance. The coursing-field is the best school for this purpose, as the puppies have something to engage their attention, and until they will bear their straps without pulling against them their education in this respect is not complete. A dog pulling in slips will do himself so much harm as often to cause the loss of a course, and therefore every precaution should be taken to avoid this fault. The leader should never pull against the puppy steadily, but the moment he finds him beginning to hang forward, give him a severe check with the strap, and repeat it as often as necessary. It is a very common defect, but never ought to occur with proper management; though when once established it is very difficult to get rid of. Two or three days' leading on the coursing-field will serve to make any puppies handy to lead if properly managed, and they may then be put in slips with perfect safety.

The *condition* of the puppy at the time of entering is too often neglected, but it should be known that a fat over-fed puppy without previous exercise may be seriously injured even by a short course, which, moreover, can never be assured under any

circumstances, as the hare will sometimes run in a different direction to that which is expected.

A *sapling*, as the young greyhound is called to the end of the first season after he is whelped, should never be trained like an old one, as the work is too severe, and his frame is not calculated to bear it, but he may be reduced in flesh by light feeding, and allowed to gallop at liberty for two or three hours a day, giving him that amount of walking exercise and as much galloping as he likes to take. With these precautions, he will be fit to encounter any hare in a short course, which is all that should ever be allowed, as far as it is possible to foresee what will happen.

*Whether an old assistant or a young one* shall be put down with a sapling is a subject which admits of some discussion. If the former, the young dog has small chance of getting to work at all, and if the latter, he may have so little assistance as to be greatly distressed. Few people like to put down an honest old dog with a sapling, and a cunning one soon teaches the tricks which he himself displays. Sometimes young dogs have great difficulty in killing, and want the encouragement afforded by blood; in such a case, a good killer may be desirable, but with no other object could I ever put down an old dog with a sapling. Before they are going to run in a stake, an old dog of known speed should be put in slips with the puppy, in order to arrive at a knowledge of the powers of the latter, but this is with a view to a *trial*, and not as part of the entering of the greyhound. When a sapling has run enough hares to know his

work, and has killed a hare, or been present at the death of one, he may be put by as properly entered; and the number required will average about five or six—more or less according to the cleverness of the particular animal, which will generally depend upon his breed.

*The deerhound is entered* at his game on the same principles as the greyhound, but as red deer are more scarce than hares it requires more time. It is always better to slip him with an older companion, but beyond this precaution everything must be left to his natural sagacity. As his nose is to be brought into play, and as he may possibly cross the scent of hares or other game, he must be made steady from all “riot,” and, if possible, should be taken up, in couples, to the death of a deer once or twice and “blooded,” so as to make him understand the nature of the scent. His instinctive fondness for it will, however, generally serve him without this, but the precaution is a good one, and may save some trouble and risk. He will not do much in aid of his older companion in *hunting* the animal he is slipped at, but when “at bay” he is soon encouraged by example to go in and afford his help, and this is the time when a second deerhound is chiefly wanted.

---

#### THE ENTERING OF FOXHOUNDS AND HARRIERS.

The first thing to be done with hound puppies, when they come into kennel, is to get them used to their new masters and to their

names, which ought to have been given them "at walk." For some little time the puppy often refuses to be reconciled to its confinement in his new home, and sulks by himself in a corner, refusing to eat and to follow his feeder or huntsman. This, however, soon goes off; but till it does there is no use in attempting to do anything with the dog. When the puppies are quite at home they may be taken out by the feeder, at first in couples, and then by degrees removing these and allowing them to run free. For some time it will be prudent to take only six or seven couples at a time, as when any "riot" makes its appearance there is enough to do even with this number, and more would be quite unmanageable. Indeed the huntsman will do well to take out only a couple or two at a time into the paddock with him, till they are thoroughly accustomed to his voice, and have found out that he must be obeyed. As soon as they are tractable on the road, they may be walked among sheep and deer, where they should at first all be in couples, and then only one or two should be loosed at a time; but before long the whole pack should be accustomed to resist the temptation, till which time they are unfit to be entered. It is also highly necessary that foxhounds should in the same way be broken from hare and rabbit; but too much must not be attempted with them until they are entered to fox, as their spirit and dash would be discouraged, if the whip or rate were always being used without the counter-cheer in favour of some kind of game.

*All hounds require daily exercise, without which they cannot be preserved in health, nor can their high spirits be controlled, as if they are not exercised they will be always requiring the whip.*

If, however, the huntsman takes them out daily in the morning on the road, which hardens their feet, and in the evening in the paddock, they are so orderly that anything may be done with them. For this purpose the men should be mounted in the morning, but in the evening they may be on foot.

*Cub-hunting*, which is the name given to the process by which young hounds are entered, begins in August as soon as the corn is cut, and the time will therefore vary with the season and the country. In some places, as in the New Forest for instance, it may be carried on at any time, but this month is early enough. It is better to take out the old hounds once or twice till they have recovered their summer idleness, as a good example is everything to the young hound. When the young entry are to be brought out, it is very desirable to find as quickly as possible, and some cautious huntsmen go so far as to keep them coupled till the old hounds have found their fox; but if they have been made steady from "riot" there is no occasion for this. If, however, they have never been rated for "riot," there is no great harm in their hunting hare or anything else at first, till they know what they ought to do; after which they must be rigidly kept to their game. But cub-hunting is not solely intended to break in and "enter" the hound, it has also for its object to disperse the foxes from the large woodlands which form their chief holds in all countries; and, as these cannot show good sport during the season, they are well routed before it commences, to drive the foxes into smaller coverts, while at the same time the hounds may be rendered steady, and by practice enabled to work their fox. Very often



the master will take advantage of an opportunity to have a nice little burst to himself; and, if the hounds are not made to hustle the foxes through the large woodlands, good after sport cannot be expected. Independently of the above object, cub-hunting is practised in August, September, and October, firstly, in order to give the young hounds blood, which they can obtain easily from a litter of fat cubs; secondly, to break them from "riot," while they are encouraged to hunt their own game; and, thirdly, to endeavour to break them of sundry faults, such as skirting, &c. ; or, if apparently incurable, to draft them at once. These objects are generally attained by the end of October, when the regular season begins.

*Harriers and beagles* are entered to hare on the same principle, the scent of the fox and deer, as well as that of the rabbit, being "riot" to them, and strictly prohibited. *Otterhounds* also have exactly the same kind of entry, although the element they work in is of a different character.

---

#### THE BREAKING OF THE POINTER AND SETTER.

The following observations on the breaking of these dogs appeared in "The Field," during the spring of 1858, and are believed to embody the general practice of good breakers:—

As the method is the same for each kind, whenever the word pointer is used, it is to be understood as applying equally to the setter.

It is scarcely necessary for me to remark that no single life would suffice to bring the art of breaking dogs to all the perfection of which it is capable, when the various improvements of succeeding generations are handed down from one to the other; and therefore I neither pretend to be the inventor of any method here detailed, nor do I claim any peculiarity as my own. All the plans of teaching the young dog that will be found described by me are practised by most good breakers; so that there will be nothing to be met with in my remarks but what is well known to them. Nevertheless, they are not generally known; and there are many good shots who are now entirely dependent upon dog-dealers for the supply of their kennels, and who yet would infinitely prefer to break their own dogs, if they only knew how to set about it. Others, again, cannot afford the large sum which a highly accomplished brace of pointers or setters are worth in the market; and these gentlemen would far rather obtain two or three good puppies and break them with their own hands, with expenditure of little more than time, than put up with the wretchedly broken animals which are offered for sale by the dozen at the commencement of every shooting season. To make the utmost of any dog requires great experience and tact, and therefore the ordinary sportsman, however ardent he may be, can scarcely expect his dogs to attain this amount of perfection; but by attending to the following instructions, which will be given in plain language, he may fairly hope to turn out a brace of dogs far above the average of those belonging to his neighbours.

One advantage he will assuredly have when he begins the actual war against the birds in September, namely, that his dogs will cheerfully work for him, and will be obedient to his orders; but at the same time he must not expect that they will behave as well *then* as they did when he considered their education complete in the previous April or May. No one who values "the bag" above the performance of his dogs will take a young pointer into the field at all, till he has been shot over for some time by a man who makes it his business to break dogs, and who is not himself over-excited by the sport. It is astonishing what a difference is seen in the behaviour of the young dog when he begins to see game falling to the gun. He *may* go out with all the steadiness which he had acquired by two months' drilling in the spring; but more frequently he will have forgotten all about it, unless he is well hunted in the week previous to the opening of the campaign. But no sooner has he found his birds or backed his fellow-pointer, and this good behaviour has been followed by the report of the gun, heard now almost for the first time, and by the fall of a bird or two within a short distance, than he becomes wild with excitement, and, trying to rival the gun in destructiveness, he runs into his birds, or plays some other trick almost equally worthy of punishment. For this there is no remedy but patience and plenty of hard work, as we shall presently find; and I only mention it here, in order that my readers may not undertake the task without knowing all its disagreeables as well as the advantages attending upon it.

Supposing, therefore, that a gentleman has determined to break a brace of pointers for his own use, without assistance from a keeper, let us now consider how he should set about it.

In the first place, let him procure his puppies of a breed in which he can have confidence. He will do well to secure a brace and a half, to guard against accidents or defects in growth. Let these be well reared up to the end of January, or, in fact, until the birds *are paired and will lie well*, whatever that time may be. They should be fed as directed in the last chapter. A few bones should be given daily, but little flesh, as the nose is certainly injuriously affected by this kind of food; and without attention to his health, so as to give the dog every chance of finding his game, it is useless to attempt to break him. The puppies should either be reared at full liberty at a good walk, or they should have an airy yard, and should then be walked out daily, taking care to make them know their names at a very early age, and teaching them instant obedience to every order, without breaking their spirit. Here great patience and tact are required; but, by the owner walking them out himself two or three times a week and making them fond of him, a little severity has no injurious effect. In crossing fields the puppies should never be allowed to "break fence," even if the gates are open, but should be called back the moment they attempt to do so. These points are of great importance, and by attending to them half the difficulty of breaking is got over; for, if the puppy is early taught obedience, you have only to let him know what he is required to do, and he does it as a matter of course. So also the

master should accustom his puppies from the earliest age to place a restraint upon their appetites when ordered to do so; and if he will provide himself with pieces of biscuit and will place them within reach of the dog, whilst he prevents his taking them by the voice only, he will greatly aid the object he has in view. Many breakers carry this practice so far as to place a dainty morsel on the ground before the dog when hungry, and use the word "Toho" to restrain him; but this, though perhaps hereafter useful when inclined to run in upon game, is by no means an unmixed good, as the desire for game in a well-bred dog is much greater than the appetite for food, unless the stomach has long been deprived of it.

Besides these lessons prior to breaking, it will be well to teach the dog to come to heel, and to keep there, also to run forward at the word of command, to lie down when ordered, and to remain down. All these several orders should be accompanied by the appropriate words afterwards used in the field, viz.

WORDS OF COMMAND USED TO THE POINTER AND SETTER.

1. To avoid breaking fence—"Ware fence."
2. To come back from chasing cats, poultry, hares, &c.—"Ware chase."
3. To come to heel, and remain there—"To heel," or "Heel."
4. To gallop forward—"Hold up."
5. To lie down—"Down," or "Down charge."
6. To abstain from taking food placed near, equally applied to running in to birds—"Toho."

When these orders are cheerfully and instantly complied with by the puppy, it will be time to take him into the field, but not till then. Many breakers during this period accustom their dogs to the report of the gun, by firing a pistol off occasionally while they are a short distance off, and in a way so as not to alarm them. This is all very well, and may prevent all danger of a dog becoming "shy of the gun;" but with a well-bred puppy, properly reared, and not confined too much so as to make him shy in other respects, such a fault will seldom occur. Nevertheless, as it does sometimes show itself, from some cause or other, the above precaution, as it costs little trouble or expense, is not to be objected to. It is also advantageous to accustom the dog to drop when the pistol is discharged, and, if he is of high courage, he may be drilled to this so effectually that he never forgets it. By the aid of a "check cord," wherever the dog is when the pistol is discharged, he is suddenly brought up and made to drop with the command "Down charge;" and in process of time he associates one with the other, so that whenever he hears a gun he drops in an instant. Timid dogs may however be made shy in this way, and unless the puppy is evidently of high courage, it is a dangerous expedient to resort to; as, instead of making the dog, it may mar him for ever.

Next comes the teaching to "range," which is about the most difficult part of breaking. Many sportsmen who have shot all their lives are not aware of the extent to which this may be, and indeed ought to be, carried; and are quite content if their dogs "potter" about where they like, and find game anyhow.

But the real lover of the dog, who understands his capabilities, knows that for perfect ranging the whole field ought to be beaten systematically, and in such a way as to reach all parts in succession, the dog being always as near to the gun as is consistent with the nature of the ground, the walking powers of the man, and the degree of wildness of the game. All these varying points of detail in the management of the dog while beating his ground will, however, be better considered at a future stage of the inquiry ; so that at present, taking it for granted that what I have assumed is the real *desideratum*, we will proceed to inquire how this mode of ranging is best taught. It must be understood that what we want is,—first, that the puppy should hunt freely, which soon comes if he is well bred ; secondly, that he should range only where he is ordered, and that he should always be on the look-out for his master's hand or whistle to direct him. This also is greatly dependent on breed, some dogs being naturally wilful, while others from their birth are dependent upon their master, and readily do what they are desired. Thirdly, great pains must be taken to keep the puppy from depending upon any other dog and following him in his line, and also from “pottering,” or dwelling on “the foot-scent,” which, again, is a great deal owing to defective blood. Now, then, how are these points to be attained ? By a reference to the annexed diagram, the principle upon which two dogs should beat their ground is laid down ; the dotted line *a a a a* representing the beat of one, and the plain line *b b b b* that of the other dog. But, with a raw puppy, it is useless to expect him to go off to the right while

his fellow proceeds to the left, as they afterwards must do if they perform their duty properly; but, taking an old dog into a field with the puppy, the former is started off with the ordinary words "Hold up" in either line laid down, which, being properly

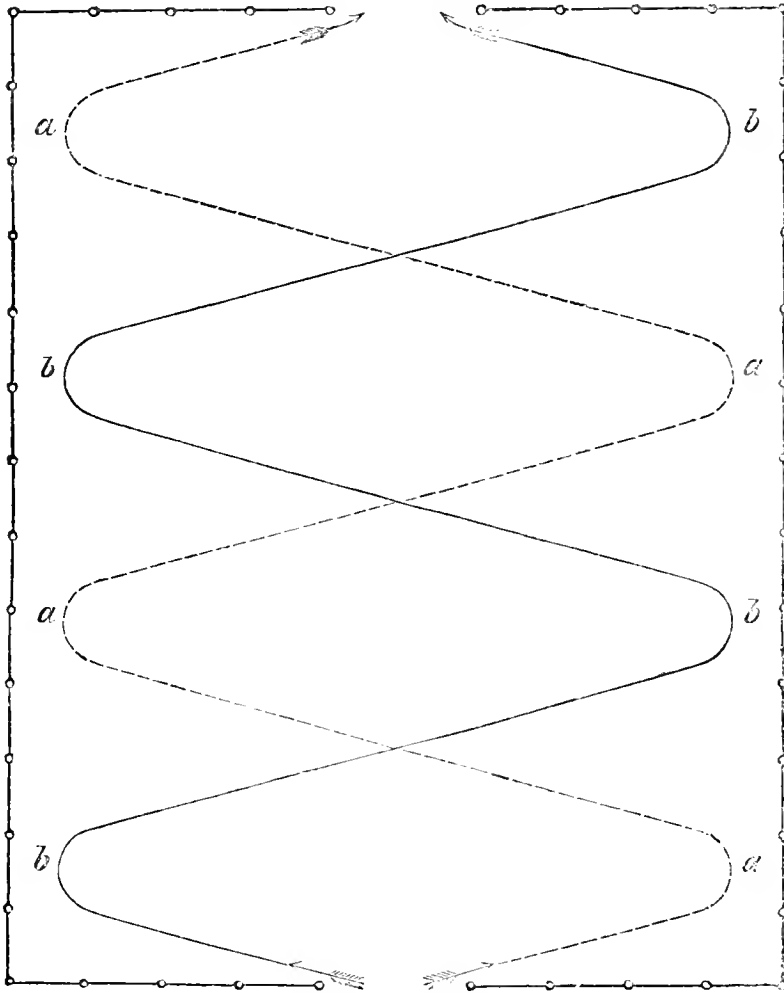

broken, he proceeds to follow out, accompanied by the puppy, who does not at all understand what he is about. Presently the old dog "finds," and very probably the young one goes on and



puts up the birds, to the intense disgust of his elder companion, but to his own great delight, as shown by his appreciation of the scent, and by chasing his game till out of sight. At the present stage of breaking, the puppy should by no means be checked for this, as he knows no better, and the great object is to give him zest for the work, not to make him dislike it ; so that, even if he runs in to half a dozen pairs of birds, it will do him no harm, however jealous it may make the old dog. As soon, however, as the young one seems decidedly inclined to go to work by himself, take up the old dog, and hunt the young one till he is thoroughly tired or till he begins to point, which he will often do before that time arrives if he is well enough bred. At first, when he comes upon a scent, he will stop in a hesitating way, then draw rapidly up and flush his birds, chasing them as before ; but gradually, as he tires, he gains steadiness, and, after a time, he assumes the firm attitude of the true pointer or setter, though this is seldom shown in perfection for the first two or three days. Let it be clearly understood, that the present lesson is solely with a view to teach the range, steadiness in the point being at first quite subordinate to this quality, though in well-bred dogs it may often be taught at the same time. Hundreds of puppies are irretrievably spoiled by attempting to begin with teaching them to stand, when, by undue hardship and severity, their relish for hunting or beating the ground is destroyed ; and they are never made to do this part of the work well, although their noses are good enough when they come upon game, and they stand for a week if allowed to do so. Keep to

the one object till the puppy will beat his ground as shown in the diagram, at first single-handed, and then crossing it with another dog; but it seldom answers to use two together until steadiness at "the point" is attained, as there are few old dogs which will beat their ground properly long together when they find that they are worked with a young one which is constantly flushing his birds or committing some other *faux pas*. For these reasons it is better to work the young ones at first singly, that is, as soon as they *will* work; and then, after they range freely and work to the hand and whistle, turning to the right or left, forwards or backwards, at the slightest wave of the hand, and when they also begin to point, it is time enough to "hunt them double."

In order to complete the education of the pointer in *ranging* or *beating his ground*, it is not only necessary that he should "quarter" it, as it is called, according to the method inculcated at page 254 *et seq.*, but that he should do it with every advantage of the wind, and also without losing time by dwelling on a false scent, and, above all, avoiding such careless work as to put up game without standing to a point at all. I have before explained the principle upon which a field is to be "quartered," and described the way in which the dog is to be set to do his work, by the hand and voice, aided by the whistle. As a general rule, pointers find their game by the scent being blown to them from *the body*, constituting what is called a "body-scent," and not from that left by the *foot* on the ground, which is called a "foot-scent." Hence it is desirable in all cases to

give the dog the wind, that is to say, to beat up towards the wind's eye; and therefore the breaker will put his dogs to work in that direction; and then, though they do not always beat directly towards the wind, yet they have it blowing from the game towards them in each of their crossings. (See diagram on p. 255.) But suppose, as it sometimes happens, that the sportsman cannot well do this, as when birds are likely to be on the edge of a manor, with the wind blowing on to it from that over which he has no right of shooting;—here, if he gave his dog the wind in the usual way, he would drive all the birds off his own beat; and, to avoid this, he begins at the edge of it, and makes his pointers (if they are well enough broken) leave him and go up the other side to the far end of the field (if not too long), and then beat towards him in the usual way. It is true that the necessity for this kind of beating does not often occur; but sometimes a considerable number of shots are lost for want of teaching it, and the perfect dog should understand it thoroughly. When, therefore, the puppy has learnt to range in the ordinary way, and will work to the hand well, as before described, give him a lesson in this kind of beating; and, if any difficulty occurs, send a boy to lead him until he is far enough away, and then let the biped loose his charge, first catching the dog's eye yourself, so as to make him aware that you are the person he is to range to. In a few lessons he soon begins to find out the object of this departure from the usual plan, and by a little perseverance he will, of his own accord, when he finds he has not got the wind, work so as to make a

circuit and get it for himself. Nevertheless, a good dog, *who has a master as good as himself*, should always wait for orders, and there is always some excuse for very clever ones becoming headstrong when they are constantly misdirected. Let me again repeat what I have observed on the importance of teaching, *at first*, the correct mode of quartering the ground, and of persevering (without regard to standing or pointing) in the lessons on this subject alone, until the puppy is tolerably perfect in them. At the same time it is true that some little attention may be paid to the "point;" but this is of far less consequence at the early stage which we are now considering. Indeed, in most well-bred dogs, it comes naturally; but none beat to the hand without an education in that particular department.

But at this stage it will be frequently needful to correct *various faults* which are apt to show themselves in young dogs, such as (1) "hunting too low," leading to "pottering or dwelling on the foot-scent;" (2) hunting too wide from the breaker; and (3) "blinking," or leaving the game as soon as found, which last is a fault depending on undue previous severity. With regard to the first of them, there is, unfortunately, no certain remedy for it; and the puppy which shows it to any great extent after a week or ten days' breaking will seldom be good for much, in spite of all the skill and trouble which an experienced breaker can apply. The method of cure most commonly adopted is that called hunting with a "puzzle-peg" on, which is shown applied in the annexed cut. It consists of a piece of

strong wood, such as ash or oak, attached to the neck by a leather collar, and to the jaw by a string tied just behind the tusks or canine teeth, so as to constitute a firm projection in continuation of the lower jaw; and, as it extends from six to



nine inches beyond it, the dog cannot put his nose nearer to the ground than that amount of projection will allow of. The young dog should be well accustomed to it in kennel and in the field, before he is hunted in it; for when it is put on for the first time it inevitably "cows" him so much as to stop all disposition to range; but by putting it on him for an hour or two daily while he is at liberty and not expected to hunt, he soon becomes tolerably reconciled to it, and will set off on his range when ordered or allowed. With it on, a foot-scent can seldom be made out, unless pretty strong; but, at all events,

the dog does not stoop to make it out in that spaniel-like style which occasions its adoption. Nevertheless, when it is left off, the old tendency to stoop most frequently reappears, more or less, and the sportsman finds that all his care has been thrown away. Still I have known it cure this fault, and if it fails I have no other suggestion to offer but sixpennyworth of cord or "a hole in the water." If used at all, it must be kept on for many days together, that is to say, while at work, and when left off it should be occasionally reapplied if the dog shows the slightest tendency to put his nose down, or dwell on the scent where birds have been rising or have "gone away." I may here remark that "false pointing" is altogether different from this low hunting, though often coupled with it; but this we shall come to after describing the nature of, and mode of teaching, that part of the pointer's education. There is a wonderful faculty in some breeds of feeling a body-scent at long distances, while they have no perception of the foot-scent, and this is the quality which ought to be most highly prized in the pointer or setter, unless he is also wanted to retrieve, in which latter case such a nose will be found to be defective. But of this also we shall come to a more close understanding in a future part of this inquiry. In addition to the use of the "puzzle-peg,"—which should only be resorted to in extreme cases, and even in them is, as I before remarked, of doubtful utility,—the voice should be used to cheer the dog when he dwells on the scent too long, or carries his nose too low. "Hold up!" may be cried in a cheering way, and the dog encouraged with the hand waved

forward as well. Colonel Hutchinson recommends the previous inculcation of the perception of *height*,—in fact, to make the dog understand that you mean, when you use the word “Up,” that he should raise his head. But this is a refinement in dog-breaking which possibly *may* be carried out, yet which, I confess, I think practically inoperative. Few of us would like to teach [our hacks to lift their knees, by giving them to understand the nature of height, and then telling them to lift them. We should certainly find it much more simple to select hacks with good action, or to breed them even, rather than to convert our colt-breakers into circus-men. If there were no other method of attaining the object, by all means adopt it; but, when a far easier one is at hand, I should certainly select it in preference. Nevertheless, it may serve to prove the teachableness of the dog; and, knowing the extent to which his education may be carried by patience and perseverance, I have no doubt that Colonel Hutchinson’s plan is capable of execution, if the time and trouble necessary for it were properly remunerated. But we must now proceed to the second fault, which consists in ranging too far from the breaker. This may readily be cured, either by compelling attention to the hand and voice, with the aid of the whip in bad cases; or by attaching to the dog’s collar a long cord, which is then suffered to trail on the ground, or is held in the hand of the breaker when the dog is very wild. Twenty, thirty, or at most forty, yards of a small box-cord will suffice for this purpose, and will soon tire down the strongest and most unruly dog. Indeed, an application of

it for a short time will make many dogs give in entirely; but some high-couraged ones, and setters especially, will persevere with it on till they are fairly exhausted. This "check-cord," as it is called, is also necessary in some dogs, to perfect their education in other respects, and, indeed, is chiefly wanted at a later period of breaking, not being often required at this stage.

Having described the mode of teaching pointers and setters to beat their ground, I have now to consider the best modes of teaching them (1) to point, set, or stand (which are different names for the same act), (2) to back, (3) to down charge, (4) to retrieve, if considered desirable, and (5) how to remedy certain faults, such as blinking, &c.

*Pointing, setting, or standing* is taught as follows. It will, of course, be discovered in practice that, in teaching the range, most dogs begin to point, and nineteen out of twenty, if well-bred, become steady enough, *without the gun*, before they are perfect in the proper mode of beating their ground. For these, then, it is unnecessary to describe any other means of teaching their trade; but there are some few exceptions, in which, even after a fortnight's work, the dog is still deficient in this essential, and, though he beats his ground in ever so perfect a manner and finds his birds well enough, yet he invariably runs them up, sometimes with great zest and impudent disregard of his breaker, and at others with evident fear of the consequences. Here, then, something more must be done, and it is effected by taking the young dog out with a steady companion and hunting them together; then, keeping the old dog within forty yards, let him, if possible, be the one to



find, and take care to walk up to him before the young one comes up, which he is sure to do as soon as he catches his eye on the point. Now use your voice in a severe but low tone to stop him; and, as he has been accustomed to halt with the word "Toho!" he will at once do so, generally standing in a cautious attitude, at a distance varying with his fear of his breaker and the amount of courage which he possesses. If the birds lie close, let him draw up and get the scent; and the excitement will then be so great, that, if he is under sufficient command to be held in check by the "Toho!" he will be sure to assume the rigid condition characteristic of his breed. Now go quietly up to him, pat him, and encourage him, but in such a tone as to prevent his running in,—still using the "Toho! good dog; toho!"—and keeping him for a few minutes where he is, so long as he can scent his birds, which he shows by champing and frothing at the mouth. After the lapse of this time, walk quietly forward, keeping your eye on him, and still restraining him with the "Toho," put up the birds, and then, if possible, make him drop with the words "Down charge!" the meaning of which he has already been taught. But, if he is very wild and of high courage, do not attempt this at first, as it is better to proceed step by step, and to teach each department thoroughly before another is commenced. In this way, by perseverance and hard work (which last is the keystone of the breaker's arch), any dog, whether of the special breeds used for the purpose or not, may be made to point when he finds game; but none but the pointer and setter become rigid or cataleptic, a peculiarity which is con-

fined to them. In very high-couraged dogs a check-cord, thirty or forty yards in length, is sometimes suffered to trail on the ground, or is held by the breaker, so as to assist the voice in stopping the dog when he is wanted to make his stand; but the cases where this is wanted are so rare as scarcely to require any allusion to it, if the breaker is sufficiently industrious to give work enough to his charge. This part of the education is generally effected in a couple of lessons, without trouble, and, indeed, the young dog often points steadily enough at the first or second scenting of game.

*Backing.*—When a dog has acquired the merely instinctive property already described, he is said to be “steady before,” and may be used *alone* or *single-handed* without any further education; but when he is to be hunted with other dogs he requires to be made “steady behind,” that is to say, he must be taught to “back” another dog as the latter stands. In very high-bred dogs this property, like the former, is developed very early; but, the more hardy and courageous the breed, the longer they generally are in acquiring it, and therefore the young breaker should not be discouraged if he finds that his puppies give him some trouble after they have learnt to stand perfectly steady. Backing is usually taught in the same way as described for standing, that is to say, by hunting with an old steady dog, *taking care that he is one whose find is to be depended on*, and then stopping the young one with the voice and hand, or with the aid of a check-cord if necessary. The great art consists here in managing to get between the two dogs at the moment when the old one stands,

and thus to be able to face the puppy as he rushes up to share the scent with his rival, which he at first considers his companion to be. Jealousy is a natural feeling in all dogs from their desire to obtain approbation ; but it must be eradicated in the pointer and setter, or they never become steady together, and whichever finds first the other tries to run up and take the point from him. To avoid this failing, leave the dog which first finds alone, and walk up to the one which you have stopped, pat and encourage him with the word "Toho!" in a low but pleased tone; let him not on any account creep forward a step, but keep him exactly where he is for some minutes, if the birds lie well. Then walk forward to the old dog, but take no notice of him, and, with your eye still on the puppy, put up the birds, having stopped him with voice and hand if he moves a limb. Supposing the old dog has pointed falsely, the young one is materially injured, inasmuch as he has lost confidence in him, and next time he is with more difficulty restrained from running in to judge for himself; hence the necessity for a good nose in the old dog, who ought to be very steady and perfect in all respects. It will thus be seen that very little art is required in carrying out this part of the education, which really demands only hard walking, patience, and perseverance to complete it in the most satisfactory manner. It should be pursued day after day, till the young dog not only finds game for himself and stands quite steadily, but also backs his fellows at any distance, and without drawing towards them a single step after he sees them at point. When this desirable consummation is effected to such an extent that the puppy will back even a

strange dog, and has already learnt to beat his ground properly, as explained in my previous remarks, he is steady and well broken as he can be without the gun, and may be thrown by until a fortnight before the shooting season, when he ought to be taken out again for two or three days, as in the interval he will generally have lost some of his steadiness. Still he will only require *work* to restore it, as he knows what he ought to do; and with patience, joined if necessary with a little punishment, he soon re-acquires all that he had forgotten. Many masters now fancy that all is done towards "making the pointer:" but, on the contrary, they find that after birds are killed the puppy which was previously steady becomes wild and ungovernable, and spoils the day's shooting by all sorts of bad behaviour. Hence it is that breakers so often are blamed without cause; but when it is found by experience that such conduct is the rule, and not the exception, young dogs are left by their owners to be shot over by a keeper for a few days, or even longer, before they are taken into the field. Another reason for this wildness may be assigned; namely, the dogs are often hunted in the commencement of the season by almost perfect strangers, two or three guns together; whereas, if their breaker had the management, they would be under much more control, and especially if he went out quietly by himself. Here again is another reason for gentlemen breaking their own dogs, or, at all events, finishing their education by giving their dogs and *themselves* a few lessons together.

*Down charge*, as already described, ought to be taught from a very early period, the dog being made to drop at the word

or elevation of the hand of his master, without the slightest hesitation. It is not, therefore, necessary to dwell upon this part of his education, further than to remark that after each point, or, indeed, directly after birds rise under any circumstances, the dog should be made to drop by the voice, using the order "Down charge!" or by raising the hand if the eye of the dog can be caught. When this practice is made habitual, there is little trouble in carrying out the order until the gun is added; but then it will be found that great patience and forbearance are required to prevent the dog from running to his birds as they drop; for, if this is allowed, it is sure to make him unsteady in every case as soon as his eye catches sight of game, whether after the point or not. It is now that the advantage of having made the dog drop to the gun is manifested, for the first thing he thinks of when the gun is fired is the necessity for dropping, and if this is encouraged all goes on well. Too often the shooter himself produces unsteadiness, by disregarding his dog at the moment when he ought to attend to him most particularly, and by running in himself to take care of his "bag" considering that more important than the steadiness of his dog. It is true that a runner is sometimes lost by the delay of a few seconds while the discharged barrel is reloaded; but in the long run, the shooter who keeps his dog down till he has loaded will bag the most game.

*The faults which chiefly require correction at this stage are: blinking, shying the gun, pottering at the hedges, hunting too wide, and chasing fur.* The vice of *blinking* has been caused

by over-severity in punishment for chasing poultry, &c., and takes a great deal of time to remove. Indeed, until the dog sees game killed, he seldom loses the fear which has produced it. It is therefore frequently useless to continue the breaking in the spring, although such a dog sometimes becomes very useful by careful management in the shooting season. Generally speaking, it is occasioned by undue severity, either applied for chasing cats or poultry, or for chasing game when first hunted. The former kind of castigation should be very cautiously applied, as the puppy is very apt to associate the punishment given for the chasing of game with that due to the destruction of poultry or cats; and as he has been compelled to leave the latter by the use of the whip, and has been afterwards kept "at heel," so he thinks he must do so now, and in fear he comes there, and consequently "blinks his birds." This defect is only to be remedied by instilling confidence, and by avoiding punishment; but it is often one which gives great trouble before it is got over. It is not so bad as the obstinately refusing to work at all, but is only next to it. Both occur in dogs which are deficient in courage, and both require the most delicate and encouraging treatment to remove them. Let such dogs run "riot," and commit any fault they like, without fear for a time; then afterwards (that is, when they begin to be quite bold, and are full of the zest for game) begin very cautiously to steady them, and something may yet be done. In very bad cases all attempts at breaking must be given up at "pairing time," and the gun must be relied on as a last resource, the killing of

game having sometimes a wonderful effect in giving courage to a dog which has been depressed by undue correction. Punishment is not to be condemned altogether, for in some breeds and individuals without the whip nothing could be done; but it should be very cautiously applied, and the temper of each dog should be well studied in every case before it is adopted. Kindness will effect wonders, especially where united with firmness, and with a persevering determination to compel obedience somehow: but, if that "how" can be effected without the whip, so much the better; still, if it cannot, the rod must not be spared, and, if used at all, it should be used sufficiently.

*Shyness of the gun* will generally also go off in time; but, as it seldom occurs except in very timid and nervous dogs, they do not often become very useful even when they have lost it. The best plan is to lead a shy dog quietly behind the shooters, and not to give him an opportunity of running off, which he generally does on the first discharge. When game falls, lead him up and let him mouth it; and thus, in course of time, he connects cause with effect, and loses that fear of the report, which he finds is followed by a result that gives him the pleasure of scenting fresh blood.

*Pottering* at the hedges in partridge-shooting is the result of using dogs to find rabbits, or of allowing them to look for them, which they always are ready to do, especially if permitted to chase or even to retrieve hares. There is no remedy for it, and a potterer of this kind is utterly worthless and irreclaimable.

*Hunting too wide* for close partridge-shooting may be easily

remedied by constantly keeping in the dog by the whistle and hand; and, if he has been properly taught to range at command, little trouble is required in making him change from the wide beat, necessary in countries where game is scarce, to the confined and limited range of sixty yards, which is best where it is thick on the ground.

*Chasing fur*, and also *running in to dead birds*, are often most unmanageable vices; but either can generally be cured by patience and severe treatment, aided if necessary by the check-cord, or in very bad cases by the spike-collar in addition. When these are used it is only necessary to work the dog with them on, the cord either trailing loosely on the ground or held in an assistant's hand. Then, the moment the dog runs in, check him severely, and, if he is not very bold, the plain collar will suffice, as it may be made by a sharp jerk to throw him back, to his great annoyance; but the spike-collar punishes far more, and if it is used will soon give the dog cause to leave off his malpractices.

---

#### BREAKING TO RETRIEVE.

*Retriering*, in my opinion, should be invariably committed to a dog specially kept for that purpose; but, as this is not the universal practice, it will be necessary to say a few words on this subject. When pointers or setters are broken to retrieve, in addition to those qualities peculiar to them they should always



be so much under command as to wait "down charge," until they are ordered on by the words "Seek dead;" when they at once go up to the place where they saw their game drop, and, taking up the scent, foot it till they find it. Some breeds have no nose for a foot-scent, and, if ordered to "seek dead," will beat for the body-scent as they would for a single bird; and, when they come upon the lost bird, they "peg" it with a steady point in the same way. This does not injure the dog nearly so much as the working out a runner by the foot-scent; but a retrieving pointer of this kind is of little use for any but a badly wounded bird which has not run far. Few pointers and setters will carry game far, nor indeed is it worth while to spend much time on teaching them to do so; and when they are set to retrieve it is better to follow them, and help them in their search, so as to avoid all necessity for developing the "fetch and carry" quality which in the genuine retriever is so valuable. But it is chiefly for wounded hares or running pheasants that such a retriever is required; and as the former spoil a pointer or setter, and are sure to make him unsteady if he is allowed to hunt them, it is desirable to keep clear of the position altogether, while pheasants are so rarely killed to these dogs that their retrieval by them need not be considered.

The *regular land retriever* requires a much more careful education, inasmuch as he is wanted to abstain from hunting, and from his own especial duties excepting when ordered to commence. The breed generally used is the cross of the Newfoundland with the setter or water-spaniel, but, as I have described

at page 158, other breeds are equally useful. In educating these dogs they should be undertaken at a very early age, as it is almost impossible to insure perfect obedience at a later period. The disposition to "fetch and carry," which is the essence of retrieving, is very early developed in these dogs, and without it there is little chance of making a puppy perfect in his vocation. Young dogs of this breed will be seen carrying sticks about, and watching for their master to throw them, that they may fetch them to him. This fondness for the amusement should be encouraged to a certain extent, almost daily, but not so far as to tire and disgust the dog, and care should always be taken that he does not tear or bite the object which he has in charge. On no account should it be dragged from his mouth, but he should be ordered to drop it on the ground at the feet of his master, or to release it directly it is laid hold of. The consequence of pulling anything out of the young retriever's mouth is that he becomes "hard bitten," as it is called; and, when he retrieves a wounded bird, he makes his teeth meet, and mangles it so much that it is utterly useless. A dog which is not naturally inclined to retrieve may be made so by encouraging him to pull at a handkerchief or a stick; but such animals very seldom turn out well in this line, and it is far better to put them to some other task. As soon as the puppy has learnt to bring everything to his master when ordered, he may be taught to seek for trifling articles in long grass or other covert, such as bushes, &c.; and, when he succeeds in this, get some young rabbits which are hardly old enough to run, and hide one at a

time at a little distance, after trailing it through the grass so as to imitate the natural progress of the animal when wounded. When putting the young retriever on the scent at the commencement of the "run," let him puzzle it out till he finds the rabbit, and then make him bring it to his master without injuring it in the least. Encouragement should be given for success, and during the search the dog should have the notice of his master, by the words "Seek! seek! seek dead!" &c. A perseverance in this kind of practice will soon make the dog very clever in tracing out the concealed rabbits, and in process of time he may be intrusted with the task of retrieving a wounded partridge or pheasant in actual shooting. But it is always a long time before the retriever becomes perfect, practice being all important to him.

*Many shooters use a slip* for the retriever, the keeper leading him in it till he is wanted, which is a good plan when a keeper is always in attendance. In any case, however, these dogs should be made to drop "down charge," as the gun may be used while they are at work, and if they are not broken to drop they become excited, and often flush other game before it is reloaded.

*The breaking of the Water-Spaniel or Retriever* is also a complicated task, and, as he has to hunt in the water and on the banks, his duties are twofold. These dogs are used in the punt as well as on the edge of the water, but, when the education is finished in the river, the pupil will generally do what is wanted from the punt. As in the land retriever, so in this

variety, the first thing to be done is to get the puppy to "fetch and carry" well; after which he may be introduced to "flappers" in July and August, when the water is warm, and he does not feel the ill effects and disagreeables attendant on a cold winter's day with a wet coat. The young birds are also slow and awkward in swimming and diving, so that every encouragement is afforded to the dog, and he may readily be induced to continue the sport, to which he is naturally inclined, for hours together. The chief difficulty at first is in breaking the water-spaniel from rats which infest the banks of most streams, and which are apt to engage the attention of most dogs. The dog should be taught to beat to the hand, and, whenever a flapper is shot and falls in the water, then he must be encouraged to bring it to land without delay. No art must be neglected to induce him to do this, and, failing every other plan, the breaker must himself enter the water; for, if the dog is once allowed to leave a duck behind him, he is much more difficult afterwards to break. Indeed, perseverance in the breaker is necessary at all times, to insure the same quality in the pupil. The object in teaching the range to hand to the spaniel is, because without this there will often be a difficulty in showing him where a bird lies in the water, the eye of the dog being so little above its level, and the bird very often so much immersed, that when there is the slightest ruffle he can scarcely see it a yard from his nose. As in all other cases, the water-retriever must be strictly "down charge," and he must be thoroughly steady and quiet at heel, or he will be sure to disturb the water-fowl when the shooter

is in ambush waiting for them. The slightest whine is fatal, and the dog should, therefore, be taught to be as quiet as a mouse until ordered to move.

---

#### THE ENTERING AND BREAKING OF THE COVERT SPANIEL.

The breaking of all spaniels should be commenced as early as possible, as they are naturally impetuous, and require considerable restraint to keep them near enough to the shooter while they are at work. After teaching them the ordinary rules of obedience, such as to "come to heel," to "hold up," to drop "down charge," &c., which may all be done with the pistol and check-cord, aided if necessary by the spiked-collar, the next thing is to enter them to the game which they are intended to hunt. Generally it is the practice to use spaniels for pheasants, cocks, and hares, disregarding rabbits, which take their chance with the shooter. The spaniel, therefore, is not expected to "speak" to them, and if he can be induced to give a different note at each of the three varieties above mentioned, he is all the more highly prized. These dogs are better taken out first into small coverts or hedgerows (provided there are not too many rabbits in the latter), as they are more under command here than in large woodlands; self-hunting should be strictly discouraged, that is to say, the dog should neither be allowed to hunt *by* himself nor *for* himself, but should be made to

understand that he is always in aid of the gun, and that he must keep within shot. For this purpose spaniels must be taught not to press their game till the shooter is within range, which is one of the most difficult things to teach them. When they are to be kept exclusively for "feather," they must be stopped and rated as soon as it is discovered that they are speaking to "fur." This requires a long time, and therefore few spaniels are worth much till they have had one or two seasons' practice, from which circumstance it should not occasion surprise that a thoroughly broken Clumber spaniel fetches from 30 to 40 guineas. When they are too riotous and hunt too freely, these methods of sobering them are adopted:—1st, to put on a collar, and slip one of the fore legs into it, which compels the dog to run on three only; 2ndly, to buckle a small strap, or tie a piece of tape, tightly round the hind leg above the hock, by which that limb is rendered useless, and the dog has to go upon three also; and, 3rdly, to put on a collar loaded with shot. If either of the legs is fastened up, it must be occasionally changed, especially if the strap is adopted, as it cramps the muscles after a certain time, and, if persisted in too long, renders the dog lame for days afterwards. On the other hand, when the puppy is slack in hunting, put him on the scent of pheasants as they are going off their feed, when they generally run back into covert, and at that time the scent is very strong, especially in the evening. The birds soon rise into the trees, and after that are no longer disturbed by the dog. In hunting hedge-rows, the young dog should at first be kept on the same side as

the shooter, so that his movements may be watched; but, as soon as he can be trusted, he should be sent through to the other side, and made to drive his game towards the gun, always taking care that the dog does not get out of shot. In first introducing a young dog to a large covert, he must be put down with a couple of old ones which are very steady; and, at the same time, he should have a shot-collar on, or one of his legs up. Without this precaution he will be sure to range too wide, and, if he gets on the scent of a hare, he will probably follow her all over the covert, to the entire destruction of the day's sport; but, by the above precautions, he is prevented doing this, and by imitating his fellows, he soon learns to keep within the proper distance. Here, as in all dogs intended for the gun, the great principle is to make them understand that *it* is the instrument of destruction, not *themselves*, and that it is only by paying proper attention to the gun that they can be expected to succeed in obtaining game. In working spaniels in covert great quiet is desirable, as game will never come within distance of the shooter if they hear a noise proceeding from him, and hence the constant encouragement to the dogs, which some sportsmen indulge in, is by no means necessary. If the spaniel is properly broken, he can hear his master as he passes through the underwood, and he will take care to drive the game towards him, while, if he is slack and idle, the voice does him little good, and prevents the only chance of getting a shot which might otherwise occur. In *battue* shooting, spaniels, if employed, are in aid of the beaters, not of the shooters, most

of whom do not even know the dogs' names, and the latter cannot, therefore, be expected to work to them; but as they go forward with the beaters in line, they must be kept from getting on too far, or they will often drive game back. For this work, however, they do not require to be nearly so thoroughly broken as for hunting to the single shooter, for which purpose they must know him, and should in fact be broken by him.

---

#### THE ENTERING AND BREAKING OF VERMIN DOGS.

Terriers are entered to vermin with great facility, and require very little breaking, unless they are intended to be used with ferrets, when they must be broken to let these animals alone, as they are apt to make their appearance occasionally in passing from one hole to another. It is only necessary to let the ferret and the terrier be together in a yard or stable, cautioning the latter not to touch the former, for a few times, and the young dog soon learns to distinguish his friends from his foes. Some terriers are not hardy enough to brave the bites which they are liable to in ratting, &c., and, indeed, the true terrier without any cross of the bull-dog is a great coward, so that he is quite useless for the purpose. In such a case he must be encouraged by letting him kill young rats first, and as he gains confidence he will perhaps also increase in courage. If, however, the terrier is well bred, he will seldom want anything but practice.



## CHAPTER V.

THE EMPLOYMENT OF THE DOG IN COURSING, HUNTING,  
SHOOTING, ETC.

Coursing. — Deerstalking. — Hunting. — Partridge- and Grouse-Shooting. — Snipe-Shooting. — Covert Shooting.—Wildfowl-Shooting. — Ferreting.

## PRIVATE COURSING.

BETWEEN private and public coursing there is a considerable difference, not only in the methods adopted, but also in the kind of greyhound most useful for each. In the first place, the private courser will not like the expense of rearing a fresh set of greyhounds each year, but will expect them to last several seasons ; and hence speed and cleverness must to some extent be sacrificed to honesty, which is the *sine quâ non* of the private greyhound, excepting for those who course for currant jelly purposes only. It is true that a cunning old dog, if fast and clever, will kill more hares than any other, but he will do it in a way to disgust every sportsman, and such an animal is not to be recommended on any account. If, therefore, the private courser regards the sport independently of the obtaining hares, he will see that his greyhounds combine as many good qualities as possible, with an amount of honesty which will carry them through three or four seasons

without lurching. These, however, are only now to be obtained from private sources, for every strain of public greyhounds with which I am acquainted will show a tendency to lurch after a couple of seasons, if used as much and as freely as the greyhounds of most private coursers are expected to be.

The *feeding* of these greyhounds should be on oatmeal porridge, with more or less wheat-flour or Indian meal, as described at page 215, and flavoured with greaves, or with broth made from flesh of some kind. If half a pound a day, or rather more, of flesh can be given in addition, they will be so much the better, but in that case they ought to have a couple of hours' exercise every day, without which they become fat and unwieldy. Vegetables should be carefully given, as in all cases with dogs, and due attention should be paid to cleanliness. In fact there is no reason why the system adopted in the feeding of the public greyhound should not be fully carried out. *The sport of private coursing* may be conducted exactly on the same principles as public coursing, excepting that stakes are not usually run for, but in almost all cases the dogs are matched together, without which the sport is tame and uninteresting. The essence of coursing is the competition between the two dogs engaged, that being the number which is considered fair to the hare, and coursing with more than two being by general consent stamped as poaching ever since the days of Arrian, A. D. 150. When, therefore, greyhounds are kept with this purpose, it promotes the object of sport if two or more gentlemen will meet together to run their dogs in competition with one another; and, when this is done,

there is often quite as much excitement produced as in the most important public meeting. But then there must be a person appointed to act as judge, for without this functionary there must be endless disputes as to the respective qualifications of the greyhounds engaged. With him, if he understands the points of the course, it is only necessary to conduct the beating of the ground properly, and to appoint a proper person to slip the greyhounds, and then everything is *en règle*.

*In beating the ground*, when there are no gentlemen present on horseback, five or six beaters must be provided, whose task is somewhat onerous, if there is much ploughed land, especially in clay districts when wet. In any case, a line should be formed, with one person at every twenty yards, and then walking abreast from one extremity of the field to the other, so as either to find the hare sitting, or to put her up from her form. The proper direction of this line of beaters, so as to drive the hare in the best direction, requires some considerable experience and tact. Thus, when there is a covert near, the beat should be *from* it, so as to compel the hare to go in the opposite direction, by which a sufficiently long course is often insured, whereas otherwise she would be safe before she was well reached. At the end of this beat the men should return over the beaten ground, taking what is called a "dead beat," and then again beating from covert. When the part of a field is beaten near the hedge, the line on that side should be extended forwards; and, if there is a horseman present, he should walk up close to the hedge, thirty yards in front of the others, so as to prevent the hare at once running through it. Hares

may often be driven out of turnips, clover, or small coverts, by a line of beaters driving them towards the dogs, which are held at a particular spot, and kept as much as possible out of sight. The *slipper* uses the same kind of slips as are adopted in public coursing, and slips his dogs in the same way, adapting the length of the slip allowed to the nature of the ground. It is a very bad plan to let the greyhounds run loose while the hare is looked for, as the two rarely start on even terms, and consequently they cannot be compared together. Unless, therefore, coursing is pursued solely to get the hare, slips are indispensable.

When private coursing is conducted in the above way, it is quite as good a sport as the public kind; but too often it degenerates into a series of mobbings of the hare, followed by perpetual squabbings of the owners of the dogs engaged, as to their respective merits or demerits.

---

#### PUBLIC COURSING.

This amusement has now become very general since the last alteration of the game laws, which permitted any person to course a hare without a certificate. It differs from private coursing, *firstly*, in requiring rather a different greyhound, and, *secondly*, in being governed strictly by rules which settle all the preliminaries.

The *public greyhound*, to be successful, must be a dog which can beat his competitors in the stake in which he is engaged, even

if he never runs afterwards respectably. Hence, unlike the dog which we have been just considering, everything is sacrificed to this point, and it has at last come to pass that the animal has been bred to such a degree of cleverness combined with speed that he very soon runs cunning, and is then no longer useful, because he will not exert his powers. The consequence is, that a great many dogs begin by running with extraordinary pace and working powers, but after winning one or two stakes they are not to be depended on. This is so common, that, as a rule, most coursers do not think it worth their while to keep their dogs for more than one season, and bring up a succession of puppies one year after another, reserving only one or two old ones to their second season. It must be remembered that this animal is kept for a specific purpose, namely, to compete with his fellows *in killing the hare under certain conditions, which are defined by general consent and laid down in certain specified rules.* Hence it is not the greyhound which will most certainly pull down his hare that is always to be prized, but he that will comply with these rules most fully in the act of running her, and will, in other words, score most points; and, in effecting this, four cardinal virtues must be combined as far as possible, consisting in speed, working power, bottom, and courage. It is almost impossible to obtain the fullest development of these several qualities in one individual, and therefore all that can be done is to sacrifice those which are of the least importance. Thus, excessive speed, as shown from the slips, is hardly consistent with a high degree of working power, or with a capability of lasting throughout a long course;

and for this reason extremely fast dogs are not adapted to down countries, where the hares are not only stout but short in their turns. In some localities, however, where there is no room for a long course, or where the hares are weak, a fast dog, even if he is not stout, and probably even if he is a bad worker, will be able to win a stake; but wherever the hares are good, and there is scope for them to display their powers, there must be both bottom and working power displayed in order to insure success. The best plan in breeding greyhounds is to obtain a brood bitch of stout blood and good working powers, combined with as much speed as possible, but still laying the most stress on the first two qualities, and then put her to a dog essentially fast, but in him also looking to bottom and working power, though secondary to speed. Courage is essential in all greyhounds, and may be obtained equally well whether the breed is fast or slow, clever in working or the reverse. It must exist with bottom, but may also be developed without it, some very soft greyhounds being high couraged, and going till they drop from the exhaustion of their delicate frames. In looking for these several qualities it is necessary to observe that speed depends upon the formation of the body and limbs, which must be of the most perfect make, as described under the head of *the points of the greyhound* at page 27; but with the most perfect shape there is often a want of speed, apparently owing to the absence of that nervous *stimulus* which sets the frame in motion. Such dogs want quickness and elasticity in using their organs, and, though they often move elegantly, there is a deficiency in the rapidity of repetition in the muscular contractions which constitute

high speed. Hence the necessity for attending to breed, and to its purity, which is the only guarantee (short of an actual trial) that the perfect frame will give perfect action. The same remarks apply to working power : a dog may look to be exceedingly cleverly made, with good shoulders, and all the other parts essential to this faculty, and yet there may be a want of cleverness and tact, as well as a deficiency in courage, which will render him absolutely useless. But when the breed is known to be almost invariably good in these respects, and the formation of the individual is good, there is a reasonable ground for expecting that he will exhibit them in more or less perfection. Nothing is more provoking than to find a splendidly formed dog beaten in his trial by a wretched-looking brute, the sole advantage attending the latter being that he is descended from good blood, while the former perhaps owns a sire and dam of well-known and ascertained imperfect nervous organisation.

*When the young courser determines upon getting together a kennel of greyhounds, he must therefore carefully attend to all these points ; but with all his care he will be disappointed unless he knows how to manage them, or can intrust them to some one who does.* Public greyhounds, as I have already explained, are easily spoiled by using them too frequently ; and yet they must have some amount of practice before they run in a stake, or they will inevitably be beaten from awkwardness. Some breeds are naturally more clever than others, and take less time in coming to their best, so that, if they have as many courses as would barely suffice in many cases, they would be past their prime. All this

therefore requires considerable practice, and theoretical knowledge as well ; and, for this reason, the young courser should not fancy that he can at once compete on even terms with the experienced hand. Let him therefore content himself with creeping before he runs, and let him undertake a brace or two at the most for a season, before he rushes into the thick of the contest. No one can hope for much success who keeps a very large kennel under the management of one man, because he cannot do justice to more than eight or ten running dogs ; but at first he had better content himself with half that number, and he will find afterwards that he has made many mistakes about these. It is also very difficult to purchase good dogs, though occasionally they may be met with ; but when a young courser begins he wants the experience which is required to know how to select them. On all these accounts therefore he had better begin by sporting a brace, and in the mean time he can be bringing forward a moderate number of puppies bred by himself, which will be ready for work in a year or two.

*The kennel management of greyhounds* has been described at page 226, and it only remains to describe the method of *training* which is adopted for the purpose of enabling them to bear the severe work often experienced in going through a stake. Many a greyhound will run one course quite as well without training as with, that is, if it is not a long one ; but there are few untrained dogs that will go on through a series of courses as well as if they had had the pains bestowed upon them which a man of experience would be able to give. It is often said that certain dogs



have run better untrained than trained, but this only shows that the training in their particular case was mismanaged; for, if they had been treated properly, they would not have been worked to the extent which produced the change for the worse. Scarcely any two dogs require the same treatment, and the chief art in training is to discover the exact amount which each will bear and require in order to bring him out to the best advantage. It must therefore be understood, that by training is here meant the act of preparing a dog for certain public performances in the way best fitted for each individual; and that it does not by any means consist in putting him through a specified course of physic, diet, and work, which, in his case, may be altogether unsuited to him.

*Before commencing to train a greyhound,* it is necessary to consider what condition he is in at the time, and what amount of work he is likely to bear, judging from his breed, and also from his bodily formation. The first thing to be done is to see that his health is good, and that his liver and kidneys are doing their work properly, without which it is useless to attempt to train him. If he is known to be descended from a stock which has been accustomed to severe preparatory work, and if he also has a stout frame and *good feet*, it may reasonably be expected that he will bear as much training as his progenitors, and he may be treated accordingly. If on the other hand he comes of a soft strain, that has never been used to road-work, and of which the dogs composing it have always trained themselves in their play to the highest pitch of which their frames are capable, then it will be safer to follow suit, and to take the descendant

of these latter animals out for two or three hours a day on the greensward, simply keeping him moving, and encouraging him to play with his fellows till he is tired. Less than three hours' exercise can never be sufficient, as the dog is only compelled to walk, and any faster pace is voluntary, and will not be attempted if he is at all exhausted. From this it will appear that the trainer's art greatly consists in apportioning the proper quantity of work, which he can only do by studying the constitutions and breeding of the dogs under his charge; after which he will determine in his own mind the probable amount of work which each will bear, and will proceed to put his theory into practice, always carefully watching the progress which is made, and altering his plans as he goes on, according as he finds that he has calculated erroneously. One great guide which he has is the weight which is gained or lost; for if he finds the dog is putting on flesh when he wants some off, or if he is losing it when he is already too light, there must be some alteration made, or the dog will not come out fit for his duties. Thus, then, the trainer first fixes in his mind the weight to which he wishes to bring his dog on a certain day, and then, by apportioning the work, physic, and food according to his ideas of the dog's constitution, he endeavours to attain that standard of proportion; altering his plans as he goes on if necessary. It must, however, always be remembered, that training should not attempt to produce an unnatural condition, but rather the highest state of health consistent with that free play of the lungs and heart which will enable the dog to continue

his highest speed for the longest time, and guarantees the retention of his spirit and courage, so as to induce him to exert it.

*Work for training purposes* is effected in two ways: the object being to get rid of the superfluous fat, which interferes with muscular action, and with the free play of the lungs; and also to accustom the muscles, ligaments, and tendons to severe and long-continued exertions. These two methods are often combined; and indeed, though the one by means of slipping is effectual by itself, yet the other, or horse-exercise alone, will not develop the wind sufficiently, and, if it is adopted, it must be aided by slipping the dogs as well. Horse-exercise is chiefly confined to countries where the courses are very long and severe, and where also much of the work can be given on turf, so that it is only in down countries that it is very available, but there it is almost essential to full success in training the greyhound. The amount of this kind of exercise which a greyhound of stout blood will take with advantage is very great, and it is sometimes more than one horse will be able to lead; but this is not often the case. Few greyhounds will be the better for more than fifteen miles every other day, and this is quite within the compass of a horse's powers, especially when it is considered that not more than two or three miles of this distance should be at the gallop. But the great object of horse-exercise is not to produce a fast pace, so much as to insure a sufficiency of slow work; for there are few trainers who will walk fifteen or sixteen miles a day on foot, and yet in order to keep the dogs out for four hours they ought to do so. A

certain amount of road-work is essential to the hardening of the feet, but this should be commenced two or three months prior to the time of training, as it cannot be done without time to cause the growth of the thick horny matter which covers the sole of the foot. If, therefore, horse-exercise is to be adopted, it is better to commence it two or three months before the meeting for which the dog is to be trained, and after giving him two or three days a week, up to within a fortnight of the time, discontinue it, and proceed to develop the highest degree of wind, by slipping the dog to its trainer's call. A short gallop of a couple of miles *on turf* will be nearly as beneficial, but the long dragging road-work, which will serve to prepare the dog earlier in his training, is now to be discontinued, because it interferes with the spirit, and will render him disinclined to exert himself with that fiery courage which is requisite for success. The slipping-work is effected by the aid of an assistant, who leads the greyhounds off in one direction, while the trainer walks to another point; and when half a mile apart or thereabouts the dogs are let loose, one after another, the trainer whistling and shouting to them, so as to excite them to their highest speed. The assistant should be a stranger to them, and it is better to buckle a stirrup-leather round his waist with the noose at the end of each leading-strap inserted, so that he may have both his hands at liberty to unbuckle the collars in succession. If there is a gently sloping valley composed of ground similar to that over which the public coursing is to take place, it is better to select it, as the dog then sees

his trainer plainly, and also finishes up-hill, which is of great service in "opening the pipes." By means of these two kinds of work properly proportioned, and taking care not to overdo them, the dog is at last rendered equal to any ordinary amount of exertion; but, in hardy animals which are allowed to eat as much as they like, the work which would reduce them sufficiently would make them stale in their joints, and dull in spirit, so that it is found necessary to call in the aid of physic and a reduction of food.

*The physic proper for a dog in training* should be of such a nature as simply to cause an increase of his secretions, without rendering him liable to catch cold. Hence, mercury should be carefully avoided; and jalap, salts, or aloes, will be found to be the best. Some people use emetics, but these do not reduce the weight of the dog, and they are solely useful in giving tone to the stomach, which they certainly appear to do. Even within two or three days of running they are often given, and will then render the dog lively and full of spirits, when he would otherwise be dull and disinclined to exert himself. The trainer, throughout, should watch the secretions, and if he finds that they are deficient he may give a dose of aloes or jalap; but if in good order it is better to avoid medicine, if the weight can be kept down by other means.

*The diet* is of the greatest importance, and indeed it is in this point that more mistakes are made than in any other. If a hardy dog is fed as heavily as his inclination prompts him, no kind of work will reduce him without also destroying his elas-

ticity and fire, and hence it is found necessary to limit his food. For this reason reduction of food is indispensable in most cases, and in very few will the dog in training require the same *quantity* as before, though the *quality* can hardly be too good provided it does not upset his stomach. These animals are extremely liable to become bilious, and suffer from disorder of the stomach and liver, just as man does. Hence it follows that any concentrated food like eggs or strong soup, although in theory it may be better than meat and bread, is inadmissible, because, being so prone to dyspepsia, just at the time when the greyhound is wanted to run he is off his feed, sick and sorry. The dog naturally requires variety in his feeding, but the change should be always gradual in the proportions of the elements of which it is composed. The changes may be rung on beef, mutton, and horseflesh, as often as may be convenient, but the proportion of flesh to meal must be very carefully kept at the same ratio. For the dog in high training lean mutton is the best of all flesh, as it is milder than either of the others, and though quite as nourishing, yet it is less heating; so that careful trainers prefer it to all others, especially when from home, as it can always be procured at the butcher's, while good horseflesh must be carried about, and is on that account troublesome to get. But if a good leg of well-hung horseflesh from a tolerably healthy horse can be procured, it is very nearly as good as mutton, and far better than beef, being more tender, and I think not so heating. No one, however, who wishes to take advantage of every chance in his favour, should use bad meat; and the difference between

the one and the other cannot exceed 6*d.* per day per dog, which at a meeting lasting a week amounts to 3*s.* 6*d.* per head. About three quarters of a pound of dressed meat, and the same quantity of biscuit or bread soaked in jelly, will be sufficient *on the average* for most dogs in training; but some take more and some less, so that this can only be taken as an approximation to what each animal requires. The water which is given should be boiled, by which it deposits its lime when over-abundant, and unless this precaution is taken the change of water often upsets the dog's kidneys. Many people do not leave water in the dog's kennel while in training, but I prefer the plan, taking care to remove it on the morning of running, after the kennel is first entered.

*The amount of friction* on the skin which is of service during the course of training is very considerable, and each dog ought to have half an hour a day after his exercise, first washing the feet and if necessary touching their pads with a little tar-ointment. Then taking the dog between the knees, and putting on a pair of hair gloves, rub him well in the direction of the hair, applying the pressure over the large muscles, especially those of the shoulders, loins, and haunches, and avoiding the bones as much as possible. The spine or backbone should be left between the two hands in rubbing the loin, but the ribs as a matter of course must be included. After this friction has been continued, rub all over gently with a linen rubber and again put on the clothing.

*Dogs in training are clothed*, because they are more liable to

cold than at other times, and also because their strange lodgings are seldom so free from draughts as their regular kennels. The clothing is made in one sheet which covers them from the head to the tail, but when in kennel the head and neck part is turned back over the shoulders. The clothing is necessary to put on when the dogs are carried out to the coursing-field, as they are often kept standing about in the cold for hours. A waterproof cloth is of great service in wet weather. This clothing can be obtained at almost any saddler's throughout the country. The *following summary* will be useful in giving *general directions* for training the greyhound.

1. Give no more physie than just enough to freshen the stomach, unless it is wanted as a means of reduction.

2. When used in this way try mild physie before giving stronger.

3. Give about three quarters of a pound of mutton or horse-flesh daily, mixed with as little bread as will suffice for health. The quantity of bread necessary may be known by the colour of the fæces, which ought to continue of a good gingerbread colour, and which become black, or nearly so, when the flesh is overdone.

4. Reduce the dog more by increase of work and reduction of food, than by physie.

5. Give as much horse or other exercise as the stoutness of the dog will enable him to bear, without overdoing him.

6. Use plenty of friction.

7. Feed from one to three o'clock on the day before running.



8. Do not give more than walking exercise on the day before running, or on the morning prior to the course.

*Greyhounds require very careful management at the meeting* when they are to run, inasmuch as there are many strange circumstances which often affect their health. In the first place the travelling is apt to upset them, especially if by railway, the excitement of which is too much for irritable dogs, and therefore they should be moved to their new quarters several days before they are wanted. It is usual to feed rather more lightly than usual on the day before running, but this plan is often carried to extremes, and the dog runs weak in consequence. After running very little is needed, except to get the dog home, and feed him for next day if he is required. If, however, there is much distress, and the dog has to run again, a cordial must be given, which is sometimes egg and sherry. The egg I do not believe to be useful, as it has a tendency to make the dog bilious, but a little sherry or spirit and water may be employed; what is far better is some kind of spice mixed with a little mutton or by itself, and given about half an hour before the dog will be wanted; using plenty of friction just before he is put in the slips. Cold tea, with or without the addition of a little spirit, is also an excellent restorative.

#### SPICED-MEAT BALL.

Take of Caraway seeds, 10 grains.  
 Cardamoms, 10 grains.  
 Grains of Paradise, 5 grains.  
 Ginger, 5 grains.  
 Lean boiled knuckle of mutton,  $\frac{3}{4}$ oz.

Bruise the seeds in a mortar, and then mix with the mutton, and form it into a ball.

## COMMON CORDIAL BALL.

Take of Cumin seeds, 10 grains.  
Coriander seeds, 10 grains.  
Caraway seeds, 10 grains.  
Grains of Paradise, 10 grains.  
Saffron, 1 drachm.  
Syrup, enough to form a ball.

Bruise in a mortar, and mix well together, then make up into a ball.

---

THE NATIONAL COURSING CLUB.

*Public coursing is conducted under certain rules* which have recently been revised by a committee appointed at the Great Waterloo Meeting held at Liverpool in 1858. These supersede all previous rules, with the exception of those of Mr. Thacker which relate to the decision of courses, which, by Rule 1, are now approved of. The committee thus appointed have resolved themselves into a National Coursing Club, to be elected each year at the Waterloo Meeting.

The National Coursing Club has now been established, and all complaints of whatever description connected with coursing, or any matters in dispute, can be referred to it for arbitration and adjustment.

The National Club consists at present of the members selected at the Waterloo Coursing Meeting in February, 1858, together

with several other influential noblemen and gentlemen who have been added to it, and whose names have been made known.

The Club is now kept up on the elective principle, the various Coursing Clubs electing members in rotation, and eight retiring every year.

Two General Meetings of the Club shall be held in each year—viz. one in London during the Epsom Race-week, and one at Liverpool during the Waterloo Coursing Meeting—for the despatch of business, and for the revision and alteration of rules; but the Secretary shall be authorised, upon a requisition addressed to him in writing by any three of the secretary and stewards of a meeting, or upon a remonstrance signed by six public coursers who may happen to be present, to summon such special meetings as may be necessary from time to time, at the earliest convenient opportunity, for adjudication upon such questions as may be referred to the Club.

The National Coursing Club recommends that the following code of laws shall be adopted universally for the guidance both of open and club meetings, clubs merely adding such special or local regulations as may be required to adapt the national code to their own peculiar use; in fact it is generally used throughout the kingdom:—

#### CODE OF RULES.

I. SECRETARY AND STEWARDS.—The Secretary of any proposed open meeting shall associate with himself a Committee of not less than three members, to settle preliminaries. The management of

the meeting shall be entrusted to this Committee in conjunction with Stewards, who shall be elected by the subscribers present the first evening of a meeting. The Stewards alone shall decide any disputed question by a majority of those present, subject to an appeal to the National Club. The Secretary, if honorary, shall be a member of Committee and a Steward *ex officio*. No Steward shall have a right to vote during a meeting in any case relating to his own dogs. The Secretary shall declare, as soon as possible, how the prizes are to be divided; and shall give a statement of expenses, if called upon to do so, within fourteen days after the meeting, by any six of the subscribers.

2. ELECTION OF JUDGE.—The Judge may either be elected by the Secretary and Committee appointed under Rule 1, in which case his name shall be announced simultaneously with the meeting, or his appointment shall be determined by the votes of the subscribers taking nominations: but each subscriber shall have only one vote, whatever the number of his nominations. Not less than ten days' notice of the day of election shall be given to the subscribers, and the appointment shall be published at least a fortnight before the meeting. The names of the subscribers voting, with the votes given by them, shall be recorded in a book open to the inspection of the Stewards, who shall declare the number of votes for each Judge, if called upon to do so by any of the subscribers. When a Judge is prevented from attending or finishing a meeting, the Committee and the Stewards (if appointed) shall have the power of deciding what is to be done.

3. DESCRIPTION OF ENTRY.—Every subscriber to a stake must

name his dog at or before the entry, giving the names (the running names if they had any) of the sire and dam of the dog entered, and also in puppy stakes the name of the dam's owner. The Secretary shall publish on the cards the names of those who are subscribers, but do not comply with these conditions. These nominations shall not be drawn, but must be paid for. For Produce Stakes the names, pedigrees, ages, and colours, and distinguishing marks of puppies, shall be detailed in writing to the Secretary of a meeting at the time of entry. Every subscriber must also, if required, state in writing to the Secretary, before or during the meeting for which such entry is made, the names and addresses of the parties who reared his puppies; and any puppy whose marks and pedigree shall be proved not to correspond with the entry given shall be disqualified, and the whole of its stakes or winnings forfeited. No greyhound is to be considered a puppy which was whelped before the 1st of January of the year preceding the commencement of the season of running. A sapling is a greyhound whelped on or after the 1st of January of the same year in which the season of running commenced.

4. PAYMENT OF STAKES.—All moneys due for nominations taken must be paid at or before the entry, whether the stakes fill or not, and although, from insufficient description or any other cause, the dogs named may be disqualified. No entry shall be valid unless the amount due for it has been paid in full. For all Produce and other Stakes where a forfeit is payable no declaration is necessary; the non-payment of the remainder of the entry money at the time fixed for that purpose is to be considered a declaration of forfeit.

The Secretary is to be responsible for the entry money of all dogs whose names appear upon the card.

5. ALTERATION OF NAME.—If any subscriber should enter a greyhound by a different name from that in which it shall have last run in public, he shall give notice of the alteration to the Secretary at the time of entry, and the Secretary shall place on the card both the late and the present names of the dog. If notice of the alteration be not given, the dog shall be disqualified.

6. PREFIX OF “Ns.”—Any subscriber taking an entry in a stake and not prefixing the word “*Names*” to a greyhound which is not his own property, shall forfeit that greyhound’s chance of the stake. He shall likewise, if requested, deliver in writing to the Secretary of the meeting the name of the *bonâ fide* owner of the greyhound named by him, and this communication is to be produced should any dispute arise in the matter.

7. DEATH OF A SUBSCRIBER.—The death of a subscriber shall only affect his nominations, if it occur before the draw, in which case, subject to the exceptions stated below, they shall be void whether the entries have been made or not, and any money received for forfeits or stakes shall be returned. If he has parted with all interest in the nominations, and dogs not his property are entered, paid for, and drawn in ignorance of his being no longer alive, such entries shall not subsequently be disturbed. When dogs, who have been entered in Produce Stakes, change owners with their engagements and with their forfeits paid, the new owner, if otherwise entitled to run them in those stakes, shall not be prevented from doing so by reason of the death of the former owner.

8. DRAW.—Immediately before the greyhounds are drawn at any meeting, and before nine o'clock on every subsequent evening during the continuance of such meeting, the time and place of putting the first brace of dogs into the slips on the following morning shall be declared. A card or counter bearing a corresponding number shall be assigned to each entry. These numbered cards or counters shall then be placed together and drawn indiscriminately. This classification once made, shall not be disturbed throughout the meeting, except for the purpose of guarding, or on account of byes. Dogs whose position on the card has been altered in consequence of guarding or of byes must return to their original position in the next round, if guarding does not prevent it.

9. GUARDING.—When more than one nomination in a stake is taken in one name, the greyhounds, if *boná fide* the property of the same owner, shall be guarded throughout: this is always to be arranged, as far as possible, by bringing up dogs from below to meet those which are to be guarded. This guarding is not, however, to deprive any dog of a natural bye to which he may be entitled, either in the draw, or in running through the stake.

10. BYES.—A natural bye shall be given to the lowest available dog in each round. No dog shall run a second such bye in any stake, unless it is unavoidable. When a dog is entitled to a bye, either natural or accidental, his owner or nominator may run any greyhound he pleases to assist in the course, provided always that in sapling stakes only a sapling may be used, and in puppy stakes none older than a puppy. But if it is proved to the satisfaction of the Stewards that no puppy can be found in time to run an acci-

dental bye, the owner shall have the power of substituting an old dog. No dog shall run any bye earlier than his position on the card entitles him to do. The Judge shall decide whether enough has been done to constitute a course, or whether it must be run again. If at the commencement of any round in a stake, one dog in each course of that round has a bye, those byes shall not be run, but the dogs shall take their places for the next round as if the byes had been run.

11. POSTPONEMENT OF MEETING.—A meeting appointed to take place on a certain day may, if a majority of the Committee and the Stewards (if appointed) consider the weather unfit for coursing, be postponed from day to day; but if the running does not commence within the current week all nominations shall be void, and the expenses shall be paid by the subscribers, in proportion to the number of nominations taken by each. In the case of Produce Stakes, however, the original entries shall continue binding, if the meeting is held at a later period of the season.

12. TAKING DOGS TO THE SLIPS.—Every dog must be brought to the slips in its proper turn, *without delay*, under a penalty of £1. *If absent for more than ten minutes* (according to the report of any one of the Stewards) its opponent shall be entitled to claim the course, and shall in that case run a bye. If both dogs be absent at the expiration of ten minutes, the Stewards shall have power to disqualify both dogs, or to fine their owners any sum not exceeding £5 each. No dog shall be put into the slips for a deciding course until thirty minutes after its course in the previous round, without the consent of its owner.



13. CONTROL OF DOGS IN SLIPS.—The control of all matters connected with slipping the greyhounds shall rest with the Stewards of a meeting. Owners or servants, after delivering their dogs into the hands of the Slipper, may follow close after them, but not so as to inconvenience the Slipper, or in any way interfere with the dogs, under a penalty of £1. Neither must they halloo them on while running, under the same penalty. Any greyhound found to be beyond control, and mischievous in slips, may, by command of the Stewards, be taken out of the slips and disqualified.

14. GREYHOUNDS OF SAME COLOUR TO WEAR COLLARS.—When two greyhounds drawn together are of the same colour they shall each wear a collar, and the owners shall be subject to a penalty of 10s. for non-observance of this rule; the colour of the collar to be red for the left-hand side, and white for the right hand side of the slips. After the first round, the upper dog on the card for the day will be placed on the left hand, and the lower dog on the right hand of the slips.

15. The order to slip may be given by the Judge, or by a Slip Steward, or the Stewards of a meeting may leave the slip to the sole discretion of the Slipper. The length of slip must necessarily vary with the nature of the ground, but should never be less than from three to four score yards, and must be maintained of one uniform length, as far as possible, throughout each stake.

16. THE SLIPPER.—If one greyhound gets out of the slips, the Slipper shall not let the other go. In any case of slips breaking, and either or both dogs getting away in consequence, the Slipper may be fined not exceeding £1, at the discretion of the Stewards.

17. The Judge shall be subject to the general Rules which may be established by the National Coursing Club for his guidance. He shall, on the termination of each course, immediately deliver his decision aloud, and shall not recall or reverse his decision, on any pretext whatever, after it has been declared, but no decision shall be delivered until the Judge is perfectly satisfied that the course is absolutely terminated.

18. He shall decide all courses upon the one uniform principle that the greyhound which does most towards killing the hare during the continuance of the course is to be declared the winner. The principle is to be carried out by estimating the value of the work done by each greyhound, as seen by the Judge, upon a balance of points according to the scale hereafter laid down, from which also are to be deducted certain specified allowances and penalties.

19. The points of the course are—

- a. *Speed*—which shall be estimated as one, two, or three points, according to the degree of superiority shown. [See Definition below, *a.*]
- b. *The Go-by*.—Two points, or, if gained on the outer circle, three points.
- c. *The Turn*.—One point.
- d. *The Wrench*.—Half a point.
- e. *The Kill*.—Two points, or, in a descending scale, in proportion to the degree of merit displayed in that kill, which may be of no value.
- f. *The Trip*.—One point.

## DEFINITION OF POINTS.

- a.* In estimating the value of speed to the hare the Judge must take into account the several forms in which it may be displayed, viz. :—
1. Where in the run up a clear lead is gained by one of the dogs, in which case one, two, or three points may be given according to the length of lead apart from the score for a turn or wrench. In awarding these points the Judge shall take into consideration the merit of a lead obtained by a dog which has lost ground at the start, either from being unsighted or from a bad slip, or which has had to run the outer circle.
  2. Where one greyhound leads the other so long as the hare runs straight, but loses the lead from her bending round decidedly in favour of the slower dog of her own accord, in which case the one greyhound shall score one point for the speed shown, and the other dog score one point for the first turn.
  3. Under no circumstances is speed without subsequent work to be allowed to decide a course, except where great superiority is shown by one greyhound over another in a long lead to covert.

If a dog, after gaining the first six points, still keep possession of the hare by superior speed, he shall have double the prescribed allowance for the subsequent points made before his opponent begins to score.

- b. *The Go-by* is where a greyhound starts a clear length behind his opponent, and yet passes him in a straight run, and gets a clear length before him. .
- c. *The Turn* is where the hare is brought round at not less than a right angle from her previous line.
- d. *The Wrench* is where the hare is bent from her line at less than a right angle : but where she only leaves her line to suit herself, and not from the greyhound pressing her, nothing is to be allowed.
- e. *The merit of a kill* must be estimated according to whether a greyhound, by his own superior dash and skill, bears the hare ; whether he picks her up through any little accidental circumstances favouring him ; or whether she is turned into his mouth, as it were, by the other greyhound.
- f. *The Trip*, or unsuccessful effort to kill, is where the hare is thrown off her legs, or where a greyhound flecks her, but cannot hold her.

20. The following allowances shall be made for accidents to a greyhound during a course ; but in every case they shall only be deducted from the other dog's score :—

- a. *For losing ground* at the start, either from being unsighted, or from a bad slip, in which case the Judge is to decide what amount of allowance is to be made, on the principle that the score of the foremost dog is not to begin until the second has had an opportunity of joining in the course.

*b.* Where a hare bears very decidedly in disfavour of one of the greyhounds after the first or subsequent turns, in which case the next point shall not be scored by the dog who may be unduly favoured, or only half his point allowed, according to circumstances. No greyhound shall receive any allowance for a fall, or an accident of any description whatever, with the exception of being ridden over by the owner of the competing greyhound or his servant, provided for by Rule 24, or when pressing his hare, in which case his opponent shall not count the next point made.

21. Penalties are as follows :—

- a.* Where a greyhound, from his own defect, refuses to follow the hare at which he is slipped, when he shall lose the course.
- b.* Where a dog wilfully stands still in a course, or departs from directly pursuing the hare, no points subsequently made by him shall be scored; and if the points made by him up to that time be just equal to those made by his antagonist in the whole course, he shall thereby lose the course; but where one or both dogs stop with the hare in view, through inability to continue the course, it shall be decided according to the number of points gained by each dog during the whole course.
- c.* If a dog refuses to fence where the other fences, any points subsequently made by him are not to be scored; but if he does his best to fence, and is foiled by sticking in a meuse,

the course shall end there. When the points are equal, the superior fencer shall win the course.

22. If a second hare be started during a course, and one of the dogs follow her, the course shall end there.

23. GREYHOUND GETTING LOOSE.—Any person allowing a greyhound to get loose, and join in a course which is being run, shall be fined £1. If the loose greyhound belongs to either of the owners of the dogs engaged in the particular course, such owner shall forfeit his chance of the stake with the dog then running, unless he can prove, to the satisfaction of the Stewards, that he had not been able to get the loose greyhound taken up after running its own course. The course is not to be considered as necessarily ended when a third dog joins in.

24. RIDING OVER A GREYHOUND. If any subscriber, or his servant, shall ride over his opponent's greyhound while running a course, the owner of the dog so ridden over shall (although the course be given against him) be deemed the winner of it, or shall have the option of allowing the other dog to remain and run out the stake, and in such case shall be entitled to half its winnings, if any.

25. A "no course" is when by accident or by the shortness of the course the dogs are not tried together, and if one be then drawn the other must run a bye, unless the Judge on being appealed to shall decide that he has done work enough to be exempted from it. An undecided course is where the Judge considers the merits of the dogs equal, and if either is then drawn, the other cannot be required to run a bye; but the owners must at the time

declare which dog remains in. (See Rule 27.) The Judge shall signify the distinction between a "no course" and an "undecided," by taking off his hat in the latter case only. After an undecided or no course, if the dogs before being taken up get on another or the same hare, the Judge must follow, and shall decide in favour of one, if he considers that there has been a sufficient trial to justify his doing so. A "no course" or "undecided" may be run again immediately, or if claimed on behalf of both dogs, before the next brace are put into the slips, or in case of no course, if so ordered by the Judge, otherwise it shall be run again after the two next courses, unless it stand over to the next morning, when it shall be the first course run; if it is the last course of the day, fifteen minutes shall be allowed after both dogs are taken up.

26. The Judge shall render an explanation of any decision only to the Stewards of the meeting, if required, through them before the third succeeding course, by the owner, or nominator, or representative of the owner or nominator of either of the greyhounds engaged in the course. The Stewards shall, if requested to do so, express their opinion whether the explanation is satisfactory or not, and their opinion in writing may be asked for and published afterwards, but the decision of the Judge, once given, shall not be reversed for any cause.

27. WITHDRAWAL OF A DOG.—If a dog be withdrawn from any stake on the field, its owner, or some one having his authority, must at once give notice to the Secretary or Flag Steward. If the dog belong to either of these officials, the notice must be given to the other.

28. **IMPUGNING JUDGE.**—If any subscriber openly impugns the decision of the Judge on the ground, except by a complaint to the Stewards, according to Rule 26, he shall forfeit not more than £5, nor less than £2, at the discretion of the Stewards.

29. **STAKES NOT RUN OUT.**—When two greyhounds remain in for the deciding course, the stakes shall be considered divided if they belong to the same owner or to confederates, and also if the owner of one of the two dogs induces the owner of the other to draw him for any payment or consideration; but if one of the two be drawn without payment or consideration, from lameness, or from any cause clearly affecting his chance of winning, the other may be declared the winner, the facts of the case being clearly proved to the satisfaction of the Stewards. The same rule shall apply when more than two dogs remain in at the end of a stake, which is not run out, and in case of a division between three or more dogs, of which two or more belong to the same owner, these latter shall be held to take equal shares of the total amount received by their owner in the division. The terms of any arrangement to divide winnings and the amount of any money given to induce the owner of a dog to draw him must be declared to the Secretary.

30. **WINNERS OF STAKES RUNNING TOGETHER.**—If two greyhounds shall each win a stake, and have to run together for a final prize or challenge cup, should they not have run an equal number of ties in their respective stakes, the greyhound which has run the smaller number of courses must run a bye, or byes, to put itself upon an equality in this respect with its opponent.



31. **OBJECTIONS.** An objection to a greyhound may be made to any one of the Stewards of a meeting at any time before the stakes are paid over, upon the objector lodging in the hands of such Steward, or the Secretary, the sum of £5, which shall be forfeited if the objection proves frivolous, or if he shall not bring the case before the next meeting of the National Club, or give notice to the Stewards previous thereto of his intention to withdraw the objection. The owner of the greyhound objected to must deposit equally the sum of £5, and prove the correctness of his entry. All expenses in consequence of the objection shall be borne by the party against whom the decision may be given. Should an objection be made which cannot at the time be substantiated or disproved, the greyhound may be allowed to run under protest, the Stewards retaining his winnings until the objection has been withdrawn, or heard and decided. If the greyhound objected to be disqualified, the amount to which he would otherwise have been entitled shall be divided equally among the dogs beaten by him; and if a piece of plate or prize has been added, and won by him, only the dogs which he beat in the several rounds shall have a right to contend for it.

32. **DEFAULTERS.**—No person shall be allowed to enter or run a greyhound, in his own or any other person's name, who is a defaulter for either stakes, forfeits, or bets, or for money due under an arrangement for a division of winnings, or for penalties regularly imposed for the infraction of rules by the Stewards of any meeting, or for any payment required by a decision of the National Club, or for subscriptions due to any club entitled to have repre-

sentatives in the National Club. As regards bets, however, this rule shall only apply when a complaint is lodged with the Secretary of the National Club within six months after the bet becomes due. On receipt of such complaint the Secretary shall give notice of the claim to the person against whom it is made, with a copy of this rule, and if he shall not pay the bet, or appear before the next meeting of the National Club, and resist the claim successfully, he shall be considered a defaulter.

33. JUDGE OR SLIPPER INTERESTED.—If a Judge or Slipper be in any way interested in the winnings of a greyhound or greyhounds, the nominator in each case, unless he can prove satisfactorily that such interest was without his cognisance, shall forfeit all claim to the winnings; and if any nominator or owner of greyhounds shall give, or offer, or lend money or anything of value to any Judge or Slipper, such owner or nominator shall not be allowed to run dogs in his own or any other person's name during any subsequent period that the Club may decide upon.

34. Any person who is proved to the satisfaction of the National Club to have been guilty of any fraudulent or discreditable conduct in connection with coursing, may, in addition to any pecuniary penalty to which he may be liable, be declared incapable to run or enter a greyhound, in his own or any other person's name, during any subsequent period that the Club may decide upon.

35. BETS ON AN UNDECIDED.—All bets upon an undecided course shall stand, unless one of the greyhounds be drawn. All bets upon a dog running further than another in the stake, or upon the event, shall be p.p., whatever accident may happen; but

bets upon a deciding, as upon every other single course, are off if the course is not run.

36. BETS ON STAKES DIVIDED.—Where money has been laid against a dog winning a stake, and he divides it, the two sums must be put together, and divided in the same proportion as the value of the stakes.

---

#### DEER-STALKING.

It is needless to dilate upon the employment of this dog in deer-stalking, as his perfection depends entirely upon his amount of experience, and the degree of nose and sagacity which he naturally possesses.

---

#### HUNTING.

Fox-hunting has now become a science in itself, and it would be useless to attempt any minute detail here of all the features which attend upon it. I have already alluded at some length to the duties and peculiarities of the foxhound, in the description of the hound himself at page 55, and of the mode of entering him at page 245, beyond which I must refer my readers to the

pages of Beckford and Somerville, among the old authorities, and to “Nimrod,” Col. Cooke, the Hon. Grantley Berkeley, Mr. Delmé Radcliffe, and lastly “Scrutator,” among the modern writers on this subject. A treatise on Hunting must comprise at least as large a volume as the present, and, therefore, I may well be excused from going into it. For the same reason hare-hunting both with harriers and beagles must be passed over, as well as otter-hunting, beyond the notices which are given of the hounds used in these sports, at pages 63—67 and 70.

---

#### THE USE OF THE DOG IN SHOOTING.

The dogs used in aid of the gun are: the pointer, the setter, in grouse- and partridge-shooting; the spaniel, beagle, and terrier, in covert-shooting; either of the above in snipe-shooting; and the water-spaniel or retriever in wildfowl-shooting.

---

#### GROUSE- AND PARTRIDGE-SHOOTING.

*In open shooting*, whether of the grouse or partridge, there is a great difference of opinion respecting the choice of a dog, that is, whether the pointer or setter shall be selected, and, if either, the particular breed. In order to arrive at any conclusion

on this *questio verata*, it is desirable to consider what are the chief differences between the two kinds of shooting, and also between the two kinds of dog which have to beat the respective grounds on which partridge and grouse are found. Every sportsman knows that the former are chiefly met with in cultivated corn-lands, and especially on a light sandy soil suited to barley, such as that of Norfolk and part of Suffolk. Here these birds are preserved in immense numbers; and there is no heather, or other rough undergrowth of any kind, to scratch the skin or to wear away the hair on the legs, the only part which suffer at all being the pads of the feet. Indeed in too many cases, according to my opinion, the dog is dispensed with altogether in actual shooting; and the birds being driven into the turnips by spaniels, assisted by a man on horseback, are afterwards walked up by the shooters, who require only a retriever to find the wounded birds. In wilder districts where the birds are more scarce the pointer or the setter is used, but he is always worked within fifty or sixty yards of his master, and is never on any account suffered to "break fence." Hence the amount of ground beaten is comparatively small, but it is of such a nature, being composed almost entirely of stubble, fallow, or turnips, that it requires a good nose to find game, while at the same time the scent of the partridge is very mild as compared with that of the grouse; on the other hand, this latter bird is found where they are scattered indiscriminately over the heath-covered slopes, and where dogs are essential to success, because there are no turnips or other cover to drive them into, and they are as

likely to be on one spot as another. Hence every inch of ground must be beaten, and often a day's sport covers two or three thousand acres or even more. The scent of the grouse is also stronger than that of the partridge, and from the nature of the heather he is disposed to lie closely, unless made wild by constant disturbance, so that with good dogs he is seldom put up out of shot. The heather is very rough and irritating, and as it works up between the toes it makes the interspaces extremely sore if they are not well covered with hair.

From these varying circumstances it results that a careful dog, not ranging too wide, but going steadily to work, and keeping at it at such a pace as to make sure of not flushing a bird, perfectly steady "before and behind" and "down charge," is the dog for partridge-shooting; while a wider ranger, with perhaps a trifle less delicacy of nose, will be preferred for grouse-shooting, especially if he will last for a longer time at his work, and will bear the constant friction of the heather. Now it is clear to every one who has had much experience of the two kinds of dog, that the pointer has the more delicate nose; for though some setters may compete with any pointer in this particular, yet, on the whole, the average of setters are inferior to the average of pointers in powers of scent. The pointer is also more easily broken, and when perfect, remains so with more certainty, but he has the disadvantage of more readily tiring, and his toes sooner become sore if used in heather. On the whole, therefore, though there are numerous exceptions, the pointer is more suited to partridge-shooting, and the setter to grouse. If, however, the sportsman has a fancy for

or against either, and selects the smooth dog for the moors, he should fix upon a strong coarse-haired dog, and those with a cross of the foxhound seem to be generally preferred ; but they have some of the disadvantages of the setter, being much more difficult to break than the genuine pointer, but are far more hardy and enduring. Indeed, some of this breed will beat the setter in pace and endurance ; while the nose of the hound, being as good as that of the pointer, or nearly so, does not lower the power of scent, but it has a tendency to make the dog lose that fine handsome range which the true breed possess, as displayed in the high carriage of the head when at work, which is so beautiful to the eye of the sportsman. With regard to the peculiar breed of each which is to be selected, I should advise the modern pointer without the foxhound cross (or, if any, very remote), taking care that there is endurance enough to carry the dog through a good day's shooting. On the average, few pointers will beat as they should do for more than four or six hours, and even this amount of work cannot be maintained for many days together. I have had one or two dogs which no one man could tire, but these were light greyhound-like animals ; and though they could do wonders on a good scenting day, they were useless on a dry September afternoon, without any wind stirring. It is true that few dogs will find game on such a day ; but there are some which will reduce their pace accordingly, and these are generally to be found among the true pointers, bred with as large heads as possible, consistently with the possession of frames suited to go through their work. They need not be very fast, but they should keep at their work steadily, and in that way

will cover a vast deal of ground in a short time, never flushing even a single bird, and rarely leaving one behind them. Such a dog, if well matched with another, is the one to kill game to; and if the sportsman will only give the brace time to try their ground, and will avoid spoiling them by running in to wounded birds and other indiscretions, he will find that for all kinds of open shooting they are invaluable. Irish setters are thought very highly of by some people; but those which I have used have been headstrong and unruly, while I never found any superiority in their noses, nor is their endurance, as far as I have seen, greater than that of our best English breeds. With a dog formed like the animal from which the engraving at page 97 was taken, great endurance may be expected, and his nose was equal to any emergency. The Russian setter I know very little of, so can give no reliable opinion on his merits.

*In conducting the beat*, whether for partridge or grouse, it is always desirable to give these dogs the wind, inasmuch as they generally find their game by the scent wafted to them in the air, and not by the foot-scent. Sometimes they are obliged to "road" a running bird, especially with grouse, which will often take the pointer or setter a long way, and a stupidly stiff old-fashioned pointer which refuses to stir is an abomination. Nothing is more annoying than to see birds get up far out of shot, while the pointer is "steady as a crutch" at his first point, where he caught the scent and where they started from. A sensible dog would either have drawn up to his birds after waiting till his master was close up, or he would have left his



point and gone round to head them if he was unusually clever in his vocation. Such a feat is by no means unattainable, if dogs are broken to beat *towards* the shooter as explained at page 258; but some stupid brutes will never learn to do it of their own accord, and must be sent round by their master, which causes delay and takes away half the advantage of the plan. Beyond a repetition of the cautions as to making the dog work to hand, and keeping him steady "down charge," there is little more to be said on the use of the pointer and setter.

---

#### SNIPE-SHOOTING.

The following observations on snipe-shooting in Ireland, by an Irish sportsman, recently appeared in the columns of "The Field;" and, as the writer has had far more experience in this department of sport than I can lay claim to, I prefer introducing these extracts to inserting the results of my own experience, which, however, are strictly in accordance with his.

"In Ireland the best sportsmen do not commence snipe-shooting until the November frosts set in. This is sometimes considered an old-fashioned prejudice; but there are good reasons why it should be postponed until that season. For, although the birds bred here are in good condition in September, or even earlier, they do not, except to the mere tyro, afford any-

thing like the same sport. Instead of the ringing scream and rapid eccentric flight with which they dart away from the shooter through the thin frosty air of a winter's day, they flutter up with a faint cry from his feet, fly straight forward, and pitch almost immediately; while, to the gourmand, the difference in flavour between a bird placed on the table in September and December is almost as great as between a spent salmon and one fresh run from the sea. On the other hand, those birds which arrive here in October, during the equinoctial gales, are so thin and worn out with their long flight as scarcely to be worth powder and shot.

“In shooting these birds, with or without a dog, it is always better to hunt down the wind, as, unless it is blowing a hurricane, they always fly against it. By this means the sportsman will get two shots for one he would otherwise obtain. The popular idea that the slightest graze will bring down a snipe is, like many popular ideas, a fallacy; no bird requires more careful marking. After being fired at, I have known them fly nearly out of sight when shot clean through the body, and then drop suddenly dead. This happens most frequently when very light shot has been used; and for that reason I would always recommend the shooter to load the second barrel with No. 6 shot. It has another advantage. He will often meet hares, teal, and duck at distances where his light shot would be thrown away; and it is well to be prepared for them. If a snipe stops screaming and stoops in his flight after being fired at, it is a pretty

good sign that he is hit hard. If his legs drop, he is mortally wounded, and will never fly far.

“In some marshes snipes are very wild, rising in wisps, before you can come within range. This generally occurs when the ground is wet, and the birds are sitting upon the little hillocks above the water. In such cases the dog should be tied up, and the sportsman ought to walk them up alone. If this does not succeed, the only chance left is to stand (under cover if possible) at the windward end of the bog, and send the attendant in to leeward, with directions to make as little noise as possible; by this means a few shots may be obtained, and you will have an opportunity of, perhaps, marking some of the birds down in more favourable ground. At all events, there is the chance of meeting them when scattered through the country.

“Many an old Irish sportsman will smile at the idea of any person giving directions for finding snipe. Until the last few seasons they have been so numerous, that all he had to do was to walk into the first marsh and blaze away until the light failed, or his ammunition was expended. What with severe and long-continued frosts, however, drainage, and other ‘dreadful inventions of science,’ as one of your correspondents terms agricultural improvements, we are not (except in a few happily situated Alsacias) so sure of a good bag as we were: it may, therefore, be worth the shooter’s while to study the habits of these birds. Indeed, every sportsman ought to be something of a ‘field naturalist,’ as it gives him an additional enjoyment in his favourite sport.

“The state of the weather is, I believe, the great clue to the haunts of the snipe, their delicate organization making them peculiarly sensitive to atmospheric influences. At the first breath of the autumn frosts, those birds which have been bred upon the mountains leave their summer quarters, and come down to the vast bogs which still abound in some parts of our island. Here they are soon joined by their comrades from Scotland and the North of Europe, who rapidly recover from the effects of their long flight; and from that time forward, until the arrival of spring scatters them again, their life is one constant succession of changes from one part of the country to another, moving towards the sea-shore, the mountains, or inland, according as the season is mild or severe.

“In very mild wet weather, snipe leave the bogs and return to the mountains, where it is scarcely worth the sportsman’s while to follow them. With a good dog, however, fair sport can be had at such times by beating rushy coarse pastures and heathery uplands, where he will be sure to find a considerable number of outlying birds. In this description of ground they lie well to a dog, and are much easier to shoot than in the bogs, where the unsteadiness of footing makes it difficult to take accurate aim.

“I have always found northerly winds with hail showers the best weather for the marshes. The hail drives the birds down from the mountains, collects them together, and makes them unwilling to rise. In white frosts they are generally wild, though numerous; in hard black frosts they assemble in wisps

about the margin of unfrozen springs, along the borders of streams, or in marshes near the shore. Bent grass is also a favourite haunt at such times, as frost has seldom any effect upon it. Should the severe weather continue, they take to the plantations like woodcocks, to furze covers on southern slopes, and to the rocks on the shore.

“Snipe are very restless at night, but, unless disturbed, seldom move in the daytime. During bright moonlight nights they travel a great deal, and are fond of feeding on the sea-shore. Walking along the coast at such times, I have put them up in dozens, and even in daylight have shot them on a strand. In beating a marsh near the sea I have always been least successful when the tide was out, which I could only account for by the supposition that the birds were then feeding upon the strand.

“In some districts in Ireland there are what are called black and red bogs. The sportsman will sometimes find them in one and sometimes in the other, *never* in both together. I cannot account for this, as the weather does not appear to be the cause; at least, I could not observe any marked change.

“Almost any dog can be trained to set snipe. Water spaniels and Newfoundlands have been known to do it; and I once shot for part of a season over a little Dinmont terrier. But the dog of all dogs for that sport—or indeed any sport—is the old Irish setter, when he can be got pure. Handsome, courageous, hardy, and delighting in water, he is (as an old gamekeeper remarked to me once) ‘a companion for any gentleman.’ The dropper is also

a capital dog for general purposes in a wet country. One of the finest animals I ever saw of this kind was the produce of a cross between a Russian and a smooth pointer. They are, however, difficult to train, and curiously ugly. The smooth pointer should never be used in snipe-shooting. They have a natural dislike to the water, and, although their high breeding and courage make them disregard it when in pursuit of game, any one who has seen them cowering at their master's heels after a hard day's work on a cold wintry day cannot but feel compassion for these noble animals.

“In training dogs for snipe-shooting they should be broken as much as possible to ‘hand.’ Shouting or talking in a bog ought always to be avoided; more birds will be sprung in that way than by the report of the gun. No dog that splashes through the water, or with bad feet, should be used for snipe. It is in his peculiar style of going that the old Irish setter shows his superiority to all other dogs for this sport; not pottering or plowtering among the reeds, like a tame drake, but moving through the marsh with a long, light, stealthy pace, like a panther in search of prey.

“The system of training dogs in Ireland is, generally speaking, very bad,—in fact, cannot well be worse. Three guineas and a hundred-weight of meal is the usual charge; and for this you will get plenty of so-called gamekeepers and trainers willing to undertake the duty. I do not object to the price, which is moderate enough, if the duty was properly performed; but do object, and very strongly, to the fact that not one grain of the

meal ever finds its way to the stomach of the unfortunate animal for whose benefit it was ostensibly bought. This would not suit the trainer's purpose, whose object is to return him 'broken' in the shortest possible time (and broken he certainly is, with a vengeance). This can only be accomplished by fasting and flagellation, and accordingly both are put liberally in requisition; the former by leaving the dog entirely to his own resources, when the chances are, he takes to killing his own mutton; and the latter, by the unsparing use of the whip, or the butt end of the gun, according as his master is drunk or out of temper. The consequences may easily be anticipated. Should he survive this treatment, he is returned at the end of three months, thoroughly cowed and heart-broken, and in such a state of starvation that his owner will have some difficulty in recognising his favourite. Should he succeed in getting once more into condition, it will be found that he has forgotten all he ever learned under the former system, and will require to be trained over again.

"I would therefore recommend the sportsman, if he can spare time, by all means to break his own dogs. If he succeeds, and a little patience and temper are all that is required to make success certain, he will be amply repaid, for a dog works far better for the man who trains him than for any one else. A sort of mutual understanding springs up between them; the dog gets into his master's ways, and a look or a gesture is sufficient to make him comprehend his meaning. Better this, surely, than the constant rating and flagellations which make it positively

painful to go out with some men, who are everlastingly using the whip upon their unhappy slaves.

“If the snipe-shooter wishes to keep his dogs in health and condition, free from coughs and colds, and always fit for work, he must not be above looking after them himself when their day’s work is done, instead of handing them over to ignorant or careless servants. Their legs and feet should be well washed in warm water before consigning them to the kennel, which ought to be comfortable and dry, and provided with a liberal allowance of straw.—HENRY CLIVE.”

---

## COVERT SHOOTING.

This kind of shooting is generally carried out by the aid of human beaters, who, either with or without dogs, enter the covert and drive the game to the shooter. Sometimes, however, the sportsman has a train of thoroughly broken spaniels, beagles, or terriers, and with these he goes quietly to work, either making them drive the game to him, or else keeping them at work so close to him, as he walks through the covert, that any game which is disturbed comes within shot. In either case the dogs should be thoroughly under command, as has been explained in the



chapter treating of the breaking of them to the gun, and, beyond the remarks there introduced, there is little to be said. A practical acquaintance with each animal is more requisite here than in any other kind of shooting, because the sportsman always is being called upon to judge of the proximity of the dog to his game, and of the kind of game also by his note at the time. Hence practice is all important, and directions are of little avail. The shooter must, however, be quick in his movements in getting to his dogs when they give tongue in a way to lead him to expect that they are close upon their game, or he will get few shots; and in this one of the chief arts of covert shooting consists. It is, however, useless to attempt any further explanation of its details.

*Whether spaniels, beagles, or terriers* make the best covert dogs is a point which is sometimes discussed; but I think there is a general feeling in favour of the first, and at present the Clumber spaniel is certainly the fashion. He is more suited to *battues*, which are now the only kinds of covert shooting much in vogue, for the reason that pheasants will not bear disturbing many times in the season, and so the proprietor of a large preserve likes to give the greatest happiness to the greatest number of his friends on the small number of days which his gamekeeper advises him that he can afford. These spaniels, however, are too heavy for wild woodlands, or for cock-shooting, for which the light corky cocker must be employed. But between these two there is little room for the too noisy beagle, or the too silent terrier, and they are therefore seldom used, though the last is very useful to the

single sportsman who goes quietly poking about in search of a shot.

---

## WILDFOWL-SHOOTING.

As far as the dog is concerned, this kind of sport requires a steady water spaniel or retriever, with a good nose, and thoroughly accustomed to his work. In river and pond shooting, he will have to find as well as to retrieve the ducks or other kinds of water-fowl which are sought for; but in the marine variety his sole use is to retrieve the dead and crippled birds, which would otherwise be beyond the reach of the shooter. For each kind, however, the power of retrieving is most important, and no one would think of embarking in this sport without a dog thoroughly broken in this respect, or likely to become so. Those who wish to become expert in it, and have no friend or servant able to teach them the various details necessary for its successful prosecution, will do well to consult the pages of Col. Hawker, who has written most minute instructions for the construction and management of punts, punt guns, &c., in his celebrated work on shooting.

---

## THE USE OF TERRIERS IN FERRETING, RATting, ETC.

Beyond the necessity for entering these dogs to their game, and breaking them from destroying the ferrets, little can be said on the mode of using them. Some practice is of course required to do these things well and successfully, but the oral instructions of a good keeper or ratcatcher are of far more value than all the written directions which can be given.

## BOOK III.

THE DISEASES OF THE DOG AND THEIR TREATMENT.



## CHAPTER I.

## PECULIARITIES IN THE ANATOMY AND PHYSIOLOGY OF THE DOG.

The Skeleton including the Teeth.—The Muscular System.—The Brain and Nervous System.—The Digestive System.—The Heart and Lungs.—The Skin.

## THE SKELETON\*, INCLUDING THE TEETH.

IN the skeleton of the dog and in that of the horse, as well as of all other animals remarkable for their speed, there is a peculiar formation of the chest which deserves to be noticed. The principle of construction in every *thorax*, as this part is called scientifically, is that of dilatation and contraction, by which its entire contents are lessened or increased, and thereby air is made to pass in and out. In man this is chiefly caused by the front of the chest rising and falling, and in this way increasing the diameter from before backwards, but in the dog, horse, deer, &c., the increase is from side to side, the ribs being sickle-shaped, and acting laterally like the gill-covers of a fish. From this it often arises that a narrow-chested horse or dog may have better wind than another with a round barrel, because he is able to alter the cubic contents of his chest more rapidly, and thus inspire and expire a larger volume of air. A round barrel is nearly at its greatest expansion, and though it can contract it cannot dilate its volume, while the chest that is too flat can expand rapidly, but then it

\* See next page.

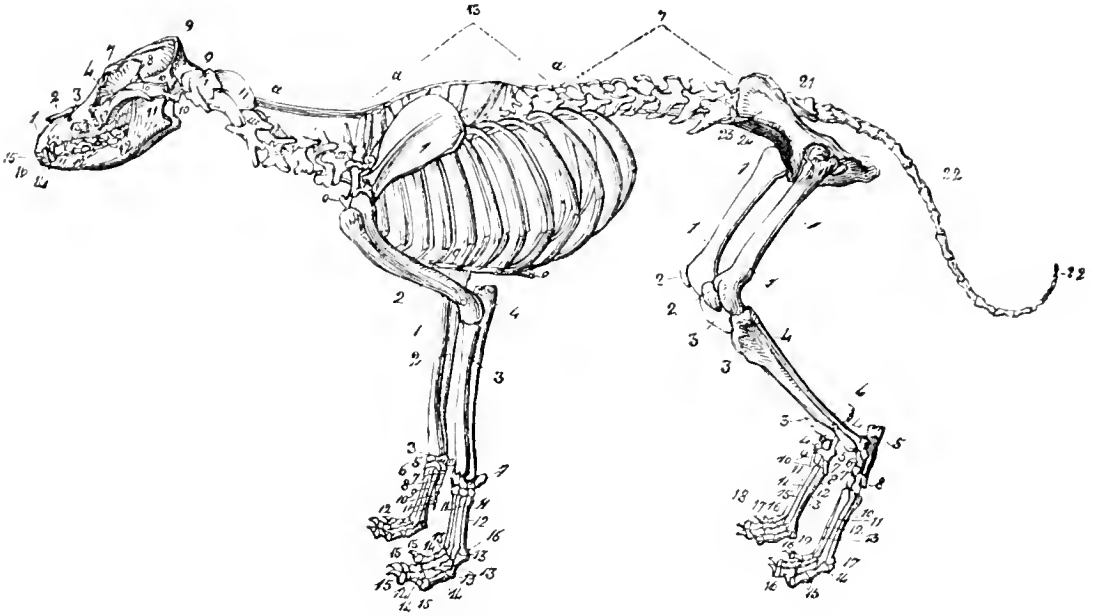

The Skeleton of the Dog. (Youatt.)

## THE HEAD.

- |                             |   |
|-----------------------------|---|
| 1. The intermaxillary bone. | 11, 11, 11. Inferior maxillary or jaw-bone.             |
| 2. Nasal bone.              | 12, 12. Seven inferior maxillary molar teeth.           |
| 3. Maxilla superior.        | 13, 13. Six molar teeth of the superior jaw.            |
| 4. Lachrymal bone.          | 14. Canine teeth of the superior and inferior jaws.     |
| 5. Zygomatic bone.          | 15. Three incisor teeth of the superior maxillary bone. |
| 6. Orbit.                   | 16. The three inferior ditto.                           |
| 7. Frontal bone.            |   |
| 8. Parietal bone.           |   |
| 9, 9. Occipital bone.       |   |
| 10, 10, 10. Temporal bone.  |   |

## THE TRUNK.

- |   |  |
|---|--|
| <i>a, a, a.</i> The ligamentum nuchæ.                       | 22, 22. Twenty caudal vertebræ — vertebræ of the tail. |
| 1. II. III. IV. V. VI. VII. The seven vertebræ of the neck. | 23. The left os innominatum.                           |
| 13. The thirteen dorsal vertebræ.                           | 24. Right ditto.                                       |
| 7. The seven lumbar vertebræ.                               | The nine true ribs, with their cartilages.             |
| 21. Os sacrum, or rump-bone.                                | The four false ribs, with their cartilages.            |
| <i>a, a.</i> The sternum.                                   |  |

## THE LEFT ANTERIOR EXTREMITY.

- |   |   |
|---|---|
| 1. The scapula, or shoulder-blade.                        | 11. Os metacarpi digiti quarti — fourth metacarpal.   |
| 2. Os humeri, or arm-bone.                                | 12. Os metacarpi digiti quinti.                       |
| 3. Radius—the lesser bone of the arm.                     | 13, 13, 13, 13. The first phalanges of the fore feet. |
| 4. The elbow, or olecranon process of the ulna.           | 14, 14, 14, 14. The second ditto.                     |
| 7. Os pisiforme, or pisiform bone.                        | 15. The third ditto.                                  |
| 10. Os metacarpi digiti tertii—the third metacarpal bone. | 16. The sesamoid bone.                                |

## THE RIGHT ANTERIOR EXTREMITY.

- |  |   |
|--|---|
| 1. Radius.   | 9. Ossa metacarpi digitorum quatuor — the four bones of the metacarpus. |
| 2. Ulna.   | 10. Phalanx prima pollicis—first phalange of the thumb.                 |
| 3. Os triquetrum—the triangular bone.                | 11. Phalanx tertia pollicis—third phalange of ditto.                    |
| 5. Os semilunare—the semilunar bone.                 | 12. Digi quatuor—phalanges of the four toes.                            |
| 6. Os multangulum majus—the larger multangular bone. |   |
| 7. Os multangulum minus—the small multangular bone.  |   |
| 8. Os metacarpi pollicis—the thumb.                  |   |

## THE LEFT POSTERIOR EXTREMITY.

- |   |  |
|---|--|
| 1, 1. Os femoris—thigh-bone.                        | 9. Os cuneiforme tertium et maximum.   |
| 2. Patella—the knee-pan.                            | 10. Os metatarsi digiti quarti.        |
| 3, 3. Tibia—the shank of the leg.                   | 11. Os metatarsi digiti tertii.        |
| 4, 4. Fibula—the small bone of ditto.               | 12. Os metatarsi digiti secundi.       |
| 5. Os calcis—the heel.                              | 13. Os metatarsi digiti primi.         |
| 6. Astragalus—one of the seven bones of the tarsus. | 14. Phalanges primæ digitorum pedis.   |
| 7. Os naviculare—the navicular bone.                | 15. Phalanges secundæ digitorum pedis. |
| 8. Os cuboideum—or cubic bone.                      | 16. Phalanges tertiæ digitorum pedis.  |
|   | 17. Os sesamoideum—the sesamoid.       |

## THE RIGHT POSTERIOR EXTREMITY.

- |   |  |
|---|--|
| 1. Os femoris—the thigh-bone.                       | 11. Os cuneiforme secundum et minimum.   |
| 2. Patella—the knee-pan.                            | 12. Rudimentum ossis metatarsi hallucis. |
| 3. Tibia—the shank of the leg.                      | 13. Os metatarsi digiti primi.           |
| 4. Os calcis—the heel-bone.                         | 14. Os metatarsi digiti secundi.         |
| 5. Astragalus—one of the seven bones of the tarsus. | 15. Os metatarsi digiti tertii.          |
| 7. Os naviculare—the navicular bone.                | 16. Phalanges primæ digitorum.           |
| 8. Os cuneiforme primum et medium.                  | 17. Phalanges secundæ digitorum pedis.   |
| 9. Os cuboideum, or cubic bone.                     | 18. Phalanges tertiæ digitorum pedis.    |
| 10. Os cuneiforme tertium et maximum.               | 19. Os sesamoideum—the sesamoid.         |



has not the power of contraction beyond its natural limits. A medium transverse diameter is therefore to be desired, and is practically found to be advantageous, in allowing a better action of the shoulder-blades rolling upon the surface on each side. On the other hand, man requires great depth of chest from before backwards if he is to have good wind, and the lateral diameter is of less importance. These facts ought to be taken into consideration in selecting the best kind of frame for the purposes of speed and endurance.

*Large size of bone* contributes to the strength of the limbs, and foxhounds especially, which have continual blows and strains in their scrambling over or through fences of all kinds, require big limbs and joints. When, however, extreme speed is desired, as in the greyhound, there may be an excess of bone, which then acts as so much lumber, and impedes the activity. Still, even in this dog, the bones and joints must be strong enough to resist the shocks of the course, without which we constantly find them liable to fracture or dislocation. If, however, a dog is brought up at liberty, and from his earliest years is encouraged in his play, the bones though small are strong, and the joints are united by firm ligaments which will seldom give way.

*The dog has no collar-bone*, so that his fore quarter is only attached to the body by muscular tissue. This is effected chiefly by a broad sling of muscle, which is attached above to the edge of the shoulder-blade, and below to the ribs near their lower ends. It is also moved backwards by muscles attached to the spine, and forwards by others connected in front to the neck and

head, so that at the will of the animal it plays freely in all directions.

*The teeth* are 42 in number arranged as follows:—

Incisors  $\frac{3-3}{3-3}$ : Canines  $\frac{1-1}{1-1}$ : Molars  $\frac{6-6}{7-7}$

Fig. 1.

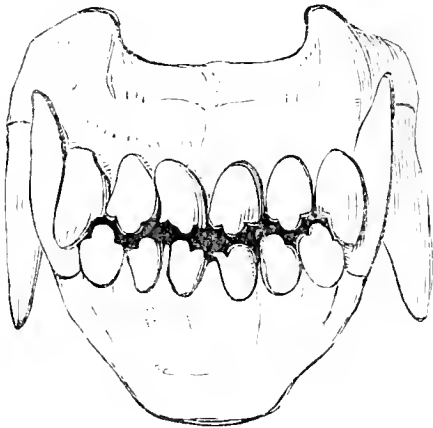

Fig. 2.

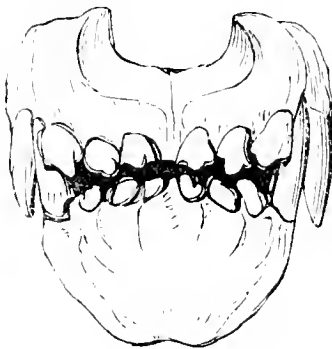
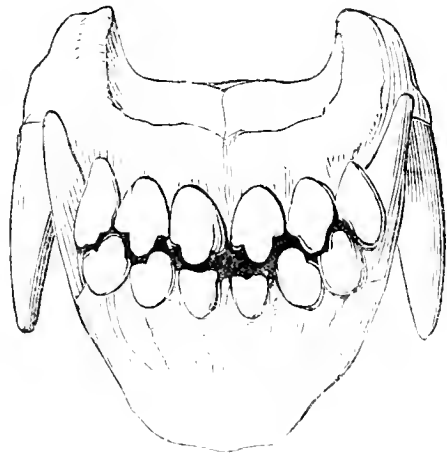

Fig. 3.

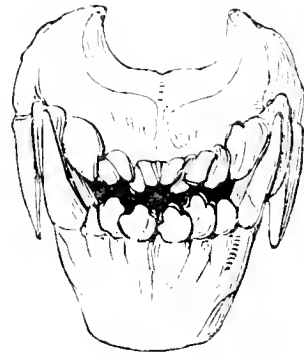

Fig. 4.

TEETH OF THE DOG AT VARIOUS AGES.

The *incisors* are somewhat remarkable in shape, having three little lobules at their edges resembling a *fleur-de-lis* (Fig. 1). Next to these come the canine teeth or tusks, and then the molars, which

vary in form considerably. In the upper jaw, in front, are three sharp and cutting teeth, which Cuvier calls *false* molars; then a tooth with two cutting lobes; and lastly two flat teeth, or *true* molars. In the under jaw, the first four molars on each side are *false*, or cutters; then an intermediate one, with the posterior part flat; and lastly two tubercular teeth, or true molars. As the incisors are worn away and the dog becomes old, the lobules on the edges wear away and are flattened (see Figs. 3 and 4). The teeth are developed in two sets; the first, called *milk-teeth*, showing themselves through the gums about a fortnight or three weeks after birth, and lasting till the fifth or sixth month, when they are displaced by the *permanent set*, the growth of which is accompanied by a degree of feverishness which is often mistaken for distemper. The dog's teeth should be beautifully white, if he is healthy and well reared, and until the third year there should be no deposit of tartar upon them, but after that time they are always coated with this substance at the roots, more or less, according to the feeding and state of health.

The *fore feet* are generally provided with five toes, and the hind with four, all furnished with strong nails that are not retractile. The inner toe on the fore feet is more or less rudimental, and is called the dew-claw; while there is also sometimes present in the hind foot a claw in the same situation still more rudimental, inasmuch as there is often no bony connexion with the metatarsal bone. This also is called the dew-claw, when present.

---

## THE MUSCULAR SYSTEM.

The *muscles* of the dog have nothing remarkable about them, excepting that they are renewed and wasted faster than in most animals. This has passed into a proverb, and should be known as influencing the time which dogs take to recruit their strength.

---

## THE BRAIN AND NERVOUS SYSTEM.

The *nervous system* is highly developed in those breeds which have been carefully attended to, that is, where individuals of high nervous sensibility have been selected to breed from. This is therefore remarkable in the bulldog, selected for generations for courage; in the pointer, where steadiness in pointing has been the prominent cause of choice; and in the greyhound, whose characteristic is speed; all requiring a high development of the nervous system, and all particularly liable to nervous diseases, such as fits, chorea, &c. On the other hand, the cur, the common sheep-dog, &c., seldom suffer from any disease whatever.

---

## THE DIGESTIVE SYSTEM.

The *stomach* of this animal is extremely powerful in dissolving bones, but it is also very liable to sickness, and on the slightest disturbance rejects its contents. This appears to be almost a natural effect, and not a diseased or disordered condition, as there is scarcely a dog which does not wilfully produce vomiting occasionally by swallowing grass. Few medicines which are at all irritating will remain down, and a vast number which are supposed to be given are not retained on the stomach, while others are only partially so. The bowels are extremely liable to become costive, which is in great measure owing to the want of proper exercise, and this also is very apt to produce torpidity of the liver. It may, however, be observed that in almost all particulars, except the tendency to vomit, the digestive organs of the dog resemble those of man.

---

## THE HEART AND LUNGS.

There is nothing whatever remarkable in the heart and lungs; but the blood-vessels, like those of most of the lower animals, are so elastic in their coats that they quickly contract when divided, and a fatal bleeding rarely results.

---

## THE SKIN.

The skin of the dog is said to be quite free from perspiration, but this is a mistake, as I have often seen the short hairs of a smooth-coated dog glistening with fine beads of liquid, poured out on a hot day, when strong exercise was taken. The tongue, however, is the grand means of carrying off heat by evaporation, and its extensive surface, when hanging out of the mouth, is sufficient for the purpose, as the fluid is carried off more rapidly from the air passing over it in expiration. I am persuaded that a considerable amount of insensible perspiration is constantly going on from the surface of the skin, and that nothing ought to be done which is likely to check it. This, however, is contrary to the generally received opinion, which is that nothing of the kind takes place in this animal.

## CHAPTER II.

THE REMEDIES SUITED TO THE DOG, AND THE BEST MEANS OF  
ADMINISTERING THEM.

Alteratives. — Anodynes. — Antispasmodics. — Aperients. — Astringents. — Blisters. — Caustics. — Charges. — Cordials. — Diuretics. — Embrocations. — Emetics. — Expectorants. — Fever medicines. — Clysters. — Lotions. — Ointments. — Stomachics. — Styptics. — Tonics. — Worm medicines. — Administration of Remedies.

## ALTERATIVES.

THESE are medicines which are given with a view of changing an unhealthy into a healthy action. We know nothing of the mode in which the change is produced, and we can only judge of them by the results. The most powerful are mercury, iodine, hemlock, hellebore, and cod-liver oil, which are given in the following formulas :

1.—Æthiop's mineral,  $1\frac{1}{2}$  to 5 grains.

    Powdered rhubarb, 1 to 4 grains.

    ,, ginger,  $\frac{1}{2}$  to  $1\frac{1}{2}$  grain.

Mix and make into a pill, to be given every evening.

2.—Hemlock extract, or fresh-bruised leaves, 2 to 4 grains.

    Plummer's pill,  $1\frac{1}{2}$  to 5 grains.

Mix, and give every night, or every other night.

3.—Iodide of potassium, 2 to 4 grains.

Liquid extract of sarsaparilla, 1 drachm.

Mix, and give in a little water, once or twice a day.

4.—Stinking hellebore, 5 to 10 grains.

Powdered jalap, 2 to 4 grains.

Mix into a bolus, and give every other night.

5.—Cod-liver oil, from a teaspoonful to a tablespoonful.

To be given twice a day.

---

#### ANODYNES.

Anodynes are required in the dog chiefly to stop diarrhœa, which is a very common disease in him. Sometimes also they are used for the purpose of relieving spasm. Opium is so little objectionable in the dog that it is almost the only anodyne used; but the dose must be far larger than for human beings, and less than a teaspoonful of laudanum for an average dog will be found to be wholly inert.

For slight purging :

6.—Prepared chalk, 2 to 3 drachms.

Aromatic confection, 1 drachm.

Laudanum, 3 to 8 drachms.

Powder of gum arabic, 2 drachms.

Water, 7 ounces.

Mix, and give two tablespoonfuls every time the bowels are relaxed.



OR,

7.—Castor oil, from a dessert to a tablespoonful.

Laudanum, 1 to 2 drachms.

Mix, and give as a drench, repeating it in a day or two if necessary.

For long standing and severe purgation :

8.—Creasote, 2 drachms.

Laudanum, 6 to 8 drachms.

Prepared chalk, 2 drachms.

Powdered gum arabic, 2 drachms.

Tincture of ginger, 2 drachms.

Peppermint water, 6 ounces.

Mix, and give two tablespoonfuls every time the bowels are relaxed, but not more often than every four hours.

#### ANTISPASMODICS

Are useful in allaying cramp or spasm, but, as in the case of Alteratives, we do not know how they act. The chief are opium, æther, spirit of turpentine, and camphor, prescribed according to the following formulas :

9.—Laudanum,

Sulphuric æther, of each  $\frac{1}{2}$  to 1 drachm.

Camphor mixture, 1 ounce.

Mix, and give in any ordinary spasm, as colic, &c.

An antispasmodic injection :

10.—Laudanum,

Sulphuric æther,

Spirit of turpentine, of each 1 to 2 drachms.

Gruel, 3 to 8 ounces.

Mix, and inject with a common clyster syringe.

## APERIENTS.

Aperients, opening medicines, or purges, by which several names this class of medicines is known, are constantly required by the dog, though it is a great mistake to give them when they are not absolutely demanded by the necessity of the case. All act by quickening the ordinary muscular action of the bowels, but some also stimulate the lining membrane to pour out large quantities of watery fluid, and others either directly or indirectly compel the liver to increase its secretion of bile. Hence they are often classed into corresponding divisions, as laxatives, drastic purgatives, &c. The chief of these drugs used in the dog-kennel are aloes, colocynth, rhubarb, jalap, ipecacuanha, senna, calomel, and blue pill, all of which act more or less on the liver; while Epsom salts, castor oil, and croton oil open the bowels without any such effect. Syrup of buckthorn is commonly given, but has little effect; and, indeed, the syrup of red poppies is generally substituted for it by the druggist, who seldom keeps the genuine article, from the belief that it is inert.

A mild bolus :

- 11.—Barbadoes aloes, 10 to 15 grains.
- Powdered jalap, 5 to 8 grains.
- Ginger, 2 or 3 grains.
- Soap, 10 grains.

Mix into one bolus for a large dog, or divide into two or three for small ones, and give as required.

## Strong bolus :

12.—Calomel, 3 to 5 grains.

Jalap, 10 to 20 grains.

Mix with syrup, and give as a bolus.

## A good common aperient, when the liver is sluggish :

13.—Podophyllin,  $\frac{1}{3}$  grain.

Compound extract of colocynth, 12 to 18 grains.

Powdered rhubarb, 3 to 5 grains.

Oil of cloves, 2 drops.

Mix, and give as a bolus to a large strong dog, or divide into two or three for smaller dogs.

## Very strong purgative when there is an obstruction :

14.—Croton oil, 1 to 2 drops.

Purified opium, 1 to 2 grains.

Linseed meal, 10 grains.

Mix the meal with boiling water into a thick paste, then add the oil and spices, and give as a bolus.

## Ordinary castor oil mixture :

15.—Castor oil, 3 ounces.

Syrup of buckthorn, 2 ounces.

Syrup of poppies, 1 ounce.

Mix, and give a tablespoonful to a medium-sized dog.

## Very strong purgative mixture :

16.—Jalap, 10 grains.

Epsom salts, 2 drachms.

Subcarbonate of soda, 10 grains.

Infusion of senna, 1 ounce.

Tincture of senna, 2 drachms.

Tincture of ginger, 15 drops.

Mix, and give as a drench. For a small dog, give one half, one third, or one quarter, according to size.

A purgative clyster :

17. — Castor oil,  $\frac{1}{2}$  ounce.  
 Spirit of turpentine, 2 to 3 drachms.  
 Common salt,  $\frac{1}{2}$  ounce.  
 Gruel, 6 to 8 ounces.

Mix all together, and inject carefully *per anum*.

### ASTRINGENTS

Produce contraction in all living tissues with which they are placed in apposition, either directly or by means of absorption into the circulation. Of these, opium, gallic acid, alum, bark, catechu, sulphate of zinc, nitrate of silver, and chloride of zinc are the most commonly used.

An astringent bolus for diabetes or internal hemorrhage :

18. — Gallic acid, 3 to 6 grains.  
 Alum, 4 to 7 grains.  
 Purified opium, 1 to 2 grains.

Mix with syrup, and give two or three times a day to a large dog.

or,

19. — Nitrate of silver,  $\frac{1}{2}$  grain.  
 Crumb of bread, enough to make a small pill.

To be given twice a day.

Astringent wash for the eyes :

20. — Sulphate of zinc, 5 to 8 grains.  
 Water, 2 ounces. — Mix.

or,

21. — Extract of goulard, 1 drachm.  
Water, 1 ounce. — Mix.

or,

22. — Nitrate of silver, 2 to 6 grains.  
Distilled water, 1 ounce. — Mix.

Wash for the penis :

23. — Chloride of zinc,  $\frac{1}{2}$  to 2 grains.  
Water, 1 ounce. — Mix.

Astringent application for piles :

24. — Gallic acid, 10 grains.  
Extract of goulard, 15 drops.  
Powdered opium, 15 grains.  
Lard, 1 ounce.

Mix, and apply night and morning.

---

## BLISTERS

Are not often used for the dog, because unless he has a proper muzzle on he will lick them off, and injure himself very materially. Sometimes, however, as in inflammation of the lungs, they are absolutely necessary. Iodine blisters to reduce local swellings may often be applied with a bandage over them, but even then, unless there is a muzzle on, the dog soon gets the bandage off, and uses his tongue. The chief are cantharides, turpentine, sulphuric acid, mustard, ammonia, tincture of iodine,

and biniodide of mercury; the last two having some peculiar effect in producing absorption of any diseased substance lying beneath. In all cases the hair ought to be cut off as closely as possible.

A mild blister :

25. — Powdered cantharides, 5 or 6 drachms.  
 Venice turpentine, 1 ounce.  
 Lard, 4 ounces. — Mix, and rub in.

Strong blister :

26. — Strong mercurial ointment, 4 ounces.  
 Oil of origanum,  $\frac{1}{2}$  ounce.  
 Finely powdered euphorbium, 3 drachms.  
 Powdered cantharides,  $\frac{1}{2}$  ounce. — Mix.

Very quick blister :

27. — Flour of mustard, 4 ounces.  
 Spirit of turpentine, 1 ounce.  
 Strong liquor of ammonia,  $\frac{1}{2}$  ounce.

Mix the mustard with water into a paste, then add the other ingredients and rub in.

For bony growths or other tumours :

28. — Tincture of Iodine.

Painted on every day, by means of a common painter's brush.

OR,

29. — Biniodide of mercury, 1 to  $1\frac{1}{2}$  drachms.  
 Lard, 1 ounce.

Mix, and rub in a piece the size of a nutmeg every day, keeping the part wet with tincture of arnica,  $\frac{1}{2}$  ounce, mixed with half a pint of water.

---

## CAUSTICS.

This name is given to substances which either *actually* or *potentially* destroy the living tissue; the actual cautery is an iron heated in the fire, the potential of some chemical substance, such as corrosive sublimate, lunar caustic, caustic potash, a mineral acid, or the like. The actual cautery, or firing, is not often used for the dog, but in some cases it is of great service. Both kinds are used for two purposes: one to relieve the effects of strains, and other injuries of the limbs, by which the ligaments are inflamed; and the other to remove diseased growth, such as warts, fungus, &c.

30. — Firing, when adopted for the dog, should be carried out with a very small thin-edged iron, as the dog's skin is thin, and very liable to slough. No one should attempt this without experience or previously watching others.
  31. — Lunar caustic, or nitrate of silver, is constantly required, being very manageable in the hands of any person accustomed to wounds, &c.
  32. — Sulphate of copper, or bluestone, is much milder than the lunar caustic, and may be freely rubbed into the surface of fungus or proud flesh. It is very useful in ulcerations about the toes.
  33. — Fused potass is not fit for any one but the experienced surgeon.
  34. — Corrosive sublimate in powder may be applied, carefully and in very small quantities, to warts, and then washed off. It is apt to extend its effects to the surrounding tissues.
  35. — Yellow orpiment is not so strong as corrosive sublimate, and may be used in the same way.
  36. — Burnt alum and white sugar, in powder, act as mild caustics.
-

## CHARGES.

Charges are plasters which act chiefly by mechanical pressure, being spread on while hot, and then covered with tow. They are not much used among dogs, but in strains they are sometimes useful, as they allow the limb to be used without injury. The best for the dog is composed as follows :

37.—Canada balsam, 2 ounces.

Powdered arnica leaves,  $\frac{1}{2}$  ounce.

Melt the balsam, and mix up with the powder, with the addition of a little turpentine, if necessary. Then smear over the part, and cover with tow, which is to be well matted in with the hand; or use thin leather.

## CORDIALS.

Warm stimulating stomachics are so called. They may be given either as a ball or a drench.

Cordial ball :

38.—Powdered caraway seeds, 10 to 15 grains.

Ginger, 3 to 5 grains.

Oil of cloves, 2 drops.

Linseed meal, enough to make a ball, first mixing it with boiling water.

Cordial drench :

39.—Tincture of cardamoms,  $\frac{1}{2}$  to 1 drachm.

Sal volatile, 15 to 30 drops.

Tincture of casearilla,  $\frac{1}{2}$  to 1 drachm.

Camphor mixture, 1 oz.—Mix.



## DIURETICS.

Medicines which act on the secretion of urine are called *diuretics*. They are either employed when the kidneys are sluggish, to restore the proper quantity; or to increase it beyond the natural standard, when it is desired to lower the system.

Diuretic bolus :

40.—Nitre, 5 to 8 grains.  
Digitalis,  $\frac{1}{2}$  grain.  
Ginger, 2 or 3 grains.

Mix with linseed meal and water, and give all or part, according to the size of the dog.

Diuretic and alterative bolus :

41.—Iodide of potassium, 2 to 4 grains.  
Nitre, 3 to 6 grains.  
Digitalis,  $\frac{1}{2}$  grain.  
Extract of camomile, 5 grains.

Mix, and give all or part.

---

 EMBROCATIONS.

These external applications, otherwise called *liniments*, are extremely useful in the dog, for strains, or sometimes to relieve muscular inflammation, or chronic rheumatism of the joints. Mustard, ammonia, laudanum, and turpentine, are the chief agents employed.

## Mustard embrocation :

- 42.—Best mustard, 3 to 5 ounces.  
 Liquor of ammonia, 1 ounce.  
 Spirit of turpentine, 1 ounce.

Mix into a thin paste, and rub into the part affected.

## Embrocation for strains or rheumatism :

- 43.—Spirit of turpentine,  
 Liquor of ammonia,  
 Laudanum, of each  $\frac{1}{2}$  ounce.

Mix, and shake well before using, then rub in.

---

 EMETICS.

Emetics are very commonly used in the diseases of the dog, and sometimes act very beneficially; but they have a tendency to weaken the stomach, and should therefore be used with caution. If not frequently resorted to no harm is likely to accrue, as vomiting is almost a natural process in the dog.

## Common salt emetic :

- 44.—Dissolve a teaspoonful of salt and half a teaspoonful of mustard in half a pint of tepid water, and give it as a drench.

## Strong emetic :

- 45.—Tartar emetic, 1 to 3 grains.  
 Dissolve in a tablespoonful of warm water, and give as a drench; following it up in a quarter of an hour, by pouring down as much thin gruel as the dog can be made to swallow.

## EXPECTORANTS, OR COUGH MEDICINES.

The action of these remedies is to promote the flow of mucus, so as to relieve the congestion of the air passages.

Common cough bolus :

- 46.—Ipecacuanha in powder,  $\frac{1}{2}$  to  $1\frac{1}{2}$  grain.  
 Powdered rhubarb, 1 to 2 grains.  
 Purified opium,  $\frac{1}{2}$  to  $1\frac{1}{2}$  grain.  
 Compound squill pill, 1 to 2 grains.

Mix, and give night and morning.

Expectorant draught, useful in recent cough :

- 47.—Ipecacuanha wine, 5 to 10 drops.  
 Common mucilage, 2 drachms.  
 Sweet spirit of nitre, 20 to 30 drops.  
 Paregoric, 1 drachm.  
 Camphor mixture,  $\frac{1}{2}$  ounce.

Mix, and give two or three times a day.

Expectorant draught for chronic cough :

- 48.—Friar's balsam, 8 to 12 drops.  
 Syrup of poppies, 1 drachm.  
 Diluted sulphuric acid, 3 to 8 drops.  
 Mucilage, 2 drachms.  
 Paregoric, 1 drachm.  
 Camphor mixture,  $\frac{1}{2}$  ounce.

Mix, and give twice a day.

---

## FEVER MEDICINES.

These medicines reduce fever by increasing the secretions of urine and perspiration, and by reducing the action of the heart to some extent.

## Common fever powder :

49.—Nitre in powder, 3 to 5 grains.

Tartar emetic,  $\frac{1}{4}$  grain.

Mix, and put *dry* on the dog's tongue every night and morning.

## More active powder :

50.—Calomel,  $\frac{1}{2}$  to  $1\frac{1}{2}$  grain.

Nitre, 3 to 5 grains.

Digitalis,  $\frac{1}{2}$  to 1 grain.

Mix, and give once or twice a day, in the same way ; or made into a pill with confection.

## Fever mixture :

51.—Nitre, 1 drachm.

Sweet spirit of nitre, 3 drachms.

Mindererus' spirit, 1 ounce.

Camphor mixture,  $6\frac{1}{2}$  ounces.

Mix, and give two tablespoonfuls every six hours.

## CLYSTERS

Are extremely useful in the dog, who is very liable to constipation from want of exercise, and in that case is *mechanically* bound. A pint of warm water, in which some yellow soap has been dissolved, will generally have the desired effect.

Turpentine clyster in colic :

52.—Spirit of turpentine,  $\frac{1}{2}$  ounce.

Castor oil, 1 ounce.

Laudanum, 2 to 3 drachms.

Gruel, 1 pint.

Mix, and throw up, using only half or one third for a small dog.

---

LOTIONS,

Otherwise called Washes, are intended either to reduce the temperature in inflammation of the surface to which they are applied, or to brace the vessels of the part.

Cooling lotion for bruises :

53.—Extract of lead, 1 drachm.

Tincture of arnica,  $\frac{1}{2}$  to 1 drachm.

Water,  $\frac{1}{2}$  pint.

Mix, and apply by means of a bandage or sponge.

For severe stiffness from over-exercise :

54.—Tincture of arnica,  $\frac{1}{2}$  drachm.

Strong spirit of wine, whisky, or brandy,  $7\frac{1}{2}$  drachms.

Mix, and rub well into the back and limbs, before the fire.

Lotion for the eyes :

55.—Sulphate of zinc, 20 to 25 grains.

Water,  $\frac{1}{2}$  pint.

Mix, and wash the eyes night and morning.

Strong drops for the eyes :

56.—Nitrate of silver, 3 to 8 grains.

Distilled water, 1 ounce.

Mix, and drop in with a quill.

OINTMENTS.

By means of lard, wax, &c., various substances are mixed up so as to be applied to wounds, chiefly to keep out the air.

A good ointment for old sores :

57.—Yellow basilicon,

Ointment of nitric-oxide of mercury, equal parts.

Digestive ointment :

58.—Red precipitate, 2 ounces.

Venice turpentine, 3 ounces.

Beeswax,  $1\frac{1}{2}$  ounce.

Lard, 4 ounces.—Mix.

Mange ointment :

58a.—Green iodide of mercury, 1 drachm.

Lard, 8 drachms.

Mix, and rub in carefully every 2nd or 3rd day.

STIMULANTS—*see* CORDIALS.

---

 STOMACHICS.

The name describes the use of the remedies, which are intended to give tone to the stomach.

## Stomachic bolus :

- 59.—Extract of gentian, 6 to 8 grains.  
 Powdered rhubarb, 2 to 3 grains.

Mix, and give twice a day.

## Stomachic draught :

- 60.—Tincture of cardamoms,  $\frac{1}{2}$  to 1 drachm.  
 Compound infusion of gentian, 1 ounce.  
 Carbonate of soda, 3 grains.  
 Powdered ginger, 2 grains.

Mix, and give twice a day.

---

## STYPTICS

Are remedies applied to stop bleeding. In the dog the vessels seldom give way externally, but internally the disease is frequent enough, either in the shape of a bloody flux, or bloody urine, or bleeding from the lungs, for which the following may be tried :

- 61.—Supracetate of lead, 2 to 3 grains.  
 Tincture of matico, 30 to 50 drops.  
 Vinegar, 10 drops.  
 Water, 1 ounce.

Mix, and give two or three times a day.

---

TONICS.

Tonics permanently increase the tone or vigour of the system, being particularly useful in the recovery from low fever.

Tonic pill :

- 62.—Sulphate of quinine, 1 to 3 grains.  
 Extract of hemlock, 2 grains.  
 Ginger, 2 grains.

Mix, and give twice a day.

Tonic mixture :

- 63.—Compound tincture of bark, 2 ounces.  
 Decoction of yellow bark, 14 ounces.

Mix, and give three tablespoonfuls twice or thrice daily to a large dog.

---

WORM MEDICINES.

By this term we are to understand such substances as will expel worms from the intestines of the dog, their action being



either poisonous to the worm itself, or so irritating as to cause them to evacuate their position. All ought either to be in themselves purgative, or to be followed by a medicine of that class, in order to insure the removal of the eggs, as well as the worms themselves. The more detailed directions will be found in the chapter on Worms.

#### Aperient-worm bolus.

64.—Calomel, 2 to 5 grains.

Jalap, 10 to 20 grains.

Mix into a bolus, with treacle.

For general worms. Not aperient, and therefore to be followed by castor oil :

65.—Recently powdered arca nut, 1 to 2 drachms.

Mix up with broth, and give to the dog directly, as there is no taste in it till it has been soaked some time, when the broth becomes bitter. If the dog refuses it he must be drenched. Four hours after, give a dose of castor oil. N. B.—The exact dose is 2 grains for each pound the dog weighs.

#### For round-worms, or maw-worms :

66.—Indian pink,  $\frac{1}{2}$  ounce.

Boiling water, 8 ounces.

Let it stand for an hour, then strain, and give half to a large dog, a quarter to a middle-sized dog, or an eighth to a very small one. This, however, is a severe remedy, and is not unattended with danger. It should be followed by castor oil in six hours.

#### Mild remedy, unattended with any danger :

67.—Powdered glass, as much as will lie on a shilling, heaped up.

To be mixed with butter, and given as a bolus, following it up with castor oil after six hours.

For tape-worm :

- 68.—Kousso,  $\frac{1}{4}$  to  $\frac{1}{2}$  ounce.  
 Lemon juice, 1 tablespoonful.  
 Boiling water,  $\frac{1}{4}$  pint.

Pour the water on the kousso, and when nearly cold add the lemon juice. Stir all up together, and give as a drench. It should be followed up in six or eight hours by a dose of oil.

Another remedy for tape-worm :

- 69.—Spirit of turpentine, 1 to 4 drachms.

Tie this up firmly in a piece of bladder, then give as a bolus, taking care not to burst the bladder. This also requires a dose of oil to follow. Or mix the turpentine with suet into a bolus.

Another :

- 70.—Fresh root of male fern, 1 to 4 drachms.  
 Powdered jalap, 15 grains.  
 Liquorice powder and water, enough to make a bolus.

N. B.—The oil of male fern is better than the dry root, the dose being ten to thirty drops.

## ADMINISTRATION OF REMEDIES.

Some considerable tact and knowledge of the animal are required, in order to give medicines to the dog to the best advantage. In the first place, his stomach is peculiarly irritable, and so much under the control of the will, that most dogs can vomit whenever they like. Hence it is not only necessary to give the medicine, but also to insure its being kept down.

For this purpose, however, it is generally only necessary to keep up the dog's head, as he will not readily vomit without bringing his nose to the ground, and so it is the regular practice in large kennels, in giving a dose of physic, to put the couples on, and fasten them up to a hook, at such a height that the dog cannot lower his head, maintaining this position for two or three hours. A single dog may be watched, if such is preferred, but a lot of hounds in physic must be treated with less ceremony.

---

#### THE DOG'S SYSTEM RESEMBLES THAT OF MAN.

The effects of remedies on the dog are nearly the same as on man, so that any one who understands how to manage himself may readily extend his sphere of usefulness to the dog. On the other hand, horses require a very different treatment, which accounts for the ignorance of the diseases of the dog so often displayed by otherwise clever veterinary surgeons, who have confined their attention to the more valuable animal. Some remedies affect the dog differently, however; thus laudanum, which is a very dangerous drug in human medicine, rarely does harm to the canine species, and treble the dose which is enough for a man will be required for the dog. On the other hand, calomel is quite the reverse, being extremely liable to produce great irritation on the lining membrane of the dog's stomach and bowels.

## MODE OF GIVING A BOLUS OR PILL.

If the dog is small, take him on the lap, without harshness, and if inclined to use his claws tie a coarse towel round his neck, letting it fall down in front, which will muffle them effectually ; then with the finger and thumb of the left hand press open the mouth by insinuating them between the teeth, far enough back to take in the cheeks, and so to compel the mouth to open from the pain given by the pressure against the teeth, while it also prevents the dog from biting the fingers. Then raising the nose, drop the pill as far back as possible, and push it well down the throat with the forefinger of the right hand. Let go with the left, still hold the nose up, keeping the mouth shut, and the pill is sure to go down. A large dog requires two persons to give a pill, if he is at all inclined to resist. First, back him into a corner, then stride over him, and putting a thick cloth into his mouth, bring it together over the nose, where it is held by the left hand ; the right can then generally lay hold of the lower jaw. But if the dog is very obstinate and inclined to resist, another cloth must also be placed over that, and then drawing them apart an assistant can push the pill down. Very often a piece of meat may be used to wrap the pill up in, and the dog will readily bolt it ; but sometimes it is desirable to avoid this, as it may be necessary to give the medicine by itself. Even large dogs, however, are seldom so troublesome as to require the above precautions in giving pills, though they almost always obstinately refuse liquid medicine when they have tasted it once or twice.

## MODE OF DRENCHING THE DOG.

If a small quantity only is to be given, the dog's head being held, the liquid may be poured through the closed teeth, by making a little pouch of the cheek; but this is a tedious process, as the animal often refuses to swallow it for a long time, and then struggles till half is wasted. A spoon answers for small quantities, but for larger a soda-water bottle is the best instrument. Then, having the dog held on either of the plans recommended in the last paragraph, pour a little down, and shut the mouth, which is necessary, because the act of swallowing cannot be performed with it open. Repeat this till all is swallowed. Then watch the dog, or tie his head up, till it is clear that the medicine will be retained on the stomach.

---

## CLYSTERS, OR INJECTIONS.

When the bowels are very much confined, a pint or two of warm gruel will often be of great service, if thrown up into the rectum. The dog should be placed on his side, and held in this position on a table by an assistant, while the operator passes the pipe carefully up into the rectum, and then pumps the fluid up.

---

## THE APPLICATION OF THE MUZZLE.

When any operation is to be performed which is likely to make the dog use his teeth, he must be muzzled, either with an instrument made on purpose, or with a piece of tape, which is to be first wound round the nose of the dog, as close to the eyes as possible without touching them, then tied in a knot between them, and both ends brought back over the forehead to the collar, where they are to be made fast. When a muzzle is required to be worn by a savage dog, either in-doors or out, it must be so made as to allow of his readily putting his tongue out. For this purpose either a cone of leather pierced with holes, or of wire, is strapped on by a neck-strap and two or three short side-straps.

## CHAPTER III.

### FEVERS, AND THEIR TREATMENT.

Simple Ephemeral Fever, or Cold. — Epidemic Fever, or Influenza. — Typhus Fever, or Distemper. — Rheumatic Fever. — Small-Pox. — Sympathetic Fever.

THE dog is peculiarly liable to febrile attacks, which have always a tendency to put on a low form, very similar in its nature to that known as typhus in human medicine. This is so generally the case, that every dog is said to have the distemper at some time of his life, that name being given to this low form of fever. Hence, an attack may commence with a common cold, or any inflammatory affection of the lungs, bowels, &c.; but, this going on to assume the low form, it becomes a case of genuine typhus fever, or distemper. Nevertheless, it does not follow that the one must necessarily end in the other; and so the dog may have simple fever, known as “a cold,” or various other complaints, without being subjected to the true distemper. The fevers occurring in the dog are: 1st, Simple ephemeral fever, commonly called “a cold;” 2nd, Simple epidemic fever, or influenza; 3rd, Typhus fever, known as Distemper; 4th, Rheumatic fever, attacking the muscular and fibrous systems; and, 5thly, Small-pox.

## SIMPLE EPHEMERAL FEVER.

*Symptoms.*—This slight disease, known as “a common cold,” is ushered in by chilliness, with increased heat of surface, a quick pulse, and slightly hurried breathing. The appetite is not as good as usual, eyes look dull, bowels costive, urine scanty and high-coloured. There are often cough and slight running at the nose and eyes, and sometimes the other internal organs are attacked; or the disease goes on till a different form of fever is established, known as typhus, and this is particularly the case when many dogs are collected together, or when one or two are kept in a close kennel, and are neither properly ventilated nor cleaned.

*Cause.*—Exposure to wet or cold.

*Treatment.*—Complete rest. A gentle dose of opening medicine: (12) or (13) if the liver is torpid, (15) if acting. After this has acted, give slops, and if there is still much fever, one of the remedies (45) or (51). If there is much cough, give the draught (47) or the bolus (46).

---

  
INFLUENZA.

*The symptoms* of influenza at first closely resemble those of the last-described attack, but as they depend upon some peculiar



condition of the air which prevails at the time, and as they are more persistent, the name influenza is given. After the first few days, the running at the eyes and nose increases, and a cough is almost always present, which symptoms often persist for two or three weeks, leaving great prostration of strength at the end of that time, and often a chronic cough, which requires careful treatment.

*The cause* is to be looked for in some peculiar state of the air, of the nature of which nothing is known at present.

*Treatment.*—In the early stage, the remedies should be the same as for ordinary or simple “cold.” Towards the second week, a cough-bolus (46) or draught (47) will generally be required. When the strength is much reduced after the second week, and the cough is nearly gone, give a tonic pill (62) or mixture (63). Great care should be taken not to bring on a relapse by improper food, or by too early an allowance of exercise. Fresh air is of the utmost importance, but it must be taken at a slow pace, as a gallop will often undo all that has been effected in the way of a cure.

---

#### TYPHUS FEVER, OR DISTEMPER.

Having in previously published works proved the similarity of this disease to the typhus fever of man, and the identity of the

two methods of treatment, I shall take this for granted, more especially as it is now generally admitted.

*The essence of the disease* is some poison admitted from without, or developed within the blood, by which the various secretions are either totally checked, or so altered as no longer to purify the system. The exact nature of this poison is beyond our present state of knowledge, but from analogy there is little doubt that it resides in the blood. As in all cases of poison absorbed into the system, there is a most rapidly depressing effect upon the muscular powers, which is to be expected, inasmuch as their action requires a constant formation of new material from the blood; and as this is retarded in common with all other functions, the muscles waste away rapidly, and their contractions are not performed with any strength. The disease is sometimes contracted by infection, and at others developed within the body; just as in the case of fermentation in vegetable substances, there may be a ferment added to a saccharine solution, by which the process is hastened, although if left to itself it will come on in due course.

The *symptoms* are very various, but they may be divided into two sets, one of which comprises a set always attending upon distemper; while the other may or may not be present in any individual attack. The *invariable* symptoms are: a low insidious fever, with prostration of strength to a remarkable degree, in proportion to the duration and strength of the attack, and rapid emaciation, so that a thick muscular dog is often made quite thin and lanky in three days. As a part of the fever, there is

shivering, attended by quick pulse, hurried respiration, loss of appetite, and impaired secretions: but, beyond these three, are no signs which can be called positively invariable; though the running at the eyes and nose, and the short husky cough, especially after exercise, are very nearly always present. The *accidental* symptoms depend upon the particular complication which may exist; for one of the most remarkable features in distemper is, that, coupled with the above invariable symptoms, there may be congestion, or inflammation of the head, chest, bowels, or skin. So that in one case the disease may appear to be entirely confined to the head, in another to the chest, and in a third to the bowels; yet all are strictly from the same cause, and require the same general plan of treatment, modified according to the seat of the complication.

*The ordinary course of an attack* of distemper is as follows: that is, when contracted by contagion, or clearly epidemic. (On the other hand, when it is developed in consequence of neglect, it comes on at the end of some other attack of disease, which may have existed for an indefinite time.) Almost always the first thing noticed is a general dulness or lassitude, together with loss of appetite. In a day or two there is generally a peculiar husky cough, which sounds as if the dog were trying to get a piece of straw out of his throat, and always comes on at exercise after a gallop. With this there is also a tendency to sneeze, but not so marked as the "husk" or "tissuck" which *may* occur in common "cold" or influenza, but is then usu-

ally more severe, and also more variable in its severity; soon going on to inflammation, or else entirely ceasing in a few days. In distemper, the strength and flesh rapidly fail and waste, while in common "cold," the cough may continue for days without much alteration in either; and this is one of the chief characteristics of the true disease. There is, also, generally a black pitchy condition of the *feces*, and the urine is scanty and high-coloured. The white of the eyes is always more or less reddened, the colour being of a bluish red cast, and the vessels being evidently gorged with blood. When the brain is attacked, the eyes are more injected than when the bowels or lungs are the seats of complication. The corners of the eyes have a small drop of mucus, and the nose runs more or less, which symptoms, as the disease goes on, are much aggravated, both being glued up by brownish matter, while the teeth also are covered with a blackish brown fur. Such are the regular symptoms of a severe attack of distemper, gradually increasing in severity to the third, fourth, or fifth week, when the dog dies from exhaustion, or from disease of the brain, lungs, or bowels, marked by peculiar signs in each case. In this course the disease may be described as passing through four *stages* or *periods*: 1st, That in which the poison is spreading through the system, called *the period of incubation*; 2nd, That in which nature rouses her powers to expel it, called *the period of reaction*; 3rd, *The period of prostration*, during which the powers of nature are exhausted, or nearly so, by the efforts which have been made; and

4th, *The period of convalescence.* On the average, each of these will occupy a week or ten days, varying with the mildness or severity of the attack.

*When the head is attacked,* there may or may not be a running from the nose and eyes; but more usually there is some evidence of congestion in these organs, the eyes being weak and glued up with the mucus, and the nose running more or less. A fit is, however, the clearest evidence of brain affection, and, to a common observer, the only reliable one. Sometimes there is stupor without a fit, gradually increasing till the dog becomes insensible, and dies. At others, a raving delirium comes on, easily mistaken for hydrophobia, but distinguished from it by the presence of the premonitory symptoms peculiar to distemper. This is the most fatal complication of all, and, if the dog recovers, he is often a victim to palsy or chorea for the rest of his life.

*If the lungs are attacked,* there is very rapid breathing, with cough, and almost always a considerable running from the eyes and nose, and expectoration of thick frothy mucus. If inflammation of the lungs is established, the danger is as great as when the head is the seat of the seizure.

*The bowels* may be known to be seized when there is a violent purging of black offensive matter, often tinged with blood, and sometimes mixed with patches or shreds of a white leathery substance, which is coagulable lymph. The discharge of blood is in some cases excessive, and rapidly carries off the dog.

*If the skin is attacked,* which is a favourable sign, there is a breaking out of pustules on the inside of the thighs and

belly, which fill with matter often tinged with dark blood, and sometimes with blood itself of a dark purple colour.

*To distinguish* distemper from similar affections is not always easy to an inexperienced observer, but the practised eye at once detects the difference. The chief diseases which are likely to be confounded with it are, the true canine madness, common "cold," or influenza, inflammation of the lungs, and diarrhœa. The first of these runs a more rapid course, and is ushered in by peculiar changes in the temper, which will be described under the head of HYDROPHOBIA. "Cold" and influenza cause no great prostration of strength; and the former comes on after exposure to the weather, while the latter is sure to be prevalent at the time. Inflammation of the lungs must be studied to be known, and simple diarrhœa has no fever attending upon it.

The *treatment of distemper* is twofold: firstly, being directed to the safe conduct through the lowering effects of the complaint; and secondly, to ward off the fatal results which are likely to be occasioned by the local complications in the brain, lungs, or bowels. It must be remembered that the disease is an effort of nature to get rid of a poison; and, therefore, the powers of the system must be aided throughout, or they will be incompetent to their task. One great means of carrying off this poison is to be looked for in the bowels and kidneys; and, as far as possible, these organs must be restored to their natural state, taking care that, in trying to effect these desirable objects, they are not injured by the remedies used. Thus it is

well known that aperients, and especially calomel, have the property of restoring the suspended action of the liver; but they also have an injurious effect upon the strength of the general system, and therefore must be used with great caution; the best formulæ being (13) or (15) given only once or twice, at intervals of two or three days. After the secretions are restored, the next thing to be done is to look out for the complications in the brain, lungs, and bowels, which are to be expected; and, if present, to counteract them by appropriate remedies. Thus a seton put into the back of the neck, covering the tape with blister ointment, will be likely to relieve the *head*, together with cold applications of vinegar and water by means of a sponge. At the same time the fever mixture (51) may be regularly administered. For any trifling complication in the *lungs* the fever powder (49) will generally suffice; but, if severe, blood must be taken from the neck vein; though this, if possible, should be avoided, and the cough bolus or draught (46) or (47) administered. *Dairrhœa* must be at once checked by one of the mixtures (6) or (8); or, if very severe, by the pill (19). At the same time, rice-water should be given as the only drink; and beef-tea, thickened with arrow-root or rice, as the sole article of diet, changing it occasionally for port wine and arrow-root. When the stage of exhaustion has commenced, the tonic mixture (63) will almost always be required; and it is astonishing what may be done by a perseverance in its use. Dogs which appear to be dying will often recover; and no case should be given up as long as there is any life remaining.

The *diet* should be carefully attended to, little or no food being required on the first four or six days, beyond weak broth or gruel, no solid food from the first being permitted, and this restriction being maintained till the dog is quite recovered. When the state of exhaustion or prostration comes on, good strong beef-tea should be given every three or four hours, and, if the dog will not swallow it, force should be used; a spoonful at a time being given in the way ordered for drenching at page 364. At this time also port wine is often of service, thickened with arrow-root, and given alternately with the beef-tea. For a dog of average size the plan is to give a teacupful of beef-tea, then, after two hours, the same quantity of arrow-root and wine; then, again after two hours, a dose of the tonic mixture, and so on through the twenty-four hours. Perseverance in this troublesome plan will generally be rewarded with success; but, of course, it is only a valuable dog which will reward it properly. In less important animals the beef-tea may be provided, and if it is not voluntarily swallowed the poor patient often dies for want of the compulsion, so that humanity as well as self-interest counsels the adoption of what often appears a harsh proceeding.

*No exercise*, even of the most gentle kind, should be allowed, it being found invariably to bring on a return of the disease, whenever it is indulged in. Many a young dog has been sacrificed to the mistaken kindness of his master, who has thought that a "breath of fresh air" would do him good; and so it would if taken in an easy carriage, at rest; but the muscular exertion necessary to procure it is highly injurious, and should



be delayed until the strength is restored. This is one reason why dogs in the country bear distemper so much better than in towns; for, as it is known that they are in the fresh air, no attempt is made to take them to it, and so they are left alone, and are not induced to exert their strength prematurely. Even when the dog appears nearly well it is better to lead him out to exercise for the first day or two, for otherwise he is almost sure to over-exert himself, and a gallop will often do more harm than can be rectified in many days afterwards.

*Ventilation* should not be neglected, but moderate warmth is essential to a cure, and a delicate dog like the greyhound should have a cloth on him in cold weather. The greatest cleanliness should be observed, but this should be done as far as possible without making the kennel damp with water. Clean straw must be liberally provided, and all offensive matters removed as often as they are voided.

*Summary of treatment.*—In the early stage get the bowels into good order by mild doses of aperient medicine: (11), (13), or (15). Attend to any complication which may come on, using a seton for the head, or the appropriate remedies for the chest, or mixture for the bowels (6) if there is diarrhœa. For the exhaustion, when the violent symptoms are abated, give the tonic (63); and during the whole period attend to the diet, ventilation, cleanliness, and rest, as previously described.

*Vaccination* has been recommended as a remedy for distemper, and has been largely tried both in foxhound and greyhound kennels, as well as among pointers and setters. The

result has been that some people fancy it to be a sure preventive, and there is evidence that for years after it has been adopted in certain kennels distemper, which was previously rife in them, has been kept at bay. On the other hand, a still more numerous party have found no change produced in the mortality among their dogs, and they have come as a natural consequence to the opposite conclusion. Reasoning from analogy, there is no ground for supposing that the matter of small-pox or cow-pox should prevent the access of a disease totally dissimilar to these complaints; but, as experience is here the best guide, the appeal must be made to it in order to settle the question. Judging from this test, I can see no reason whatever for the faith which is placed in vaccination, because there are at least as many recorded failures as successes; and as we know that after any remedy there will always be a certain number of assumed cures held out by sanguine individuals, so we must allow for a great many in this particular case. Distemper is well known to be most irregular in its attacks, and to hit or miss particular kennels, as the case may be, for years together; after which it reverses its tactics; and as vaccination is used at any of these various periods of change, so it gains credit or discredit which it does not deserve. My own belief is, after trying it myself and seeing it tried, and after also comparing the experience of others, that vaccination is wholly inoperative; but, as others may like to test it for themselves, I here append directions for the operation.

*To vaccinate the dog.*—Select the thin skin on the inside of the ear, then with a lancet charged with vaccine lymph (which should

be as fresh as possible) make three or four oblique punctures in the skin, to such a depth as barely to draw blood, charging the lancet afresh each time. If the lymph cannot be procured fresh, the punctures must be made as above described, and then the points charged with dry lymph must be introduced one in each puncture and well rubbed into the cut surface so as to insure the removal of the lymph from the points. In four or five days an imperfect vesicle is formed, which, if not rubbed, goes on to maturity and scabs at the end of ten days or thereabout. There are various other methods suggested, such as introducing a piece of thread dipped in the virus, &c., but the above is the proper plan, if any is likely to be effectual.

The *treatment* of the various sequels of distemper, including fits, palsy, &c., will be given under those heads respectively.

---

#### RHEUMATIC FEVER.

One of the most common diseases in the dog is rheumatism in some form, generally showing itself with very little fever, but sometimes being accompanied with a high degree of that attendant evil. The frequency of this disease is owing to the constant exposure of the dog to cold and wet, and very often to his kennel being damp, which is the fertile source of kennel lameness, or chest-founder, which is nothing more than rheumatism of the

muscles of the shoulders. Again, those which spend half their time before a roasting fire, and the other half in the wet and cold, are extremely apt to contract this kind of fever, but not in so intractable a form as the denizen of the damp kennel. By some writers this affection is classed among the inflammations; and it is a debatable point to which of these divisions it should be assigned; but this is of little consequence, so that it is properly known and easily recognised by the symptoms. I shall therefore include here rheumatic fever, which is a general affection, and also the partial attacks known as kennel lameness or chest-founder, and rheumatism of the loins, commonly called palsy of the back.

*Rheumatic fever is known* by the following signs:—There is considerable evidence of fever, but not of a very high character, the pulse being full but not very quick, with shivering and dulness, except when touched or threatened, the slightest approach causing a shriek, evidently from the fear of pain. The dog almost always retires into a corner, and is very reluctant to come out of it. On being forcibly brought out he snarls at the hand even of his best friend, and stands with his back up, evidently prepared to defend himself from the pat of the hand, which to him is anguish. The bowels are confined, and the urine high-coloured and scanty.

The *treatment* consists in bleeding from the neck, to a moderate extent, if the dog is very gross and full of condition, then giving a smart dose of opening physic: (12) or (13). After this has acted give the following pills:—

Calomel,  
Purified opium, of each 1 grain.  
Powdered root of colehicium, 2 to 3 grains.  
Syrup, enough to make a pill.

This is the dose for an average-sized dog. A hot bath will often be of service, taking care to dry the skin afterwards before the fire. Then follow up with a liberal friction by the aid of the liniment (43).

*Kennel lameness*, or *chest-founder*, shows itself in a stiffness or soreness of the shoulders, so that the dog is unable to gallop freely down hill, and is often reluctant to jump off his bench to the ground, the shock giving pain to the muscles suspending the body to the shoulder-blades, which are affected with rheumatism. It is peculiarly prominent in the kennels of foxhounds, for these dogs, being exposed to wet and cold for hours together and then being sometimes brought home to a damp lodging-room, contract the disease with great frequency. Pampered house pets are also very liable to chest-founder, over-feeding being quite as likely to produce rheumatism as exposure to cold, and when both are united this state is almost sure to be established. When it becomes chronic there is little or no fever attendant on it, nor is there much in the recent state. After it has existed for some months it is generally considered to be incurable, but instances are known in which the stiffness has entirely disappeared. *Chest-founder* also arises from a sprain of the muscles suspending the chest between the shoulders.

The *remedies* for kennel lameness are nearly the same as for general rheumatism, taking care to remove the cause if it has

existed in the shape of a damp cold lodging-room. The food should be light, and composed chiefly of vegetable materials, strong animal food being inclined to increase the rheumatic affection. The liniment (43) is very likely to be of service, especially if used after the hot bath, as previously described. It has been asserted, by persons of experience, that a red herring given two or three times a week will cure this disease: I have no personal experience of the merits of this remedy, but, according to Col. Whyte, it has recently been discovered that there is an active principle in the herring that is a complete specific in human rheumatism, and therefore this apparently inert remedy may really be a very powerful one. At all events it is worth a trial. It is ordered to be given with two drachms of nitre and one of camphor, most dogs readily eating the herring and camphor, and the nitre being added in a little water as a drench. Cod-liver oil is also said to be of great service (5). Iodine with sarsaparilla (3) is a combination which I have known of more service than any internal medicines.

*A dragging of the hind limbs* is common enough in the dog, and, though often called palsy, it really is almost always of a rheumatic nature. It exactly resembles chest-founder in all its symptoms, excepting that the muscles affected are situated in the loins and hips, corresponding with human lumbago in all particulars, excepting that it is far more permanent. The *causes* and *treatment* are the same as those of kennel lameness.

---

## SMALL-POX.

Never having seen a case of this disease in the dog, I must be content with extracting entire Mr. Youatt's description of it :—

“In 1809, there was observed, at the Royal Veterinary School at Lyons, an eruptive malady among the dogs, to which they gave the name of *small-pox*. It appeared to be propagated from dog to dog by contagion. It was not difficult of cure; and it quickly disappeared when no other remedies were employed than mild aperients and diaphoretics. A sheep was inoculated from one of these dogs. There was a slight eruption of pustules formed on the place of inoculation, but nowhere else; nor was there the least fever.

“At another time, also, at the school at Lyons, a sheep died of the regular sheep-pox. A part of the skin was fastened, during four and twenty hours, on a healthy sheep, and the other part of it on a dog, both of them being in apparent good health. No effect was produced on the dog, but the sheep died of confluent sheep-pox.

“The essential symptoms of small-pox in dogs succeed each other in the following order: the skin of the belly, the groin, and the inside of the fore arm becomes of a redder colour than in its natural state, and sprinkled with small red spots irregularly rounded. They are sometimes isolated, sometimes clustered together. The near approach of this eruption is announced by an increase of fever.

“On the second day, the spots are larger, and the integument is slightly tumefied at the centre of each.

“On the third day, the spots are generally enlarged, and the skin is still more prominent at the centre.

“On the fourth day, the summit of the tumour is yet more prominent. Towards the end of that day the redness of the centre begins to assume a somewhat grey colour. On the following days, the pustules take on their peculiar characteristic appearance, and cannot be confounded with any other eruption. On the summit is a white circular point, corresponding with a certain quantity of nearly transparent fluid which it contains, and covered by a thin and transparent pellicle. This fluid becomes less and less transparent, until it acquires the colour and consistence of pus. The pustule, during its serous state, is of a rounded form. It is flattened when the fluid acquires a purulent character, and even slightly depressed towards the close of the period of suppuration, and when that of desiccation is about to commence, which ordinarily happens towards the ninth or tenth day of the eruption. The desiccation and the desquamation occupy an exceedingly variable length of time ; and so, indeed, do all the different periods of the disease. What is the least inconstant, is the duration of the serous eruption, which is about four days, if it has been distinctly produced and guarded from all friction. If the general character of the pustules is considered, it will be observed, that, while some of them are in a state of serous secretion, others will only have begun to appear.

“The eruption terminates when desiccation commences in the



first pustules; and, if some red spots show themselves at that period of the malady, they disappear without being followed by the development of pustules. They are a species of abortive pustules. After the desiccation, the skin remains covered by brown spots, which, by degrees, die away. There remains no trace of the disease, except a few superficial cicatrices on which the hair does not grow.

“The causes which produce the greatest variation in the periods of the eruption are, the age of the dog, and the temperature of the situation and of the season. The eruption runs through its different stages with much more rapidity in dogs from one to five months old than in those of greater age. I have never seen it in dogs more than eighteen months old. An elevated temperature singularly favours the eruption, and also renders it confluent and of a serous character. A cold atmosphere is unfavourable to the eruption, or even prevents it altogether. Death is almost constantly the result of the exposure of dogs having small-pox to any considerable degree of cold. A moderate temperature is most favourable to the recovery of the animal. A frequent renewal or change of air, the temperature remaining nearly the same, is highly favourable to the patient; consequently close boxes or kennels should be altogether avoided.

“I have often observed that the perspiration or breath of dogs labouring under variola emits a very unpleasant odour. This smell is particularly observed at the commencement of the desiccation of the pustules, and when the animals are lying upon dry straw; for the friction of the bed against the pustules destroys

their pellicles, and permits the purulent matter to escape; and the influence of this purulent matter is most pernicious. The fever is increased, and also the unpleasant smell from the mouth, and that of the fæces. In this state there is a disposition which is rapidly developed in the lungs to assume the character of pneumonia. This last complication is a most serious one, and almost always terminates fatally. It has a peculiar character. It shows itself suddenly, and with all its alarming symptoms. It is almost immediately accompanied by a purulent secretion from the bronchi, and the second day does not pass without the characters of pneumonia being completely developed. The respiration is accompanied by a mucous *râle* which often becomes sibilant. The nasal cavities are filled with a purulent fluid. The dog that coughs violently at the commencement of the disease employs himself, probably, on the following day in ejecting, by a forcible expulsion from the nostrils, the purulent secretion which is soon and plentifully developed. When he is lying quiet, and even when he seems to be asleep, there is a loud, stertorous, guttural breathing.”

---

SYMPATHETIC FEVER.

This term is applied to the fever which comes on either before or after some severe local affection, and being, as it were, eclipsed by it. Thus in all severe inflammations there is an accompanying

fever which generally shows itself before the exact nature of the attack is made manifest, and though it runs high, yet it has no tendency in itself to produce fatal results, subsiding, as a matter of course, with the inflammation which attends it. The same happens in severe injuries; but here also, if there is no inflammation, there is no fever; so that the same rule applies as where there is an external cause.

The *treatment* of this kind of fever is always merged in that which is necessary for the attendant inflammation, and this being removed the fever subsides; it therefore requires no special notice to be taken of it, or any remedy to be directed to it.

## CHAPTER IV.

## INFLAMMATIONS.

Definition of Inflammation.—Symptoms and Treatment of Rabies, Tetanus, and Turnside.—Of Inflammation of the Eye, Ear (canker), Mouth, and Nose.—Of the Lungs.—Of the Stomach.—Of the Bowels.—Of the Liver.—Of the Kidneys and Bladder.—Of the Skin.

## DEFINITION OF INFLAMMATION.

INFLAMMATION consists in a retardation of the flow of blood in the small vessels, which requires an increased action of the large ones to overcome it. When external and visible, it is characterised by increased heat, swelling, pain, and redness, and internally by the first three, the last not being discoverable, though existing. It may be *acute* when coming on rapidly, or *chronic* when slow, and without very active symptoms. In the acute form there is always an increased rapidity of the pulse, with a greater reaction on the heart's pulsations, known as hardness of the pulse. In the dog the healthy pulsations are from 90 to 100 in the minute, which may be taken as the standard of health; the arterial pulse may be felt on the inside of the arm above the knee; or, by

putting the hand against the lower part of the chest, the contractions of the heart may be readily felt. In different breeds, however, there is considerable variation in the pulsations of the heart.

---

#### HYDROPHOBIA, RABIES, OR MADNESS.

This disease has been classed among the inflammations, although it has not been proved to arise from that cause; but, as it is generally supposed to be connected with an inflammation or congestion of the spinal column and brain, there is every reason for placing it at the head of this division; and, as it is of the utmost importance to understand its symptoms, the sooner it is studied the better. At present there appears to be little or no control over this horrible complaint, so that it is solely with a view to recognise the attack and prevent its transmission by inoculation, that it is interesting to the owner of the dog.

The *symptoms* are chiefly as follows:—the first is a marked change of temper; the naturally cheerful dog becoming waspish and morose, and the bold fondling pet retreating from his master's hand as if it was that of a stranger. On the other hand, the shy dog sometimes becomes bold; but in almost every case there is a total change of manner for several days before the absolute outbreak of the attack, which is indicated by a kind of delirious watching of imaginary objects, the dog snapping at the wall, or if anything comes in his way, tearing it to pieces with savage

fury. With this there is constant watchfulness, and sometimes a peculiarly hollow howl, while at others no sound whatever is given, the case being then described as "dumb madness." Fever is always present, but it is difficult to ascertain its extent on account of the danger of approaching the patient, and with this (in contradiction to the name hydrophobia) there is invariably an urgent thirst, which the dog is in such a hurry to gratify that he generally upsets the vessel containing his water. Mr. Grantley Berkeley maintains very strongly that no dog really attacked with rabies will touch water, and that the presence of thirst is a clear sign of the absence of this disease; but this opinion is so entirely in opposition to the careful accounts given by all those who have witnessed the disease when it had unquestionably been communicated either to man or to some of the lower animals, that no reliance ought to be placed upon it, especially where so important a stake is involved. Mr. Youatt witnessed more cases of rabies than perhaps any equally good observer ever did, and he strongly insists upon the presence of thirst, as may be gathered from the concluding portion of the following extract:—

"Some very important conclusions may be drawn from the appearance and character of the urine. The dog, and at particular times when he is more than usually salacious, may, and does diligently search the urining places; he may even at those periods be seen to lick the spot which another has just wetted; but, if a peculiar eagerness accompanies this strange employment, if, in the parlour, which is rarely disgraced by this evacuation, every corner is perseveringly examined, and licked with unwearied and

unceasing industry, that dog cannot be too carefully watched, there is great danger about him; he may, without any other symptom, be pronounced to be decidedly rabid. I never knew a single mistake about this.

“Much has been said of the profuse discharge of saliva from the mouth of the rabid dog. It is an undoubted fact that, in this disease, all the glands concerned in the secretion of saliva become increased in bulk and vascularity. The sublingual glands wear an evident character of inflammation; but it never equals the increased discharge that accompanies epilepsy or nausea. The frothy spume at the corners of the mouth is not for a moment to be compared with that which is evident enough in both of these affections. It is a symptom of short duration, and seldom lasts longer than twelve hours. The stories that are told of the mad dog covered with froth are altogether fabulous. The dog recovering from, or attacked by, a fit may be seen in this state; but not the rabid dog. Fits are often mistaken for rabies, and hence the delusion.

“The increased secretion of saliva soon passes away. It lessens in quantity; it becomes thicker, viscid, adhesive, and glutinous. It clings to the corners of the mouth, and probably more annoyingly so to the membrane of the fauces. The human being is sadly distressed by it, he forces it out with the greatest violence, or utters the falsely supposed bark of a dog, in his attempts to force it from his mouth. This symptom occurs in the human being when the disease is fully established, or at a late period of it. The dog furiously attempts to detach it with his paws.

“It is an early symptom in the dog, and it can scarcely be mistaken in him. When he is fighting with his paws at the corners of his mouth, let no one suppose that a bone is sticking between the poor fellow’s teeth ; nor should any useless and dangerous effort be made to relieve him. If all this uneasiness arose from a bone in the mouth, the mouth would continue permanently open, instead of closing when the animal for a moment discontinues his efforts. If after a while he loses his balance and tumbles over, there can be no longer any mistake. It is the saliva becoming more and more glutinous, irritating the fauces and threatening suffocation.

“*To this naturally and rapidly succeeds an insatiable thirst.* The dog that still has full power over the muscles of his jaws continues to lap. He knows not when to cease, while the poor fellow labouring under the dumb madness, presently to be described, and whose jaw and tongue are paralysed, plunges his muzzle into the water-dish to his very eyes, in order that he may get one drop of water into the back part of his mouth to moisten and to cool his dry and parched fauces. Hence, instead of this disease being always characterised by the dread of water in the dog, it is marked by a thirst often perfectly unquenchable. Twenty years ago, this assertion would have been peremptorily denied. Even at the present day we occasionally meet with those who ought to know better, and who will not believe that the dog which fairly, or perhaps eagerly, drinks, can be rabid.”—*Youatt*, pp. 135-6.

From my own experience I can fully confirm the above account, having seen seven cases of genuine rabies, in all of which thirst



was present in a greater or less degree ; and in five of which the disease was communicated to other dogs.

If the rabid dog is not molested he will seldom attack any living object ; but the slightest obstruction in his path is sufficient to rouse his fury, and he then bites savagely, and in the most un-reasoning manner, so as to be wholly uncontrollable by fear of the consequences. The gait, when at liberty, is a long trot, without any deviation from the straight line, except what is compulsory from the nature of the surrounding objects.

*The average time of the occurrence of rabies* after the bite is, in the dog, from three weeks to six months, or possibly even longer ; so that a suspected case requires careful watching for at least that time ; but, after three months, the animal suspected to have been bitten may be considered tolerably safe.

*The duration* of the disease is about four or five days, but I have myself known a case fatal in forty-eight hours.

*As there has never yet been discovered a cure* for rabies, so the best plan in all cases is to destroy the dog as soon as he is clearly shown to exhibit the disease. In the interval he should be secluded in a safe place, where he cannot possibly get at any living animal.

---

## TETANUS.

Resembling rabies in some degree, tetanus differs from it in the absence of any affection of the brain, the senses remaining perfect to the last. It is not common with the dog; and, when it does manifest itself, is generally produced by a severe injury, and shows itself in the form known as "lock-jaw." Hence in France it is known as *mal de cerf*, from its supervening upon wounds from the horns of that animal. It consists in spasmodic rigidity of certain muscles, alternately with relaxation; but the stiffness continuing for some length of time, and not appearing and disappearing as quickly as in cramp. If the tetanic spasm affects the muscles of the jaw, the state is called "lock-jaw." When it seizes on all the muscles of the back, the body is drawn into a bow, the head being brought nearly close to the tail. Sometimes the contraction is of one side only, and at others of the muscles of the belly, producing a bow in the opposite direction to that alluded to above. These various conditions exactly resemble the contractions produced by the poison of strychnine; so that when they occur, as the disease is extremely rare, it is fair to suspect that poison has been used. Nevertheless, it should be known that they were witnessed long before this poison was in use; and, therefore, they may arise independently of it.

*The successful treatment of tetanus is a hopeless affair, if the case is clearly established. Purgatives and bleeding may be tried, followed by chloroform, which will always relieve the spasm for the*

time ; but, as it returns soon after the withdrawal of the remedy, no good is likely to accrue from its use. Excepting in the case of very valuable or highly valued dogs, I should never advise any remedies being tried, and the most humane course is at once to put the poor animal out of his misery, the spasms being evidently of a most painful nature.

---

#### URNSIDE

Is more frequently seen in the dog than tetanus ; but, nevertheless, is by no means common. It consists in some obscure affection of the brain, resembling the "gid" of sheep, and most probably produced from the same cause, namely, from the presence of a hydatid. (See WORMS, Chap. V.) The dog has no fit, but keeps continually turning round and round, and at last dies worn out. It is most commonly met with in high-bred puppies, whose constitutions are of great delicacy ; and I have known a whole litter carried off, one after the other, in this way. As far as I know, no *remedy* is of any avail ; but bleeding, blistering, and purgatives are said to have restored some few cases. The seton, also, has been recommended, and is, in my opinion, more likely than any other remedy to produce a cure, taking care to keep the strength supported against the lowering effects of this remedy.

---

## INFLAMMATIONS OF THE EYE.

*Ophthalmia*, or simple inflammation of the eyes, is very common in the dog, especially in the latter stages of distemper, when the condition of this organ is often apparently hopeless; though a little patience will show that no mischief eventually occurs. On more than one occasion I have saved puppies from a watery grave, whose eyes were said to be hopelessly gone; but without any remedy being applied locally, and simply by attending to the general health, the organ has recovered its transparency, and the sight has become as good as ever. The appearance of this form, as seen in distemper, consists in an unnatural bluish redness of "the white" of the eye, together with a film over the transparent part, which may or may not show red vessels spreading over it. There is great intolerance of light, with a constant watering; and, if the eye is opened by force, the dog resists most strenuously, giving evidence of pain from exposure to the rays of the sun. This state resembles the "strumous ophthalmia" of children, and may be *treated* in the same way, by the internal use of tonics, the pills (62) being especially serviceable. In the *ordinary ophthalmia* the "white" of the eye is of a brighter red, and the lids are more swollen, while the discharge is thicker, and the intolerance of light is not so great. The *treatment* here which is most likely to be of service is of the ordinary lowering kind, exactly the reverse of that indicated above. Purgatives, low diet, and sometimes

bleeding, will be required, together with local washes, such as (55) or (56). If the eyes still remain covered with a film, a seton may be inserted in the back of the neck with advantage, and kept open for two or three months.

*Cataract* may be known by a whiteness more or less marked in the pupil, and evidently beneath the surface of the eye, the disease consisting in an opacity of the lens, which is situated *behind* the pupil. It may occur from a blow, or as the result of inflammation, or from hereditary tendency. No *treatment* is of any use.

In *amaurosis* the eye looks clear, and there is no inflammation; but the nerve is destroyed, and there is partial or total blindness. It may be known by the great size of the pupil.

---

#### CANKER, OR INFLAMMATION OF THE EAR.

From high feeding generally, and exposure to the weather, many dogs (especially of a sporting kind) contract an inflammation of the membrane or skin lining the ear. This produces irritation, and the dog shakes his head continually, which together with the tendency to spread externally, causes an ulceration of the tips of the ears of those dogs, such as the hound, pointer, setter, spaniel, &c., which have these organs long and pendulous. Hence, the superficial observer is apt to confine his observation to this external ulceration, and I have even known the tips of the ears

cut off in the hope of getting rid of the mischief, whereas it was only aggravated, because the incessant shaking caused the wound to extend, while the internal mischief was not in the slightest degree relieved. The pointer is particularly liable to "canker," as shown on the tips of the ears, because he has little hair on this part to take off the acuteness of the "smack" which is given in the shaking of the head. Long-haired dogs on the other hand are quite as liable to the real disease, as evidenced on an examination of the internal surface, but, from the protection afforded by the hair, the pendulous ear is not so much ulcerated or inflamed. Whenever, therefore, a dog is seen to be continually shaking his head, and abortively trying to rub or scratch his ear, not being able to succeed because he cannot reach the interior, an examination should be made of the passage leading into the head; and if the lining is red and inflamed, there is clear evidence of the disease, even if the external ear is altogether free from it. On the other hand, the mere existence of an ulceration on the tips of the ears is no absolute proof of "canker," because it may have been caused by the briars and thorns which a spaniel or heund has to pass through in hunting for his game. Still it should lead to a careful inspection, and, if it continues for any length of time, it may be generally concluded that there is an internal cause for it.

The *treatment* should in every case be chiefly directed to the internal passage, the cap which is sometimes ordered to be applied to the head, with a view of keeping the ears quiet, having a tendency to increase the internal inflammation, and being, therefore, rather prejudicial than otherwise. The first thing to be done, is

to lower the system by purgatives (11), (12), (15), or (16), with low diet, including no animal food. As soon as this has produced a decided effect, the nitrate of silver wash (22), the ointment (58*a*), melted, or the sulphate of zinc (20), should be dropped into the ear-passage, changing the one for the other every second or third day. At the same time the sores on the edges of the ears may be touched with bluestone daily, which will dry them up. In slight cases, this treatment will suffice for a cure, if carried on for three weeks or a month; but, in long-standing attacks, a seton must be put into the back of the neck, and this seldom fails to afford relief. If the inflammation in the external ear has been so great as to produce abscesses, they must be slit open with the knife to the very lowest point, as wherever matter is confined in a pouch there can be no tendency to heal. Whenever anything is to be done to the ear the dog must be muzzled, as the head cannot otherwise be held sufficiently still, and in pouring in the lotion, the head must be placed on a table, and held there steadily for some minutes, so that the fluid may have time to penetrate the whole canal.

*Deafness* may arise from canker, or from rheumatic or other inflammation of the internal ear; but, as no treatment is likely to be beneficial, there is no use in enlarging on the subject. The only remedy at all to be relied on in recent cases is the seton in the back of the neck.

---

## INFLAMMATION OF THE MOUTH AND TEETH.

Dogs which are fed on strongly stimulating food are very apt to lose their teeth by decay, and also to suffer from a spongy state of the gums, attended with a collection of tartar about the roots of the teeth. Decayed teeth are better extracted, but the tartar, when it produces inflammation, may be removed by instruments if it is considered worth the trouble. By carefully scraping the teeth there is little or no difficulty in removing it if the dog's head is held steadily, but few people are handy enough with the necessary tools to effect this, excepting those who make a business of the art; and, if the dog is so highly valued as to make it desirable to incur the expense, he should be taken to a veterinary surgeon. A lotion composed of 1 part of a solution of chlorinated soda, 1 part of tincture of myrrh, and 6 parts of water will be afterwards of service, if the teeth are occasionally brushed with it. When puppies are shedding their milk teeth, it often happens that these are not easily got rid of, producing a good deal of soreness in the mouth which prevents the puppy eating. In such a case the old tooth is better removed with a pair of forceps.

*Blain* is a watery swelling beneath the tongue, showing itself in several large vesicles containing straw-coloured lymph, which is sometimes stained with blood. When discovered, the *treatment* consists in pricking them with a lancet or penknife, after which the sores may be washed with the lotion given above.

---



## INFLAMMATIONS.

*Ozæna* is an inflamed state of the lining membrane of the nose producing a stinking discharge from the nostrils. This is very common in the pug dog, and also more or less in toy spaniels. There is little to be done in the way of treatment, but a solution of chloride of zinc (2 grains to the ounce of water) may be thrown up into the nostrils with a syringe.

## LARYNGITIS AND BRONCHOCELE.

*Laryngitis* consists in inflammation of the top of the wind-pipe, where there is a very narrow passage for the air, and consequently where a slight extra contraction caused by swelling is necessarily fatal. When *acute* it is a very dangerous disease, and is characterised by quick and laborious breathing, accompanied by a snoring kind of noise. There is also a hoarse and evidently painful cough. Pulse quick and sharp, and some degree of fever. The *treatment* must be active, or it will be of no use. Large bleedings, followed by a calomel purge (12) and the fever powder (50), will be necessary; but no time should be lost in calling in skilful aid, if the life of the dog is of any consequence.

*Chronic laryngitis* attacks the same part, but comes on insidiously, and is shown chiefly in a hoarse cough and stridulous

bark. It is best treated by a seton in the throat, together with low diet and the alterative pill (1).

*Bronchocele* is known by an enlargement (often to the size of the fist) of the thyroid body placed just on each side of the wind-pipe. If this does not press upon the air-passage, there is no inconvenience; but in course of time it has that ill effect, and the dog becomes wheezy and short-winded. It is chiefly seen in house pets, and may be relieved by the internal use of iodine (3), given for weeks together.

---

#### INFLAMMATION OF THE LUNGS.

The organs of respiration consist of an external serous and an internal mucous membrane, united together by a cellular tissue, and each of these is the seat of a peculiar inflammation (*pleurisy, pneumonia, and bronchitis*), attended by different symptoms and requiring a variation in the treatment. There is also, as in all other inflammations, an *acute* and a *chronic* kind, so that here we have six different inflammatory disorders of the contents of the chest, besides heart disease and phthisis or consumption, which last requires a separate notice. All the acute forms are attended with severe sympathetic fever, and with a quick pulse; but the character of the latter varies a good deal. The chronic forms have also some slight febrile symptoms; but generally in proportion to the acuteness is the amount of this attendant or sympa-

thetic fever. As these three forms are liable to be easily mistaken for each other, I shall place the symptoms of each in juxtaposition in the following Table :

COMPARATIVE TABLE OF SYMPTOMS.

|                      | Acute Pleurisy.   | Acute Pneumonia.  | Acute Bronchitis.   |
|----------------------|---|---|---|
| Early symptoms.      | Shivering, with slight spasms of the muscles of the chest ; inspiration short and unequal in its depth, expiration full, air expired not hotter than usual ; cough slight and dry ; pulse quick, small, and wiry. | Strong shivering, but no spasms ; inspiration tolerably full, expiration short, air expired perceptibly hotter than natural ; nostrils red inside : cough violent and sonorous, with expectoration of rusty coloured mucus ; pulse quick, full, and soft. | Shivering, soon followed by continual hard cough : inspiration and expiration equally full : air expired warm, but not so hot as in pneumonia ; cough soon becomes moist, the mucus expectorated being frothy, scanty at first, but afterwards profuse ; pulse full and hard. |
| Stethoscopic sounds. | No very readily distinguishable sound. A practised ear discovers a friction sound or rubbing.   | A crackling sound, audible in the early stage, followed by crepitating wheezing.  | The sound in this form varies from that of soap bubbles to a hissing or wheezing sound.   |
| Percussion.          | Produces at first no result different from a state of health. After a time, when serum is thrown out, there is increased dullness.  | Dullness after the early stage is produced by the thickening of the tissue, approaching to the substance of liver, hence called "hepatisation."   | No change.  |
| Termination.         | The symptoms either gradually disappear, or lymph is thrown out, or there is an effusion of serum or matter, with   | If the symptoms do not disappear, there is a solidification of the lung, by which it is rendered impervious to air, and in  | The inflammation generally subsides by a discharge of mucus, which relieves the inflammation ; or it may go   |

|                 | Acute Pleurisy.   | Acute Pneumonia.   | Acute Bronchitis.   |
|-----------------|---|--|---|
| Treat-<br>ment. | <p>a frequently fatal result.</p> <p>Bleeding in the early stage, in degree according to the severity of the attack. Relieve the bowels by (12) or (13). No blistering, which is actually prejudicial. Try the fever powder (19) or (50), and if not active enough give calomel and opium, of each 1 grain, in a pill, 3 times a day. Low diet of slops only.</p> | <p>bad cases suffocation takes place, or matter is formed, producing abscess.</p> <p>Bleeding in the early stage, in amount according to the severity of the attack. Give an aperient, (12) or (13). Blisters to the chest of service, or the mustard embrocation (42). Give the cough bolus (46) or the draught (47). If the inflammation is very high, give calomel and opium, of each 1 grain, digitalis <math>\frac{1}{2}</math> grain, tartar emetic <math>\frac{1}{4}</math> grain, in a pill, 3 times daily. Low diet of slops.</p> | <p>on to the extent of causing suffocation by the swelling of the lining membrane filling up the area of the tubes.</p> <p>No bleeding is required. In the early stage give an emetic (44). Follow this up with a mild aperient, (11) or (15). Apply the embrocation (42) to the chest, and give the cough bolus (46) or the draught (47). Low diet in the early stages; afterwards, a little solid food, not meat, may be given.</p> |

COMPARATIVE TABLE OF CHRONIC SYMPTOMS.

|                         | Chronic Pleurisy.   | Chronic Pneumonia.  | Chronic Bronchitis.  |
|-------------------------|---|---|--|
| Early<br>symp-<br>toms. | <p>Inspiration slower than expiration; cough dry; pulse quicker than natural, small and wiry.</p> | <p>Respiration quick and painful; cough troublesome but restrained; expectoration trifling; pulse quick and full.</p> | <p>Respiration quick but free; cough constant and severe, but without pain; pulse scarcely affected.</p> |

|              | Chronic Pleurisy.   | Chronic Pneumonia.  | Chronic Bronchitis.  |
|--------------|---|---|--|
| Termination. | Either in a cure, or else there is an effusion of serum into the chest, and generally also into the belly and limbs, causing suffocation by pressure. | If not ending in a cure, there is great difficulty of breathing, often ending in suffocation. The animal does not lie down, but sits up on his hind legs, supporting himself on his fore legs.  | Ends in a cure, or in a permanently chronic state of inflammation. Or, if fatal, there is suffocation from effusion, but this is very rare in chronic bronchitis.  |
| Treatment.   | The same as for acute pleurisy, but milder in degree, and the diet is not required to be so strictly confined to slops.                               | Bleeding will seldom be required. Give the calomel, opium, and tartar emetic, without the digitalis, in the doses ordered for acute pneumonia. After a few days have recourse to the bolus (46). Diet nourishing, but strictly confined to farinaceous articles. The embrocation is of great service. | Dispense with the emetic, and at once try the cough bolus (46). In very mild cases, give ipecacuanha $\frac{1}{2}$ grain, rhubarb 2 grains, opium $\frac{1}{2}$ grain, in a pill, 3 times a day. Apply the mustard embrocation (43). Milk diet, with nourishing slops. |

These various forms constantly run into one another, so that we seldom see pleurisy without some degree of pneumonia, or the latter without bronchitis. Still one generally predominates over the other, and, as far as treatment is concerned, that one may be considered as distinct. So also there is every shade between the very acute form, the acute, the subacute, the chronic, and the permanently chronic; but for practical purposes the two divisions are sufficient.

## SPASMODIC ASTHMA.

What is often called asthma in the dog is nothing more than a permanently chronic form of bronchitis, which is very common among petted toy dogs or house dogs, which are not allowed much exercise. The symptoms and treatment are detailed under the head of Chronic Bronchitis, at p. 403. But there is a form of true asthma with spasm, which is also met with among the same kind of dogs, the *symptoms* of which are much more urgent, comprising a sudden accession of difficulty in breathing, so severe that the dog evidently gasps for breath, and yet there is no evidence of inflammation. It may be known by the suddenness of the attack, inflammation being comparatively slow in its approach. The *treatment* consists in the administration of an emetic (45), followed by the cough bolus (46), or the draught (47); but, if the spasms are very severe, a full dose of laudanum and ether must be given, viz.—1 drachm of laudanum, and 30 drops of the ether, in a little water, every three hours, till relief is afforded. The mustard embrocation (42), or the turpentine liniment (43), may be rubbed into the chest with great advantage.

---

## PHTHISIS, OR CONSUMPTION.

This disease, though very commonly fatal among highly-bred animals, has not been noticed by the writers on the diseases of the dog in this country, neither Blain, Youatt, nor Mayhew making the slightest allusion to it. I have, however, seen so many cases of tubercular disease in the dog, that I cannot doubt its existence as an ordinary affection, and, since I know that hundreds die every year from it, I cannot pass it over without notice. I have seen the tubercles in almost every stage of softening, and have known scores of cases in which a blood-vessel has given way, producing the condition known in the human being as "spitting of blood," without any other attendant symptoms than those which are seen in man.

The *symptoms* of consumption are, a slow insidious cough, without fever in the early stage, followed by emaciation, and ending after some months in diarrhœa, or exhaustion from the amount of expectoration, or in the bursting of a blood-vessel, which last is generally the termination in those dogs that are kept for use, the work to which they are subjected leading to excessive action of the heart, which is likely to burst the vessel. In the latter stages there is a good deal of constitutional fever, but it is seldom that the dog lives long enough to show this condition, being either destroyed as incurable, or dying rapidly from loss of blood or diarrhœa. *Treatment* is of little use, as, though the attack may be postponed, the disease cannot be cured, and no phthisical animal

should be bred from. Cod-liver oil is of just as much service as in the human subject, but, as before remarked, it can only put off the fatal result. Except, therefore, in the case of house-pets, it is not desirable to use it. The dose is from a teaspoonful to a table-spoonful three times a day.

---

#### GASTRITIS, OR INFLAMMATION OF THE STOMACH.

This affection is, like all others of the same kind, either *acute* or *chronic*. The former very rarely occurs except from poison, or highly improper food, which has the same effect. The *symptoms* are a constant and evidently painful straining to vomit, with an intense thirst, dry hot nose, quick breathing, and an attitude which is peculiar, the animal lying extended on the floor, with his belly in contact with the ground; and in the intervals of the retching, licking anything cold within reach. The *treatment* consists in bleeding, if the attack is very violent; calomel and opium, of each a grain, in a pill every four hours; and two drops of the diluted hydrocyanic acid in a little distilled water following each. Thin gruel or arrow-root may be given occasionally in very small quantities, but until the vomiting ceases they are of little service. If poison has clearly been swallowed, the appropriate treatment must be adopted.

*Chronic gastritis* is only another name for one of the forms of dyspepsia, for the symptoms and treatment of which see p. 448.



## INFLAMMATION OF THE LIVER (HEPATITIS, OR YELLOWS).

This is one of the most common of the diseases to which sporting dogs are subject, in consequence of the exposure to cold and wet which they are submitted to, producing congestion of the liver, and this going on to inflammation. Dogs deprived of exercise also contract it, because their livers first becoming torpid the bile accumulates, and then, in order to get rid of it, nature establishes an action which ends in inflammation. The *symptoms* are a yellow state of the white of the eye and skin generally, from which the disease is commonly called "the yellows."

*Acute hepatitis* comes on rapidly, and with a good deal of fever, generally showing itself on the day after a long exposure to wet and cold, as in shooting or hunting. The dog shivers, his nose is hot, his breathing is slightly quicker than usual, and his pulse quick, *small*, and *wiry*. The bowels are confined, and when moved, the motions are clay-coloured or slaty. If these symptoms are not soon relieved, the case ends fatally, sickness coming on, and the strength being rapidly exhausted. The *treatment* should be, first, a considerable abstraction of blood; then give the bolus (13); and, as soon as it has acted, rub on to the right side, over the liver, the embrocation (42) or (43); and, at the same time, give calomel and opium, of each a grain in a pill, every four hours, taking care to keep the bowels open by the bolus (13), or by castor oil (15). As soon as the proper colour returns to the motions, the calomel may be entirely or partially discontinued, substituting small doses

of rhubarb and ipecacuanha. An emetic in the early stage (45) will sometimes act like a charm, unloading the liver, and thus at once cutting short the congestion, but when inflammation has set in actively it is worse than useless, inasmuch as it aggravates the disease tenfold.

*Chronic hepatitis* is more frequently caused by improper food than exposure, and is very different in its *symptoms* from the acute form. Whenever the *jæces* are pale, or dark, or slate-coloured, the approach of this disease may be suspected, and appropriate treatment should be commenced; but it is not until the liver is perceptibly enlarged, and the dog is evidently out of condition, that it is generally considered to be established, and then scarcely any remedies will be of much service. At this time there is often not only a hard enlarged state of the liver, easily felt through and below the ribs on the right side, but also a yielding watery enlargement of the belly, from a collection of serous fluid, which is thrown out in consequence of the pressure on the veins as they return through the liver itself. The skin is "hidebound," and the hair dull and awry; while, altogether, the dog looks thin and wretched. The *treatment* consists in the use of small doses of mercury, or podophyllin, according to the state of the liver (1) or (13); or sometimes ipecacuanha may be given instead of the mercury, in half-grain doses; but it requires a long time to act, and will only suffice in very mild cases. The red iodide of mercury may be rubbed into the side, mixed with lard (one drachm to one ounce of the lard), or the embrocation (42) or (43) may be used instead. Gentle exercise may be given at the same time, and

mild farinaceous food, with a small quantity of weak broth. After a time, as the liver begins to act (shown by the yellow colour of the *feces*), the disease relaxes, and the mercury may be dispensed with; but it is usually some considerable time before the stomach recovers its tone. A strong decoction of dandelion roots (made by boiling them for an hour in as little water as will serve to cover them, and then straining) may be given for this purpose, the dose being half a teacupful every morning.

---

#### INFLAMMATION OF THE BOWELS.

Four varieties of this condition are met with, viz. 1, acute inflammation of the peritoneal coat; 2, spasms of the muscular coat, attended with congestion or inflammation, and known as *colic*; 3, inflammation of the mucous coat, attended by *diarrhoea*; and 4, chronic inflammation, almost always followed by constipation.

Acute inflammation of the peritoneal coat is known as *peritonitis* and *enteritis*, according as its attacks are confined to the membrane lining the general cavity (*peritoneum*), or to that covering the intestines (*enteron*); but, as there is seldom one without more or less of the other, there is little practical use in the distinction. The *symptoms* are very severe, and are shown by shivering, fever-

ishness, cold dry nose, ears, and legs, breath hot, and the expression anxious, showing evidence of pain, which is increased on pressing the bowels with the hand. The tail is kept closely pressed against the body, and the attitude is peculiar to the disease, the back being arched, and the legs all drawn together. The bowels are costive, the urine scanty and high-coloured; there is thirst, and the appetite is absent altogether. Sometimes there is a slight vomiting after food, but at others it is retained; though, in the later stages, the former condition generally prevails. The disease soon runs on, and, if not relieved, is fatal in a few days. To *treat it*, take a large quantity of blood; give calomel and opium in grain doses of each, every three or four hours; put the dog in a warm bath for half an hour, and, after drying him, rub in the embrocation (43), avoiding pressure, and applying it rapidly, but lightly. After twelve hours the bowels may be moved by means of the castor oil (15); or, if necessary, the strong mixture (16), repeating the calomel pills till the tenderness ceases. Great skill is required in adapting the remedies to the disease, and a veterinary surgeon should be called in whenever the dog is worth the expense.

*Colic* is also a frequent complaint among the dog tribe, the *signs* being intense pain aggravated at intervals to such a degree as to cause the patient to howl most loudly, the back being at the same time arched as far as possible, and the legs drawn together. If this shows itself suddenly after a full meal, the colic may at once be surmised to exist, but the howl at first is not very loud, the dog starting up with a sharp moan, and then lying down

again, to repeat the start and moan in a few minutes with increased intensity, until it becomes a howl continued for many seconds together. The nose is of a natural appearance, and there is little or no fever, the evidence of pain being all that directs the attention to the bowels, where there is no tenderness, and, on the contrary, pressure gradually made with the hand seems to afford relief. The *treatment* should be by means of laudanum (1 drachm) and ether (30 drops) in a little water every two or three hours; or, in very bad cases, croton oil (1 drop) may be given in a pill with three grains of solid opium every four hours till the pain ceases. The embrocation (45) may also be rubbed into the bowels, either at once, or after a *very hot* bath continued for at least half-an-hour, which last remedy is of the greatest service. The clyster (17) may also be tried with advantage, and sometimes a very large quantity of warm water thrown up into the bowels while the dog is in the warm bath will afford instant relief. Colic sometimes ends in *intussusception*, which is a drawing of one portion of the bowel into the other; but of this there is no evidence during life, nor if there was would any remedy be of service, short of opening the belly with the knife and drawing out the inverted portion with the hand.

*Diarrhœa*, or inflammation of the mucous membrane of the bowels, is a constant visitor to the kennel. Sometimes it is produced by chronic inflammation of the mucous membrane; at others by improper food irritating it, but not to that extent; and at others again by an epidemic influence, the nature of which it is difficult to understand. The *symptoms* are too plain to need

description, further than to remark that the motions may be merely loose, marking slight irritation, or there may be a good deal of mucus (slime), which is an evidence of great irritation of the membrane: or, again, there may be shreds or lumps of a white substance resembling boiled white of egg, in which case the inflammation has run very high. Lastly, blood may be poured out, marking either ulceration of the bowel, when the blood is bright in colour, or an oozing from the small intestines, when it is of a pitchy consistence and chocolate colour; or a similar oozing from the large intestines, when the blood is similar to that drawn from a vein. It may also be poured out from piles, which are not uncommon in the dog, though they seldom bleed as they do in the human being, the horizontal position of the dog accounting for this immunity. The *treatment* for these several conditions will vary considerably. If there is reason to believe that there is irritation from improper food, a dose of oil (15) will clear all away and nothing more is needed. In slight cases of mucous diarrhœa, laudanum may be added to a small dose of oil (7), and if this does not have the desired effect, try (6), (8), or (9). Bleeding from an ulcerated surface or from the small intestines seldom occurs except in distemper, and can rarely be restrained when severe. Relief may be attempted by the bolus (18) or the pill (19), but the shock to the system is generally too great to allow of perfect health being restored. In case of bleeding from the large intestines, the chalk mixture (6), together with the bolus (18), will often avail. Rice-water should be given as the only drink, and well-boiled rice flavoured with milk as the only solid food.

*Chronic inflammation with constipation* is very apt to occur in dogs which are not exercised, and are fed with biscuit or meal without vegetables. The consequence is, that the bowels after a time become inflamed, and diarrhoea is set up; but, this soon ceasing, the mucous membrane is impaired in tone, and there is a want of the proper secretion, so that the *feces* become hard, and the muscular coat refuses to act as it should do. In such a case, the belly becomes distended, and there is excessive pain, with more or less spasm. In some instances the *feces* have become so impacted that no means could be used which would overcome the mechanical difficulty, and the dogs have died "undelivered." It is easy to distinguish these collections, because they may be readily felt through the flank, and nothing but a case of pregnancy can be mistaken for them. The *treatment* of habitual constipation should be by giving regular exercise and green vegetables with the food. Coarse oatmeal will almost always act gently on the bowels of the dog, and a costive animal may be fed upon porridge with great advantage, mixing wheat flour with it or Indian meal, so as to correct any over-activity. It is better to avoid opening medicine as a rule, though there is no objection to an occasional dose of a mild drug like castor oil. (See *Aperients*, page 345.) If the *feces* are impacted, throw up warm water or gruel repeatedly, till they are softened, and at the same time give the aperient (12), (15), or (16). If there are piles, which may be seen as dark nut-like tumours round the anus, give as much brimstone as will lie on a shilling to a dog of average size every morning mixed up in his food.

## INFLAMMATION OF THE KIDNEYS AND BLADDER.

The former of these affections, which may be known by a great scantiness of urine, and evident pain in the loins, is not very common in the dog, but it does occasionally occur. The only *treatment* likely to be of service is the administration of carbonate of soda (5 grs.), with 30 drops of sweet spirit of nitre, in a little water twice a day.

The *bladder*, and the *urethra* leading from it for the passage of the urine, are often subject to a mucous inflammation characterised by pain and constant irritation in passing water, and by a gradual dropping of a yellowish discharge from the penis. This is generally the result of cold, and may be treated by giving full doses of nitre (10 grs.) with Epsom salts (half an ounce) in some water twice a week. If the discharge and pain are very severe, balsam of copaiba may be administered, the best form being the "capsules" now sold, of which two form a dose for an average-sized dog. If the discharge has spread to the exterior of the penis, the wash (20) will be of service.

---



## SKIN DISEASES.

Almost all skin diseases depend on neglect in some form ; and in the dog they arise either from improper management, as in the case of "blotch," or "surfeit," or from the presence of parasites, as in mange. These three names are all that are applied to skin diseases in the dog, though there can be no doubt that they vary greatly, and mange itself is subdivided by different writers so as to comprehend several varieties. Fleas, ticks, &c., also irritate the skin greatly, and all will therefore be included here, the inflammation produced by them being entitled to be considered a skin disease as much as mange itself.

*Blotch*, or *surfeit*, shows itself in the shape of scabby lumps of matted hair, on the back, sides, head, and quarters, as well as occasionally on the inside of the thighs. They vary from the size of a sixpence to that of half-a-crown, are irregularly round in shape, and after about three or four days the scab and hair fall off, leaving the skin bare, red, and slightly inclined to discharge a thin serum. The disease is not contagious, and evidently arises from gross feeding joined very frequently with want of exercise, and often brought out by a gallop after long confinement to the kennel. The appropriate treatment is to remove the cause by giving mild aperients (11), (13), or (14), with low diet and regular exercise, by the aid of which, continued for some little time, there is seldom any difficulty in effecting a cure.

*An eruption between the toes*, similar in its nature and cause to "blotch," is also very common, showing itself chiefly at the roots of the nails, where there are considerable redness and swelling, and so much tenderness as to make the dog quite lame. In bad cases, when the constitution is impaired by defective kennel arrangements, the sores become very foul, and are then very difficult to heal. In order to remove this state of things, the general health must first be attended to, using the same means as in "blotch" if the cause is the same, and touching the sores themselves with blue-stone, which should be well rubbed into the roots of the nails, first scraping it to a fine point. When the health is much impaired and the sores are in the foul state described above, give from five to eight drops of *liquor arsenicalis* with each meal, which for this condition should be of good nourishing food. This remedy must be continued for weeks, or even months in some obstinate cases. Here, after applying the blue-stone, it is often of service to rub in a *very* little tar-ointment, and then dust all over with powdered brimstone, dipping the foot into a box of it being the best mode of applying it.

*Foul mange* (resembling the *psoriasis* of man in its nature) is a most unmanageable disease, inasmuch as it has become quite constitutional before it can be so designated, and because, being a disease of the blood, it requires a complete change in the composition of this fluid before it can be eradicated. It is doubtful whether mange is contagious, but that it is hereditary I have no doubt whatever, the proofs within my own knowledge being amply sufficient to convince me of the fact. Thus I have seen a bitch

apparently cured of it, and with a perfectly healthy skin, produce a litter of whelps all of which broke out with mange at four or five months old, though scattered in various parts of the country at their walks; the bitch afterwards showing the impurity of her blood by again and again becoming the subject of mange. I should therefore never breed from either a dog or bitch who was attacked by this form of eruption. There is considerable thickening of the skin with an offensive discharge from the surface, chiefly flowing from the cracks and ulcerations under the scabs on it. This dries and falls off in scales, taking with them a good deal of the hair, which is further removed by the constant scratching of the poor dog, who is tormented with incessant itching. Almost always there is a fat unwieldy state of the system from want of exercise, but the appetite is often deficient. The *treatment* is founded upon the constitutional nature of the disease, which is not caused by any parasite or vegetable growth, and is solely the result of what is commonly called foulness of the blood. The first thing to be done is to clear out the bowels by a brisk aperient, such as (12) or (13). Then give low diet without flesh, starving the dog till he is ready to eat potatoes and green vegetables, alternately with oatmeal porridge,—and then only in moderate quantities. As soon as the stomach is brought down to this kind of food, but not before, begin to give the *liquor arsenicalis* with the food, the dose being a drop to each four pounds in weight of the animal, and thus a dog of eight pounds' weight will require two drops three times daily; taking care to divide the food into three equal portions, and not to give more of this altogether than is required for the purpose of

health. The arsenic must be administered for weeks or even months, and as soon as the itching seems abating, and the health is improved, the mangy parts of the skin may be slightly dressed with small quantities of sulphur and pitch ointments mixed in equal proportions. By a perseverance in these remedies for two or three months, the blood becomes purified, and the eruption disappears, after which, if the health seems impaired, a stomachic or tonic, (59) or (62), will often be required. Sometimes the ointment (58*a*) will be required.

*Virulent mange* (which may be compared to *psora* and *porrigo* in the human subject) is of two kinds, one attributable to a parasitic insect, and the other of vegetable origin. In the former case, which is its most common form, it appears in large kennels where cleanliness is not sufficiently attended to, and when the floors become loaded with the excretions. There is no doubt that this is highly contagious, but there is also little difference of opinion as to its being capable of being bred or developed among a lot of previously healthy dogs if mismanaged in the above way. The skin shows itself bare of hair in large patches of irregular form, and the hair being as it were gradually worn away at the edges, as if by scratching. The skin is dry and rough, with cracks and creases in various directions, from some of which a thin ichorous discharge may be seen to flow, on removing the scabs which fill them. The dog feeds well, but from want of sleep is languid and listless; there is considerable thirst and some slight feverishness, but very often the flesh is maintained for months at a high rate. The *treatment* of this form of mange is founded upon the belief

that it is caused by an insect of the *acarus* tribe, which has been detected by the microscope in many cases, but which by some people is maintained to be an accidental effect, and not a cause of mange. However this may be, it is found that remedies which are destructive to insect life, are by far the most efficacious, such as hellebore, sulphur, corrosive sublimate, tobacco, &c. The *second kind* of virulent mange is more rare than that described above, and still more difficult of cure, the vegetable parasite being less easily destroyed than the insect. This parasite is supposed to be of the nature of mould or fungus, which we all know is most obstinately tenacious of life, and is reproduced again and again in any liquid where it has once developed its germs. In outward appearance this variety of mange differs very little from the insect-produced form, but it may be known by its generally attacking young puppies, while the other appears at all ages, but chiefly in the adult animal. The hair falls off in both, but there is more scab in the insect mange, probably from the fact, that it does not produce such violent itching, and therefore the scratching is not so incessant. The *treatment* is nearly the same in both cases, being chiefly by external remedies, though alteratives, stomachics, and tonics, are often required from the loss of health which generally accompanies the disease. In all cases, therefore, it is necessary to attend to this, giving generally a mild aperient first, such as (12) or (13), and subsequently (2) and (3) combined together, or (1) and (59), according to circumstances. At the same time one of the following applications may be tried externally, with the greatest care that the dog does not lick them off, as they are highly poi-

sonous when taken into the stomach. To the wash some aloes is added, with the view of preventing this by the bitter taste of the drug, but though it has this good effect partially, there is nothing like a wire or leathern muzzle kept constantly on, except when feeding, at which time of course the tongue is otherwise engaged. All applications must be rubbed well into the *roots* of the hair.

Ointment (or dressing) for virulent mange :

Green iodide of mercury, 2 drachms.

Lard, 2 ounces.

Mix, and rub as much as can be got rid of in this way, into the diseased skin, every other day, for a week; then wait a week, and dress again. Take care to leave no superfluous ointment.

A milder ointment :

Compound sulphur ointment, 4 oz.

Spirit of turpentine, 1 ounce.

Mix, and rub in every other day.

*Red mange* is quite of a different nature to either of the above forms, being evidently a disease of the bulb which produces the hair, inasmuch as the colouring matter of the hair itself is altered and, if white, the hair looks of a pale brickdust colour, almost as if the dog had been sprinkled over with this material. It first shows itself almost invariably at the elbows and inside the arms, then on the front and inside of the thighs, next on the buttocks, and finally on the back, which is only attacked when the disease has existed for some weeks or months. The health does not seem to suffer, and the skin is not at all scabbed, except from the effects

of the scratching, which is very frequent, but not so severe as in the virulent or foul mange. It appears most probable that red mange is contagious, but it is by no means a settled question, as it will often be seen in single dogs which are in the same kennel with others free from it entirely. Of its exact nature I know nothing, beyond the theoretical belief, founded upon analogy, that the disease is in the blood, and is not caused by any parasite. Dogs which are highly fed, and which are allowed to lie before the fire, are the most subject to it, while the poor half-starved cur becomes affected with the foul or virulent forms. The *treatment* consists in lowering the diet, giving aperients (12) or (13); following these up with the addition of green vegetables to the food, and at the same time using one or other of the following applications every other day. In obstinate cases arsenic may be given internally (see page 418).

Dressing for red mange :—

Green iodide of mercury,  $1\frac{1}{2}$  drachm.  
 Spirit of turpentine, 2 drachms.  
 Lard,  $1\frac{1}{2}$  ounce.

Mix, rub a very little of this well into the roots of the hair every other day.

Or,

Carbolic acid, 1 part.  
 Water, 30 parts.

Use as a wash.

*Canker of the ear* has been alluded to under the disease of that organ at page 396.

*Irritative inflammation of the skin* is produced by fleas, lice, and ticks, which are readily discovered by examining the roots of the hair. Dog-fleas resemble in appearance those of the human subject. The lice infesting him are, however, much larger, but otherwise similar in appearance. Dog-ticks may easily be recognised by their spider-like form, and bloated bodies, the claws adhering firmly to the skin, so that they are with some difficulty removed from it. These last are of all sizes, from that of an average pin's head to the dimensions of a ladybird, beyond which they seldom grow in the dog. They suck a great quantity of blood when they are numerous, and impoverish the animal to a terrible extent, partly by the drain on the system, and partly by the constant irritation which they produce. The remedies are as follows:—

To remove fleas and lice:—

Mix soft soap with as much carbonate of soda as will make it into a thick paste, then rub this well into the roots of the hair all over the dog's body, adding a little hot water so as to enable the operator to completely saturate the skin with it. Let it remain on for half an hour, then put the dog into a warm bath for ten minutes, letting him quietly soak, and now and then ducking his head under. Lastly wash the soap completely out, and dry before the fire, or at exercise, if the weather is not too cold. This, after two or three repetitions, will completely cleanse the foulest skin.

Dry remedies for lice and ticks:—

Break up the lumps of some white precipitate, then with a hard brush rub it well into the roots of the hair over the whole body. Get rid of the superfluous powder from the external surface of the coat by means of light brushing or rubbing with a cloth. Put a muzzle on, and leave the dog with the powder in the coat for five or six hours. Then brush all well out, reversing the hair for this



purpose, and the ticks and lice will all be found dead. A repetition at the expiration of a week will be necessary, or even perhaps a third time.

Or, use the Persian Insect-destroying powder, sold by Keating, of St. Paul's Churchyard, and other druggists, which seems to answer well.

Or, the following wash may be tried :

Acetic acid (Pharm. Lond.),  $3\frac{1}{2}$  ounces.

Borax,  $\frac{1}{2}$  drachm.

Distilled water,  $4\frac{1}{2}$  ounces.

Mix, and wash into the roots of the hair.

## CHAPTER V.

## DISEASES ACCOMPANIED BY WANT OF POWER.

Chorea.—Shaking Palsy.—Fits.—Worms.—General Dropsy or Anasarca.

As inflammation is attended by increased action of the heart and arteries, so this class of diseases is, on the contrary, accompanied by a want of tone (atony) in these organs, as well as by an irritability of the nervous system, which arises from the same cause. None of them require lowering measures, but, on the contrary, tonics and generous living will almost always be demanded. I have included worms among them, because these parasites produce a lowering effect, and seldom infest to any extent a strong healthy subject, preferring the delicate and half-starved puppy, to the full-grown and hardy dog.

---

 CHOREA.

*Chorea*, or *St Vitus's dance*, may be known by the spasmodic twitches which accompany it, and by their ceasing during sleep.

In slight cases the spasm is a mere drop of the head and shoulder, or sometimes of the hind quarter only, the nods in the former case, or the backward drop in the latter, giving a very silly and weak expression to the animal. Chorea is almost always a consequence of distemper, so that it is unnecessary to describe its early stages, and the disease itself cannot be further defined than by the above description. It seldom goes on to destroy life, though occasionally it is accompanied by fits, the disease in the brain and spine then being of such a severe nature, as to end fatally in the course of time, the dog apparently dying from exhaustion. Of the exact nature of the disease we know nothing, the most careful examination of the brain and spinal cord leading to no useful result. But it often happens that there is present at the same time, a degree of mischief in the stomach, caused apparently by the presence of worms, and then the chorea is said to be sympathetic with this. In the *treatment*, therefore, it is desirable to ascertain the existence of worms, and if they are found, no remedy will be likely to be beneficial so long as they are allowed to continue their attacks. If they are only suspected, it is prudent to give a dose of the most simple worm-medicine, such as the arca nut (65), and if this brings away only one or two, the presence of others may be predicated, and a persistence in the proper remedies (see p. 439) will be necessary, till the dog is supposed to be cleansed from them. Beyond this, the remedies must be directed to improve the general health, and at the same time to relieve any possible congestion of the brain or spine by the insertion of a seton in the neck. Fresh country air is the best giver of strength, and it alone will often

suffice; but if not, after trying good nourishing animal food, mixed with a proper proportion of vegetables, recourse may be had to the following tonic, which is often of the greatest service :

Sulphate of zine, 2 to 5 grains.

Extract of gentian, 3 grains.

Mix, and form a bolus. To be given three times a day.

Attention must be carefully paid to the state of the bowels, both constipation and looseness being prejudicial to the health, and each requiring the appropriate treatment laid down at pages 412 and 414. Sometimes the tonic pill (62) will do wonders, and often the change from it to the sulphate of zine and back again will be of more service than either of them continued by itself. A perseverance in these methods, with the aid of the shower-bath, used by means of a watering-pot applied to the head and spine, and followed by moderate exercise, will sometimes entirely remove the disease, though in the majority of cases a slight drop will be ever afterwards noticed, and in sporting-dogs the strength is seldom restored to the same extent as before.

---

#### SHAKING PALSY.

This resembles chorea in its nature, but it is incessant, except during sleep, and attacks the whole body. The *same remedies* may be applied, but it is an incurable disease, though not always destroying life.

## FITS.

*Fits* are of three kinds: 1st, those arising from irritation, especially in the puppy, and known as convulsive fits; 2nd, those connected with pressure on the brain, and being of the nature of apoplexy; and 3rd, epileptic fits, which may occur at all ages, and even at intervals throughout the whole life of the animal.

*Convulsive fits* are generally produced by the irritation of dentition, and occur chiefly at the two periods when the teeth are cut, that is, in the first month, and from the fifth to the seventh. They come on suddenly, the puppy lying on its side, and being more or less convulsed, the extent and severity of the struggling being no indication of the amount of the disease. There is no foaming at the mouth, and the recovery from them is gradual, in both these points differing from epilepsy. The only *treatment* at all likely to be of service, is the use of the hot-bath, which in young and delicate puppies may sometimes give relief. Fits arising in distemper, are caused by absolute mischief in the brain, unless they occur as a consequence of worms, which will also produce them at other times, and are nearly as often the cause as teething. In such cases, these parasites being removed, the fits cease.

In *apoplectic fits* the dog lies insensible, or nearly so, without foaming at the mouth, but snoring and breathing heavily. Here the *treatment* must be conducted by taking away blood from the neck-vein, afterwards purging by means of croton oil, and inserting

a seton in the back of the neck. The attack, however, is generally fatal, in spite of the most scientific treatment.

*Epilepsy* may be distinguished by the blueness of the lips and gums, and by the constant champing of the jaws and frothing at the mouth, which constantly accompany its attacks. The fit comes on without any notice, frequently in sporting dogs while they are at work, a hot day being specially provocative of it. In the pointer and setter, the fit almost always occurs just after a "point," the excitement of which seems to act upon the brain in producing it. The dog falls directly the birds are sprung, and after lying struggling for a few minutes, or perhaps a quarter of an hour, rises, looking wildly about him, and then sitting or lying down again for a few minutes, he is ready to go to work again, apparently unconscious of anything having been the matter. As in chorea so in epilepsy, nothing is known of the *cause*, and the *treatment* is therefore guided by the most empirical principles. Within the last ten years bromide of potassium has been used with great success in the human subject, but although I have recommended its use in many cases on the dog, I have not heard the result. The dose for a moderate-sized animal is 3 grs. twice a day in a pill, continued for a month at least.

---

#### WORMS.

*Worms* are a fertile source of disease in the dog, destroying every year more puppies than distemper itself; and, in spite of

every precaution, appearing in the kennelled hound or shooting-dog, as well as the pampered house-pet and the half-starved cur. In old and constantly used kennels they are particularly rife, and I believe that, in some way, their *ova* remain from year to year, attached either to the walls or to the benches. All of the varieties met with are propagated by *ova*, though some, as the *Ascaris lumbricoides*, are also viviparous, so that the destruction of the worms actually existing at the time the vermifuge is given does not necessarily imply the after clearance of the animal, who may be infested with them as badly as before, from the hatching of the eggs left behind. The natural history of these parasites is, however, very imperfectly understood, in spite of the carefully recorded and extended labours of Rudolphi, Schmalz, Cloquet, Creplin, and our own Owen; indeed, as it is not till after the death of the animal infested by them that they can be reached, it is only wonderful that so much is known. Besides the intestinal worms, there are also others met with in the dog, including the large kidney worm, (*Strongylus gigas*), which shall presently be described, and the hydatid, which is in all probability the cause of turnside; but, though found in the dog's brain, its presence has not, I believe, been clearly associated with that disease. I shall, therefore, first describe the appearance of each kind of worm; then the symptoms of worms in general; and, lastly, the best means for their expulsion.

The *Maw-worm* (*Ascaris vermicularis*) is much larger than its representative in the human subject, which is a mere thread, and is hence called the "thread-worm." In the dog it is about an

inch in length (*fig. 1*), of a milky white colour, with one end cut off obtusely and slightly puckered (the mouth), and the other

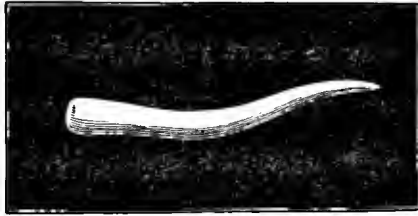

Fig. 1.

pointed (the tail). Maw-worms exist in great numbers in the dog, chiefly occupying the large intestines, and not injuring the health to any great degree, unless they exist in very large numbers. They are male and female, and are propagated by *ova*.

The *Round-worm* (*Ascaris lumbricoides*) is from four to seven inches long, round, firm, and of a pale pink colour. The two extremities are exactly alike, and are slightly flattened in one direction at the point (see *fig. 2*), in which *a* shows the worm extended,

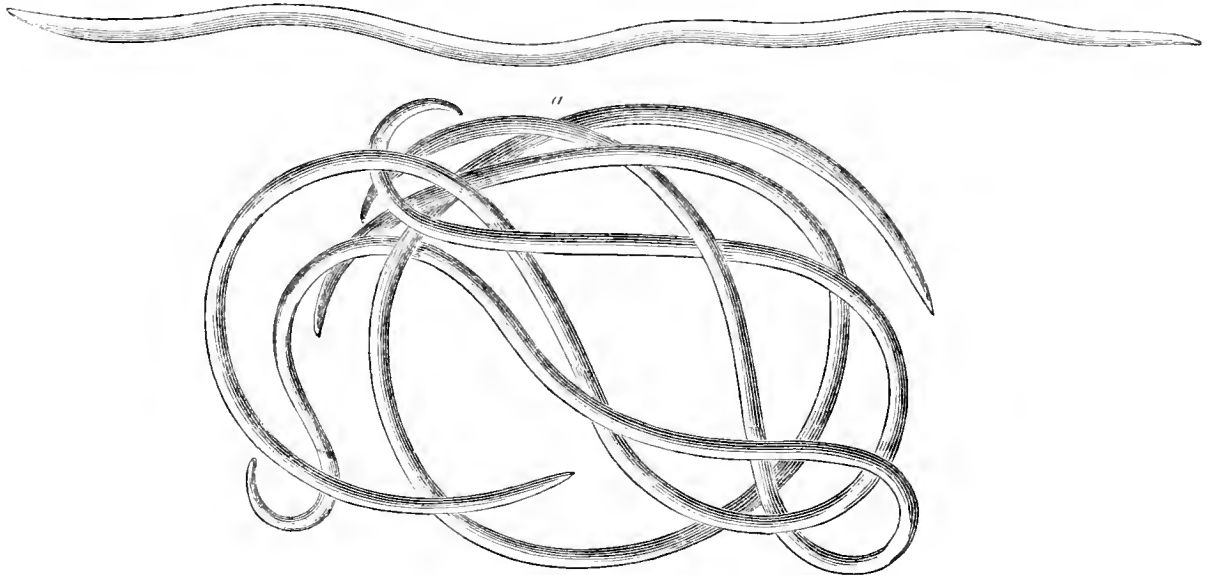

Fig. 2.

*b*



and *b* a group of three as actually discharged from the intestine of a dog in which they were thus knotted. I have often seen from six to a dozen round worms thus collected together, so as when discharged to form a solid mass as large as an egg. Like the last species they are propagated by *ova*, but sometimes these are hatched in the body of the parent, so that a large worm may be seen full of small ones. This species occasions much more inconvenience than the maw-worm, but still far less than the tape-worm.

*Tape-worms* in the dog are described by foreign writers as of five kinds, of which the *Tenia solium* and *Bothriocephalus latus* are common to man and the dog. The others are not readily distinguished from these two, and all are now said to be developed from the hydatid forms found in the livers of sheep, rabbits, &c. The peculiarity in the bothriocephalus consists in the shape of the head (see *fig. 4*), which has two lateral longitudinal grooves (*bothria*), while that of the true tænia is hemispherical. The following is a description according to Professor Owen:—"The *Tenia solium* attains the length of several feet, extending sometimes from the mouth to the anus. The breadth varies from one-fourth of a line at its anterior part to three or four lines towards the posterior part of the body, which then again diminishes. The head (*fig. 3, a*) is small, and generally hemispherical, broader than long, and often as if truncated anteriorly; the four mouths, or oscula, are situated on the anterior surface, and surround the central rostellum, which is very short, terminated by a minute apical papilla, and surrounded by a double circle of small recurved hooks. The segments of

the neck, or anterior part of the body, are represented by transverse rugæ, the marginal angles of which scarcely project beyond the lateral line; the succeeding segments are subquadrate, their

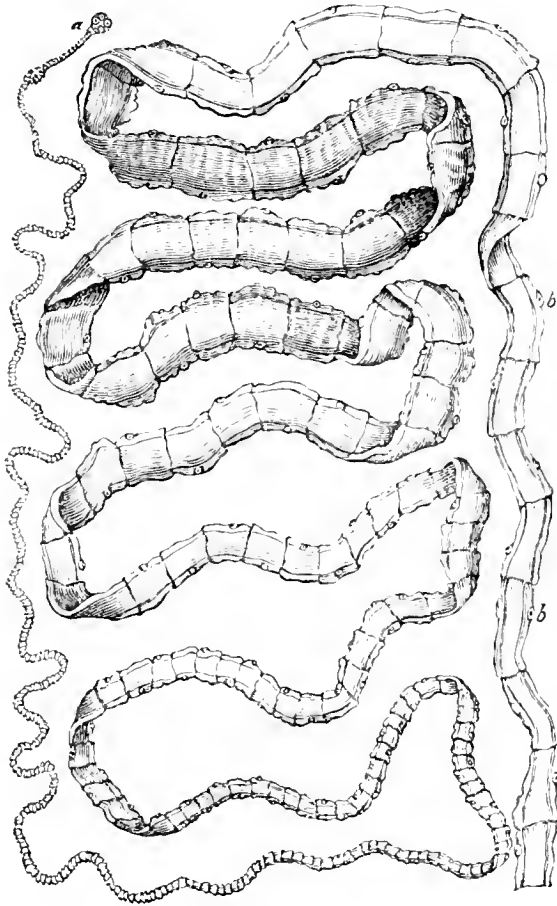

Fig. 3.



Fig. 4.

length scarcely exceeding their breadth; they then become sensibly longer, narrower anteriorly, thicker and broader at the posterior margin, which slightly overlaps the succeeding joint. The last series of segments are sometimes twice or three times

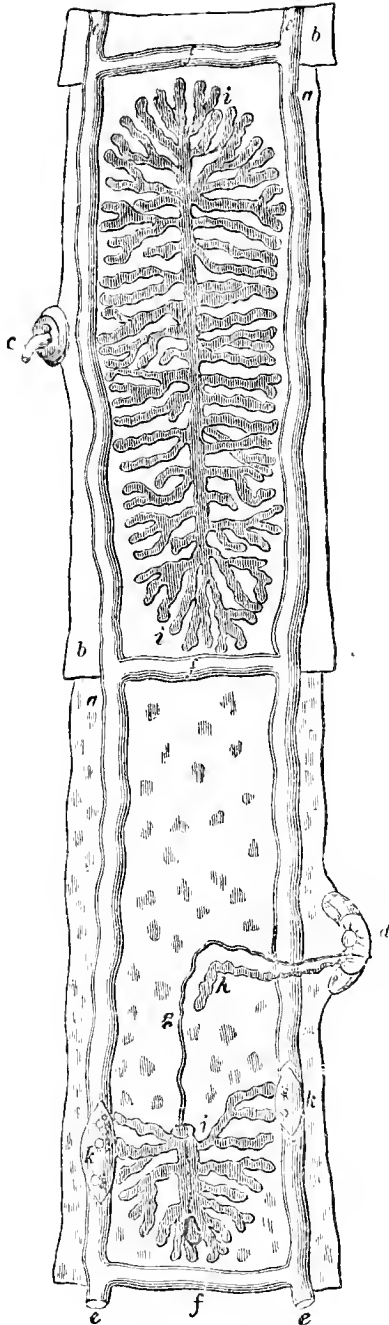

Fig. 5.

as long as they are broad. The generative orifices (*b b*) are placed near the middle of one of the margins of each joint, and are generally alternate (*fig. 5, c d*). The *Tenia solium* is androgynous; that is to say, it produces its *ora* without the necessity for the contact of two individuals, the male and female organs being contained in each." Professor Owen thus describes them: "In each joint of this worm there is a large branched ovary (*fig. 5, i*), from which a duct (*h*) is continued to the lateral opening; the *ora* are crowded in the ovary, and in those situated on the posterior segments of the body they generally present a brownish colour, which renders the form of their receptacle sufficiently conspicuous. In segments which have been expelled separately, we have observed the ovary to be nearly empty; and it is in these that the male duct and gland are most easily perceived. For this purpose, it is only necessary to place the segment between two slips of glass, and view it by means of a simple lens, magnifying from 20 to 30

diameters. A well-defined line (*g*), more slender and opaque than the oviduct, may then be traced, extending from the termination of the oviduct, at the lateral opening, to the middle of the joint, and inclined in a curved or slightly wavy line to near the middle of the posterior margin of the segment, where it terminates in a small oval vesicle. This, as seen by transmitted light, is subtransparent in the centre, and opaque at the circumference, indicating its hollow or vesicular structure. The duct, or *vas deferens*, contains a grumous secretion; it is slightly dilated just before its termination. In this species, therefore, the ova are impregnated on their passage outward." (*Cyclopaedia of Anatomy*, art. *Entozoa*.) From this minute description it may be gathered, that the ova are in enormous numbers, each section of the worm being capable of producing them to an almost indefinite extent; and as they are passed out of the body with the *fæces*, it is not surprising that they are readily communicated from one dog to another, as is almost proved to be the case from the fact of their prevalence in certain kennels and absence from others. The injury caused by these worms is twofold, depending partly upon the abstraction of nourishment, which is absorbed by the worm, and partly by the irritation produced by its presence in the intestines; and hence it is of the utmost importance to get rid of so troublesome a customer.

The *Kidney-worm* (*Strongylus gigas*) "inhabits the kidney of the dog, as well as that of the wolf, otter, raccoon, glutton, horse, and bull (see *fig. 6*). It is generally of a dark blood-

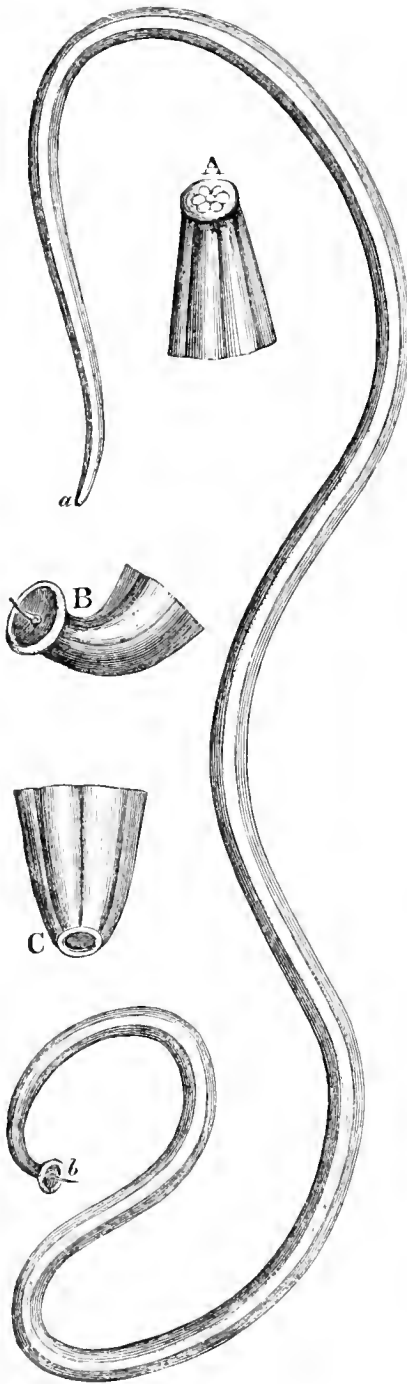

Fig. 6.

colour, which seems to be owing to the nature of its food, which is derived from the vessels of the kidney, as, when suppuration has taken place round it, the worm has been found of a whitish hue." In the human kidney it has been known to attain the length of three feet, with a diameter of half an inch. "The head (*a*) is obtuse, the mouth orbicular and surrounded by six hemispherical papillæ (*A*); the body is slightly impressed with circular striæ, and with two longitudinal impressions; the tail is incurved in the male, and terminated by a dilated point or *bursa* (*B*), from the base of which the single intromittent spiculum (*b*) projects. In the female the caudal extremity is less attenuated and straighter, with the anus (*c*) a little below the apex." (*Cyclopaedia of Anatomy*, art. *Entozoa*.) I have been thus particular in inserting descriptions of these worms, because I find that the study of their natural history is becoming more general; and as there is a large field for the microscopic

inquirer, it is well to have a good ground to start from. The generation of parasites is at all times of great interest, but, with reference to the *Entozoa*, there is so much still unknown, that the natural historian who would be able to throw light on this branch of his favourite study would deserve the thanks of those who, while they take an equal interest in it with himself, have not the opportunity, or perhaps the industry, which he possesses.

The *symptoms* of the presence of worms in the dog should be carefully noted and anxiously looked for, if the health of the animal is of any importance. They are, an unhealthy appearance of the coat, the hair looking dead and not lying smoothly and evenly; appetite ravenous in proportion to the condition, which is generally low, though worms may exist for months without interfering much with the presence of fat. After a time, however, the fat of the body is absorbed, and the muscles, without being firm and prominent, are marked with intervening lines from its absence. The *feces* are passed frequently and in small quantities, the separate passage of a small quantity of mucus each time being particularly indicative of worms, especially if there is first a solid lump, and then a small portion of frothy mucus. The spirits also are dull, the nose hot and dry, and the breath offensive. These signs are only present to the full extent when the dog is troubled with tape-worm, or with the round-worm in large quantities; the maw-worm being only slightly injurious in comparison with the others, and seldom producing the whole of the above train of symptoms. The kidney-worm, of course, has no effect upon the intestinal secretions, but it produces bloody urine, more or less mixed

with *pus*. Still, as these are often present without this worm, it is impossible to predict its existence during life, with any degree of certainty. When worms are suspected, in order to distinguish the species, it is better to give a dose of calomel and jalap (16), unless the dog is very weakly, when the areca nut may be substituted (65); and then, by watching the *feces*, the particular worm may be detected and the treatment altered accordingly.

The *expulsion of the worms* is the proper method of *treatment* in all cases, taking care afterwards to prevent their regeneration, by strengthening the system, and by occasional doses of the medicine suited to remove the worm in question. All vermifuges act as poisons to the worms themselves, or as mechanical irritants; the former including the bulk of these medicines, and the latter powdered glass and tin as well as cowhage. These poisons are all more or less injurious to the dog, and in spite of every precaution fatal results will occur after most of them; even the areca nut, innocent as it is said to be, having occasionally nearly destroyed the life of valuable dogs under careful superintendence. There is a wonderful difference in the power of resisting the action of remedies in certain individuals of the dog tribe, as well as in the worms themselves; so that whereas in some instances a remedy may clear a dog easily without the slightest ill effect upon him, in another, apparently under the very same circumstances of health and strength, remedy and dose, a fatal result, or nearly so, shall be produced, and even without bringing away the worms. Hence there is always some little risk in conducting the removal of these troublesome parasites, which directly and indirectly cause more

deaths than all other diseases put together; the former by their own prejudicial effects, and the latter from the abuse of the powerful drugs which are employed.

The following *list of remedies* against the various worms is inserted:

For round and maw-worms:

Betel nut (*Nux areca*).  
 Stinking hellebore (*Helleborus fatidus*).  
 Indian pink (*Spigelia Marylandica*).  
 Calomel (*Hydrargyri chloridum*).  
 Wormwood (*Artemisia Absinthium*).  
 Santonine, the active principle of wormseed (*Artemisia contra*).  
 Cowhage (*Mucuna pruriens*).  
 Powdered tin and glass.

For tape-worm:

Spirit of turpentine (*Spiritus terebinthinæ*).  
 Kouso (*Brayera anthelmintica*).  
 Pomegranate bark (*Punica Granatum*).  
 Leaves and oil of male fern (*Filix mas*).

The *areca nut* was first recommended in this country as a vermifuge about ten years ago, by Major Besant, who had seen it used in India for that purpose. Since that time it has been very generally adopted, and appears to answer the purpose remarkably well, if it is frequently used, and dependence is not placed on a single dose. It should be given every week or ten days, for six or seven times, if the round-worm is present; but two or three doses occasionally given will suffice for the maw-worm. Six or eight hours afterwards, a dose of castor oil should be given. The dose of the



freshly powdered area nut is about two grains to every pound of the dog's weight. Thus a dog of 30 lbs. will take one drachm, or half an average nut. The powder should be merely the nut roughly grated with a coarse "grater;" and it should be quickly mixed with some good broth, thickened with oatmeal, and given before the bitter taste is extracted by soaking, after which the dog will not voluntarily take it.

*Stinking hellebore* is very innocent, and even useful in other ways. The dose for a 30 lbs. dog is five or six grains mixed up with eight or ten of jalap, and formed into a bolus, to be given every five or six days.

*Indian pink* is a very powerful vermifuge; but it also occasionally acts very prejudicially on the dog; and it must never be given without knowing the risk which is incurred. I have myself used it in numberless instances without injury; but its employment has so frequently been followed by fatal results in other hands that I cannot do otherwise than caution my readers against it. How, or why, this has been, I have never been able to ascertain; but, that it is so, I have no doubt whatever. If it is determined to use it, half an ounce of the drug, as purchased, should be infused in half a pint of boiling water; and of this infusion, after straining it, from a table-spoonful to two table-spoonfuls should be given to the dog, according to size, followed by a dose of oil.

*Calomel* is a powerful expellant, but it also is attended with danger. The dose is from three to five grains, mixed with jalap. (See 12, page 346.)

*Wormwood* may be given with advantage to young puppies, being

mild in its operation ; but I do not believe it to be as generally useful as the areca nut. The dose is from ten to thirty grains, in syrup or honey.

*Santonine* is an admirable remedy, when it can be procured in a pure state. The brown is the best, of which from one half to three grains is the dose, mixed with from five to fifteen grains of jalap, and given at intervals of a week.

*Cowhage*, *powdered tin*, and *glass*, all act by their mechanical irritation, and may be given without the slightest fear at any time. The first should be mixed with treacle, and a tea-spoonful or two given occasionally. The second and third are better mixed with butter, the dose being as much as can be heaped upon a shilling.

*Spirit of turpentine* is without doubt the most efficacious of all worm medicines ; but, if not given with care, it is apt to upset the health of the dog, by irritating the mucous membrane of the alimentary canal, and of the kidneys also. I am satisfied, however, that it is not necessary to give it in its undiluted form, and that by mixing it with oil its dangerous qualities are altogether suppressed. I have known young puppies, under two months of age, cleared of worms without the slightest injury, by giving them from three to ten drops, according to their size, in a tea-spoonful of oil. The old plan was to tie up the turpentine in a piece of bladder, which is then to be given as a bolus ; but this is either broken in the throat, causing suffocation by getting into the windpipe, or it is dissolved in the stomach, which is then irritated by the almost caustic nature of the turpentine. The ordinary dose given in this

way is from half a drachm to half an ounce, the latter being only adapted to very strong and full-sized dogs. Certainly it is very useful given in this way, if it does not irritate; but I should prefer the mixture with oil, though it is sometimes rejected from the stomach.

*Kousso*, when employed, should be given entire, first pouring boiling water upon it, and, when cool, adding the juice of half a lemon, which seems to increase its power. Like Indian pink and turpentine, it sometimes acts prejudicially, or even fatally, though it is generally quite innocent. The dose is from two drachms to four, in half a pint of boiling water, which should be repeated two or three times at intervals of a week.

*Pomegranate bark* is an admirable remedy, but it is not often to be obtained genuine, it being little used in this country. The dose is from half an ounce to an ounce of the bark, which, after standing for twenty-four hours in a pint and a half of water, is to be boiled down to one half and filtered. This quantity is then to be divided into three portions, one of which is to be given every half-hour, till the whole is taken.

The *leaves* and *oil of the male fern* are both very efficacious remedies, when obtained in a state of purity, in which there is some difficulty, though the plant is common enough. It should be dug up in the summer, and the top powdered and carefully preserved in stoppered bottles. The dose is from twenty grains to two drachms, made into a bolus, and followed by a jalap purge, or castor oil, in two or three hours. Of the oil, from ten to twenty drops are the dose, mixed up with linseed meal and water, and one

half given at night, the remainder next morning, followed in an hour by a dose of castor oil.

---

#### GENERAL DROPSY (ANASARCA).

*General Dropsy* consists in serum infiltrated into the cellular membrane, beneath the skin of the whole body, as shown by swelling without redness, and "pitting" on the pressure of the finger being removed. The *immediate cause* is to be looked for either in general debility, by which the serum is not absorbed in due course, or from defective action of the kidneys, by which the blood is overcharged with it. More *remotely*, improper stimulants or gross food will produce it, especially in foul and dirty kennels, and in old and worn-out dogs when the liver is deficient in activity. The *treatment* must vary with the *cause*, and it is therefore important that this should be ascertained at once. Thus, in case there is merely general debility, tonics (62) or (63) will be the proper remedies. If the kidneys are in fault, but merely torpid, the diuretic bolus (40) or (41) may be relied on; while, if they have been inflamed, the treatment proper to that disease (see page 415) must be resorted to. Sometimes, in a broken down constitution, when the urine is mixed with blood, small doses of cantharides may be found beneficial, as advised by Mayhew; but these cases are so difficult to distinguish, that it is only when veterinary aid

cannot be obtained that I should advise the use of this drug. The dose is two to three drops in water twice a day.

Tincture of Cantharides, 2 drops.

Spirit of Nitric Ether, 15 drops.

Water, 1 oz.

Mix, and give as a drench twice a day.

## CHAPTER VI.

DISEASES ARISING FROM MISMANAGEMENT OR NEGLECT.

Anæmia.—Rickets.—Indigestion.

## POVERTY OF BLOOD (ANÆMIA).

WHEN puppies are reared in the densely populated parts of our cities, or even in the country where they are crowded together in large numbers, they are weakly in constitution, and their blood is pale, from being deprived of the red particles which fresh air and good food with *sunlight* will alone produce. The feeding has a good deal to do with this, but not so much as the other causes. The *signs* are clear enough, the young dog looking emaciated and delicate and his coat staring, while his lips and tongue are of a pale pink as if washed out. Worms are almost always present, and if so they aggravate the disease tenfold. (See p. 429.) The *treatment* should consist in plenty of fresh air, in the country if possible, admitting the sun on all occasions; together with good nourishing food, composed of the proper proportions of animal and vegetable ingredients. (See page 215.) Generally a total change in these respects will be the best remedy, but sometimes this cannot

be had, and then a combination of quinine and steel may be used as an internal medicine. Thus,

Sulphate of quinine,  
Sulphate of iron, of each 1 grain.  
Extract of dandelion, 3 grains.

Mix, and give 3 times a day.

If worms are present they must of course be got rid of. (See page 429.)

---

#### RICKETS AND ENLARGED JOINTS.

By *Rickets* is understood a soft and weak condition of the bones, in which the lime is deficient; and, the gelatine comprising their framework having no proper support, they bend in any direction which the superincumbent weight may give them. Hence we so often see puppies which are confined to their kennels with bandy legs, which is usually the first sign of rickets. Sometimes the shins bend forward, producing what is called the "buck-shin," but whether the legs bow outwards or forwards the cause is the same. The *remedy* for this is to be looked for in country air, exercise, and good food; but the quinine and steel pills, ordered for poverty of blood, will also be of service here.

*Enlarged Joints* may be merely a sign of excessive vigour in the formation of bone, as is sometimes seen in the early puppyhood of

the greyhound, the mastiff, and other large dogs, between three and nine months old, when the knees and hocks will strike the eye as out of all character with the rest of the frame. Here, so long as the legs are not bent out of shape, and there is no lameness, the breeder need feel no anxiety, as in course of time the enlargement of the joints subsides, leaving only what is particularly desired, namely, large bony and strong joints, without any malformation. It is extraordinary to what an extent this bony development sometimes goes, especially in young dogs, bitches seldom showing the same amount of it. Inexperienced breeders are often sadly puzzled to know whether such puppies are worth rearing, and I have often saved the lives of valuable animals, which had been condemned as diseased, but which ultimately turned out to be all that could be wished. When, therefore, such a state of things exists, let the patience of the owner be exercised till the ninth or tenth month, or sometimes still longer, and, if about this time the limbs do not grow into shape, it will be quite early enough to consider what is to be done. But, again, there is to be met with a scrofulous enlargement of the joints which is seldom got rid of; but this occurs in delicate puppies, and not in the large overgrown animals which are the subjects of the mere "big joints" above described. There is a puffy and soft feeling communicated to the hand on examining the leg, and usually there is a tenderness on pressure, together with more or less lameness in walking or running. This scrofulous enlargement may occur in the knees, hocks, or stifles, but the last-named joints are most usually the seats of the disease. Sometimes nature rallies and throws off this tendency



to serofula, but more frequently the joints become larger and larger, the lameness increases, and, in most cases, some one joint being worse than the others inflames and forms matter within it, when nothing is to be done but to consign the poor animal to the halter or the river.

#### INDIGESTION (DYSPEPSIA).

Among the most common consequences of improper feeding and neglect of exercise is indigestion, attended by its usual concomitant, constipation. (See page 414.) It shows itself in flatulence, loss of appetite, alternations of constipation and diarrhœa, low spirits, and want of muscular vigour; although often the animal is fat enough, or, indeed, sometimes loaded with fat (adipose matter). Such a state of things never occurs to a dog properly reared and afterwards well managed, being confined to those which are either fed on improper food, or allowed too much of it, or which are not allowed exercise enough; or, as is too frequently the case, which are submitted to all three of these causes. The *treatment* is simple enough, it being only necessary, except in very old-standing cases, to adopt the proper rules for feeding, exercise, &c., which are laid down at page 199 et seq., and nature asserts her supremacy, rapidly getting the victory over disease. In no animal are the ups and downs so rapid as in the dog, who gets fat and lean in a

week; and certainly there are few which will bear with impunity the liberties which are taken with him. If moderate starvation (sometimes, at first, entire, in order to make the pampered dog take food which is fit for him) does not soon restore the stomach, care must be taken that the liver is acting properly, the *faeces* being watched to see if they are of a proper colour; and, if not, small doses of calomel or blue pill will be required: (1), (2), or (13). If, on the contrary, the liver acts properly, yet the stomach is out of order, recourse may be had to the stomachic bolus (59), or the draught (60), which will very seldom fail, if aided by proper management. It should, however, never be forgotten, that medicine is of no use, unless, at the same time, the diet is attended to, and sufficient exercise given. In cases of indigestion it is particularly necessary to change the food every third or fourth day, for the stomach is often so fitful that what will agree with it once or twice will afterwards be almost sure to disagree.

## CHAPTER VII.

## DISEASES AND ACCIDENTS REQUIRING SURGICAL AID.

Tumours.—Cancer.—Encysted Tumours.—Abscesses.—Unnatural Parturition.—Accidents and Operations.

## TUMOURS.

*BRONCHOCELE*, or *Goitre*, is very common among house pets, showing itself in a large and rather soft swelling in the front of the throat. It is not attended with danger ; and even in extreme cases, when it affects the breathing so as to cause it to be short and even attended with noise, it very rarely goes on to produce suffocation. It is called, scientifically, an *hypertrophy* of the thyroid body, being an excessive and unnatural growth of the part, and not a new or diseased production. The *treatment* consists in rubbing in iodine outwardly ; and, if this fails, giving it internally also. The internal remedy may be according to the formula (3) ; but, if the expense is objected to, the sarsaparilla may be omitted. The ointment is as follows :

Iodide of potassium, 1 drachm.

Lard, 1 ounce.

Mix, and rub in the size of a filbert, night and morning.

Or,

Paint over the surface some tincture of iodine twice a week.

## CANCER.

*Cancer* is a malignant disease; that is, it is incapable of a cure by the natural powers, and must be eradicated either by the knife or by caustic. It is, however, very doubtful whether by their means the disease is checked for any length of time, generally returning afterwards in the course of a few months. The disease may be known in the early stage by the appearance of a hard lump, varying in size from that of a filbert to a large walnut or common egg, with an irregular "knotty" feel and a strange hardness. In process of time this enlarges, and the skin adheres to it, by and by ulcerating, and a red fungous growth making its appearance. There are various forms in which the open cancer shows itself, sometimes red and smooth, at others very "knotty" and purple, while a third variety resembles curdy matter mixed with streaks of blood. The most common seats of cancer in the dog are, the teats or womb in the bitch, and the penis in the dog. I have several times seen a cancerous condition of the womb and vagina cause such constant irritation that the bitch always appeared to be at heat, and would take the dog at any time, but without breeding, to the great astonishment and annoyance of the owner, who is unable to account for this repeated "heat," as he considers it. A cancer is *incurable*; the knife is the only remedy, but it should be used by hands accustomed to operations, and practice with previous demonstrations

is all important. When, therefore, a cancer is to be removed, a veterinary surgeon should at once be called in.

---

#### ENCYSTED TUMOURS.

*Encysted tumours* are sacs or bags of various sizes, which occur just beneath the skin, and contain a thick, glairy, and transparent fluid resembling white of egg. They are readily known by their soft yielding feel, and by their evident want of connexion with the surrounding parts. Nothing but the knife is of the slightest use, and, by cutting through them, the sac may readily be torn out, each half at a time, taking care not to leave a particle behind, as it is sure to grow again into another sac of the same size as before.

---

#### ABSCESSSES.

*Abscesses*, the result of inflammation, are very common in the dog, and show themselves in the early stage as hard painful swellings more or less deep, but gradually coming to the surface, when the skin reddens, and they burst of themselves in the course of time. Very often, however, the matter forms so slowly, and has such a tendency to burrow among the muscles, that, if it is not let out by the knife in the early stage, it produces great exhaustion from the quantity formed. Matter may be detected as

soon as it is thrown out, by the sensation given to the fingers of each hand called "fluctuation;" that is to say, on pressing one side of the swelling with the left hand, the other side rises beneath the fingers of the right, in an elastic way, just as happens with a water-pillow, when pressure is made upon it. When, therefore, this fluctuation is clearly made out, a lancet or knife should be inserted, and made to cut its way out, so as to leave a considerable opening, which should be so arranged as to let the matter drain out at all times. This is what in surgery is called a "depending" opening, the opposite plan allowing the matter to remain in the abscess, which cannot therefore heal, because its walls are separated, and the consequence is that a *sinus* forms, which gives infinite trouble to get it well. Should this sinus be established, the only plan is, either to lay it open by slitting it up with a narrow knife, or by passing a probe or other similar smooth body to the end, cutting down upon it, and then inserting a few threads or a piece of tape, convert it into a seton, which will either eat its way out, or after a time the threads may be withdrawn and the sides unite.

---

#### UNNATURAL PARTURITION.

I have alluded to the management of healthy parturition at page 196, but in this chapter I must say something of the proper conduct to be observed where the process is disturbed by any

accidental complication. As, however, these unnatural labours only occur in any number to the veterinary practitioner, I shall take the liberty of inserting here Mr. Youatt's remarks on the subject, which I believe to be truthful throughout:—

“The pupping usually takes place from the sixty-second to the sixty-fourth day; and, the process having commenced, from a quarter to three quarters of an hour generally takes place between the production of each puppy.

“Great numbers of bitches are lost every year in the act of parturition: there seems to be a propensity in the females to associate with dogs larger than themselves, and they pay for it with their lives. The most neglected circumstance during the period of pregnancy is the little exercise which the mother is permitted to take, while, in point of fact, nothing tends more to safe and easy parturition than her being permitted or compelled to take a fair quantity of exercise.

“When the time of parturition has arrived, and there is evident difficulty in producing the fœtus, recourse should be had to the ergot of rye, which should be given every hour or half-hour, according to circumstances. If after a certain time some, although little, progress has been made, the ergot must be continued in smaller doses, or perhaps suspended for a while; but, if all progress is evidently suspended, recourse must be had to the hook or the forceps. By gentle but continued manipulation much may be done, especially when the muzzle of the puppy can be brought into the passage. As little force as possible

must be used, and especially the fœtus little broken. Many a valuable animal is destroyed by the undue application of force.

“If the animal seems to be losing strength, a small quantity of laudanum and ether may be administered. ‘The patience of bitches in labour is extreme,’ says Mr. Blaine; ‘and their distress, if not removed, is most striking and affecting. Their look is at such time particularly expressive and apparently imploring.’ When the pupping is protracted, and the young ones are evidently dead, the mother may be saved, if none of the puppies have been broken. In process of time the different puppies may, one after another, be extracted; but when violence has been used at the commencement, or almost at any part of the process, death will assuredly follow.

“*June 15, 1832.*—A spaniel bitch was brought to my infirmary to-day who has been in great and constant pain since yesterday, making repeated but fruitless efforts to expel her puppies. She is in a very plethoric habit of body; her bowels are much confined, and she exhibits some general symptoms of febrile derangement, arising, doubtless, from her protracted labour. This is her first litter. Upon examination no young could be distinctly felt.

“Place her in a warm bath, and give her a dose of castor oil, morning and evening.

“*June 16.*—The bitch appears in the same state as yesterday, except that the medicine has operated freely upon the bowels, and the febrile symptoms have somewhat decreased. Her strainings



are as frequent and distressing as ever. Take two scruples of the ergot of rye, and divide into six doses, of which let one be given every half-hour.

“In about ten minutes after the exhibition of the last dose of this medicine, she brought forth with great difficulty one dead puppy; upon taking which away from her, she became so uneasy that I was induced to return it to her. In about a quarter of an hour after this I paid her another visit; the puppy could not now be found; but a suspicious appearance in the mother’s eye betrayed at once that she had devoured it. I immediately administered an emetic; and in a very short time the whole fœtus was returned in five distinct parts, viz. the four quarters and the head. After this, the bitch began to amend very fast; she produced no other puppy; and, as her supply of milk was small, she was soon convalescent.

“Twelve months afterwards she was again taken in labour, about eleven o’clock in the morning, and after very great difficulty one puppy was produced. After this the bitch appeared in great pain, but did not succeed in expelling another fœtus, in consequence of which I was sent for about three o’clock P. M. I found her very uneasy, breathing laboriously; the mouth hot, and the bowels costive; but I could not discover any trace of another fœtus. She was put into a warm bath, and a dose of opening medicine was administered.

“About five o’clock she got rid of one dead and two living puppies.

“*2<sup>nd</sup>*. She is still very ill; she evinces great pain when pressed upon the abdomen; and it is manifest that she has another fœtus

within her. I ordered a dose of the ergot, and in about twenty minutes a large puppy was produced, nearly dying. She survived with due care.

“I cannot refrain from inserting the following case at considerable length:—

“*Sept. 4th, 1820.*—A very diminutive terrier, weighing not 5 lbs., was sent to my hospital in order to lie in. She was already restless and panting. About eight o'clock at night the labour pains commenced; but until eleven scarcely any progress was made. The *os uteri* would not admit my finger, although I frequently attempted it.

“At half-past eleven, the membranes began to protrude; at one the head had descended into the pelvis and the puppy was dead. In a previous labour she had been unable to produce her young, although the ergot of rye had been freely used. I was obliged to use considerable force, and she fought terribly with me throughout the whole process. At half-past one, and after applying considerable force, I brought away a large fœtus, compared with her own size. On passing my finger as high as possible, I felt another fœtus living, but the night passed and the whole of the following day, and she ate and drank, and did not appear to be much injured.

“Several times in the day I gave her some strong soup and the ergot. Some slight pains now returned, and by pressing on the belly the nose of the fœtus was brought to the superior edge of the pelvis. The pains again ceased, the pudenda began to swell from frequent examination, the bitch began to stagger, and made fre-

quent attempts to void her urine: with extreme difficulty in accomplishing it. I now resorted to the crotchet; and after many unsuccessful attempts, in which the superior part of the vagina must have been considerably bruised, I fixed it sufficiently firmly to draw the head into the cavity of the pelvis. Here for a while the shoulder resisted every attempt which I could make without the danger of detruncating the fœtus. At length by working at the side of the head until my nails were soft and my fingers sore, I extracted one fore leg. The other was soon brought down; another large puppy was produced, but destroyed by the means necessary for its production. This was the fruit of two hours' hard work.

“She was completely exhausted, and scarcely able to stand. When placed on the ground she staggered and fell at almost every step. Her efforts to void her urine were frequent and ineffectual.

“At four o'clock I again examined her; the external pudenda were sore and swelled, and beginning to assume a black hue. It was with considerable difficulty that I could introduce my finger. A third fœtus irregularly presented was detected. I could just feel one of the hind legs. No time was to be lost. I introduced a small pair of forceps by the side of my finger, and succeeded in laying hold of the leg without much difficulty, and, with two or three weak efforts from the mother,—I could scarcely call them pains,—I brought the leg down until it was in the cavity of the pelvis. I solicited it forward with my finger, and, by forcibly pressing back the *labia pudendi*, I could just grasp it with the finger

and thumb of the right hand. Holding it there, I introduced the finger of the right hand, and continued to get down the other leg, and then found little difficulty until the head was brought to the superior edge of the pelvis. After a long interval, and with considerable force, this was brought into the pelvis, and another puppy extracted. This fully occupied two hours.

“The bitch now appeared almost lifeless. As she was unable to stand, and seemed unconscious of everything around her, I concluded that she was lost: I gave her one or two drops of warm brandy and water, covered her up closely, and put her to bed.

“To my surprise, on the following morning, she was curled round in her basket; she licked my hands, and ate a bit of bread and butter; but when put on her legs staggered and fell. The pudendum was dreadfully swollen, and literally black. In the afternoon she again took a little food: she came voluntarily from her basket, wagged her tail when spoken to, and on the following day she was taken in her basket a journey of seventy miles, and afterwards did well. No one could be more rejoiced than was her master, who was present at, and superintended, the greater part of the proceedings.

“*The beneficial effect of Ergot of Rye in difficult Parturition.*—The following case is from the pen of Professor Dick:—

“On the 10th instant, a pointer bitch produced two puppies; and it was thought by the person having her in charge that she had no more. She was put into a comfortable box, and with a little care was expected to do well. On the next morning, how-

ever, she was sick and breathed heavily, and continued rather uneasy all the day.

‘On the forenoon of the following day I was requested to see her. I found her with her nose dry, breath hot, respiration frequent, mouth hot and parched, coat staring, back roached, pulse 120, and a black fetid discharge from the vagina. Pressure on the abdomen gave pain. A pup could be obscurely felt; the secretion of milk was suppressed, and the skin had lost its natural elasticity.

‘Tepid water with a little soap dissolved in it was immediately injected into the uterus, which in a considerable degree excited its action; and this injection was repeated two or three times with the same effect.

‘After waiting for half an hour, the fœtus was not discharged nor brought forward; therefore a scruple of the ergot of rye was then made into an infusion with two ounces of water, and one third of it given as a dose; in half an hour another one third of it; the injections of warm water and soap being also continued. Soon after the second dose of the infusion, a dead puppy was expelled; the bitch rapidly recovered, and, with the exception of deficiency of milk, is now quite well.

‘This case would seem to prove the great power of the ergot of rye over the uterus; but, until more experiments are made, it is necessary to be cautious in ascribing powers to medicines which have not been much tried in our practice. It is not improbable that the warm water and soap might have roused the uterus into action without the aid of the ergot; and it is therefore necessary

that those who repeat this experiment should try the effects of the medicine unaided by the auxiliary.'

"The Professor adds, that the great power which this drug is said to have on the human being, and the apparent effect in the case just given, suggest the propriety of instituting a further trial of it, and of our extending our observations to cattle, amongst which difficult cases of calving so frequently occur.

"Mr Simpson thus concludes some remarks on ergot in difficult parturition. 'This medicine possesses a very great power over the uterus, rousing its dormant or debilitated contractility, and stimulating it to an extra performance of this necessary function after its natural energy has been in some measure destroyed by forcible but useless action. The direct utility of the ergot was manifested in cases where the uterus appeared quite exhausted by its repeated efforts; and certainly it is but fair to ascribe the decidedly augmented power of the organ to the stimulus of the ergot, for no other means were resorted to in order to procure the desired effect. Its action, too, is prompt. Within ten minutes of the administration of a second or third dose, when nature has been nearly exhausted, the parturition has been safely effected.'

"*Puerperal Fits.*—Nature proportions the power and resources of the mother to the wants of her offspring. In her wild undomesticated state she is able to suckle her progeny to the full time; but, in the artificial state in which we have placed her, we shorten the interval between each period of parturition, we increase the number of her young ones at each birth, we diminish her natural powers of affording them nutriment, and we give her a degree of

irritability which renders her whole system liable to be excited and deranged by causes that would otherwise be harmless : therefore it happens that, when the petted bitch is permitted to suckle the whole of her litter, her supply of nutriment soon becomes exhausted, and the continued drain upon her produces a great degree of irritability. She gets rapidly thin ; she staggers, is half-unconscious, neglects her puppies, and suddenly falls into a fit of a very peculiar character. It begins with, and is sometimes confined to, the respiratory apparatus : she lies on her side and pants violently, and the sound of her laboured breathing may be heard at the distance of twenty yards. Sometimes spasms steal over her limbs ; at other times the diaphragm and respiratory muscles alone are convulsed. In a few hours she is certainly lost ; or, if there are moments of remission, they are speedily succeeded by increased heavings.

“The practitioner unaccustomed to this fearful state of excitation, and forgetful or unaware of its cause, proceeds to bleed her, and he seals her fate. Although one system is thus convulsively labouring, it is because others are suddenly and perfectly exhausted ; and by abstraction of the vital current he reduces this last hold of life to the helpless condition of the rest. There is not a more common or fatal error than this.

“The veterinary practitioner is unable to apply the tepid bath to his larger patients, in order to quiet the erethism of certain parts of the system, and produce an equable diffusion of nervous influence and action ; and he often forgets it when he has it in his power to save the smaller ones. Let the bitch in a fit be put into

a bath, temperature 96° of Fahrenheit, and covered with the water, her head excepted. It will be surprising to see how soon the simple application of this equable temperament will quiet down the erethism of the excited system. In ten minutes, or a quarter of an hour, she may be taken out of the bath evidently relieved, and then, a hasty and not very accurate drying having taken place, she is wrapped in a blanket and placed in some warm situation, a good dose of physic having been previously administered. She soon breaks out in a profuse perspiration. Everything becomes gradually quiet, and she falls into a deep and long sleep, and at length awakes somewhat weak, but to a certain degree restored.

“ If, then, all her puppies except one or two are taken from her, and her food is, for a day or two, somewhat restricted, and after that given again of its usual quantity and kind, she will live and do well; but a bleeding at the time of her fit, or suffering all her puppies to return to her, will inevitably destroy her.

“ A bitch that was often brought to my house was suckling a litter of puppies. She was foolishly taken up and thrown into the Serpentine in the month of April. The suppression of milk was immediate and complete. There was also a determination to the head, and attacks resembling epilepsy. The puppies that were suffered to remain with the mother, were very soon as epileptic as she was, and were destroyed. A seton was inserted on each side of her neck. Ipecacuanha was administered; and, that having sufficiently worked, a small quantity of diluted sulphuric acid was given. A fortnight afterwards she was perfectly well.



“*Inversion of the uterus in a Bull bitch after pupping. Extirpation and cure.* By M. Cross, M. V., Milan.—‘In July, 1829, I was desired to attend a small bull bitch six years old, and who had had puppies four times. The uterus was completely inverted, and rested all its weight on the vaginal orifice of the urethra, preventing the discharge of the urine, and thus being the cause of great pain when the animal endeavoured to void it, or the fecal matter. The uterus was become of almost a black colour, swelled, softened, and exhaling an insupportable odour. Judging from this that the preservation of the uterus was impossible, and reckoning much on the good constitution of the patient, I warned the proprietor of the danger of its reduction, even supposing that it was practicable, and proposed to him the complete extirpation of the uterus as the only means that remained of saving the bitch.

‘Armed with his consent, I passed a ligature round the neck of the uterus, at the bottom of the vagina, and drew it as tight as I possibly could. On the following day I again tightened the ligature, in order to complete the mortification of the part, and the separation of the womb. On the third day I extirpated the womb entirely, close to the haunch. There was very slight loss of blood, but there ran from the walls of the vagina a small quantity of ichorous fluid, with a strong fetid smell. The operation was scarcely completed ere she voided a considerable quantity of urine, and then searched about for something to eat and to drink.

‘The portion of the uterus that was removed weighed fourteen ounces. The mucous membrane by which it was lined was in a highly disorganized state. From time to time injections of a

slight infusion of aromatic plants were introduced into the vagina, and the animal was nourished with liquid food of easy digestion.

‘The first day passed without the animal being in the slightest degree affected; but on the following day, in despite of all our care, an ichorous fluid was discharged, which the dog would lick notwithstanding all our efforts to prevent it. The general health of the animal did not seem to be in the slightest degree affected. We continued our aromatic infusion and our regimen.

‘On the fourth day after the operation, the cords that had served as a ligature fell off, and all suppuration from the part gradually ceased.

‘*October 20th.*—Three months have passed since the operation, and she is perfectly well.’—*Youatt on the Dog*, pp. 225—230.

---

#### ACCIDENTS AND OPERATIONS.

*Cuts, tears, and bites*, unless they are very extensive, and are therefore likely to occupy a long time in healing, are better left to themselves, the dog's tongue being the best healing remedy. But when a V-shaped flap is torn down, or a very long and straight cut or tear is accidentally made, a few stitches should be put in with a proper curved needle armed with strong thread or silk. It is only necessary to introduce the needle in two places on exactly opposite sides, and then, an assistant drawing the skin together, the ends are tied in a common knot, and cut off closely. When, however, this plan is adopted, a muzzle must be worn as long as

the stitches are kept in, because the dog never rests satisfied till he has licked the knots open, or in some way with his teeth and tongue has got rid of them. Wounds in the dog do not heal "by the first intention," that is, in three or four days, as in man, but fill up by what is called granulation. Of course, in long wounds, more than one stitch is required, but, as perfect union never can be effected by adhesion, the attempt to bring the edges carefully together is a failure; and, provided that anything like an approach to this is effected, all is done by a few stitches at short distances which can be desired. A bandage may be put on afterwards and kept on for three days, after which it must be changed daily, still keeping on the muzzle. When the red granulations rise above the level of the skin, called *then* "proud flesh," a piece of blue-stone should be rubbed on them daily, or often enough to keep them down to the proper level. When below the level of the skin, they never require caustic of any kind.

*In any cuts about the legs or feet*, the parts may be protected by collodion painted on rapidly with a camel-hair brush, and allowed to dry; but a very little friction removes it. Canada balsam, spread on white leather and warmed, will keep its place well enough to bear the rubs of a course in the greyhound, and is, I believe, the best application. A leathern boot may be made to fit the pointer's or setter's foot, or indeed that of any dog which requires protection during work. It should be made of two pieces of leather, one considerably larger than the other, and the large one set into the small with a puckered or full edge. This, when firmly tied or stitched round the ankle, just below the

knee, will resist all the efforts of the dog to get it off, and may be worn without a muzzle for weeks, taking care to remove it occasionally in order to cleanse the wound. In this way I have obtained the healing of cuts in the ball of the foot in a week or two, without stopping exercise a single day, whereas, without a boot, the dog would have been lame, and it would take months to heal the wound without resting the dog.

*Fractures* may occur in any of the bones of the dog, but excepting in the legs or ribs little relief can be afforded by art. They are detected by the deformity which is seen in the part, an angle being presented in the interval between two joints, when occurring in the limb, and a *crepitus* or crackling being heard and felt on handling the part. When the ribs have been broken, the injury is easily detected by the depression which is felt, and the grating sound often produced in breathing. In this case a flannel bandage may be bound tightly round the chest, and the dog, after being bled, should be kept quiet, and fed on low diet. A horse-girth passed twice or thrice round and buckled answers the purpose pretty well, but is not equal to a well-applied bandage. *Fractures of the limbs* may be set by extending the broken ends, and then carefully applying wooden or gutta percha splints lined with two or three thicknesses of coarse flannel; they are bound round with tapes and tied, and kept on till the end of three weeks or a month, re-applying them if necessary. This, however, requires some practical experience to perform properly. If there is much local injury, it is better to apply the splints very loosely for the

first week, keeping the whole wrapped in folds of linen dipped in the lotion (53). In all cases the dog must be strictly kept to his kennel, and the limbs should not be strained by allowing him to jump up and down on a bench, a low bed being provided. In five or six weeks the thigh or hind leg is united, and the fore leg in three weeks or a month.

*Dislocations* occur in the shoulder and elbow very rarely, in the knee and toes commonly, in the hip very often, in the stifle occasionally, and in the hock very seldom, except in connexion with fracture. In all cases, they are detected by the deformity occurring in any of these joints, which is not capable of restoration by gentle handling, and is not accompanied by the *crepitus* which marks the fracture. *To reduce a dislocation*, two persons must lay firm hold of the two parts of the limb on each side of the injured joint, and then extending them strongly, the head of the bone in slight and recent cases will be felt to slip into the socket. It is only, however, in the knee, that any inexperienced operator is likely to succeed, for in the hip, which is the most common seat of dislocation, great tact and knowledge of the anatomy of the part are required to effect a cure. Here the head of the bone may be removed from the socket in three different directions, namely, either forwards, upwards, or backwards, and the pull must be in the direction of the socket, or it will do harm rather than good. At the same time while an assistant is making the extension, the operator himself, with his hand or a towel, lifts the thigh from the body, with the view of raising the head of the bone

over the edge of the cup, into which it is his object to conduct it. Chloroform should always be given during the operation, if the attempt is not immediately successful when made directly after the accident, inasmuch as it relaxes the muscles in a remarkable manner, and enables the operator to proceed without being counteracted by the struggles of the dog. Dislocated toes are sometimes reduced directly after the accident occurs, but they are very apt to return to their deformed condition immediately, and a small splint should be bound on at once. In dislocations of the knee, also, a bandage should be applied, so as to keep the joint slightly bent, and prevent the foot from being put to the ground.

The *operations* which are likely to be practised on the dog are somewhat numerous, but the only ones fit to be attempted by any but the professed veterinarian are bleeding, the insertion of a seton, and the closing of wounds by the ligature.

*Bleeding* is effected with a common lancet in the neck vein. The hair is cut off in a small patch close to the wind-pipe; then, tying a string tightly round the neck, the vein will be felt to rise on the side next the head, and then the lancet must be introduced with some little force, cutting out again so as to make the opening large enough *inside* to allow of the blood escaping. When enough blood has been taken, the string is taken off, a pin is introduced through and across the lips of the wound, and some tow or thread wound round the ends; after which the point is cut off, and the whole is left for three or four days, when the pin may be safely withdrawn, leaving

the tow to fall off. If the neck is too fat, a vein on the inside of the fore arm may be opened. *To insert a seton*, all that is necessary is to take any large needle with an eye (a seton needle is made on purpose), then, lifting up a fold of skin, a knife or lancet is passed through it, and on its withdrawal the needle armed with the tape follows, after which the two ends of the tape are tied with a common knot, and in that way it is securely kept in. In bad cases of brain mischief, when there is a necessity for immediate relief by counter-irritation, a small red-hot poker is passed through the opening made by the knife before the introduction of the tape, which need not then be covered with blistering ointment, as is required in ordinary cases. The closing of wounds, and the application of the muzzle, have been already described.

THE END.

## BOOKS ON RURAL SPORTS AND NATURAL HISTORY.

---

- The Greyhound.** By STONEHENGE, Author of 'The Dog in Health and Disease.' Revised Edition, with 24 Portraits of Greyhounds. Square crown 8vo, price 10s. 6*l.*
- The Setter;** with Notices of the most Eminent Breeds now extant, Instructions how to Breed, Rear, and Break; Dog Shows, Field Trials, General Management, &c. By EDWARD LAVERACK. With Two Illustrations in Chromolithography. Crown 4to, price 7s. 6*l.*
- A Treatise on Horse-shoeing and Lameness.** By JOSEPH GAMGEE, Veterinary Surgeon, formerly Lecturer on the Principles and Practice of Farriery in the New Veterinary College, Edinburgh. 8vo, with 55 Woodcuts, 15s.
- Blaine's Veterinary Art:** a Treatise on the Anatomy, Physiology, and Curative Treatment of the Diseases of the Horse, Neat Cattle, and Sheep. Seventh Edition, revised and enlarged by C. STEEL. 8vo, with Plates and Woodcuts, 18s.
- Youatt on the Horse.** Revised and enlarged by W. WATSON, M.R.C.V.S. 8vo, with numerous Woodcuts, 12s. 6*l.*
- Youatt on the Dog.** By the same Author. 8vo, with numerous Woodcuts, 6s.
- The Horse's Foot, and how to keep it Sound.** By W. MILES, Esq. Ninth Edition, with Illustrations. Imp. 8vo, 12s. 6*l.*
- A Plain Treatise on Horse-shoeing.** By the same Author. Sixth Edition, post 8vo, with Illustrations, 2s. 6*l.*
- Stables and Stable Fittings.** By the same. Imp. 8vo, with 13 Plates, 15s.
- Remarks on Horses' Teeth,** addressed to Purchasers. By the same. Post 8vo, 1s. 6*l.*
- Encyclopædia of Rural Sports;** a Complete Account, Historical, Practical, and Descriptive, of Hunting, Shooting, Fishing, Racing, &c. By D. P. BLAINE. With above 600 Woodcuts (20 from Designs by JOHN LEECH). 8vo, 21s.
- The Dead Shot,** or Sportsman's Complete Guide; a Treatise on the Use of the Gun, Dog-breaking, Pigeon-shooting, &c. By MARKSMAN. Fcp., with Plates, 5s.
- A Book on Angling:** being a Complete Treatise on the Art of Angling in every branch, including full Illustrated Lists of Salmon Flies. By FRANCIS FRANCIS. New Edition, with Portrait and 15 other Plates, plain and coloured. Post 8vo, 15s.

---

LONDON: LONGMANS AND CO.



## BOOKS ON RURAL SPORTS AND NATURAL HISTORY.

---

- Wilcock's Sea-Fisherman**: comprising the Chief Methods of Hook and Line Fishing in the British and other Seas, a glance at Nets, and remarks on Boats and Boating. Second Edition, enlarged, with 80 Woodcuts. Post 8vo, 12s. 6d.
- The Fly-Fisher's Entomology**. By ALFRED RONALDS. With coloured Representations of the Natural and Artificial Insect. Sixth Edition, with 20 coloured Plates. 8vo, 14s.
- The Book of the Roach**. By GREVILLE FENNEL, of 'The Field.' Fcp. 8vo, price 2s. 6d.
- Horses and Stables**. By Colonel F. FITZWYGRAM, XV. the King's Hussars. With 24 Plates of Woodcut Illustrations, containing very numerous Figures. 8vo, 15s.
- The Ox**, his Diseases and their Treatment; with an Essay on Parturition in the Cow. By J. R. DOBSON, M.R.C.V.S. Crown 8vo, with Illustrations, 7s. 6d.
- Insects at Home**; a Popular Account of British Insects, their Structure, Habits, and Transformations. By the Rev. J. G. WOOD, M.A., F.L.S. With upwards of 700 Illustrations engraved on Wood, 1 coloured and 21 full size of page. 8vo, 21s.
- Homes without Hands**; a Description of the Habitations of Animals classed according to their Principle of Construction. By Rev. J. G. WOOD, M.A., F.L.S. With about 140 Vignettes on Wood. 8vo, 21s.
- Strange Dwellings**; a Description of the Habitations of Animals, abridged from 'Homes without Hands.' By J. G. WOOD, M.A., F.L.S. With a New Frontispiece and about 60 other Woodcut Illustrations. Crown 8vo, 7s. 6d.
- Bible Animals**; a Description of every Living Creature mentioned in the Scriptures, from the Ape to the Coral. By the Rev. J. G. WOOD, M.A., F.L.S. With about 100 Vignettes on Wood. 8vo, 21s.
- The Harmonies of Nature and Unity of Creation**. By Dr. G. HARTWIG. 8vo, with numerous Illustrations, 18s.
- The Sea and its Living Wonders**. By the same Author. Third Edition, enlarged. 8vo, with many Illustrations, 21s.
- The Tropical World**. By the same Author. With 8 Chromoxylographs and 172 Woodcuts. 8vo, 21s.
- The Subterranean World**. By the same Author. With 3 Maps and about 80 Woodcut Illustrations, including 8 full size of page. 8vo, 21s.
- The Polar World**: a Popular Description of Man and Nature in the Arctic and Antarctic Regions of the Globe. By the same Author. With 8 Chromoxylographs, 3 Maps, and 85 Woodcuts. 8vo, 21s.

---

LONDON: LONGMANS AND CO.







