

Historic, archived document

Do not assume content reflects current scientific knowledge, policies, or practices.



LIBRARY
RECEIVED
NOV 11 1909
U. S. Department of Agriculture

LIBRARY
U. S. Department of Agriculture
Washington, D. C.

DREER'S

AUTUMN CATALOGUE

OF

BULBS
PLANTS
SEEDS ETC.

FOR

AUTUMN PLANTING

1909

HENRY A. DREER
714 CHESTNUT ST.
PHILADELPHIA PA.

Gesneriades

Le Reve

La Merveille

General Directions to Customers.

PHILADELPHIA, September, 1909.



The attention of our customers is respectfully called to the following directions, which will, if followed, be an aid to purchasers as well as to ourselves.

ORDER EARLY.—It will greatly facilitate shipments if orders are *sent early*. We aim to send off all orders the same or next day after receipt, but during the busy season this is nearly impossible—hence the advisability of ordering early.

TIME OF SHIPMENT.—The majority of Fall Bulbs are ready to ship by the second week in September; a few sorts, which are noted in Catalogue, do not mature until October and November. *Unless otherwise instructed, we will send the early bulbs as soon as ready, and the late-maturing sorts when in good condition to ship.*

FORWARDING.—We deliver, postage paid, to any post-office in the United States, Bulbs, Vegetable and Flower Seeds in packets, ounces and pounds, at catalogue prices, except where otherwise noted; but it will be much cheaper to the purchaser if goods are ordered to be sent by express or freight at their expense when desired in any quantity. Agricultural Seeds, Implements and other bulky and heavy goods can only be sent by freight or express at purchaser's expense.

PLANTS.—Small plants can be sent by mail if so desired, but we strongly advise our customers to have their plants sent by express at their expense, as larger and finer plants can be sent in this way, and "extras" are added to help defray charges, and we always ship in this way unless instructed to the contrary. Heavy plants, such as Azaleas, Camellias, Shrubs and similar large stock, cannot be sent by mail. *Seeds, Plants and Bulbs are now taken by the Express Companies at a reduction of twenty per cent. from the regular rates for merchandise.*

CANADA POSTAGE.—Vegetable and Flower Seeds in packets and ounces mailed without extra cost. On everything else remit double the amount of postage required for delivery in U. S.

LOCAL DELIVERY.—We deliver goods free in Philadelphia, Germantown and Chestnut Hill. We also deliver free of charge by Package System (Baggage Master) to all points where this system is in operation, such goods as will be received by them.

PACKING.—No charge is made for boxes or packing, nor for Delivery to Freight Depots or Express Offices in Philadelphia.

REMITTANCES should be made by Post-office Money Order, Drafts on Philadelphia or New York Banks, or Express Money Orders. We disclaim all responsibility when remittances are not made as above directed. Where it is not possible to obtain these, the letter should be registered. Postage stamps will be found a convenient method of remitting for small amounts, and can be used by us to advantage. Coin should not be sent by mail.

CASH WITH ORDER.—Please send money with the order sufficient to cover the whole bill. We decline sending goods "Collect on Delivery" unless remittance be made on account to guarantee acceptance.

ERRORS.—We exercise the utmost care in filling orders, striving to do a little more than we offer; yet in the press of business errors sometimes occur, in which event we wish to be promptly notified of the fact, and will make such corrections as will be satisfactory. Please keep copies of all your orders for comparison.

SAFE ARRIVAL OF PACKAGES.—We endeavor to secure the safe arrival of packages of Seeds, Bulbs and Plants in good condition in every case. If a package is injured or lost by express, we will replace it as soon as informed of the fact. Frequently it happens that orders never reach us, or are without signature. When customers fail to receive their packages in a reasonable time they should inform us, and at the same time send a copy of their order and any other information necessary to trace the goods. Complaints must be made on receipt of goods.

NAME AND ADDRESS.—Please remember to write your **NAME, POST-OFFICE, COUNTY** and **STATE**; also give number of street or P. O. Box as distinctly as possible; also the **NEAREST EXPRESS OFFICE**, or, if on a stage route, send us special directions, giving us the name of the Express Company delivering goods.

CORRESPONDENCE.—We try to give prompt attention to all proper letters of inquiry, etc. We ask, as a favor, that all questions be stated clearly and briefly, and not on order sheets.

NON-WARRANTY.—Most of the failures with seeds, plants and bulbs are due to causes entirely beyond our control, such as unfavorable weather and soil conditions, too deep or too shallow planting, etc., which renders it impossible for us to guarantee success, and although we take all possible care to supply only such stock as will, under proper conditions, produce satisfactory results, we still give no warranty as to description, quality or productiveness of any of the seeds, plants or bulbs we send out, and will not be in any way responsible for the crop, and every order for articles named in this Catalogue will be executed on these conditions only. It must, however, be plain to every one who gives the matter the slightest thought that it is to our best interests to send out only such stock as will not only grow, but prove true to name and description.

DREER'S SUPERB MAY=FLOWERING, COTTAGE GARDEN or BOULEVARD TULIPS.

We illustrate on the covers of this Catalogue ten of the best varieties of this charming class of Tulips.

SHOWN ON FRONT OF COVER.

SHOWN ON BACK OF COVER.

Gesneriana spathulata.

Le Reve.

Snowdon.

Parisian Yellow.

Summer Beauty.

La Merveille.

Mrs. Moon.

Golden Crown.

Picotée or Maiden's Blush.

Shandon Bells, Isabella or Blushing Bride.

All of the above, as well as many other fine sorts, are described and offered on pages 10 and 11.

DREER'S AUTUMN CATALOGUE

FOR 1909.

INDEX.

Bulbs and Roots.....	3 to 34	Hedge Plants.....	61
Decorative and Flowering Plants.....	35 to 43	Small Fruits.....	62, 63
Aquarium Plants.....	44	Vegetable Plants and Roots.....	63
Hardy Perennial Plants.....	45 to 58	Flower Seeds.....	64 to 70
Hardy Roses.....	59	Vegetable Seeds.....	71 to 73
Hardy Climbing Plants.....	59	Grass and Farm Seeds.....	74, 75
Hardy Shrubs.....	60, 61	Miscellaneous Garden Requisites.....	76 to 80

BULBS AND ROOTS.

PAGE	PAGE	PAGE	PAGE
African Lily..... 19	Crocus, Autumn Flowering..... 22	Glory of the Snow..... 21	Muscaria..... 30
Agapanthus..... 19	Crown Imperial..... 23	Helleborus..... 25	Narcissus, Named..... 14-18
Allium..... 19	Cuban Lily..... 23	Hemerocallis..... 25	Chinese Sacred..... 18
Alstromeria..... 19	Cyclamen..... 21	Hippeastrum..... 19	Polyanthus..... 18
Amaryllis..... 19	Daffodils..... 14-18	Hyacinths, Mixed..... 5	Double..... 17
Anemone..... 20	Day Lily..... 25	Miniature..... 6	Star..... 16
Anthericum..... 20	Dielytra..... 23	Roman..... 5	Hoop Petticoat..... 15
Astilbe..... 34	Dog's-tooth Violet..... 23	Named..... 3 to 5	Poet's..... 16
Autumn Daffodil..... 33	Eranthis..... 23	for Beds..... 7	Trumpet..... 14, 15
Babiana..... 20	Eremurus..... 23	Selections..... 5	Nerine..... 30
Bleeding Heart..... 23	Erythronium..... 23	Grape..... 30	Ornithogalum..... 31
Barbadoes Spice Lily..... 19	Fairy Lily..... 34	Feathered..... 30	Oxalis..... 31
Brodiaea..... 20	Floral Firecracker..... 20	Imantophyllum..... 21	Paeonies..... 31, 32
Bugle Lily..... 34	Fleur-de-Lis..... 25-27	Incarvillea..... 25	Plantain Lily..... 24
Butterfly Tulip..... 20	Flowering Flags..... 25-27	Iris..... 25-27	Puschkinia..... 31
Callas..... 21	Freesia..... 24	Ixias..... 25	Ranunculus..... 31
Calochortus..... 20	Fritillaria..... 23, 24	Jonquils..... 17	Richardia..... 21
Chilian Lily..... 19	Funkia..... 24	Lachenalia..... 30	Scarborough Lily..... 34
Chionodoxa..... 21	Galanthus..... 33	Leucojum..... 30	Scillas..... 33
Christmas Rose..... 25	Glaдиolus..... 24	Lily of the Palace..... 19	Snowdrops..... 33
Clivia..... 21	Guernsey Lily..... 30	Lilies..... 28, 29	Sparaxis..... 33
Colchicum..... 22	Guinea Hen Flower..... 24	Lily of the Valley..... 30	Squills..... 31, 33
Crocus..... 22		Mariposa Tulip..... 20	Spiraea..... 34
			Spring Snowflake..... 30
			Spring Star Flower..... 34
			Star of Bethlehem..... 31
			St. Bruno's Lily..... 20
			St. Bernard's Lily..... 20
			Sternbergia..... 33
			Trillium..... 34
			Triteleia..... 34
			Tropaeolum..... 34
			Tulips, Single Early..... 8, 9
			" Late Garden..... 10, 11
			" Double..... 12
			" for Beds..... 13
			" Parrot..... 12
			" Darwin..... 11
			Vallota..... 34
			Watsonia..... 34
			Windflower..... 20
			Winter Aconite..... 23
			Wood Lily..... 34
			Zephyranthes..... 34

PLANTS—Winter-flowering, Decorative, Hardy, Small Fruits, Shrubs, etc.

PAGE	PAGE	PAGE	PAGE
Abelia..... 60	Boxwood..... 36, 61	Eleagnus..... 60	Lonicera..... 60
Abutilon..... 35	Buddleia..... 60	Erigeron..... 49	Ludwigia..... 44
Acacia..... 35	Bombax..... 44	Eucharis..... 38	Lupinus..... 51
Achillea..... 45	Callirhoe..... 45	Eugenia..... 38	Lychnis..... 52
Aconitum..... 45	Caltha..... 47	Eunymus..... 60	Lythrum..... 51
Actaea..... 45	Camellia..... 37	Eupatorium..... 49	Maranta..... 41
Actinidia..... 59	Caragana..... 60	Euphorbia..... 49	Medinilla..... 41
Adonis..... 45	Campanula..... 47	Eurya..... 38	Mentha..... 52
Aegopodium..... 45	Cape Jessamine..... 40	Exochorda..... 60	Mertensia..... 52
Aeschynanthus..... 35	Carnations..... 37	Farfugium..... 38	Metrosideros..... 41
Aglaonema..... 35	Caryopteris..... 47	Ferns..... 39	Mint..... 63
Agrostemma..... 45	Cassia..... 47	Ficus..... 38	Monarda..... 52
Akebia..... 59	Celastrus..... 59	Fittonia..... 38	Moonflower..... 59
Allamanda..... 35	Centauria..... 48	Forsythia..... 60	Moschosma..... 41
Alocasia..... 35	Cercis..... 60	Gaillardia..... 50	Myriophyllum..... 44
Alpinia..... 35	Cephalaria..... 48	Gardenia..... 40	Nephtytis..... 41
Althea..... 60, 61	Cerastium..... 48	Genista..... 40	Norfolk Island Pine..... 35
Alyssum..... 45	Chelone..... 48	Geranium..... 40	Oenothera..... 52
Amorpha..... 60	Chelidonium..... 63	Gooseberries..... 62	Olea..... 42
Ampelopsis..... 59	Chionanthus..... 60	Grapevines..... 62, 63	Ophiopogon..... 41
Anacharis..... 44	Chionodoxa..... 37	Grasses..... 60	Orange..... 41
Anchusa..... 45	Chrysanthemum..... 37, 48	Gypsophila..... 50	Osage Orange..... 61
Andromeda..... 60	Chrysosoma..... 48	Hedge Plants..... 61	Pachysandra..... 52
Anemone..... 46	Cimicifuga..... 48	Helium..... 50	Palm..... 42
Anthurium..... 35	Cinerarias..... 37	Halesia..... 60	Panax..... 41
Aphelandra..... 35	Cinnamon Vine..... 59	Helianthus..... 50	Pandanus..... 41
Apios..... 59	Cissus..... 37	Heliconia..... 40	Papaver..... 52
Aquatic Plants..... 44	Clematis..... 48, 59	Heliopsis..... 50	Pardanthus..... 52
Aquilegia..... 46	Clerodendron..... 37	Hepatica..... 51	Passiflora..... 41
Arabis..... 60	Clethra..... 60	Hesperis..... 51	Pentstemon..... 53
Aralia..... 35, 60	Colchorus..... 60	Hibiscus..... 51	Peperomia..... 43
Araucaria..... 35	Colocasia..... 37	Hibiscus..... 51	Petasites..... 53
Ardisia..... 39	Colutea..... 60	Hollyhock..... 51	Philadelphia..... 43
Aristolochia..... 59	Coreopsis..... 48	Honeysuckle..... 59	Philodendron..... 43
Armeria..... 46	Cornus..... 60	Hop Vine Roots..... 63	Phlox..... 54, 55
Artemesia..... 46	Costus..... 37	Horseradish Roots..... 63	Phyllotantemum..... 43
Asclepias..... 47	Cratageus..... 60	Hydrangea..... 60	Physostegia..... 53
Asparagus..... 36	Currant..... 37	Iberis..... 51	Physalis..... 53
" Roots..... 63	Cyanophyllum..... 37	Isolepis..... 40	Pinks, Hardy..... 53
Aspidistra..... 36	Cycas..... 37	Itea..... 60	Platycodon..... 53
Asters, Hardy..... 47	Cyperus..... 44	Ixoras..... 40	Plumbago..... 43, 53
Astilbe..... 47	Cytisus..... 60	Ivy..... 59	Podophyllum..... 53
Aucuba..... 36	Daphne..... 60	Jasmine..... 40, 59	Polygonum..... 53, 59
Azaleas..... 36, 60	Delphinium..... 40	Jasminum..... 40, 59	Potentilla..... 61
Baccharis..... 36, 60	Desmodium..... 60	Kalmia..... 60	Pothos..... 43
Baptisia..... 47	Deutzia..... 60	Lapageria..... 40	Primroses..... 43, 55
Bay Trees..... 36	Dianthus..... 48	Lathyrus..... 59	Primula..... 43, 55
Begonias..... 36	Dictamnus..... 40	Lavender..... 63	Privet..... 61
Berberis..... 60, 61	Dieffenbachia..... 38	Lemon..... 40	Prunus..... 61
Bigonia..... 59	Digitalis..... 49	Lеспедеза..... 60	Pulmonaria..... 61
Blackberries..... 62	Doronicum..... 49	Liatris..... 51	Pyrus..... 61
Bocconia..... 47	Dracacna..... 38	Ligustrum..... 60	Pyrethrum..... 55
Boltonia..... 47	Eichhornia..... 44	Lilac..... 61	Raspberries..... 63
Bougainvillea..... 36		Lobelia..... 51	Rhexia..... 56
			Rhodotypos..... 61
			Rhus..... 61
			Rhubarb Roots..... 63
			Rhynchospermum..... 43
			Roses, Hardy..... 59, 61
			Rubber Plants..... 38
			Rudbeckia..... 56
			Sage..... 63
			Sagittaria..... 44
			Salisburya..... 61
			Salvia..... 56
			Salvinia..... 44
			Sanseveria..... 43
			Scabiosa..... 56
			Schizmatoglottis..... 43
			Schizophragma..... 59
			Sedum..... 56
			Smilax..... 43
			Solidago..... 57
			Spathiphyllum..... 43
			Spirea..... 57, 61
			Sphaerogynne..... 43
			Sphegylea..... 61
			Statice..... 57
			Stenanthium..... 57
			Stephanotis..... 43
			Stokesia..... 57
			Strawberries..... 63
			Synsmona..... 43
			Swampcane..... 61
			Syringacarpus..... 61
			Syringa..... 61
			Tamarix..... 61
			Tanacetum..... 63
			Tarragon..... 63
			Thalictrum..... 57
			Thymus..... 57
			Tradescantia..... 58
			Trollius..... 58
			Tunica..... 58
			Valeriana..... 58
			Vallisneria..... 44
			Veronica..... 58
			Viburnum..... 61
			Vitex..... 61
			Viburnum..... 61
			Viola..... 43, 58
			Vinca..... 58
			Vegetable Plants and Roots..... 63
			Weigelia..... 61
			Wistaria..... 59
			Xanthoceras..... 61
			Xanthorrhiza..... 61
			Yucca..... 58

..Dreer's Reliable Bulbs..

TO succeed with bulbs it is necessary to begin right, by getting sound bulbs of good size, and we would warn intending purchasers against buying cheap, undersized bulbs and expect the fine results obtained from such as we offer. Our sources of supply are the best in this country and abroad, the leading growers of the world having for years supplied us with their choicest stock.

To the lover of flowers there is no class of plants so much prized as those which are produced from bulbs. The reason is easily found, because within the bulbs are stored all the future glory of leaves and flowers, only requiring the simplest culture to develop them in their highest perfection. Success is therefore the rule.

Another reason why bulbs are prized so highly is that a large number of them produce their flowers in very early spring, when the rest of nature is asleep. Then it is that a clump of Snowdrops, Scillas, or Chinodoxas impart to the garden an air of warmth and cheer that cannot be accomplished in any other way. Following these modest flowers come the showier Crocus, Narcissus, Hyacinths, Tulips, etc., in all their dazzling colors, keeping up a continuous display well into the summer. With no other material can be secured such a wealth of charming flowers of infinite variety of form and coloring, with so little trouble and at so small an outlay.

A FEW CULTURAL HINTS.

Note.—*The following cultural hints apply especially to the latitude of Philadelphia. South of us it is quite possible to plant out bulbs as late as Christmas, while at points north of Philadelphia they should be planted as early as possible after the first killing frost.*

WHEN TO PLANT.—To the beginner we would emphasize the fact that *Autumn* and *not Springtime* is the time to plant all kinds of spring-flowering bulbs. The larger part of the bulbs offered in this Catalogue are ready to ship by the second week in September, and the sooner they are planted after that the greater will be the measure of success, more particularly those for indoor culture; therefore, **ORDER EARLY.** A few sorts, which are noted in the catalogue, do not mature until October and November, and can be sent at once on their arrival.

OUTDOOR CULTURE.—As a general rule, the bulbs should be planted in October and November, so that the roots may make a good growth before cold weather sets in, but they can be set out even later if the ground is not frozen. They require a moderately rich soil that has been well manured for previous crops, or else apply well-rotted cow or sheep manure or bone-meal; fresh manure is injurious to bulbs. The soil should be well drained, and no good results can be obtained without free drainage. A small quantity of sand or fine coal-ashes at the base of each bulb when planted in stiff soil will be beneficial. In planting the bulbs should be placed from an inch to four inches below the surface, according to the size of the bulb. A good rule to go by is to cover the bulbs with soil one and a half times their own depth.

When the ground freezes hard the bed should be covered with three or four inches of leaves or litter, which should be removed in early spring. Too early and heavy covering starts the tops prematurely, which are frequently injured in March by freezing and thawing. After flowering, if the beds are wanted for late spring plantings, take up the bulbs, tops and roots, and "heel in" in some corner of the garden until the bulbs mature, after which they should be spread out in an airy room to dry, and kept in a cool, dark place until time for replanting the following autumn.

INDOOR CULTURE.—Bulbs intended for blooming during the winter can be planted from September until November—the earlier the better—in pots, pans or boxes, and be left in the open air, covered with a few inches of ashes or soil, until the earth begins to freeze, and then placed in a cool greenhouse, cellar or room, at a temperature of 50 degrees. They will need, occasionally, moderate watering after they are brought inside. Or the pots, pans or boxes may be placed at once, after potting, in a cool, dark cellar, watering well and cover the same as above. The whole success of pot culture depends upon getting the roots well established in the pots, at a low temperature of say 40 to 50 degrees, before you begin to force the tops at 60 degrees or over. After this the bloom is easily developed by giving light and water, and one can have a supply of flowers from Christmas until after Easter by regulating the time of bringing them to the light.



PLANTING OF POET'S NARCISSUS ALONG EDGE OF WALK.

DUTCH HYACINTHS.

The Hyacinth is so well known and esteemed that any description of its many good qualities is needless. The list now offered includes nearly every shade of red, white, blue, yellow, etc.

Outdoor Culture.—The bulbs may be planted any time from October to December—the earlier the better. They succeed in any good, well-drained garden soil. Set the bulbs so that the tops will be 3 or 4 inches below the surface and 6 to 10 inches apart. Before very severe weather comes on, cover the beds with straw, leaves or manure to protect them from the frost, but care should be taken that this covering is not too thick, as the bulbs are as likely to be injured by being kept too warm as by freezing; this should be removed in March, or when danger from hard frost is past.

Pot Culture.—Plantings may be made at any time from September to December, though October is the best time. A light, rich soil, with a mixture of well-rotted cow or sheep manure, is most suitable. Use a 4 or 5-inch pot, and have the tops of the bulbs just above the surface. After potting give a good watering and set away in a cool cellar or outhouse and cover with coal-ashes or some litter, until thoroughly rooted; this usually takes from 10 to 12 weeks. They may then be brought as wanted for a succession of flowers into a moderately warm, light room.

Culture in Glasses.—When it is desired to grow Hyacinths in water, they should be placed so that the base of the bulb *merely touches the water*. The glasses should then be set in a cool, dark closet, or in the cellar, until filled with roots, when they may be brought into the light. Give as much fresh air as possible without letting the plants stand in a draught, and as nearly as possible at a temperature of sixty degrees until the spikes are developed. To put them at once into a room with a temperature of say 70 degrees would cause them to flower prematurely.

Select Second Size Named Hyacinths.

These are smaller than our Extra Selected first size bulbs offered on pages 4 and 5, but are fine flowering stock, and admirably adapted for pot culture and high-grade bedding where distinct shades of color are desired. We can furnish them in the following grand varieties:

SINGLE RED, ROSE AND PINK.

- Chas. Dickens.** Soft rose; exquisite.
- Gen. Pelissier.** Intense deep crimson-scarlet; fine bedder.
- Gertrude.** Deep rose; extra fine for bedding, having erect truss.
- Gigantea.** Soft blush pink; very large spike.
- Moreno.** Waxy pink; very large bells and truss.
- Roi des Belges.** Brilliant crimson-scarlet; a grand bedding sort.

Single Pure and Tinted White.

- Alba Superbissima.** Purest white; fine truss and bells.
- Baroness van Thuyll.** Pure white; popular bedder.
- Grandeur a'Merveille.** The finest blush white variety.
- L'Innocence.** Purest white; a grand variety.
- La Grandesse.** Magnificent clear white; considered the finest of all whites.
- Mme. van der Hoop.** Pure white; large bells; a splendid sort.

Single Blue, Lavender and Purple.

- Baron van Thuyll.** Rich purple, in long spikes.
- Czar Peter.** Light porcelain-blue; an exquisite shade.
- Grand Maitre.** Deep porcelain-blue; very large truss; strong and free grower.
- King of the Blues.** The finest of the rich deep blue varieties.
- La Peyrouse.** Light porcelain-blue; very dainty.
- Queen of the Blues.** Clear silvery azure-blue; beautiful.

Price, any of the above, **8 cts. each; 75 cts. per doz.;**
\$5.00 per 100; \$47.00 per 1000.

If by mail, add 12 cts. per doz. for postage.

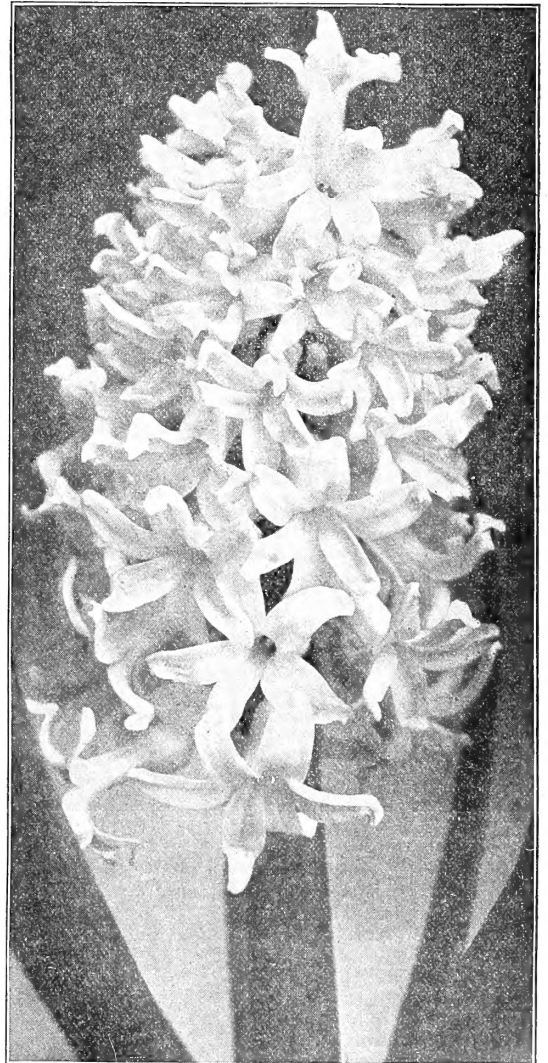

SPIKE OF SINGLE HYACINTH.

GLASSES for HYACINTHS.

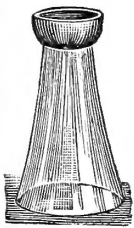

TALL OR BELGIAN SHAPE.

Either shape in Amber, Green, Amethyst, Blue, Clear or Crystal, 20 cts. each; \$2.00 per doz.



SQUAT OR TYE SHAPE.

For Collections of Hyacinths suitable for growing in glasses see page 5.

Glasses cannot be sent by mail.

Single-flowering Hyacinths are usually the most satisfactory, producing the finest spikes of bloom.

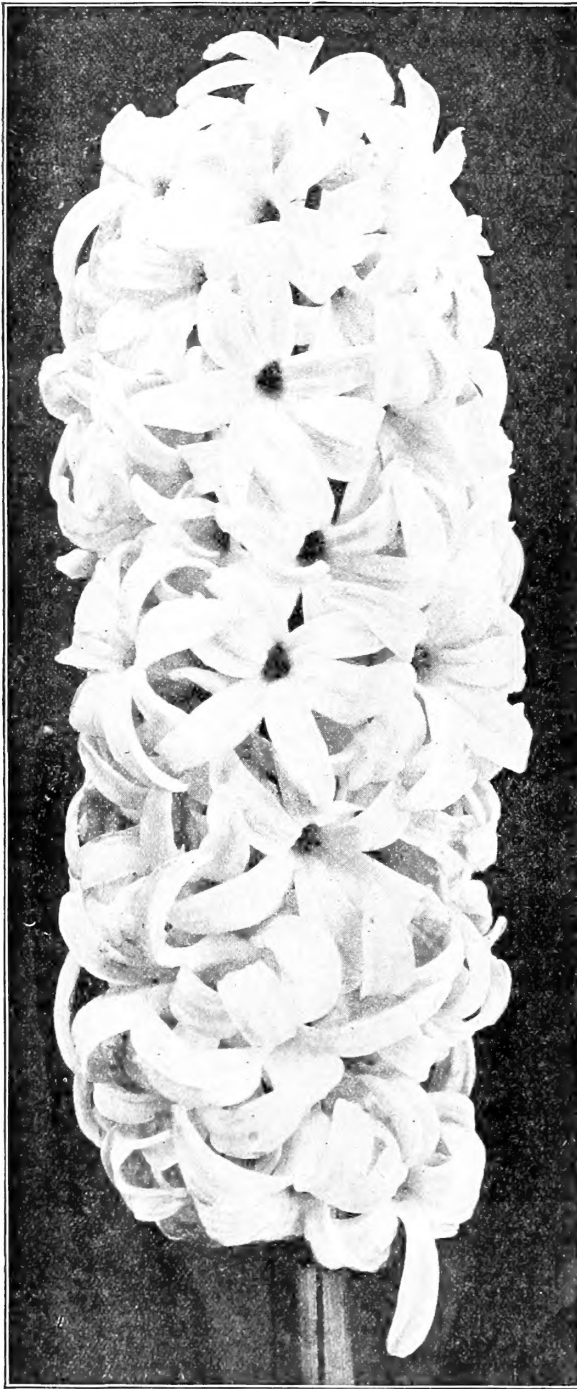

SPIKE OF SINGLE HYACINTH.

SINGLE YELLOW SHADES.

Ida. The best pure yellow; fine spike. 12 cts. each; \$1.25 per doz.

King of the Yellows. Fine bright yellow. 12 cts. each; \$1.25 per doz.

La Pluie d'Or. Pale yellow.

Obelisque. Rich deep yellow. 12 cts. each; \$1.25 per doz.

Sonora. Buff; large bells and spike.

Yellow Hammer. A splendid pure yellow, fine spike and bells. 12 cts. each; \$1.25 per doz.

Price.—All of the Extra Selected First-size Named Hyacinths (except where noted) at the uniform price of **10 cts. each; \$1.00 per doz.**; by mail, 18 cts. per doz. extra.

Extra Selected First-size Named Hyacinths.

The varieties enumerated below have been selected for their distinct coloring and free-flowering qualities, and are all **selected first-size bulbs**, specially suited for growing in pots or glasses or for high-grade bedding. For cultural notes see page 3.

Price.—All the Extra Selected First-size Named Hyacinths (except where noted) at the uniform price of **10 cts. each; \$1.00 per dozen.** If wanted by mail, add 18 cts. per dozen for postage. Single bulbs mailed free at prices given.

SINGLE RED, ROSE AND PINK.

Baron van Thuyll. A beautiful delicate pink; fine spikes.

Cardinal Wiseman. Charming light rose pink.

Charles Dickens. Soft rose, exquisite shade; very large spikes.

Fabiola. Rose-pink, striped carmine; fine bells and spike.

General Pelissier. Intense deep crimson-scarlet; compact spike; a fine bedder.

Gertrude. Deep rose; large compact truss. A splendid variety for bedding, as it stands very erect.

Gigantea. One of the best blush-pink varieties. Very large truss.

Koh-i-Noor. Brilliant salmon-pink, large spike, semi-double. 12 cts. each; \$1.25 per doz.

Moreno. Waxy pink; very large truss and bells; splendid sort for pots.

Norma. Coral pink. One of the best for early forcing; a great favorite.

Robert Steiger. Deep rose-carmine; compact truss.

Roi des Belges. Brilliant crimson-scarlet; a grand bedder.

Sultan's Favorite. Blush pink with darker stripes.

SINGLE PURE AND TINTED WHITE.

Alba Superbissima. Of purest white; fine truss.

Albertine. Pure white; an easy variety to force.

Baroness von Thuyll. Pure white, splendid forcer and bedder.

Grandeur a' Merveille. Finest blush-white; large truss of bloom.

Grand Vedette. Snow white; early.

La Franchise. Blush white; very large bulb.

La Grandesse. This is the finest pure white. 12 cts. each; \$1.25 per doz.

L'Innocence. Purest white, extra fine spike. 12 cts. each; \$1.50 per doz.

Mme. van der Hoop. Pure white; very large bells. This is one of the best whites.

Mina. Pure white; large bells; fine.

Voltaire. Creamy white; large bells.

SINGLE BLUE, LAVENDER, PURPLE, ETC.

Baron van Thuyll. Fine purple; very large.

Blondin. Beautiful shade of azure blue.

Chas. Dickens. Porcelain-blue, shaded darker.

Czar Peter. Finest light porcelain-blue. 12 cts. each; \$1.25 per doz.

Grand Maitre. Deep porcelain-blue, very large truss.

King of the Blues. This is the finest of the deep blue varieties.

La Peyrouse. Light porcelain-blue.

Leonidas. Light blue; fine spike.

Marie. Rich purple-blue; enormous spike.

Pieneman. Porcelain-blue; large spike.

Queen of the Blues. Clear silvery azure blue; a grand sort. 12 cts. each; \$1.25 per doz.

William I. Very dark purple.

EXTRA SELECTED FIRST SIZE DOUBLE NAMED HYACINTHS.

While Double Hyacinths do not, as a rule, produce as fine spikes as the single sorts offered on the opposite page, especially when grown in water, yet they are exceedingly handsome, and deserve extensive cultivation. The varieties listed below are those which we have found by actual tests to be the most satisfactory.

DOUBLE RED ROSE, Etc.

- Bouquet Royal.** Salmon pink, red centre.
- Bouquet Tendre.** Dark carmine red, good spike.
- Grootvorst.** Very fine blush pink; large, compact spike.
- Lord Wellington.** The finest double pink. 12 cts. each; \$1.25 per doz.
- Noble Par Merite.** Deep rose; extra double.
- Prince of Orange.** Rosy pink; fine spike.

DOUBLE PURE AND TINTED WHITE.

- Bouquet Royal.** Pure white; good spike; extra.
- Duchess of Bedford.** Pure white.
- Isabella.** The finest double blush white.
- La Tour d'Auvergne.** Earliest pure white; grand spike; extra.
- La Virginite.** Blush white; fine spike.
- Prince of Waterloo.** Pure white; large bells and spike. 12 cts. each; \$1.25 per doz.

DOUBLE BLUE, LAVENDER, PURPLE, Etc.

- Blocksberg.** Finest light blue; very large, compact spike.
- Garrick.** Deep azure blue; very large spike.
- General Antinck.** Light blue; good truss.
- Prince of Saxe Weimar.** Deep purple.
- Rembrandt.** Light porcelain blue.
- Van Speyk.** Fine porcelain blue; very large truss.

DOUBLE YELLOW.

- Bouquet Orange.** Dark orange salmon.
 - Goethe.** Light yellow; large spike.
 - Jaune Supreme.** Citron-yellow.
 - Minerva.** Orange yellow; extra large and fine flower; semi-double. 12 cts. each; \$1.25 per doz.
 - Ophir d'Or.** Citron-yellow, with purple centre.
- Price:** All of the extra selected first size named Hyacinths (except where noted) at the uniform price of **10 cts. each; \$1.00 per doz.** *If wanted by mail, add 18 cts. per dozen for postage. No extra charge for mailing single bulbs.*

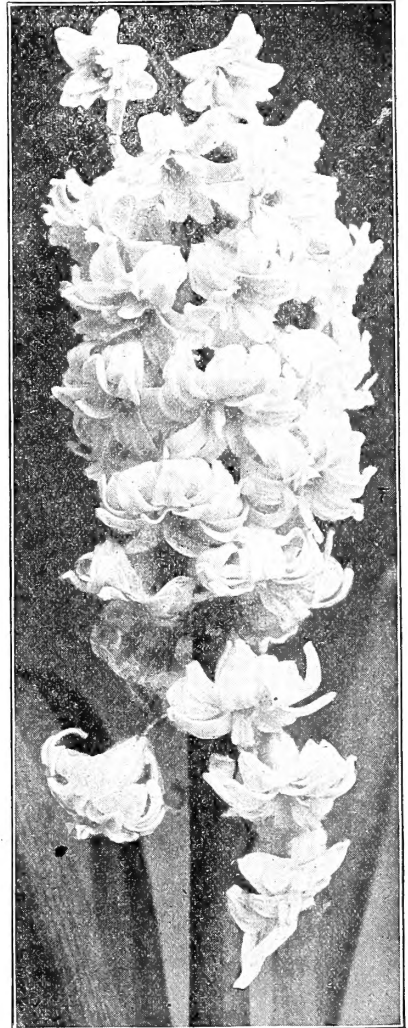

SPIKE OF DOUBLE HYACINTH.

COLLECTIONS OF FIRST SIZE NAMED HYACINTHS.

Dreer's Selection for Pot Culture.

A selection of magnificent and distinct sorts, which may confidently be expected to produce spikes of exceptional size. For culture see page 3. 12 distinct named varieties (6 singles and 6 doubles), our selection, \$1.00, or by mail \$1.15.

Dreer's Selection for Growing in Water.

Many varieties do not succeed grown in this way. This selection is made up of sorts which are specially adapted for the purpose. For culture see page 3. 12 distinct named varieties (9 singles and 3 doubles), our selection, \$1.00, or by mail \$1.15.

Glasses for Hyacinths.

These are offered on page 3.

DUTCH ROMAN HYACINTHS.

These are small, single-flowering Dutch Hyacinths, and quite distinct from the French Romans offered on page 6, and excellent for growing in pots, pans or boxes, blooming early and freely. They may be planted close together in the pots, pans or boxes, or in beds in the open ground, with charming effect.

- Charles Dickens.** Delicate rose.
- Gertrude.** Deep rose.
- General Pelissier.** Deep scarlet.
- Gigantea.** Soft blush or shell-pink.
- Baroness van Thuyll.** Pure white.
- Grandeur a'Merveille.** Blush white.
- La Grandesse.** Snow white.
- L'Innocence.** Purest white.
- Czar Peter.** Light porcelain-blue.
- Grand Maitre.** Deep porcelain-blue.
- King of the Blues.** Rich, deep blue.
- Queen of the Blues.** Silvery-blue.

Price, any of the above named varieties, **5 cts. each; 40 cts. per doz.; \$2.75 per 100.**

If wanted by mail, add 6 cts. per dozen on Miniature Hyacinths for postage. Single bulbs mailed without additional cost.

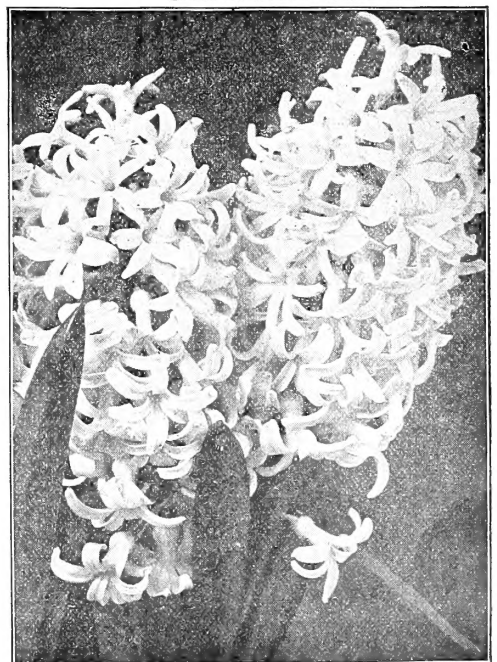

DUTCH ROMAN HYACINTHS.

Dreer's Mixed Dutch Hyacinths.

We offer two grades of mixtures—our "Rainbow" and "Popular." Both are good, and we feel confident that nothing better can be had at the prices quoted. We recommend the single-flowering sorts as giving the best and most uniform results.

DREER'S "RAINBOW" MIXTURE.

Only the best named sorts are used in making this really fine mixture. The bulbs average over 6 inches in circumference, and can be depended on to produce fine results, either planted out of doors or in pots in the house.

Dark Red shades mixed.
Rose and Pink shades mixed.
Red, all shades mixed.
Pure White sorts mixed.
Blush and Tinted White sorts mixed.

Price. Any of the above in either Single or Double, 6 cts. each; 60 cts. per doz.; \$4.00 per 100; \$38.00 per 1000. *If wanted by mail, add 12 cts. per dozen for postage.*

Dark Blue and Purple shades mixed.
Light Blue and Lavender shades mixed.
Blue, all shades mixed.
Yellow, all shades mixed.
All colors mixed.

DREER'S "POPULAR" MIXTURE.

A fine grade of bulbs at a popular price. The bulbs used in making this mixture are 15 centimeters—nearly 6 inches in circumference—and are adapted for bedding and outdoor planting of all kinds. Can also be used for pot culture, but we strongly advise the use of our Select Second Size and Extra Selected First Size named sorts offered on pages 3, 4 and 5 for this purpose.

Dark Red shades mixed.
Rose and Pink shades mixed.
Red, all shades mixed.
Pure white sorts mixed.
Blush and Tinted White sorts mixed.

Price. Any of the above in either Single or Double, 5 cts. each; 50 cts. per doz.; \$3.25 per 100; \$30.00 per 1000. *If wanted by mail, add 10 cts. per dozen for postage.*

Dark Blue and Purple shades mixed.
Light Blue and Lavender shades mixed.
Blue, all shades mixed.
Yellow, all shades mixed.
All colors mixed.

EARLY FRENCH ROMAN HYACINTHS.

A charming class of Hyacinths from the south of France (quite distinct from the Dutch Hyacinths), producing graceful, delicately perfumed spikes of flowers. They force readily in the house. Three bulbs can be put in a 4-inch, or six bulbs in a 6-inch pot or pan, and as each bulb produces several spikes it makes a beautiful plant for conservatory or house decoration. Their treatment is identical with the Dutch Hyacinth (see page 3), except that we do not recommend them for outdoor planting.

Early White. Pure white, one of the most valuable plants for cut flowers. Millions of these are annually forced in the United States. If potted at intervals from September to November can be had in flower from November till April.

Selected bulbs, 5 cts. each; 50 cts. per doz.; \$3.00 per 100; \$27.50 per 1000.

Extra selected bulbs, 6 cts. each; 60 cts. per doz.; \$4.00 per 100; \$32.00 per 1000.

Mammoth bulbs, 7 cts. each; 75 cts. per doz.; \$5.00 per 100; \$42.00 per 1000.

Early Dark Rose. Semi-double, deep pink. 5 cts. each; 50 cts. per doz.; \$3.00 per 100.

Early Light Rose. Double, beautiful pale rose. 5 cts. each; 50 cts. per doz.; \$3.00 per 100.

Early Blue. Light blue, a fine contrast to the other colors. 5 cts. each; 50 cts. per doz.; \$3.00 per 100.

Early White Italian or Parisian. A little later in flowering than the Romans. Much larger spikes. 5 cts. each; 50 cts. per doz.; \$3.00 per 100.

Add 8 cts. per doz. for postage on French Roman Hyacinths, if wanted by mail. Single bulbs mailed free at prices given.

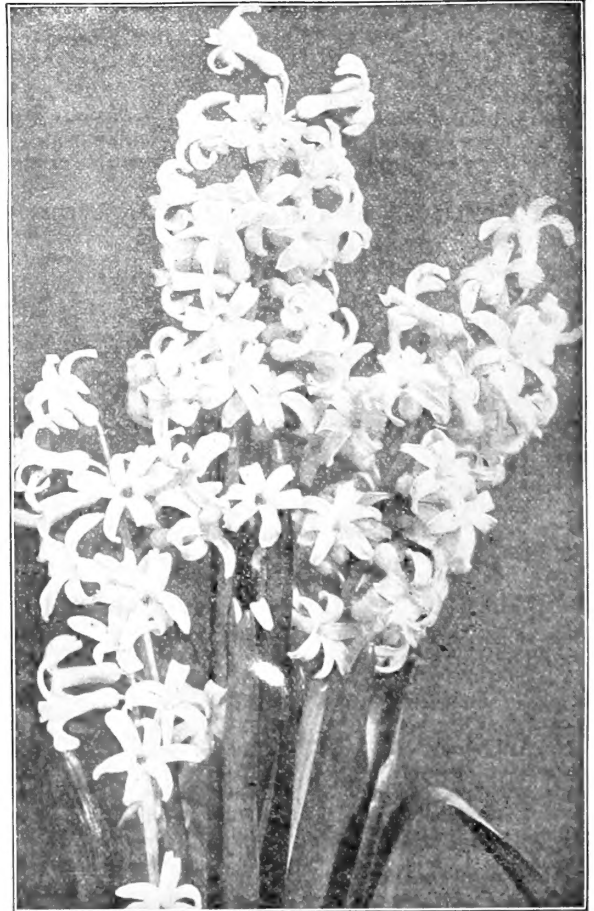

EARLY WHITE FRENCH ROMAN HYACINTHS.

COLLECTIONS OF Hyacinths for Beds.

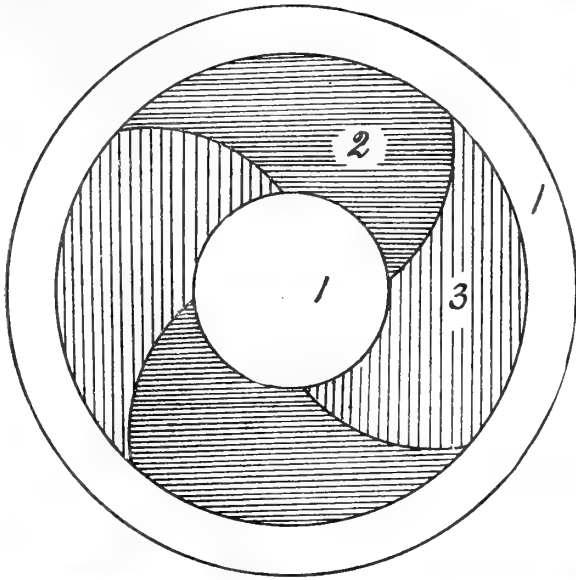

CIRCULAR BED OF HYACINTHS "A."

FEW bulbs can be used for bedding with such good effect as Hyacinths, and every spring they form one of the features of the principal public parks, and, considering the little trouble necessary for their care and the low cost of planting a good-sized bed, it is a matter of comment that larger plantings are not seen in private gardens. While mixed Hyacinths in the separate colors offered on page 6 are well adapted for bedding purposes, yet where a special design is wanted in which the colors must be sharp and distinct we advise using the named varieties. Not only do you then get the requisite colors, but at the same time much finer individual spikes of flowers, which well repays for the slight increase in cost.

Cultural directions will be found on page 3. We might add that Hyacinth bulbs in some soils do well for a number of years without lifting or replanting. When through flowering, the beds may be sown or planted with shallow-rooting plants, such as Petunias, Verbenas, Portulaca, etc., which will keep the beds bright throughout the summer and in no way hurt the bulbs.

The sizes of these beds are 6 feet in diameter; plant outside rows 3 inches from edge of bed; each bed requires 108 bulbs, planted 6 inches apart each way.

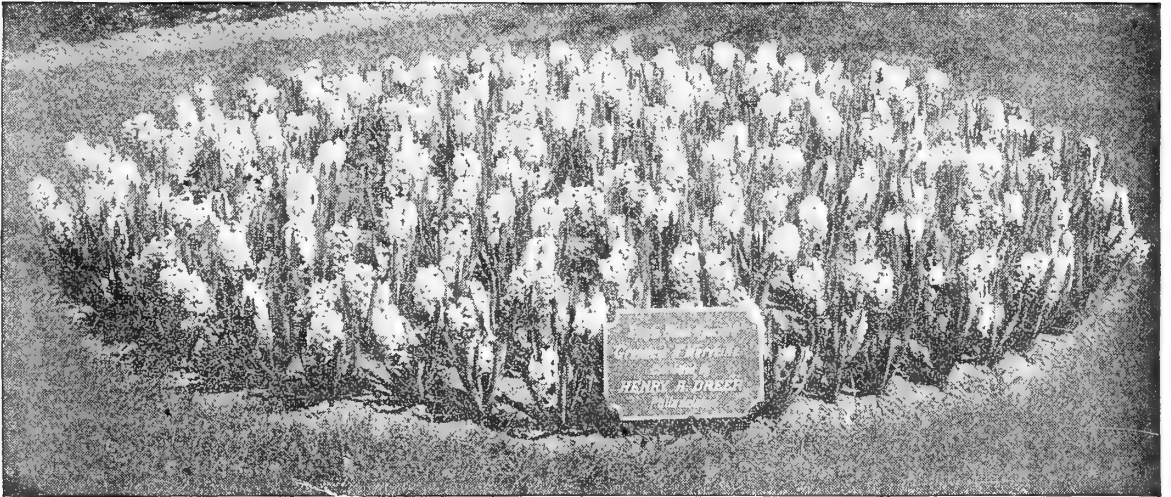

BED OF HYACINTHS AT THE PAN-AMERICAN EXPOSITION "C."

Price. Bulbs for any of the following beds in Select Second size for \$5.00; in Extra Selected First size for \$7.00.

CIRCULAR BED OF HYACINTHS "A."

- | | | | | |
|-------|--------|-----|-----------------------------|-------------|
| Space | No. 1. | 48. | Gertrude. | Deep rose. |
| " | " | 2. | King of the Blues. | Deep blue. |
| " | " | 3. | Baroness van Thuyll. | Pure white. |

CIRCULAR BED OF HYACINTHS "B."

- | | | | | |
|-------|--------|-----|----------------------|-------------|
| Space | No. 1. | 32. | Grand Maitre. | Clear blue. |
| " | " | 2. | Gertrude. | Deep rose. |
| " | " | 3. | L'Innocence. | Pure white. |

CIRCULAR BED OF HYACINTHS "C."

This bed is formed of 6 lines of bulbs, using five sorts, and makes a very attractive effect.

- | | | | |
|--------------------|-----|---------------------------|----------------------------------|
| 1st (outside) row, | 33. | Grand A'Merveille. | Blush white. |
| 2d " | " | 27. | Gen. Pelissier. Scarlet. |
| 3d " | " | 21. | Chas. Dickens. Deep blue. |
| 4th " | " | 15. | Gigantea. Pink. |
| 5 } (centre) | " | 9. | Grand Maitre. Clear blue. |
| 6 } | " | 3. | |

Price. Bulbs for any of the above beds in Select Second Size for \$5.00, in Extra Selected First Size for \$7.00.

The combination of colors in any of the beds will be changed if so desired at same cost.

Collections for beds are too heavy to be sent by mail, and will be forwarded by express or freight at customer's expense.

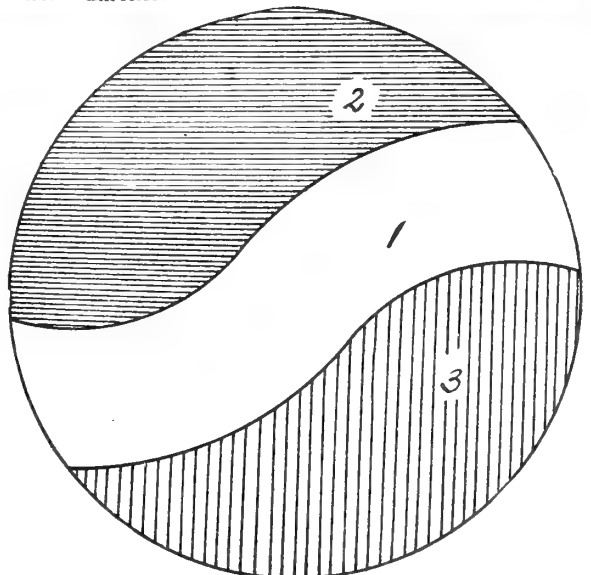

CIRCULAR BED OF HYACINTHS "B."



GROUP OF SINGLE EARLY TULIPS.

SINGLE Early-flowering TULIPS.

THE Tulip is always attractive from its beauty and brilliancy of color, and is one of the popular early spring flowers. A

few bulbs scattered here and there produce but little effect, but when planted in masses or in small groups, they become at once grand and brilliant, and eclipse in variety of coloring and picturesque effect almost any other flower. Our collection is unusually fine, embracing all the choicest varieties. Tulips require cultural treatment similar to Hyacinths; the bulbs, being smaller, should not be planted so deep. All the varieties named below are well adapted for pot culture. The Duc Van Thol sorts can be forced into bloom for Christmas with but little trouble. Put 3 bulbs in 4-inch pots.

The figures prefixed indicate the average height in inches of each variety.

If Tulips are wanted by mail, add at the rate of 5 cts. per dozen for postage.

	Height, inches.		Per Doz.	Per 100.
8. Artus. Bright deep scarlet; a splendid bedding variety. \$14.00 per 1000			\$0 25	\$1 50
10. Belle Alliance. Bright crimson scarlet; fine either for forcing or bedding. \$23.00 per 1000			35	2 50
10. Canary Bird. Clear yellow; early. \$13.00 per 1000			25	1 50
10. Chrysolora. The finest golden-yellow bedding Tulip; splendid large flowers. \$12.00 per 1000			25	1 50
8. Cottage Maid. White bordered pink; very dainty and attractive for bedding or forcing. \$12.00 per 1000			25	1 50
10. Couleur Cardinal. Rich cardinal; splendid bedder or forcer. \$22.00 per 1000			35	2 50
7. Crimson King. Crimson scarlet; fine bedder. \$15.00 per 1000			25	1 60
Duc van Thol. These varieties are only valuable for early forcing in pots or boxes.				
6. Red and Yellow		\$12.00 per 1000	25	1 50
7. Scarlet		15.00 per 1000	30	1 75
7. Crimson		10.00 per 1000	25	1 25
7. Rose		18.00 per 1000	30	2 00
7. White		15.00 per 1000	30	1 75
7. Yellow		20.00 per 1000	35	2 25

	Per doz.	Per 100.		
9. Duchesse de Parma. Red, bordered orange, effect orange-scarlet; very bright. \$13.00 per 1000	25	\$1 50	10. La Reine (Queen Victoria). Pure white, sometimes tinted rose; fine for bedding or forcing. \$12 00 per 1000	25 1 50
9. Grand Duc de Russie. White ground flaked with rosy-purple. \$20.00 per 1000	35	2 25	10. Ophir d'Or. Golden-yellow; extra large flower; grand bedder. \$15.00 per 1000	30 1 75
7. Grand Master of Malta. White and crimson rose. \$20.00 per 1000	35	2 25	12. Pink Beauty. Exquisite deep pink, flushed snowy-white on outer petals; rare and beautiful. \$60.00 per 1000	1 00 6 50
8. Golden Standard. Crimson, flaked and feathered golden-yellow. \$30.00 per 1000	50	3 50	12. Pottebakker, White. One of the finest, either for forcing or bedding. \$15.00	30 1 75
10. Joost van Vondel. Deep blood-red; light feathering of white at base. \$15.00 per 1000	30	1 75	12. Pottebakker, Yellow. Very large and fine yellow. \$15.00 per 1000	30 1 75
10. Joost van Vondel White. The finest of all white Tulips; perfect in every way. \$30.00 per 1000	50	3 50	12. Pottebakker, Scarlet. \$18.00 per 1000	30 2 00
15. Kaiser Kroon. Bright red, margined golden-yellow; extra large and grand in every way. \$15.00 per 1000	30	1 75	9. Prince of Austria. Orange-scarlet; a striking color; sweet-scented. \$25.00 per 1000	40 2 75
9. L'Immaculee. Pure white; early. \$10.00 per 1000	20	1 25	8. Princess Marianne. White, shaded rose; fine bedder. \$12.00 per 1000	25 1 50
			10. Proserpine. Glossy carmine-rose; large and beautiful, and one of the most attractive. \$28.00 per 1000	45 3 00

Single Early Tulips

(Continued.)

Height. Inches.		Per Doz.	Per 100.
6.	Rose Grisdelin. The finest dwarf, bright pink bedding Tulip. \$16.00 per 1000	30	\$1 75
8.	Rose Luisante. Brilliant deep pink; fine for forcing or bedding. \$25.00 per 1000	40	2 75
10.	Rosa Mundi. Rose and white; a good bedder. \$10.00 per 1000	20	1 25
9.	Silver Standard. White, flaked and striped with crimson; fine. \$16.00 per 1000	30	1 75
12.	Thos. Moore. Rich, brilliant orange-scarlet; sweet-scented. \$15.00 per 1000 ..	30	1 75
8.	Van der Neer. Rosy violet. \$22.00 per 1000	35	2 50
12.	Vermillion Brilliant. Rich vermilion; the finest scarlet. \$28.00 per 1000	45	3 00
12.	White Hawk (Albion). A beautiful large pure white of great substance; fine for bedding or forcing. \$20.00 per 1000 ..	35	2 25
9.	Wouverman. Purple violet; extra large. \$20.00 per 1000	35	2 25
12.	Yellow Prince. The leading golden yellow for forcing; is also equally valuable for bedding; sweet-scented. \$12.00 per 1000.	25	1 50



SINGLE EARLY TULIP THOS. MOORE.

Collections of Single Early Tulips.

A border planted with one of the following collections forms one of the most interesting and educational features of the garden.

1	each of the '40 named sorts	\$ 1 25
3	" " " " " 120 bulbs	3 25
6	" " " " " 240 "	6 00
12	" " " " " 480 "	10 00
25	" " " " " 1000 "	19 00



SINGLE EARLY TULIPS KAISER KROON (offered on page 8).

MIXED SINGLE TULIPS.

If wanted by mail, add 5 cts. per doz. to Tulips for postage.

There are great differences in the various grades of mixed Tulips. As a rule they are made up by the growers in Holland out of cheap, undesirable or surplus lots, and little attention given to variety of color or time of flowering.

Dreer's Superb Mixture of Single Early Tulips.

We are importing a large quantity of fine-named varieties to make this mixture. It will contain a carefully balanced range of colors, and must not be compared with mixtures as usually sent out. 20 cts. per doz.; \$1.00 per 100; \$9.00 per 1000.

Dreer's Fine Quality Mixture of SINGLE EARLY TULIPS.

A first-class mixture, prepared for us by one of the leading Dutch growers. 15 cts. per doz.; 80 cts. per 100; \$7.00 per 1000.

TULIPA GREIGI.

An exceptionally handsome and distinct early-flowering species. The beautifully-formed flowers are of large size and of a gorgeous orange scarlet color, so brilliant as to at once attract the attention. The plant is quite ornamental on account of its broad, spotted foliage; very choice. 10 cts. each; \$1.00 per doz.; \$6.50 per 100.

May-flowering Cottage Garden or Boulevard TULIPS.

This beautiful class is becoming more popular as they become better known, and in order to bring them prominently to the attention of all of our customers we illustrate 10 of the leading varieties on the cover of this catalogue. They are quite distinct from the early-flowering sorts offered on the preceding pages, coming into bloom in the vicinity of Philadelphia about May 10th, or two to three weeks later than the early-flowering types, and extending the Tulip season over a period of four weeks or more. For the most part they have been collected from the old Cottage Gardens of England, Scotland and Ireland, where they have been, in some cases, for over half a century. They are said to be the offspring of *Tulipa Gesneriana*, and, while possessing infinite variety and brilliancy of color, all have the fine form and stately yet graceful character of the parent. On account of their extreme hardiness, they are specially adapted for the permanent hardy flower border, where they should be liberally planted in clumps or masses. They may also be naturalized in grass, wild gardens, etc. For bedding they are superb, while as cut flowers they are much to be preferred to the early type, having long stems with flowers of great substance that stand cut in a perfect condition for a long time. We have tested over one hundred of the best varieties, and offer the selection of twenty sorts with every confidence that they will give complete satisfaction. The heights given are actual measurements taken at our trial grounds May 10th to 15th. These, of course, are liable to vary according to soil and other conditions.

In planting, the bulbs should be set a little deeper than ordinary Tulips, a covering of 4 inches being about right.

Bizarres (24 inches). An odd and striking class. The ground color of the flowers is some shade of yellow quaintly marked, in a greater or lesser degree, with brown, violet or crimson; mixed colors. 20 cts. per doz.; \$1.25 per 100; \$10.00 per 1000.

Bouton d'Or (*Golden Beauty*) (21 inches). Rich, buttery orange-yellow cup-shaped flowers. The anthers are black and make a striking contrast with the yellow when the flowers are expanded. 25 cts. per doz.; \$1.50 per 100; \$12.00 per 1000.

Caledonia (20 inches). Brilliant orange-scarlet with greenish black centre, very striking in masses. 50 cts. per doz.; \$3.50 per 100; \$30.00 per 1000.

Fulgens (30 inches). Velvety vermilion red, with yellow base, long reflexed petals. Very showy. 35 cts. per doz.; \$2.50 per 100; \$20.00 per 1000.

Gesneriana spatulata (28 inches). A superb Tulip of strong yet graceful growth, and bearing very large flowers of an intense brilliant crimson-scarlet with glittering blue-black centre. No words or picture can begin to do this Tulip justice. It should be planted in generous quantity. There are a number of inferior types of this Tulip. The variety *spatulata* is the finest of all. 30 cts. per doz.; \$1.75 per 100; \$15.00 per 1000.

Golden Crown (22 inches). Large flowers with pointed petals, color rich yellow, petals faintly edged with red; a good bedder. 20 cts. per doz.; \$1.25 per 100; \$10.00 per 1000.

Inglescombe Pink (*Salmon Queen*) (18 inches). A rare blending of buff and salmon. Most attractive, both in form and coloring. 50 cts. per doz.; \$3.50 per 100; \$30.00 per 1000.



GROUP OF MAY-FLOWERING TULIPS.

La Merveille (18 inches) A magnificent variety with very large, artistic, sweet-scented blossoms and of a striking color, being salmony-rose overlaid with orange-red, very effective in beds or borders. 30 cts. per doz.; \$1.75 per 100; \$15.00 per 1000.

Le Reve (*Hobbema*) (15 inches). When first opening a dull, smoky color, developing into the most beautiful old-rose color imaginable; a handsome flower of great texture, remaining in perfection for a long time. 75 cts. per doz.; \$5.00 per 100; \$45.00 per 1000.

Mrs. Moon (*Fulgens lutea*) (24 inches). The largest and finest of all yellow late Tulips. Flowers long and pointed, color rich yellow, sweet-scented. 10 cts. each; \$1.00 per doz.; \$7.50 per 100.

Orange Beauty (*Gesneriana aurantiaca maculata*) (24 inches). Perfect globular flowers, very large in size, of a rich, dark-red, bordered with orange, highly perfumed. 50 cts. per doz.; \$3.00 per 100; \$26.00 per 1000.

Parisian Yellow (28 inches). A beautiful large pure yellow of exquisite shade and shape; grand in every way, and of special value for cutting. 35 cts. per doz.; \$2.50 per 100; \$20.00 per 1000.

Picotee (*Maiden's Blush*) (24 inches). Pure white, daintily edged with pink, which suffuses the entire flower as it ages; a beautiful cut flower. 30 cts. per doz.; \$1.75 per 100; \$15.00 per 1000.

Rose Byblæmen (24 inches). Mostly white ground, flaked with rose, scarlet or crimson, but also self or solid colored sorts in various shades of rose; mixed colors. 25 cts. per doz.; \$1.50 per 100; \$13.00 per 1000.

Royal White (18 inches). Splendid globular flowers of pure white, the centre of the petals slightly tinted with creamy yellow. 60 cts. per doz.; \$4.00 per 100; \$35.00 per 1000.

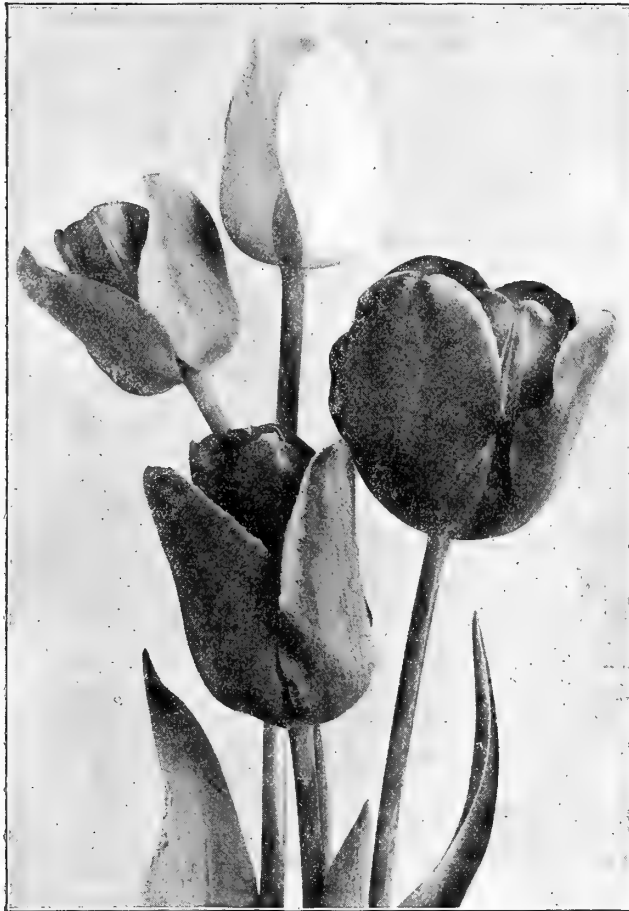

GROUP OF DARWIN TULIPS.

May-flowering, Cottage Garden or Boulevard Tulips.

(Continued.)

- Shandon Bells, Isabella, or Blushing Bride** (18 inches). A pretty variety, opening out a creamy-yellow tinted with blush, turning, as the flower ages, to a carmine pink; a charming transformation. 30 cts. per doz.; \$2.00 per 100; \$18.00 per 1000.
- Snowdon** (20 inches). Beautiful goblet-shaped flowers of snow white, suffused on the margin with delicate rosy-lavender; a rare color combination and much admired as a cut flower. 50 cts. per doz.; \$3.00 per 100; \$25.00 per 1000.
- Summer Beauty** (24 inches). White, beautifully striped and splashed with rosy-crimson; a fine large, showy flower. 60 cts. per doz.; \$4.00 per 100; \$35.00 per 1000.
- Violet Byblømen** (22 inches). Made up of solid purple, violet and heliotrope shades, also flakings of these colors on a white ground, mixed colors. 25 cts. per doz.; \$1.50 per 100; \$12.00 per 1000.
- Vitellina** (22 inches). Enormous flowers of soft primrose yellow, shading off to silvery white; delicately almond-scented. 50 cts. per doz.; \$3.50 per 100; \$30.00 per 1000.
- Choicest Mixed** This is a splendid mixture made up out of over fifty sorts of all colors, and contains a good percentage of sweet-scented varieties. 25 cts. per doz.; \$1.50 per 100; \$12.00 per 1000.

Collections of May-flowering Tulips.

The best way to get acquainted with the beauties and merits of this beautiful class is to grow one of the collections offered below.

3 each of the 20 sorts, 60 bulbs	\$2 00
6 " " 20 " 120 "	3 75
12 " " 20 " 240 "	7 00
25 " " 20 " 500 "	12 50
50 " " 20 " 1000 "	24 00

DARWIN TULIPS (May-flowering).

Handsome May-flowering class and quite distinct in style of growth from the other late-flowering sorts, stately in appearance, attaining a height of 24 to 30 inches, and bearing on strong stems beautiful globular flowers of remarkably heavy texture, in a large range of colors, embracing almost every conceivable tint in rose, heliotrope, claret, maroon, crimson, and other rich and rare shades. Unsurpassed for bedding and for cutting... The twelve sorts offered below were selected out of a large collection as being the best and most distinct.

- Clara Butt.** Soft salmony-pink, tinged with blush. \$1.00 per doz.; \$6.00 per 100.
- Farncombe Saunders.** Rich brilliant scarlet; extra fine. \$1.00 per doz.; \$6.00 per 100.
- Glow.** Brilliant; glowing vermilion, blue centre. 50 cts. per doz.; \$3.00 per 100.
- Gretchen (Margaret).** Outside of petals delicate blush; inside soft rose; very pretty. 50 cts. per doz.; \$3.00 per 100.
- Loveliness.** Satiny rose, margined blush. 50 cts. per doz.; \$3.00 per 100.
- Mme. Krelage.** Vivid rosy-pink. 60 cts. per doz.; \$4.00 per 100.
- Mrs. Potter Palmer.** Rich glowing purple. 50 cts. per doz.; \$3.00 per 100.

Mixed Darwin Tulips. Our supply of these comes from a specialist who grows over 50 sorts, most of which are represented in this mixture. 25 cts. per doz.; \$1.50 per 100; \$13.00 per 1000.

- Pride of Haarlem.** Immense flowers of deep rose, shaded scarlet, with electric blue centre. 50 cts. per doz.; \$3.50 per 100.
- Rev. Ewbank.** Bright heliotrope; very distinct. 60 cts. per doz.; \$4.00 per 100.
- Salmon King.** Dazzling rosy-scarlet. 60 cts. per doz.; \$4.00 per 100.
- The Sultan.** This might be called **The Black Tulip**, being a rich, glossy, black maroon. Extra fine. 50 cts. per doz.; \$3.00 per 100.
- White Queen.** Clear white, slightly tinged with delicate blush. 50 cts. per doz.; \$3.50 per 100.

Collections of Darwin Tulips.

3 each of the above 12 sorts, 36 in all	\$1 75	12 each of the above 12 sorts, 144 in all	\$ 6 00
6 " " " 12 " 72 "	3 25	25 " " " 12 " 300 "	10 00



Double Tulips.

While not equal to the single in brilliancy, the double varieties last much longer in bloom. The early varieties, such as Duc Van Thol, Murillo, Titian, Imperator Rubrorum, and the Tournesols, are excellent for forcing. The later sorts will not bear forcing, but are very effective in beds or borders. A combination or solid bed of the pure white and bright scarlet varieties, La Candeur and Rex Rubrorum is especially effective. The average height of each in inches is prefixed.

If Tulips are wanted by mail, add 5 cts. per doz. for postage.

Height, Inches.	Per Doz.	Per 100.
10. Couronne d'Or (Crown of Gold), Golden yellow; beautiful. \$28.00 per 1000	\$0 50	\$3 00
9. Duke of York . Carmine rose bordered with white. \$12.00 per 1000	25	1 50
6. Duc Van Thol . Red edged yellow. \$10.00 per 1000	20	1 25
9. Gloria Solis . Deep crimson, with gold margin. \$15.00 per 1000	25	1 60
8. Imperator Rubrorum . Bright scarlet. \$26.00 per 1000	40	2 75
8. La Candeur . Pure white. A fine bedder. \$14.00 per 1000	25	1 50
6. Murillo . Superb light pink. \$22.50 per 1000	35	2 50
8. Rex Rubrorum . Bright scarlet. A good bedder. \$18.00 per 1000	30	2 00
8. Tournesol . Scarlet broadly edged yellow; fine forcer. \$20.00 per 1000	35	2 25
8. Tournesol Yellow . Bright yellow, shaded orange; fine. \$25.00 per 1000	40	2 75
10. Yellow Rose . Golden yellow; late flowering; fragrant. \$12.00 per 1000	25	1 50

DOUBLE TULIPS MURILLO.

	Per Doz.	Per 100.
8. Rose Blanche . Pure white; fine bedder. \$12.00 per 1000	25	\$1 50
7. Salvator Rosa . Deep rosy pink. \$30.00 per 1000	45	3 25
8. Titian . Red bordered yellow. \$17.00 per 1000	30	2 00

COLLECTIONS OF DOUBLE TULIPS.

3 each of the 14 named varieties, 42 bulbs	\$1 10
6 " " 84 " " 84 "	2 00
12 each of the 14 named varieties, 168 bulbs	\$3 50
25 " " 14 " " 350 "	6 00

DOUBLE MIXED TULIPS.

Dreer's Superb Mixture. A grand mixture of early flowering sorts, growing the same height and blooming together; a large variety of colors. 20 cts. per doz.; \$1.25 per 100; \$10.00 per 1000.

Fine Quality Mixed. A mixture of the cheaper sorts. 15 cts. per doz.; \$1.00 per 100; \$8.00 per 1000.

Double Late Mixed. These come into flower from a week to 10 days later than the above; many of this section bear immense flowers of brilliant colors. 20 cts. per doz.; \$1.00 per 100; \$8.50 per 1000.

PARROT OR DRAGON TULIPS.

Very large flowers of singular and picturesque forms and brilliant colors; very beautiful and interesting. The petals are curiously fringed or cut. They form extravagantly showy flower beds or borders, are of endless variety of form and color, stand a long time when cut, and should be grown in every flower garden in quantity. (See cut.)

Constantinople. Orange-scarlet, with black markings.

Cramoisie Brilliant. Rich deep blood-crimson with blackish markings.

Lutea. Clear yellow, feathered with red and green.

Markgraaf. Yellow flamed scarlet.

Perfecta. Striped yellow and red.

Price. Any of the above, 30 cts. per doz.; \$1.75 per 100; \$15.00 per 1000.

Collections of Parrot Tulips.

6 each of the above 5 sorts, 30 bulbs	\$0 70
12 " " 5 " 60 "	1 10
25 " " 5 " 125 "	2 00
50 " " 5 " 250 "	3 75

Parrot Tulips, Mixed Colors, in great variety. A border of these resembles an Oriental rug in coloring. 20 cts. per doz.; \$1.25 per 100; \$10.00 per 1000.



PARROT OR DRAGON TULIPS.

Collections of Tulips for Beds.



CIRCULAR BED OF SCARLET AND YELLOW TULIPS.

What we say on page 7 about the Hyacinth as a bedding plant is equally true of the Tulip. Many brilliant color effects are possible with Tulips that cannot be produced with any other plant. The culture is the same as for the Hyacinth, only, being perfectly hardy, they do not require to be covered so heavily through the winter, but merely enough to keep the frost from throwing them out of place. When through flowering, the bulbs may be lifted and dried off, and used another year, or they may be left in the ground. The following beds are 6 feet in diameter and require 156 bulbs, planted 5 inches apart each way, and are made up of the most approved sorts:

CIRCULAR BED OF TULIPS "E."

This bed is formed of two outside rows of yellow, the entire centre of scarlet, as shown in the illustration above, and is a most effective combination.

Centre—76 **Belle Alliance**. Scarlet.
Two Outer Rows—80 **Chrysolora**. Yellow.

Price : \$3.00.

CIRCULAR BED OF TULIPS "G."

Section 1. 40 **Kaiser Kroon**. Scarlet edged gold.
" 2. 30 **Belle Alliance**. Scarlet.
" 3. 42 **La Reine**. White.
" 4. 44 **Chrysolora**. Yellow.

Price : \$2.70.

CIRCULAR BED OF TULIPS "F."

This bed is divided into four quarters, each quarter being filled with a distinct color, as under.

Section 1. 39 **Cottage Maid**. Pink.
" 2. 39 **Chrysolora**. Yellow.
" 3. 39 **Pottebakker**. White.
" 4. 39 **Belle Alliance**. Scarlet.

Price : \$2.75.

CIRCULAR BED OF TULIPS "H."

Section 1. 42 **Cottage Maid**. Pink.
" 2. 39 **Pottebakker**. White.
" 3. 39 **Chrysolora**. Yellow.
" 4. 36 **Belle Alliance**. Scarlet.

Price : \$2.75.

The combinations can be changed in any of the above beds if so desired.

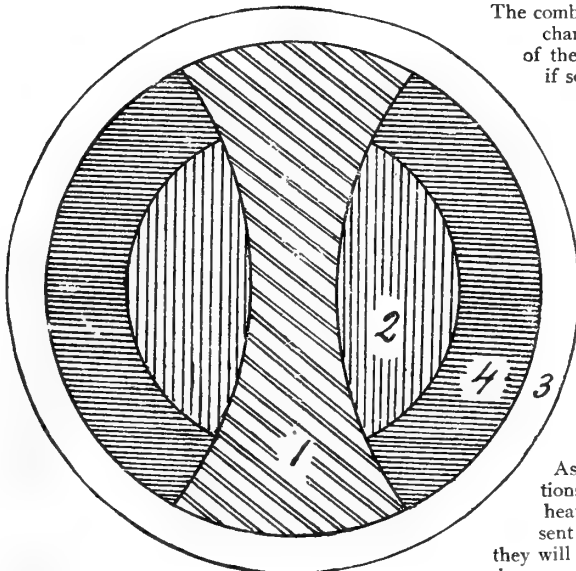

CIRCULAR BED OF TULIPS "G."

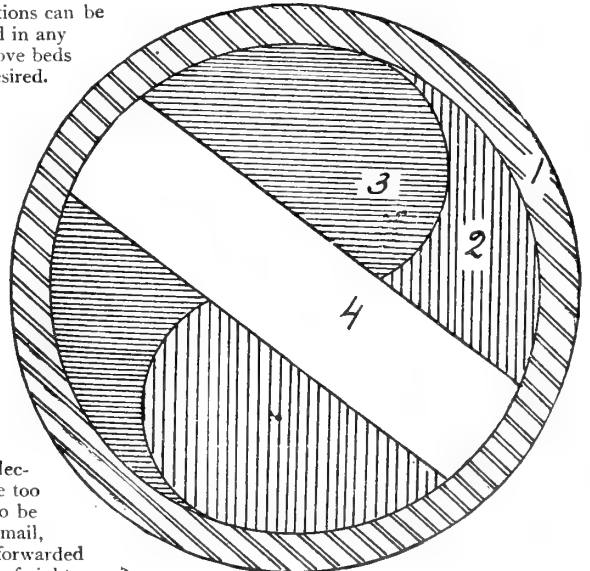

CIRCULAR BED OF TULIPS "H."

As collections are too heavy to be sent by mail, they will be forwarded by express or freight at purchaser's expense.

Narcissus or Daffodils.

There are no hardy bulbous plants which have more points of merit than the Narcissus or Daffodils. Perfectly hardy, growing and doing well in almost any and every position, sun or shade, moist or dry.

All conditions seem to suit them, although they have a preference for a good, deep soil and a semi-shaded position, and every vacant corner in the garden, amongst the grass, under the trees, etc., etc., could not be used to better advantage than by filling with Narcissus. They are equally desirable for pot culture for winter flowering. Three or four bulbs can be put into a 5-inch or 6-inch pot, and, with the same treatment as given to Hyacinths, the dull winter and early spring months can be made bright with their exquisite gold and silver blossoms. But it is outdoors that Narcissus do best, and once planted need no further attention, the clumps multiplying and giving larger and finer results each year, and from an original planting of a few hundred bulbs in two or three years may be cut thousands of flowers without missing them.

NOTE.—We offer Narcissus under 7 distinct heads or types: First, the large trumpet varieties, like Emperor and Empress; second, the medium trumpet sorts, of which Sir Watkin and Mrs. Langtry are examples; third, the small trumpet kinds or the Poeticus group; fourth, the Hoop Petticoat sorts, which really belong in the large trumpet class; fifth, the Jonquils; sixth, the Polyanthus or many-flowered; seventh, the double-flowering sorts.

In describing Narcissus it is usual to give the color of the trumpet or crown and the color of the perianth or petals surrounding the trumpet.



LARGE TRUMPET
NARCISSUS
EMPEROR.

LARGE TRUMPET NARCISSUS.

This type is the showiest of the genus, and also the most useful, growing easily either indoors or in the open ground. Every one of the twelve sorts offered are deserving of extensive planting, and you can set out any of them with full assurance that you will get a bountiful harvest of blossoms in the spring.

If wanted by mail, add 10 cts. per doz. for Large Trumpet Narcissus for postage. Single bulbs mailed free at prices given.

Albicans, "The Great Spanish Daffodil." Perianth white, large, bold primrose trumpet, changing to pure white; a beautiful, chaste flower; delicately musk-scented. 6 cts. each; 50 cts. per doz.; \$3.00 per 100; \$25.00 per 1000.

Bicolor Grandee. Flowers of the largest size, with broad, pure white petals and yellow trumpets, flowering about two weeks later than Empress and valuable for succession. 3 cts. each; 25 cts. per doz.; \$1.65 per 100; \$14.00 per 1000.

Bicolor Victoria. A new variety, perianth creamy-white, trumpet rich yellow delicately perfumed; unsurpassed for pot culture and always satisfactory out of doors. 6 cts. each; 50 cts. per doz.; \$3.75 per 100; \$35.00 per 1000.

Emperor. A magnificent flower; perianth deep primrose; trumpet rich golden-yellow. Should be largely grown in flower beds, borders, or naturalized in grass; it is one of the finest Daffodils in cultivation and much prized for cutting. (See cut.) 5 cts. each; 40 cts. per doz.; \$2.75 per 100; \$25.00 per 1000.

Empress. Perianth snow-white, trumpet rich yellow, serrated and flanged at the edges, large in outline, and of rare beauty for cutting. 5 cts. each; 40 cts. per doz.; \$2.75 per 100; \$25.00 per 1000.



LARGE
TRUMPET
NARCISSUS
GOLDEN SPUR.
Offered on next page.

LARGE TRUMPET SORTS.—Continued.

Giant Princeps. One of the most popular; perianth sulphur white; trumpet rich yellow. As a forcing variety it is superior in every way, and a fine sort for naturalizing. (See cut.) 3 cts. each; 25 cts. per doz.; \$1.25 per 100; \$10.00 per 1000.

Glory of Leiden. "The King of Daffodils." Well named and deserving of the title, being the most massive of all the yellow trumpets, flowers held boldly erect on stout, strong stems, and, unlike many floral aristocrats, it is of the easiest culture, and is as much at home grown in pots as out in the garden. You cannot be considered to have a good collection of daffodils without Glory of Leiden. (See cut.) 20 cts. each; \$1.75 per doz.; \$12.00 per 100.

Golden Spur. Large, spreading full, deep rich yellow perianth and trumpet. A charming, richly perfumed flower, and one of the very best of the Golden Trumpets, flowering early and freely. (See cut on page 14.) 5 cts. each; 40 cts. per doz.; \$2.50 per 100; \$22.00 per 1000.

Henry Irving. Remarkable for its deep yellow, imbricated, wheel-shaped perianth and large trumpet of a lovely golden-yellow hue; a fine variety for any purpose. 5 cts. each; 40 cts. per doz.; \$2.50 per 100; \$20.00 per 1000.

Horsfieldi. A Royal flower and very similar to Empress; perianth pure white; trumpet rich yellow. It comes into bloom early, and is one of the very finest for cutting. 5 cts. each; 40 cts. per doz.; \$2.50 per 100; \$22.00 per 1000.

Maximus. "Hale's Vase of Beaten Gold." A grand deep golden-yellow flower. For cutting this variety is unexcelled; succeeds best in a heavy moist well enriched soil. 6 cts. each; 50 cts. per doz.; \$3.00 per 100; \$28.00 per 1000.

Trumpet Major (Single Van Sion). A large and shapely flower of a rich yellow color throughout. Comes into bloom early and is excellent for forcing, bedding or naturalizing. 3 cts. each; 25 cts. per doz.; \$1.50 per 100; \$12.00 per 1000.



LARGE TRUMPET NARCISSUS GLORY OF LEIDEN.



LARGE TRUMPET NARCISSUS GIANT PRINCEPS.

Collections of Large Trumpet Sorts.

3 each of the 12 varieties, 36 bulbs	\$ 1 50
6 each of the 12 varieties, 72 bulbs	2 75
12 each of the 12 varieties, 144 bulbs	5 00
25 each of the 12 varieties, 300 bulbs	9 00
50 each of the 12 varieties, 600 bulbs	17 00

If wanted by mail, add 10 cts. per doz. for postage on Large Trumpet Narcissus. Single bulbs mailed free at prices given.

HOOP PETTICOAT NARCISSUS.

Bulbocodium. Exceedingly pretty flowers, of a rich citron-yellow. It is a gem for pot culture and edgings, and bears from 6 to 12 flowers to each bulb. 5 cts. each; 50 cts. per doz.; \$3.50 per 100.

Bulbocodium Monophyllum (Clusi). Pure white; very early blooming. 6 cts. each; 60 cts. per doz.; \$4.00 per 100.

NARCISSUS IN MIXTURE.

For planting among shrubbery, in unused corners, or for naturalizing in grass, where they may remain undisturbed for years, these are, without doubt, one of the best hardy bulbs, coming into bloom early and supplying an unfailing source of cut flowers.

If wanted by mail, add 5 cts. per doz. for postage on Mixed Narcissus.

Single Varieties. A splendid mixture, containing a great many fine varieties and none of the undesirable kinds; sure to produce satisfactory returns. 20 cts. per doz.; \$1.00 per 100; \$8.00 per 1000.

Double Mixed Narcissus. See page 17.



STAR NARCISSUS. SIR WATKIN.

The Poet's Narcissus.

(*Narcissus Poeticus*.)

This is the old-fashioned favorite type, with white flowers, the cups margined with red and with rich, spicy odor. For indoor culture the *Ornatus* is best. All do well in the open border, are perfectly hardy, and once planted take care of themselves. The illustration on page 2 shows how they lend themselves for naturalizing.

If wanted by mail, add 5 cts. per doz. for postage on Poet's Narcissus.

Biflorus. Pure white perianth, with soft yellow crown, 2 to 3 flowers on each stalk; late-flowering; very sweetly-scented. 20 cts. per doz.; \$1.25 per 100; \$9.00 per 1000.

Burbidgei. Pure white flowers, cup edged with rich cinnabar-red; earliest to bloom; much prized for cutting. 20 cts. per doz.; \$1.25 per 100; \$9.00 per 1000.

Poeticus (*Pheasant's Eye* or *Poet's Narcissus*). Flowers snow-white, with beautiful cup suffused with bright orange-red; blooms in May; very fragrant. 15 cts. per doz.; 75 cts. per 100; \$6.00 per 1000.

Poeticus Ornatus. The most perfect form of the Poet's Narcissus. It is more symmetrical than the old Poeticus, and blooms almost a month earlier; flowers large, pure white, cup margined with scarlet and as fragrant as the type. 20 cts. per doz.; \$1.00 per 100; \$8.00 per 1000.

COLLECTIONS OF POET'S NARCISSUS.

6 each of the 4 varieties, 24 bulbs	\$0.35
12 " " " 4 " 48 "65
25 " " " 4 " 100 "	1.00
100 " " " 4 " 400 "	3.50

Nonsuch, Peerless, Chalice-cup or Star Narcissus.

This class is also known as the medium trumpets, and comprises some of most beautiful and graceful forms. All are especially adapted for naturalizing, being of free growth and multiplying rapidly.

If wanted by mail, add 6 cts. per doz. on Star Narcissus.

Barril Conspicuus. Perianth soft yellow; broad-spreading cup; magnificently illuminated with scarlet; a most distinct and beautiful sort; the admiration of everyone, and should be grown in quantity for cutting, as it lasts longer when cut than most sorts. 20 cts. per doz.; \$1.25 per 100; \$10.00 per 1000.

Cynosure. Large primrose perianth; cup yellow; stained with orange-scarlet; remarkably showy; a fine sort for cutting. 20 cts. per doz.; \$1.25 per 100; \$8.00 per 1000.

Figaro. A large and well-formed flower, with spreading lemon-yellow perianth; cup yellow, shaded with orange. 20 cts. per doz.; \$1.25 per 100; \$10.00 per 1000.

Incomparabilis. Yellow, with orange cup; very free-flowering and splendid for planting in grass and for cutting. 20 cts. per doz.; \$1.25 per 100; \$10.00 per 1000.

Leedsii Mrs. Langtry. Pure white perianth, broad and overlapping, large white cup, edged bright canary-yellow; free bloomer and exquisite as a cut flower. 20 cts. per doz.; \$1.25 per 100; \$10.00 per 1000.

Sir Watkin. "Giant Chalice Flower," or "Big Welshman." A gigantic flower, the largest in this section; perianth sulphur-yellow; cup slightly deeper in color and tinged with orange; fine for pot culture; in fact, does well everywhere. 35 cts. per doz.; \$2.25 per 100; \$20.00 per 1000.

Stella. One of the first to bloom; flowers star-shaped; pure white with yellow cup; large, wonderfully free-blooming and one of the very best for general decoration or for cutting. 20 cts. per doz.; \$1.00 per 100; \$7.50 per 1000.

COLLECTIONS OF STAR NARCISSUS.

3 each of the above 7 varieties, 21 bulbs	\$0.40
6 " " " 7 " 42 "75
12 " " " 7 " 84 "	1.25
25 " " " 7 " 175 "	2.25
50 " " " 7 " 350 "	4.00



POET'S NARCISSUS. (NARCISSUS POETICUS).

For best results plant your bulbs as soon after the first frost as possible.

JONQUILS.

(*Narcissus Jonquilla* and *Odorus*.)

All of the Jonquils are prized for their graceful, golden, fragrant blossoms and the ease with which they may be grown. Half a dozen bulbs can be put in a 5-inch pot, and with the same treatment as recommended for Hyacinths (see page 3) a fine display can be had from January to April. Their cost is so trifling that liberal planting should be made outdoors. A clump of 50 or more bulbs put here and there among shrubbery or interspersed in the hardy border or naturalized in the grass gives an indescribably rich effect in the early spring, while a vase of the cut blooms will fill a room with the rich, spicy odor.

Single Sweet-scented (*Narcissus Jonquilla*). Rich buttery yellow; not as large a flower as the others, but most fragrant and very free-flowering. 15 cts. per doz.; 85 cts. per 100; \$7.00 per 1000.

Campernelle (*Narcissus Odorus*). A grand variety, producing freely large yellow flowers, very sweetly scented; a strong grower, doing well in almost any position. 20 cts. per doz.; \$1.00 per 100; \$7.50 per 1000.

Campernelle Rugulosus. The largest and finest of all Jonquils; a handsome flower; color pure yellow; very fragrant. 20 cts. per doz.; \$1.25 per 100; \$10.00 per 1000.

Double Sweet-scented. Full double golden-yellow; highly fragrant. 25 cts. per doz.; \$1.75 per 100; \$15.00 per 1000.

Collections of Jonquils.

12 each of the above 4 varieties	\$0 75
25 " " " 4 "	1 25
50 " " " 4 "	2 25
100 " " " 4 "	4 00

Jonquils mailed free at dozen rates.



CAMPERNELLE JONQUILS.

DOUBLE DAFFODILS.

No collection of *Narcissus* is complete without the double-flowering sorts. While not as attractive as many of the single varieties, they possess a charm peculiarly their own. All are perfectly hardy, and are much in demand for cutting.

If wanted by mail, add 8 cts. per doz. for postage on Double Daffodils.

Van Sion (*Telamonius plenus*). The famous old Dutch Daffodil; flowers golden yellow, large and of fine form. This variety is used in enormous quantities for forcing; also excellent for bedding in conjunction with Hyacinths, flowering at the same time.

Extra Selected Double-nosed Bulbs. Each bulb will produce at least two flowers and frequently three or more. 6 cts. each; 50 cts. per doz.; \$3.00 per 100; \$25.00 per 1000.

Selected Single-nose Bulbs. Each bulb will produce at least one fine flower and often two. 30 cts. per doz.; \$1.75 per 100; \$15.00 per 1000.

Incomparable (Butter and Eggs). Orange and yellow; of large size and good shape. 25 cts. per doz.; \$1.50 per 100; \$12.00 per 1000.

Orange Phoenix (Eggs and Bacon). Light citron, with orange centre; a beautiful, artistic blossom, and easily forced. 30 cts. per doz.; \$1.75 per 100; \$14.00 per 1000.

Sulphur or Silver Phoenix (Codlins and Cream). Creamy-white, with pale sulphur centre. Considered the finest of the double sorts. 6 cts. each; 50 cts. per doz.; \$3.00 per 100; \$25.00 per 1000.

Alba Plena Odorata (*Double Poet's Narcissus* or *Gardenia Daffodil*). Double, pure white; very sweet-scented. This beautiful variety cannot be forced. It succeeds best planted on rather heavy soil, in partial shade, and where it will not suffer from lack of moisture. 20 cts. per doz.; \$1.00 per 100; \$8.50 per 1000.

Collections of Double Daffodils.

3 each of the 5 varieties	\$0 40
6 " " 5 "	70
12 " " 5 "	1 25
25 " " 5 "	2 25

Double Mixed Daffodils.

A good mixture, and just the thing for planting in odd corners for cutting. 20 cts. per doz.; \$1.00 per 100; \$8.50 per 1000.



DOUBLE NARCISSUS, ORANGE PHENIX.

Polyanthus Narcissus, or NOSEGAY DAFFODILS.

Beautiful, free-flowering, deliciously sweet-scented flowers, of the easiest culture; suitable for forcing or for growing in water in the same way as the Chinese Sacred Narcissus. They bear tall spikes of bloom, with from 6 to 20 flowers each. Bulbs planted in the open border in November stand the winter with protection.

If wanted by mail, add 10 cts. per doz. for postage on Polyanthus Narcissus.

Paper White Grandiflora. An improved large-flowering form of the Paper White, possessing all the good qualities of that popular and easily-grown variety, and which, on account of its larger flowers, is now the principal forcing sort. As shown in the illustration at the bottom of this page, it does splendidly in water, like the Chinese Sacred Lily.

Selected bulbs, 4 cts. each; 30 cts. per doz.; \$1.75 per 100; \$15.00 per 1000.

Mammoth bulbs. Of special value for growing in water. 5 cts. each; 40 cts. per doz.; \$2.25 per 100; \$20.00 per 1000.

Double Roman. White, with double yellow centre; very fragrant. 4 cts. each; 30 cts. per doz.; \$1.50 per 100; \$12.00 per 1000.

Grand Monarque. Fine large trusses of white flowers, with primrose cups. Very effective. 5 cts. each; 35 cts. per doz.; \$2.50 per 100.

Grand Primo. Cup citron, perianth pure white; excellent for cutting. 5 cts. each; 35 cts. per doz.; \$2.50 per 100.

Grand Soleil d'Or. A charming rich yellow flower, with deep reddish cup. 5 cts. each; 35 cts. per doz.; \$2.50 per 100.

Staten General. White, with orange cup; very early. 5 cts. each; 35 cts. per doz.; \$2.50 per 100.

White Pearl. Large, pure, satiny white; beautiful. 5 cts. each; 35 cts. per doz.; \$2.50 per 100.

Mixed Polyanthus Narcissus. 4 cts. each; 30 cts. per doz.; \$1.75 per 100; \$15.00 per 1000.

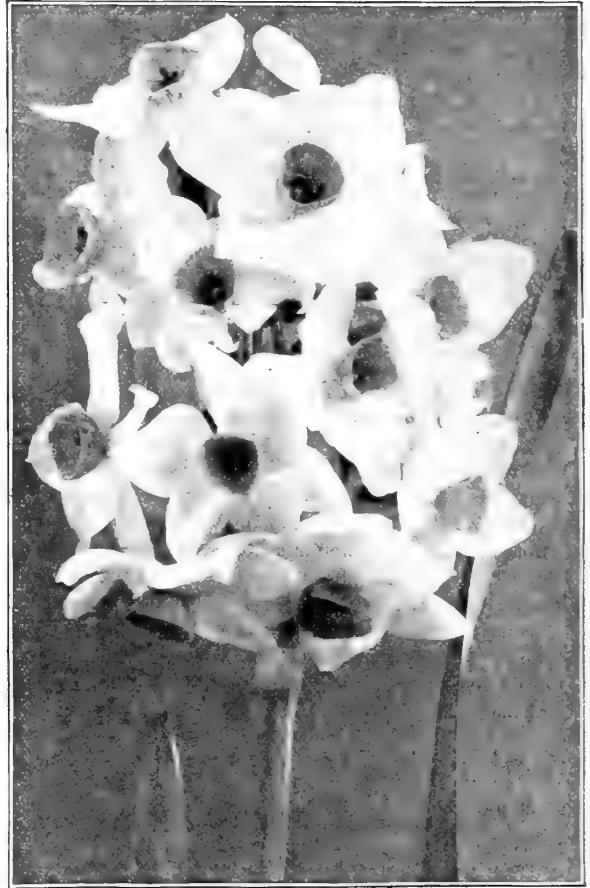

POLYANTHUS NARCISSEUS.

COLLECTIONS OF POLYANTHUS NARCISSEUS.

3 each of the above 7 named sorts, 21 bulbs	60	12 each of the above 7 named sorts, 84 bulbs	\$2 00
6 " " " 7 " " 42 "	\$1 10	25 " " " 7 " " 175 "	3 75



NARCISSEUS PAPER WHITE GRANDIFLORA.
Grown in a bowl in water and pebbles.

Chinese Sacred Lily.

(Soy Sin Far, Joss Flower, or Flower of the Gods.)

This is the *Narcissus Orientalis*, and the variety grown by Chinamen for decorating their temples or Joss-houses on their New Year's Day, which occurs in February. For the most part they are grown in water in fancy bowls, with just enough pebbles around them to keep them from toppling over. They can also be grown in pots in soil, sand or moss. We annually import from China a large quantity of the finest quality bulbs, and if planted on arrival (about October 1st) they will flower by Christmas, and a succession of flowers can be had by making several plantings. The white and yellow flowers are borne in clusters, and are highly scented. *Large bulbs,* 10 cts. each; 3 for 25 cts.; 90 cts. per doz. Original baskets, containing 30 bulbs, \$2.00.

If wanted by mail, add 3 cts per bulb for postage.

LILY BOWLS, for Chinese Sacred and Polyanthus Narcissus.

Imari. Fine Japanese ware, highly decorated in red, blue, green, etc.; exceedingly attractive. To hold 1 bulb, 15 cts. each; for 2 bulbs, 25 cts. each; for 3 bulbs, 35 cts. each.

Imitation Cut Glass. To hold 1 bulb, 15 cts. each; for 2 bulbs, 20 cts. each; for 3 bulbs, 25 cts. each.

PEBBLES, for filling Lily Bowls, 10 cts. per quart.

Lily Bowls and Pebbles cannot be sent by mail, but only by express or freight, at customer's expense.

Miscellaneous Bulbs and Roots.

(Unless otherwise specified, all Bulbs and Roots are ready for delivery in September.)



BURBANK'S HYBRID AMARYLLIS.

ALSTROMERIA.

Chilensis (*Chilian Lily*). A tuberous-rooted plant, 2 ft. high, with spikes of showy flowers, varying from rose-white to deep orange and red, flowering from July to September. Set the roots 4 inches deep. In exposed situation requires protection. (*Ready in November.*) 15 cts. each; \$1.50 per doz.

AMARYLLIS (Hippeastrum).

The Amaryllis is pre-eminently a window-garden plant for the amateur, producing under the simplest conditions one, two or even three spikes, two feet or more high, which are crowned with from three to six large and gorgeous trumpet-shaped blooms, which last long in good condition. For full cultural directions see page 121 of our Garden Book for 1909.

Nehrling's Florida Hybrids. This grand strain is the result of over 20 years' selection of crosses made between such magnificent varieties as Empress of India, Enchantress, the long-tubed, fragrant Solandriiflora, as well as the finest English and Continental hybrids of more recent introduction. These crossings and recrossings, combined with careful selection, have resulted in a strain of strong, vigorous growth, producing from four to six flowers on a stalk, which are perfectly circular in outline and of enormous size, ranging in color from deep crimson to dazzling orange-scarlet and from light rose to almost pure white, the darker varieties generally being striped with a band of white, the lighter-colored ones having bright crimson lines and variegations. 75 cts. each; \$7.50 per doz.

Burbank's Hybrids. The bulbs we offer have been received direct from Mr. Luther Burbank, the famous hybridizer, and represent the result of years of careful crossing and selecting, and is a magnificent strain in every way. Very strong bulbs, 75 cts. each; \$7.50 per doz.

Aulica Platypetala (*Lily of the Palace*). Immense flowers of intense crimson, tipped green. 75 cts. each; \$7.50 per doz.

Equestre (*Barbadoes Spice Lily*). Bright orange-scarlet with a white star-shaped centre; quite fragrant. 15 cts. each; \$1.50 per doz.

Johnsonii. Very large flower, of a rich crimson-scarlet color, striped with white. 30 cts. each; \$3.00 per doz.

Prince of Orange. Large flowers; orange, intermingled with white and green. 50 cts. each; \$5.00 per doz.

Solandriiflora conspicua. Striped white, green and rose. 75 cts. each.

Vittata Hybrids. Beautiful striped, flaked and feathered varieties; grown for us by a European specialist. 50 cts. each; \$5.00 per doz.

One each of the above 8 Amaryllis for \$4.00.

AGAPANTHUS (African Lily).

Splendid ornamental plants, bearing large clusters of bright blue and pure white flowers on long flower stalks, and lasting a long time in bloom. There is no finer plant than this for outdoor decoration, planted in large pots or tubs on the lawn, terrace or piazza. It does well in the house or greenhouse in winter, requiring but slight protection. It is a rapid grower and gross feeder, and the chief point in its cultivation is to divide the plants before the pots or tubs become overcrowded with roots. Strong clumps.

Umbellatus. Bright blue. | — **albus.** Pure white. 15 cts. each; \$1.50 per doz. One of each for 25 cts.

ALLIUMS.

Bulbous plants of the very earliest culture, requiring little attention and giving good returns.

Neapolitanum. An excellent variety for winter flowering, extensively forced by florists for cut flowers. Its flower stems are 20 inches high, supporting a large cluster of delicate white starry flowers; sure to bloom splendidly in any window. (See cut.) 15 cts. per doz.; \$1.00 per 100; \$7.00 per 1000.

Hermetti grandiflorum. A variety similar to the preceding, but dwarfer and better adapted for pot culture. 15 cts. per doz.; \$1.00 per 100; \$8.00 per 1000.



ALSTROMERIA.

Aureum (*Golden Lily Leek*). Bright yellow; perfectly hardy; blooms in June; excellent for naturalizing. 15 cts. per doz.; 75 cts. per 100; \$6.00 per 1000.

Azureum. A beautiful variety, throwing up in spring slender stems 2 feet high, surmounted by a large umbel of lovely azure-blue flowers; perfectly hardy. 6 cts. each; 60 cts. per doz.; \$4.50 per 100.

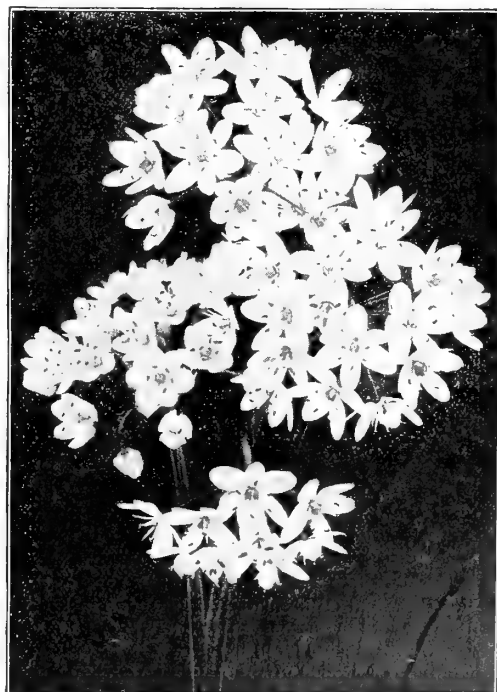

ALLIUM NEAPOLITANUM.



SINGLE ANEMONES.

ANTHERICUM.

Liliastrum (St. Bruno's Lily). A beautiful plant, 2 feet high, with narrow grass-like foliage and long spikes of white, fragrant, Lily-like flowers in May and June. 10 cts. each; \$1.00 per doz.; \$7.00 per 100.

Liliastrum Giganteum (Giant St. Bruno's Lily). A wonderful improvement on the St. Bruno's Lily, of which it is a gigantic form. It produces 2½ feet high stems, which during May and June are terminated by spikes of very large white flowers, and forcibly remind one of a miniature Liliium Candidum. A striking novelty. 30 cts. each; \$3.00 per doz.

Liliago (St. Bernard's Lily). A pretty species, bearing spikes of white flowers 18 inches high during May and June. 10 cts. each; \$1.00 per doz.; \$7.00 per 100.

BABIANA.

A charming genus with leaves of dark green, thickly covered with downy hairs, and bearing showy spikes of flowers. They should have the protection of a cold frame, and are very successfully grown in pots. Height, 6 to 9 inches.

Mixed Varieties. 4 for 10 cts.; 25 cts. per doz.; \$1.75 per 100.

BRODIAEA.

Handsome bulbous plants from the Pacific Slope, blooming in pendant clusters on long, slender stems. It is easily forced, and may be grown in the greenhouse or cold frame, or if planted out in clumps or masses will flower freely in June or July. Perfectly hardy.

Coccinea (Floral Firecracker). Flowers 1½ to 2 inches long; a rich, glowing crimson tipped with pea-green; a striking plant. (See cut.) 4 cts. each; 40 cts per doz.; \$3.00 per 100.

Mixed Varieties. In many beautiful colors. 4 for 10 cts.; 25 cts. per doz.; \$1.50 per 100.

CALOCHORTUS (Mariposa, or Butterfly Tulp).

Very beautiful California bulbs, blooming in summer. The flowers are of rich and brilliant colors in various shades of white, purple and yellow, borne on stiff, slender stalks, 8 to 20 inches high, from a few to 15 or 20 flowers a stalk. (See cut.)

Mixed. A selection of the hardiest varieties. 3 for 10 cts.; 30 cts. per doz.; \$2.00 per 100.

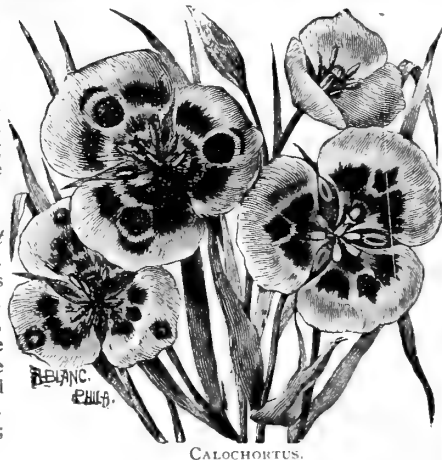

CALOCHORTUS.

Anemone Fulgens.

(Scarlet Windflower.)

The anemone Fulgens is one of the most attractive and desirable flowers for winter forcing or early spring blooming. Its dazzling vermilion flowers are very pretty, and are borne in profusion. The cut flowers are invaluable, lasting a long time in water 3 for 10 cts.; 30 cts. per doz.; \$2.00 per 100.



ANTHERICUM LILIASTRUM GIGANTEUM

POPPY ANEMONES.

(Windflower.)

The varieties offered below are charming hardy spring flowers, and are becoming better known and more popular as a garden flower. Both double and single are equally desirable, and no garden should be without them. They are suitable for pot or border culture, and when planted in masses are most effective. They succeed best in a light, rich, well-drained loam. Plant in November, or as soon as the ground can be worked in the spring. If planted in the autumn, they should be covered with leaves, straw, or long manure on the approach of winter. For pot culture, fill with any rich, porous compost, with good drainage, planting 4 roots in a 5-inch pot; place in a cold frame, or any moderately cool situation, giving very little water until the plants appear; then remove to greenhouse or sitting-room window.

DOUBLE POPPY ANEMONES.

Duchess of Lorraine. Deep rose, large and full.

Harold. Intense bright blue.

Ceres. White delicately tinted rose.

Rosette. Delicate rose; a beautiful shade.

L'Eclair. Brilliant, striking scarlet.

Price, any of the above, 3 for 10 cts.; 35 cts. per doz.; \$2.50 per 100.

Double Mixed. All colors, 4 for 10 cts.; 25 cts. per doz.; \$1.50 per 100; \$12.00 per 1000.

SINGLE POPPY ANEMONES.

	Doz.	100	1000
Single Brilliant Scarlet	\$0 20	\$1 25	\$10 00
Single White (The Bride).....	20	1 00	7 50
Single Mixed. All colors.....	20	1 00	7 00

CALLA LILIES.

White Calla (*Richardia Æthiopica*). The White Calla, or Lily of the Nile, is a well-known plant of easy culture, and in winter is one of our best window plants. To aid profuse blooming keep them dormant from the middle of June until the last of August; repot in good, rich soil, using 6 to 8-inch pot, give water, light and heat in abundance, and the result will be most satisfactory.

Good	roots, 10 cts. each;	\$1.00 per doz.;	\$7.50 per 100.
Large	“ 15 “	1.50 “	10.00 “
Mammoth	“ 25 “	2.50 “	18.00 “

Black (*Arum Sauctum*). This interesting variety from the Holy Land resembles in habit and foliage the White Calla, with flowers of a rich purple color over a foot in length and 4 to 6 inches across; the spike or spadix is about 10 inches long, and of an ebony-black color. 15 cts. each; \$1.50 per doz.

Spotted-leaf (*Richardia alba maculata*). The leaves of this variety are deep green, with numerous white spots, which give the plant a very ornamental appearance. The flowers are white, with a black centre; they grow freely either indoors or out. 10 cts. each; \$1.00 per doz.

Golden Yellow (*Richardia Elliottiana*). A rare and beautiful variety; it has the same habit of growth as the ordinary White Calla, with flowers of the same size and shape, but of a rich, clear, lustrous golden-yellow color; the foliage is dark green, with a number of translucent creamy-white spots, which add much to its beauty. A large stock enables us to offer strong bulbs at the very low price of 25 cts. each; \$2.50 per doz.

One each of the above 4 Callas, strong roots, for 60 cts.



WHITE CALLA LILY.

CHIONODOXA.

(Glory of the Snow.)

These are among the most beautiful of our spring-flowering bulbs, coming into flower soon after the snow is gone. Grows well in any good garden soil, and when once planted requires no further care. Looks best when planted in lines or clumps of 25 or more bulbs.

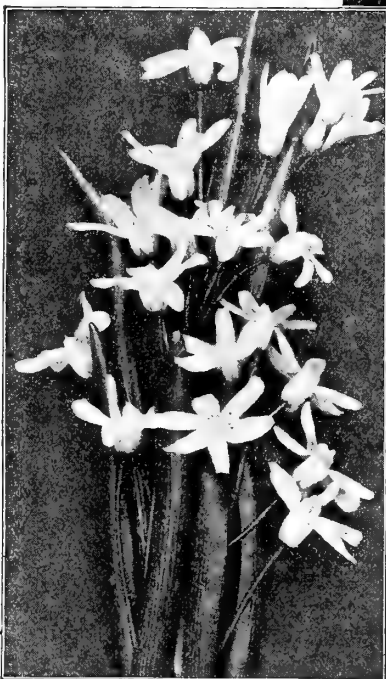

CHIONODOXA LUCILLA.

Lucilla: Flowers of a brilliant sky-blue color, with white centre. 15 cts. per doz.; \$1.00 per 100; \$8.00 per 1000.

Lucilla Gigantea. A very distinct and beautiful species, with very large flowers of soft lavender-blue, and white centre. 25 cts. per doz.; \$1.50 per 100; \$12.00 per 1000.

Sardensis. A strikingly beautiful, brilliant genetian-blue flower. A gem among spring bulbs. 15 cts. per doz.; \$1.00 per 100; \$8.00 per 1000.

Tmoulsi. Very large flowers of deep indigo-blue. 25 cts. per doz.; \$1.50 per 100; \$12.00 per 1000.

CLIVIA (Imantophyllum).

Miniatum. A pretty lily-like plant of the easiest culture, and most desirable house plant; it flowers during the spring and summer months, remaining in bloom for a long period. In color it is of a fine orange red, shading to buff. Strong growing plants, 50 cts. each.

DREER'S GIANT CYCLAMEN.

There are few winter-flowering bulbs more attractive than the Cyclamen, being an ideal plant either for greenhouse or window decoration. The Giant strain here offered is of robust growth, throwing the large flowers well above the handsome foliage. It is often a hard matter to get dry bulbs started into growth. We therefore send out only nicely started plants, which we feel sure will produce grand results. We can furnish any of the following colors:

White, Rose, Blood-red and White with carmine eye.
25 cts. each; \$2.50 per doz.; by mail, 5 cts. each extra.



GIANT CYCLAMEN.



GIANT NAMED CROCUS.

MIXED CROCUS.

The bulbs offered under this head are smaller than our Giant Named sorts, but are quite satisfactory for planting in the grass or for any position out of doors.

Blue and Purple shades,
Striped and Variegated sorts.
White sorts.

Golden Yellow, good bulbs.

Price, any of the above, 10 cts. per doz.;
50 cts per 100; \$4.50 per 1000.

All Colors Mixed. 10 cts. per doz.; 45 cts. per
100; \$4.00 per 1000.

If wanted by mail add 10 cts. per 100 for postage to Mixed Crocus. Dozens mailed without extra charge.

COLCHICUM:

(Autumn-flowering Crocus.)

Autumnale (*Meadow Saffron*). Very effective and handsome hardy plants, the flowers of which come through the ground without the leaves in the fall, the leaves appearing the following spring. The flowers comprise many shades of white, purple, rose, striped, etc. 5 cts. each; 50 cts. per doz.; \$3.50 per 100.

Parkinsoni. A distinct and beautiful sort, remarkable for the peculiar arrangement of color in its flowers, they being checkered with dark purple on a white ground; unique. 5 cts. each; 50 cts. per doz.; \$3.50 per 100.



COLCHICUM PARKINSONI.

CROCUS.

This brilliant and universally admired spring flower will thrive in any soil or situation, but to be brought to the highest perfection it should be grown in an open bed or border of deep, rich, sandy loam. When planted in large groups or lines of distinct colors, the effect is very striking, and the bulbs are now offered so cheap as to justify their liberal use. They are invaluable for pot culture. To secure a succession of blooms commence planting early in October, 6 or 8 bulbs in a pot (the named varieties are best for this purpose), using rich soil and planting about an inch deep. Place the pots on a surface of ashes, cover the top one inch deep with soil, until the leaves appear, when they may be removed to the house. They can also be grown in saucers or bowls, in water and pebbles, in the same way as the Chinese Sacred Lily.

DREER'S GIANT NAMED CROCUS.

These are large bulbs of the best varieties, and are remarkable for richness of color and size of their flowers, and are the best to use for pot culture or where extra fine results are wanted.

Cloth of Gold. Golden yellow veined brown on the outside.

King of the Blues. Brilliant purplish blue.

King of the Whites. Purest white, large flower and very free.

Mme. Mina. White, striped lavender blue.

Mammoth Yellow. Golden yellow, very large bulbs, and very free-flowering.

Mont. Blanc. Large pure white.

Purpurea grandiflora. Richest purple, very large flowers.

Sir Walter Scott. White, striped with violet.

Price, any of the above in extra fine bulbs, 15 cts. per doz.; 85 cts. per 100; \$7.50 per 1000. *If by mail, add 20 cts. per 100 to named Crocus.*



MIXED CROCUS IN THE GRASS

CROWN IMPERIALS.

(*Fritillaria Imperialis.*)

Very showy and stately early spring-blooming plants. The flowers are bell-shaped, and are borne in a whorl at the top of the plant, which grows from 3 to 4 feet high. The Crown Imperial will grow well in any good garden soil, and if it can be said to have preferences, it is for a deep loam. At the time of planting the soil should be deeply trenched and well manured. They should be planted 2 or 3 in a clump, 6 inches deep, and then left alone for years. When established they flower abundantly, and the stems should not be cut off, but allowed to decay naturally. A slight covering during the winter is beneficial. (See cut.)

Crown Upon Crown. Bright red. 25 cts. each; \$2.50 per doz.

Yellow. Canary-yellow. 25 cts. each; \$2.50 per doz.

Superfine Mixed. Including red, yellow and shades of orange. 12 cts. each; \$1.25 per doz.; \$7.50 per 100.

If Crown Imperials are wanted by mail, add 2 cts. each for postage.

DIELYTRA, or DICENTRA.

(*Ready in November.*)

Spectabilis (*Bleeding Heart, Seal Flower, or Lyre Flower.*)

An old-fashioned favorite, equally well adapted for forcing as for planting in the open border; its long racemes of graceful heart-shaped pink flowers are always attractive.

Formosa (*Plumy Bleeding Heart.*) A dwarfier-growing species, with finely-cut ornamental foliage, growing about 15 inches high and producing its showy pink flowers from April to August. 15 cts. each; \$1.50 per doz.; \$10.00 per 100.

ERANTHIS HYEMALIS.

(*Winter Aconite.*)

The Winter Aconite is a pretty yellow flower, valuable for its early blooming and contrasting well with the Snowdrops, which are the only flowers to keep it company at the early season in which it blooms. 20 cts. per doz.; \$1.00 per 100; \$8.00 per 1000.

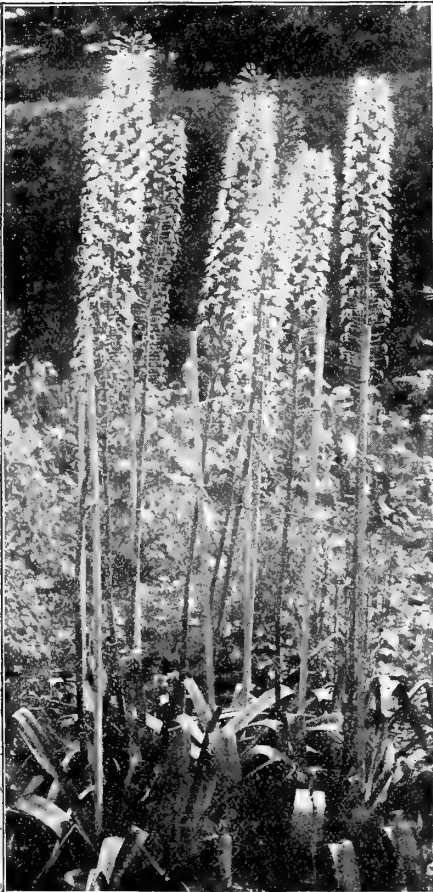

EREMURUS ROBUSTUS.



CROWN IMPERIALS.



ERANTHIS HYEMALIS.

Erythronium.

(*Dog's Tooth Violet.*)

Beautiful hardy plants, especially suited to moist, shady situations; the leaves are handsomely variegated, flower stems about a foot high, bearing lily-like blossoms of different colors; does well in pots; mixed varieties. 20 cts. per doz.; \$1.25 per 100.

EREMURUS.

Robustus. A noble and rare bulbous plant from Turkestan and one of the choicest subjects for the permanent hardy border. They thrive best in a well-drained, sheltered, sunny position, and prefer a deep, sandy loam, to which has been added a liberal quantity of well-rotted cow manure. A covering of 4 or 5 inches of leaves or litter will be beneficial and save the young shoots, which start early, and are liable to be damaged by late frosts. It produces immense flower stems, 6 to 10 feet high, bearing a dense raceme of flesh-pink flowers, each nearly 2 inches across. (See cut.) Extra strong-flowering roots (ready in October), 75 cts. each; \$7.50 per doz.

Himalaicus. Another noble variety from the temperate Himalayan mountains, 4 to 8 feet high. Raceme nearly 2 feet long, of lovely pure white flowers as large as a fifty-cent piece. This is perhaps the hardiest and easiest grown of this magnificent genus. Strong-flowering roots (ready in October), 50 cts. each; \$5.00 per doz.



FRITILLARIA MELEAGRI.

FRITILLARIA.

Meleagris (*Snake's Head, or Guinea Hen Flower*). An elegant species, growing from 10 to 18 inches high, bearing in spring curious drooping bell-shaped flowers, most of which are very oddly marked, many being checkered and splashed white and purple, cream and maroon, etc., etc. (See cut.) Perfectly hardy and splendid for naturalizing, especially in semi-shady places. Mixed colors, 3 for 10 cts.; 25 cts. per doz.; \$1.50 per 100.

Recurva. A beautiful and distinct sort from California, producing as many as a dozen brilliant, clear scarlet flowers, spotted with orange in the throat, on stalks 18 to 24 inches high; excellent for naturalizing. 5 cts. each; 50 cts. per doz.; \$3.00 per 100.

GLADIOLUS. *Ready in October.*

The early flowering sorts offered below are now largely used for forcing, coming into bloom in May. The flowers are of good size, and borne freely on long stems; 6 bulbs can be planted in a 6-inch pot. They can also be planted outdoors, being hardy with slight protection.

The Bride. A lovely pure white. 20 cts. per doz.; \$1.25 per 100; \$10.00 per 1000.

Blushing Bride, or Delicatissima. Ivory-white, with carmine blotch on the lower petals. (See cut.) 25 cts. per doz.; \$1.50 per 100; \$12.00 per 1000.

Peach Blossom. A lovely shade of peach blossom pink. 25 cts. per doz.; \$1.50 per 100; \$12.00 per 1000.

MAY-FLOWERING, COTTAGE GARDEN or BOULEVARD TULIPS.

You have a treat in store if you have never grown this beautiful class of Tulips. We offer a splendid collection on pages 10 and 11, and ten of the most popular kinds are illustrated on the covers of this catalogue.

FREESIA.

This is one of the most beautiful of all Cape bulbs, possessing a peculiar grace of form, and its fragrance is most delightful, one pot of five or six bulbs being sufficient to perfume a whole house. As cut flowers they are extremely valuable; the unexpanded blooms, opening in water, fill the air with the most delicate perfume, and their endurance is really remarkable. They force very easily, and can be had in flower at Christmas, and continue in succession until June. When potted these should not be placed in a dark place, like most other bulbs, but should be put directly in the light.

Refracta Alba. Pure white; delightfully fragrant.

Mammoth bulbs, 30 cts. per doz.; \$1.75 per 100; \$15.00 per 1000.

Selected bulbs, 20 cts. per doz.; \$1.25 per 100; \$10.00 per 1000.

Leichtlinii. Large, pure yellow; fragrant. 25 cts. per doz.; \$1.50 per 100.

FUNKIA (Plantain Lily).

The Plantain Lilies are among the easiest plants to manage; their broad, massive foliage makes them attractive subjects for the border even when not in flower; they deserve extensive cultivation.

Cerulea. Blue, broad, green leaves.

Glauca. Large, showy, glaucous-green foliage, lilac flowers.

Robusta elegans variegata. A decided improvement on all variegated varieties, producing foliage fully double the size of the popular *F. undulata media picta*, which in variegation it closely resembles. 30 cts. each; \$3.00 per doz.

Subcordata grandiflora. Pure white, lily-shaped, fragrant flowers.

Undulata media picta. Green and white variegated foliage, purple flowers.

Thos. Hogg. Broad, glaucous foliage, with white border.

Price, except where noted, 15 cts. each; \$1.50 per doz.; \$10.00 per 100. Set of 6 varieties for 75 cts.



FREESIA REFRACTA ALBA.



GLADIOLUS BLUSHING BRIDE.

HEMEROCALLIS (Yellow Day Lily).

Popular hardy tuberous plants, belonging to the Lily family.

Aurantiaca. Large trumpet-shaped, bright orange-yellow, sweet-scented flowers during June and July. 25 cts. each.

— **Major.** Very free-flowering, sweet-scented deep orange flowers; July and August; requires protection. 50 cts. each.

Dumortieri. Flowers of a soft rich yellow, exterior bronzy-orange; in June and July.

Florham. Produces very large golden-yellow, sweet-scented flowers during June and July. This variety is of American origin, and is one of the best. 25 cts. each.

Flava (Yellow Day Lily). Large, fragrant flowers during July and August; 3 feet high.

Fulva (Tawny Day Lily). Tawny orange-colored flowers, excellent for planting among shrubbery; blooms in July and August.

— **Fl. Pl.** The double-flowering Tawny Day Lily.

Gold Dust. Very large golden-yellow flowers in July and August. 25 cts. each; \$2.50 per doz.

Middendorffii. A handsome, deep golden-yellow variety, growing 1½ to 2 feet high; June and July.

Thunbergii. One of the latest-flowering varieties, producing its sweet-scented lemon-yellow flowers on 2½ feet high stems in August and September.

Price (except where noted), 15 cts. each; \$1.50 per doz.; \$10.00 per 100. Set of 10 varieties, \$2.00.

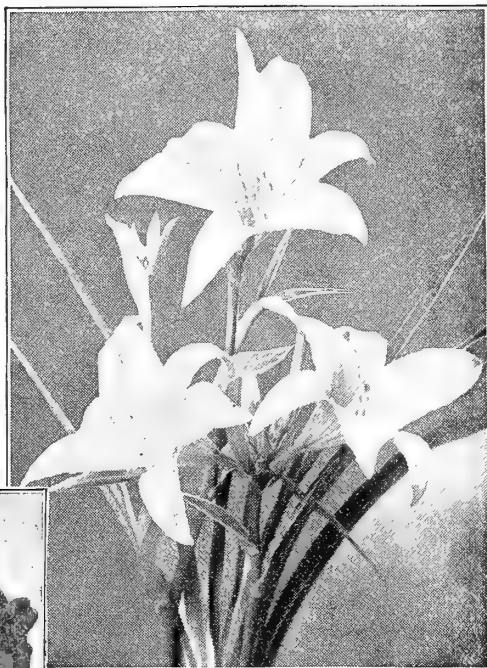

HEMEROCALLIS FLORHAM.

HELLEBORUS.

(Christmas Rose.)

Most valuable hardy plants on account of yielding, at a season when flowers are scarce, their beautiful large blossoms. They succeed in any ordinary garden soil, but prefer a sheltered, semi-shaded situation. (*Strong-flowering clumps ready in November.*) 30 cts. each; \$3.00 per doz.



INCARVILLEA DELAVAYI.

INCARVILLEA.

(The Hardy Gloxinia.)

(Ready in October.)

Delavayi. A hardy tuberous-rooted plant, with beautiful trumpet-shaped flowers of a deep rose-carmine color, with yellow throat, borne in clusters on stems 18 inches high.

Grandiflora. A new variety, with flowers one-half larger than the above and of a brighter color.

25 cts. each; \$2.50 per doz.

IXIAS (African Corn Lily).

These charming half-hardy bulbs, from the Cape of Good Hope, are very ornamental for indoor culture, or planted outdoors in well-drained and protected borders. They are graceful in growth. The flowers are of the most brilliant, rich and varied hues. (See cut.)

Crateroides. Fiery scarlet, large blooms. 25 cts. per doz.; \$1.50 per 100.

Mixed. All colors. 12 cts. per doz.; 75 cts. per 100; \$6.00 per 1000.

VARIOUS IRIS.

Gracilipes. A miniature variety from Japan, with delicate lilac flowers. 25 cts. each; \$2.50 per doz.

Ochroleuca Gigantea. A noble species, growing 4 feet high, with large, pale-yellow flowers. 25 cts. each; \$2.50 per doz.

— **Aurea.** A golden-yellow form. 25 cts. each; \$2.50 per doz.

Pallida folia variegata. Conspicuous on account of its beautifully variegated foliage, which is evenly marked with broad bands of creamy-yellow. Flowers are soft, pale lavender. 50 cts. each; \$5.00 per doz.

— **argentea variegata.** Identical to above, but with silvery-white variegation. 75 cts. each.

Pumila hybrida Cyanea. Rich purple, with blackish shadings, } 20 cts. each;

— **Eburna.** Pure white, with creamy-white shadings, } \$2 per doz.

— **Florida.** A beautiful lemon-yellow, shaded darker, }

— **Formosa.** Upper petals deep violet, lower petals light violet, }

Sibirica. Purplish-blue flowers on slender scapes 3 feet high; useful for cutting. 15 cts. each; \$1.50 per doz.

— **Alba.** White, veined with pale lilac. 15 cts. each; \$1.50 per doz.

— **Orientalis.** Rich violet-blue; very free. 15 cts. each; \$1.50 per doz.

— **Snow Queen.** A new variety of great merit; forms an attractive plant; flowers snow-white. 25 cts. each; \$2.50 per doz.



IXIAS.

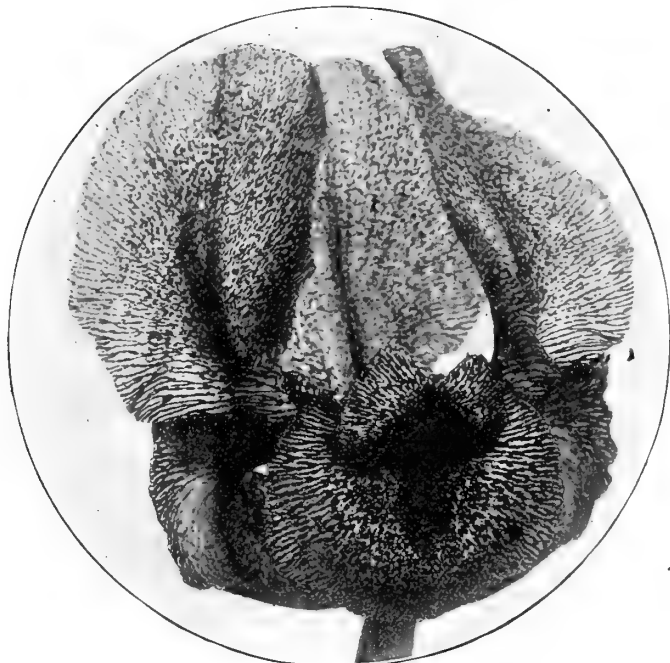

IRIS SUSIANA (Mourning Iris).

PEACOCK IRIS (*I. Pavonia*).

An exquisite small variety; flowers pure white, with a blue triangle on each petal; 1 foot. 4 for 10 cts.; 25 cts. per doz.; \$1.50 per 100.

ENGLISH IRIS (*I. Anglica*).

Somewhat like the Spanish Iris, but with larger flowers and coming into bloom later. They have quite a range of color, with rich purple, blue and lilac predominating; grows 18 to 20 inches high; perfectly hardy.

Mont Blanc. A beautiful pure white. 4 cts. each; 40 cts. per doz.; \$2.50 per 100.

Mixed. All colors. 25 cts. per doz.; \$1.50 per 100; \$12.00 per 1000.

SPANISH IRIS (*Iris Hispanica*).

These have appropriately been called "the Orchids of the Hardy Flower Garden," some of the choicest Orchids being their only rivals, and even they can hardly be said to exceed them in richness, variety and beauty. They are of the simplest culture, succeeding in almost any soil or position. The bulbs should be planted 2 to 3 inches deep and 6 inches apart, early enough in the autumn to allow them to make some growth before hard frost comes. For best effect they should be planted in beds or groups of 25 to 100 or more bulbs—the larger the number the finer the effect. They flower in June, and the bulbs may either be lifted or allowed to remain for another season.

They are also splendid for pot culture. Put 4 to 6 bulbs in a 5-inch pot and treat the same way as Hyacinths, except that they should not be brought in for flowering much before March. We offer the following select sorts:

- Belle Chinoise.** Golden yellow.
- British Queen.** The finest pure white.
- King of the Blues.** Rich dark blue.
- Louise.** Pale pearl blue.
- Chrysolora.** Clear canary-yellow.
- Reconnaissance.** Rich dark bronze.

Any of the above 15 cts. per doz.; \$1.00 per 100; \$6.00 per 1000.

Mixed Spanish Iris. 12 cts. per doz.; 75 cts. per 100; \$5.00 per 1000.

Collections of Spanish Iris. 12 each of the 6 named sorts for 75 cts.; 25 each of the 6 named sorts for \$1.40; 100 each of the 6 named sorts for \$3.50.

BULBOUS IRIS.

(Flowering Flag—Fleur-de-Lis.)

Hardy spring and summer-blooming plants, bearing large, rich and various-colored flowers. They are of easy culture, and thrive in any good garden soil. The whole family have claims on the attention of amateurs on account of their excellent faculty of taking care of themselves if properly planted in the first instance. No garden should be without some of the varieties, especially as they are valuable for cutting.

MOURNING IRIS (*I. Susiana*).

In that wonderful combination of form and coloring of the rare sweet flower we call the Iris (the eye of heaven) there is none so peculiarly beautiful as *Susiana*. It stands out in its own right as the grandest of all species. The groundwork of the flower is silvery-gray, so mottled and veined and lined with dark chocolate and black as to leave one under the impression that it is only a silver lining showing through. It is perfectly hardy without the slightest protection, blooming early in spring. No description can do it justice. It must be seen to be appreciated. (See cut.) 12 cts. each; \$1.25 per dozen; \$8.00 per 100.

IRIS RETICULATA.

(Netted Bulbous Iris.)

One of the prettiest and sweetest of spring flowers, coming into bloom with the Crocus. It is absolutely hardy, and will grow almost anywhere. The flowers are of royal purple and gold, and are borne freely on stems about 4 inches high, followed by grassy-like leaves 1 foot in height. It does beautifully indoors, six or more bulbs in a pan or pot making an exquisite display in midwinter. 10 cts. each; \$1.00 per doz.; \$7.00 per 100.



SPANISH IRIS.

JAPANESE IRIS (Iris Kämpferii).

These magnificent Iris are among the most beautiful of our summer-flowering plants, and are becoming more popular each season. They commence blooming about the middle of June, and continue for five or six weeks. Many of these flowers measure from 10 to 12 inches in diameter, and rival the orchids in their rich colorings. While this Iris succeeds in almost any soil and condition, it delights in a rich, deep, moist position.

(It would take a page or more to accurately describe these beautiful Iris. Below we merely give the general color effect. Order by name or number.)

SINGLE JAPANESE IRIS.

Very large artistic flowers with three petals.

- No. 1. **Iso-no-nami.** Silvery white, veined throughout with violet.
- No. 11. **Hano-no-nishiki.** Violet-purple, veined with white.
- No. 12. **Shippo.** Light lilac, densely veined purple.
- No. 14. **Shishi-ikari.** White ground, densely veined dark purple.
- No. 15. **Gekka-no-nami.** A very early pure white.
- No. 16. **Kumoma-no-sora.** Silvery white, suffused throughout with soft light blue; the largest three-petaled variety in cultivation.
- No. 23. **Yedo-kagami.** Magenta-lilac, delicately veined white.
- No. 55. **Shuchinkwa.** Crimson purple, white veins and centre; a showy variety.
- No. 62. **Misutmoshito.** White, marbled violet purple.
- No. 77. **Yayaura.** White, marked light violet.



JAPANESE IRIS.

Price, 25 cts. each; \$2.50 per doz.; \$15.00 per 100. Set of ten, \$2.00.

DOUBLE-FLOWERING JAPANESE IRIS.

Under this head we offer the very choicest sorts, having flowers with six large petals.

- No. 4. **Yomo-no-umi.** The finest double white.
- No. 5. **Koki-no-iro.** Light violet, with white veins.
- No. 13. **Yedo-jiman.** Rich royal purple.
- No. 26. **Uchiu.** Bright crimson purple, with white veins.
- No. 35. **Shishi-odori.** Rich velvety purple.

- No. 47. **Renjo-no-toma.** Light lilac, suffused violet.
- No. 69. **Waku-hotel.** White, veined with violet-blue.
- No. 72. **Uji-no hotaru.** Bright violet purple, shaded blue.
- No. 74. **Ohime.** White, densely marbled and spotted purple.
- No. 91. **Kan-ran.** White, densely veined with rich violet.

Price, 25 cts. each; \$2.50 per doz.; \$15.00 per 100. Set of ten, \$2.00.

Extra Choice mixed varieties, containing both single and double, 15 cts. each; \$1.50 per doz.; \$10.00 per 100.

GERMAN IRIS (I. Germanica).

The German Iris is one of the most desirable early spring-flowering plants. The flowers are of large size and of exquisite colors. No garden is complete without a collection of these beautiful "Flags." We offer the following choice sorts:

- Cherion.** Standards lilac-mauve; falls violet-mauve.
- Florentina Alba.** Very free-flowering white.

- Edith.** Standards light plumbago-blue, falls purple.
 - Gazelle.** White frilled rich mauve.
 - Julius Cæsar.** Standards amber; falls deep purple.
 - Johan de Witt.** Standards bluish-violet; falls deep violet-purple veined with white.
 - Jordan.** Standards and falls light mauve.
 - L'Avenir.** Standards and falls ageratum-blue.
 - Lord Salisbury.** Standards amber-white; falls dark violet-purple.
 - Maori King.** Standards golden-yellow; lower petals chocolate, veined white and edged yellow. 25 cts. each; \$2.50 per doz.
 - Mrs. Neubronner.** The finest golden-yellow. 25 cts. each; \$2.50 per doz.
 - Mme. Chereau.** Standards and falls pure white; daintily edged with light blue.
 - Plicata.** Standards and falls bright violet-purple.
 - Rembrandt.** Standards light lavender; falls deeper.
 - Shakespeare.** Standards straw-yellow, veined with burnt amber; falls deep carmine-violet.
 - Spectabilis.** Light and deep violet-purple.
 - Souvenir.** Standard lemon; falls canary, veined purple.
 - Velveteen.** Standards pale amber; falls creamy-white, veined mauve.
- Price: Any of the above (except where noted), 15 cts. each; \$1.50 per doz.; \$10.00 per 100. Set of 18 varieties, \$2.25.
- Mixed German Iris, 10 cts. each; \$1.00 per doz.; \$6.00 per 100.



GROUP OF GERMAN IRIS NATURALIZED ON EDGE OF BROOK.



LILIAM AURATUM (Golden-banded Japanese Lily).

Auratum (*Golden-banded Lily*). Undoubtedly one of the finest. Its large, graceful, fragrant flowers are composed of six petals of a delicate ivory-white color, thickly studded with chocolate crimson spots, and striped through the centre a golden-yellow; 3 to 5 feet; July-September. (See cut.)

8 to 9-inch bulbs, 15 cts. each; \$1.25 per doz.; \$8.00 per 100.
 9 to 11 " " " 20 " " 1.75 " " 12.00 "
 11 to 13 " " " 30 " " 2.50 " " 18.00 "

Auratum Rubro-vittatum. This splendid variety has a band of red running through each petal instead of the gold band as in the type; 3 to 4 feet; August. 50 cts. each; \$5.00 per doz.

Batemanniae. Bright, apricot-tinted flowers; 3 feet; July. 15 cts. each; \$1.50 per doz.; \$10.00 per 100.

Brownii. Large trumpet-shaped flowers, internally pure white; externally rich purple; 4 feet; July-August. 50 cts. each; \$5.00 per doz.

Canadense. Bright crimson, with dark spots; 2 to 3 feet; June and July. 10 cts. each; \$1.00 per doz.

Candidum (*Annunciation or Madonna Lily*). This is one of the most popular of garden Lilies. The flowers are pure snow-white, and very fragrant, borne on long stems. To succeed with it, it should be planted early in the autumn, so that it can make some growth before frost; give the bulbs a light dusting with powdered sulphur, and do not cover with more than 2 inches of soil; 3 to 4 feet; May-June. (See cut.)

	Each.	Doz.	100
Large bulbs	12	\$1.00	\$6.00
Extra large bulbs	15	1.25	8.00
Mammoth " "	20	1.50	10.00

Croceum (*Orange Lily*). One of the easiest Lilies to grow; bright orange, borne in an umbel of 5 to 10 erect flowers; 3 to 4 ft.; July. 10 cts. each; \$1.00 per doz.; \$7.00 per 100.

LILIUMS.

Single Bulbs of Lilies mailed free at prices given; rates on larger quantities do not include postage.

To the Lily must be awarded the first place among hardy bulbs; their beauty and fragrance are unequalled by any other class of plants. The genus embraces a vast number of species; we, however, confine our list to such as are of easy culture, and give the best results with the least care. It is in the hardy border, or among shrubbery, that Lilies do best, as they get the benefit of the shade of the surrounding plants, which is so necessary for their welfare. In planting, cover the bulbs at least three times their own depth, and when hard frost sets in 4 to 6 inches of leaves or litter should be placed over them; this should be removed in spring, when danger from hard frost is past. When grown in pots it is advisable to begin with the smallest size pot in which the bulbs can be placed, and to shift into larger pots as the plant progresses. A cool temperature suits them best, and the plants should be liberally watered during the period of growth and flowering.

SPECIAL NOTICE. *Lily bulbs will be forwarded as they mature. As a rule, we can furnish Candidum and Harrisii from August on. Canadense, Elegans, Longiflorem, Superbum and Tenuifolium from end of September on. The entire balance in late October and November.*

Auratum, Kramerii and the Speciosum varieties come from Japan, and are usually received early in November. They are liable to delays of steamers, freight blockades, etc., and we advise the preparation of the Lily beds or borders early in autumn, covering them with 4 to 6 inches of leaves or litter of any kind. This will keep them open and admit of the planting of the bulbs even if not received until December.

Elegans (*Umbellatum*.) This class includes some of the most beautiful Lilies; flowers erect, borne in clusters; colors of the richest hues of yellow and red; fine for planting in masses. Mixed varieties 1 to 2 feet; July. 10 cts. each; \$1.00 per doz.; \$6.00 per 100.

Elegans Incomparable. Intense deep red; one of the richest of this easily grown group; 2 feet; July. 15 cts. each; \$1.50 per doz.; \$12.00 per 100.

Excelsum. This remarkable Lily produces from 8 to 12 nodding, rich, apricot-hued blooms; very sweet-scented; 4 to 6 feet; July. 50 cts. each; \$5.00 per doz.

Giganteum. A splendid species of gigantic growth and very distinct; the stems grow 6 to 10 feet high, and frequently bear 12 to 20 large flowers 5 to 6 inches long; color creamy white, with a purple throat; blooms in the summer. Large flowering bulbs, \$1.00 each; \$10.00 per doz.

Hansonii. Deep golden-yellow, conspicuously spotted with purple. A thrifty grower and very hardy; 3 to 4 ft.; June. 50 cts. each; \$5.00 per doz.



LILIAM CANDIDUM (Annunciation or Madonna Lily).

LILIUMS—Continued.

Single bulbs of Lilies mailed free at prices given. Rates on larger quantities do not include postage.

Harrisii (*Bermuda Easter Lily*). This magnificent Lily is undoubtedly the best for winter forcing, as it comes quickly into bloom. The flowers are trumpet-shaped, pure white, gracefully formed and delightfully fragrant. The bulbs should be potted in early fall in rich soil, and the pots plunged in sand, where they should be allowed to remain until the approach of cold weather. The freedom with which the flowers are produced is truly remarkable; even the smallest bulbs blooming freely.

	Each.	Per doz.	Per 100.
Fine bulbs (5 to 7 inches)	10 cts.	85 cts.	\$ 6 00
Extra bulbs (7 to 9 inches)	20 cts.	\$1 75	12 00

Henryi. This beautiful and rare variety closely resembles the speciosum type, and has been called the "Yellow Speciosum," the flowers being a rich apricot-yellow with a few brown spots. Grows 3 to 5 feet high, is perfectly hardy and invariably does well. 75 cts. each; \$7.50 per doz.

Krameri. Large flowers, of a soft, beautiful rose color; 2 to 2½ feet; June-August. 20 cts. each; \$2.00 per doz.; \$15.00 per 100.

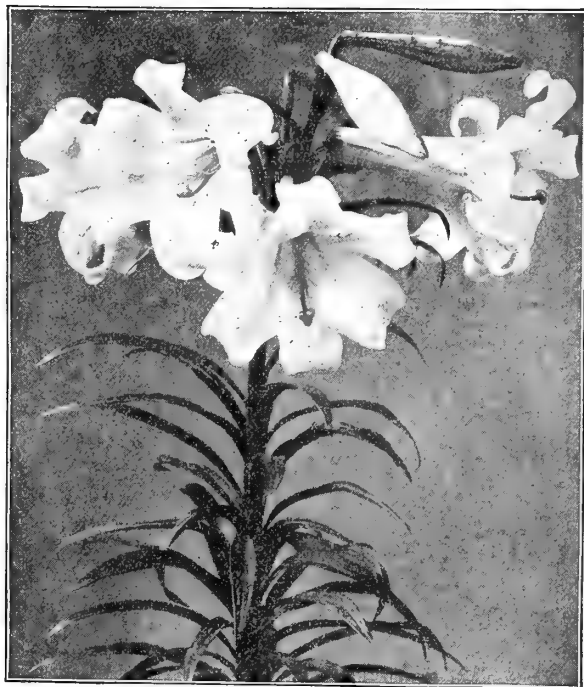

LILIUM HARRISII (Bermuda Easter Lily).

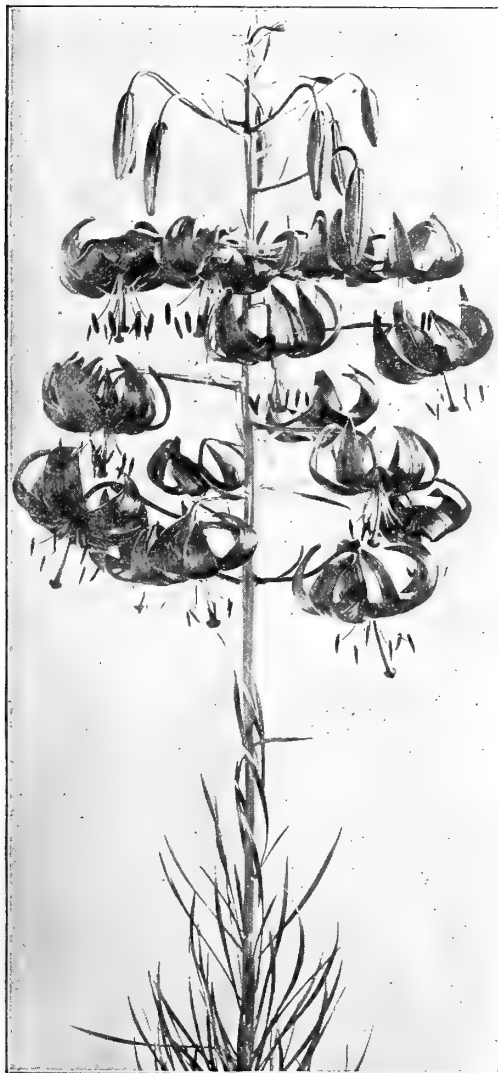

LILIUM TENUIFOLIUM "Golden Gleam."

Longiflorum Multiflorum. Pure white trumpet-shaped flowers. Splendid for growing in pots for Easter flowering, and very desirable for outdoor planting, being quite hardy; 2 to 3 feet, according to strength of bulb; blooms in June outdoors.

	Each.	Doz.	100.
6 to 8-inch bulbs,	08	75	\$ 5 00
7 to 9 " "	12	\$1 00	7 50
9 to 10 " "	20	1 75	12 00

Superbum. A beautiful native variety; bright reddish-orange, spotted; 3 to 6 feet; August. 12 cts. each; \$1.25 per doz.; \$8.00 per 100.

Speciosum Album. The Speciosum or Lancifolium are the most important of all the Japanese Lilies, always satisfactory; the variety here offered has large white flowers of great substance, with a greenish band running through the centre of each petal.

	Each.	Doz.	100.
8 to 9-inch bulbs,	20	\$1 75	\$12 00
9 to 11 " "	30	2 50	18 00

Speciosum Rubrum, or Roseum. White, heavily spotted with rich crimson spots.

	Each.	Doz.	100.
8 to 9-inch bulbs,	15	\$1 25	\$ 8 00
9 to 11 " "	25	2 00	12 00

Speciosum Magnificum. Magnificent large flowers of rich deep red. 18 cts. each; \$1.50 per doz.; \$10.00 per 100.

Tenuifolium "Golden Gleam." A new variety of unusual merit, having all the characteristics of the Coral Lily except color, which, instead of being red, is a pure golden-yellow, absolutely hardy in all parts of the country, easy to grow and sure to do well. 50 cts. each; \$5.00 per doz.

Tenuifolium (Coral Lily). Bears in profusion medium-sized flowers of perfect form and of a dazzling orange-scarlet; 1 to 2 feet; May. 15 cts. each; \$1.50 per doz.; \$10.00 per 100.

Tigrinum (Tiger Lily). Orange, spotted black; 2 to 5 feet; summer. 10 cts. each; 75 cts. per doz.; \$5.00 per 100.

— **Splendens (Improved Tiger Lily)**. 10 cts. each; 85 cts. per doz.; \$6.00 per 100.

— **Flore Plena (Double Tiger Lily)**. Orange-red spotted with black; double, showy flowers. 12 cts. each; \$1.25 per doz.; \$7.00 per 100.

Wallacei. Flowers rich vermilion-orange, spotted with rich maroon dots; thrifty grower, and highly satisfactory; 1 foot; August. 10 cts. each; \$1.00 per doz.; \$7.00 per 100.

LACHENALIA.

(Cape Cowslip, or Leopard Lily.)

This beautiful genus of half-hardy bulbs is comparatively rare in this country. The few specimens exhibited at horticultural shows create quite a sensation, owing to their profusion of bloom and their bright, diversified colors, as well as their ornamental foliage. Of easiest growth; can be had in bloom at Christmas, and lasts for a long time.

Pendula. Vigorous species; bright red, tipped with sea-green and purple.

Tricolor. Very free-flowering; spotted yellow flowers, margined with green and red; early.

Nelsoni. A beautiful and distinct variety with golden-yellow flowers; one of the best.

Price: Any of the above, 20 cts. each; \$2.00 per doz. One of each for 50 cts.

LEUCOJUM VERNUM.

(Spring Snowflake.)

Pretty bulbous plants allied to the Snow-drop, but of much stronger and bolder habit, growing in rich soil from 1 to 2 feet high, and producing freely beautiful large white flowers distinctly tipped with green; excellent for cutting. When once planted they take care of themselves, and should have a place in all hardy collections; can also be grown in pots, 25 cts. per doz.; \$1.50 per 100; \$12.00 per 1000.

LILY OF THE VALLEY.

(Ready in November.)

One of the most charming of spring-flowering plants, and can readily be flowered in the house. The pips or crowns are received from Germany during November, and should be planted soon after their receipt. The simplest method for indoor culture is to place a bundle of 25 pips in a 7 or 8-inch pot, filling it up with sand, moss or light soil, allowing the points of the pips to be about an inch above the surface. They should then be placed out of doors and brought indoors as wanted, and put in a shaded place in a temperature of about 70 degrees, and when the spikes are 3 or 4 inches high they may be brought to where they are to perfect their flowers. By having a number of pots and bringing in at intervals, a continuous display can be had throughout the winter and spring months. We recommend clumps as most suitable for outdoor planting.

Extra Selected Pips. Bundle of 25 pips, 50 cts.; \$1.50 per 100; \$12.50 per 1000.

If wanted by mail, add 10 cts per bundle of 25 pips for postage.

Strong Clumps. For outdoor planting, 30 cts. each; \$2.50 doz.; \$17.50 per 100.

Clumps can only be sent by express or freight at purchaser's expense.



MUSCARIA BOTRYOIDES.
(Grape Hyacinths.)

MUSCARIA.

(Grape and Feathered Hyacinths.)

Botryoides (*Grape Hyacinth*). One of the prettiest of early spring-flowering bulbs, growing about 6 inches high and throwing up numerous spikes of clear blue or white flowers, which resemble a miniature bunch of grapes. They are perfectly hardy, and once planted take care of themselves; in clumps or lines they are very effective. 8 to 12 bulbs in a 6-inch pan make a pretty plant for window decoration, blooming at Easter.

Blue Grape Hyacinths. 15 cts. per doz.; 75 cts. per 100; \$6.00 per 1000.

White Grape Hyacinths (*Pearls of Spain*). 20 cts. per doz.; \$1.00 per 100; \$8.00 per 1000.

Monstrosum (*Feathered Hyacinth*). An odd and interesting variety, growing a foot or more high, producing spikes of claret-colored flowers, which are cut up into wavy filaments in such a way as to resemble purple feathers; perfectly hardy and will grow anywhere. 25 cts. per doz.; \$1.25 per 100; \$10.00 per 1000.

Nerine Sarniensis.

(Guernsey Lily.)

A beautiful and easily-grown variety of Amaryllis. The lily-like blossoms are a brilliant crimson, and in sunlight appear as if sprinkled with gold dust; decidedly one of the best winter-flowering bulbs. 25 cts. each; \$2.50 per doz.



LEUCOJUM VERNUM.



LILY OF THE VALLEY.

ORNITHOGALUM ARABICUM.

(Arabian Star of Bethlehem.)

A very showy and distinct species, bearing racemes of white flowers with a black centre, having a sweet aromatic odor; grows 1 to 2 feet in height, and succeeds either outdoors or in pots. Excellent for forcing, and largely used by florists for this purpose. Of the easiest cultivation. (See cut.) 5 cts. each; 40 cts. per doz.; \$2.50 per 100. *If wanted by mail, add 10 cts. per doz. for postage. No extra charge for single bulbs.*



ORNITHOGALUM ARABICUM.

OXALIS.

These are profuse bloomers, and very attractive in the house or conservatory during the winter. Plant 3 or 4 bulbs in a pot; the pot should be kept close to the light to prevent the foliage from growing too long.

Grand Duchess. New varieties of great beauty; of dwarf, sturdy growth, throwing their large, exquisite flowers well above the foliage. Extremely free-flowering, never being out of bloom from November till June. One of the most desirable for window culture. We offer them in three distinct colors, **Pink, White and Lavender.**

Bermuda Buttercup. One of the finest of winter-flowering plants for pot culture; of strong, luxuriant growth. The great profusion of bloom produced in uninterrupted abundance for weeks is astonishing. The flowers are of the purest bright buttercup-yellow. (See cut.)

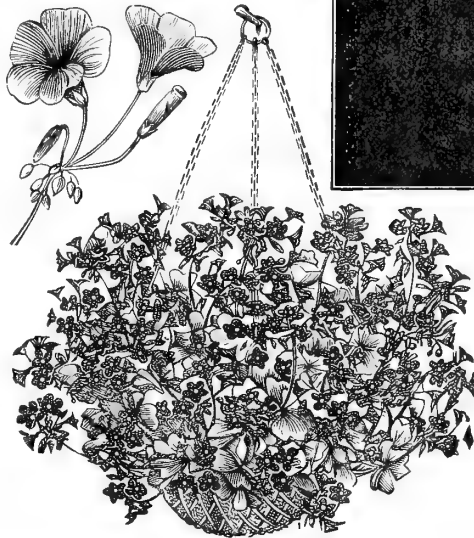

BERMUDA BUTTERCUP OXALIS.

Bowiei. Brilliant carmine-rose.

Double Yellow (*Lutea fl. pl.*).

Versicolor. Red, violet and white.

Price, of any of the above, 4 for 10 cts.; 25 cts. per doz.; \$1.50 per \$100.

Mixed, containing a large number of varieties, 3 for 5 cts.; 15 cts. per doz.; \$1.00 per 100.

PUSCHKINIA.

Libanotica (*Striped Squill*) A beautiful hardy spring-flowering bulb; looks like a gigantic Scilla Sibirica; the flowers, however, are blue-white, with a darker stripe through the centre of each petal. Begins blooming in March, and continues in good condition for weeks. 4 for 10 cts.; 25 cts. per doz.; \$1.50 per 100; \$12.00 per 1000.

RANUNCULUS.

These beautiful dwarf-flowering bulbs delight in a cool, moist atmosphere, and will repay extra care in cultivation. The curious, tooth-like bulbs may be kept out of the ground without injury for a long time, and if planted in spring in a cool, shady situation will generally give satisfactory results. They are also desirable for pot culture and for growing in frames in the spring.

- Persian Mixed.** Rose-shaped flowers; very double.
- Turban Mixed.** Double pæony-formed flowers; many vivid colors.
- French Mixed.** Rare flowers of gorgeous colors.
- Price,** any of the above, 15 cts. per doz.; 75 cts. per 100; \$6.00 per 1000.

TREE PÆONIES (*Pæony Moutan*).

These differ from the herbaceous varieties in their growth, which is in the form of a dwarf shrub; they are equally free-flowering, and commence blooming about three weeks earlier, and while also perfectly hardy they are benefited by slight protection through the winter. The varieties enumerated below have been selected from a large collection, and will be found very interesting.

- Bijou de Chusan.** White, suffused with blush.
- Carolina d'Italie.** Salmon-rose, cream centre.
- Jeanne d'Arc.** Delicate rose.
- Lactea.** Creamy-white, with violet-red spots at the base.
- La Ville de St. Denis.** White, with lilac sheen.
- Louise Mouchelet.** Silvery-rose.
- Mme. Stuart Low.** Semi-double, salmon-rose.
- Maxima plena.** White, with violet-red centre.
- Reine Elizabeth.** Rose color.
- Remembrance of Downing.** Silvery-pink.
- Roseolens odorata.** Delicate salmon-rose.
- Souv. de Ducher.** Deep violet-red.
- Souv. d'Etienne Mechin.** Rich rose.
- Wisconsin.** Delicate pink, with crimson tracings.

Strong plants, \$1.00 each. Set of 14 varieties for \$12.00.



PUSCHKINIA LIBANOTICA.



HARDY HERBACEOUS PÆONIES.

DREER'S Perfect Pæonies.

The Herbaceous Pæonies have always held an important place among hardy plants, and with the wonderful improvements made during recent years have established themselves among the leaders for popular favor. Their requirements are so simple—a good, rich, deep soil and a liberal supply of water during their growing season, being sufficient to give an abundance and wealth of flowers which rival the finest roses in coloring, and produce during their flowering season a gorgeous effect not equalled by any other flower. They are perfectly hardy, requiring no protection whatever even in the most severe climate, are not troubled with insect pests or disease of any kind, and once planted take care of themselves, increasing in beauty each year.

An important point to observe in the planting of Herbaceous Pæonies is not to plant too deep. The roots should be placed so that the crowns are covered with 2 inches of soil. Too deep planting is a frequent cause of shy flowering.

Eight Superb New and Rare

Double Herbaceous Pæonies.

Charlemagne. Rose tinted white; large flowers of good substance.

Duchesse de Nemours. Extra fine, large, pure white; fragrant.

Duke of Wellington. Well formed blooms, sulphur white; fragrant.

Felix Crousse. Large ball-shaped bloom; very brilliant red; one of the finest self-colored varieties. 75 cts. each; \$7.50 per doz.

Francois Ortegat. Brilliant crimson, full, double flower; one of the richest.

Marie Lemoine (Lemoine's). Extra large, free-flowering, ivory white. 60 cts. each; \$6.00 per doz.

Mme. de Verneville. Broad sulphur-white guard petals, centre delicate rosy white.

Mme. Forel. Bright deep pink, shading lighter towards the border.

Price: Any of the above, except where noted, 50 cts. each; \$5.00 per doz. One each of the 8 varieties, \$3.75.

STANDARD VARIETIES DOUBLE HERBACEOUS PÆONIES.

Agnes Marie Kelway. Rosy white guard petals, creamy white centre.

Achille. A beautiful soft mauve rose changing to almost pure white.

Andre Lauries. A fine tyrian rose, late.

Chrysanthemiflora Rosea. A fine large deep rose-pink with paler shadings in the centre. A fine cut flower.

Canary. Guard petals white, centre yellowish changing to pure white.

Duc de Cazes. Guard petals tyrian rose, centre soft rose-pink. Useful for all purposes.

Festiva Maxima. Pure white, centre petals occasionally tipped red. The most popular white for cutting.

Grandiflora rosea. Bright pink, shaded salmon.

Price: Any of the above standard sorts, 25 cts. each; \$2.50 per doz.; \$18.00 per 100. Set of 18 varieties for \$3.75.

JAPANESE SINGLE PÆONIES.

No other plant flowering at the same season can vie with the Single Pæony for beauty, and an established bed, when in full bloom, with the large, silky flowers, and appearing like immense single roses, is simply gorgeous.

Dogrose. Luminous rose, cup-shaped.

Purity. Pure white, suffused with rose towards the centre.

Snowdrift. A beautiful pure white.

Strong roots, 75 cts. each; \$7.50 per doz.

PÆONIA OFFICINALIS.

This type is the real old-fashioned "Pæony," and comes into bloom from ten days to two weeks ahead of the above sorts. All are strong growers, with large, full, double, fragrant flowers.

Alba. Blush-white. **Rosea.** Bright rose-pink.

Rubra. Brilliant, glowing deep crimson.

30 cts. each; \$3.00 per doz. One each for 75 cts.

Grandiflora rubra. Deep crimson carmine, large and full.

Humel. Beautiful rose-pink.

Lady Bramwell. A beautiful silvery rose of fine form.

Louis van Houtte. Brilliant crimson maroon, of good size and very free-flowering.

Ne-plus-ultra. Violet-rose guard petals, centre mauve-rose with lighter edges.

Paganini. Light solferino-red with lighter centre.

Pomponia. Rosy mauve guard petals, primrose-yellow centre, changing to creamy white.

Queen Victoria. A good early white.

Rosea Elegans. Guard petals silvery rose; centre creamy white suffused with rose. A fine large flower.

Zoe Calot. White suffused with delicate rose.

One each of the six varieties for \$3.75.

The Dragon. Deep rosy-crimson; very large.

The Mikado. Fine deep rose.

Venus. Pure white, with yellow centre; very free-flowering.

One each of the six varieties for \$3.75.

PÆONIA TENUIFOLIA FL. PL.

Interesting and handsome, not only on account of their rich crimson double flowers, which resemble in color the Gen. Jacqueminot Rose, but the fine, feathery foliage makes a handsome ornamental plant. 25 cts. each; \$2.50 per doz.

SCILLAS (Squills).

Sibirica. This is one of the prettiest of early spring-blooming bulbs, of dwarf habit, with sprays of exquisite rich blue flowers. Grown in masses, in conjunction with Crocus, Chionodoxas and Snowdrops, the effect is charming. Valuable for edging, and a dozen bulbs in a 5-inch pot make a pretty effect when grown indoors. 20 cts. per doz.; \$1.25 per \$100; \$10.00 per 1000.

Campanulata (*Spanish Blue-bell or Wood Hyacinth*). A beautiful spring-flowering bulb; spikes of bell-shaped flowers in blue, white and rose; fine for naturalizing in the woods, etc.; perfectly hardy and requires no further care when once planted. This is one of the few things that will thrive under pine trees.

	Per Doz.	Per 100.	Per 1000.
Blue	\$0.20	\$1.00	\$ 9.00
Rose25	1.50	12.00
White25	1.25	10.00
Mixed, all colors.....	.20	1.00	8.00

Peruviana (*Cuban Lily*). A charming variety for growing in pots, producing magnificent umbels of rich blue and white flowers; unlike the other sorts, this variety is not hardy. 10 cts. each; \$1.00 per doz.; \$7.00 per 100.

If Scillas are wanted by mail, add 15 cts. per 100 for postage. Dozens mailed without extra charge.

SPARAXIS.

A beautiful class of bulbs, allied to the Ixias, and requiring the same treatment, producing spikes of flowers of the most exquisite and brilliant colors. Mixed varieties. 15 cts. per doz.; 75 cts. per 100; \$6.00 per 1000.



SCILLA SIBIRICA.

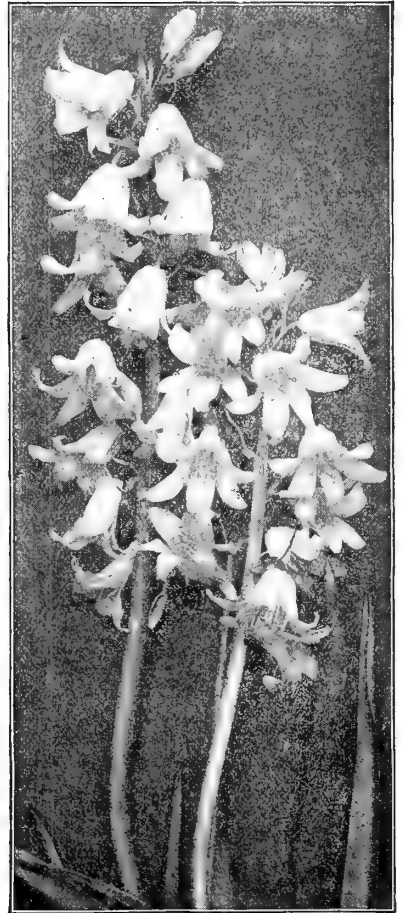

SCILLA CAMPANULATA.

SNOWDROPS (*Galanthus*).

The charming Snowdrop is the first of all flowers to herald the approach of spring. It can frequently be seen in bloom when the ground is white with snow, as it takes every advantage, and hastens to display its graceful snow-white bells before the winter has disappeared. In conjunction with Chionodoxas and Scillas, a matchless effect can be produced. As the bulbs are small, they should be planted liberally in order to obtain immediate results. Banks, grassy slopes, edging or rock-work will suit all of these bulbs. They should not be disturbed often if a fine display is desired.

Elwes' Giant. An exceedingly large and beautiful single variety; flowers snow-white, with emerald-green tube. 15 cts. per doz.; 75 cts. per 100; \$6.50 per 1000.

Single. Pure white graceful bells; early flowering. 15 cts. per doz.; 75 cts. per 100; \$6.50 per 1000.

Double. Flowers perfectly double, pure white. 25 cts. per doz.; \$1.50 per \$100; \$12.00 per 1000.

Giant Cassabah. The largest flowering of all the single Snowdrops. Very showy. The bulbs we offer have been received from Asia Minor, its native habitat. 30 cts. per doz.; \$2.00 per 100; \$18.00 per 1000.

If Snowdrops are wanted by mail, add 10 cts. per 100 for postage. Dozens mailed without extra charge.

STERNBERGIA LUTEA.

(Autumn Daffodil.)

Pretty, hardy autumn-flowering bulbs that deserve to be better known. In appearance they resemble a fine yellow Crocus, and a clump of a dozen or more together with a corresponding clump of Autumn Crocus offered on page 22 gives a touch of spring to the garden in autumn. This is supposed by some writers to be the Lily of Scripture, as it grows abundantly in the Holy Land, from whence our stock was procured. 25 cts. per doz.; \$1.50 per 100; \$12.00 per 1000.



ELWES' GIANT SNOWDROPS.



SPIRÆA GLADSTONE.

TRILLIUM.*(Wood Lily, or Wake Robin.)*

Excellent plants for shady positions in the hardy border, or in a sub-aquatic position, flowering in early spring.

Erectum. This is the purple wood-lily, the earliest to flower.

Grandiflorum. The large white; probably the handsomest.
10 cts. each; \$1 per doz.; \$6 per 100.

TRITELEIA.

Uniflora (*Spring Star Flower*). A pretty little plant, suitable either for pot culture or open border, grows about 6 inches high and bears star-shaped flowers of a delicate blue-white; fragrant. 15 cts. per doz.; 75 cts. per 100; \$6.00 per 1000.

VALLOTA.

Purpurea (*Scarborough Lily*). A valuable free-flowering summer and autumn-blooming Amaryllis; color rich red. It is one of the few really good window plants. 25 cts. each; \$2.50 per doz.

WATSONIA ARDERNEI (*White Bugle Lily*).

A bulbous plant from the Cape of Good Hope, closely allied to and similar in growth to the Gladiolus. It can be grown as a pot plant and flowered in the conservatory or greenhouse, but succeeds best when planted on benches like Carnations or Roses; does finely out of doors in summer. It grows about 4 feet high with branched stems, there frequently being as many as five or six branches on a stem, and bearing many long-tubed open flowers, 2 inches across, of the purest glistening white. As a cut flower for vases it is considered very choice. Extra strong bulbs, 15 cts. each; \$1.50 per doz.; \$10.00 per 100.

ZEPHYRANTHES (*Zephyr Flowers, or Fairy Lilies*).

Beautiful dwarf bulbous plants, somewhat resembling the Crocus in appearance; very effective for planting in the border in May, flowering with great profusion during the summer. They are also most suitable for pot culture. 6 bulbs clustered in a 6-inch pot in the autumn will give a fine display during the winter and spring. (*Ready in October.*)

Alba. Pure white.

Rosea. Large rose-colored flowers.

Price, either of the above, 5 cts. each; 40 cts. per doz.; \$3.00 per 100.

SPIRÆA OR ASTILBE.*(Ready in November.)*

Queen Alexandra. A beautiful new variety, entirely distinct, the color being a soft pink. A strong grower, free-flowering and forces almost as easy as the other sorts. When grown indoors it should be kept cool when flowers are developing, this being necessary to bring out the delicate coloring. 40 cts. each; \$4.00 per doz.

Gladstone. This grand variety is a favorite with the leading growers, who are unanimous in declaring it the finest in existence. The plants form very symmetrical, bushy specimens, and are remarkably free-flowering, a single clump producing from 25 to 40 large snow-white trusses; can be forced even easier than the ordinary Japonica. (See cut.) Strong clumps, 20 cts. each; \$1.50 per doz.; \$10.00 per 100.

Japonica. A splendid plant for forcing in the greenhouse or the conservatory, where it produces beautiful sprays of silvery-white flowers from February till May. It is perfectly hardy, and when planted outside it blooms in June. Strong clumps, 15 cts. each; \$1.00 per doz.; \$6.00 per 100.

Japonica compacta multiflora. A dwarf, very compact-growing variety, with very large, silvery-white sprays. Strong clumps, 15 cts. each; \$1.00 per doz.; \$6.00 per 100.

Japonica aurea reticulata. Flowers pure white, in large clusters, foliage beautiful green, elegantly veined with golden yellow; a very handsome and ornamental plant. 15 cts. each; \$1.50 per doz.

Astilboides floribunda. Large, fluffy, pure white plumes. 15 cts. each; \$1.00 per doz.; \$6.00 per 100.

Palmata. One of the most striking and beautiful hardy plants in cultivation; bright crimson flowers, charming when forced. 15 cts. each; \$1.50 per doz.; \$8.00 per 100.

Spiræas can only be sent by express or freight at customer's expense.

TROPÆOLUM.

Jarrattii. Graceful climbing plant for pot culture, producing richly colored flowers of scarlet, yellow and black in the winter months. 10 cts. each; \$1.00 per doz.; \$7.50 per 100.



TRITELEIA UNIFLORA.



WATSONIA ARDERNEI.

SELECT LIST OF SEASONABLE DECORATIVE AND FLOWERING PLANTS.

For Complete List and Cultural Directions see our Garden Book for 1909.

ABUTILONS.

(Chinese Bell Flower, or Flowering Maple.)

Most desirable free-flowering plants for the conservatory or window garden. Six distinct colors, viz.: White, yellow, orange, pink, red and carmine. 10 cts. each; \$1.00 per doz.

ACACIA.

Armata. A most desirable house plant, succeeding under the same conditions as an Azalea or Camellia; the bright canary-yellow globular flowers are produced in March and April. 50 cts. and \$1.00 each.

ÆSCHYNANTHUS.

Grandiflora. A pretty trailing or basket plant for the warm conservatory, bearing attractive orange-scarlet flowers. 25 cts. each.

AGLAONEMA.

Dwarf-growing Aroids, with pretty, variegated foliage suitable for the warm conservatory.

Costatum. Very compact, heart-shaped leaves of dark, shining green, with white midrib and scattering blotches of white.

Marantæfolium Maculatum. Dark green foliage, beautifully variegated with greenish white.

Pictum. Foliage of rich verdant green, marbled and spotted with deep French-green and silver-grey.

50 cts. each; \$5.00 per doz. One of each for \$1.25.

ALLAMANDA.

Williamsii. This handsome variety is quite dwarf, and forms a compact bush, with trusses of flowers of a very rich, yet delicate, tint of yellow, deliciously scented and in bloom during the greater part of the year. 25 cts. each; \$2.50 per doz.

Hendersonii. A strong-growing-variety, with very large yellow flowers. 25 cts. and 50 cts. each.

ALOCASIAS.

Beautiful subjects for the warm conservatory, with showy, ornamental foliage.

Argyrea. Foliage deep green, with silvery-white ribs and veins. \$1.50 each.

Macrohiza Variegata. Large bright green foliage, with irregular blotches of ivory white. 50 cts. and \$1.00 each.

ALPINIA SANDERÆ.

A handsome new species from New Guinea of this useful class of stove plants, with erect stems and short-stalked glabrous leaves, 4 to 5 inches long by $\frac{3}{4}$ to $1\frac{1}{4}$ inches wide, tapering at both ends; of a rich, shining green, regularly striped at close intervals with broad white bands diverging from the midrib to the margin. \$1.00 each.



ANTHURIUM.



ARAUCARIA EXCELSA.

ANTHURIUMS (Flamingo Flower).

Pretty greenhouse plants that have many good qualities. Their peculiar-shaped flowers of rich colorings frequently last on the plant from two to three months.

Andreanum Hybrids. A fine collection of seedlings in red, rose and white. \$1.00 and \$1.50 each.

Scherzerianum. Brilliant scarlet. 50 cts. and \$1.00 each.

— **Album.** White. \$2.00 each.

— **Majus.** Large scarlet. \$1.00 each.

— **Mme. Dallièrè.** Soft salmon-pink. \$1.00 each.

— **Rothschildianum.** White spotted crimson. \$1.50 each.

— **Sanguineum.** Rich crimson. \$1.50 each.

Magnificum. Olive-green foliage, with silvery veins. \$1.50 each.

APHELANDRA.

Roezlii. A pretty hot-house plant, with silvery green foliage and showy terminal spikes of bright, red-bracted flowers, produced during the late autumn. 25 cts. each; \$2.50 per doz.

ARALIA.

Handsome decorative foliage plants for the stove or warm conservatory; elegant for exhibition purposes.

Chabrierii. Long, narrow, deep green foliage; with crimson-bronze midrib. \$1.00 each.

Elegantissima. Finely-divided, metallic green foliage. \$1.50 each.

Kerchoveana. Foliage rather broad, of a deep, glossy green, relieved by a pale midrib. \$1.50 each.

Veitchii. A handsome species, with narrow leaflets of a dark green above and red underneath. \$1.50 each.

Gracillima. Similar to above, but with narrower foliage. \$1.50 each.

ARAUCARIA (Norfolk Island Pine).

Excelsa. As a decorative plant for the house this is one of the handsomest and most serviceable plants in our collection.

4-inch pots, 6 inches high \$0 50 each.

5-inch pots, 12 inches high 1 00 each.

6-inch pots, 18 inches high 1 50 each.

6-inch pots, 24 inches high 2 00 each.

Excelsa Glauca. Identical with the above, except in the color of the foliage, which is of a bluish or glaucous color.

5-inch pots, 10 inches high . . . \$1.00 each | 6-inch pots, 15 inches high . . . \$2.00 each.

Robusta Compacta. Compact growth, producing even a more symmetrical plant than *Excelsa*; the color is a rich deep green. Strong plants in 5-inch pots, 10 inches high, \$1.50 each; 6-inch pots, 15 inches high, \$2.00 each.



BEGONIA GLOIRE DE LORRAINE.

ARDISIA CRENULATA.

A very ornamental greenhouse plant, with dark green foliage and clusters of brilliant red berries. 25 cts. and 50 cts. each.

ASPARAGUS.

Plumosus Nanus. This graceful variety is finer than the most delicate fern, and is an excellent house plant. 15 cts. and 25 cts. each; \$1.50 and \$2.50 per doz.

Sprengeri. Invaluable as a decorative plant for growing in pots, window boxes, baskets, etc. Strong plants, 15 cts. each; \$1.50 per doz. Extra strong plants, 25 cts. and 50 cts. each; \$2.50 and \$5.00 per doz.

Sprengeri Variegata. A pretty "sport," with every leaf edged white. \$3.00 each.

ASPIDISTRA.

Lurida. A very useful decorative plant; will succeed in any position; an excellent hall or corridor plant. 50 cts., 75 cts. and \$1.00 each.

Lurida Variegata. A pretty variegated form of the above, the foliage being striped with white. 75 cts. and \$1.00 each.

AUCUBA JAPONICA.

A half-hardy evergreen shrub with laurel-like foliage of dark green, freely spotted with bright yellow. A most useful plant for decorative purposes, either as a pot plant for the house in winter or for the lawn in summer. (*Ready in October.*)

Strong bushy plants, 12 inches high, 35 cts. each; specimen plants, 1½ feet high, 75 cts. each; 2 feet high, \$1.50 each.

CHINESE AZALEAS.

The plants we offer are all beautiful specimens. Our collection comprises the cream of the best European establishments. All sizes offered will flower freely in proper season.

First size, 36 to 45 inches in circumference, \$1.50 each; \$15.00 per doz. Second size, 36 inches, \$1.00 each; \$10.00 per doz. Third size, 30 inches, 75 cts. each; \$7.50 per doz. Good bushy young plants, 50 cts. each; \$5.00 per doz. An extra fine lot of specimen plants, 5 to 6 feet in circumference, \$4.00 each; \$45.00 per doz.

BOXWOOD TREES. (Ready in October.)

Pyramid-shaped.

HEIGHT.	DIAMETER AT BASE.	EACH.
30 to 36 inches.	15 inches	\$2 50
36 to 42 "	15 to 18 "	3 50
48 to 50 "	18 to 20 "	5 00
54 to 60 "	20 to 22 "	7 50

Standard, or Tree-shaped.

HEIGHT OF STEMS.	DIAMETER OF CROWN.	EACH.
20 to 24 inches.	12 to 14 inches	\$1 50
20 to 24 "	14 to 16 "	2 50
22 to 24 "	22 to 24 "	4 00

BAY TREES (Laurus nobilis).

Pyramid-shaped.

4½ feet high, 24 to 26 inches diameter at base.	\$ 7 50 each.
5 " " 26 to 28 " " "	10 00 "
6 " " 30 to 32 " " "	12 50 "
6 " " 32 to 34 " " "	15 00 "
7 " " 38 to 40 " " "	20 00 "

Standard, or Tree-shaped.

45 inches high, crown 24 to 26 inches diameter.	\$ 7 50 each.
45 " " 26 to 28 " " "	10 00 "
45 " " 30 to 32 " " "	12 50 "
45 " " 34 to 36 " " "	15 00 "
45 " " 40 to 42 " " "	20 00 "

Begonia Gloire de Lorraine.

Undoubtedly one of the finest winter-flowering plants. It naturally forms symmetrical specimens, requiring no training, and is completely covered with delicate, soft rosy-pink flowers from October to April. Good plants, in 3-inch pots, 25 cts. each; \$2.50 per doz. Strong plants, in 4-inch pots, 50 cts. each; \$5.00 per doz. Extra strong plants, \$1.00 and \$1.50 each.

New Lorraine Begonia Pres. Taft.

An improved form of the above, with larger, expanded flowers of a more intense yet soft pink color. 50 cts. each; \$5.00 per doz.

BEGONIAS.

Alba Picta. Leaves glossy green, spotted silvery-white.

Argentea Guttata. Foliage rich green, spotted silver.

Corallina Lucerna. Gigantic trusses of bronzy-red flowers, and flowering continuously from April to November. The foliage is dotted with silvery-white.

Haageana. Large flowers of a creamy white, with just sufficient pink to give them a bright, cheerful glow.

Metallica. Dark, rough leaves; surface lustrous bronze-green.

Rubra (Coral Begonia). Large, scarlet-rose, wax-like flowers.

Saundersoni. Scarlet flowers; in bloom continually.

Price, 15 cts. each; \$1.50 per doz. Set of 7 varieties, \$1.00.

Begonia Rex (Ornamental-leaved).

A collection of 12 choice sorts. 15 cts. each; \$1.50 per doz.

BOUGAINVILLEA.

Sanderlana. This beautiful free-flowering variety is very popular, especially as a plant for Easter. It is of strong and rapid growth, and brilliant rosy-crimson blossoms are produced from early in March until mid-summer. Altogether it is a most desirable subject for the conservatory or window garden, 25c. each.

William K. Harris. One of the most beautiful variegated foliage flowering plants yet introduced, the foliage being beautifully marbled, with creamy-white on a dark green ground. Valuable for decorative purposes in or out of bloom. Strong plants in 4-inch pots, 50 cts. each.



CHINESE AZALEA.

Camellia Japonica.

A choice assortment of 12 varieties. Fine bushy plants, 15 inches high, 75 cts. each; \$7.50 per doz. Stronger plants, 18 to 20 inches high, bushy, \$1.25 each; \$12.00 per doz.

Select Carnations.

The following are the choicest varieties introduced to date:

- Beacon.** Brilliant free-flowering scarlet.
- Enchantress.** Exquisite delicate pink.
- Guardian Angel.** Very free, fine pink.
- Harlowarden.** Rich crimson.
- Harry Fenn.** Magnificent crimson.
- Irene.** A fine yellow.
- Lady Bountiful.** Pure white.
- Mrs. Patton.** White, beautifully marked with pink.
- Nelson Fisher.** Brilliant cerise.
- Rose-Pink Enchantress.** Rose-pink.
- White Perfection.** Pure white.
- Winsor.** Clear silvery-pink.

Strong plants, prepared for winter flowering, 25 cts. each; \$2.50 per doz.; \$15.00 per 100.



SELECT CARNATIONS.

CHOISYA.

Ternata. A pretty greenhouse shrub, producing very freely sweet-scented, white orange-like blossoms; a most desirable plant for the cool greenhouse or for planting in the open ground in the Southern States, succeeding under the same conditions as a Camellia. Strong plants, 75 cts. each.

Chrysanthemum Frutescens.

(Paris Daisy, or Marguerite.)

California Giant. This is the large white Marguerite that is used so extensively as a cut flower in winter and as a decorative pot plant at Easter.

Etoile d'Or. Identical to the above except in color, which is a fine light yellow.

Queen Alexandra. Pure white flowers from 2½ to 3 inches in diameter, the greater percentage coming full double. The remainder of the flowers on the same plant come semi-double and single, all of which are very handsome.

Blush Queen Alexandra. A variety of the above with flowers of soft rosy white.

15 cts. each; \$1.50 per doz. Set of 4 varieties, 50 cts.

DREER'S PRIZE CINERARIAS.

Our strain of Cineraria cannot be surpassed either for size of flowers or beauty of color. Many of the blooms measure 3 inches in diameter. Fine young plants, ready in October, 10 cts. each; \$1.00 per doz.

CISSUS.

Discolor. A beautiful climber for the conservatory, with marbled crimson and green foliage. 25 cts. each.

CLERODENDRONS.

Balfouri. A beautiful greenhouse climber, and admirably suited for house culture; flowering most profusely with bright scarlet flowers, enveloped in a creamy-white calyx. 15 cts. each; \$1.50 per doz.

Falax. A beautiful variety, with very bright scarlet flowers, produced during August and September in many-flowered terminal panicles; it is of shrub-like habit and a grand plant for the warm conservatory. 25 cts. each.

COLOCASIA.

Neo Guinensis. Dark green shiny leaves, spotted with creamy-white. A good subject for the stove or warm conservatory. 50 cts. each.

COSTUS.

Zebrinus. A pretty warm greenhouse plant with large dark green foliage and darker stripes. 50 cts. each.

CURMERIA.

Wallisii. A handsome, ornamental, decorative plant for the warm conservatory. Its leaves, which are about 5 inches long by 2 to 2½ inches wide, are of a rich deep green, irregularly blotched with pale yellowish-green. 50 cts. each.

CYANOPHYLLUM.

Magnificum. One of the most striking plants for the warm conservatory, with large, bold, broad foliage, two feet or more in length, of a lustrous deep green on the upper surface and a reddish bronze underneath, the prominent veins white or light green. \$1.00 each.

CYCAS REVOLUTA (Sago Palm).

Valuable decorative plants both for lawn and house decoration; their heavy, glossy deep green fronds resist alike the gas, dust and cold to which decorative plants are frequently exposed.

Height of stem.	Number of Leaves.	Length of Leaves.	
4 to 6 in.	7 to 8	15 to 18 in.	\$0 75 each.
4 to 6 in.	8 to 10	18 to 20 in.	1 50 "
6 to 8 in.	10 to 12	18 to 20 in.	2 00 "
8 to 10 in.	12 to 15	20 to 24 in.	5 00 "

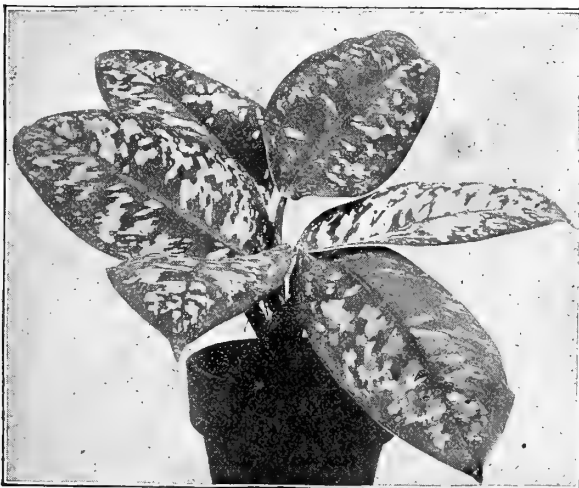

CURMERIA WALLISII.



DIEFFENBACHIA BAUSEI.

DIEFFENBACHIAS.

Handsome decorative plants for the warm conservatory.

Bausei. Leaves yellowish green, blotched dark green, and spotted white.

Bowmannii. Rich deep green leaves, blotched pea green.

Memoræ Corsi. Silvery white foliage with green veins. Very beautiful.

Napoleon III. Very dark green foliage with ivory-white midrib and creamy markings.

Splendens. Rich deep bottle-green, with whitish striated blotches.

Price, 50 cts. each. Set of 5 sorts, \$2.00.

DRACÆNAS.

Amabilis. Bright glossy green foliage, marked and suffused with pink and creamy-white. 50 cts. and \$1.00 each.

Desmetiana. Bold green foliage marked with rose, pink and white. 50 cts. and \$1.00 each.

Fragrans. An excellent house plant, with broad, dark green foliage. 25 cts. and 50 cts. each.

Goldieana. Of erect habit, with spreading leaves, which are of dark green, marked with cream-white irregular blotches and stripes; one of the finest stove plants. Thrifty plants in 4-inch pots, about 8 inches high, at \$1.50 each.

Godseffiana. Entirely different from all other Dracænas; of free-branching habit, forming compact, graceful specimens. Its foliage is of strong, leathery texture; rich dark green color, densely marked with irregular spots of creamy-white. 3-inch pots, 25 cts. each.

Knerkii. Dark glossy green leaves; makes a bold specimen, and is a good house plant. \$1.00 and \$2.00 each.

Lord Wolseley. Long, narrow, recurving foliage, which colors to a very bright rosy-crimson. 50 cts. and \$1.00 each.

Lindenii. A beautiful variegated form of *Fragrans*, with broad green foliage and golden-yellow stripes on the edges. 50 cts. to \$1.00 each.

Massangeana. Another form of the above, with the variegation through the centre of the leaf. 50 cts. to \$1.00 each.

Rothiana. Recurved glaucous green foliage. 50 cts. to \$1.00 each.

Sanderiana. A graceful, small-leaved variety, with glaucous-green foliage, which is edged with a broad border of creamy-white. 25 cts. each.

Terminalis. Bronzy crimson foliage marked with pink and white. 50 cts. and \$1.00 each.

EUCHARIS.

Amazonica. A splendid hothouse plant, blooming at various seasons. It sends up stalks bearing several pure white, star-shaped flowers, 4 inches across. Delightfully fragrant, and is highly prized as a cut flower. 25 cts. each; \$2.50 per doz.

EUGENIA.

Microphylla. A pretty little plant with small, dark green foliage, excellent for Fern dishes or as a pot plant for the conservatory or window garden. 25 cts. each.

EURYA.

Latifolia Variegata. An evergreen shrub with rich, dark green foliage, which is beautifully variegated with creamy-white; an excellent plant for house decoration. Strong plants, 50 cts. each.

FARFUGIUM.

Grande. A beautiful ornamental foliage plant, either for pot culture or for planting in open border in a shaded position; the leaves, from 8 to 10 inches in diameter, are dark green in color, with bright yellow spots. 25 cts. each; \$2.50 per doz.

FICUS (Rubber Plant).

Elastica (India Rubber Tree). One of the very best plants for home decoration. Its thick, leathery leaves enable it to stand excessive heat and dryness. 4-inch pot, 10 inches high, 35 cts. each; 6-inch pot, 24 inches high, 75 cts. each.

Lutescens (Mistletoe Fig). Interesting on account of its free and prolific fruiting qualities, it bearing at each leaf axil a small fig, which, at first green, changes to a pale yellow; the dark green foliage is small, the whole plant reminding one of a branch of mistletoe. An excellent subject for the window garden. 25 cts. each.

Pandurata (The Majestic Rubber Plant). A truly majestic plant. Its gigantic leaves are irregular in outline, of a rich deep green with creamy-white veins and of remarkable substance, enabling the plant to flourish under the most unfavorable conditions. One of the finest foliage plants of recent years. Good specimens, 24 inches high, \$3.00 each.

Parcelli. A pretty plant for the warm conservatory, with large, deep green leaves, marbled and blotched with white. 50 cts. each.

Repens. A trailing or creeping variety, with small foliage; useful for baskets, covering greenhouse walls, etc. 15 cts. each.

FITTONIA.

Argyroneura. A pretty trailing plant, with vivid green foliage, which is traced with a network of pure white veins; useful in the conservatory for planting on the surface of pots or tubs containing specimen plants.

Verschaffeltii. Prettily veined pink on a green ground.

25 cts. each; \$2.50 per doz.



FITTONIA ARGYRONEURA.

DREER'S FINE FERNS.

The limited space in this catalogue allows us to offer but a few of the most important varieties. These are the very best for house culture, succeeding under ordinary living-room conditions.

For complete list and cultural notes see our Garden Book for 1909.

Adiantum Croweanum. This is unquestionably the best of the Maiden-hairs as a house plant. It closely resembles the popular *Adiantum cuneatum*, but of stronger growth. 3-inch pots, 25 cts. each; \$2.50 per doz. 6-inch pots, 75 cts. each; \$7.50 per doz.

Adiantum Farleyense. The most beautiful of the Maiden-hairs, but requires the moist atmosphere of the greenhouse for its successful cultivation. 25 cts., 50 cts., \$1.00 and \$2.00 each.

Asplenium Nidus Avis (*The Bird's Nest Fern*). An interesting species, with large, dark green foliage. 50 cts. each. Specimen plants, \$1.00 each.

Cibotium Schiedei. This Mexican Tree-Fern is the finest decorative house plant we know of, and, though appearing soft, is as hardy as any variety in our collection, succeeding under the same conditions as a Boston Fern; exceedingly graceful. 3-inch pots, 50 cts. each; 6-inch pots, \$2.00 each.

Cyrtomium Falcatum (*Holly Fern*). One of the most serviceable ferns for house decoration, with dark glossy-green holly-like foliage. 25 cts. and 50 cts. each.

Nephrolepis Bostoniensis (*The Boston Sword Fern*). This is the original Boston Fern, which for years has been the most popular house plant in cultivation. Young plants, 15 cts. each; specimens in 6-inch pots, 75 cts. each; large specimens, \$2.50 each.

Nephrolepis Scholzei (*The Plumed Scott or Dwarf Boston Fern*). In this new form, a sport from *Scotti*, we have all the desirable features of the parent, with plummy fronds similar to the Ostrich Plume Fern. Its leaves are held erect with a graceful arch, forming a plummy globe, which is as pretty in a small plant as it is in a specimen plant of largest size. A splendid variety for table decoration. Young plants, 50 cts. each; \$5.00 per doz.; 4-inch pots, \$1.00 each; 6-inch pots, \$2.00 each.

Nephrolepis Scottii (*Dwarf Boston Fern*). Identical to the Boston Fern, except that it is smaller in all its parts and of more compact and denser growth, making an ideal decorative plant for the house. Young plants, 15 cts. each; 6-inch pots, 75 cts. each; specimen plants, \$1.50 each.

Nephrolepis Whitmani (*The Improved Ostrich Plume Fern*). Unquestionably the most valuable of this type. Not only is the pinnæ on the individual fronds more finely divided, but the fronds are denser, broader and more graceful, and the habit of the plant is more perfect. Young plants, 15 cts. each; 6-inch pots, 75 cts. each; specimen plants, \$2.50 each.

Pteris Wilsoni (*Crested Fern*). Among the crested forms of this beautiful genus this is the most desirable. It is of compact growth, with the pinnæ more densely crested than in any other variety. An elegant house plant. Young plants in 3-inch pots, 15 cts. each; specimens in 6-inch pots, 50 cts. each.

Pteris Victoriae (*Silver Variegated Fern*). A most graceful variety, with silvery variegation through the centre of each leaf. 25 cts. and 70 cts. each.

Ferns for Fern Dishes. We have at all times a good supply of the most desirable varieties for this purpose. 2½-inch pots, \$1.00 per doz.; \$6.00 per 100. 3-inch pots, \$1.50 per doz.; \$10.00 per 100.



HOLLY FERN (CYRTOMIUM FALCATUM).



CRESTED FERN (PTERIS WILSONI).



PLUMED SCOTT FERN (NEPHROLEPIS SCHOLZEI).



GARDENIA (Cape Jessamine).

GARDENIA FLORIDA.

(Cape Jessamine.)

Beautiful greenhouse evergreen shrubs, with delightfully fragrant, pure white, waxy flowers. 4-inch pots, 35 cts. each; \$3.50 per. doz.; 6-inch pots, \$1.00 each; \$10.00 per doz.

GENISTA.

Fragrans. A most desirable spring-flowering plant, producing its fragrant, bright golden-yellow flowers in the greatest profusion. As a winter plant of the easiest culture it is unsurpassed. Especially desirable for Easter decoration. First size, 50 cts. each; \$5.00 per doz. Second size, 30 cts. each; \$3.00 per doz.

Geraniums for Winter-flowering.

While undoubtedly the most popular of bedding plants, Geraniums deserve to be used more extensively for window and conservatory decoration, no other plants excelling or even approaching them for brilliancy and richness of color. We have aimed to make the selection below combine in the highest degree perfection of form and size of the individual florets, size of truss, purity of color, habit of plant and general excellence, and specially recommend them for the embellishment of the conservatory and window garden.

SIX BEST DOUBLES.

- Anais Segalas.** Bright salmon-carmine.
Madonna. Pure snow-white; fine form.
M. Anatole Roseleur. Deep rose-pink.
Mrs. Lawrence. Beautiful soft, satiny-salmon, tinted white.
Ornelia. Rich deep scarlet, shaded crimson.
S. A. Nutt. Rich dark crimson.
 15 cts. each; \$1.50 per doz. Set of 6 for 75 cts.

SIX BEST SINGLES.

- Claire Albane.** A fine pure white.
Maxime Kovalevski. Brilliant orange-red.
Pamela. Large white centre, bordered rosy-lake and a bold edge of violet-crimson.
Paul Crampel. Exceptionally free-flowering, brilliant scarlet.
Theodor de Wyzewa. Lilac-rose, white blotch at base of petals.
Victor Grosset. Apricot-salmon, shaded vermilion.
 15 cts. each; \$1.50 per doz. Set of 6 for 75 cts.

HELICONIA.

Aurea Striata. A handsome bothouse plant with leaves of deep, glossy green, marked by curving parallel lines of yellow. \$1.00 each.

ISOLEPIS GRACILIS.

A useful plant with graceful, grass-like dark-green, drooping foliage, for vases, baskets or the window garden. 15 cts. each, \$1.50 per doz.

IXORAS.

These are among the showiest of hothouse flowering plants. The foliage is pretty and attractive, while the flowers, borne in large terminal corymbs, are shaped somewhat like a Bouvardia.

- Acuminata.** Fragrant, pure white flowers.
Chelsoni. Brilliant salmon-orange.
Coccinea. Bright red, in very large corymbs.
Coccinea Superba. Large bright red.
Dixiana. Deep orange, in large trusses.
Flore lutea. Very large creamy-yellow flowers.
Incarnata. Delicate flesh color.
Javanica. Deep orange-red.
Prince of Orange. Large orange-red.
Rosea Splendens. Bright rose.
Williamsii. Reddish-salmon, in large heads.
 50 cts. each. Set of 11 varieties for \$5.00.

JASMINUM.

Grandiflorum (*Catalonian or Star Jessamine*). Very fragrant white flowers, in bloom almost continuously. 15 cts. each.

- Grand Duke.** Large, double white, fragrant flowers. 25 cts. each.
Maid of Orleans. Creamy-white, fragrant flowers. 25 cts. each.

LAPAGERIA.

Extremely beautiful greenhouse climber. Bell-shaped, waxy flowers of great substance, lasting a long time in bloom.

- Rosea.** Rich rosy-crimson. \$2.00 each.
Alba. Pure waxy-white. \$2.50 each.

PONDEROSA LEMON.

Of strong, vigorous growth, producing freely flowers as large as a tuberose and as fragrant as the orange blossom, followed by gigantic fruit, many weighing from 1½ to 2 pounds each, which are useful for many domestic purposes. Good young plants, 15 cts. each; strong 2-year-old plants, 50 cts. each.



WINTER-FLOWERING GERANIUM.

MARANTA.

Valuable decorative stove plants, remarkable for the richness and beauty of their varied foliage.

Alberti	Each. \$0 50	Makoyana	Each. \$0 50
Argyraea	75	Masangeana (True)	50
Bachemiana	50	Media Picta	50
Bella	25	Mosella	1 00
Costata Glabra	75	Musaica	50
Chantrieri	50	Porteana	50
Eximea	50	Pulchella	50
Gouletti	75	Rosea Lineata	75
Goveniana	25	Sanderi	1 00
Illustris	75	Smaragdina	50
Iconifera	50	Spitzeriana	50
Insignis	50	Splendens	50
Kerchoviana	25	Triumphans	75
Kummeriana	50	Van den Heckeii	75
Leopardina	75	Vittata	1 00
Lietzei	50	Wallichii	50
Lindeni	1 00	Warscewiczii	75
Lubersi	50	Wietii	50
Luciana	50		

We will furnish one each of the above grand collection of 37 varieties of Marantas for \$20.00.

MEDINILLA.

The *Medinillas* here described are among the most gorgeous tropical flowering plants in cultivation and most desirable plants for the amateur who has the facilities of a hothouse. They are natives of the Philippines, with handsome, broad, shining, leathery foliage. The plants continue in flower from April to July; the flowers are of a coral-red color, five-petalled, each about an inch across, and are borne in immense pyramidal panicles frequently a foot long, and bearing from 100 to 150 flowers. The branches of the panicles as well as the large, showy bracts, sometimes four inches long, are of a delicate pinkish color. A large well-flowered specimen is a sight never to be forgotten.

Magnifica. Bears its flowers in pendulous racemes.
Amabilis. Identical with the above, except that the racemes of flowers are held erect.

\$1.50 each.

MOSCHOSMA RIPARIUM.

An introduction from tropical South Africa; in habit of growth not unlike a *Coleus*, but producing from early in December until March dense feathery or plume-like erect panicles of small creamy-white flowers in great profusion; easy to grow. 25 cts. each; \$2.50 per doz.



PANDANUS VEITCHI.



MARANTA.

METROSIDEROS.

Floribunda (Bottle Brush). A greenhouse shrub, producing long cylindrical spikes of bright red flowers. \$1.00 each.

NEPHTHYTIS PICTURATA.

An interesting ornamental stove plant; dark green foliage, with fern-like variegation in silvery white. \$1.00 each.

OLEA FRAGRANS (Sweet Olive).

An old favorite greenhouse shrub, succeeding admirably as a house plant, producing small white flowers of the most exquisite fragrance. 50 cts. each.

OPHIOPOGON.

Jaburan Variegatus. A pretty variegated foliage plant, useful either as a pot plant for the window or for planting out in summer. 50 cts. each.

OTAHEITE ORANGE.

The best of the *Oranges* for house culture. It is of dwarf, bushy habit, and bears a profusion of fragrant flowers and edible fruit. 25 cts. and 50 cts. each.

PANDANUS (Screw Pine).

Veitchi. One of the best and most attractive of decorative plants for the house. The leaves are light green, beautifully marked with stripes of pure white.

	Each.		Each.
4-in. pots, 12 in. high,	\$0 75	6-in. pots, 18 in. high,	\$1 50
5 " " 15 " "	1 00	8 " " 30 " "	3 00

PANAX.

Pretty shrubby plants for the warm conservatory, of compact growth, with neat variegated foliage.

Balfouri. Bold foliage of rich ivy-green, abundantly splashed with creamy white, the edge of the leaf entirely white. 50 cts. each.

Monstrosium aureum. Deep green foliage with delicate golden-green variegation. 50 cts. each.

Victoriae. Small, finely-cut foliage of light green with white variegation. 25 cts. each.

PASSIFLORA (Passion Vine).

Princeps. This is one of the finest climbers we have for the warm conservatory or greenhouse, an established plant being rarely out of flower. 50 cts. each.

PALMS.

We are the largest growers of Palms in this country, over three acres of greenhouse space being devoted to them alone. For complete list of varieties and full cultural directions see pages 152 to 154 of our Garden Book for 1909.

The heights given are from top of pot to top of plant.

Areca Lutescens. One of the most graceful and beautiful Palms in cultivation; the foliage is of a bright glossy-green, with rich golden-yellow stems. Each 3-inch pots, bushy plants, 12 to 15 inches high..... \$0 25
 4-inch " " " 15 to 18 " " 50
 6-inch " " " 24 to 30 " " 1 50
 7-inch " " " 36 " " 2 50

Areca Verschaffeltii. A splendid Palm, with finely-divided pinnae of a deep green color with yellowish midrib. 3-inch pots, 15 inches high, 50 cts. each; 5-inch pots, 24 inches high, \$1.50 each; 6-inch pots, 30 inches high, \$2.50 each.

Arenga Sacharifera. In a large specimen this is a most striking and attractive Palm. The ends of the leaves have a cut appearance like those of the Fish-tail Palm, and of a rich deep green color. 6-inch pots, 30 inches high, \$2.50 each; 7-inch pots, 36 inches high, \$3.50 each.

Bactris Major. Not a new, but a comparatively rare Palm, which, where the temperature of a warm conservatory can be given, is an interesting subject, on account of the many long spines with which not only the stems, but also both surfaces of the leaves, are densely covered. 3-inch pots, 10 to 12 inches high, \$1.00 each; 6-inch pots, 30 inches high, \$3.00 each.

Cocos Weddelliana. The most elegant and graceful of all the smaller Palms. Its slender, erect stem is freely furnished with its gracefully arching leaves, of a rich green color. Admirable for fern dishes, as they are of slow growth and maintain their beauty for a long time. Young plants in 3-inch pots, 12 inches high, 25 cts. each; beautiful specimens in 5-inch pots, 18 to 24 inches high, \$1.50 each. Larger specimens, \$3.00 and \$5.00 each.

Kentia Belmoreana. The Kentias are the hardiest Palms in cultivation. They are of slow growth, and are less affected by the dust and dry atmosphere of the house than any others. The variety here offered is of dwarf, spreading habit, with fine rich dark green foliage.

In. pots.	Leaves.	In. high.	Each.	In. pots.	Leaves.	In. high.	Each.
3	4 to 5	12	\$0 25	6	6	24 to 30	\$2 00
4	5 to 6	15	60	7	6 to 7	30	3 00
5	6	18 to 20	1 00	8	6 to 7	36	5 00



COCOS WEDDELIANA.

Kentia Forsteriana. This splendid variety is very similar to *K. Belmoreana*, but of stronger growth, with broader, heavier foliage.

In. pots.	Leaves.	In. high.	Each.	In. pots.	Leaves.	In. high.	Each.
3	3 to 4	12	\$0 25	8	6 to 7	42	\$ 00
4	4 to 5	15	60	In. tubs.			
6	5 to 6	24	1 50	10	6 to 7	60	10 00
6	6 to 7	30	2 50	12	6 to 7	72	20 00
				12	6 to 7	84	25 00

Kentia McArthurii. A tall growing species, with broad pinnae of irregular outline. A good plant for the cool conservatory. 6-inch pots, 30 inches high, \$1.50 each.

Kentia Sanderiana. A new and rare Palm of elegant and graceful habit, with narrow pinnae in gracefully arching leaves of bright green. 4-inch pots, 15 inches high, \$1.00 each; 5-inch pots, 24 inches high, \$1.50 each.

Latania Borbonica (Chinese Fan Palm). This popular fan-leaved variety is too well known to require description. We grow them in immense quantities.

3-inch pots,	4 to 5 leaves,	12 inches high	\$0 25 each.
4	"	5 to 6	"	15 " " " " " " 50 "
6	"	6	"	20 " " " " " " 1 00 "

Livistona Rotundifolia. A miniature fan-leaved Palm, which, in a finished specimen, makes almost a globular plant. Thrifty young plants in 3-inch pots, 25 cts. each; 4-inch pots, 50 cts. each.

Phoenix Roebelenii. The most graceful of the Phoenix, and a Palm which we feel sure will become popular for room decoration. The plant is of vigorous growth, and its gracefully recurring leaves with very narrow dark green pinnae, give it a lightness and airiness not surpassed, if equalled, by *Cocos Weddelliana*; at the same time it is as hardy as a *Kentia*, succeeding admirably as a house plant.

3-inch pots,	6 to 8 inches high,	nicely characterized	\$0 35 each
4	"	10 " " " " " "	50 "
5	"	12 " " " " " "	1 50 "

Phoenix Ruppicola. A very handsome species, with long, gracefully arched foliage of rich, deep glossy green. 6-inch pots, 15 inches high, \$2.00 each.

Rhapis Flabelliformis. Good plants of this interesting Japanese Palm, 2 feet high, \$3.50 to \$5.00 each.

Thrinax Barbadensis. A pretty and graceful form of this attractive fan-leaved Palm. 5-inch pots, 18 to 24 inches high, \$3.00 each.

SPECIAL OFFER OF PALMS. We will send a thrifty young plant each of *Areca Lutescens*, *Kentia Belmoreana*, *Kentia Forsteriana*, *Latania Borbonica* and *Cocos Weddelliana*, prepaid, to any address in the United States for \$1.00.



PHOENIX ROEBELENII

SPATHIPHYLLUM.

Pictum. A hothouse plant much on the type of a Dieffenbachia, foliage dark green with golden variegations. 75 cts. each.

SPLÆROGYNE.

Latifolia. A magnificent hothouse decorative plant with large green foliage; a striking exhibition plant. \$1.00 each.

STEPHANOTIS FLORIBUNDA.

One of the most charming hothouse climbers, growing rapidly, with long glossy, deep green foliage, and producing clusters of pure white, deliciously fragrant flowers. 50 cts. and \$1.00 each.

SWAINSONA.

Alba. A most desirable everblooming plant, with pure white flowers, produced in sprays, the individual blooms resembling a Sweet Pea. Its easy culture, freedom of bloom, and the grace and beauty of the flower and plant make it popular. 10 cts. each; \$1.00 per doz.

DOUBLE VIOLETS.

The double violets require the protection of a cold frame.

Marie Louise. The finest double blue.

Swanley White. Pure white.

SINGLE VIOLETS.

La France. Rich violet-blue; a strong grower and very free-flowering; deliciously scented.

Luxonne. Rich but soft violet-purple; very sweet.

Princess of Wales. Not quite so large as *Luxonne* and a shade lighter in color; intensely fragrant.

Price, any of the above Double or Single Violets, 15 cts. each; \$1.50 per doz.; \$10.00 per 100.

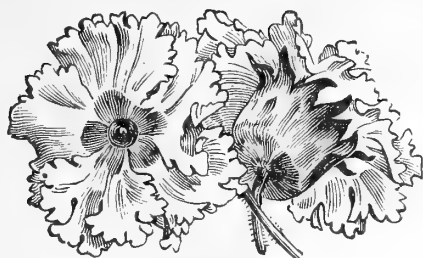

CHINESE FRINGED PRIMROSE.

PEPEROMIA.

Maculosa. A pretty, dwarf, ornamental foliage plant, the thick leaves being bright green, veined silvery-white; exceedingly useful as a pot plant for the window or porch boxes. 25 cts. each; \$2.50 per doz.

PHILODENDRON.

Spectabilis. An interesting stove plant, with large heart-shaped dark green leaves, with light veins. \$1.00 and \$2.00 each.

Pertusum. A stove plant of climbing habit, with large perforated leaves of grotesque appearance. \$1.00 and \$2.00 each.

PHYLLOTÆNIUM.

Lindeni. A handsome stove plant, light green hastate leaves, ribs and veins creamy-white. 75 cts. each.

Lindeni Magnificum. A variety of the above with larger leaves and the variegation more decided. \$1.00 each.

PLUMBAGO.

Capensis. Light lavender-blue.

— **Alba.** Color creamy-white.

15 cts. each; \$1.50 per doz.

POTHOS ARGYRÆA.

A pretty hothouse climber, with deep green foliage, nicely variegated with silvery white. 25c. each

CHINESE FRINGED PRIMROSES.

Our collection of these well-known winter-blooming plants has been grown from our unrivaled strain of seed, and embraces all the leading shades of color. 15 cts. each; \$1.50 per doz.

RHYNCHOSPERMUM.

Jasminoides (Maylayan Jasmine). A climbing plant which succeeds admirably in the conservatory or window garden; grown as a pot plant and trained on a trellis, it produces during the spring months in great abundance delicate pure white flowers of entrancing perfume. 25 cts. each.

SANSEVIERA ZEALANICA.

An elegant variegated plant, especially adapted for house decoration, the thick, leathery leaves standing the heat and dust of the house with impunity. 15 cts. each; 4 for 50 cts.

SCHISMATOGLOTTIS.

Picta. A handsome decorative plant. Foliage deep green, with greyish-white markings. 50c. each.

SMILAX.

Too well known to require any description. One of the most valuable plants for bouquets, wreaths, festoons and decorations. 10 cts. each; \$1.00 per doz.; \$5.00 per 100.



SINGLE VIOLET.

DREER'S
Superb May-flowering
Cottage Garden
 or
Boulevard Tulips

We show ten of this beautiful class of Tulips on the covers of this Catalogue. For descriptions and prices see pages 10 and 11.

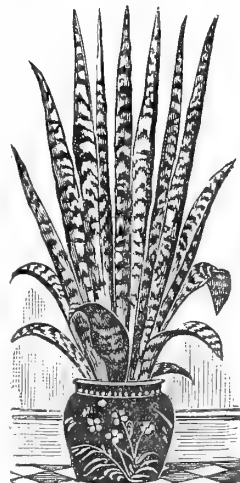

SANSEVIERA ZEALANICA.



Aquatic Plants for Aquariums.

There is a rapidly growing taste for the culture of fancy fish and aquatic plants in Aquariums, and it is doubtful if anything is more fascinating to the young, as well as to the older members of the household, than to watch the development of animal and plant life in the aquaria. It is necessary to secure and maintain the proper balance between plant and animal life, as fish will not thrive unless enough plants are growing to furnish them with oxygen. To do this there should be not less than one plant to every two gallons of water. The ideal temperature is about 50 degrees, and a shady corner, or a window facing north, is best during the summer, and an east window during the winter. If the proper balance is maintained, it will not be necessary to change the water more than three or four times a year.

The plants offered below are the best known oxygenators.

Anacharis Canadensis Gigantea (*Giant Water Weed*).

A beautiful submerged plant with dark green ovate leaves and light stems; of quick growth. The best oxygenator and a splendid Aquarium plant. 15 cts. each; \$1.50 per doz.

Cabomba Viridifolia (*Washington Grass*). A pretty and popular submerged plant; leaves brilliant, glossy green, fan-shaped, regularly cut and more beautiful than the most delicate fern. 10 cts. per bunch; \$1.00 per doz. Pot plants, 25 cts. each.

Cyperus Alternifolius. An excellent plant for growing in water or damp places; will thrive in any good soil, and always presents a green and attractive appearance. 15 cts. and 25 cts. each; \$1.50 and \$2.50 per doz.

Eichhornia Crassipes Major (*Water Hyacinth*). A very showy floating aquatic, bearing flowers of a delicate lilac-rose in trusses like a Hyacinth. 15 cts. each; \$1.50 per doz.

Ludwigia Mulertii. One of the prettiest of the submerged plants. The small, ovate leaves, green above and pink on the under side, are very attractive and entirely distinct from all other Aquarium plants. 25 cts. each; \$2.50 per doz.

Myriophyllum Proserpinacoides (*Parrot's Feather*).

Long, trailing stems, clothed with whorls of the most exquisite foliage, as delicate as the Cypress Vine. Planted in water-tight hanging-basket, so water can be kept standing on the surface, it will trail finely. 10 cts. each; \$1.00 per doz.

Sagittaria Natans. This plant is indispensable for the Aquarium; its long strap-like green leaves resemble the well-known *Vallisneria*. 15 cts. each; \$1.50 per doz.

Sagittaria Sinensis (*Giant Sagittaria*). Leaves dark green; broader and stronger than *S. Natans*, and a freer grower; the best form for the Aquarium. 15 cts. each; \$1.50 per doz.

Salvinia Braziliensis. This pretty little floating aquatic is suitable for all Aquaria. The leaves are a soft green, covered with a delicate hairy surface. 15 cts. per bunch; \$1.50 per doz.

Vallisneria Spiralis Gigantea (*Giant Eel Grass*). A submerged plant with ribbon-like leaves, $\frac{1}{4}$ inch wide and from 1 to 2 feet long; a free grower and a good oxygenator. 15 cts. each; \$1.50 per doz.

DREER'S SELECT Hardy Perennial Plants.

THIS class of plants, familiarly known as **Old-fashioned Hardy Garden Flowers**, has come into public favor in recent years so rapidly as to astonish even the most sanguine enthusiast of these gems of the garden. Their popularity is not at all surprising when we consider the many varied and pleasant changes which take place throughout the entire growing season in a well arranged hardy border, in which every week, yes, almost every day, brings forth something fresh and new. The limited space at our command in this catalogue permits us to offer but an abridged list of the many species and varieties which we grow. For complete list, also for many valuable cultural notes, see pages 172 to 216 of our Garden Book for 1909. For customers who are not acquainted with the various varieties, we offer the following collections, all in good strong roots, that, once planted, will, with very little care, keep the garden gay with flowers from the time frost leaves the ground until late in autumn.

12 distinct species, our selection\$1.50
25 " " " " " " " " 2.75
50 distinct species and varieties, our selection 5.00
100 " " " " " " " " 9.00

ACHILLEA (Milfoil, or Yarrow).

Ptarmica Fl. Pl. "The Pearl." Flowers all summer of the purest white.

Filipendula (Noble Yarrow). A showy species, with golden-yellow flowers in dense flat corymbs; in July; 2 feet.

Millefolium Roseum (Rosy Milfoil). Finely-cut, deep green foliage; flowers pink, in dense heads, all summer; 18 inches.

— **Cerise Queen.** A new, bright amaranth-red variety.

Tomentosa (Woolly Yarrow). Handsome cut foliage and bright yellow flowers in a multitude of flat heads during June; 12 inches.

Eupatorium (Fern-leaved Yarrow). Finely-cut foliage and brilliant yellow flowers all summer; 4 feet.

ACONITUM (Monkshood, or Helmet Flower).

Forms bushy clumps, with spikes 3 feet long of hood-shaped flowers, and are invaluable for planting in shady positions.

Autumnale. Deep purplish-blue; Sept.

Napellus. Large, dark-blue; Aug. and Sept.

— **Bicolor.** Blue-and-white flowers.

Fischeri. Pale blue flowers in Sept. and Oct.

Lycoctonum. Pale yellow; June and July.

Streikianum. Beautiful rich, deep blue; July and Aug.

Wilsoni. A new variety from Northern China; grows 5 to 6 feet high, with very large flowers of light violet-blue in September. 30 cts. each; \$3.00 per doz.

Price (except where noted), 25 cts. each; \$2.50 per doz.

ACTÆA (Baneberry).

Desirable native plants, with showy, dense spikes of white flowers, about 2 feet high, produced in masses in June, followed with handsome clusters of berries.

Spicata alba. Pure white berries on red stems.

— **Rubra.** Bright scarlet berries in long, dense spikes. 25 cts. each; \$2.50 per doz.



A HARDY PERENNIAL BORDER.

ADONIS (Bird's Eye).

Beautiful early spring-flowering plants, about 12 inches high, with finely-cut, ornamental foliage.

Amurensis. A Japanese species, with large, yellow flowers; blooms fully two weeks earlier than any other hardy plant. 50 cts. each; \$5.00 per doz.

Pyrenaica. Large, orange-yellow. 25 cts. each.

Vernalis (Ox-eye). Bright yellow. 25 cts. each.

ÆGOPIDIUM (Bishop's Weed).

Podagraria Variegata. Green and yellow variegated foliage, thriving in any soil; makes a fine border for a bed of shrubs or for covering waste ground; 1 foot.

AGROSTEMMA (Rose Campion).

Stout, erect-growing plants, with silvery foliage, which contrasts well with the showy flowers, which are produced during June and July.

Coronaria (Mullein Pink). Bright crimson flowers on stems 2½ to 3 feet high.

Flos Jovis (Flower of Jove). Deep pink flowers on 12-inch high stems.

ALYSSUM.

Rostratum. Bright golden yellow flowers in June and July. 25 cts. each; \$2.50 per doz.

Saxatile Compactum (Basket of Gold, Gold Tuft, Rock-madwort). An indispensable plant for the rockery or border, growing 1 foot high and producing early in summer masses of broad, flat heads of bright yellow flowers.

ANCHUSA.

Barrelieri. Forget-me-not-like blue flowers with white tube and yellow throat; May and June; 18 inches. 25 cts. each; \$2.50 per doz.

Italica (Italian Alkanet). A strong-growing plant, 3 to 4 feet high, with rough, broad foliage and large heads of deep blue flowers the entire season.

— **Dropmore Variety.** A grand improvement on the preceding; flowers deep blue. 1 to 1½ inches across; blooms all summer. 30 cts. each; \$3.00 per doz.

All Hardy Perennial Plants, except where noted, 15 cts. each; \$1.50 per doz.



ANEMONE.

ANEMONE JAPONICA.

(Japanese Windflower.)

These beautiful Windflowers are perfectly hardy if given the protection of 2 or 3 inches of leaves or litter during the winter, and brighten up the hardy border during the fall.

Japonica. Beautiful rosy red.

Alba. Large, snowy white.

Elegantissima. Large, satiny-rose, semi-double flowers.

Lord Ardilaun. The finest single white. 25 cts. each.

Prince Henry. Very double, deep, rich, pink flowers.

Queen Charlotte. Large semi-double flowers of silvery pink.

Rosea Superba. Delicate silvery rose.

Whirlwind. Large semi-double pure white.

AQUILEGIA (Columbine).

Old favorite spring and early summer blooming plants, growing about 2 feet high, that succeed in any ordinary garden soil.

Californica Hybrida. One of the finest mixtures.

Canadensis. Our native Columbine, bright red and yellow.

Caryophylloides Fl. Pl. Double striped, etc.

Chrysantha. The golden-spurred "Columbine."

Cœrulea (Rocky Mountain Columbine). Blue and white.

Flabellata nana alba. A dwarf, pure white.

Helenæ. Blue, with white corolla.

Nivea grandiflora. A beautiful pure white.

Skinneri. Yellow, with long red spurs.

Truncata. Scarlet, with yellow tips.

Vulgaris. The European violet-blue Columbine.

ARABIS (Rock Cress).

Alpina. One of the most desirable early spring-flowering plants, especially adapted for edging; covered with pure white flowers.

— **Flore-Plena.** A pretty double-flowering form.

ARMERIA (Thrift).

Attractive evergreen tufts of bright green foliage, from which innumerable flowers appear in dense heads on stiff, wiry stems about 9 inches high. They flower continuously the entire season.

Maritima Splendens. Bright rosy pink.

— **Alba.** A pretty white.

ARTEMESIA.

A most useful class of plants for the border.

Abrotamnum (Old Man, or Southernwood). Dark green, finely cut foliage, with pleasant aromatic odor; 2 feet.

Frigida (Colorado Mountain Fringe). Small silvery-white foliage; fine for rockery or border; 6 to 10 inches.

Purshiana. A white-foliaged sort, for edging; 18 inches.

Stellariana (Old Woman). Deeply-cut, silvery foliage; much used in carpet bedding; 18 inches.

HARDY ASTERS.

(Michaelmas Daisies, or Starworts.)

These are among the showiest of our late-flowering hardy plants, giving a wealth of bloom when most other flowers are past. Unless specified, they bloom in September and October.

Amellus Mackii. Pure violet; Aug. and Sept.; 15 inches.

Airship. Pure white; August and September; 2½ feet.

Curtissii. Pale heliotrope; August and September; 3 feet.

Grandiflorus. The finest and latest flowering of all; the flowers are of a lovely dark bluish-violet; October and November. 25 cts. each; \$2.50 per doz.

Esme. Large white flowers; 2 feet.

Formosissima. Bright violet; 3 feet.

F. W. Burbidge. Light violet; 3 feet.

Lævis floribunda. Light heliotrope; 4 feet.

Mme. Soyneuse. Pale lilac; very free; 15 inches.

Novæ-Angliæ. Bright violet-purple; 4 feet.

— **Mrs. F. W. Raynor.** Light reddish-violet; 4 feet.

— **Rosea.** Bright purplish-mauve; 4 feet.

— **Ryecroft Pink.** Soft rosy-pink; 4 feet.

— **Wm. Bowman.** Amethyst-blue; 4 feet.

Novi-Belgii Semi-Plenus. Pale parma-violet; 4 feet.

Patens. Deep ageratum-blue; 2 feet.

Ptarmicoides. Neat and distinct; pure white; useful for cutting; August and September; 18 inches.

Punicus Pulcherrimus. Bluish white with yellow centre, incurved petals; 5 feet.

Shorti. Deep parma violet-blue; 3 feet.

Snowflake. Very free, pure white; 18 inches.

St. Brigid. White tinted lilac; Aug. and Sept.; 3½ feet.

Top Sawyer. Clear parma violet color; 4 feet.

Trinervus. Rich violet-purple; October and November; 2½ feet.

White Queen. Large white; very free; 4 feet.

DWARF HARDY ASTERS.

Alpinus. Grows 6 to 10 inches high, and bears large, showy bluish-purple flowers in May and June.

— **albus.** Identical to the above, but with pure white flowers.

Acris. Violet-blue flowers in September.

— **Nanus.** Similar to the preceding, but only 6 inches high.



ASTER GRANDIFLORUS

ASCLEPIAS (Butterfly Weed).

Tuberosa. One of the showiest of our native perennials; 2 feet high, and producing from July to September heads of orange-colored flowers.

ASTILBE DAVIDII.

Unquestionably one of the most important additions to hardy plants in many years. Its 5 to 6 feet high stems, which rise from a tuft of pretty dark green foliage, are crowned with feathery plumes of deep rose-violet flowers during July and August. 25 cts. each; \$2.50 per doz.

BAPTISIA (False Indigo).

Australis A strong-growing plant, about 2 feet high, with dark green, deeply cut foliage, and spikes of dark blue flowers in June and July.

Tinctoria. Spikes of bright yellow flowers during June and July; 2 to 3 feet.

BOCCONIA (Plume Poppy, or Tree Celandine).

Cordata. A noble hardy perennial, beautiful in foliage and flower, and admirably adapted for planting in the shrubby borders, centre of beds, and in bold groups in any position. It will grow in any soil or situation, attaining 6 to 8 feet in height; flowers creamy-white in terminal panicles during July and August.

BOLTONIA (False Chamomile).

Among the showiest of our native hardy perennial plants, with Aster-like flowers, in bloom during the summer and autumn, and with its thousands of flowers open at one time produces a very showy effect. (See cut.)

Asteroides. Pure white; very effective; 5 to 7 feet.

Latisquama. Pink, slightly tinged with lavender; 4 to 6 feet.

— **nana.** Similar to the type, but growing only 2 feet high,



BOLTONIA LATISQUAMA.

CALLIRHOE (Poppy Mallow).

Involucrata. An elegant trailing plant, with large saucer-shaped flowers of bright rosy-crimson, with white centres, which are produced all summer and fall.

Lineariloba. Delicate light rose-colored flowers all summer.

CAMPANULA (Bell Flower).

Alliariæfolia. Grows 2 feet high, with nodding white flowers in June and July.

Carpatia (*Carpathian Harebell*). A pretty species, growing in compact tufts, not exceeding 8 inches high; flowers clear blue, 1 inch in diameter and blooms all summer.

— **alba.** The white-flowered form of the preceding.

Glomerata (*Clustered Bell-flower*). Grows 18 inches high, and produces from June to August dense clusters of funnel-shaped violet-blue flowers.

Grosseki. Dark blue flowers all summer; 2 feet.

Lactiflora. Large spikes of flowers, white tinted blue; June to August; 3 feet.

Latifolia macrantha. Grows 3 feet high, and in May and June bears large purplish-blue flowers.

Medium (*Canterbury Bells*). An old-time favorite. Blue, rose and white; 2 to 3 feet.

Medium Calycanthema (*Cup and Saucer Canterbury Bells*). A beautiful form. Blue, rose and white.

Persicifolia (*Peach Bells*). Grows 1½ to 2 feet high, and produces an abundance of blue salver-shaped flowers during June and July.

— **alba.** A pure white form of the above.

— **humosa.** The double blue form of the Peach Bells. 25 cts. each; \$2.50 per doz.

Punctata. Nodding bell-shaped flowers, white spotted purplish-rose; May and June; 1 foot.

Pyramidalis (*Chimney Bellflower*). The most conspicuous of all, 4 to 5 feet high, with large blue flowers in September. 25 cts. each; \$2.50 per doz.

Rapunculoides. Showy blue flowers in June and July; 3 feet.

Rotundifolia (*Blue Bells of Scotland*). This is the true hare-bell or blue-bell famed in song and story, with beautiful clear blue flowers from June to August; grows about 1 foot.

Trachelium (*Coventry Bells*). Purple flowers during June and July; 3 feet.

CASSIA (American Senna).

Marilandica. Large panicles of bright yellow flowers from July to August; 3 to 4 feet.

CARYOPTERIS.

Mastacanthus (*Blue Spiræa*). A handsome hardy perennial, producing rich, lavender-blue flowers continuously from early in September until frost; 3 feet.

CAMPANULA MEDIUM CALYCANTHEMA.
(Cup and Saucer Canterbury Bells.)



CHRYSANTHEMUM BURBANK'S "SHASTA DAISY."

CENTAUREA (Hardheads or Knapweed).

Hirta nigra variegata (*Variegated Button Weed*). Prettily variegated foliage and purple flowers; 2 feet.

Dealbata. Bright rose-colored flowers; July to Sept.; 18 inches.

Macrocephala. Very large thistle-like golden-yellow flowers; July and August; 3½ feet.

Montana (*Perennial Corn Flower*). Grows 2 feet high, bearing large violet-blue flowers from July to September.

— **alba**. Large white variety of above.

Orientalis. Pale yellow flowers; July and August; 2½ feet.

CEPHALARIA (Roundheads).

Alpina. Attains a height of 6 feet, bearing in July and August sulphur-yellow flowers. 25 cts. each; \$2.50 per doz.

CERASTIUM (Snow in Summer).

Tomentosum. Silvery foliage and white flowers, suitable for the rockery, or for carpeting dry, sunny spots.

CHELONE (Shell Flower).

Stately and handsome perennials, growing about 2 feet high and bearing numerous spikes of large flower-heads during late summer and fall.

Glabra Alba. Spikes of creamy-white flowers.

Lyonii. Heads of deep red flowers.

Obliqua Alba. Clusters of pure white flowers.

25 cts. each; \$2.50 per doz.; \$15.00 per 100.

CHRYSOCOMA (Goldilocks).

Linosyris. Produces from July to September yellow, daisy-like flowers, with narrow, thread-like petals; 2 feet.

CIMICIFUGA (Snake Root).

Simplex. Most valuable by reason of its extreme late-flowering, beginning in September and attaining full perfection about the middle of October; flowering stems 2½ to 3 feet high, terminated with a dense spike of white flowers. 50 cts. each; \$5.00 per doz.

Acerinum, or Japonicum. A pretty Japanese variety, with slender, erect stems, about 2½ feet high, of white flowers; August and September. 25 cts. each.

Racemosa. A handsome native species, bearing spikes of pure white flowers. 25 cts. each.

Dahurica. Large cylindrical spikes of creamy flowers in September. 25 cts. each.

CHRYSANTHEMUMS (Moonpenny Daisy).

Shasta Daisy. Large snowy-white flowers, in bloom continuously throughout the summer and fall.

Shasta Daisy "Alaska". The finest of all; blooms 4½ to 5 inches across of pure glistening white. 25 cts. each; \$2.50 per doz.

Hardy Pompon Chrysanthemums.

These beautiful hardy sorts are indispensable in the hardy border. Their bright colors give life to the garden when most other plants have been destroyed by frost. We offer the following select list:

Baby. Very small, lemon-yellow.

Eagle d'Or. Golden-yellow.

Gold Finch. Yellow, striped red.

Julia Lagravere. Rich garnet.

Model of Perfection. White.

Princess of Wales. Pure white.

Rhoda. Apple-blossom pink.

Rosinante. Blush-rose.

Thalia. White, yellow centre.

Tennyson. Pure yellow.

Trojan. Maroon yellow centre.

Victor. Rosy crimson.

SHRUBBY CLEMATIS.

This type of Clematis forms erect bushes 2 to 3 feet high, and during their long period of bloom are very attractive.

Davidiana. Tubular bell-shaped flowers of deep lavender-blue during August and September; deliciously fragrant.

Integrifolia. Produces attractive, large deep-blue flowers in great profusion during July and August.

Recta. Handsome pure white flowers in very large, showy clusters during June and July. 25 cts. each; \$2.50 per doz.

COREOPSIS.

Lanceolata grandiflora. One of the most popular hardy plants. The flowers are a rich golden-yellow, and invaluable for cutting; the main crop comes during the latter part of June, but it continues in bloom the entire summer and autumn.

DIANTHUS.

Barbatus (*Sweet William or London Tufts*). Mixed colors. 10 cts each; \$1.00 per doz.; \$7.00 per 100.

Deltoides (*Maiden Pink*). A charming creeping variety, with medium-sized pink flowers.

— **alba**. A pretty white-flowering form.

Fettes Mount. A charming, strong growing variety, covered with soft rosy-pink flowers in June.

Latifolius atrococcineus Fl. Pl. (*Everblooming Hybrid Sweet William*). A beautiful summer bedding variety, producing masses of brilliant fiery crimson flowers throughout the entire season.



COREOPSIS LANCEOLATA GRANDIFLORA.

DELPHINIUMS (Hardy Larkspurs).

These are deservedly one of the most popular subjects in the hardy border; bold, attractive and highly prepossessing plants of easiest culture; perfectly hardy. They will establish themselves in almost any garden soil, but respond quickly to liberal treatment.

Belladonna. The freest and most continuous blooming of all, never being out of flower from the end of June until cut down by hard frost. The clear turquoise-blue of its flowers is not equalled for delicacy and beauty by any other flower. 25 cts. each; \$2.50 per doz.; \$20.00 per 100.

Chinense. A very pretty variety, with fine feathery foliage and intense gentian-blue flowers in open panicles.

— **Album.** A pure white form of the above.

Formosum. The old favorite dark blue with white centre.

Gold Medal Hybrids. Unquestionably the finest strain of mixed hybrids ever offered. The plants are of strong, vigorous habit, with large flowers in spikes two feet and over long, the majority running in the lighter shades of blue. 20 cts. each; \$2.00 per doz.; \$15.00 per 100.

Sulphureum (*Zalil*). An attractive species, covered during June and July with pure sulphur-yellow flowers. 25 cts each; \$2.50 per doz.

Mixed Hybrids. A fine lot of seedlings grown from a select strain.

DICTAMNUS (Gas Plant).

A very showy perennial, forming a bush about 2½ feet in height, having fragrant foliage and spikes of curious flowers during June and July, giving off during hot weather a fragrant volatile oil, which ignites when a match is applied.

Fraxinella. Showy rosy-pink flowers, with deeper veins.

— **Alba.** Pure white.

— **Caucasicus.** A new and gigantic form of the pink variety. Flowers fully double the size of the type. 35 cts. each; \$3.50 per doz.

DIELYTRA (Bleeding Heart). (See page 23.)

DIGITALIS.

(Foxglove.)

The Foxgloves, old-fashioned, dignified and stately, during their period of flowering dominate the whole garden.

Gloxiniæflora (*Gloxinia-flowered*). A beautiful strain of finely-spotted varieties. We offer them in *White, Purple, Lilac, Rose or Mixed*.

Ambigua, or Grandiflora.

Showy flowers of pale yellow, veined brown.

Lanata. Dense spikes of odd-looking flowers; corolla gray, with creamy-white tips.

DORONICUM (Leopard's Bane).

One of the most effective very early spring-flowering perennials, growing about 2 feet high and beginning to bloom early in April.

Columnæ. Very large; bright yellow.

Clusii. Rich yellow, 2½ to 3 inches across.

Excelsum. Large orange-yellow; 3½ inches across. 25 cts. each; \$2.50 per doz.; \$15.00 per 100.

ERIGERON (Flea Bane).

Coulteri. Purplish-blue; July; 1 foot.

Glabellus. Large purplish-violet flowers; July to September; 15 inches.

Grandiflorus elatior. Large, solitary purple flowers, with bright yellow disc; June and July; 18 inches.

EUPATORIUM.

Ageratoides (*Thorough-wort*). A useful border plant, of strong, free growth, 4 feet high, with minute white flowers in dense heads; August and September

Celestinum. A pretty, hardy plant, with light blue flowers similar to the *Ageratum*. In flower from August until frost; 2 feet.

EUPHORBIA (Milk Wort).

Corallata (*Flowering Spurge*). A most showy and useful native plant, growing about 18 inches high, and bearing from June till August umbels of pure white flowers with a small green eye. 10 cts. each; \$1.00 per doz.; \$8.00 per 100.

FUNKIA (Plantain Lily). (See page 24.)

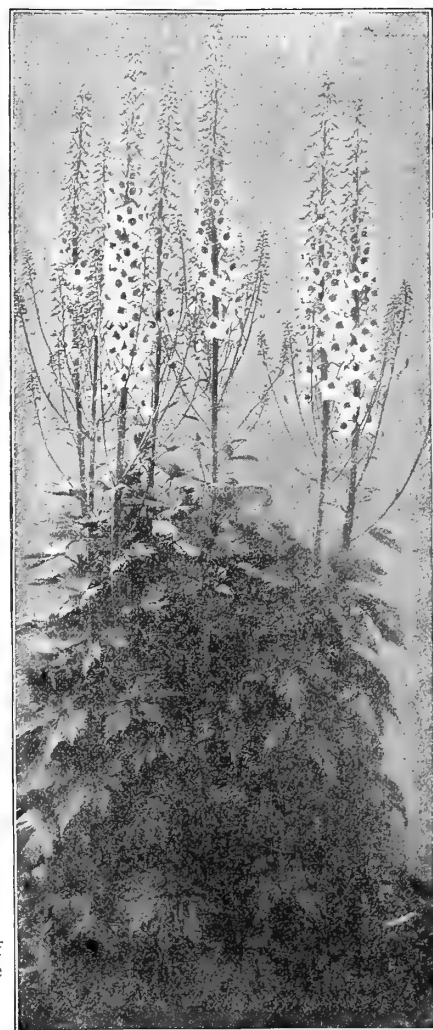

DELPHINIUM (Hardy Larkspur).



DICTAMNUS.

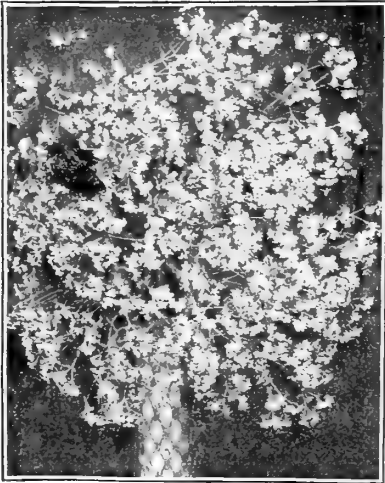

GYPSOPHILA PANICULATA.

GAILLARDIA (Blanket Flower).

Grandiflora. One of the showiest and most effective hardy plants, growing about two feet high; beginning to flower in June they continue one mass of bloom the entire season. The large flowers are of gorgeous coloring. The centre is dark red-brown, while the petals are variously marked with rings of brilliant scarlet-crimson, orange and vermilion. Excellent for cutting.

GYPSOPHILA (Baby's Breath).

Acutifolia. A strong-growing kind, attaining a height of 2 feet, with large panicles of small white flowers in July.

Cerastioides. A most useful variety for the rockery, growing but 3 inches high, and producing from June to August small white flowers marked with pink.

Paniculata. A beautiful old-fashioned plant, possessing a grace not found in any other perennial. It forms a symmetrical mass 2 to 3 feet in height, and as much through, of minute pure white flowers, having a beautiful gauze-like appearance. For cutting purposes it is exquisite.

Paniculata Fl. Pl. A new double-flowering form of the above. 25 cts. each; \$2.50 per doz.

Repens. An elegant trailing plant for the rockery, with clouds of small flowers.

ORNAMENTAL GRASSES.

Erianthus Ravennæ (*Plume Grass, or Hardy Pampas*). Grows from 9 to 12 feet high, frequently throwing up from 30 to 50 flower spikes. It closely resembles the Pampas Grass.

Eulalia Gracillima Univittata (*Japan Rush*). Of graceful habit, with very narrow foliage; of a bright green color, with a silvery midrib.

— **Japonica Variegata.** A very ornamental variety; long, narrow leaves, striped green, white and often pink or yellow. Flower stalks from 4 to 6 feet.

— **Zebrina** (*Zebra Grass*). The long blades of this variety are marked with broad yellow bands across the leaf. It makes a very attractive specimen plant for the lawn.

Price: Any of the above Grasses 25 cts. each; \$2.50 per doz.

HELIOPSIS (Orange Sunflower).

Similar in general habit to Helianthus, but commencing to flower earlier in the season; of dwarfer habit, rarely exceeding 3 feet in height; very valuable for cutting.

Pitcheriana. Flowers deep golden-yellow color, about 2 inches in diameter, of very thick texture, and very graceful for cutting.

Pitcheriana Semi-plena. A semi-double form of the above.

Scaber Major. Orange-yellow flowers the entire summer.

HEMEROCALLIS (Day Lily). See page 25.**HELIANTHUS** (Hardy Sunflowers).

The perennial Sunflowers are among the most effective hardy plants for large borders, for planting among shrubbery, or as clumps on the lawn. They are remarkably free-flowering, will succeed in any soil, and are invaluable for decorative purposes or as cut flowers during the summer.

Daniel Dewar. The earliest to flower, bearing large single yellow flowers from early July till late August; 6 feet.

Maximiliana. The latest of all, perfecting its fine golden-yellow flowers in long, graceful sprays during October; invaluable for cutting; 5 to 7 feet.

Miss Mellish. Flowers in September and October. Grows about 6 feet high, with large, single golden-yellow flowers.

Mollis. Large, single lemon-yellow flowers, with downy white foliage; blooms in August and September; 4 feet.

Oryalis. Medium-sized single golden-yellow; in September; 6 feet.

Rigidus. One of the most desirable, beginning to bloom early in July and continuing until fall; flowers golden-yellow, with dark centres; 3 feet.

Sparsifolius. Graceful, single, deep yellow flowers on long stems, making it a most valuable cut flower; Ang.-Sept.; 6 to 8 feet.

Wolley Dod. The best of the September-flowering varieties, with deep yellow flowers; entirely distinct.

HELENIUM (Sneeze-wort).

All of these are desirable border plants, with broad-spreading heads of flowers, each species covering a long blooming season.

Autumnale Superbum. Golden-yellow flowers during the late summer and fall months; 5 to 6 feet.

Grandicephalum Striatum. Branching heads, of a deep orange color, irregularly striped and blotched with crimson; July and August; 3 feet.

Hoopesi. Pure orange-yellow flowers, coming in early in June and continuing throughout the summer; 2 feet.

Pumilum Magnificum. A most useful summer and autumn-flowering perennial, growing about 18 inches high and almost smothered with its golden-yellow blossoms.

Riverton Gem. A new red variety which originated at our nurseries. 25 cts. each; \$2.50 per doz.

Riverton Beauty. Another variety which originated with us. Flowers lemon-yellow, with a large purplish-black cone; August to October; 3 to 4 feet. 25 cts. each; \$2.50 per doz.



HELENIUM RIVERTON BEAUTY.

HEPATICA (Liver Leaf).

Angulosa. One of the prettiest very early spring-flowering plants, with white, red or purple flowers and handsome foliage; well suited for shady nooks in the rockery.
Triloba. A pretty native spring-flowering plant with pretty blue flowers.

HESPERIS (Rocket).

Matronalis. A strong-growing perennial, forming stout, bushy plants 3 to 4 feet high, with showy terminal spikes of pink flowers during June and July.

HEUCHERA (Alum Root).

Most desirable dwarf, compact, bushy plants, of robust constitution and easy culture, growing 1½ to 2 feet high, and bearing during July and August loose, graceful spikes of flowers in the greatest profusion; excellent subjects either for the border or rockery.
Sanguinea. Bright coral-red.
Sanguinea Alba. Creamy-white.
Rosea. Rose-colored.

HIBISCUS (Mallow).

Desirable border plants, growing 4 feet high, with large foliage and large, showy flowers of delicate coloring, produced during the entire summer.
Militaris (*Halbert-leaved Rose Mallow*). A tall-growing species with delicate flesh-pink flowers, tinged with deeper color toward the centre.
Moscheutos (*Swamp Rose Mallow*). Light rosy-red, with darker eye.
 — “**Crimson Eye.**” Purest white, with deep crimson centre.

DREER'S SUPERB HOLLYHOCKS.

Few hardy plants combine as many good qualities as the Hollyhock. For planting in rows or groups on the lawn, or for interspersing among shrubbery, they are invaluable. The Hollyhock requires a rich, deep soil, well drained, and will repay any extra care. A slight protection during the winter will be beneficial.
Double White, Pink, Yellow, Maroon and Bright Red. 20 cts. each; \$2.00 per doz.; \$15.00 per 100.
Double Fringed Allegheny. We offer in mixed colors stock grown from carefully selected seed. 20 cts. each; \$2.00 per doz.; \$15.00 per 100.
Double Mixed Colors. **Single Mixed Colors.**

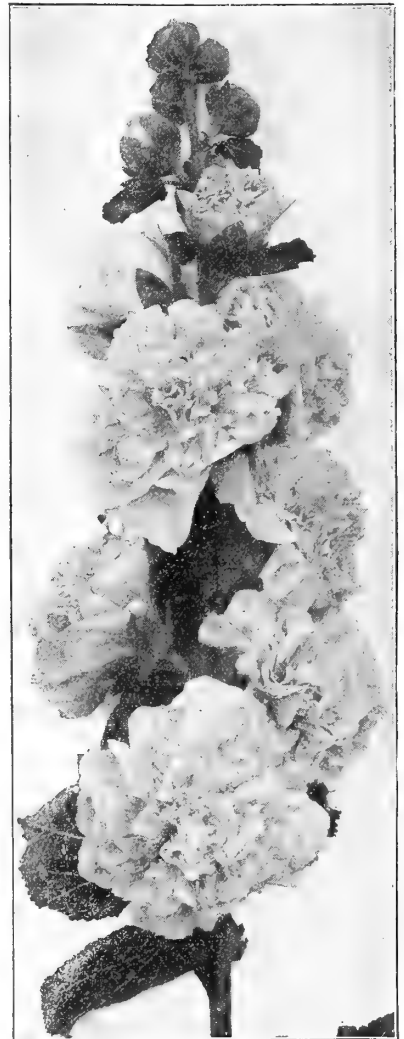

DOUBLE HOLLYHOCK.

IBERIS (Candytuft).

A most desirable dwarf plant with evergreen foliage, which is completely hidden with dense heads of flowers early in the spring.
Corraefolia. Grows about 9 inches high; fine heads of white flowers.
Sempervirens. Produces innumerable flat heads of pure white flowers.
Snowflake. A new variety and a grand improvement on existing sorts, having exceptionally large and pure white flowers. 30 cts. each; \$3.00 per doz.

IRIS (Flags). See pages 25, 26 and 27.

LIATRIS (Blazing Star, or Gay Feather).

Most showy and attractive native plants; large spikes of flowers from July to September.
Pycnostachya (*Kansas Gay Feather*). Spikes of light, rosy purple flowers; 5 feet.
Scariosa. Purple flowers; 3 to 4 feet.
Spicata. Deep purple flowers in spikes 2 to 3 feet high.

LOBELIAS.

Handsome border plants, thriving in any ordinary garden soil, but preferring a moist, deep loam, where they will not suffer from drouth. Few plants are more effective at their season of bloom, which extends from July till late in September.
Cardinalis (*Cardinal Flower*). Rich, fiery cardinal flowers.
Syphilitica hybrida (*Great Lobelia*). A choice selection of our native Lobelia, producing large spikes of flowers varying from blue to pure white; July to September.

LUPINUS (Lupine).

Polyphyllus. An effective plant about 3 feet high, producing its large spikes of blue flowers from June to September.

LYTHRUM.

Roseum Superbum (*Rose Loosestrife*). A strong-growing plant, 3 to 4 feet high, thriving in almost any position, producing large spikes of rose-colored flowers from July to September.



LOBELIA CARDINALIS.



LYCHNIS CHALCEDONICA.

LYCHNIS (Campion).

All the *Lychnis* are of the easiest culture, and this, in addition to their brightness, has brought them into high favor.

Chalcedonica. A most desirable plant, heads of brilliant orange-scarlet, grows 2 to 3 feet high and blooms all summer.

Chalcedonica Fl. Pl. A double-flowering form, producing immense heads of vermilion-scarlet flowers, 2 to 3 feet high, flowering from July to September. 25 cts. each; \$2.50 per doz.

— **Alba.** White-flowered form.

— **Carnea.** A pale pink variety.

Dioca Rosea. Rose-colored flowers; May and June; 15 inches.

Haageana. Brilliant orange-scarlet flowers in May and June; 12 inches.

Vespertina, Double White. Large, double white flowers, produced in the greatest profusion the entire summer; 18 inches high. 25 cts. each; \$2.50 per doz.

Viscaria, Double Red. Forms a dense tuft of ever-green foliage, and in June sends up spikes of handsome, double, deep-red, fragrant flowers.

MENTHA (Mint).

Piperita (*Common Peppermint*).

Rotundifolia variegata. Foliage dark green, with creamy white variegation.

Spicata or Virides (*Spear-mint*).

10 cts. each; \$1.00 per doz.; \$6.00 per 100.

MERTENSIA (Blue Bells).

Virginica. An early spring-flowering plant, growing about 1 to 1½ feet high, with drooping panicles of handsome light blue flowers, fading to clear pink; one of the most interesting of our native spring flowers; May and June.

MONARDA (Bergamot).

Showy plants, growing from 2 to 3 feet high, with aromatic foliage, and producing their flowers during July and August.

Didyma (*Oswego Tea*). Flowers bright scarlet, produced in spikes.

— **Cambridge Scarlet.** Brilliant crimson-scarlet.

— **Rosea** (*Bee Balm*). A pretty rose-colored form.

— **Splendens.** Intense rich crimson-scarlet.

Fistulosa Alba (*Wild Bergamot*). A showy white-flowered variety.

GENOTHERA (Evening Primrose).

Fraseri. Beautiful rich yellow; 1½ feet.

Missouriensis. Large golden-yellow; 1 foot.

Pilgrimi. Large clusters of bright yellow.

Speciosa. A rare, pure white variety.

Youngi. Bright yellow; 1 foot.

PÆONIES. (See pages 31 and 32.)**PACHYSANDRA.**

Terminalis. A trailing plant, 6 to 8 inches high, forming broad mats of bright, glossy green foliage and small spikes of flowers during May and June; mainly valuable on account of its foliage.

— **Variegata.** A variegated-leaved form of the above.

PARDANTHUS (Blackberry Lily).

Sinensis. Lily-like flowers of bright orange during July and August, on 2½ feet high stems, followed in September with seeds which resemble blackberries. 10 cts. each; \$1.00 per doz.; \$7.00 per 100.

ICELAND POPPY (*Papaver nudicaule*).

The plant is of neat habit, forming a tuft of bright green fern-like foliage, from which spring, throughout the entire season, a profusion of slender, leafless stems one foot high, each graced with charming cup-shaped flowers. We offer them in white, yellow, orange-scarlet, or in mixture.

ORIENTAL POPPY (*Papaver Orientale*).

For a gorgeous display of rich, brilliant coloring, nothing can equal the Oriental Poppies during their period of flowering in May or June, and whether planted singly or in masses, their large flowers render them conspicuous in any position.

Goliath. Fiery scarlet.

Princess Louise. Salmon pink.

Psyche. Delicate rosy blush.

Silberblick. Bright salmon-red, with white spots.

Trilby. Brilliant red.

25 cts. each. Set of 5 varieties, \$1.00.

Finest Mixed Varieties, 15 cts. each; \$1.00 per doz.; \$10.00 per 100.



ORIENTAL POPPY.

PENTSTEMON (*Beard Tongue*).

Most useful perennials, either for the border or rockery.

- Barbatus Torreyii.** Spikes of brilliant scarlet flowers; height 3 to 4 feet.
- Diffusus.** Violet-blue flowers; June and July; 2 feet.
- Digitalis.** Large spikes of long, purple-white flowers, with purple throats, during June and July; 2 to 3 feet.
- Gilaber.** A trailing species, about a foot high, bearing in early summer showy flowers, varying from light to dark blue.
- Grandiflorum.** Large bright purplish-blue flowers in spring; 2½ feet.
- Heterophyllus.** Lovely azure-blue flowers in summer; 2 feet.
- Ovatus.** Bright blue shaded purple flowers; July to September; 2 feet.
- Pubescens.** Bright rosy-purple, July and August; 1½ feet.
- Smalli.** Rosy-carmine flowers in early summer; 1 foot.

PETASITES.

Fragrans (*Winter Heliotrope*). Grows about 1 foot high, and produces, frequently as early as the middle of March, numerous spikes of strongly heliotrope-scented flowers. An excellent plant for low, moist ground.

PHYSOSTEGIA (*False Dragon Head*).

One of the most beautiful of our mid-summer flowering perennials, forming dense bushes 3 to 4 feet high, bearing spikes of delicate tubular flowers. (See cut.)

- Virginica.** Bright but soft pink.
- **alba.** Pure white; very fine.
- **Speciosa.** Very delicate pink.

HARDY GARDEN PINKS.

Old favorites, bearing their sweet clove-scented flowers in the greatest profusion during May and June.

- Comet.** Large rosy-red.
- Delicata.** Soft delicate rose; very free.
- Diamond.** A fine extra early-flowering fringed white.
- Elsie.** Bright rose with maroon centre.
- Her Majesty.** Flowers of large size and of the purest white.
- Homer.** Rich rosy-red with dark centre.
- Juliette.** White, laced crimson.
- Snow.** A fine pure white.
- Souv. de Salle.** Soft rosy-red.
- Stanislaus.** Violet-rose, with deep crimson centre.
- White Reserve.** An everblooming pure white.

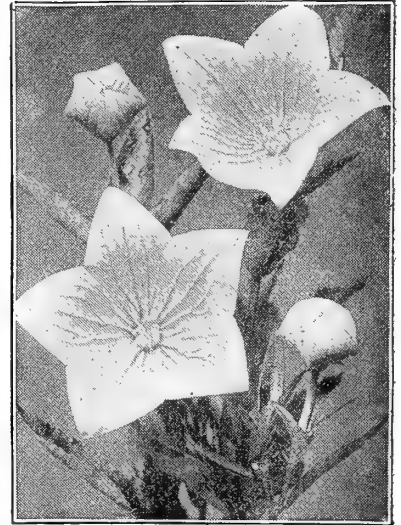

PLATYCODON GRANDIFLORA.

PHYSALIS (*Chinese Lantern Plant*).

Francheti. An ornamental variety of the Winter Cherry, forming dense bushes 2 feet high, producing bright orange-scarlet lantern-like fruits; highly interesting.

PLUMBAGO (*Lead-wort*).

Larpentæ. Of dwarf spreading habit, growing 4 to 6 inches high; useful as an edging plant or for the rockery; covered with beautiful deep blue flowers during the summer and fall months.

PODOPHYLLUM.

Peltatum (*May Apple or Mandrake*). A well-known native plant, which is worthy of a place in every shady border. 10 cts. each; \$1.00 per doz.

PLATYCODON.

(*Balloon Flower, or Japanese Bell-flower.*)

The Platycodons are closely allied to the Campanulas, and form neat branched bushes of upright habit, which bear a continual succession of flowers from June until October:

- Grandiflorum.** Deep blue-cupped, star-shaped flowers: 1½ ft. (See cut.)
- **Album.** A white-flowered form of the above.
- Mariesi.** Deep blue bell-shaped flowers, nearly 3 inches across, on one foot high plants.

POLYGONUM.

Compactum. A variety which is deserving of great popularity; it grows about 15 inches high, and during August and September the entire plant appears as a foamy mass of white flowers.

Cuspidatum (*Giant Knotweed*). A tall-growing species, attaining a height of 5 to 7 feet, and producing during August and September long, drooping clusters of white flowers at the axil of each leaf along the upper half of the stem; a striking plant for the shrubbery or as an isolated specimen.

POTENTILLA (*Cinquinfoil*).

Charming plants for the border, with brilliant flowers that are produced from June to August in profusion; they grow about 18 inches high, and will succeed in any garden soil.

- Formosa.** Single, rosy-red.
- Hamlet.** Double dark rich crimson.
- MacNablana.** Rich crimson, very double.
- Perfecta.** Double vermilion, lemon centre.
- Phoenix.** Double scarlet, marked yellow.
- Sanguinea.** Single, orange-red, marked yellow.
- Striatissima.** Double scarlet with yellow markings.

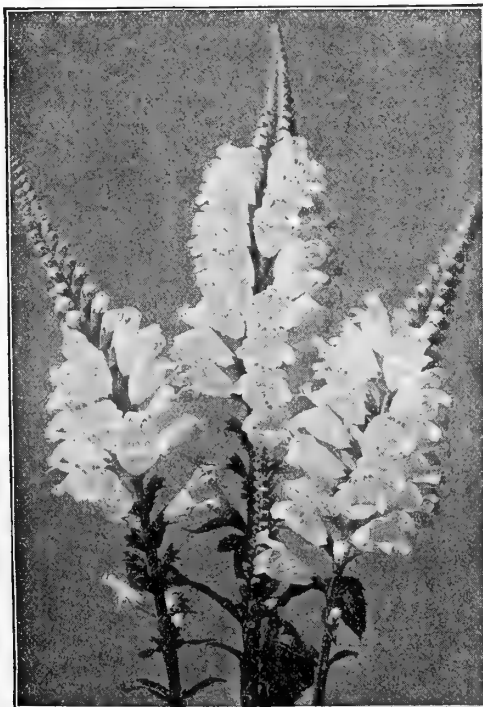

PHYSOSTEGIA.



HARDY PHLOX.

GENERAL COLLECTION OF HARDY PHLOX.

For convenience in selecting we have arranged them in color classes :

BEST ROSE AND PINK SORTS.

- Bacchante.** Tyrian rose with crimson-carmine eye.
Caran d'Ache. Geranium red, with old rose shadings and white eye; very effective.
Clara Benz. Lovely carmine rose with deeper eye.
General Giovaninelli. Bright Tyrian rose, with light shadings at the base of each petal; a pure red eye.
La Vague. Pure mauve with aniline-red eye.
Pacha. Deep pink suffused with red, carmine eye.
Pantheon. Bright carmine-rose. A fine effective variety.
Selma. A pretty, delicate, soft pale rose, with distinct red eye.
Sunshine. Aniline-red with crimson eye and light halo.
Von Goethe. Tyrian rose, suffused with carmine-lake.

BEST WHITE SORTS.

- Albion.** A strong, vigorous grower, producing very large panicles of pure white flowers, with a faint red eye.
Hermine. The dwarfest variety, ten inches in height; pure white flowers of good size, early; unequalled for bordering.
Jeanne d'Arc. A good late-flowering pure white.
Mrs. Jenkins. The best white for massing; immense panicles; early and free bloomer.

BEST SCARLET AND RED SORTS.

- Consul H. Frost.** Pure red, with bright French purple eye.
Coquelicot. A fine pure scarlet with crimson-red eye.
Etna. Crimson red, suffused with fiery-red; cherry-red eye.
Frau Dora Umgeller. Very rich, deep rosy-red.
Pecheur d'Islande. Crimson-red, suffused with cochineal-red and carmine-red eye.
R. P. Struthers. Bright rosy-carmine, with claret-red eye.

Price: Any of the General Collection in strong one-year-old plants, 15 cts. each; \$1.50 per doz.; \$10.00 per 100.

EARLY-FLOWERING HARDY PHLOX (*Phlox Suffruticosa*).

- Miss Lingard.** A grand white variety, which begins flowering after the middle of June and continues throughout the season. Extensively used for cut flowers. 20 cts. each; \$2.00 per doz.; \$12.00 per 100.

DREER'S Superb Hardy Phlox.

Among hardy perennial plants no class is of more importance than the Phloxes, succeeding in almost any soil and position, and flowering through a long season; and while they will continue in good condition and flower freely for many years without attention, yet they respond quickly to and are improved by liberal cultivation. Those who wish to grow Phloxes to the greatest perfection would do well to follow the directions given by Mrs. Helena Rutherford Ely and which appear in our Garden Book for 1909.

NEW AND RARE VARIETIES.

- Aglæ Adanson.** Immense flowers, snow-white, with red eye.
F. G. Von Lassburg. The purest white in cultivation; individual flowers larger than any other white.
General von Heutz. Brilliant salmon-red with white centre.
Geo. A. Strohleln. Bright scarlet, with crimson-red eye. A large flower; color does not bleach in the sun.
Helena Vacaresco. A free large-flowering dwarf white.
Jules Cambon. Brilliant reddish-purple, with exceptionally large, pure white centre.
Louis Blanc. Reddish violet with purple shadings.
Mme. Paul Dutrie. Delicate lilac-rose in shade like a soft pink Orchid; flowers very large, borne in immense panicles.
Prosper Henry. Large compact truss of pure white with bright crimson-carmine centre; dwarf.
Siebold. An improvement on the popular scarlet "Coquelicot," brighter in color and stronger.
Vesuvius. One of our new seedlings, pure red, with bright purple eye; a dazzling color.
Von Hochberg. The ideal crimson; the richest of its color.

Price, 25 cts. each; \$2.50 per doz.; \$18.00 per 100. Set of 12 varieties for \$25.50.

Best Crimson and Purple Sorts.

- B. Comte.** A glowing reddish or French purple.
Champs Elysee. A bright rosy magenta; very effective.
Eclairer. Brilliant rosy magenta with large lighter halo.
Edmond Rostand. Reddish-violet, shading brighter towards the centre of petals, large, white, star-shaped centre.
La Foudre. Rich glowing French purple, shading crimson.
Le Mahdi. Deep reddish-violet, with deeper eye.
Obergartner Wittig. Bright magenta, with crimson-carmine eye; large flowers and truss; the best of its type.

BEST MOTTLED SORTS.

- Antonin Mercie.** Light ground color, one-half of each petal suffused bluish-lilac.
Beranger. Ground color white, delicately suffused with rosy-pink and distinct amaranth-red eye.
De Miribel. White suffused with rosy-scarlet, crimson eye.
Eugene Danzenvillier. Lilac, shading white towards the edges; large white centre.
Mozart. Ground color white, suffused with salmon, red eye.

Best Light Dark-eyed Sorts.

- Bridesmaid.** Pure white, with large crimson-carmine eye.
Colibri. White, with crimson-carmine centre; very late.
H. O. Wijers. Pure white, with crimson-carmine eye.
Henry Murger. White, with crimson-carmine centre.

PHLOX SUBULATA.

(Moss, or Mountain Pink.)

An early spring-flowering type, with pretty moss-like evergreen foliage, which, during the flowering season, is hidden under the masses of bloom. An excellent plant for the rockery, the border, and invaluable for carpeting the ground or covering graves. We offer six varieties.

- | | |
|---|-------------------------------|
| Alba. Pure white. | Lilacina. Light lilac. |
| Atropurpurea. Purplish-rose. | Nelsoni. Pure white. |
| Bridesmaid. Purplish-tinted white. | Rosea. Bright rose. |
- 10 cts. each; \$1.00 per doz.; \$6.00 per 100. Set of 6 for 50 cts.

VARIOUS PHLOXES

Amœna. The best variety for carpeting the ground, the rockery or the border; it grows but 4 inches high, and in spring is a sheet of rich, bright pink flowers. 10 cts. each; \$1.00 per doz.; \$6.00 per 100.

Carolina. A dwarf-growing species, rarely exceeding 12 inches in height, and producing during May and June masses of bright rosy-red flowers.

Divaricata Canadensis. One of our native species, which is worthy of extensive planting, commencing to bloom early in April, and continuing through May, with large, fragrant lavender flowers on stems 10 inches high.

PULMONARIA (Lungwort, Bethlehem Sage).

Saccharata Maculata. A beautiful plant, rivaling in the markings of its foliage many of the choicest hothouse plants; of easy culture; foliage deep green, handsomely mottled with silver-gray and terminal 1 foot high spikes of pink, changing to blue flowers during May and June. 25 cts. each; \$2.50 per doz.; \$15.00 per 100.

PRIMULAS (Primrose).

Auricula. The plants we offer of this old favorite have been grown from seed of one of the finest European collections. Mixed colors, 25 cts. each; \$2.50 per doz.

Veris (English Cowslip). Plants grown from a select strain of seed, and embrace a fine range of colors. 10 cts. each; \$1.00 per doz.; \$8.00 per 100.

Veris Superba. A giant-flowered form of the English Cowslip, producing individual flowers from 1 to 2 inches across in heavy trusses, which measure from 10 to 15 inches in circumference; in color they are a bright canary-yellow with a golden centre; perfectly hardy, and when in flower present a complete sheet of bloom. (See cut.)

Vulgaris (English Primrose). An old favorite, and should be found in every garden; one of the earliest spring flowers; of bright canary-yellow; very fragrant.

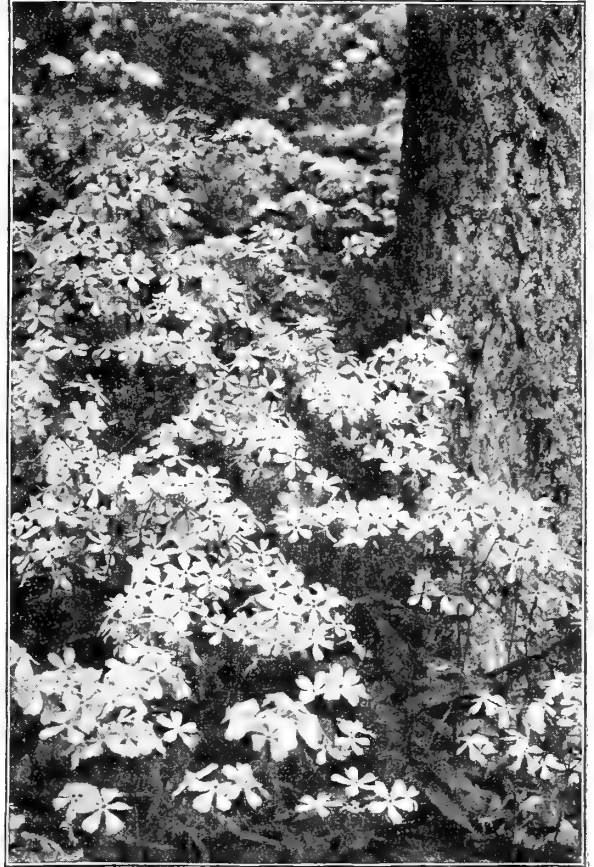

PHLOX DIVARICATA CANADENSIS.

PRIMULA CORTUSOIDES SIEBOLDII.

(Japanese Primrose.)

These are not so well known as they deserve; they are of free-growth, with dark green foliage, and throw up in late spring innumerable stems of large flowers, varying in color from pure white to rich crimson. They succeed under the same conditions as the common hardy Primroses, and are also useful for forcing under glass, making beautiful pot plants.

- Else Beyer.** Bright rose, with lighter centre.
- Lilacina Marginata.** Large white flowers, veined with mauve on the edges.
- Queen Victoria.** Very fine, large pure white.
- Robert Herold.** Large flowers of a bright rosy-crimson with white eye.
- Sirius.** Rich crimson-rose, with white centre.
- Werner.** Tender rose, with white veins.

20 cts. each; \$2.00 per doz. Set of 6 sorts for \$1.00.

PYRETHRUM.

Hybridum Fl. Pl. Too much cannot be said in favor of this grand hardy perennial, which will thrive in any good garden soil where there is good drainage and full exposure to the sun. Splendid for cutting, lasting a week in good condition.

- Alfred.** Rich crimson.
- Bridesmaid.** A fine large pure white.
- Ne-plus-ultra.** Blush-pink.

30 cts. each; \$3.00 per doz. Set of 3 for 75 cts.

Hybridum Single. In choicest mixture.
Uliginosum (Giant Daisy). Grows 4 to 5 feet high, and is covered with large white daisy-like flowers 3 inches in diameter from July to September.



PRIMULA VERIS SUPERBA.



RUDBECKIA RAYS OF GOLD.

RHEXIA (Meadow Beauty).

Virginica. A handsome dwarf plant, 9 inches, flowering the greater part of the summer, with numerous bright rosy-purple blossoms, and long, protruding golden anthers; a grand subject for massing in a moist, sunny spot.

RUDBECKIA (Cone Flower).

Fulgida. Brilliant orange-yellow flowers, produced in masses, from July to September; 2 feet high.

Golden Glow. We question if any one hardy perennial plant has ever met with greater popularity than this. Produces masses of double golden-yellow Dahlia-like flowers from July to September.

Maxima. A rare and attractive variety, growing 5 feet high, with large glaucous green leaves and bright yellow flowers 5 to 6 inches across, with a cone 2 inches high; flowers from June to September. 25 cts. each; \$2.50 per doz.

Newmanii. Dark orange-yellow flowers, with deep purple cone, borne on stiff, wiry stems, 3 feet high, admirably fitting it for cutting. Flowers from July to October.

Nitida, Autumn Sun. A single-flowering sort, an improvement on "Autumn Glory," its flowers being far more showy. It has longer, broader petals of a bright primrose-yellow, grows 5 to 6 feet high, and flowers from August to October. 25 cts. each; \$2.50 per doz.

Purpurea (Giant Purple Cone-flower). Flowers about 4 inches across, of a peculiar reddish purple, with a remarkably large, cone-shaped centre of brown; forms bushy plants from 2 to 3 feet high, and blooms from July to October.

Rays of Gold. In this new variety we have a refined form of the popular Golden Glow, the flower having the same golden color, but with narrower petals, which forms a perfect globe. 25 cts. each; \$2.50 per doz.

Sub-Tomentosa. A pyramidal, densely-branched plant, 2½ feet high, enveloped throughout the summer in a mass of brilliant lemon-yellow flowers with dark purple centres.

Triloba. Forms a much-branched plant, 3 feet high, which is covered during August and September with medium-sized attractive yellow flowers, with brown disc.

SALVIA (Meadow Sage).

Azurea Grandiflora. A Rocky Mountain species, growing 2 to 3 feet high, producing during August and September pretty sky-blue flowers in the greatest profusion.

Pratensis. Showy spikes, 2 to 3 feet high, of deep blue flowers, from June to September.

SCABIOSA.

Caucasica (Blue Bonnet). A soft, charming shade of lavender; 15 to 18 inches; July to September.

— **Alba.** The white-flowering form of above.

Japonica. A variety from Japan, forming bushy plants 2½ to 3 feet in height, and bearing on long, wiry stems beautiful artistic lavender-blue flowers, 2 to 2½ inches across. The plants are extremely floriferous, producing a continuous crop from the end of June until late in autumn.

Ochroleuca. Sulphur-yellow flowers; July to September; 2½ feet.

SEDUM (Stone Crop).**DWARF VARIETIES.**

Suitable for the rockery, carpet bedding, etc.

Acre (Golden Moss). Much used for covering graves; foliage green; flowers bright yellow.

Album. Green foliage, white flowers.

Pulchellum. Bronzy green foliage and purplish flowers.

Sexangulare. Dark green foliage, yellow flowers.

Spurium. Attractive pink flowers; 6 inches.

— **Coccineum.** A beautiful crimson-flowered form of the preceding.

10 cts. each; \$1.00 per doz.; \$8.00 per 100.

ERECT, OR TALL-GROWING VARIETIES.

Useful and pretty plants for the border, producing their interesting flowers during late summer and fall.

Japonicum Macrophyllum. Forms compact bushes 15 inches high, with pleasing waxy-white flowers, with light pink centres.

Maximum Atropurpureum. Interesting on account of its dark bronzy-purple foliage; 15 inches.

Spectabilis (Brilliant Stone-crop). One of the prettiest erect-growing species, attaining a height of 18 inches, with broad light green foliage and immense heads of handsome showy rose-colored flowers; indispensable as a late fall-blooming plant.

— **Atropurpurea.** Like the type, this forms an erect, bushy plant about 18 inches high, with broad, oval, light green foliage, and producing in September and October gigantic, showy heads of deep rosy-crimson flowers. A decided acquisition for the hardy border.



SEDUM SPECTABILIS.

SOLIDAGO (Golden Rod).

The varieties offered below are the most desirable of our popular native Golden Rods.

Altissima. The giant of the family, attaining a height of 10 to 12 feet; the large heads of golden-yellow flowers do not reach perfection until late in October.

Canadensis. Grows 4 to 5 feet high, with spikes of golden-yellow flowers from the end of July until September.

Rigidus. A bold plant, with large heavy foliage and immense heads of rich yellow flowers in August and September.

Shortia. Golden-yellow flowers in July and August; 3 feet.

SPIRÆA (Goat's Beard, Meadow Sweet).

Aruncus. A noble variety, 3 to 5 feet high, producing in June and July long, feathery panicles of white flowers.

— **Kneiffi** A new variety, 3 to 4 feet high, with foliage divided as fine as a fern, with great sprays of silvery-white flowers in June. 25 cts. each; \$2.50 per doz.

Chinensis. A distinct and handsome species, with large heads of silvery-pink flowers in June and July; 2 feet. 25 cts. each; \$2.50 per doz.

Filipendula Fl. Pl. (*Double-flowered Drop-wort*). Numerous corymbs of double-white flowers, on stems 12 inches high, during June and July, and pretty fern-like foliage.

Gigantea, or Kamtschatica. Forms a bold plant 5 to 6 feet high, with large palmate leaves and immense heads of white flowers from July to September. 25 cts. each; \$2.50 per doz.

Palmata (*Crimson Meadow Sweet*). One of the most beautiful hardy plants, the deep purple-red of the stems and branches passing into the crimson-purple of the broad corymbs of flowers, which are produced very freely during June and July; 3 feet.

— **Elegans.** A free-flowering, silvery-pink form.

Venusta. A showy, red-flowering species; very fragrant; 4 to 5 feet; June.

Ulmaria Fl. Pl. (*Meadow Sweet*). A double white form.

STENANTHIUM (Mountain Feather Fleece).

Robustum. A remarkable perennial, with tall, showy panicles of pure white feathery flowers, on stems 4 to 5 feet high. Valuable for naturalizing in moist, shady corners. 50 cts. each; \$5.00 per doz.

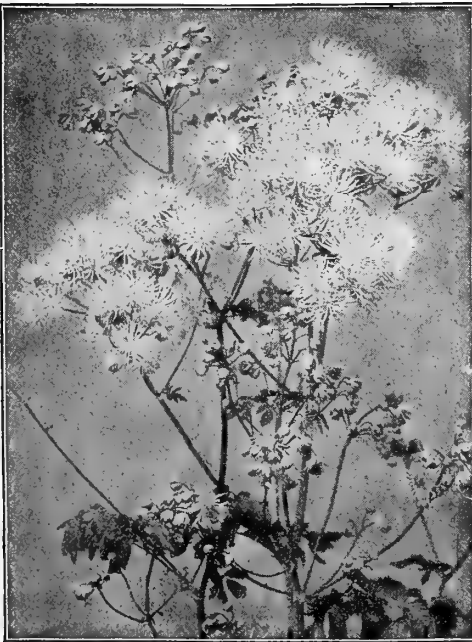

THALICTRUM.



STOKESIA CYANEA (Cornflower Aster).

STATICE (Sea Lavender).

Most valuable plants either for the border or rockery, with tufts of leathery foliage and immense candelabra-like panicles of minute flowers, producing a remarkable effect; grows from 15 to 18 inches high, and blooms from June until September.

Eximia. Bears immense heads of lovely lilac flowers.

Gmelini. Large panicles of violet-blue flowers.

Latifolia (*Great Sea Lavender*). Immense heads, 2 to 3 feet across, of deep blue flowers, which last for months if cut and dried.

Tartarica. Bright purplish-red flowers in graceful panicles.

STOKESIA (The Cornflower, or Stokes' Aster).

Cyanea. A most charming and beautiful native hardy plant. Grows from 18 to 24 inches high, bearing freely from early in July until October its handsome lavender-blue Cornflower-like blossoms, which measure from 4 to 5 inches across. It is of

the easiest culture, succeeding in any open, sunny position, and not only is it desirable as a single plant in the hardy border, but it can also be used with fine effect in masses or beds of any size.

Cyanea alba. A new variety. Flowers identical to the now so popular blue variety, except in color, which is pure white. A decided novelty and a desirable addition to the list of hardy plants.

TANACETUM (Tansy).

Vulgare. The common Tansy; golden-yellow flowers in mid-summer; 3 feet.

THALICTRUM (Meadow Rue).

Very graceful, pretty-flowered plants, with finely-cut foliage; great favorites for planting in the hardy border. (See cut.)

Aquilegfolium atropurpureum. Elegant, graceful foliage and masses of rosy-purple flowers; 3 feet.

Cornuti. Panicles of white flowers in June and July; 4 to 8 feet.

Flavum. Large yellow flowers in July and August; 4 feet.

Glaucum. Fine cut foliage, bronzy-yellow flowers in June, 2 feet.

Minus. Finely-cut foliage and pale yellow flowers; 1½ feet.

THYMUS (Thyme).

Serpyllum (*White Mountain Thyme*). A pretty subject for the rockery, forming dense mats of dark green foliage and clouds of white flowers.

— **Coccinea** (*Scarlet Thyme*). Dark green foliage and clouds of bright red flowers.

— **Splendens.** Bright purplish-red flowers.



TROLLIUS (GLOBE FLOWER).

TROLLIUS (Globe Flower).

Popular hardy perennials, flowering freely from May until August; 2 to 2½ ft.

Europæus. Large, bright yellow, globular flowers, 2 inches in diameter.

Fire Globe. Large bright orange-red flowers.

Japonicus "Excelsior." Very deep orange flowers.

Caucasicus "Orange Globe." A rare variety, with large deep orange-colored flowers.

TRADESCANTIA (Spider-wort).

Virginica. Produces a succession of purple flowers all summer.

— **Alba.** A white-flowered form.

TUNICA.

Saxifraga. A pretty tufted plant with light pink flowers; produced all summer; useful either for the rockery or the border. 25 cts. each; \$2.50 per doz.

VALERIANA (Spurred Flower).

Coccinea (Valerian). An old-fashioned perennial, bearing numerous showy heads of reddish flowers from June to October; 2 feet.

— **Alba** A white-flowered form.

Officinalis (Hardy Garden Heliotrope). Produces showy rose-pink heads of flowers during June and July, with strong heliotrope odor.

VINCA (Periwinkle or Trailing Myrtle).

Minor. An excellent dwarf evergreen trailing plant that is used extensively for carpeting the ground under shrubs and trees, or on graves where it is too shady for other plants to thrive. 10 cts. each; \$1.00 per doz.; \$8.00 per 100.

HARDY VIOLETS.

The varieties listed below, while not suited for forcing, are perfectly hardy, and are covered with flowers in early spring.

Pedata (Bird's Foot Violet). A native variety, with finely cut foliage and showy blue flowers. 10 cents each; \$1.00 per doz.; \$6.00 per 100.

— **Bicolor.** An elegant variety of the preceding, with the upper petals a rich royal purple; lower petals almost white. 15 cts. each; \$1.50 per doz.; \$10.00 per 100.

Double Russian. Fine large double deep purple flowers of exquisite fragrance. 10 cts. each; \$1.00 per doz.

COLLECTIONS OF HARDY PERENNIALS.

12 varieties, our selection \$1 50	50 varieties, our selection \$5 00
25 " " " 2 75	100 " " " 9 00

VERONICA (Speedwell).

Amethystina. Amethyst-blue flowers in July and August; 2 feet.

Incana. Bright silvery foliage with spikes of amethyst-blue flowers; July and August; 1 foot.

Longifolia Subsessilis. A pretty species with blue flowers, produced on spikes a foot long, continuing in bloom the entire summer and fall. 25 cts. each; \$2.50 per doz.; \$15.00 per 100.

Maritima. Long spikes of blue flowers from July to September; 2 feet.

Pectinata. Fine for the rockery; masses of blue flowers in May.

Prostrata. Dwarf and spreading, only 4 inches high; deep blue flowers in May and June.

Repens. A trailing variety, covered during May with blue flowers.

Rosea. A most desirable variety, bearing bright rose flowers; 1½ feet.

Rupestris. A fine rock plant, growing 3 or 4 inches high, thickly-matted deep green foliage, hidden in spring under a cloud of bright blue flowers.

Spicata. An elegant border plant, growing about 1½ feet high, producing long spikes of bright blue flowers.

— **Alba.** A white-flowered form of the above.

Virginica. Long spikes of white flowers in July and August; 3 to 5 feet.

YUCCA (Adam's Needle).

Filamentosa. Among hardy ornamental foliage and flowering plants this can be classed at the head of the list. Its broad, sword-like foliage and tall, branched spikes of large, fragrant, drooping, creamy-white flowers during June and July make it an effective plant for all positions. 25 cts. each; \$2.50 per doz.; \$15.00 per 100.



VERONICA LONGIFOLIA SUBSESSILIS.

Twelve "Best" Hardy Garden Roses.

The twelve sorts offered below combine as varied a range of color as can be brought together in such a number, and each one stands at the head of its color for freedom of flowering, perfect form, fragrance, hardiness and general excellence. We can supply them in strong two-year-old field-grown plants along about the beginning of November, which is as early as the wood is ripened sufficiently to admit of safe moving.

- Anna de Diesbach.** Clear, bright carmine-pink, very large, full and finely shaped; fragrant and a free bloomer.
- Baron de Bonstetten.** Velvety blackish-crimson; very large, double, fragrant flowers; a strong grower.
- Baroness Rothschild.** A superb Rose, of pale, satiny-rose; very large.
- Frau Karl Druschki.** This is the ideal hardy white Rose, pure in color, perfect in form; strong grower and remarkably free-flowering; superb in every way.
- General Jacqueminot.** Brilliant scarlet-crimson; an old favorite and one of the best known Roses in cultivation.
- Gloire Lyonnaise.** White, tinted with yellow; large, full and of good shape; very distinct and pleasing.

- Mrs. R. G. Sharman Crawford.** Deep rosy-pink, outer petals shaded with pale flesh. A beautiful Rose.
- Mrs. John Laing.** Soft pink, of beautiful form; exceedingly fragrant and remarkably free-flowering. Always does well and stands very close to the top among fine Roses.
- Paul Neyron.** Dark rose, of enormous size; perhaps the largest of all.
- Prince Camille de Rohan.** Deep velvety crimson-maroon, shaded scarlet; a magnificent dark Rose.
- Rodocanachi.** Beautiful transparent rose color, shaded pink; large, full and fragrant.
- Ulrich Brunner.** Bright cherry-red; flowers large and full; a good, strong grower and always does well.

Price: Strong 2-year-old plants, 30 cts. each; \$3.00 per doz.; \$20.00 per 100. Set of 12 sorts for \$3.00.

Hardy Climbing, Rambler and Trailing Roses.

- Baltimore Belle.** Blush-white; in clusters.
- Climbing Clothilde Soupert.** White, with rosy centre.
- Crimson Rambler.** The well-known climber.
- Dorothy Perkins.** A charming pink Rambler.
- Philadelphia Rambler.** A dark form of the crimson Rambler.

- Prairie Queen.** Deep rose.
- Sweet Brier.** The true Eglantine; fragrant foliage.
- Trier.** A desirable Rambler; blush, changing to white.
- White Rambler.** Small white; in clusters.
- Wichuriana (Memorial Rose).** Single white.

Price: Strong 2-year-old plants, 30 cts. each; \$3.00 per doz. Set of 10 sorts for \$2.50.

Select List of Hardy Climbing Plants.

- Actinidia Arguta.** A desirable climber; dark green shining foliage and white flowers. 50 cts. each; \$5.00 per doz.
- Akebia Quinata.** A quick grower, with bunches of small violet-brown flowers. 25 cts. each; \$2.50 per doz.
- Ampelopsis Quinquifolia (Virginia Creeper).** 25 cts. each; \$2.50 per doz.
- Tricolor.** Beautifully variegated leaves; green, pink and white. 25 cts. each; \$2.50 per doz.
- Veitchii (Boston Ivy).** The best climber to cling to walls, trees, etc. Strong plants, 15 cts. each; \$1.50 per doz.; \$10.00 per 100. Extra strong plants, 25 cts. each; \$2.50 per doz.; \$18.00 per 100.
- Apios Tuberosa.** A neat vine, like a miniature Wistaria. 5 cts. each; 50 cts. per doz.
- Aristolochia Sippo (Dutchman's Pipe).** A strong grower, with large leaves and pipe-like flowers. 50 cts. each; \$5.00 per doz.
- Bignonia Grandiflora (Trumpet Vine).** Large, orange-red flowers. 50 cts. each; \$5.00 per doz.
- Radicans.** Dark red, very free-flowering. 25 cts. each; \$2.50 per doz.
- Celastrus Scandens (Bitter Sweet).** 25 cts. each; \$2.50 per doz.
- Cinnamon Vine.** 5 cts. each; 50 cts. per doz.
- Clematis Coccinea.** Bell-shaped, coral-red flowers. 25 cts. each; \$2.50 per doz.
- Crispa.** Lavender-blue, with white centre; bell-shaped flowers. 25 cts. each; \$2.50 per doz.
- Flammula (Fragrant Virgin's Bower).** An old favorite fragrant white variety. 15 cts. each; \$1.50 per doz.
- Montana Grandiflora.** A beautiful spring-flowering variety; pure white flowers, 2 inches across. 50 cts. each; \$5.00 per doz.
- Paniculata (Japanese Virgin's Bower).** One of the finest climbers; clouds of small, fragrant flowers in August. Strong plants, 15 cts. each; \$1.50 per doz.; \$10.00 per 100. Extra strong plants, 25 cts. each; \$2.50 per doz.; \$15.00 per 100.

- Clematis Virginiana (Virgin's Bower).** A strong grower, with fine white flowers in August. 25 cts. each; \$2.50 per doz.
- Large-flowering sorts.** We can supply fine, strong roots of the following choice varieties:
- Anderson Henryi.** Creamy-white, large.
- Boskoop Seedling.** Extra large, lavender.
- Duchess of Edinburgh.** Double pure white.
- Jackmani.** The popular rich purple variety.
- Mme. Baron Veillard.** Light rose, with lilac shading.
- Ville de Lyon.** The nearest approach to a red.
- Any of the Large-flowering Clematis, 40 cts. each; \$4.00 per doz.
- Honeysuckle Chinese Evergreen (Woodbine).** Red, yellow and white.
- Halliana.** White, turning yellow.
- Heckrothi.** Deep red, with yellow throat.
- Variegated.** Foliage mottled yellow and green.
- Any of the above, 25 cts. each; \$2.50 per doz.; \$12.00 per 100.
- Ivy, English.** Invaluable for covering walls; also for covering graves. 25 cts. each; \$2.50 per doz.; \$15.00 per 100.
- Jasmine Nudiflorum.** Yellow. 25 cts. each; \$2.50 per doz.
- Officinale.** Pure white. 25 cts. each; \$2.50 per doz.
- Lathyrus Latifolius (Everlasting Pea).** Deep rosy-red. 25 cts. each; \$2.50 per doz.
- Latifolius albus.** White. 25 cts. each; \$2.50 per doz.
- Latifolius, White Pearl.** A magnificent large-flowering pure white. Extra fine in every way. 75 cts. each.
- Moonflower (Ipomœa pandurata).** The hardy variety; a strong grower. Flowers white, with pinkish-purple throat. 10 cts. each; \$1.00 per doz.
- Polygonum Multiflorum.** A desirable climber, with bright green heart-shaped leaves and foamy-white flowers in September and October. 25 cts. each; \$2.50 per doz.
- Schizopragma Hydrangeoides (Climbing Hydrangea).** Strong plants, \$1.00 each.
- Wistaria Sinensis.** Blue. 50 cts. each.
- Sinensis Alba.** White. 50 cts. each.

CHOICE HARDY SHRUBS.

For full Descriptive List and Cultural Notes see pages 217 to 225 of our Garden Book for 1909.

All Hardy Shrubs (except where noted) 25 cts. each; \$2.50 per doz.

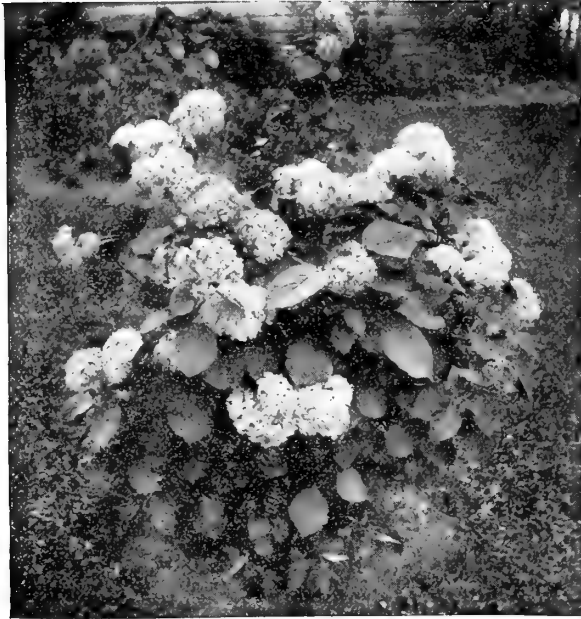

HYDRANGÆA ARBORESCENS GRANDIFLORA FORMA NOVA.

Abelia Chinensis Grandiflora. A choice dwarf shrub, with white-tinted lilac, heather-like flowers all summer.

Althea (Rose of Sharon). Valuable on account of their late blooming, August to October. We offer the following choice sorts.

- **Alba plena.** Double white, crimson centre.
- **Atropurpurea plena.** Double purple.
- **Boule de Feu.** Double red.
- **Cœrulea plena.** Double blue.
- **Duchesse de Brabant.** Double dark red.
- **Folia Variegata.** Leaves variegated.
- **Grandiflora superba.** Double delicate blush with carmine centre.
- **Jeanne d'Arc.** Double white.
- **Totus Albus.** Fine single pure white.
- **Violacea.** Double rosy-lilac.

Amorpha Fruiticosa (False Indigo). Spikes of indigo flowers; June.

Andromeda Mariana (Lily of the Valley Shrub). Waxy white, bell-shaped blossoms; June.

— **Japonica.** Racemes of white blossoms. \$1.00 each.

Aralia Pentaphylla. A pretty Japanese shrub.

— **Spinosa (Hercules Club, Angelica Tree, or Devil's Walking-stick).** Panicles of white flowers in August. 50 cts. each.

Azalea Anthony Koster. Intense golden orange-yellow flowers of exceptionally large size. 75 cts. each; \$7.50 per doz.

— **Hinodegirl.** Small, but very bright, fiery-red flowers. \$1.00 each.

— **J. C. Van Tol.** This is the best of the red-flowering forms of A. Mollis. 75 cts. each; \$7.50 per doz.

— **Yodogama.** Semi-double, lavender-pink flowers. \$1.00 each.

— **Mollis.** Yellow, orange, carmine, etc.; May. 75 cts. each; \$7.50 per doz.

— **Pontica, or Hardy Ghent.** A large range of colors. 75 cts. each; \$7.50 per doz.

— **Amœna.** Rosy-crimson. Bushy plants, 12 to 15 inches high, 60 cts. each; \$6.00 per doz. 15 to 18 inches high, \$1.00 each; \$10.00 per doz. 18 to 24 inches high, \$1.25 each; \$12.00 per doz.

Baccharis Halimifolia (Groundsell Tree).

Berberis Thunbergii. Small foliage, assuming the most varied and beautiful tints of coloring in the autumn.

Berberis Vulgaris purpurea (Purple Barberry). Violet-colored foliage and fruit.

Buddleia Variabilis. Racemes of rosy-lilac flowers, with an orange spot in the centre.

Calycanthus Floridus (Sweet or Strawberry Shrub). Chocolate-colored strawberry-scented flowers.

Caragana Arborescens (Pea Tree). Pea-shaped flowers in May.

Cercis Canadensis (Judas Tree, or Red Bud). Branches are covered with a mass of small pink flowers early in the spring. 50 cts. each.

Chionanthus Virginica (White Fringe). Flowers resemble bunches of white silken fringe.

Clethra alnifolia (White Alder, or Sweet Pepper Bush). Spikes of pure white fragrant flowers; July and August.

Cornus Florida (White-flowering Dogwood). 50 cts. each.

— **Rubra (Red-flowering Dogwood).** \$1.00 each.

— **Sanguinea (Red-twigg'd Dogwood).**

— **Flascula (Cornelian Cherry).**

— **Sericea.**

Colutea Arborescens (Bladder Senna). Yellow, pea-shaped blossoms; June.

Corchorus, or Kerria Japonica fl. pl. (Globe Flower) Double yellow flowers; June to October.

Cratægus Oxyacantha fl. pl. (Double-flowering Hawthorn). We offer both double red and white. 50 cts. each.

Cytisus Laburnum (Golden Chain, or Golden Rain). Racemes of yellow flowers in early summer.

Daphne Cneorum (Garland Flower). Bright pink, sweet-scented flowers in May. 50 cts. each.

Desmodium Penduliflorum. Sprays of bright rose flowers; Sept.

— **Japonicum.** An elegant white-flowering variety. 50c. each.

Deutzia Candidissima plena. Double white.

— **Crenata rosea plena.** Double white, tinged pink.

— **Gracilis.** Pure white flowers in early summer.

— **Campanulata.** A new white sort.

— **Rosea.** Suffused with delicate pink.

— **Lemoinei.** Cone-shaped heads of purest white.

— **Pride of Rochester.** Double pure white.

— **Scabra.** Large white, tinged pink.

Elaeagnus Longipes. The orange-colored fruit is very attractive.

Euonymus Europæus (Burning Bush).

Exochorda Grandiflora (Pearl Brush). White flowers in early spring.

Forsythia Suspensa (Weeping Golden Bell). Golden-yellow bells in early spring.

— **Viridissima.** Strong, erect habit; flowers yellow.

Halesia Tetraptera (Silver Bell, or Snowdrop Tree).

Hydrangea Arborescens Grandiflora Forma Nova (Snowball Hydrangea). A beautiful new hardy shrub. 50 cts. each; \$5.00 per doz.

— **Paniculata Grandiflora.** The most popular shrub in cultivation, flowers borne in dense pyramidal panicles, white when they first open, but gradually change to rose color. Fine bush plants, 25 cts. each; \$2.50 per doz.; \$18.00 per 100. Extra " " 50 " " 5.00 " " 30.00 " "

Standard or tree-shaped plants, which will make beautiful specimens for the lawn or garden, 50 cts. each; \$5.00 per doz.

Itea Virginica. Pure white flowers during June.

Kalmia Latifolia (Mountain Laurel, or Calico Bush). Strong cultivated plants, 75 cts. each; \$7.50 per doz.; \$60.00 per 100.

Lespedeza Bicolor (Bush Clover). Pea-shaped pink and white blossoms.

Ligustrum Iboata Regelianum. A Japanese Privet, with dark green foliage and racemes of fragrant white flowers.

Lonicera (Bush Honeysuckles).

— **Ledebouri.** Red flowers in May.

— **Morrowi.** White flowers; bright red fruit in the autumn.

— **Tartarica (Tartarian Honeysuckle).** Pink flowers.

— **Tartarica Alba.** Creamy white.

— **Grandiflora rosea.** Bright red flowers, striped with white.

- Philadelphus, Boule d'Argent** (*Silver Ball Mock Orange*). Double white flowers.
- **Coronarius** (*Garland Mock Orange*).
 - **Coronarius fl. pl.** Double-flowering.
 - **Coronarius aurea** (*Golden-leaved Mock Orange*).
 - **Grandiflorus**. A large-flowered sort.
 - **Manteau d'Hermine**. Creamy-white double flowers.
 - **Purpurea maculatus**. New; white with a rosy-crimson spot at base of each petal. 50 cts each.
 - **Rosæflorus plenus**. Full double-white.
- Potentilla Fruticosa** (*Shrubby Cinquefoil*). Golden-yellow flowers throughout the summer.
- Prunus Japonica fl. pl.** (*Double-flowering Almond*). We can supply both white and pink. 35 cts. each.
- Pyrus Japonicus** (*Japan Quince*). Dazzling scarlet.
- Rhodotypos Kerrioides** (*White Kerria*).
- Rhus Cotinus** (*Purple Fringe, or Smoke Tree*).
- Salisburia adiantifolia** (*Maiden-hair Tree, or Ginkgo*). Beautiful fern-like foliage.
- Spiræa Anthony Waterer**. Bright crimson.
- **Billardii**. Pink-flowered.
 - **Alba**. A white-flowered form.
 - **Callosa alba**. White flowers.
 - **Douglassi**. Rose-colored flowers.
 - **Lindleyana**. Large panicles of white in July.
 - **Margaritæ**. Soft pink flowers.
 - **Opulifolia aurea** (*Virginian Guelder Rose*). Golden-tinted foliage and large white flowers.
 - **Prunifolia fl. pl.** (*Bridal Wreath*). Double white.
 - **Reevesii fl. pl.** Double white.
 - **Thunbergii**. White flowers in spring.
 - **Van Houttei**. A fountain of white bloom.
- Staphylea Colchica** (*Bladder-nut*). Flowers white and fragrant. 35 cts. each.
- Lilac, Common** (*Syringa Vulgaris*). The common purple Lilac.
- **Common White** (*S. vulgaris alba*). Flowers pure white.
 - **Charles X.** Reddish-purple. 50 cts. each.
 - **Japonica**. A Japanese tree variety with creamy white flowers. 50 cts. each.
 - **Josikæa** (*Hungarian Lilac*). Flowers purple.
 - **Leon Simon**. Double blush-crimson. 50 cts. each.
 - **Mme. Casimir Perier**. The finest double white Lilac. 50 cts. each.
 - **Marie Le Gray**. Creamy white. 50 cts. each.
 - **Michael Buchner**. Double lilac. 50 cts. each.
 - **Souvenir de Louis Spæth**. Very large flowers of a deep purplish-red in immense compact trusses. 50 cts. each.
 - **Virginite**. Double soft rose. 50 cts. each.
- Symphoricarpus Racemosus fructo alba** (*Snowberry*).
- **Vulgaris** (*Red-fruited or Indian Currant*).
- Tamarix Africana** (*Tamarisk*). Feathery foliage and small, delicate pink flowers.
- **Hispidæ Æstivalis** (*New*). Feathery, soft pink sprays in July and August. 35 cts. each; \$3.50 per doz.
 - **Indica** (*East Indian Tamarisk*).

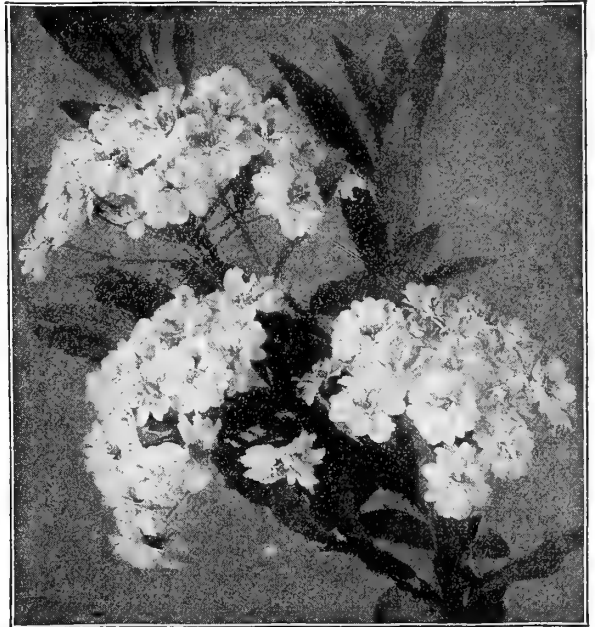

SPIRÆA REEVESII FL. PL.

- **Vitex Agnus Castus** (*Chaste Tree*). Lilac-colored flowers.
 - **Viburnum Opulus** (*High Bush Cranberry*). White flowers, followed in autumn by scarlet berries.
 - **Opulus Sterilis** (*Snowball, or Guelder Rose*). The popular white Snowball.
 - **Lantana** (*Wayfaring Tree*). A tall-growing Shrub with large foliage, silvery underneath, and large clusters of white flowers in May, succeeded by bright red berries, changing to black. 50 cts. each.
 - **Plicatum** (*Japan Snowball*). A decided improvement on the old Snowball. 50 cts. each.
 - **Tomentosum**. Pure white, flat flowers, borne along the branches. 50 cts. each.
- Weigelia Amabilis**. A beautiful pink.
- **Coccinea**. Rosy crimson.
 - **Candida**. Fine pure white.
 - **Rosea**. Soft rosy-carmine.
 - **Rosea Nana Variegata**. One of the finest variegated-leaved Shrubs.
 - **Eva Rathke**. Rich ruby-carmine.
 - **Xanthoceras Sorbifolia**. Racemes of pure white flowers with copper-colored streak at base of petals.
 - **Xanthorrhiza Apiifolia**. Handsome foliage, which turns to a bright yellow in autumn.

ALL HARDY SHRUBS (except where noted) 25 cts. each; \$2.50 per doz.

HEDGE PLANTS.

ALTHEA (Rose of Sharon).

Strong, bushy plants, 30 to 36 inches high, in choice variety. \$2.00 per doz.; \$12.00 per 100.

BERBERIS THUNBERGII.

Strong 3-year-old plants, 18 to 24 inches high. \$2.00 per doz.; \$15.00 per 100; \$120.00 per 1000.

BOXWOOD EDGING.

Nice bushy plants, 4 to 6 inches high. \$1.00 per doz.; \$6.00 per 100; \$50.00 per 1000.

CALIFORNIA PRIVET.

		Per 100.	Per 1,000
Strong	1-year-old, 18 to 24 inches high	\$3.00	\$25.00
"	2 " " 24 to 30 "	4.00	35.00
"	2 " " 30 to 36 "	5.00	45.00
Selected	2 " " 36 to 42 "	8.00	70.00

OSAGE ORANGE.

Strong 2-year-old plants, \$1.00 per 100; \$7.50 per 1000.

ROSA RUGOSA (Ramanas Rose).

We can furnish these either in the red or white-flowering strong 2-year-old plants. \$2.50 per doz.; \$20.00 per 100.

SELECT SMALL FRUITS.

For Fall Planting. Ready about Oct. 20th.

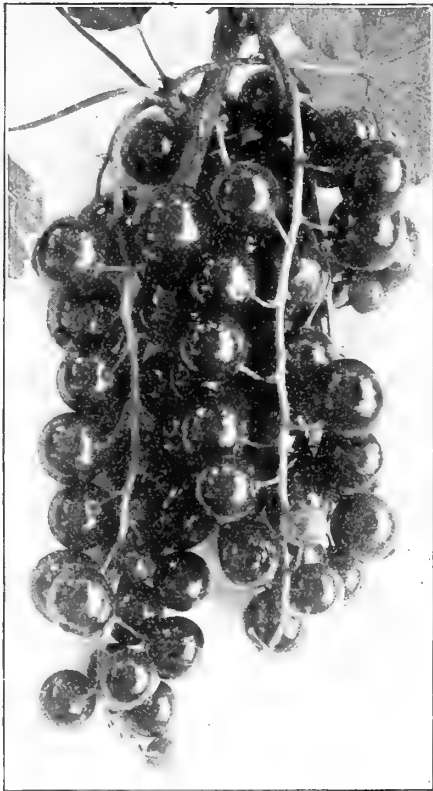

PERFECTION RED CURRANT.

Fall is a good time to plant hardy Grapes, Blackberries, Raspberries, Currants, etc.; the plants being at that time dormant are less liable to injury in transplanting than when planted in spring. After planting, cover the roots with 2 or 3 inches of litter or manure. While the list offered on this and the next page is short, yet it is very select, only the very finest sorts being offered. We think this is better than offering a long list, many of which would be of doubtful value. *We do not handle fruit trees, such as apples, pears, cherries, etc.*

BLACKBERRIES.

Blackberries respond generously to good treatment. They prefer a deep soil, inclining to sand, but will grow and fruit almost anywhere.

Rathbun, | **Erie,** | **Kittatinny,**
Wilson Junior, | **Early Harvest,** | **Snyder.**

Price: Any of the above, 50 cts. per doz.; \$2.50 per 100; \$15.00 per 1000.

If wanted by mail, add 10 cts. per doz. for postage.

CURRANTS.

Currants do well in partial shade, but require rich soil and good culture. The following are the very best sorts, and are supplied in strong 2-year-old plants:

Cherry. Deep red.

Fay's Prolific. Color rich red; the leading variety for home use.

Lee's Black Prolific. The favorite sort for preserving.

Perfection. A new red variety which promises to eclipse all other sorts, combining size, color, high quality and productiveness in a superlative degree; has been awarded two gold medals. 15 cts. each; \$1.50 per doz.; \$12.00 per 100.

White Grape. Best white variety.

Wildor. A new red variety; fruit large, of fine flavor and a great yielder.

Price: Any of the above (except where noted), 10 cts. each; 75 cts. per doz.; \$6.00 per 100. *If wanted by mail, add 15 cts. per doz. for postage.*

GOOSEBERRIES.

We offer strong 2-year-old plants of the following desirable varieties:

Red Jacket. A wonderful cropper, with bright, clean, healthy foliage. 15 cts. each; \$1.50 per doz.; \$10.00 per 100.

The Pearl. Large size, color pale green and of excellent quality, either as a dessert fruit or for cooking. 15 cts. each; \$1.50 per doz.; \$10.00 per 100.

If wanted by mail, add 20 cts. per doz. for postage.

FOREIGN GRAPE VINES.

Owing to the scarcity of these in American-grown stock, we have made arrangements with one of the leading English growers for a supply. While the prices at first glance may appear high, the strength, size and quality of this stock is so much superior that comparison cannot be made with the light canes usually sent out. We offer but 12 varieties, but will be pleased to furnish a list of other sorts that can be supplied. Orders booked previous to November 25th can be executed any time after January 1st. Orders received after that date will be filled about March 15th.

Black Varieties.

Alnwick Seedling. An excellent late variety.

Black Alicante. Bunches medium, berries very large.

Black Hamburgh. The most useful and popular grape.

Gros Colman. A very handsome late grape.

Lady Downe's Seedling. One of the best late grapes.

Black Muscat, or Muscat Hamburgh. An excellent and richly-flavored grape.

Madresfield Court. Berries very large; of rich flavor.

White Varieties.

Buckland Sweetwater. A large, handsome berry and bunch; a good bearer and excellent.

Duke of Buccleuch. A large-berried, fine, early variety.

Foster's Seedling. A fine grape; sweet flavor.

Frontignan White. Fine white grape, abundant bearer.

Muscat of Alexandria. Flesh firm and rich, berries large; a superb variety; requires heat to ripen.

Price: Strong planting canes, \$2.50 each; \$30.00 per doz.

Strong fruiting canes, \$3.50 each; \$40.00 per doz.

For Hardy Grape Vines see next page.



GOOSEBERRY.

SELECT HARDY GRAPES.

Agawam (*Rodger's No. 15*). Large, dark red; sweet.
Brighton. Resembles Catawba, with richness of the Delaware.
Campbell's Early. An improved Concord; very early.
Catawba. Red, sweet and rich, with pleasant musky flavor.
Concord. The most popular black grape; succeeds everywhere.
Delaware. Light red, sweet, sprightly; fine flavor.
Lindley (*Rodger's No. 9*). Large, black; good quality.
Moore's Diamond. Delicate greenish-white with rich yellow tinge. Prolific, early and hardy; of fine quality.
Moore's Early. Large, black; good quality.
Niagara. Berries large, light greenish-white, slightly ambered.
Pocklington. Bunch and berry large, golden-yellow.
Worden. Black, hardy, healthy; of fine quality.
Price: Strong selected two-year-old vines, 25 cts. each; \$2.50 per doz.; \$15.00 per 100.

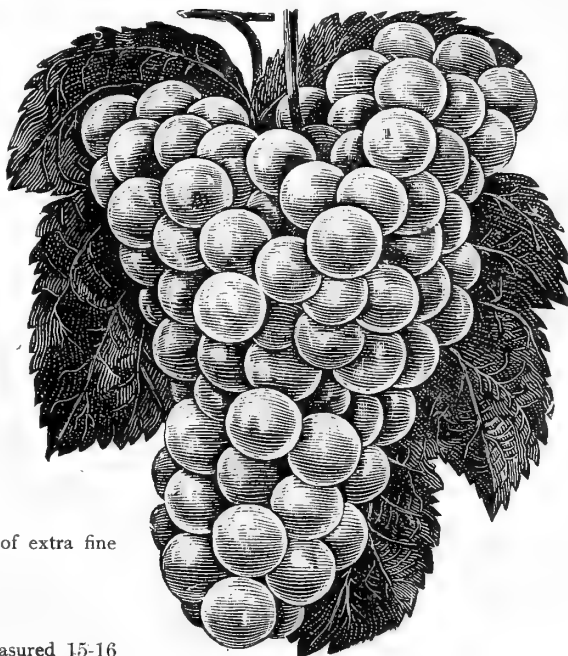

HARDY GRAPE.

RASPBERRIES.

Raspberries will succeed in any soil that can grow good corn, but respond quickly to liberal treatment; for best results the old wood should be cut out just as soon as the crop has been gathered; this will give more vigor to the young canes for next year's bearing.
Columbian. Large, dark red, strong, robust and productive.
Cumberland. A new black cap of exceptionally large size; of extra fine quality.
Cuthbert. Large, deep, rich crimson.
Golden Queen. Large, golden-yellow.
Gregg. Large black.
Kansas. One of the new black caps. Has produced fruit that measured 15-16 of an inch in diameter.
Marlboro'. Bright crimson.
Ruby. An extra large red, of fine flavor and very early.
Souhegan, or Tyler. Jet black, of medium size.

Price: Any of the above, 50 cts. per doz., \$3.00 per 100; \$20.00 per 1000.
If wanted by mail, add 10 cts per doz. for postage.

POT-GROWN AND LAYER STRAWBERRY PLANTS.

Pot-grown plants set out early this Autumn will produce a good crop of berries next June.

	Potgrown Plants.		Layer Plants.	
	Doz.	100.	Doz.	100.
Abington . Midseason, perfect	75	\$5.00	40	\$2.00
Auto . Midseason, perfect	60	4.00	25	1.50
Brandywine . Late, perfect	50	3.50	25	1.00
Bubach . Midseason, pistillate	50	3.50	25	1.00
Climax . Early, perfect	60	4.00	25	1.00
Clyde . Early to midsummer, perfect	50	3.50	25	1.00
Commonwealth . Late, perfect	60	4.00	25	1.00
Excelsior . Extra early, perfect	50	3.50	25	1.00
Fairfield . Extra early, perfect	60	4.00	25	1.00
Gandy's Prize . Late, perfect	50	3.50	25	1.00
Glen Mary . Midseason to late, perfect	50	3.50	25	1.00
Goldsborough . Early, perfect	75	5.00	40	2.00
Heritage . Midseason to late, perfect	\$1.00	6.00	40	2.00
Marshall . Early, perfect	50	\$3.50	25	\$1.00
Michel's Early . Early, perfect	50	3.50	25	1.00
New Home . Late, perfect	60	4.00	25	1.00
New York . Midseason, perfect	50	3.50	25	1.00
Nick Ohmer . Midseason, perfect	50	3.50	25	1.00
President . Late, pistillate	60	4.00	25	1.00
Sample . Midseason to late, pistillate	50	3.50	25	1.00
Sharpless . Midseason, perfect	50	3.50	25	1.00
St. Louis . Early, perfect	75	5.00	40	2.00
The Cardinal . Late, pistillate	75	5.00	40	2.00
The Fendall . Midsummer to late, pistillate	\$1.00	6.00	40	2.00
Wm. Belt . Midseason, perfect	50	3.50	25	1.00

VEGETABLE PLANTS AND ROOTS.

Asparagus. We grow roots of these in immense quantities, and can furnish the following varieties in two-year-old roots about the end of October in extra fine condition. Full details of culture are given in a circular which we send on application.

Argenteuil (<i>Violet</i>). The popular French variety	75 cts. per 100; \$6.00 per 1000
Dreer's Eclipse . A large and very fine variety	75 " " 6.00 "
Conover's Colossal	75 " " 5.00 "
Columbian Mammoth White	75 " " 5.00 "
Palmetto	75 " " 5.00 "
Barr's Mammoth	75 " " 5.00 "

Horseradish Sets, New Bohemian. 20 cts. per doz.; 75 cts. per 100.

Rhubarb Roots, Victoria, Strong roots, 10 cts. each; \$1.00 per doz.; \$6.00 per 100.

Sage, Holt's Mammoth. A large-leaved variety; never runs to seed. 10 cts. each; \$1.00 per doz.

Lavender Plants. 15 cts. each; \$1.50 per doz.

Tarragon (*Estragon*). For flavoring. 20 cts. each; \$2.00 per doz.

Mint Roots. 10 cts each; \$1.00 per doz.; \$6.00 per 100.

Chives. For flavoring. 10 cts. per clump; \$1.00 per doz.

Hop Vine Roots. 5 cts. each; 50 cts. per doz.; \$4.00 per 100.

Tansy. 10 cts. each; \$1.00 per doz.

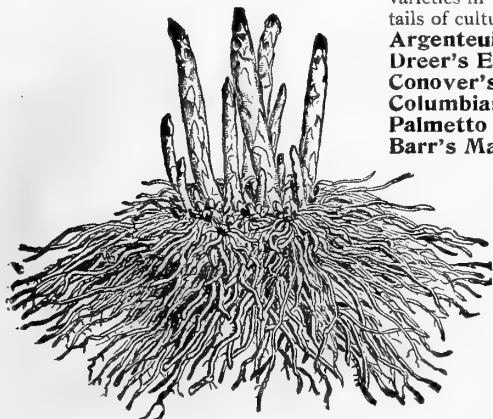

ASPARAGUS ROOT.

Dreer's Reliable Flower Seeds

On the following seven pages we give a most complete list of Seeds of the **Best Hardy Perennials** which are now so deservedly popular. Sown this fall in a cold frame or protected corner of the garden, you can have, with little trouble, an abundant supply of Columbines, Canterbury Bells, Foxgloves, Gaillardias, Hollyhocks, Larkspurs, Forget-me-nots, Daisies, Sweet Williams, etc., etc., for flowering in 1910. The list also includes a choice selection of other Flower Seeds for autumn sowing, such as Cyclamens, Pansies, Primulas, etc.

For full descriptions, illustrations and cultural notes see our Garden Book for 1909.



AQUILEGIA, OR COLUMBINE.

- | | |
|--|----------------|
| ACANTHUS. Mollis Latifolius (<i>Bear's Breech</i>). Handsome and interesting hardy plants, with fine foliage and curious flowers in August and September. Grows from 2 to 4 feet high, according to soil and location. Valuable alike for planting as single specimens, in groups or in border..... | PER PKT.
10 |
| ACHILLEA. Ptarmica Fl. Pl. " <i>The Pearl</i> ." (<i>Double White Yarrow</i>) One of the best hardy white perennials; grows about 2 feet high, and from spring till frost is covered with heads of purest white double flowers. Per 1/2 oz., 50 cts..... | 15 |
| ACONITUM. Napellus (<i>Monk's Hood, or Wolfsbane</i>). A hardy perennial, producing long spikes of curiously-shaped blue and white flowers. Well adapted for planting among shrubbery or in shady corners of the garden; 3 to 5 feet. Per 1/4 oz., 25 cts. | 5 |
| ADONIS. Vernalis (<i>Ox-Eye</i>). A hardy perennial, bearing large bright yellow flowers in early spring; 1 foot. Per 1/4 oz., 20 cts..... | 10 |
| AGROSTEMMA. Coronaria (<i>Mullein Pink</i>). An attractive free-flowering hardy perennial of easy culture, producing bright crimson flowers on long, slender stems; foliage silvery-gray. Per 1/4 oz., 15 cts..... | 5 |
| ALYSSUM. saxatile Compactum (<i>Basket of Gold</i>). Showy, hardy perennial, golden-yellow flowers; excellent for rock work or border; 1 foot. Per 1/4 oz., 25 cts..... | 5 |
| ANTHEMIS. Kelwayi (<i>Hardy Marguerite</i>). A most satisfactory hardy perennial, bearing all summer daisy-like golden-yellow blossoms; 2 feet. Per 1/4 oz., 25 cts..... | 10 |
| ANEMONE. Coronaria. Mixed Colors (<i>Opoffy Anemone, or Windflower</i>). A beautiful selection of the above, comprising semi-double and double flowers in a wonderful array of colors..... | 15 |
| ANTHRINUM. Snapdragon . The Snapdragons are undoubtedly one of the best cut flowers, and are now largely grown for spring flowers. Seed should be sown from mid-summer till early fall | 5 |
| Giant . White, Scarlet, Garnet, Yellow, Pink, Striped and Mixed, each..... | 10 |
| Double-flowering . N. w. | 15 |
| Queen of the North . Large white flowers. Per 1/4 oz., 25 cts. | 10 |
| Half-Dwarf, Mixed . Large variety of colors; 18 inches. Per 1/4 oz., 20 cts..... | 5 |
| Tall, Mixed . Extra fine selection. Per 1/4 oz., 25 cts..... | 5 |
| AQUILEGIA, or COLUMBINE . For planting in permanent borders or naturalizing along the edge of woods or shrubbery this old-fashioned favorite is one of the best of all hardy plants. | |
| Californica Hybrida . Exquisite flowers, mostly in yellow and orange shades, all with long spurs. Per 1/4 oz., 60 cts..... | 10 |
| Canadensis . Scarlet and yellow, one of the brightest. Per 1/4 oz., 25 cts..... | 5 |

- | | |
|--|---------------|
| Chrysanth (<i>Golden Spurred</i>). Bright golden-yellow; 3 feet. Per 1/4 oz., 40 cts..... | PER PKT.
5 |
| Alba (<i>White Spurred</i>). A beautiful pure white. Per 1/4 oz., 50 cts..... | 10 |
| Cerulea (<i>Rocky Mountain Columbine</i>). Violet-blue and white; 2 feet. Per 1/2 oz., 50 cts..... | 10 |
| Cerulea Hybrida . Beautiful hybrids of the preceding, bearing large, long-spurred flowers in a very great variety of charming colors. Per 1/4 oz., 50 cts..... | 10 |
| Flabellata Nana Alba . Pure white, dwarf and compact, blue-green foliage. Per 1/4 oz., 40 cts..... | 10 |
| Glandulosa . Lovely shade of light blue and pure white..... | 15 |
| Haylogensis Delicatissima . A new, delicate satin rose-colored type of the Rocky Mountain Columbine..... | 10 |
| Helena . This new hybrid is of strong, robust growth, bearing numerous flowers of a lovely shade of blue and pure white..... | 25 |
| Nivea Grandiflora . A beautiful, large, free-flowering pure white. Per 1/4 oz., 15 cts..... | 5 |
| Rose Queen . A lovely new rose-colored variety..... | 20 |
| Single , all colors mixed; 2 feet. Per oz., 30 cts..... | 5 |
| Double , all colors mixed. Per oz., 30 cts..... | 5 |
| ARABIS. Alpina (<i>Rock Cross</i>). Unequaled for rockeries or edgings; withstands the drought and is always neat. The spreading tufts are covered with a sheet of pure white flowers in early spring; 6 inches. Per 1/4 oz., 25 cts..... | 5 |
| ARMERIA. Formosa (<i>Sea Pink, Cushion Pink, or Thrift</i>). A very pretty edging plant, bearing large tufts of rosy-pink flowers; hardy perennial. Per 1/4 oz., 25 cts..... | 10 |
| ASTILBE. Davidii . A new hardy perennial, deep violet-rose flowers on stems 6 feet high..... | 50 |
| ASPARAGUS. Plumosus Nanus . This graceful climber has foliage finer than that of the most delicate fern, and will last for weeks after being cut. It is an excellent house plant, succeeding under almost any condition. 100 seeds, \$1.00..... | 25 |
| Sprengeri (<i>Emerald Feather</i>). One of the best plants to grow in suspended baskets, for greenhouse or for outdoors in the summer. 100 seeds, 50 cts..... | 10 |
| ASPERULA. Odorata (<i>Sweet Woodruff</i>). An old-fashioned favorite, grown for its fragrant leaves and stems; best grown in semi-shaded positions, where it can remain undisturbed; flowers white. Per 1/4 oz., 25 cts..... | 5 |
| ASTER. Perennial Mixed (<i>Star Worts, or Michaelmas Daisies</i>). Single-flowering, hardy herbaceous plants, thriving in any good garden soil. Per 1/4 oz., 50 cts..... | 10 |
| BAPTISIA. Australis (<i>False Indigo</i>). A beautiful hardy perennial herbaceous plant, producing pea-shaped flowers on spikes 6 inches long; bright blue; 2 1/2 feet. Per 1/4 oz., 15 cts..... | 5 |
| BELLIS (<i>English Daisy</i>). A favorite nearly hardy perennial plant, in bloom from early spring until well on in the summer. | |
| Giant Rose . The largest-flowering of all, color bright rose..... | 25 |
| The Bride . A fine new very double free-flowering pure white..... | 15 |
| Longfellow . Large double pink flowers..... | 10 |
| Snowball . A large and very double pure white Daisy..... | 10 |
| Giant Red . Beautiful and densely double red flowers..... | 10 |
| Double Mixed . All colors; of the finest quality. Per 1/4 oz., 40 cts..... | 10 |

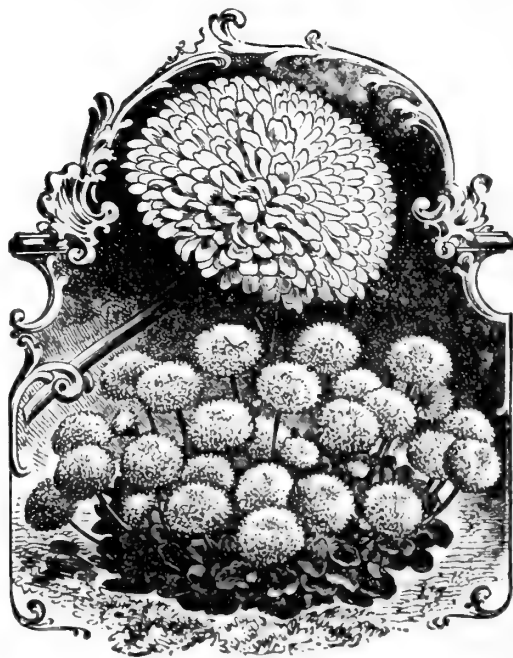

BELLIS PERENNIS—DOUBLE DAISY

	PER PKT.
BOCCONIA, Cordata (<i>Plume Poppy, or Tree Celandine</i>). Effective hardy perennial, for single specimens or groups on lawns. Foliage glaucous green, bears freely spikes 2 to 3 feet long of cream-colored flowers; 5 feet. Per ¼ oz., 15 cts.	5
BOLTONIA (<i>False Chamomile</i>). One of the showiest of our native hardy perennials, growing 4 to 6 feet high, with daisy-like flowers in countless thousands from July to September, very effective.	
Asteroides . White.....	10
Latisquama . Pink, tinged with lilac.....	10
BROWALLIA, Speciosa Major (<i>Amethyst</i>). A beautiful, brilliant ultramarine-blue, especially valuable as a pot plant for winter and early spring flowering.....	15
CALCEOLARIA . Our strains have been grown especially for us, and can be relied upon to produce flowers of the largest size and most brilliant coloring.	
Hybrida Grandiflora, Mixed . Beautiful, rich, self-colored flowers.....	25
— Tina . Tigered and spotted flowers; the very finest mixture of the most brilliant colors.....	35
— Fumila Compacta . Of dwarf, compact growth.....	35
CALIMERIS, Incisa (<i>Star Wort</i>). An attractive hardy perennial 12 to 18 inches high, bearing daisy-like pale lavender flowers, with yellow centres from July to September.....	15
CALLIRHOE, Involucrata (<i>Puppy Mallow</i>). A showy, trailing, hardy perennial, bearing continuously from early summer till fall large, bright crimson saucer-shaped flowers. Per ¼ oz., 25 cts.	5
CAMPANULA Carpatica (<i>Carpathian Hare-Bell</i>). Free-flowering, continuing in bloom the whole season; hardy perennial; 6 inches; color clear blue. Per ¼ oz., 25 cts.	5
Carpatica Alba . White-flowered form of above.....	5
Latifolia Macrantha . A handsome variety, bearing in May and June large purplish-blue flowers; 3 feet.....	15
Persicifolia Grandiflora (<i>Peach Bells</i>). Undoubtedly one of the finest of the hardy Bellflowers; grows 2 to 3 feet high, with large blue flowers. Per ¼ oz., 50 cts.	10
Persicifolia Grandiflora Alba . Pure white.....	10
Persicifolia Gigantea Moerheimi . A beautiful double white variety of this fine perennial. 3 pkts. for 50 cts.	20
Pyramidalis (<i>The Chimney Bellflower</i>). A beautiful, stately plant, either for garden or pot culture, blue salver-shaped flowers. Per ¼ oz., 25 cts.	5
Pyramidalis Alba . White.....	5
Rapunculoides . Of graceful habit, 3 feet high, and bearing in June showy blue, bell-shaped blossoms.....	10
Trachelium (<i>Coventry Bells</i>). A sturdy variety, 2 to 3 feet high, with large blue flowers in July and August.....	5
CANTERBURY BELLS (<i>Campanula Medium</i>).	
Calycanthema (<i>Cup and Saucer Canterbury Bells</i>). This is unquestionably the finest type of this old-fashioned and much prized garden plant. We offer it in separate colors as well as mixture, viz:	
— Rose . Delicate rosy-pink.....	10
— Blue . A fine, clear shade.....	10
— Striped . White, striped blue.....	10
— White . Pure white.....	10
— Finest Mixed . All colors of the Cup and Saucer type. Per ¼ oz., 40 cts.	5
A pkt. each of the four colors of Cup and Saucer Canterbury Bells.....	30
Single, Mixed . The old-fashioned sort with beautiful, large bell-shaped flowers. Per ¼ oz., 15 cts.	5
Double, Mixed . All the double medium varieties; 2½ feet. Per ¼ oz., 25 cts.	5
Imperialis (<i>Imperial Canterbury Bells</i>). A new type of fine habit and containing a number of new and unusual colors. 3 pkts. for 50 cts.	20



CUP AND SAUCER CANTERBURY BELLS.

	PER PKT.
CANDYTUFT (<i>Iberis</i>). Gibraltarica Hybrida . White flowers shading to lilac.....	10
Sempervirens . A profuse white-blooming hardy perennial, coming in flower early in the spring; much used for rockeries, etc. Per ¼ oz., 25 cts.	10
CARNATION . General favorites for their delicious fragrance and richness of color. They are indispensable both for greenhouse culture in winter and for the garden in summer.	
Fine Double, Mixed . The best for outdoor garden culture.....	10
Finest Double, Mixed . Saved from extra fine flowers.....	25
Chabaud's Everblooming . Raised by a famous French specialist. Blooms in five months after being sown, and continues to flower in the greatest profusion. Mixed colors.....	25
Marguerite . A quick-flowering type, fine double flowers. Mixed colors. Per ¼ oz., 40 cts.	5
Giant Marguerite . An improved strain of the above, with very large flowers. Mixed colors. Per ¼ oz., 50 cts.	10
CASS A. Marilandica (<i>American Senna</i>). A shrub-like hardy perennial, 3 to 4 feet high; pretty foliage and yellow pea-shaped blossoms.....	10
CENTROSEMA, Grandiflora (<i>Butterfly Pea</i>). A pretty, hardy climber; color rosy-red, feathered white.....	10
CERASTIUM, Tomentosum (<i>Snow in Summer</i>). A very pretty hardy dwarf, white-leaved edging plant; small white flowers.....	15
CHRYSANTHEMUM, Maximum, King Edward VII . The finest Moonpenny Daisy yet introduced; very large, pure white flowers and exceptionally free-flowering.....	15
Maximum "Triumph" (<i>Moonpenny Daisy</i>). Blossoms of purest white, with yellow centres and borne on long, strong stems, lasting a long time when cut; perfectly hardy. Per ¼ oz., 25 cts.	10
"Shasta" Daisy . Our stock of this comes direct from the originator, Mr. Luther Burbank, the famous California hybridizer, and contains some each of his latest improved types. 3 pkts. for 50 cts.	20
Shasta Daisy "Alaska" . This is the finest of all the Shasta Daisies; flowers of immense size.....	25
CINERARIA . Seed should be sown from May to September for succession. Our Prize strains are justly celebrated for all good qualities, being especially noted for size, coloring and texture.	
Dreer's Prize Dwarf	35
Dreer's Prize Tall	35
Matador . A new bright scarlet.....	35
Stellata (<i>Star Cineraria</i>). A charming variety, with large, spreading panicles of starry flowers of easy culture. The extreme grace and elegance of the plant and flowers make them wonderfully effective for the decoration of the house or conservatory, and especially so for church decoration; also useful for cutting.....	35
COREOPSIS, Lanceolata Grandiflora . This is one of the finest of hardy plants, with large, showy, bright yellow flowers, produced in the greatest abundance from June till frost. As a cut flower they stand near the head among hardy plants, having long stems and lasting in good condition a week or more. Per ¼ oz., 20 cts.	10
COWSLIP (<i>Primula Veris</i>). A beautiful hardy spring-flowering perennial; flowers of different colors, such as yellow, brown-edged yellow, etc.....	10
Invincible Giant . Extra large-flowering strain.....	25



CHRYSANTHEMUM "SHASTA DAISY."

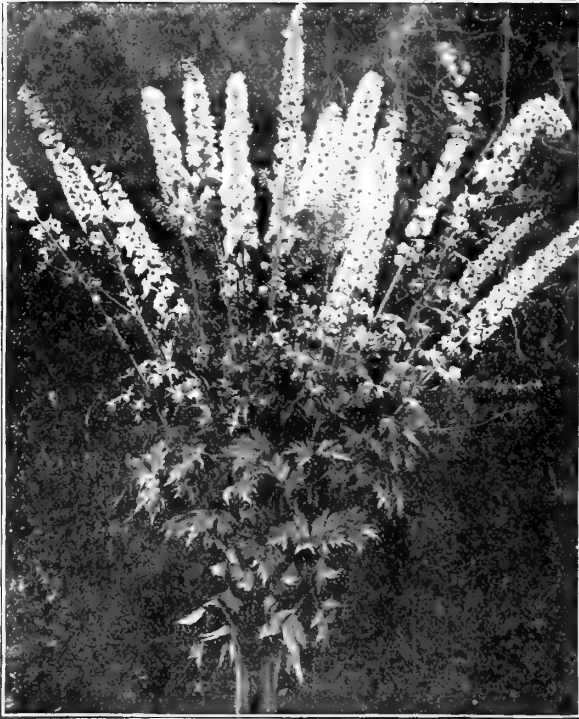

DELPHINIUM GOLD MEDAL HYBRIDS.

	PER PKT.
CYCLAMEN, Persicum. Choicest mixed; easier to grow than the Giants, but not so large. Per 100 seeds, 60 cts.....	15
Giant Pure White. Per 100 seeds, \$1.00.....	25
— White, with carmine eye. Per 100 seeds, \$1.00.....	25
— Dark Blood-red. Per 100 seeds, \$1.00.....	25
— Delicate Rose, with deep crimson eye. Per 100 seeds, \$1.00.....	25
— Finest Mixed. Saved from a superb collection. Per 100 seeds, \$1.00.....	25
Wonder of Wandsbek. A new giant-flowering variety, with flowers of various shades of rose suffused with salmon, which adds a brightness heretofore unknown in this splendid winter-blooming plant. 3 pkts. for \$1.00.....	35
Butterfly (Papilio). In this new type the edges of the flowers are beautifully fringed or waved. For house or conservatory decoration they are of surpassing beauty. Mixed colors.....	50
Double-flowering. A really double-flowering Cyclamen, coming quite true from seed; the flowers are produced with the same freedom and in the same beautiful colors as in the single-flowering sorts.....	35
DELPHINIUM or Hardy Perennial Larkspur. One of our most showy and useful hardy perennial plants, possessing almost every requisite for the adornment of the garden, producing splendid spikes of flowers in profusion throughout the summer.	
Burbank's Hybrids. A magnificent strain, clearly showing the results of painstaking care; splendid range of colors. 5 pkts., \$1.00.....	25
Belladonna. Exquisite turquoise-blue.....	25
Alfred Henderson. Oxford-blue, white eye.....	15
Duke of Connaught. Sky-blue, white centre.....	15
Geneva. Light blue.....	15
King of Delphiniums. Deep blue, large white eye.....	15
Mine, Violet Geslin. Blue, plum and lilac.....	15
Sir Geo. Newnes. Gentian-blue, plum and white.....	15
Thos. Baines. Sky-blue, veined rose; black eye.....	15
Gold Medal Hybrids. An extra fine strain. The plants are of strong, vigorous habit, with immense spikes, from 2 to 3 feet long, of large flowers, mostly in fine shades of light blue.....	15
Formosum. Spikes of rich blue flowers, with white centre. Per 1/4 oz., 25 cts.....	5
— Celestinum. Exquisite celestial-blue, with white eye. Per 1/4 oz., 50 cts.....	15
Elatum (Bee Larkspur). Rich blue of various shades, with black centres; grows 3 to 5 feet high, according to soil and location.....	10
— Celestinum. Sky-blue, with dark centre; very effective.....	15
Chinense. A distinct and neat variety, growing about 18 inches high, with fine feathery foliage, and producing freely panicles of large blossoms of bright gentian-blue. Per 1/4 oz., 20 cts.....	5
— Album. The white-flowered form. Per 1/4 oz., 20 cts.....	5
Nudicaule. Dwarf, compact growth, with spikes of bright scarlet flowers.....	10
Cashmerianum. A beautiful dark blue, blossoms in corymbs of 6 or more.....	15
Zulii. A lovely shade of sulphur-yellow.....	10
Grandiflorum Fl. Pl. Finest double mixed, in great variety of charming colors. Per 1/4 oz., 50 cts.....	15

DIANTHUS (Hardy Garden Pinks). These varieties are well adapted for beds and borders; delightful, refreshing, spicy odor; should be in every garden where cut flowers are wanted.	PER PKT.
Plumarius (Pheasant-eye Pink). Beautiful single flowers. Per 1/2 oz., 40 cts.....	5
— Fl. Pl. (Double Harvey Garden Pinks). Double and semi-double varieties in beautiful colors. Per 1/4 oz., 50 cts.....	10
Double Dwarf Erfurt. This new strain is of compact growth and early flowering. They possess the spicy clove fragrance of the old-fashioned pink, and have a much richer variety of coloring. 2 pkts., 25 cts.....	15
Semperforens (Everblooming Hardy Garden Pinks). Very beautiful, sweet-scented, double, semi-double and single flowers in great diversity of color.....	25
Latifolius Fl. Pl. (Hybrid Sweet William). A hybrid between the China Pink and Sweet William; the brilliant flowers are quite double, borne in large heads, blooming throughout the summer. Mixed colors.....	10
— Atrococcineus Fl. Pl. A brilliant crimson-scarlet variety that is very effective in any position, and one of the best perennials in the list. 2 pkts., 25 cts.....	15
DIGITALIS (Foxglove). Handsome and highly ornamental hardy plants of stately growth, succeeding under almost all conditions, and with but little attention will give a wealth of flowers during June and July. They are now used extensively, with good effect, for naturalizing in shrubberies, the edge of woods and other half-shaded places; 3 to 5 feet.	
Gloxiniaeflora. This is a fine strain of the ordinary Foxglove, <i>D. purpurea</i> , with handsome Gloxinia-like flowers on long spikes. We offer the following colors, also mixed:	
White. Per 1/4 oz., 25 cts.....	10
Rose. Per 1/4 oz., 25 cts.....	10
Purple. Per 1/4 oz., 25 cts.....	10
Lilac. Per 1/4 oz., 25 cts.....	10
A packet each of the above four colors, 30 cts.	
Finest Mixed. Contains all the finest spotted sorts. Per 1/4 oz., 15 cts.....	5
Maculata Superba. An extra choice strain of beautifully-spotted sorts. Per 1/4 oz., 25 cts.....	10
Grandiflora. Light yellow. Per 1/4 oz., 20 cts.....	5
Monstrosa (Mammoth Foxglove). Long spikes, surmounted by one enormous flower; very odd; all colors mixed. Per 1/4 oz., 30 cts.....	10
ECHINOPS, Sphærocephalus (Globe Thistle). A striking hardy perennial plant, easily raised from seed; grows 4 feet high, with globular heads of pale-blue flowers in July and August; excellent for the back of the hardy border.....	10
Ruthenicus. Steel-blue; fine for cutting.....	10
ERYNGIUM, Amethystinum (Sea Holly). Handsome ornamental hardy plants, growing 2 to 3 feet high, with finely-cut spiny foliage and beautiful thistle-like heads of amethystine-blue; fine for winter bouquets.....	10
EUPATORIUM (Thorough-wort). Strong-growing, hardy perennials, well suited for naturalizing. The sorts offered below deserve a place in every hardy border; they thrive in any kind of soil and in almost any position.	
Ageratoides. A very useful variety, growing 3 to 4 feet high, with dense heads of minute white flowers from August until October.....	10
Celestinum. One of the best blue perennials, 18 to 24 inches high, and bears from August till frost an abundance of clear, lavender-blue, flossy flowers; splendid for cutting.....	10
GAILLARDIA (Blanket Flower). These are among the showiest and most effective hardy perennial plants, and should find a place in every hardy border. They begin flowering in June, continuing a mass of bloom until frost.	
Kermesina Splendens. Centre rich crimson, narrow canary-yellow border.....	15
Sulphurea Oculata. Pale sulphur, bright maroon eye.....	15
Grandiflora Compacta. A compact variety, bearing its long-stemmed, rich and varied flowers well above the foliage.....	15
— Superba. Our own saving. Splendid mixed varieties. Per 1/4 oz., 20 cts.....	10



GIANT CYCLAMEN.

- GEUM. Atrosanguineum Fl. Pl.** Beautiful hardy perennial, bearing profusely large, showy crimson flowers all through the summer. PER PKT. 10
- GNAPHALIUM. Leontopodium (Edelweiss).** Pure white. Principally found on the Alps of Switzerland. 10
- GOLDEN ROD (Solidago Canadensis).** The well-known golden-yellow favorite hardy perennial; 2 to 5 feet. Per ¼ oz., 15 cts. 15
- GREVILLEA. Robusta (Silk Oak).** A very beautiful and graceful decorative plant, with fern-like foliage; excellent for table decoration; easily raised from seeds, producing good-sized plants in a short time. Per ¼ oz., 25 cts. 5
- GYPHOPHILA. Paniculata (Baby's Breath).** White flowers, fine for bouquets; one of the favorite hardy perennials; 2 feet. Per ¼ oz., 15 cts. 10
- Acutifolia.** A strong-growing, hardy perennial sort, 3 to 4 feet high, with large panicles of small white flowers in July. 5
- HELENIUM. (Sneeze-Wort.)** Strong-growing, hardy perennials, succeeding in any kind of soil, and useful in any hardy border, giving an enormous crop of flowers in the late summer. 5
- Autumnale Superbum.** Large heads of golden-yellow flowers; 5 to 6 feet. 10
- Grandicephalum Striatum.** Individual flowers 1½ inches across, borne in large heads; color deep orange, irregularly streaked with crimson; 3 feet. 10
- Riverton Gem.** A new variety that originated with us; in color a rich Wallflower-red, distinct and desirable. 2 pkts. for 25 cts. 10
- Riverton Beauty.** Our most recent introduction; color rich lemon, black centre. 15
- HELIANTHUS. Perennial Sunflower.** This is a mixture of the finest single-flowering hardy perennial sorts, including such varieties as Maximiliana, Miss Mellish, Orgyalis, Tomentosus, etc. Per ¼ oz., 50 cts. 10
- HELIOPSIS. Pitcheniana (Orange Sunflower).** A desirable hardy herbaceous plant, growing from 3 to 4 feet high, beginning to flower early in the season and continuing the entire summer. The flowers are of a beautiful deep golden-yellow color, about 2 inches in diameter, of very thick texture. Per ¼ oz., 20 cts. 10
- Pitcheniana Semi-plena.** A new semi-double flowering form. 15
- Scaber Major.** Very similar to *Pitcheniana*, but with much larger flowers. Per ¼ oz., 20 cts. 10
- HEUCHERA. Sanguinea (Alum Root).** One of the finest hardy perennials. The flowers are of a rich, bright crimson color, the leaves light green and slightly hairy. 10
- HOLLYHOCK.** One of the most majestic of hardy plants, and a clump or line in any garden gives an effect not attainable with any other plant. For planting among shrubbery or forming a background for other flowers it is without equal. The seeds offered have been saved from the finest double flowers.
- Double White,** per ¼ oz., 40 cts. 10
- Yellow,** per ¼ oz., 40 cts. 10
- Salmon-rose,** per ¼ oz., 40 cts. 10
- Red,** per ¼ oz., 40 cts. 10
- Pink,** per ¼ oz., 40 cts. 10
- Maroon,** per ¼ oz., 40 cts. 10
- Extra Choice Double Mixed,** per ¼ oz., 30 cts.; per oz., \$1.00 10
- Collection of a packet each of the above 6 colors** 50
- Imported Collection of 12 colors** 75
- "Allegheny."** Mammoth flowers, formed of loosely-arranged fringed petals, which look as if made from the finest China silk. The colors vary from the palest shrimp-pink to deep red. Per ¼ oz., 30 cts.; per oz., \$1.00. 10
- Single.** Many prefer the single-flowering Hollyhocks. They are usually of freer growth than the doubles, and present a very handsome appearance when covered with their artistic blossoms. Mixed colors. Per ¼ oz., 30 cts.; per oz., \$1.00. 10
- IRIS. Kämpferi (Japanese Iris).** This is one of the showiest of the "Flags," and now extensively used in the hardy garden. The seeds we offer have been saved from our own unrivaled collection, and should produce only varieties of the highest merit. Blooms the second year from seed. Per ¼ oz., 25 cts. 10
- LAVENDER (Lavandula Vera).** Well-known, sweet-scented, hardy perennials. Per ¼ oz., 15 cts. 5



DOUBLE HOLLYHOCK.

- LATHYRUS (Everlasting, or Hardy Sweet Pea).** Showy, free-flowering hardy perennial climbers for covering old stumps, fences, etc.; continually in bloom; fine for cutting. PER PKT. 5
- Latifolius.** Purplish-red. 10
- Albus.** Pure white; very desirable. 5
- "White Pearl."** A splendid new large-flowering white, flower and trusses almost twice the size of the old sort. 10
- Pink Beauty.** Bright rosy-pink. 15
- Mixed.** All colors. Per oz., 40 cts. 10
- LIATRIS (Blazing Star, or Gay Feather).** Most showy and attractive hardy perennial native plants, with long spikes of purple and rosy-purple flowers from July to September; 3 to 4 feet. Mixed varieties. 5
- LINARIA. Cymbalaria (Kentworth Ivy, or Mother of Thousands).** Lavender and purple. A charming, neat, hardy perennial trailing plant, suitable for baskets, vases, pots and rock work. 10
- LINUM. Flavum.** A bright yellow, hardy perennial variety; June to September; 1 foot. 10
- Perenne.** Another hardy variety, producing bright blue flowers the entire summer; 18 inches. 10
- LOBELIA. Cardinalis (Cardinal Flower).** A native hardy variety, with spikes of brilliant scarlet flowers; fine border plant; 3 feet. 10
- Hybrids.** Flowers resemble *Cardinalis*, but are of splendid shades of rose, red, lilac, purple, etc. 10
- Fulgens Queen Victoria.** A beautiful variety, with dark bronzy foliage and brilliant scarlet flowers. 25
- Syphilitica (Great Lobelia).** Of strong habit, color light blue. 25
- LUPINUS. Polyphyllus roseus.** A new rosy-pink sort that has much to recommend it. 15
- Perennial Mixed.** Hardy varieties in blue and white mixed. Per oz., 30 cts. 5
- LYCHNIS. Handsome hardy perennial plants of easy culture, growing in any rich garden soil; for maa-sing in beds and borders.**
- Chalcedonica (Rose Campion, Jerusalem Cross).** Fine scarlet flowers; 2 feet. Per ¼ oz., 20 cts. 5
- Haageana.** Brilliant orange, scarlet, crimson, etc., in mixture; 1 foot. Per ¼ oz., 30 cts. 10
- LYTHRUM. Roseum Superbum (Rose Loose Strife).** A very pretty hardy perennial; grows about 3 feet high and produces spikes of rosy flowers from July to September. 10

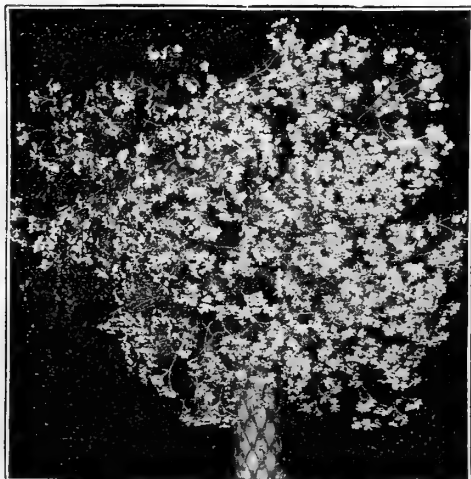

GYPHOPHILA PANICULATA.

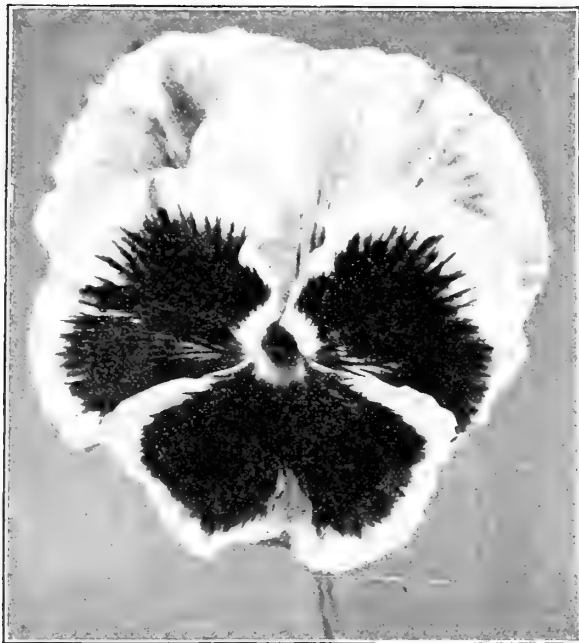

DREER'S ROYAL EXHIBITION PANSY.

GIANT TRIMARDEAU PANSIES. The largest flowering of all; of strong, robust growth and well adapted to the trying conditions of our climate.

- Black** 10
- Striped** 10
- White, with dark eye**..... 10
- Yellow, with dark eye**..... 10
- Emperor William, Blue**..... 10
- Fire King, Brown and gold**..... 10
- Finest Mixed.** A splendid range of colors. Per ¼ oz., 50 cts... 10

PANSIES IN SEPARATE COLORS.

- Adonis.** Soft lavender-blue..... 10
- Andromeda.** Apple-blossom pink, suffused rosy-lilac..... 20
- Cardinal.** The nearest approach to a bright red..... 10
- Emperor Franz Joseph.** Pure white, with five large violet-blue blotches..... 20
- Emperor William.** Brilliant ultramarine-blue..... 10
- Faust (King of the Blacks).** Almost black..... 10
- Golden-yellow,** with dark eye..... 10
- Kaiser Frederick** Velvety-brown, edged red and yellow..... 10
- Lord Beaconsfield.** Deep purple-violet, shading to white on the upper petals..... 10
- Mahogany-colored.** Rich and velvety..... 10
- Mauve Queen.** A new, distinct, delicate mauve variety; three lower petals blotched carmine..... 20
- Peacock.** Upper petals beautiful blue, lower petals a deep claret, with white margins..... 10
- Psyche.** Five velvety-violet blotches, relieved by a broad margin of white; exquisite..... 15
- Snow Queen (Candidissima).** Satiny-white..... 10
- White,** with dark eye..... 10
- Yellow Gem.** Pure yellow..... 10
- Collection,** 12 varieties, our selection..... 75
- Collection,** 6 varieties, our selection..... 40

PENTSTEMON (Beard Tongue). Highly useful and attractive hardy perennials, and much used in the hardy border.

- Barbatus Torreyi.** Brilliant coral-red..... 10
- Digitalis.** White flowers, with purple throat..... 10
- Pubescens.** Spikes of bright rosy-purple flowers..... 10
- Pulchellus hybridus.** Varying from rosy-white and chamois to purple and violet with pure white or veined throats..... 15
- Sensation.** A splendid strain of *gentianoides hybrids*; fine spikes of Gloxinia-like flowers in a fine range of colors..... 15
- Mixed.** A great variety of kinds and colors..... 5

PHLOX, Decussata (Hardy Perennial Phlox). The most important hardy perennial plant grown. The seed we offer has been saved from our own unrivaled collection, and should produce satisfactory results. Seed is saved in mixture only, and is usually ready to send out by the end of September. Per ¼ oz., 50 cts.... 10

PHYSTEGIA, Virginica (False Dragon Head). One of the best hardy perennials, forming dense bushes 3 to 4 feet high, and bearing freely during the summer months spikes of delicate tubular flowers not unlike a gigantic heather..... 10

PLATYCODON (Chinese Bell-flower). One of the best hardy perennials, producing flowers the whole season.

- Grandiflorum.** Large steel-blue flowers. 25 cts. per ¼ oz..... 5
- Album.** Pure white variety. 25 cts. per ¼ oz..... 5
- Mariesi.** Rich violet-blue; plant dwarf and compact. 25 cts. per ¼ oz..... 5
- Japonicus Fl. Pl. (Double Japanese Bell-flower).** Wonderfully free-flowering, bearing large, double, glossy deep blue flowers..... 15

- MIGNONETTE, Defiance.** Spikes of remarkable size; from 12 to 15 inches long; deliciously fragrant. Per ¼ oz., 25 cts..... 10
- Golden Machet.** Golden-yellow. Per ¼ oz., 25 cts..... 10
- Large-flowering Pyramidal.** Flowers large, of a reddish tint. Per oz., 25 cts..... 10
- Machet.** Well adapted for pot culture; dwarf pyramidal growth, bearing numerous flower stalks; highly colored and very fragrant. Per ¼ oz., 25 cts..... 10
- Goliath.** Plants of compact habit, with rich green foliage, the giant trusses of flowers being borne on erect, strong, stiff stalks and surpassing all others in brilliancy of color; especially suited for house culture. Per ¼ oz., 50 cts..... 15
- Salmon Queen.** One of the brightest and sweetest; good spikes. Per ¼ oz., 25 cts..... 10
- Sweet-scented (Reseda Odorata).** The old variety with small spikes, but very sweet-scented. Per oz., 15 cts..... 5
- MONARDA Didyma rosea (Bee Balm).** Free, strong-growing, hardy plant, flowers bright rose..... 15
- MYOSOTIS (Forget-Me-Not).** Neat and beautiful little plants, succeeding best in a semi-shady, moist situation.
- Alpestris Cœrulea.** Bright blue. Per ¼ oz., 25 cts..... 5
- Eliza Foubert (Robusta grandiflora).** Large-flowering; bright blue. Per ¼ oz., 30 cts..... 5
- Victoria.** Of bushy habit, bearing large umbels of bright azure-blue flowers. Per ½ oz., 25 cts..... 10
- Royal Blue.** This beautiful variety belongs to the upright section; flowers of larger size and a deeper blue than any other; unexcelled for pot culture..... 15
- Dissitiflora.** Compact habit, profuse bloomer; exquisite blue; an attractive spring-bedding plant..... 10
- Palustris.** The true-blue Forget-Me-Not. Per ¼ oz., 30 cts..... 10
- Semperflorens.** A charming Forget-Me-Not, continuing in bloom from early spring until autumn; blue. Per ½ oz., 30 cts. 10
- Ruth Fischer.** The latest and largest variety yet sent out; color clear blue..... 25
- MUSA, Ensete (Abyssinian Banana).** A splendid plant for the open air in summer, producing a most striking effect when planted singly or in groups. The seeds germinate easily if planted in summer, and the plants can be then carried over in the house till the following summer..... 25
- GENOTHERA, Mixed (Evening Primrose).** Charming; mostly low-growing, hardy perennial plants, with large and showy flowers of yellow, white, etc..... 10
- PANSIES, Dreer's Royal Exhibition.** Our finest mixture. Unexcelled for size, coloring and texture. Special packet of about 2,000 seeds, \$1.00; 5,000 seeds, \$2.00; regular packet..... 50
- Dreer's Premium Mixture.** Seed saved from first-class flowers only. Per ½ oz., 75 cts..... 75
- Mine, Perret.** A new French strain; flowers of large size; specially rich in red shades. Per ½ oz., 75 cts..... 75
- Masterpiece.** A remarkable type, each petal being conspicuously curled or waved; mixed colors. Per ½ oz., 75 cts..... 75
- Cassier's Giant.** A mixture of the finest blotched varieties..... 25
- Giant Parisian.** Of large size and containing a great many fancy colors and color combinations. Per ¼ oz., 75 cts..... 15
- English Finest Mixed.** Per ¼ oz., 50 cts..... 10
- Good Mixed.** All colors. Per ¼ oz., 25 cts..... 5



HARDY PERENNIAL PHLOX.

POLYANTHUS (Primula Elatior). Showy hardy early spring free-flowering plants, fine for either pot or outdoor culture. English. All colors mixed. Per ¼ oz., 50 cts. 5
Gold Laced. Very showy and attractive. 15

POLYGONUM, Compactum (Knotweed). A fine hardy perennial, 15 inches high, covered during the autumn with foamy-white flowers. 15

POPPIES, Hardy Perennial Sorts.
Bracteatum. Very large orange-scarlet flowers. Per ¼ oz., 20 cts. 5

Iceland (P. Nudicaule). Of graceful, neat habit, with bright green fern-like foliage, formed in tufts, from which issue slender stalks about 12 inches in height, bearing flowers in endless profusion.

— Bright Yellow 10
— Pure White 10
— Orange-scarlet 10
— Double Scarlet 10

— Finest Mixed. All colors. Per ¼ oz., 25 cts. 10
— New Hybrid. The latest development in this lovely species, varying in color from sulphur-yellow to salmony-rose. 15

Oriental (The Large Oriental Poppy). A charming summer-flowering hardy plant, producing numerous leafy stems about 2½ feet high, with large deep crim-on flowers, having a conspicuous black blotch on each petal; exceedingly showy. Per ¼ oz., 25c. 10

— Hybrids. Beautiful new hybrids of the Oriental Poppy, producing flowers of immense size, 6 inches and over in diameter, and of many novel colors, such as salmon, pink, cherry, etc. Per ¼ oz., 40 cts. 15

— Mammoth. A new variety, bearing immense glowing-scarlet flowers 20

PRIMULA SINENSIS (Chinese Fringed Primrose).

Alba Magnifica. The finest pure white 25
Covent Garden Red. Large rosy-red. 25

Rosy Morn. Beautiful delicate pink. 50
Hoborn Blue. Unique shade. 50
Double-flowering. Finest varieties; mixed. 50

Fern-leaved, Finest Mixed. 25
Stellata. A very pretty form, with large heads of star-shaped flowers of various colors; splendid for decorative purposes. 50

Dreer's Choicest Mixed. This mixture contains nothing but the finest fringed sorts, and cannot fail to give satisfaction. 25

VARIOUS PRIMULAS. The following varieties are of the easiest culture in greenhouse or light window of dwelling house, flowering abundantly and continuously with little care.

Obconica Grandiflora. Pure white, shading to lilac. 10
— Fimbriata. A fringed variety of the above. 15
— Carmine. Rich carmine. 20
— Compacta. A fine dwarf, compact-growing form. 25

— Gigantea. The largest and finest of this section; various colors 20
Kewensis. A new free-flowering yellow variety. 25

Forbesi (Baby Primrose). Beautiful rosy-lilac flowers. 25
Floribunda (Buttercup Primrose). Of the same general character as Obconica, differing only in color, which is a lovely shade of yellow. 25

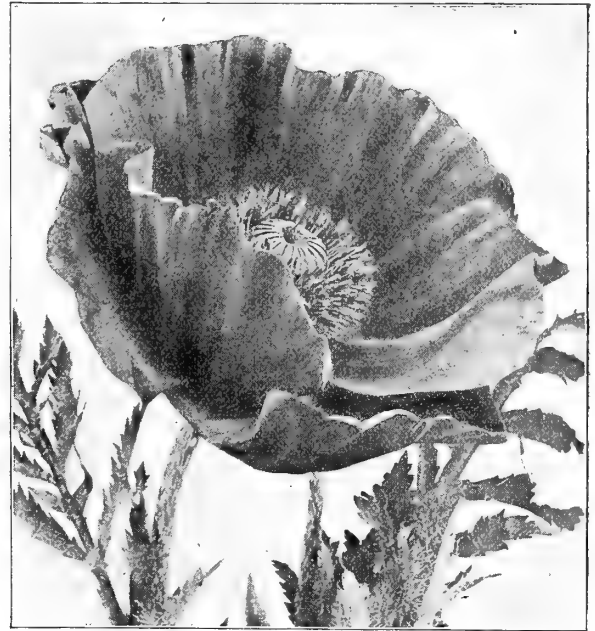

ORIENTAL POPPY.

HARDY PRIMROSES. These are among the earliest spring-blooming plants. With a slight protection they will stand the winter, but do better if protected by a cold frame.

Articula. Choicest mixed. 10
Curtusoides Amena (Sieboldi). Charming variety; mixed colors 25

Japonica (Japanese Primrose). Bright and showy flowers, borne in whorls on stems 6 to 9 inches long; mixed colors. 10
Vulgaris (English Primrose). Flowers fragrant, canary-yellow. Per ¼ oz., 50 cts. 10

PUEBARIA, Thunbergiana (Kudzu Vine). A strong, quick-growing hardy climber; splendid for covering. 15

PYRETHRUM, Hybridum. Large daisy-like flowers, ranging in color from light pink to deep red, with bright yellow centres. Per ¼ oz., 25 cts. 10

— Grandiflorum. This new large-flowering form produces blooms frequently measuring over 4 inches in diameter in all the variations of color between light rose and deep carmine. Per ¼ oz., 50 cts. 15

Hybridum Fl. Pl. Large-flowering double; seed saved from a celebrated collection; mixed colors; 1½ feet. 25

Uliginosum (Giant Daisy). A fine hardy perennial, grows 3 to 4 feet high, and from July to September is literally hidden beneath the multitude of large white flowers. Per ¼ oz., 50 cts. 70

RHEXIA, Virginica (Meadow Beauty). A pretty hardy perennial, 9 inches high, bearing all summer rosy-purple flowers. 70

ROSMARINUS, Officialis (Rosemary). The old favorite aromatic herb. Per ¼ oz., 15 cts. 5

RUDEBECKIA, Fulgida (Cone-flower). An effective hardy perennial sort, producing in masses brilliant orange-yellow flowers Newmann. One of the finest of autumn-flowering perennials. Bright orange-yellow petals, surrounding a large black cone. 15

Purpurea (Giant Purple Cone-flower). Showy, reddish-purple flowers, about 4 inches across; a remarkably large cone-shaped centre of brown. 15

SALVIA, Azurea Grandiflora A fine hardy perennial with spikes of sky-blue flowers in August and September; 3 feet. 10

SAPONARIA, Caucasia Fl. Pl. (Bouncing Bet). A hardy perennial of easiest culture, producing double bluish-white, fragrant flowers. 10

SCABIOSA, Caucasia. (Blue Bonnet). One of the handsomest of hardy perennials, especially valuable for cutting, the bloom lasting a long time in water; lilac blue; 3 feet. 10

Japonica. A new hardy sort from Japan; lavender-blue. 15

SMILAX (Myrsiphyllum Asparagoides). In many respects the most useful and certainly one of the most graceful climbers which adorn the greenhouse or conservatory. For bouquets and floral decoration it is indispensable. Per ¼ oz., 25 cts. 10

Myrtle-leaved. A new fine-leaved sort that is very graceful. 25

STATICE (Sea Lavender). Splendid hardy perennials, either for the border or rockery, producing all summer panicles of minute flowers, which can be dried and used for winter bouquets; mixed varieties. 10

STOKESIA, Cyanea (Cornflower Aster). This beautiful hardy perennial grows about 24 inches high, bearing handsome lavender-blue cornflower-like blossoms from July till frost. Per ¼ oz., 30 cts. 10

Cyanea alba. A new pure white variety. 20
New Colors Mixed. An introduction of 1909. Contains rose color and several shades of blue. 25
SWEET ROCKET (Hesperis). Old-fashioned hardy garden plant, also known as Dame's Rocket and Dame's Violet; grows 2 to 3 feet high, and bears showy white, lilac and purple fragrant flowers; mixed colors. Per oz., 25 cts. 5



PYRETHRUM HYBRIDUM SINGLE.



SWEET WILLIAM.

- SWEET WILLIAM (London Tufts).** Well-known free-flowering hardy perennials, producing a splendid effect in beds and borders with their rich and varied flowers. We offer the best and most distinct sorts, viz:
- Single White..... 5
 - Crimson..... 5
 - Scarlet..... 5
 - Velvety Black Maroon..... 5
 - Red, with white eye..... 5
 - Violet, with white eye..... 5
- A packet of each of the above six colors..... 25
- Newport Pink.** A distinct new shade, being a bright salmon-rose or watermelon-pink; very effective. 5 pkts., \$1.00..... 25
- Holborn Glory.** Of extra large size and fine coloring. Per ¼ oz., 25 cts..... 10
- Single Mixed.** All colors. Per oz., 30 cts..... 5
- Double Mixed.** All colors. Per ¼ oz., 25 cts..... 5
- Giant Double.** Producing immense umbels of full, double flowers; colors exceedingly varied..... 15
- Double Rose.** A new and desirable color in the double-flowering type..... 20
- TRITOMA, Hybrida (Red-hot Poker, Flame Flower or Torch Lily).** Saved from our own collection, which is undoubtedly the finest in this country..... 25
- TUNICA, Saxifraga.** A neat, tufted hardy perennial plant, growing but a few inches high and bearing throughout the entire season numerous elegant pink flowers. Will thrive anywhere, but is especially adapted for the rockery or margin of the hardy border..... 10
- VALERIANA, Officinalis (Garden Heliotrope).** Showy, hardy border plants, producing large corymbs of old-rose flowers, with a strong heliotrope odor..... 15
- Mixed (Valerian).** Showy heads of red or white flowers..... 5
- VERONICA, Spicata (Speedwell).** An elegant hardy perennial border plant, growing about 18 inches high, bearing all summer long spikes of bright blue flowers..... 10
- VIOLAS, or TUFTED PANSIES.** While the Pansy proper is essentially a spring flower, the Violas here offered flower throughout the entire season.
- Admirabilis.** A sensational novelty, having all the rich and varied blotchings of the finest Pansies. 3 pkts. for 50 cts..... 20
 - Papilio (Butterfly Violet).** An exceedingly lovely violet-lilac..... 10
 - Lutea splendens.** Rich golden-yellow..... 10
 - Blue Perfection.** Deep blue..... 10
 - White Perfection.** A fine white..... 10
 - Mixed.** A splendid mixture of the best varieties. Per ¼ oz., 50 cts..... 10
- WALLFLOWER.** Well-known deliciously fragrant perennials, blooming early in the spring, with spikes of beautiful flowers. They should be planted in a sheltered position or protected in a cold frame in the winter, and planted out in April
- Golbath.** A splendid single variety, flowers of a rich shining red, with a black velvety sheen..... 15
 - Paris Extra Early.** A beautiful single variety, which may be treated as an annual..... 10
 - Double Finest Mixed.**..... 10
 - Single Mixed.** All colors. Per ¼ oz., 15 cts..... 5
 - Imported Collection of Double Wallflowers, 6 colors.**..... 50
 - Imported Collection of Single Wallflowers, 6 colors.**..... 40

SWEET PEAS.

For early flowering we advise autumn planting; sow about the end of November in this latitude. For a complete list see pages 56, 109 and 110 of our Garden Book for 1929.

ORCHID-FLOWERED VARIETIES.

This splendid type has come to stay. They are distinguished for their very large flowers, which have wavy petals, and usually borne four on a stem. They will undoubtedly supersede standard sorts of same color as soon as they become more plentiful.

	OZ.	PKT.
Countess Spencer. A lovely clear pink.....	\$0 25	10
E. J. Castle. Rich carmine-rose.....	25	10
Florence M. Spencer. Blush, with pink margin.....	30	10
Frank Dolby. Pale lavender.....	40	10
Gladys Unwin. Pale rose-pink.....	20	10
Helen Lewis. Brilliant orange-rose.....	20	10
Helen Pierce. White, marbled blue.....	20	10
John Ingman. Rose-carmine.....	20	10
Mrs. Alfred Watkins. Pale pink.....	25	10
Phyllis Unwin. Bright carmine.....	20	10
Primrose Spencer. Primrose-yellow.....	30	10
White Spencer. Pure white; very large.....	25	10
Mixed Orchid-flowered, ¼ lb., 50 cts.....	20	10

STANDARD VARIETIES.

The following are merely the leading varieties. For complete list see page 109 of our Garden Book for 1929.

Aurora. Orange-rose, striped on a white ground.....	10	5
Blanche Ferry. The popular pink and white.....	10	5
Coccinea. Rich brilliant cerise.....	10	5
Countess of Lathom. Creamy-pink; very rich.....	10	5
Dainty. White, daintily edged with pink.....	10	5
Dorothy Eckford. Magnificent pure white.....	10	5
Duke of Westminster. Clear purple, tinted violet.....	10	5
Earliest of All (Christmas Pink). Pink and white; very early for growing under glass.....	10	5
Flora Norton. The clearest and most pronounced bright blue.....	10	5
Henry Eckford. Clear orange-yellow; a new shade that is very striking.....	15	5
Hon. Mrs. E. Kenyon. The finest primrose-yellow.....	10	5
King Edward VII. The finest crimson-scarlet.....	10	5
Lady Griseld Hamilton. A grand pale lavender.....	10	5
Lovely. Soft shell-pink; a lovely shade.....	10	5
Miss Willmott. Brilliant orange-pink; very large.....	10	5
Mrs. Walter Wright. An exquisite shade of mauve.....	10	5
Mont Blanc (Christmas White). Earliest white for growing under glass.....	10	5
Navy Blue. Deep indigo-blue, of medium size.....	10	5
Othello. Very dark maroon, shaded almost black.....	10	5
Prima Donna. A magnificent pure pink.....	10	5
Prince of Wales. The finest bright rose.....	10	5
Queen Alexandra. Brilliant geranium-red, the nearest approach to a pure scarlet yet introduced.....	15	5
Stella Morse. Primrose, tinged blush.....	10	5
Dreer's Peerless Mixture. All the finest standard sorts. Per lb., \$1.00; ¼ lb., 25 cts.....	10	5



SWEET PEAS, HELEN PIERCE.

A FEW SPECIALTIES IN VEGETABLE SEEDS—For Forcing.

On this page we offer a few of our leading varieties suitable for forcing; other sorts will be found in the general list on pages 72 and 73. Seeds we supply are fresh and of best quality.

PRICES FOR VEGETABLE SEEDS INCLUDE DELIVERY BY MAIL UNLESS OTHERWISE NOTED.

BEANS.

Giant Forcer. A variety of green-podded Bean, suitable for forcing under glass and also for outdoor culture. The pods mature very quickly, and are exceedingly attractive, both in color and shape. Pt., 25 cts. (postpaid, 33 cts.); qt., 45 cts. (postpaid, 60 cts.); 4 qts., \$1.60; peck, \$2.25.

Triumph of the Frames. A good variety for forcing. Produces a mass of pale green pods, is very dwarf, prolific, and of rich, tender quality. Pt., 25 cts. (postpaid, 33 cts.); qt., 45 cts. (postpaid, 60 cts.); 4 qts., \$1.60; peck, \$2.25.

BEETS.

Early Eclipse. Remarkable for rapid growth, smallness of top, and extra fine quality. Perfectly smooth and round; skin and flesh intense red; very fine-grained. Pkt., 5 cts.; oz., 10 cts.; ½ lb., 25 cts.; lb., 75 cts.

Crosby's Egyptian. (See cut.) An excellent early variety; produces a smooth Beet, and is of good quality. Pkt., 5 cts.; oz., 10 cts.; ½ lb., 30 cts.; lb., 80 cts.

CARROT.

Dreer's "Perfect" Forcing Carrot. (See cut.) A perfect half-long variety, beautiful bright scarlet color, very crisp, and grows almost without core. Tops are remarkably small, thus allowing the Carrots to be grown close in the frames. Pkt., 10 cts.; oz., 20 cts.; ½ lb., 50 cts.

CUCUMBER.

Arlington White Spine. A magnificent strain of the White Spine which has been improved by careful selection, for forcing in hot houses and frames; very tender and crisp. It is also a very fine cucumber for growing in the field and produces large fruits in great abundance. Pkt., 10 cts.; oz., 25 cts.; ½ lb., 75 cts.; lb., \$2.50.

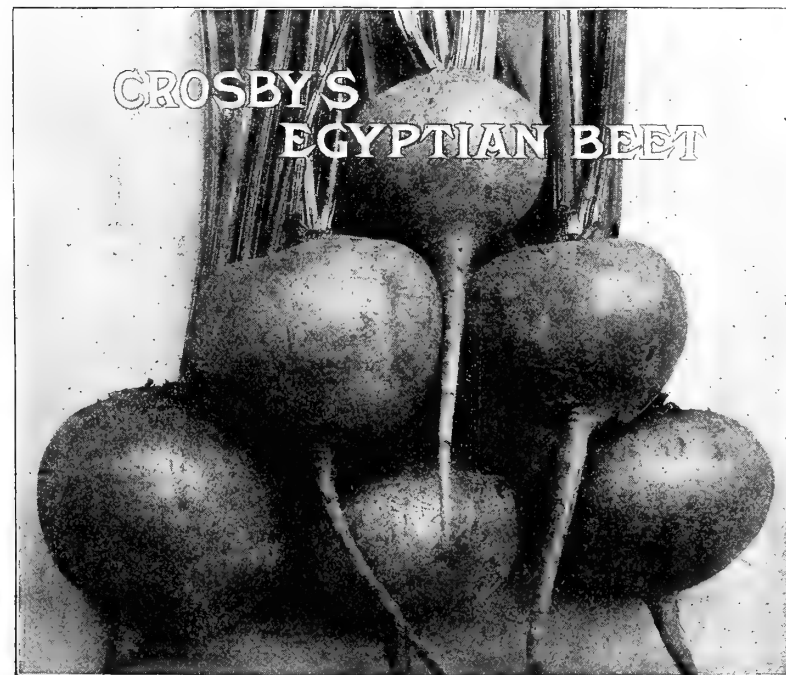
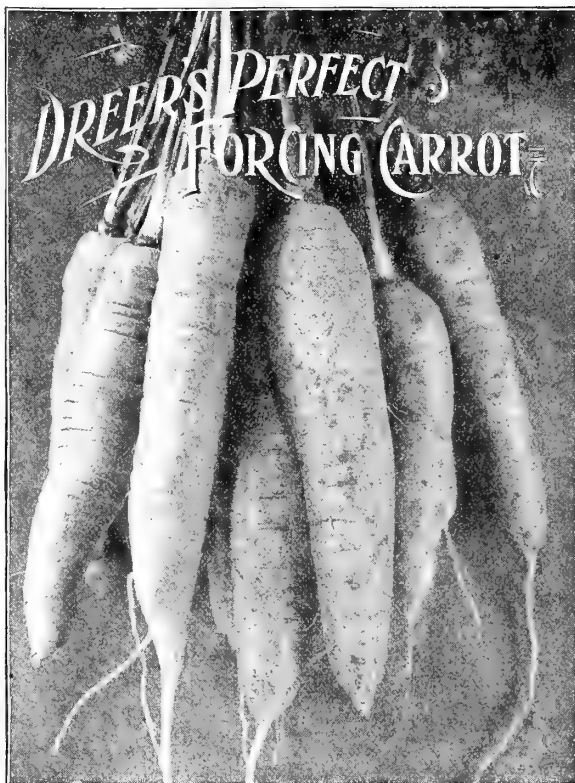

LETTUCE.

Unrivalled. Similar to Big Boston, and in some respects it is better for forcing. Pkt., 5 cts.; oz., 20 cts.; ½ lb., 50 cts.

Boston Market. Hardy and crisp; largely used for forcing. Pkt., 5 cts.; oz., 20 cts.; ½ lb., 50 cts.

Grand Rapids Forcing. Matures quickly, large size, crisp and tender. Pkt., 5 cts.; oz., 20 cts.; ½ lb., 50 cts.

RADISH.

Cardinal Globe. Those who like the crisp little red Radishes that come so early will be pleased with this variety. Pkt., 5 cts.; oz., 10 cts.; ½ lb., 35 cts.; lb., \$1.00.

Dreer's Crystal Forcing. A beautiful white variety, quick forcer, and can also be grown in open ground. Pkt., 10 cts.; oz., 15 cts.; ½ lb., 40 cts.; lb., \$1.25.

TOMATO.

Comet. Produces a large crop of medium size tomatoes, which are a rich scarlet color, very solid and of excellent quality. Pkt., 15 cts.; ½ oz., 50 cts.; oz., 85 cts.; ¼ lb., \$3.00.

Frogmore Selected. Shape round, color deep bright red, and very smooth. Pkt., 10 cts.; ½ oz., 25 cts.; oz., 40 cts.; ¼ lb., \$1.25.

Lorillard. A good sort for forcing; bright red, smooth, early. Pkt., 10 cts.; oz., 35 cts.; lb., \$1.00.

GENERAL LIST OF DREER'S RELIABLE VEGETABLE SEEDS

For Forcing and Fall Sowing.

For the convenience of our patrons in the South, we give an extended list of the leading Vegetable Seeds, to enable them to make their purchases in the fall, their sowing season being nearly over by the time our spring list is issued.

Vegetable Seeds mailed free in packets, ounces or pounds. If Beans or Peas are wanted by mail, add 8 cts per pint, 15 cts. per quart for postage.



BEANS, Dwarf or Bush.

Green-Pod Varieties.

If by mail, add 8 cts. per pint, 15 cts. per quart.

	PT.	QT.	PK.
Improved Round-Pod Valentine.....	15	25	\$1 50
Early Mohawk.....	15	25	1 50
Burpee's Stringless Green-Pod.....	20	30	1 75
Mammoth Stringless Green-Pod.....	20	30	1 75
Giant Forcer (see page 71).....	25	45	2 25
Triumph of Frames, Forcing (see page 71).....	25	45	2 25

Wax Varieties.

Improved Prolific Black Wax.....	20	30	1 75
Currie's Rust-Proof Wax.....	20	30	1 75
Wardwell's Kidney Wax.....	20	30	1 75
Hodson Wax.....	20	30	1 75

Bush Limas.

Dreer's Wonder Bush Lima.....	20	35	2 00
Dreer's Bush Lima.....	20	35	2 00
Fordhook Bush Lima.....	35	60	3 50
Burpee's Bush Lima.....	20	35	2 00
Henderson's Bush Lima.....	20	30	1 75

BEETS, Table Sorts.

	PKT.	OZ.	¼ LB.	LB.
Early Model.....	10	15	40	\$1 25
Crosby's Egyptian (see page 71).....	5	10	30	80
Crimson Globe.....	10	15	35	1 00
Dreer's Excelsior.....	10	15	35	1 00
Early Eclipse (see page 71).....	5	10	25	75
Early Egyptian Blood Turnip.....	5	10	25	75
Bastian's Extra Early Turnip.....	5	10	25	75
Edmand's Early Blood Turnip.....	5	10	25	75
Early Blood Turnip, Improved.....	5	10	25	75
Bastian's Half-Long Blood.....	5	10	25	75
Long Dark Blood.....	5	10	25	75

BROCCOLI.

White Cape.....	PKT.	OZ.	¼ LB.	
	10	35		\$1 00

BRUSSELS SPROUTS.

Dreer's Selected Matchless.....	10	30	85
---------------------------------	----	----	----

CABBAGE.

	PKT.	OZ.	¼ LB.	LB.
Early Jersey Wakefield.....	10	30		\$1 00
Charleston, or Large Wakefield.....	10	35		1 25
Eureka, or First Early (see cut).....	10	30		1 00
Volga.....	10	30		1 00
Dreer's Early Drumhead.....	5	30		1 00
All Head.....	5	30		1 00
Improved Early Summer.....	5	30		1 00
All Seasons.....	5	30		1 00
Succession.....	5	30		1 00
Danish Bull Head.....	10	30		85
Danish Round Head.....	10	30		1 00
Surehead.....	5	30		1 00
Dreer's Selected Flat Dutch.....	10	35		1 25
Perfection Drumhead Savoy.....	5	30		1 00
Dreer's Crystal Summer Savoy.....	10	35		1 25
Mammoth Rock Red.....	5	30		1 00
Red Dutch Erfurt.....	5	25		75

CARROT.

Sow in cold frames in October for an early spring supply.

	PKT.	OZ.	¼ LB.	LB.
Dreer's Perfect Forcing (see page 71).....	10	20	50	
Earliest Short Horn.....	5	15	35	\$1 00
Early Scarlet Horn.....	5	10	30	90
Early Half-Long Scarlet.....	5	10	30	90
Early Half-Long Carentan.....	5	10	30	90
Rubicon, Half-Long.....	5	10	30	90
Nichol's Long Orange.....	5	10	25	80
Chantenay, Half-Long.....	5	10	30	90
Danver's Half-Long Orange.....	5	10	30	90

CAULIFLOWER.

Sow for spring cutting from September to February.

	PKT.	¼ OZ.	LB.
Dreer's Earliest Snowstorm.....	25		\$1 75
Dreer's Selected Dwarf Erfurt.....	20		1 00
Dry Weather (see cut).....	20		1 00
Early Snowball.....	20		1 00
Early Dwarf Erfurt.....	10		75

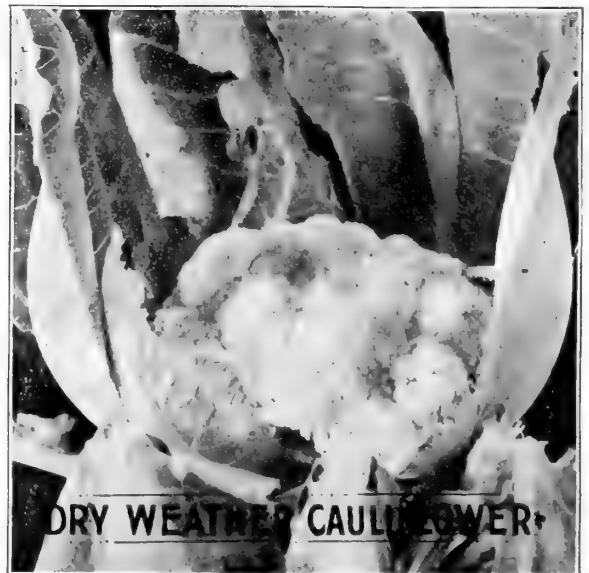

CORN SALAD.

Large Seeded.....	PKT.	OZ.	¼ LB.	LB.
	5	10	20	60

CUCUMBER. English Forcing Varieties.

	PKT.	OZ.	¼ LB.	LB.
Rochford's Market.....	\$0 25			\$2 25
Covent Garden Favorite.....	25			2 25
Lockie's Perfection.....	25			2 25
Telegraph (Rollison's) (see cut).....	20			1 75
Sion House, Improved.....	20			1 75

KALE, or BORECOLE.

	PKT.	OZ.	¼ LB.	LB.
Dreer's Imperial Long Standing..	5	10	30	90
Dwarf Curled German.....	5	10	25	75

LETTUCE. For Fall Sowing.

	PKT.	OZ.	¼ LB.	LB.
May King.....	10	25		75
Dreer's All-Heart.....	10	25		75
Wonderful.....	10	20		60
Big Boston.....	5	20		50
Unrivaled (see page 71).....	5	20		50
Boston Market, Forcing (see page 71)...	5	20		50
Silver Ball.....	5	20		50
Mammoth Salamander.....	5	20		50
Sensation.....	5	20		50
Deacon.....	5	20		50
Dutch Butter, Spotted.....	5	20		50
Grand Rapids, Forcing (see page 71)....	5	20		50

PURE CULTURE MUSHROOM SPAWN.

Per brick, 25 cts. (by mail, 40 cts.); by express, 5 bricks, \$1.00; 10 bricks, \$1.70; 25 bricks, \$4.00; 50 bricks, \$7.00.

DREER'S RELIABLE ENGLISH MILLTRACK MUSHROOM SPAWN.

Per brick, 15 cts.; by mail, 25 cts. By express, 12 bricks, \$1.50; 25 lbs., \$2.50; 50 lbs., \$4.50; 100 lbs., \$8.00.

FRENCH MUSHROOM SPAWN.

3-lb. box, \$1.25, by express.

Dreer's Mushroom Circular FREE with each order.

PEAS.

If by mail, add 8 cts. per pint, 15 cts. per quart.

	PT.	QT.	PECK.
Dreer's Electric Extra Early.....	20	35	\$2 00
Dreer's Eureka Extra Early.....	20	35	2 00
Improved Daniel O'Rourke.....	15	25	1 65
American Wonder.....	20	30	1 75
Nott's Excelsior.....	25	35	2 00
Gradus, or Prosperity.....	25	45	2 50



ENGLISH FORCING CUCUMBER, TELEGRAPH.

PARSLEY.

	PKT.	OZ.	¼ LB.	LB.
Dreer's Dwarf Perfection.....	10	35	\$1 00	
Dwarf Extra Curled.....	5	10	25	75
Champion Moss Curled.....	5	10	25	75
Dreer's Summer Green.....	5	15	30	1 00
Half Curled.....	5	10	25	75

RADISH.

Earliest Red May.....	10	15	40	1 25
Earliest White May.....	10	15	40	1 25
Cardinal Globe (see page 71)...	5	10	35	1 00
Round Red Forcing (see cut)...	5	15	35	1 00
Dreer's Crimson Ball.....	10	15	40	1 25
White Tip, Scarlet Gem.....	5	10	35	90
Early Scarlet Turnip.....	5	10	30	85
Dreer's Crystal Forcing.....	10	15	40	1 25
Philadelphia White Box.....	5	10	25	75
Long Scarlet Shot-Top.....	5	10	25	75
Icicle.....	5	10	35	90
Scarlet China Winter.....	5	10	30	85
Round Black Spanish.....	5	10	25	75
White Chinese.....	5	15	40	1 25

SPINACH.

Dreer's Round Seeded Savoy.....	5	10	15	40
Victoria.....	5	10	15	40
Long Season.....	10	15	25	70
Long Standing, Round Seeded.....	5	10	15	35
Prickly Seeded.....	5	10	15	35

TOMATOES. For Forcing.

Frogmore Selected (see page 71).....	10	40	1 25
Comet (see page 71).....	15	85	3 00
Best of All.....	10	40	1 25
Lorillard (see page 71).....	10	35	1 00

TURNIP.

Red, or Purple-top Strap-leaf.....	5	10	20	50
Purple-top White Globe.....	5	10	20	50
Early White Flat Dutch.....	5	10	20	50
Extra Early Purple-top Milan.....	5	15	25	75
Early White Egg.....	5	10	20	60
Early Snowball.....	5	10	20	60
Yellow, or Amber Globe.....	5	10	20	60
Long White, or Cowhorn.....	5	10	20	60
Purple-top Yellow Aberdeen.....	5	10	20	60

RUTA-BAGA.

Dreer's Improved Purple-top.....	5	10	25	75
American Purple-top.....	5	10	20	50
Budlong's Improved White.....	5	10	25	75

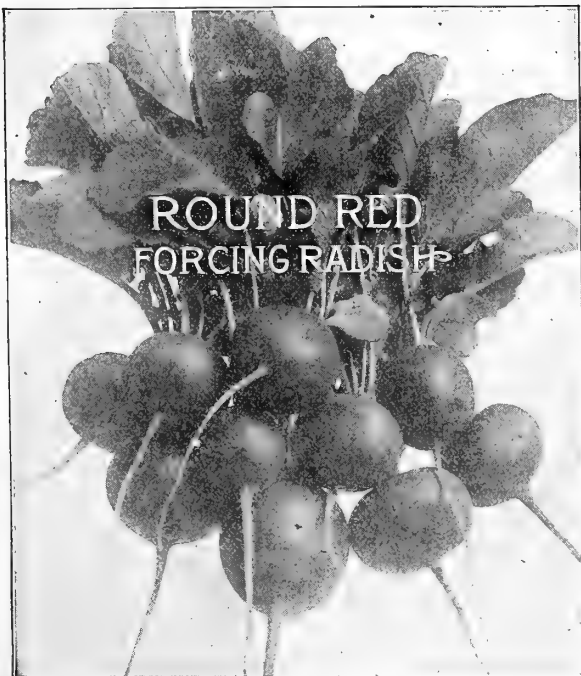



DREER'S LAWN GRASS SEEDS,

sown during the early fall months, make beautiful and permanent lawns. It is also a good time to repair damage done by fall grass, by raking it out as soon as it dies down and sowing Lawn Grass Seed on the bare spots. All of our various mixtures are composed of the best grasses for the purpose, and we give directions for sowing with every lot of lawn grass seed sold.

THE "DREER" LAWN GRASS.

For quickly producing a permanent, thick and velvety sward of grass, this brand of Lawn Grass cannot be excelled. It is a careful blending of fine-growing varieties, each in its proper proportion and thoroughly mixed, so that the result from its planting is a uniform growth of rich green grass, free from coarseness. 25 cts. per qt. (30 cts. postpaid); peck, \$1.25; bushel (20 lbs.) \$5.00.

DREER'S SHADY PLACE GRASS.

Usually it is quite difficult to obtain a satisfactory growth of grass under trees and in shady places; for sowing in such places we recommend the use of this special mixture. It will quickly produce an abundant and even growth of beautiful green grass. 30 cts. per qt. (35 cts. postpaid); peck, \$1.50; bu. (20 lbs.), \$6.00.

Dreer's "Evergreen" Lawn Grass.

This mixture is made from our own formula, and composed of Grasses which are adapted for the purpose of producing lawns which retain their rich green color and velvety appearance throughout the entire summer and fall. 20 cts. per qt. (25 cts. postpaid); peck, \$1.00; bushel (20 lbs.), \$4.00.

Dreer's Putting Green Mixture.

The varieties composing this mixture are all the finest-bladed, low-growing sorts, which produce a thick and beautiful turf. Per peck, \$1.50; bushel (20 lbs.), \$6.00.

Dreer's Golf Links Mixture.

For Cricket Tables, Golf Links, Polo Grounds, or wherever a good tough sward is wanted, this seed will give perfect satisfaction. Peck, 75 cts.; bushel (15 lbs.), \$3.00.

Dreer's Permanent Pasture Mixture

This formula is based upon successful experience. If your fields are old and worn out, it will pay to plow up and seed again with this mixture. You will be able to cut two good crops each year, whereas from Timothy only you can cut but one. Sow 50 lbs. to acre. Price, per lb., 25 cts. (by mail, 33 cts.); 15-lb. bu., \$2.50; 100 lbs., \$16.00.

Re-cleaned Grass Seeds.

If wanted by mail, add 8 cts. per lb.

Kentucky Blue, Fancy.	Per lb., 25 cts.; bu. (14 lbs.),	100 lbs.
\$2.75	\$18 00
Red Top Grass.	Lb., 15 cts.; bu. (10 lbs.), \$1.25;	
bag (50 lbs.).	\$5.50	10 00
Red Top Grass, Fancy (free from chaff).	Lb., 25	
cts.; per bu. (32 lbs.).	\$6.75	20 00
Orchard Grass.	Per lb., 25 cts.; per bu. (14 lbs.),	
\$3.00	20 00
English Perennial Rye Grass.	Per lb., 15 cts.; per	
bu. (24 lbs.).	\$2.50	9 00
Italian Rye Grass.	Lb., 15 cts.; bu. (18 lbs.),	\$3.00 10 00
Creeping Bent.	Lb., 35 cts.; bu. (20 lbs.),	\$6.25 30 00
Rhode Island Bent.	Per lb., 40 cts.; bu. (14 lbs.),	\$5.25 35 00
Sheep's Fescue.	Per lb., 20 cts.; bu. (12 lbs.),	\$2.25 16 00
Fine-leaved Sheep's Fescue.	Per lb., 45 cts.	38 00
Meadow Fescue.	Per lb., 25 cts.; bu. (22 lbs.),	\$4.75 20 00
Tall Meadow Fescue.	Per lb., 40 cts.; bu.,	\$5.00 35 00
Hard Fescue.	Per lb., 25 cts.; bu. (12 lbs.),	\$2.25 18 00
Red or Creeping Fescue.	Per lb., 35 cts.; bu.,	\$4.50 30 00
Meadow Foxtail.	Per lb., 50 cts.; bu. (7 lbs.),	\$3.00 40 00
Perennial Sweet Vernal.	Per lb., 80 cts.	
Rough Stalked Meadow Grass.	Per lb., 40 cts.	35 00
Wood Meadow Grass.	Per lb., 65 cts.; per bu. (14	
lbs.).	\$8.50	55 00
Tall Meadow Oat Grass.	Per lb., 30 cts.; bu.,	\$2.75 25 00
Crested Dogstail.	Per lb., 45 cts.; per bu. (21 lbs.),	\$9.50
.....		40 00
Awnless Brome Grass.	Per lb., 20 cts.; bu.,	\$2.50 16 00
Bermuda Grass.	Per lb., 60 cts.	
Timothy, Choice.	Write for price.	

OATS.

Grey Winter Oats. This variety has been thoroughly tested, has stood the severest winter, is entirely rust-proof; can be sown as late as November 1st. Bu., \$1.50. Add cost of bags (22 cts.) for each 2-bushel.

RAPE.

Rape, Dwarf Essex. A forage plant of the highest value. It can be sown in this latitude as late as September, and still later further South; it is sown broadcast at the rate of 10 lbs. to the acre, but is better drilled, in which case 5 lbs. to the acre are enough. In a few weeks from time of sowing, sheep, hogs or cattle can be turned on it, and all reports agree that they gain weight faster on this than any other fodder. 12 cts. per lb. (by mail, 20 cts.); 10 lbs., \$1.00; per bu. (50 lbs.), \$4.50; per 100 lbs., \$8.00. Add cost of bags (22 cts.) for each 2-bushel.

RYE.

Thousandfold Winter Rye. In hardiness and yield this variety stands foremost, will winter through severe seasons. Straw heavy and stiff of a light yellow color. Write for price.

SELECTED SEED WHEAT.

Fultz-Mediterranean Wheat (Bald). A cross of Fultz on Hybrid Mediterranean, which has absorbed the best qualities of both. The heads are large and full of beautiful, plump, red grains. The straw is stout and stiff, thereby enabling it to stand up well. This new variety is productive, and makes a crop of more than average yield. Write for price.

Improved Dietz Longberry Wheat (Bearded). This valuable early wheat will do well on all kinds of soil. Sown either early or late, it always yields a large crop of choice high-grade wheat, even after hard winters. It is very close-chafed and holds the berry tight. Write for price.

Improved Fultz Wheat (Bald). This variety is more widely known in the United States than any other kind, and probably more acreage is sown of this than any other; grows to a medium height, with stiff, strong straw, ripens early, and seldom fails to make a good crop. Write for price.



CRIMSON OR SCARLET CLOVER.

(*Trifolium incarnatum.*)

The Great Soil Improver, Early Green Feed, Grazing or for Hay Crop.

Soiling, or early green feed, is important in the early spring. As Crimson Clover is so much ahead of the pasture it can be readily cut and carried to the stabled stock; but it will not make a second crop in time for turning under for green manure.

Fertilizer. This is one of the best uses to which Crimson Clover is adapted. Its capacity for stooling and root formation is very great; like other plants it gathers nitrogen from the air and stores it in the plants and roots, which become valuable food for crops that follow.

Pasturage. When sown early enough to get a good start, Crimson Clover will make a splendid winter grazing for sheep and cattle, and is the earliest pasture in spring.

Hay. Crimson Clover produces from 2 to 3 tons of cured Hay per acre. To secure the best quality of Hay it should be cut before full bloom. It cures very rapidly and should be carefully handled to retain as much leaf as possible, but the stalks are very nutritious.

Write for sample and price of our fancy re-cleaned seed of Crimson Clover.

CLOVER SEEDS.

- Red or Medium..... Market price, write for sample.
- Red Mammoth, or Peavine..... " " " "
- Alfalfa, or Lucerne..... " " " "
- Alsike..... " " " "
- White Dutch, Choice, 30 cts. per lb. (by mail, 38 cts.); bu. (60 lbs.), \$14.40; \$24.00 per 100 lbs.

VETCHES.

Winter Vetches, or Tares (Vicia villosa). Also called Sand, or Hairy Vetch. Very hardy and remains green all winter. Sow from one-half to one bushel per acre, together with one-half bushel of Rye. Per lb., 10 cts. (by mail, 18 cts.); bu. (60 lbs.), \$5.50; per 100 lbs., \$9.00. Add cost of bags (22 cts.) for each 2-bushel.



IMPROVED DIETZ LONGBERRY WHEAT.

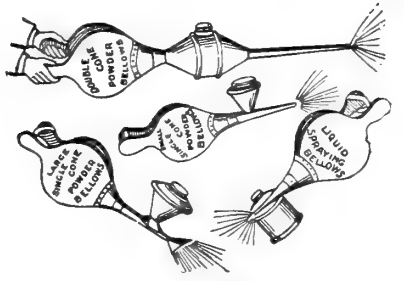

COPPER INDESTRUCTIBLE LABELS.

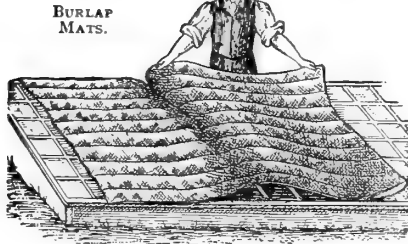

BURLAP MATS.



EUREKA.

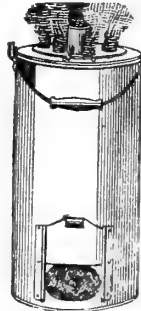

PERFECTION.

FUMIGATORS.



ENGLISH GRASS HOOK (or Sickle).

The Best Garden and Greenhouse Hose.



POWDER AND SPRAY BELLOWS.

Double Cone Powder.....	\$3 00	Large Spraying.....	\$1 75
Large Single Cone Powder ..	1 75	Small.....	1 25
Special Sulphur.....	1 50	Tin Powder Dusters.....	15
Small Single Cone Powder 1 00		Jumbo Hand Gun.....	35
BERRY AND WINE PRESS, No. 1, \$3.75; No. 2, \$4.50; No. 3, 6 25			
BRACKETS FOR POTS (Steel). No. 1, for 5-inch pots, 25 cts.; No. 2, for 6-inch pots, 30 cts.; No. 3, for 7-inch pots.....			
BRACKETS FOR POTS (Iron). For 1 pot, 25 cts.; for 2 pots.....			
CARNATION SUPPORTS (Wire). 2-Ring, per doz., 45 cts.; per 100, \$3.00; per 1000.....			
2-Ring, per doz., 55 cts.; per 100, \$3.50; per 1000.....			
CIDER MILL. Junior, \$12.00; Medium, \$16.00; Senior.....			
FRUIT PICKER. Wire, 30 cts.; Crider's.....			
“ Schneidig. (A new invention).....			

RUBBER GARDEN AND GREENHOUSE HOSE.

“Riverton.” Moulded, 3/4 in. in.	Per ft., \$	16
Chicago Electric, “ 1/2 in. “ “	“	14
Challenge. 3-ply, 3/4 in. “ “	“	17
Extra Quality. 3-ply, 3/4 in. “ “	“	10
Fine Quality. 3-ply, 3/4 in. “ “	“	12
“ “ “ 4-ply, 3/4 in. “ “	“	15
Wire-wrapped Hose. 3-ply, 3/4 in. “ “	“	16

Couplings included with above. Special price quoted on large quantities.

HOSE MENDERS, Hudson's. Box of 6 tubes, 20 bands, 1 pair pliers, 65 cts.; by mail, 75 cts.; separate tubes, per doz., 40 cts.; separate bands, per doz., 20 cts.; Jones', 5 cts. each; per doz., 50 cts. Cooper's, 10 cts. each; per doz., \$1.00.

HOSE NOZZLES. (all 3/4-in.) Gem, 30 cts.; Boston, 50 cts.; Boss, 40 cts.; Brass, with stop-cock, spray rose and stream..... 75

HUSKING PINS. Stamped steel, 15 cts.; solid steel, 25 cts.

KNIVES. Brush, American, \$1.00; English..... 1 75
 Corn and Hedge, American, 40 cts.; Little Giant..... 50

LABELS, PAINTED, POT AND TREE.

3 1/2 inch, 100, \$0 10	1000, \$0 75	5-inch, 100, \$0 20	1000, \$1 25	10-inch.....	Per 100, \$0 50
4 “ “ 12	“ “ 85	6 “ “ 25	“ “ 1 50	12 “	75
4 1/2 “ “ 15	“ “ 1 00	8 “ “ 35	“ “ 3 25		

LABELS. For trees and shrubs, 3/4 in., notched, per 100, 25 cts.; per 1000..... 1 00
 With wire, per 100, 25 cts.; per 1000..... 1 25
 Copper, indestructible, heavy, No. 2, doz., 30 cts.; gross..... 2 00
 Light, No. 2, per doz., 25 cts.; per gross..... 1 75
 White Metal, per doz., 15 cts.; per gross..... 1 25
 Zinc, tree, heavy small, per 100, 60 cts.; medium, \$1.50; large..... 3 00

LABEL INK. Indelible, for heavy zinc labels, per bottle..... 25
 LABEL PENCILS. For wood labels, each 5 cts.; per doz..... 50

GLAZING POINTS. Peerless. Three sizes; No. 1, for small single thick glass; No. 2, for medium double thick glass; No. 2 1/2, for large double thick and skylight glass. Per 1000, 60 cts.; post-paid, 75 cts.	
GLASS CUTTER. Small diamond, \$3.00; large.....	4 00
“ “ Steel wheel.....	1 15
GLOVES. Buckskin, for pruning thorny plants.....	1 25
GRASS HOOKS (Sickles). English riveted back	
No. 0.....	\$0 35
No. 1.....	40
No. 2.....	40
No. 3.....	50
American, plain, 25 cts.; Dutch, 30 cts.; Solid, English, 30 cts.; Little Giant.....	50
HOSE REELS (Wirt's) all iron. No. 10 holds 100 feet, \$2.75; No. 20 holds 150 feet, \$3.00; No. 30 holds 300 feet, \$5.00. Wooden—No. 1 holds 50 feet, \$1.50; No. 2 holds 100 feet.....	2 00

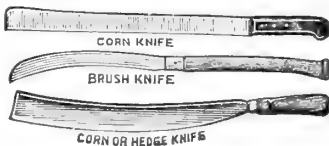

CORN KNIFE
BRUSH KNIFE
CORN OR HEDGE KNIFE



POT BRACKET (Steel.)

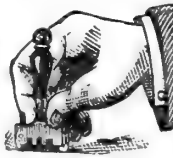

DIAMOND GLASS CUTTER.



CORN HUSKING PIN.

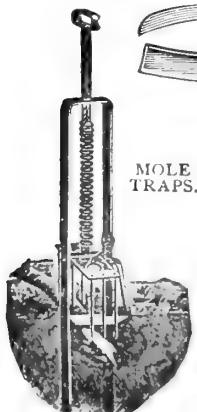

MOLE TRAPS.

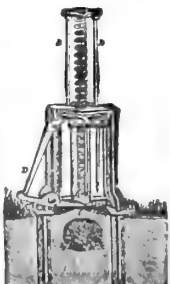

OLMSTED.



SCHNEIDIG FRUIT PICKER.



CRIDER'S.



POT BRACKET (Iron.)



WIRE.



WIRE CARNATION SUPPORT.

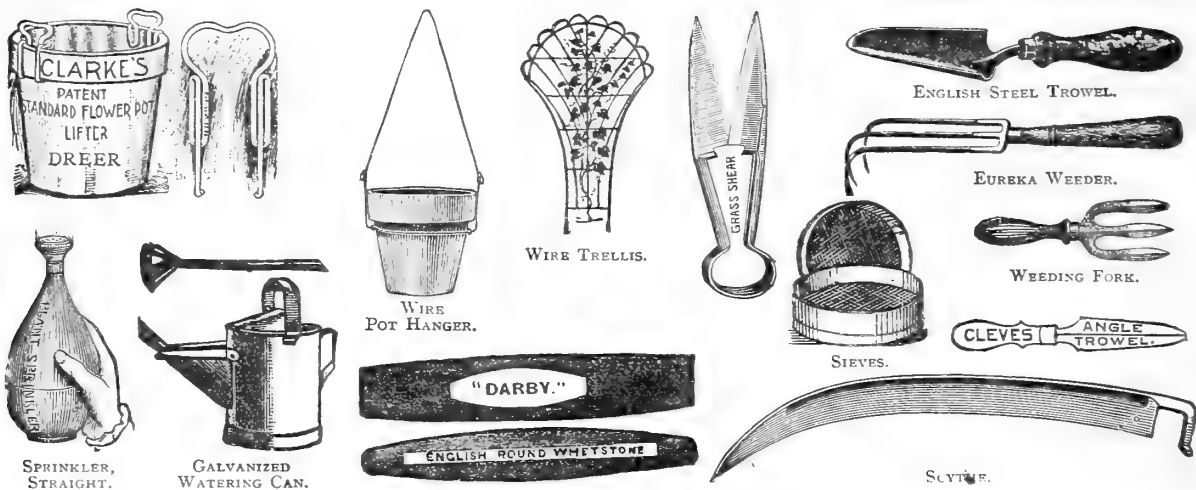

MATS. For hotbeds Burlap (frostproof).
 40 x 76 inches, to cover 1 sash \$1 00
 76 x 76 " " 2 sashes 1 50
 Waterproof, one side canvas.
 40 x 76 inches, to cover 1 sash 1 25
 76 x 76 " " 2 sashes 1 75
 Straw, for 1 sash, \$1.00; 2 sashes 1 50
 Rattan, 6 x 6, for 2 sashes 2 00
MOLE TRAPS. Reddick, \$1.00; Olmsted's 1 50

FLOWER POT LIFTER.
 This ingenious pot lifter is a safeguard against broken Jardinieres, and also water-soaked plants, as they can be easily lifted from the Jardiniere with safety. Sizes to fit from 6-inch to 12-inch pots, made of brass wire. Price, 15 cts. per pair.

WATERING CANS. Galvanized. Two qualities, heavy and light. The heavy have brass tips and two copper-faced roses; the light has one rose.

	Light.	Round (heavy).	Oval.		Light.	Round (heavy).	Oval.
4 qt.....	\$0 40	\$1 60		10 qt.....	\$0 70	\$2 25	\$2 60
6 qt.....	50	1 85	\$2 10	12 qt.....	80	2 60	2 85
8 qt.....	60	2 00	2 35	16 qt.....	90	3 15	

WATERING CAN. Low greenhouse, galvanized, 4-qt. 1 50
 Window Garden. Light weight, painted Nile green. 2-qt., 50 cts.; 4-qt., 75 cts.; 6-qt. 1 00

LAWN SHEARS. For cutting grass under fences, shrubs, etc., English, with two wheels, 9-in. blades, \$2.50 per pair; American 1 50

EDGING OR BORDER SHEARS. English, 8-in. blade, \$2.00; 10-in. blade, \$2.50 per pair; with wheel, 8 in. blade, \$2.50; 10-in. blade, \$3.00 per pair.

HEDGE. English, 8-in., \$1.50; 9-in., \$1.75; 10-in., \$2.00; 12-in. 2 50
 German. Notched, 8-in., \$1.50; 9-in., \$1.75; 10-in. 2 00

HEDGE AND LAWN. Combination. Double cut 6 00

GRASS OR SHEEP SHEARS. English, 7½-in. blade, with spring, \$1.15; without spring, \$1.00. American, 25 cts., 35 cts., 50 cts. and 75 cts. per pair.

SHEARS (Pole Pruning). Telegraph, without Pole \$1 00
 " Water's, with Pole, 4 ft., 75 cts.; 6 ft., 85 cts.; 8 ft., \$1.00; 10 ft., \$1.10; 12 ft. 1 25
 " (Hand Pruning). Dreer's Special, 9-in. 1 50
 " French, 7-in., \$1.25; 8-in., \$1.50; 9-in. 1 75
 " Perfection, 7-in., \$1.75; 8-in., \$2.00; 9-in. 2 25
 " German, 1st quality, 8-in., \$1.00; 9-in. 1 25
 " " 2d " 8-in., 50 cts.; 9-in. 75
 " Nickel, small, 85 cts. large 1 00
SPRAY SYRINGE. For insecticides Tin, 50 cts.; brass 1 00
SYRINGES. Brass, No. A, stream and spray, \$2.25; No. C, stream and spray, \$3.50; No. 2, stream and 2 sprays, \$4.25; No. 3, stream and 2 sprays, \$5.50; No. 5, stream and 2 sprays, \$6.50; No. G, stream and spray, curved neck, \$4.25; No. H, spray 2 50
RAPHIA. For tying plants. Lb., 20 cts.; 5 lbs. 85
SAWS. Pruning, 14-in., 60 cts.; 16-in., 70 cts.; 18-in., 80 cts.; 20-in., \$1.00; 24-in. 1 25
 " Double edge, lightning, 16-in. 65
 " Adjustable Pole Tree Saw, 18-in. blade 75
SIEVES. 18-in., 75 cts.; 20-in. 85
TROWELS. American steel, 10 cts.; 20 cts. and 25 cts. English steel, 6 in., 40 cts.; 7-in. 50
 " CLEVES ANGLE. 5-in., 15 cts.; 8-in. 25
HAND-WEEDING FORK. 25
SCYTHES. English lawn, riveted back, best steel, 30, 32 and 34-in., \$1.00; 36-in., \$1.15; 38-in. 1 25
 Waldron, English lawn, 36 to 40-in. 1 50
 American Lawn, 90 cts.; Bush, short 90
SCYTHE SNATH. Improved pattern 75
 " STONE. Darby, 10 cts.; English, 15 cts.; German 10
WIRE TRELLIS. For training vines. 12-in., 20 cts.; 15-in., 25 cts.; 18-in., 30 cts.; 24-in. 40
WIRE POT HANGER. For 5 to 8-in. pots. Each, 5 cts.; doz. 50
AUTO-SPRAY. Holds 4 gallons; easily carried; one pumping will spray 15 minutes. Galvanized iron, \$4.50; brass 6 75
AUTO POP NOZZLE. 1 00
WEEDERS. Eureka (steel), 25 cts.; Excelsior, 10 cts.; Lang's, 25 cts.; Climax 75
RUBBER SPRINKLERS. Straight or bent neck, large, \$1.00; small, 50 cts. Postage, 10 cts. extra.

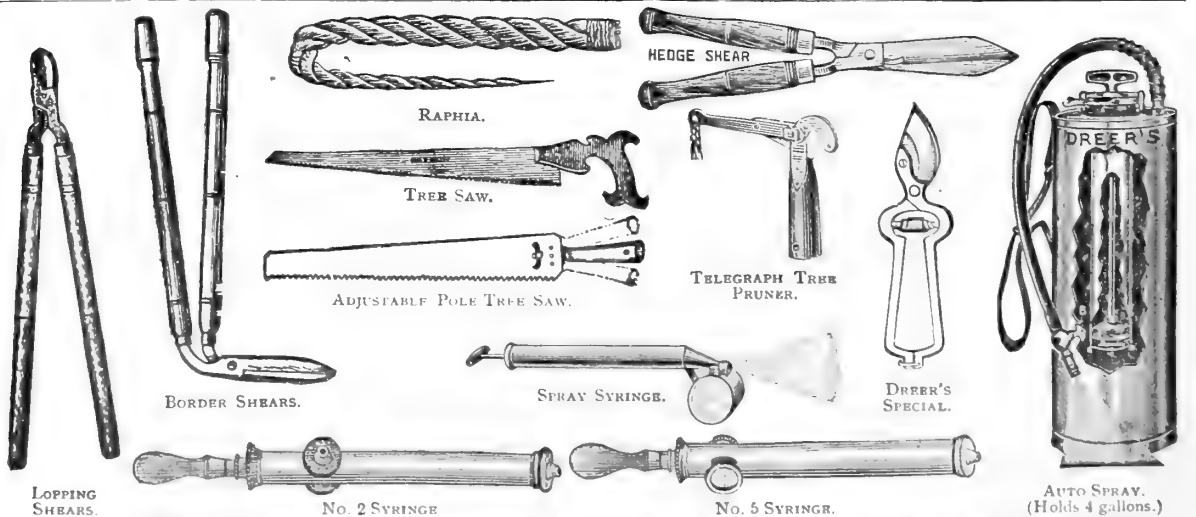

Send for Dreer's Catalogue of Tools, Implements and Poultry Supplies.

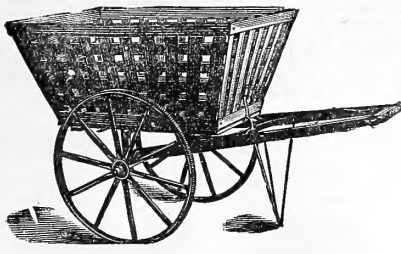

TRUCK AND LEAF RACK.

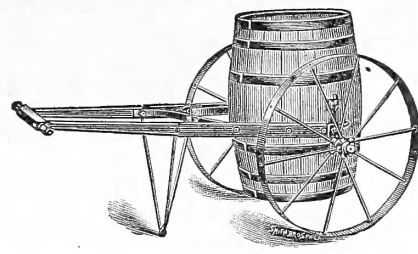

TRUCK AND WATER BARREL.



KEYSTONE WHEELBARROW LEAF RACK ATTACHMENT.

TRUCK WATER BARREL, LEAF RACK, Etc.

Indispensable in all gardens. All attachments fit the trucks, and can be attached or detached in an instant.

Truck and Water Barrel.		Truck and Leaf Rack.		Keystone Leaf Rack.	
With 1½-in. tires.....	\$ 9 50	With 1½-in. tires.....	\$11 00	This can be attached to any size wheelbarrow with removable sides. It is most convenient for gathering leaves, cut grass and rubbish. One of these should be in use on every small as well as large place. Has a capacity of 10 bushels; made of galvanized wire, bolted to a wooden base. Price, \$4 00.	
“ 2½-in. “	10 25	“ 2½-in. “	11 75		
“ 3½-in. “	11 00	“ 3½-in. “	12 50		
Barrel and Trunnions separate.....	2 75	Leaf Rack, alone.....	5 50		
Trunnions, per pair.....	50	Hand Cart Box, alone.....	3 25		

DREER'S IMPROVED KEYSTONE CEDAR PLANT TUBS.

Made of white cedar, painted green, and bound with electric-welded wire hoops, which do not rust. Handles supplied with the three largest sizes.

No.	Outside Diam.	Inside Diam.	Length of Stave.	Each.
A.	11 in.	10 in.	12 in.	\$0 75
B.	12½ in.	11 in.	12 in.	85
C.	13½ in.	12 in.	13 in.	1 00
D.	14½ in.	13 in.	14 in.	1 25
E.	15½ in.	14 in.	14 in.	1 50
F.	16½ in.	15 in.	15 in.	1 75

Tree and Plant Tubs. Painted Green. Machine-made.

White cedar, bound with iron hoops. Drop-handles, serving as hooks for carry poles. Iron legs. Removable perforated bottoms.

No.	Outside Diam.	Inside Diam.	Length of Stave.	Each.
0,	27 in.	25 in.	24 in.	\$5 00
1,	25 in.	23½ in.	21½ in.	4 50
2,	23 in.	21 in.	20 in.	4 00
3,	21 in.	18½ in.	18 in.	3 50
4,	18 in.	16½ in.	16 in.	2 75
5,	16 in.	14½ in.	14 in.	2 50
6,	14 in.	12½ in.	12 in.	2 00
7,	13 in.	11½ in.	10 in.	1 75
8,	12 in.	10½ in.	9½ in.	1 50

STANDARD FLOWER POTS.—Full inside measurement, height and width. Six at doz rates; 50 at 100 rates; 500 at 1000 rates.

Sizes.	Doz.	100.	1000.	Sizes.	Each.	Doz.	100.	1000.	Sizes.	Each.	Doz.	100.
1½ in.	\$0 06	\$0 44	\$3 46	4½ in.	\$0 20	\$1 56	\$12 37	8 in.	\$0 11	\$1 09	\$8 40	
2 in.	07	50	3 96	4½ in.	24	1 88	14 85	9 in.	16	1 56	12 00	
2½ in.	08	56	4 45	5 in.	32	2 50	19 80	10 in.	22	2 11	16 20	
3 in.	09	69	5 45	5½ in.	41	3 13	24 75	11 in.	29	2 81	21 60	
3½ in.	11	88	6 93	6 in.	49	3 75	29 70	12 in.	40	3 90	30 00	
4 in.	18	1 38	10 89	6½ in.	07	4 80	44 00	14 in.	80	7 80	60 00	
				7 in.	08	78	6 00	55 00				

Pot Stands, or Saucers.

Wood Fibre Saucers.

Wood Fibre Rolling Stands for Heavy Plants.

Sizes.	Doz.	Sizes.	Doz.	Sizes.	Each.	Doz.	Sizes.	Each.	Doz.
4 in.	\$0 15	9 in.	\$0 62	4 in.	\$0 09	\$1 00	10 in.	\$0 15	\$1 55
5 in.	18	10 in.	78	5 in.	10	1 10	12 in.	18	1 75
6 in.	24	11 in.	94	6 in.	11	1 15	14 in.	22	2 50
7 in.	31	12 in.	1 17	7 in.	12	1 25	16 in.	35	4 25
8 in.	47	14 in.	1 95	8 in.	13	1 35	18 in.	40	4 75
				9 in.	14	1 45			

Wood Pulp Cut Flower Vases.

Round Bulb or Lily Pans.

No.	Diam.	Depth.	Each.	Doz.	No.	Diam.	Depth.	Each.	Doz.	Width.	Height.	Each.	Doz.
0	8 in.	13 in.	\$0 50	\$5 40	0	6 in.	3 in.	\$0 07	\$0 68	6 in.	3 in.	\$0 07	\$0 68
1	5½ in.	10 in.	45	4 80	1	7 in.	3½ in.	08	78	7 in.	3½ in.	08	78
2	4½ in.	9 in.	40	4 20	2	8 in.	4 in.	10	98	8 in.	4 in.	10	98
3	4 in.	6 in.	35	3 60	3	9 in.	4½ in.	15	1 30	9 in.	4½ in.	15	1 30
4	3 in.	4½ in.	30	2 80	4	10 in.	5 in.	20	1 63	10 in.	5 in.	20	1 63

Square Seed Pans.

Square Earthenware Orchid Baskets.

Square Wood Orchid Baskets

Each.	Doz.	Each.	Doz.	Each.	Doz.
6 in.	\$0 20	\$2 00	4 in.	\$0 15	\$1 35
8 in.	25	2 50	5 in.	20	1 80
10 in.	30	3 00	6 in.	25	2 25
12 in.	35	3 50	7 in.	30	3 00

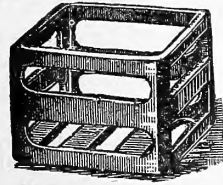

EARTHWARE ORCHID BASKET.

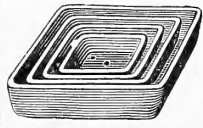

SEED PANS.

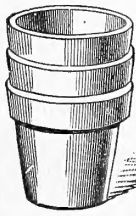

WOOD FIBRE SAUCERS.

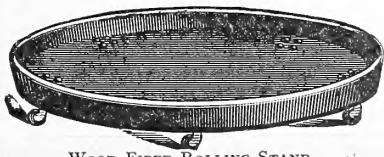
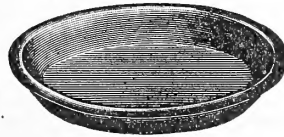

WOOD FIBRE ROLLING STAND.



CEDAR TREE AND PLANT TUB.

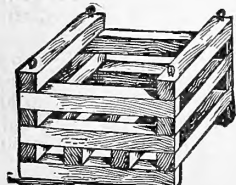

WOOD ORCHID BASKET.

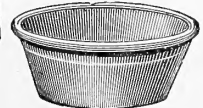

BULB OR LILY PAN.

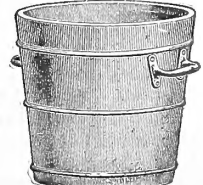

DREER'S KEYSTONE TUB.

STANDARD FLOWER POTS.

Send for Dreer's Catalogue of Tools, Implements and Poultry Supplies.

FERTILIZERS FOR THE FARM, LAWN, GARDEN AND GREENHOUSE.

We keep only the highest grade.

Prices of Fertilizers subject to change without notice. All fertilizers f. o. b. Philadelphia.

Dreer's Peerless Plant Food. One of the best and most carefully prepared odorless Plant Foods on the market. Being entirely soluble it is very convenient to use in the house and conservatory. Can be used either in dry or liquid form. Put up in $\frac{1}{2}$ and 1-lb. packages. Full directions for use with each package. Price, 15 and 25 cts.; by mail, 25 and 40 cts.

Dreer's Peerless Plant Food for Lawn and Garden. May be applied at any time during the spring or autumn. 5 lbs., 25 cts.; 10 lbs., 40 cts.; 25 lbs., \$1.00; 50 lbs., \$1.75; 100 lbs., \$3.00; 200 lbs., \$5.00; ton, \$45.00.

Pure Bone Meal (Baugh's). For giving an immediate effect. 3 lbs., 15 cts.; 5 lbs., 25 cts.; 25 lbs., 75 cts.; 50 lbs., \$1.25; 100 lbs., \$2.00; sack of 200 lbs., \$3.50; ton, \$32.00.

Canada Hardwood Ashes. Excellent as a lawn dressing. Apply late in the fall or early in the spring. 1000 to 1500 lbs. per acre. 50 lbs., \$1.00; per bbl., \$2.50; ton, \$20.00.

Clay's Fertilizer. This valuable manure is recommended to all who wish to grow either fruit, flowers, or vegetables to the highest perfection. Original bags of 28 lbs., \$2.00; 56 lbs., \$3.50; 112 lbs., \$6.50.

Pulverized Sheep Manure. This is a pure natural manure and a most nutritious food for plants; one of the best manures to mix with soil for potting plants—one part manure to six parts soil—or for making liquid manure. 5-lb. package, 25 cts.; 10 lbs., 40 cts.; 50 lbs., \$1.50; 100 lbs., \$2.50.

Nitrate of Soda. 5 lbs., 25 cts.; 25 lbs., \$1.25; 50 lbs., \$2.00; 100 lbs., \$3.75.

Tobacco Stems. An indispensable lawn covering for winter. Imparts large quantities of ammonia and drives away insects and moles. Bbl., \$1.00; bale of about 250 lbs., \$2.00; ton, \$12.00.

INSECTIDES AND FUNGICIDES.

Ant Exterminator. 25 cts., 50 cts. and \$1.00.

Apis Punk. For fumigating. Box, 60 cts.; 12 boxes, \$6.50.

Arsenate of Lead (Pure). For Elm-leaf beetle and caterpillars. 1 lb., 25 cts.; 5 lbs., 90 cts.; 12 $\frac{1}{2}$ lbs., \$2.15; 25 lbs., \$4.00; 100 lbs., \$14.00.

Bordeaux Mixture (Liquid). By simply adding water and stirring it is ready for use. 1 qt., 40 cts.; 1 gal., \$1.00; 5 gals., \$4.50. One gallon will make one barrel liquid.

Bordeaux Mixture (Dry). For fungus diseases. Ready for use by simply adding water, or use dry. 1-lb. box, 20 cts.; makes 5 gallons spray; 5-lb. box, 75 cts.

Cattle Comfort. For insects on domestic animals. Qt. can, 45 cts.; gal. can, \$1.15; 5-gal. can, \$5.00.

Copperine (Paste). Ammoniacal solution of carbonate of copper. Remedy against fungus, mildew, rust and black rot. Lb., 25 cts., makes 15 gals. liquid; 5 lbs., \$1.00.

Copper Sulphate. For early spraying and making Bordeaux. Lb., 10 cts.; 10 lbs., 90 cts.; 25 lbs., \$2.00.

Fairmount Weed Killer. Excellent for cleaning gravel paths, drives and gutters of weeds, moss, etc. A great labor-saver. $\frac{1}{2}$ gal., 75 cts.; gal., \$1.25; 5 gals., \$6.00; 10 gals., \$11.00. One gallon makes 50 gallons treating liquid.

Fir Tree Oil. For all insects. $\frac{1}{2}$ pt., 50 cts.; pt., 75 cts.; qt., \$1.50; $\frac{1}{2}$ gal., \$2.75; gal., \$5.00.

Fir Tree Oil Soap. $\frac{1}{2}$ -lb. can, 25 cts.; 2-lb. can, 75 cts.

Grape Dust. For mould, mildew, or rust mites, either in greenhouses or open air. 5-lb. pkg., 30 cts.

Hellebore. For all insects. $\frac{1}{4}$ lb., 10 cts.; $\frac{1}{2}$ lb., 15 cts.; 1 lb., 25 cts.; 5 lbs., \$1.00.

Kerosene Emulsion (Liquid). Concentrated, 1 qt., 40 cts.; 1 gal., \$1.00; 5 gals., \$4.50.

Kerosene Emulsion (Paste). Ready for use by simply adding water. 1-lb. can, 15 cts.; 5-lb. can, 60 cts.; 25-lb. can, \$2.50. One pound makes 10 gallons of spray.

Kil-O-Scale. The best San Jose scale remedy. 1 qt., 50 cts.; $\frac{1}{2}$ gal., 75 cts.; 1 gal., \$1.25; 5 or 10 gals., \$1.00 per gal. Special price by barrel. 1 gallon dilutes to 25 gallons of water.

Kil-Worm. Destroys ants and worms in Cricket grounds and private lawns, snails in greenhouse and garden. Does not injure grass. One gallon makes 50 gallons of liquid. 1 qt. bottle, 65 cts.; $\frac{1}{2}$ gal., \$1.25; 1 gal., \$2.00; 5 gals., \$9.00; bbl. of 45 gals., \$1.75 per gal.

Lemon Oil. For all insects and scales. $\frac{1}{2}$ pt., 25 cts.; pt., 40 cts.; qt., 75 cts.; $\frac{1}{2}$ gal., \$1.25; gal., \$2.00.

Little's Antipest. 1-qt. can, 60 cts.; $\frac{1}{2}$ -gal. can, \$1.00; 1-gal. can, \$1.75.

London Purple. $\frac{1}{2}$ lb., 15 cts.; 1 lb., 20 cts.; 5 lbs., 90 cts.

Nico-Fume. The best nicotine fumigating paper. Box of 24 sheets, 75 cts.; 144 sheets, \$3.50; 288 sheets, \$6.50.

Nico-Fume Liquid. A guaranteed 40 per cent. nicotine solution for fumigating and spraying. $\frac{1}{4}$ pt., 50 cts.; 1 pt., \$1.50; $\frac{1}{2}$ gal., \$5.50; 1 gal., \$10.50.

Nicoticide. Fumigating compound. 1 pt., \$2.50; $\frac{1}{2}$ pt., \$1.25; 4 ozs., 70 cts.; vaporizing apparatus, 50 cts.

Nikoteen. An economical and powerful nicotine extract. One part to 600 of water is sufficiently strong to kill all insects except scale, for which use 1 to 400. Pt. bottle, \$1.50.

Persian Insect Powder. For roaches, ants, fleas, etc. $\frac{1}{4}$ lb., 15 cts.; $\frac{1}{2}$ lb., 30 cts.; 1 lb., 50 cts.; 2 lbs., 80 cts.; 5 lbs., \$1.75.

Paris Green. $\frac{1}{2}$ lb., 20 cts.; 1 lb., 35 cts.

Rose Leaf Extract of Tobacco. A nicotine solution. Pt., 30 cts.; qt., 50 cts.; gal., \$1.25; 5 gals., \$4.25.

Slug Shot (Hammond's). One of the cheapest and best powders for destroying insects. 5 lbs., 25 cts.; 10 lbs., 50 cts.; 100 lbs., \$4.25; bbl., 235 lbs., \$8.50; 1-lb. carton, 15 cts.

Sulphur, Powdered. For mildew. 1 lb., 10 cts.; 5 lbs., 40 cts.; 10 lbs., 60 cts.; 50 lbs., \$2.50; 100 lbs., \$4.00.

Tobacco Dust. 1 lb., 10 cts.; 5 lbs., 25 cts.; 100 lbs., \$3.50.

Tobacco Soap (Dreer's). For plants, trees, cattle and all insect-infested animals. $\frac{1}{2}$ lb., 25 cts.; 10 lbs., bulk, \$3.00.

Tree Tanglefoot. The best remedy against caterpillars and all tree insects. Will not injure the tree. Will remain sticky for three months. Easily applied. 1 lb., 25 cts.; 4 lbs., 90 cts.; 10 lbs., \$2.00.

Whale Oil Soap. 1, 2 and 5 lbs., 20 cts., 35 cts. and 50 cts.

Worm Eradicator. For removing worms of any kind in greenhouses and potted plants, etc., without injury to the most delicate plants. Bottle, 50 cts. and \$1.00.

Orchard Brand Spray Remedies.

Bordeaux Mixture. The supreme remedy against Fungus, Rust, Scale and all kinds of rot. When used on Peach and Plum Trees should be at half strength. Five ozs. to 1 gal. of water is standard strength. 1 lb., 11 cts.; 2 lbs., 18 cts.; 5 lbs., 40 cts.; 10 lbs., 75 cts.; 20 lbs., \$1.35; 50 lbs., \$3.12.

Bordeaux—Arsenate of Lead Mixture. A combined Fungicide and Insecticide. For Apple and Pear Trees, Potatoes, Melons and Cucumbers. Three ozs. to 1 gal. of water. Apply as a spray. 1 lb., 15 cts.; 2 lbs., 26 cts.; 5 lbs., 60 cts.; 10 lbs., \$1.15; 20 lbs., \$2.15; 50 lbs., \$5.12.

Lime Sulphur Solution. A perfect Scale and Fungus destroyer; special for Plum and Peach Trees, which need fall and spring treatment; cures Peach leaf curl. Use during dormant period. Protect the hands with gloves when applying. Dilute with 10 parts of water. Apply with spray pump. 1 gal., 75 cts.; 5 gals., \$2.25; 10 gals., \$3.75; half bbls., \$7.00; bbls. of 50 gals., \$12.00.

Soluble Oil. An excellent Scale remedy. Specially good for lawn trees and hedges, as it will not stain. Mixes perfectly with water. Use during dormant period. Dilute with 15 to 20 parts of water. Apply with spray pump. 1 gal., \$1.00; 5 gals., \$3.65; 10 gals., \$6.65; half bbl., 60 cts. per gal.; bbl. of 50 gals., 50 cts. per gal.

Full directions for using with each package. When wanted by mail add 15c. per pound. Liquids not mailable.

Books on Horticultural and Kindred Subjects

ALL BOOKS SENT POSTPAID AT PRICES GIVEN

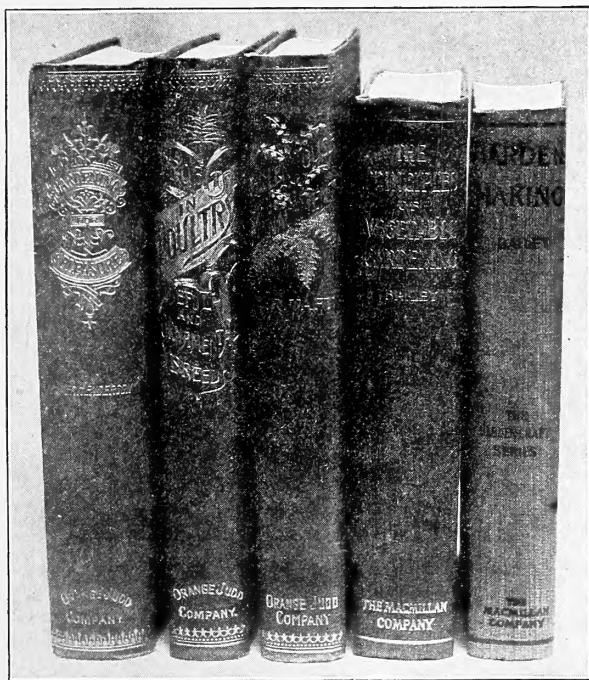

A Woman's Hardy Garden (Mrs. Ely). One of the most popular and helpful books for the amateur, beautifully illustrated \$1 75

Amateur Aquarist. A splendid work on this most fascinating subject..... 1 00

Amateur's Practical Garden-Book. Contains the simplest directions for the growing of the commonest things about the house and garden..... 1 00

Asparagus. Its culture for home use and for market..... 50

Bee Keeping (Quinby). A complete work..... 1 00

Berry Book (Biggle's). All small fruits are treated in this complete little book..... 50

Bulbs and Tuberous Rooted Plants (Allen). Full directions for their culture indoors and outdoors..... 1 50

Cabbage, Cauliflower and Allied Vegetables (Allen). Tells all about them, from seedtime to harvest..... 50

Carnation Culture (Lamborn). An up-to-date practical work on the "divine" flower..... 1 50

Chrysanthemum Manual (Revised Edition). A complete guide to the culture of this popular flower..... 47

Celery Culture. Complete in every detail, from sowing the seed for a few plants to handling carload lots..... 50

Fertilizers (Gregory). Where to Get, How to Make and When to Use..... 40

Flowers, How to Grow Them (Rexford). A splendid book for beginners..... 50

Fruit Garden (Barry's). Invaluable standard American work... 1 50

Fruit Growing, Principles of (Bailey). Presents the most approved methods of American growers..... 1 50

Garden-making (Bailey). Suggestions for the utilizing of home grounds..... 1 50

Gardening for Pleasure (Henderson). A guide to the amateur in the fruit, flower and vegetable garden..... 1 50

Gardening for Profit (Henderson). The standard work on market and family vegetable gardening..... 1 50

Ginseng. Its cultivation, harvesting and marketing..... 50

Grape Culturist (Fuller). Best work on the hardy grape..... 1 50

Grape Grower's Guide (Chorton). A practical treatise on the cultivation of the grape indoors..... 75

Greenhouse Management (Taft). The latest book on this important branch of horticulture..... 1 50

Greenhouse Construction (Taft). Complete treatise on subject..... 1 50

Guide to the Wild Flowers (Lounsbury). Unexcelled as a text-book for beginners..... \$1 75

Handbook of Plants (Henderson). A dictionary of plants with valuable cultural hints for important sorts..... 3 00

Home Floriculture (Rexford). A practical guide on flowering and ornamental plants for the amateur..... 1 00

Horse Book (Biggle's). Care of the horse fully discussed..... 50

Horticulturist's Rule Book (Bailey). A compendium of useful information..... 75

House Plants and How to Succeed with Them. A splendid book for ladies who grow plants in the house..... 1 00

How to Plan the Home Grounds (Parsons). Instructions for beautifying the home grounds, large or small..... 1 00

Landscape Gardening (Maynard). Covers all subjects in connection with the laying out of a garden..... 1 50

Mushrooms, Edible, Poisonous, etc. (Atkinson). The best book on the subject for the amateur, student, physician and all who wish to learn about mushrooms; finely illustrated..... 3 00

Mushrooms, How to Grow (Falconer). The most practical work on the subject ever written..... 1 00

Onion Culture, The New (Grenier). Gives the latest ideas of growing this crop..... 50

Orchard Book (Biggle). A new and concise work, gives all necessary details for culture of apples, pears, etc..... 50

Pigeon Raising. Tells how to raise squabs, etc..... 50

Plant Culture (O'iver). A new and enlarged edition of this splendid handbook of everyday practice for the florist and gardener..... 1 50

Potato Culture (Terry). How to grow the largest quantities and the finest qualities with the least expenditure..... 40

Poultry Architecture (Fiske). Full of valuable information about poultry houses, etc..... 50

Poultry Appliances and Handicraft. Tells how to manage poultry in the most economical manner..... 50

Poultry Book (Biggle's). Most concise work on the subject..... 50

Poultry, The Diseases of. The entire subject fully and clearly treated..... 50

Practical Floriculture (Henderson). A guide to the successful cultivation of florists' flowers..... 1 50

Practical Forestry (Fuller). Treats on all the native trees as well as the best exotic sorts..... 1 25

Profits in Poultry. A valuable addition to poultry literature..... 1 00

Rhubarb Culture. A complete guide to dark forcing and field culture..... 50

Rose Culture (Ellwanger). The standard American work on this subject..... 1 25

Seasons in a Flower Garden (Shelton). The record of an enthusiastic amateur; full of valuable points..... 1 00

Small Fruit Culturist (Fuller). This book covers the whole range of small fruits..... 1 00

Soils (Burkett). Their properties, improvements, management and the problems of crop growing and crop feeding..... 1 25

Spraying of Plants (Lodeman). Principles and practice of the application of liquids and powders to plants for destroying insects and fungi..... 1 25

Sweet Potato Culture. Full instructions from start to harvest..... 50

Strawberry Culture (Fuller). Contains all information necessary to enable anyone to grow their own strawberries..... 25

The Forcing Book (Bailey). Describes the best forcing houses and tells what crops may be grown and how to do the work..... 1 25

The Nursery Book (Bailey). A complete guide to the multiplication of plants..... 1 50

The Pruning Book (Bailey). Principles and practices of pruning and training as applied to American conditions..... 1 50

Tobacco Culture. Gives full practical details..... 25

Tomato Culture..... 30

Vegetable Gardening, The Principles of (Bailey). A highly instructive book..... 1 50

Violet Culture (Galloway). The only comprehensive work on this important subject..... 1 50

Water Gardening. A new book on this most fascinating branch of horticulture..... 2 50

DREER'S SUPERB MAY-FLOWERING, COTTAGE GARDEN or BOULEVARD TULIPS

Illustrated on the covers of this Catalogue are described and offered on pages 10 and 11.

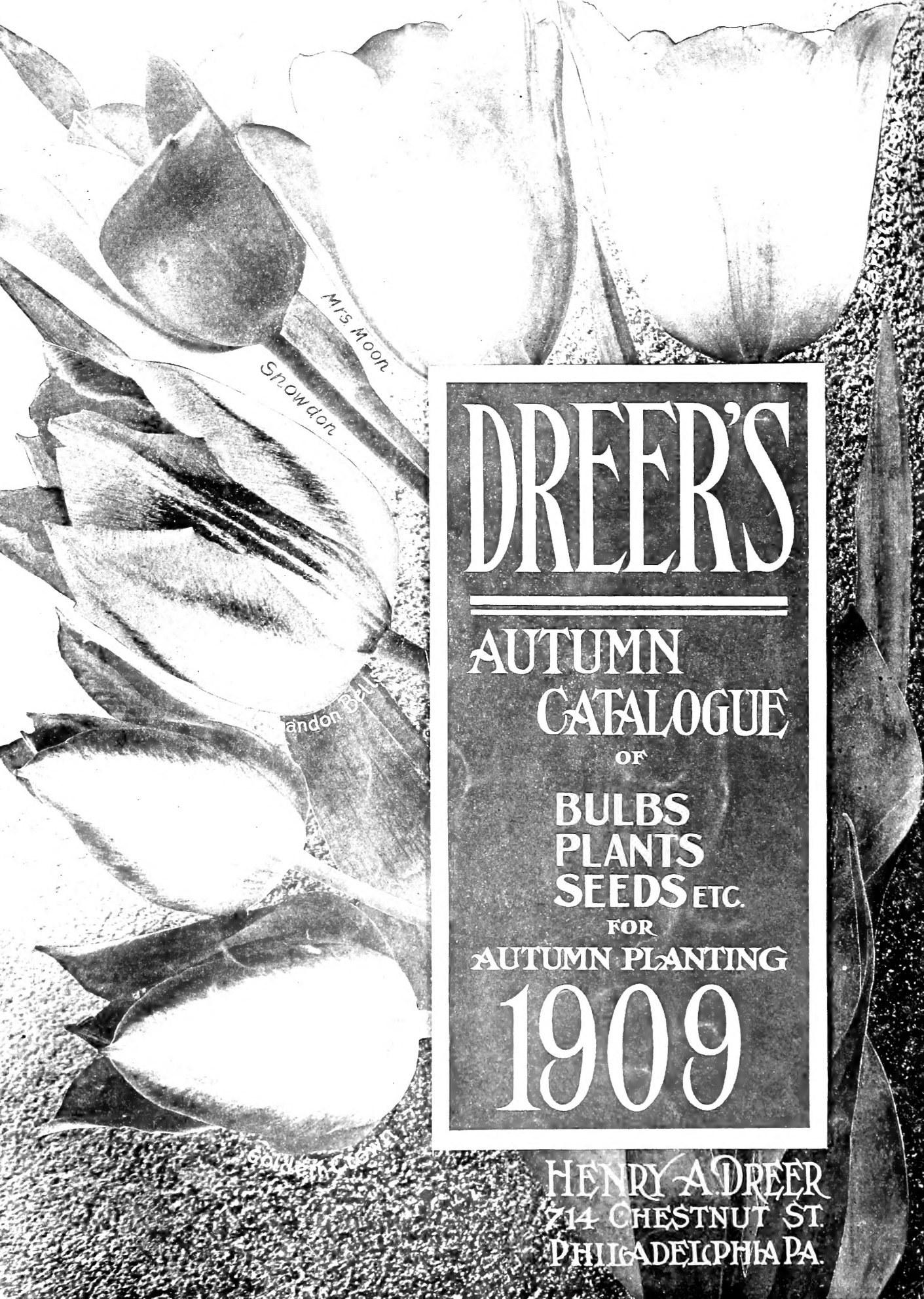

DREER'S

AUTUMN CATALOGUE

OF

BULBS
PLANTS
SEEDS ETC.

FOR

AUTUMN PLANTING

1909

HENRY A DREER
714 CHESTNUT ST.
PHILADELPHIA PA.